



ARCHMI-8XXA Series

7", 8", 10.1", 12.1", 15", 15.6", 17", 18.5", 19" and 21.5"

Intel Apollo Lake N4200/N3350 Fanless Industrial Compact Size Panel PC

User Manual

Release Date

Revision

Sep.2020

V1.1

©2020 Aplex Technology, Inc.

All Rights Reserved.

Published in Taiwan

Aplex Technology, Inc.

15F-1, No.186, Jian Yi Road, Zhonghe District, New Taipei City 235, Taiwan

Tel: 886-2-82262881 Fax: 886-2-82262883 URL: <http://www.aplertec.com/zh/home.php>

Revision History

Reversion	Date	Description
1.0	2020/04/16	Official Version
1.1	2020/09/17	Delete -20~60°C Wide temperature option in 1.1

Warning!

This equipment will generate, use and can radiate radio frequency energy and if not installed and used in accordance with the instructions manual, it may cause interference to radio communications. It has been tested and found to comply with the limits for a Class A computing device pursuant to FCC Rules, which are designed to provide reasonable protection against such interference when operated in a commercial environment. Operation of this equipment in a residential area is likely to cause interference in which case the user at its own expense will be required to take whatever measures may be required to correct the interference.

Electric Shock Hazard – Do not operate the machine with its back cover removed. There are dangerous high voltages inside.

Caution

Risk of explosion may occur if the battery is replaced with an incorrect type.

Batteries should be recycled where possible. Disposal of used batteries must be in accordance with local environmental regulations.

Disclaimer

This information in this document is subject to change without notice. In no event shall Apex Technology Inc. be liable for damages of any kind, whether incidental or consequential, arising from either the use or misuse of information in this document or in any related materials.

Packing List

Accessories (as ticked) included in this package are:

Adaptor

Driver & manual CD disc

Other. _____ (please specify)

Safety Precautions

Follow the messages below to prevent your systems from damage:

- ◆ Avoid your system from static electricity on all occasions.
- ◆ Prevent electric shock. Don't touch any components of this machine when the machine is power-on. Always disconnect power when the system is not in use.
- ◆ Disconnect power before you change any hardware devices. For instance, when you adjust a jumper, install module or any boards, a surge of power may damage the electronic components or the whole system.

Table of Contents

Revision History.....	1
Warning!/Caution/Disclaimer.....	2
Packing List.....	3
Safety Precautions.....	4
Chapter 1	Getting Started
1.1 Features.....	7
1.2 Specifications.....	7
1.3 Dimensions.....	11
1.4 Brief Description of ARCHMI-8XXA Series.....	16
1.5 Installation of HDD.....	27
1.6 VESA Mounting.....	28
1.7 Panel Mounting.....	28
Chapter 2	Hardware
2.1 Mainboard Introduction.....	29
2.2 Specifications.....	29
2.3 Jumpers and Connectors Location.....	32
2.4 Jumpers Setting and Connectors.....	33
Chapter 3	BIOS Setup
3.1 Operations after POST Screen.....	56
3.2 BIOS Setup Utility.....	56
3.3 Main Settings.....	56
3.4 Advanced Settings.....	58
3.5 Chipset Settings.....	65
3.6 Security Settings.....	69
3.7 Boot Settings.....	71
3.8 Save & Exit Settings.....	72
Chapter 4	Installation of Drivers
4.1 Intel® Apollo Lake SoC Chipset.....	75
4.2 Intel® VGA Chipset.....	78
4.3 Intel® I210 LAN Driver.....	81
4.4 Realtek ALC269Q HD Audio Driver.....	85
4.5 Intel®TXE.....	87
4.6 Touch Panel Driver.....	90
4.7 DPTF Driver.....	93

Figures

Figure 1.1: Dimensions of ARCHMI-807AP/AR/AG(H).....	11
Figure 1.2: Dimensions of ARCHMI-808AP/AR/AG(H).....	11
Figure 1.3: Dimensions of ARCHMI-810AP/AR/AG(H).....	12
Figure 1.4: Dimensions of ARCHMI-812AP/AR/AG(H).....	12
Figure 1.5: Dimensions of ARCHMI-815AP/AR/AG(H).....	13
Figure 1.6: Dimensions of ARCHMI-816AP/AR/AG(H).....	13
Figure 1.7: Dimensions of ARCHMI-817AP/AR/AG(H).....	14
Figure 1.8: Dimensions of ARCHMI-818AP/AR/AG(H).....	14
Figure 1.9: Dimensions of ARCHMI-819AP/AR/AG(H).....	15
Figure 1.10: Dimensions of ARCHMI-821AP/AR/AG(H).....	15
Figure 1.11: Front View of ARCHMI-807A.....	17
Figure 1.12: Rear View of ARCHMI-807A.....	17
Figure 1.13: Front View of ARCHMI-808A.....	18
Figure 1.14: Rear View of ARCHMI-808A.....	18
Figure 1.15: Front View of ARCHMI-810A.....	19
Figure 1.16: Rear View of ARCHMI-810A.....	19
Figure 1.17: Front View of ARCHMI-812A.....	20
Figure 1.18: Rear View of ARCHMI-812A.....	20
Figure 1.19: Front View of ARCHMI-815A.....	21
Figure 1.20: Rear View of ARCHMI-815A.....	21
Figure 1.21: Front View of ARCHMI-816A.....	22
Figure 1.22: Rear View of ARCHMI-816A.....	22
Figure 1.23: Front View of ARCHMI-817A.....	23
Figure 1.24: Rear View of ARCHMI-817A.....	23
Figure 1.25: Front View of ARCHMI-818A.....	24
Figure 1.26: Rear View of ARCHMI-818A.....	24
Figure 1.27: Front View of ARCHMI-819A.....	25
Figure 1.28: Rear View of ARCHMI-819A.....	25
Figure 1.29: Front View of ARCHMI-821A.....	26
Figure 1.30: Rear View of ARCHMI-821A.....	26
Figure 1.31: ARCHMI-8XXA Series VESA Mounting.....	28
Figure 1.32: ARCHMI-8XXA Series Panel Mounting.....	28
Figure 2.1: Motherboard Dimensions.....	31
Figure 2.2: Jumpers and Connectors Location-Board Top.....	32
Figure 2.3: Jumpers and Connectors Location-Board Bottom.....	32

1.1 Features

- Industrial Compact Size Panel PC
- Flat front panel touch screen
- Intel Apollo Lake N4200/N3350
- Onboard 4G/8G DDR3L 1333MHz
- DC 9~36V wide-ranging power input
- IP66 compliant front panel
- High brightness LCD 1000 nits for option (DPTF Setting: 77~80°C)

1.2 Specifications

ARCHMI-8XXA	
System	
CPU	Default-Onboard Intel Apollo Lake N4200(4 core, 1.1 GHz) Option-Intel Apollo Lake N3350(2 core, 1.1 GHz)(optional)
Chipset	SoC
Memory	Onboard 4GB/8GB DDR3L 1333MHz (8GB for option)
IO Port	
USB	2 x USB 3.0 type A
Serial/Parallel	1 x RS-232/422/485 DB-9, COM1, Default RS-232 1 x RS-232 DB-9, COM2
Audio	1 x Audio Line Out
LAN	2 x GbE LAN RJ-45
Power	1 x 3-pin DC Power Input terminal 1 x 2-pin connector for power on/off
Option	VESA Stand (7"~21.5") 4G LTE/Wi-Fi/BT (7"~21.5") TB-528 Series: 1. 4 x USB2.0 Type A (TB-528U4) 2. 4 x USB2.0 Type A+1 x Mini PCIe+1 SIM slot (TB-528U4ME1) 3. 1 x COM(RS-232)+2 x USB2.0 (TB-528C1U2) 4. 1 x COM(RS-232)+2 x USB2.0+1 x Power Button (TB-528C1U2P1) 5. 2 x COM(RS-232) (TB-528C2) 6. 2 x COM(RS-232)+1 x Mini-PCIe slot+1 x SIM slot (TB-528C2ME1) 7. 2 x COM(RS-232/485, isolated) (TB-528C2I) 8. 2 x CAN (TB-528CAN2)

	<p>9. 1 x LAN+2 x USB2.0 (TB-528E1U2)</p> <p>10. 1 x LAN+2 x USB2.0+45W POE (TB-528E1U2UPOE)-Not allowed for 17"/18.5"/19"/21.5"</p> <p>11. 1 x LAN+2x USB 2.0, 25W (TB-528NE1U2POE)-Only for 10.1"</p> <p>UPS Battery 21W/10.8W/1.95Ah (3S1P)</p> <p>(7" and 8" models are not allowed for I/O board TB-528 series)</p> <p>(I/O board TB-528 series and UPS battery can only be either one choice in 10.1"/12.1" models)</p> <p>(I/O board TB-528 series can only be used in ARCHMI-812A and above models)</p> <p>(TB-528POE series and UPS Battery can only be either one choice in 15" and above models)</p>
Storage Space	
HDD/SSD	<p>1 x MO-297 SATA SSD (Easy Accessible)-7"~8" models</p> <p>1 x 2.5" SATA HDD bay for SATA HDD (Easy Accessible)-10.1"~21.5" models</p>
Expansion	
Expansion Slot	<p>1 x Internal Mini-PCIe slot full size</p> <p>1 x SIM card holder/ Micro SD card reader</p>
Touch Screen – Resistive Touch Window Type	
Interface	USB
Light Transmission	Over 80%
Touch Screen – Projected Capacitive Type	
Interface	USB
Light Transmission	Over 90%
Power	
Power Input	DC 9~36V
Mechanical	
Mechanical Construction	<p>Aluminum die-casting chassis(7"~15.6"+21.5")</p> <p>Aluminum front bezel/Aluminum die-casting for back cover(17"~19")</p>
Mounting	<p>Panel Mount (7"~21.5")</p> <p>VESA 75 x 75mm (7" and 8" models)</p> <p>VESA 100 x 100mm (10.1"~21.5" models)</p>
Chassis Color	RAL 9007
IP Rating	IP66 Compliant Front Bezel
Operating System Support	
OS Support	Windows 10 IoT Enterprise
Environmental	
Operating Temperature	<p>0~50°C</p> <p>0~40°C(For 21.5" High Brightness models)</p>
Storage Temperature	-30~70°C
Storage Humidity	10 to 95% @ 40°C, non-condensing
Certification	Meet CE / FCC Class A

Display(STD)					
	ARCHMI-807 AP/AR/AG	ARCHMI-808 AP/AR/AG	ARCHMI-810 AP/AR/AG	ARCHMI-812 AP/AR/AG	ARCHMI-815 AP/AR/AG
Display Type	7" TFT LCD	8" TFT LCD	10.1" TFT LCD	12.1" TFT LCD	15" TFT LCD
Max Resolution	800 x 480	800 x 600	1280 x 800	800 x 600 1024 x 768	1024 x 768
Max Color	262K	16.2M	16.7M	262K/16.2M	16.2M
Luminance (cd/m²)	350	350	350/300	450-800 x 600 500-1024 x 768	300
Contrast Ratio	400:1	500:1	800:1	1500:1-800 x 600 1000:1-1024 x 768	2000:1
Viewing Angle (H/V)	140/120	140/120	170/170	178/178-SVGA 178/178-XGA	176/176
Backlight Lifetime(Hrs)	50,000	40,000	25,000	50,000-800 x 600 30,000-1024 x 768	70,000

Display(STD)					
	ARCHMI-816 AP/AR/AG	ARCHMI-817 AP/AR/AG	ARCHMI-818 AP/AR/AG	ARCHMI-819 AP/AR/AG	ARCHMI-821 AP/AR/AG
Display Type	15.6" TFT LCD	17" TFT LCD	18.5" TFT LCD	19" TFT LCD	21.5" TFT LCD
Max Resolution	1366 x 768	1280 x 1024	1366 x 768	1280 x 1024	1920 x 1080
Max Color	16.7M	16.2M	16.7M	16.7M	16.7M
Luminance (cd/m²)	300	350	300	350	250
Contrast Ratio	500:1	1000:1	1000:1	1000:1	3000:1
Viewing Angle (H/V)	160/160	170/160	170/160	170/160	178/178
Backlight Lifetime (hrs)	50,000	30,000	50,000	50,000	30,000

Display(HB)					
	ARCHMI-807 AP/AR/AG(H)	ARCHMI-808 AP/AR/AG(H)	ARCHMI-810 AP/AR/AG(H)	ARCHMI-812 AP/AR/AG(H)	ARCHMI-815 AP/AR/AG(H)
Display Type	7" TFT LCD	8" TFT LCD	10.1" TFT LCD	12.1" TFT LCD	15" TFT LCD
Max Resolution	800 x 480	800 x 600	1280 x 800	800 x 600 1024 x 768	1024 x 768
Max Color	262K	16.2M	16.7M	16.2M/262K	16.7M
Luminance (cd/m²)	1000	1000	1000	1000/1000	1000
Contrast Ratio	400:1	500:1	1000:1	700:1	800:1
Viewing Angle (H/V)	140/130	140/125	170/170	178/178-SVGA 160/140-XGA	160/150

Backlight Lifetime (hrs)	50,000	50,000	50,000	50,000/50,000	50,000
Display(HB)					
	ARCHMI-816 AP/AR/AG(H)	ARCHMI-817 AP/AR/AG(H)	ARCHMI-818 AP/AR/AG(H)	ARCHMI-819 AP/AR/AG(H)	ARCHMI-821 AP/AR/AG(H)
Display Type	15.6" TFT LCD	17" TFT LCD	18.5" TFT LCD	19" TFT LCD	21.5" TFT LCD
Max Resolution	1366 x 768	1280 x 1024	1366 x 768	1280 x 1024	1920 x 1080
Max Color	16.7M	16.7M	16.7M	16.7M	16.7M
Luminance (cd/m ²)	1000	1000	1000	1000	1000
Contrast Ratio	500:1	1000:1	1000:1	1000:1	3000:1
Viewing Angle (H/V)	160/160	170/160	170/160	170/160	178/178
Backlight Lifetime (hrs)	50,000	50,000	50,000	50,000	50,000

Power Consumption					
	ARCHMI-807 AP/AR/AG	ARCHMI-808 AP/AR/AG	ARCHMI-810 AP/AR/AG	ARCHMI-812 AP/AR/AG	ARCHMI-815 AP/AR/AG
Power Consumption	Max:27W	Max:28W	Max:29W	Max:33W	Max:31W
Dimension (mm)	202x149x40	231x176.1x50	285x189x48.9	319x245x51.7	410x310x54.67
Net Weight (kg)	1.1	1.9	1.88	2.8	4.6

Power Consumption					
	ARCHMI-816 AP/AR/AG	ARCHMI-817 AP/AR/AG	ARCHMI-818 AP/AR/AG	ARCHMI-819 AP/AR/AG	ARCHMI-821 AP/AR/AG
Power Consumption	Max:33W	Max:39W	Max:43W	Max:37W	Max:43W
Dimension (mm)	412x277.5x58.9	439x348x64.8	499.6x314.6x65.4	468x380x64.8	557.3x362.3x64.8
Net Weight (kg)	4.5	6.3	6.6	7.2	7.5

1.3 Dimensions

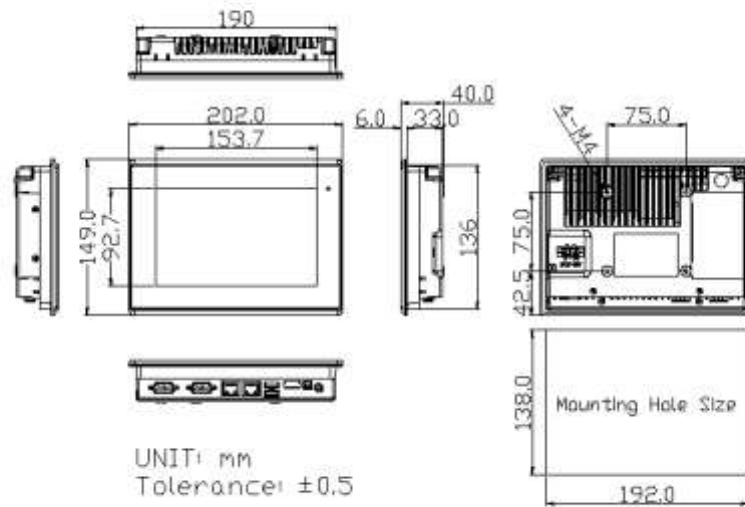

Figure 1.1: Dimensions of ARCHMI-807AP/AR/AG(H)

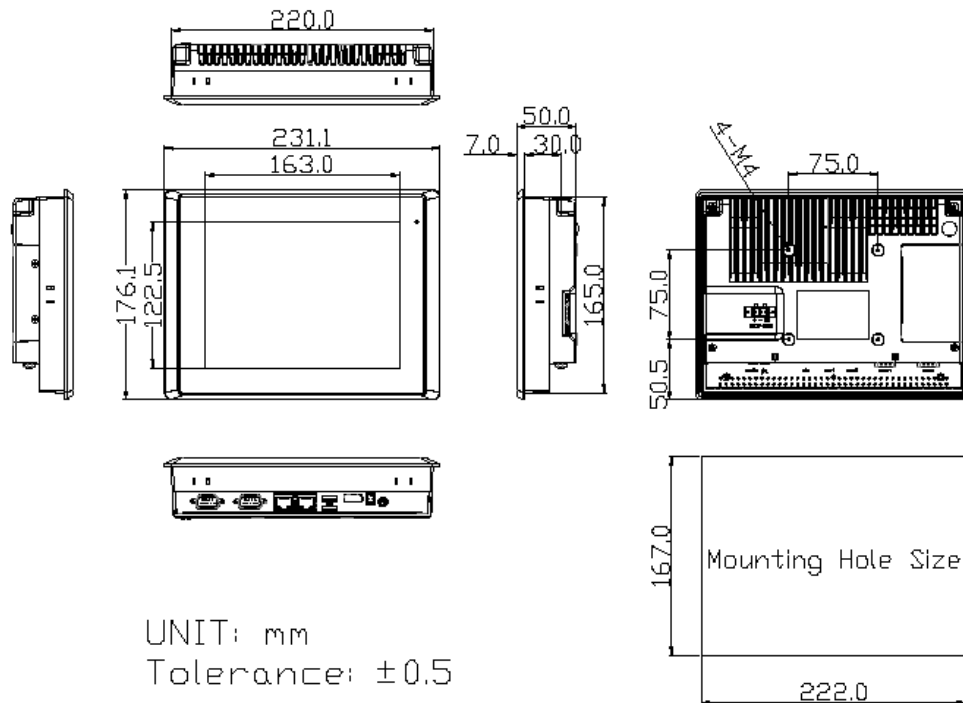

Figure 1.2: Dimensions of ARCHMI-808AP/AR/AG(H)

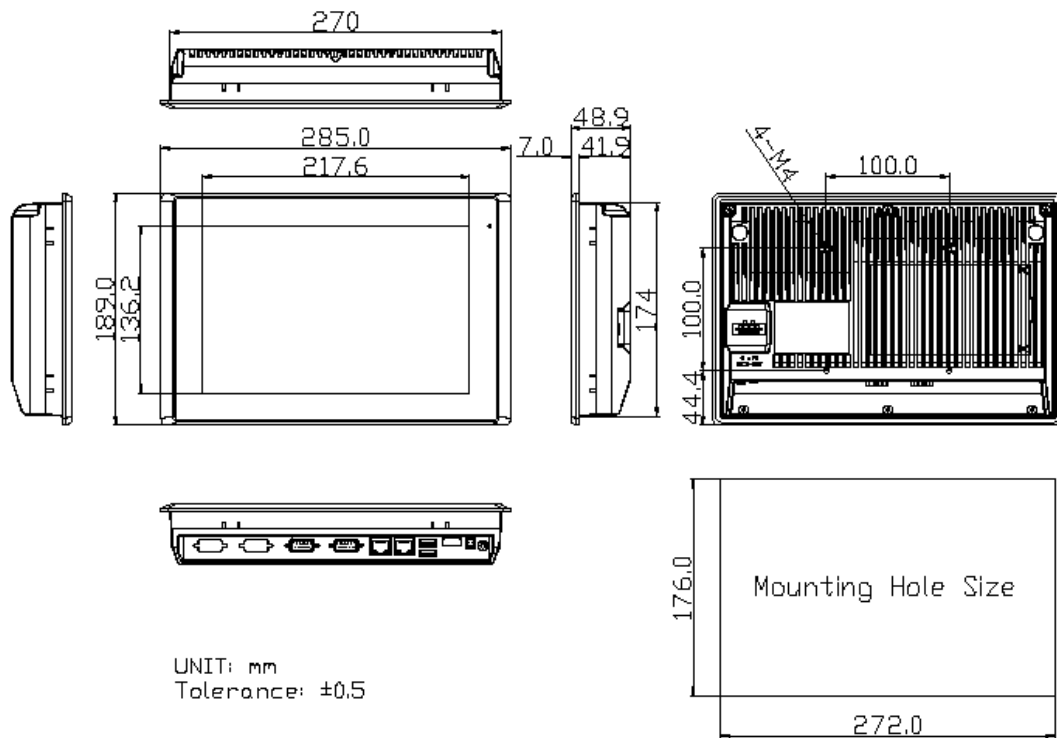

Figure 1.3: Dimensions of ARCHMI-810AP/AR/AG(H)

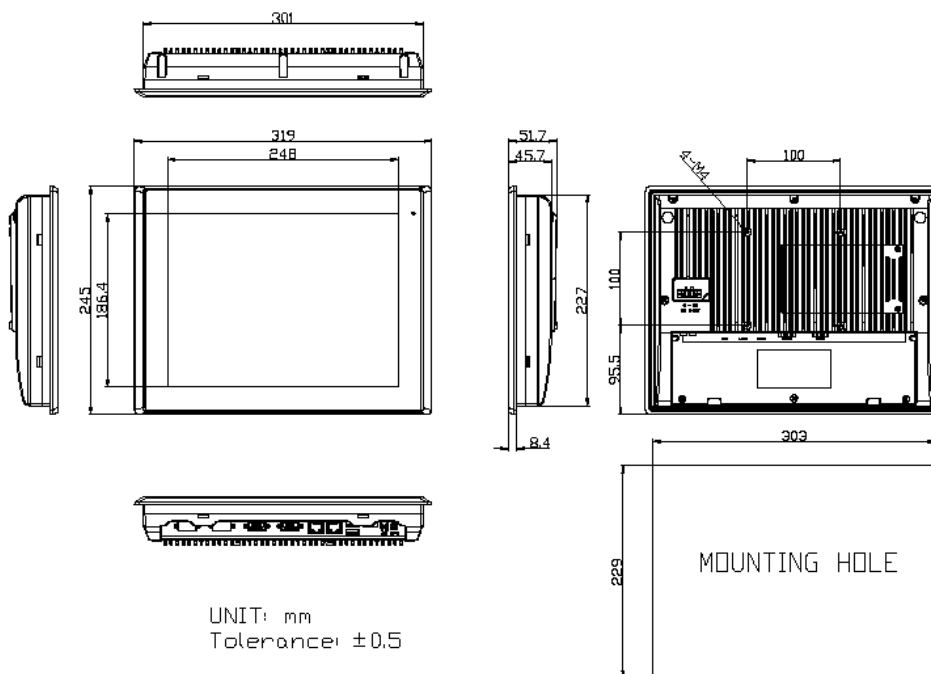

Figure 1.4: Dimensions of ARCHMI-812AP/AR/AG(H)

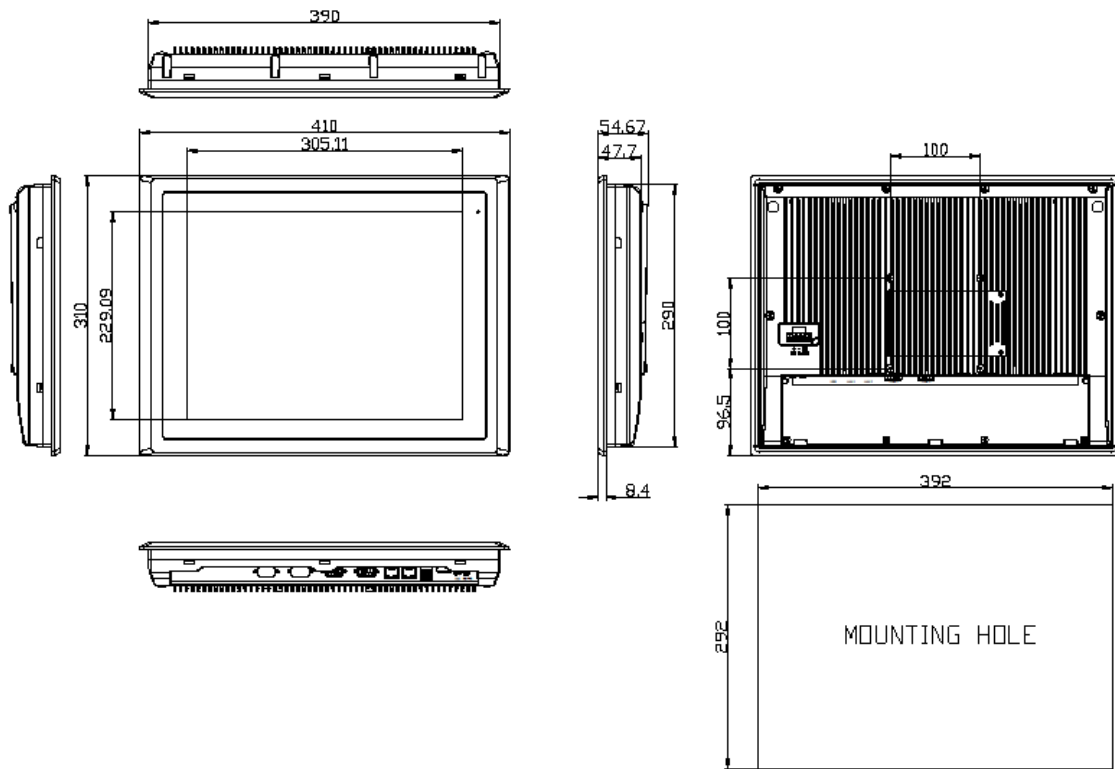

Figure 1.5: Dimensions of ARCHMI-815AP/AR/AG(H)

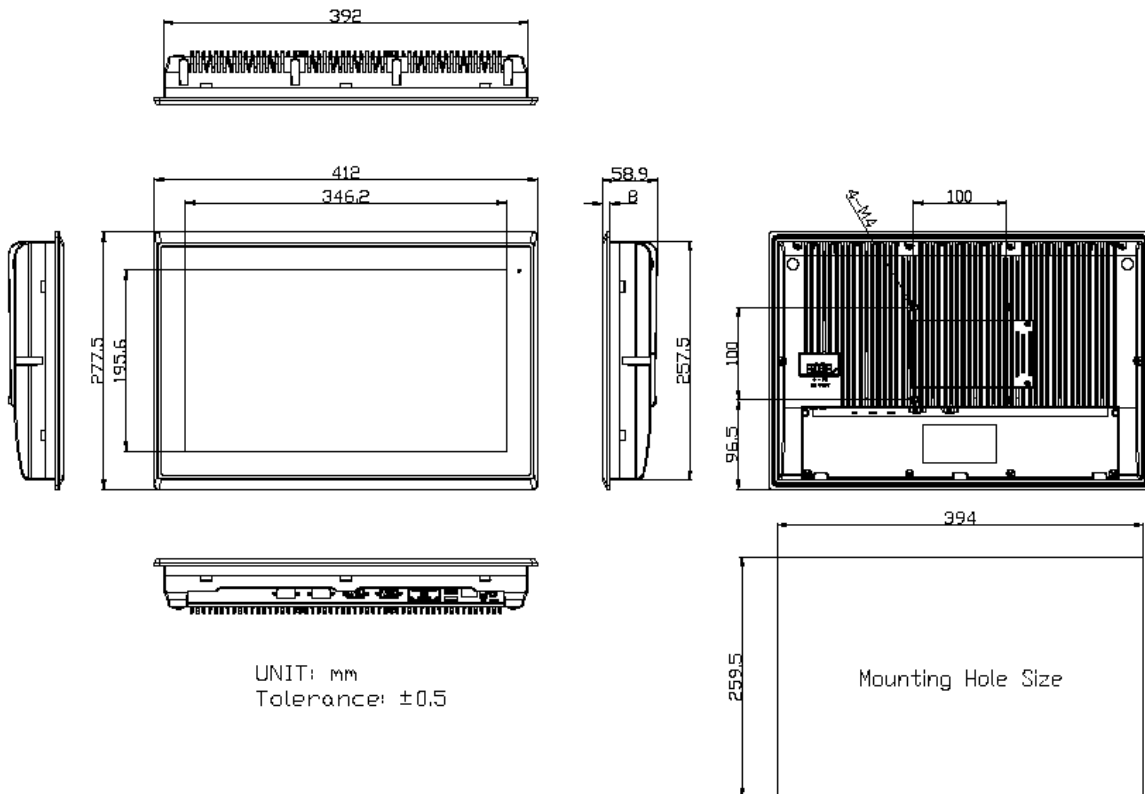

Figure 1.6: Dimensions of ARCHMI-816AP/AR/AG(H)

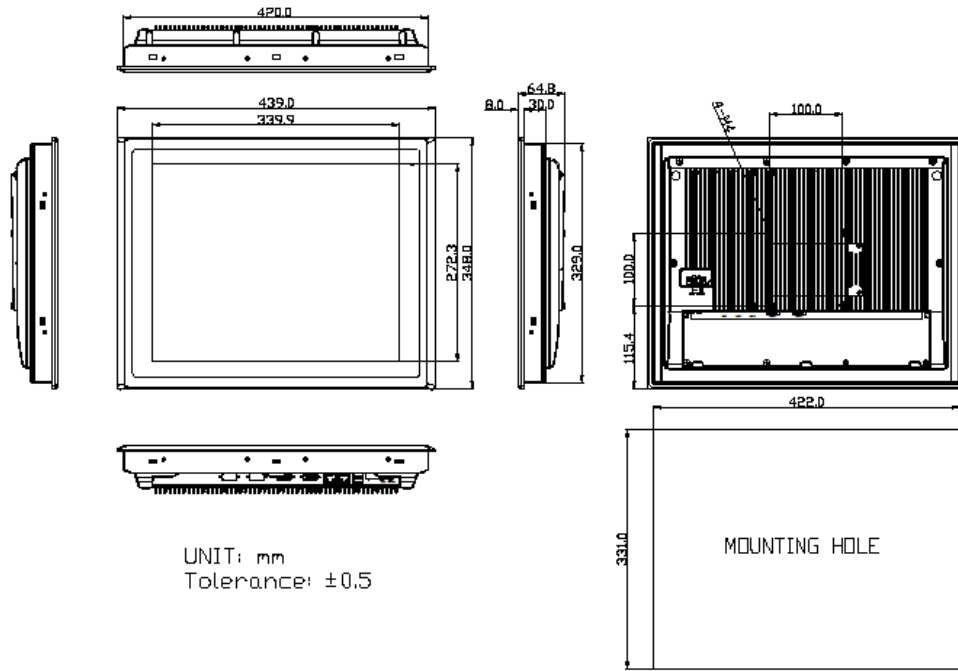

Figure 1.7: Dimensions of ARCHMI-817AP/AR/AG (H)

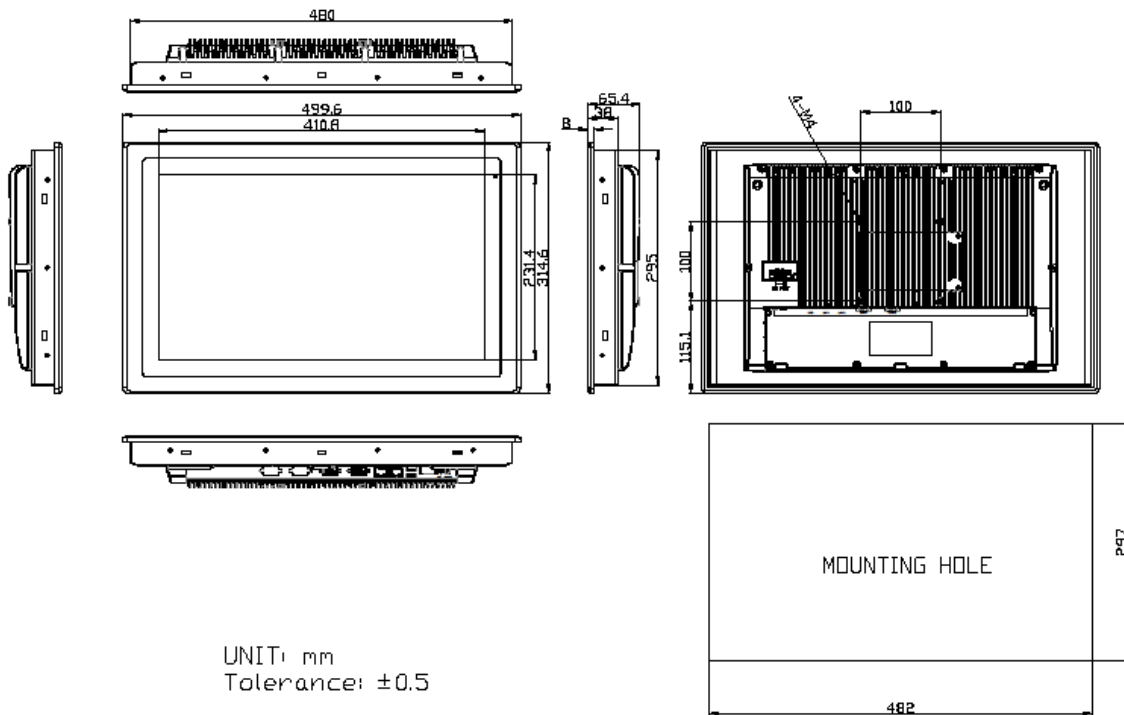

Figure 1.8: Dimensions of ARCHMI-818AP/AR/AG(H)

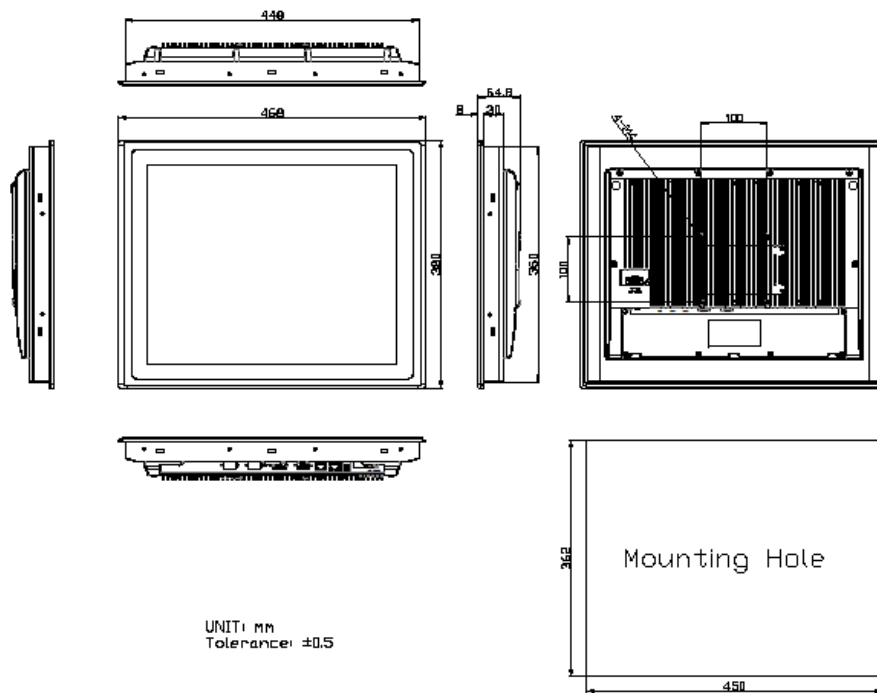

Figure 1.9: Dimensions of ARCHMI-819AP/AR/AG(H)

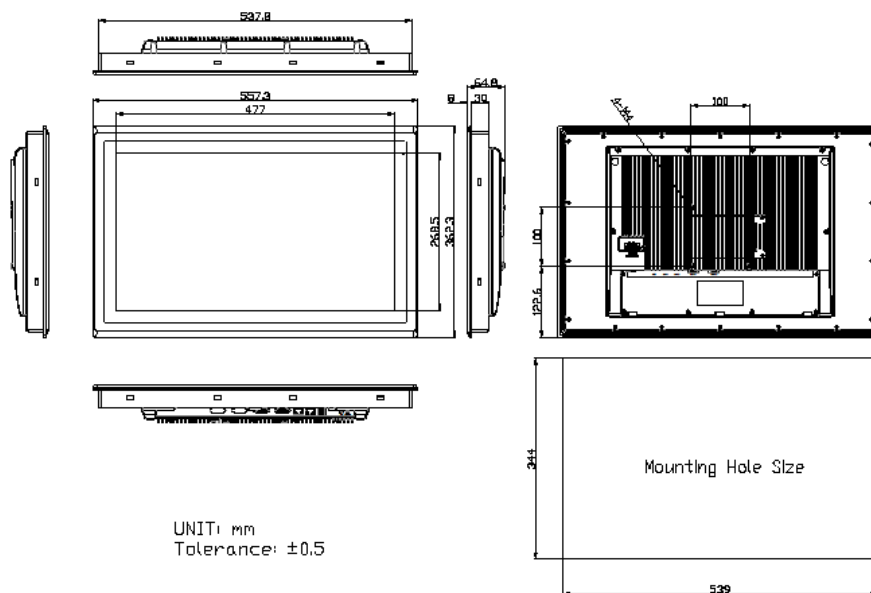

Figure 1.10: Dimensions of ARCHMI-821AP/AR/AG(H)

1.4 Brief Description of ARCHMI-8XXA Series

There are 7" ~ 21.5" Industrial Compact Size Panel PC in ARCHMI-8XXA series, which comes with flat front panel touch screen and fanless design. It is powerful by Intel Apollo Lake N4200/N3350 CPU Processors with one SO-DIMM DDR3L slot, up to 8GB 1333 MHz. These systems support DC 9~36V wide-ranging power input and IP66 compliant front panel. Optional projected capacitive touch support 7H anti-scratch surface is ideal for use as PC-based controller for Industrial Automation & Factory Automation. Furthermore, ARCHMI-8XXA Series are capable of expanding the function by option expansion I/O boards, TB-528 series, includes Mini-PCIe, CAN bus, POE, USB, COM and isolation I/O module to improve competitive advantage through providing critical flexibility and expansibility for the variety of applications and requirements.



Figure 1.11: Front View of ARCHMI-807A



Figure 1.12: Rear View of ARCHMI-807A



Figure 1.13: Front View of ARCHMI-808A



Figure 1.14: Rear View of ARCHMI-808A

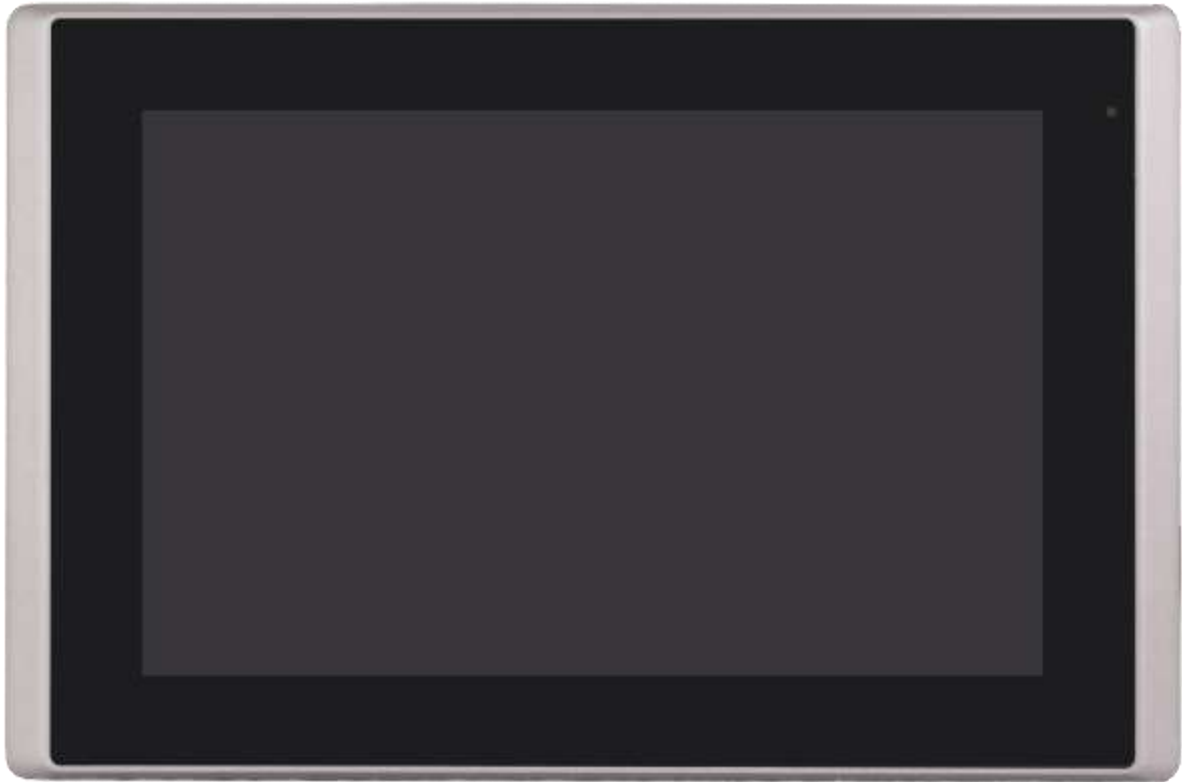

Figure 1.15: Front View of ARCHMI-810A



Figure 1.16: Rear View of ARCHMI-810A

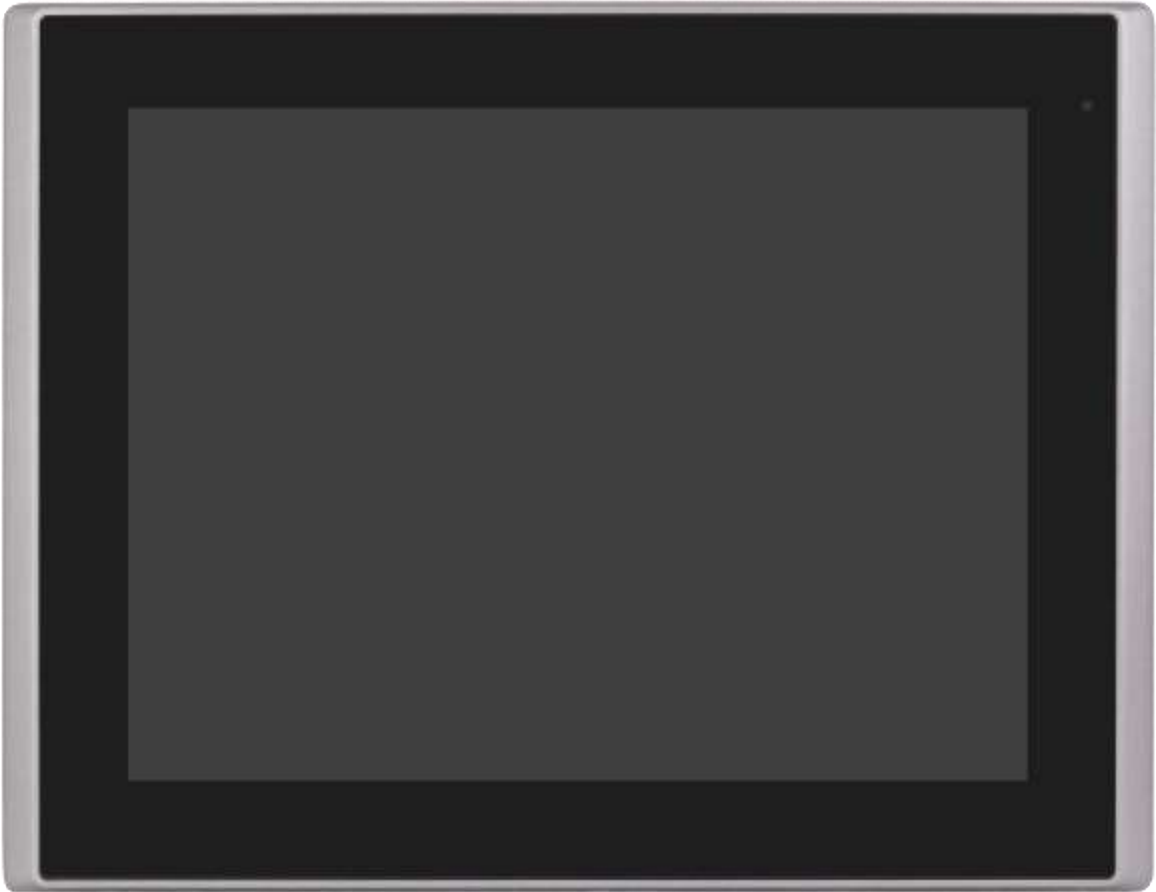

Figure 1.17: Front View of ARCHMI-812A



Figure 1.18: Rear View of ARCHMI-812A



Figure 1.19: Front View of ARCHMI-815A



Figure 1.20: Rear View of ARCHMI-815A



Figure 1.21: Front View of ARCHMI-816A



Figure 1.22: Rear View of ARCHMI-816A



Figure 1.23: Front View of ARCHMI-817A



Figure 1.24: Rear View of ARCHMI-817A



Figure 1.25: Front View of ARCHMI-818A



Figure 1.26: Rear View of ARCHMI-818A



Figure 1.27: Front View of ARCHMI-819A



Figure 1.28: Rear View of ARCHMI-819A



Figure 1.29: Front View of ARCHMI-821A



Figure 1.30: Rear View of ARCHMI-821A

1.5 Installation of HDD

Step 1

There are 2 screws to deal with when enclosing or removing the chassis. Gently remove 2 screws.



Step 2

You can put or remove HDD into the machine by pulling the HDD bracket.



Step 3

You can remove HDD by unscrewing 4 screws in the HDD bracket. Note: 4 screws are packed in the packing package.



1.6 VESA Mounting

The ARCHMI-8XXX series is designed to be VESA mounted as shown in Picture. Just carefully place the unit through the hole and tighten the given screws from the rear to secure the mounting.

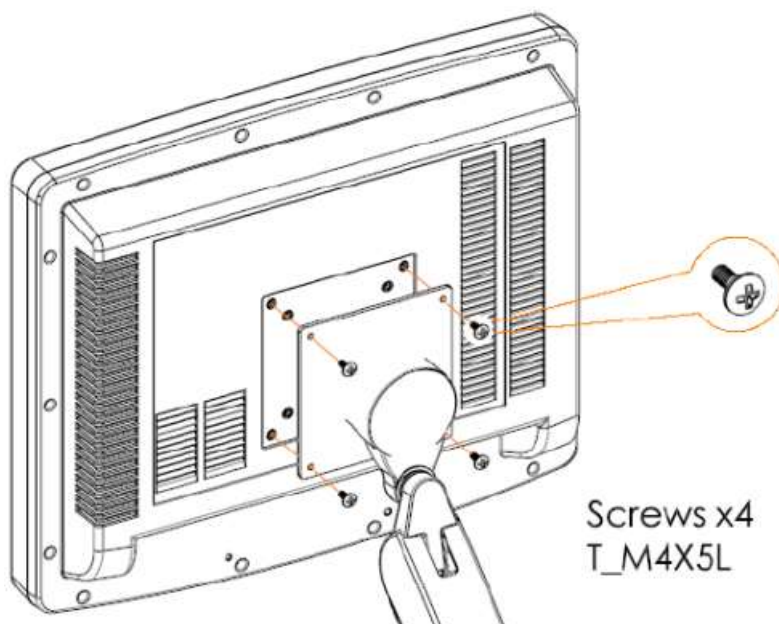

Figure 1.31: ARCHMI-8XXX Series VESA Mounting

1.7 Panel Mounting

There are four holes located along the four sides of the HMI. Insert the clamp from the four sides and tighten them with the nuts provided.

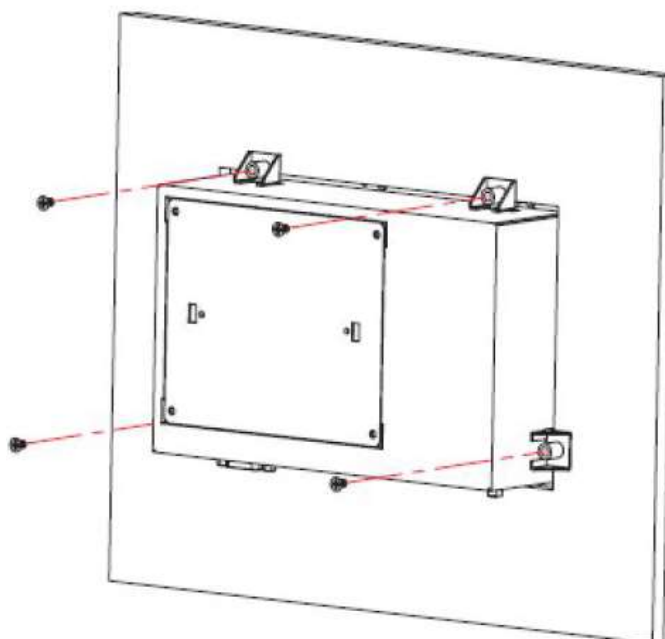

Figure 1.32: ARCHMI-8XXX Series Panel Mounting

2.1 Motherboard Introduction

SBC-7118 is a 4" industrial motherboard developed on the basis of Intel Apollo Lake Processor, which provides abundant peripheral interfaces to meet the needs of different customers. Also, it features dual GbE ports, 6-COM ports and one mSATA configuration, one HDMI port, one LVDS interface. To satisfy the special needs of high-end customers, CN1 and CN2 and CN3 richer extension functions. The product is widely used in various sectors of industrial control.

2.2 Specifications

Specifications	
Board Size	170mm x 113mm
CPU Support	Intel® Pentium®N4200 /1.10GHz Intel® Celeron®N3350 /1.10GHz (option)
Chipset	SOC
Memory Support	Onboard 4GB/8GB(option)DDR3L 1333MHz FSB
Graphics	Intel® HD Graphics 505 (N4200) Intel® HD Graphics 500 (N3350)
Display Mode	1 x HDMI Port 1 x LVDS (18/24-bit dual LVDS) via CN1 1 x CRT Port via 2x6 Pin header (VGA1)
Support Resolution	Up to 3840 x 2160 for HDMI 1.4b Up to 1920 x 1200 for LVDS (PS8625) Up to 1920 x 1200 for CRT
Dual Display	HDMI + LVDS HDMI + CRT LVDS + CRT
Super I/O	Nuvoton NCT6106D
BIOS	AMI/UEFI
Storage	1 x SATAIII, 7+15P Connector (SATA1) 1 x SATAIII Connector (7P), w/ 2Pin SATA power (SATA2, Signal share with mSATA) 1 x Micro SD/Micro SIM Combo Slot 1 x MSATA (Socket share with mPCIE, Signal share with SATA2)

Ethernet	2 x PCIe GbE LAN by Intel I210-AT
USB	2 x USB 3.0 (type A) stack ports (USB3_1/USB3_2) 1 x USB 2.0 via CN1 (USB2) 2 x USB 2.0 via CN2 (USB6/USB7) 1 x USB 2.0 via CN3 (USB5) 1 x USB 2.0 for MPCIE1 (USB0)
Serial	1 x RS232/RS422/RS485 port, DB9 connector for external (COM1) Pin 9 w/5V/12V/Ring select 1 x RS232 port, DB9 connector for external (COM2) Pin 9 w/5V/12V/Ring select 2 x UART for CN2 (COM3,COM4) 1 x RS422/485 via CN3 (COM5) 1 x RS422/485 via CN3 (COM6)
Digital I/O	8-bit digital I/O by Pin header (CN3) 4-bit digital Input 4-bit digital Output 4-bit digital I/O by Pin header (CN2) 2-bit digital Input 2-bit digital Output
Battery	Support CR2477 Li battery by 2-pin header (BAT1/CMOS)
Smart Battery	1 x Smart battery Support 3 Serial Li battery by 10-pin Header (BAT1/CMOS)
Audio	Support Audio via Realtek ALC269Q HD audio codec Support Line-out by JACK (LINE_OUT1) Support Line-in, Line-out, MIC by 2x6-pin header(AUDIO1) Support a stereo Class-D Speaker Amplifier with 2 watt per channel output power, by 1x4-pin header (SPK1)
TPM	Infineon's Trusted Platform Module (TPM2.0) *Note: Only support Windows 10 IOT*
Expansion Bus	1 x mini-PCI-express slot (Share with MSATA, Default) 1 x PCI-express for CN2
Touch Ctrl	1 x 6Pin connector for 4W/5W Resistive Touch (TCH1)
Power Management	Wide Range DC9V~36V input 1 x 3-pin power input connector
Switches and LED Indicators	1 x Power on/off switch (BT1/BT2/CN2/CN3) 1 x Reset (CN3)

	1 x HDD LED status (CN3) 1 x Power LED status (CN1) 1 x Buzzer
Temperature	Operating: 0°C to 70°C Storage: -40°C to 85°C
Humidity	10% - 90%, non-condensing, operating
EMI/EMS	Meet CE/FCC class A

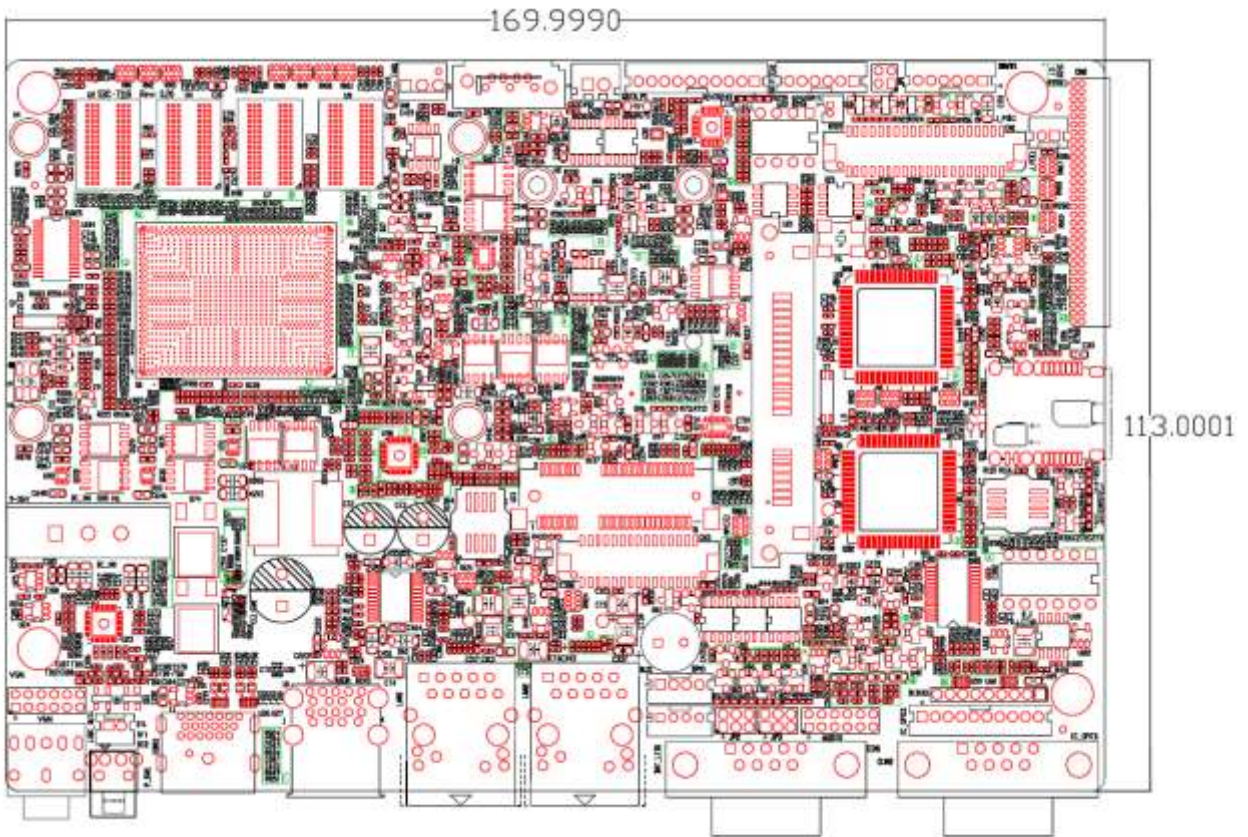

(units: mm)

Figure 2.1: Motherboard Dimensions

2.3 Jumpers and Connectors Location

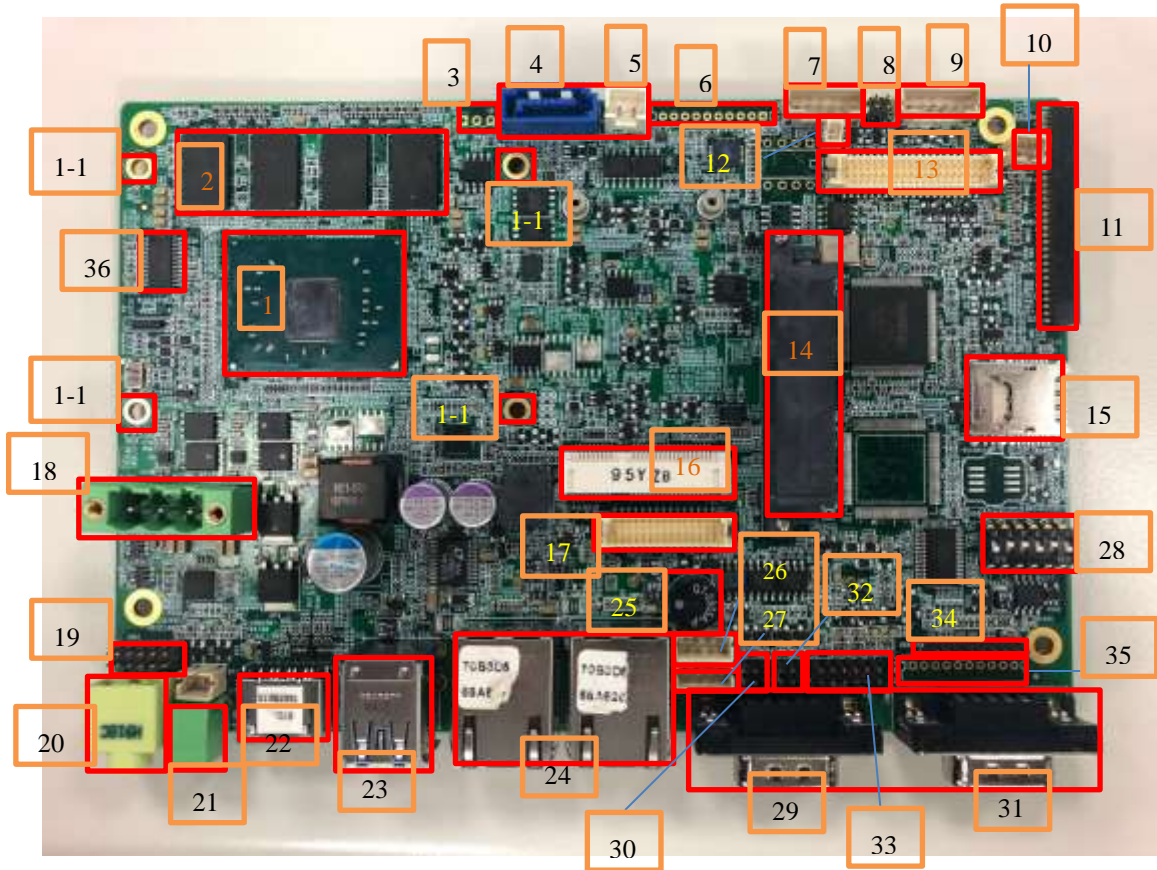

Figure 2.2: Jumpers and Connectors Location- Board Top

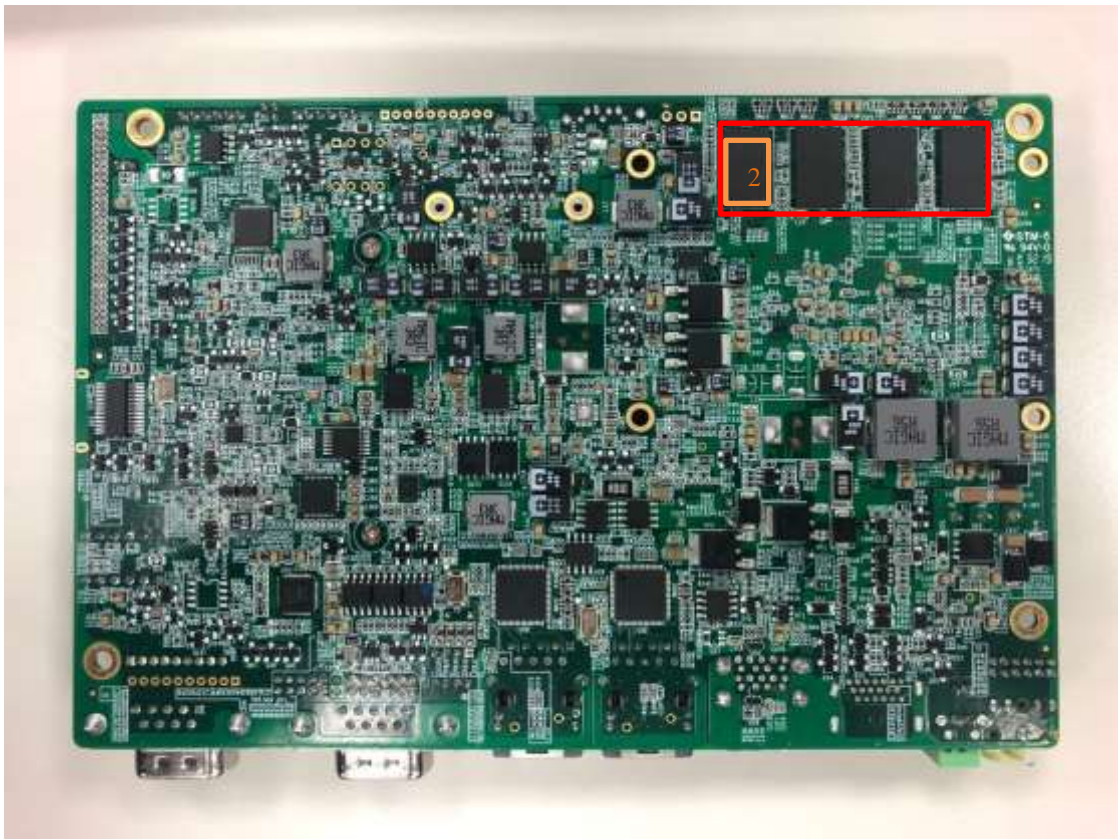

Figure 2.3: Jumpers and Connectors Location- Board Bottom

2.4 Jumpers Setting and Connectors

1. U1:

(FCBGA1090), Onboard Pentium N4200/Celeron N3350 processors

1-1. H3/H4/H5/H6 (option):

CPU1 Heat Sink Screw holes, four screw holes for Intel Apollo Lake N-series Processors. Heat Sink assemblies.

2. U2/U3/U4/U5/U7/U8/U9/U10:

(FBGA96) Onboard dual channel DDR3L memory

Model	Memory
SBC-7118-N4200-4G	4GB
SBC-7118-N4200P-4G	4GB
SBC-7118-N4200-8G	8GB
SBC-7118-N4200P-8G	8GB
SBC-7118-N3350-4G	4GB
SBC-7118-N3350P-4G	4GB
SBC-7118-N3350-8G	8GB
SBC-7118-N3350P-8G	8GB

3. FAN1: (Reserved)

(2.54mm Pitch 1x3 Pin Header), Fan connector, cooling fans can be connected directly to use. You may set the rotation condition of cooling fan in menu of BIOS CMOS Setup.

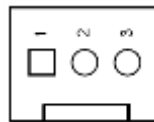

Pin#	Signal Name
1	Ground
2	VCC
3	Rotation detection



Note:

Output power of cooling fan must be limited under 5W.

4. SATA2:

(SATA 7Pin), SATA Connectors, one SATA connector is provided with transfer speed up to 6.0Gb/s. Signal share with mSATA devices.

5. SATA_P1 :

(2.5mm Pitch 1x2 box Pin Header), One onboard 5V output connector is reserved to provide power for SATA devices.

Pin#	Signal Name
1	5V_S0 (+DC5V output)
2	Ground



Note:

Output current of the connector must not be above 1A.

6. BAT2: (Reserved)

(2.0mm Pitch 1x10 Wafer Pin Header), Smart battery Interface

Pin#	Signal Name
Pin1	VCC_BAT1
Pin2	VCC_BAT1
Pin3	VCC_BAT1
Pin4	SMB_DAT_SW
Pin5	SMB_CLK_SW
Pin6	BAT1_TEMP
Pin7	GND
Pin8	GND
Pin9	GND
Pin10	SET_BAT1_ON

Function	Specifications
Nominal voltage (3S1P)	11.1~12.6V
Charge voltage	12.6V
Charge current	0.5C

7. TCH1:

(2.0mm Pitch 1x6 wafer Pin Header), Internal Touch controller connector

Pin#	Signal Name
1	SENSE
2	X+
3	X-
4	Y+
5	Y-
6	GND_EARCH

8. JP1:

(2.0mm Pitch 2x2 wafer Pin Header), Touch jumper setting

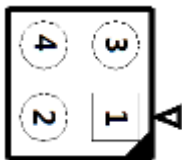

JP3	Touch (TCH1)
Open 3-4(default)	Enable
Close 3-4(option)	Disable
Open 1-2(default)	--

9. INVT1:

(2.0mm Pitch 1x6 wafer Pin Header), Backlight control connector for LVDS.



Pin#	Signal Name
1	12V_S0
2	12V_S0
3	GND
4	GND
5	BKLT_EN_OUT
6	BKLT_EN_CTRL

10. J_POE1:

(2.0mm Pitch 1x2 Wafer Pin Header), POE or DCIN input setting.

J_POE1 (Jumper)	DC_IN1	BAT2
Pin1-Pin2 (open, Default)	●	-
Pin1-Pin2 (Close)	-	●

11. CN2:

(1.27mm Pitch 2x30 Female Header), For I/O expansion interface, it provides four GPIOs, 2xUSB2.0, 2xUART, PCIe1, SMBus, and is compatible with I/O expansion card TB-528 series.

Function	Signal Name	Pin#		Signal Name	Function
	5V_S5_USB	1	2	5V_S5_USB	
	5V_S5_USB	3	4	5V_S5_USB	
	USB2_OC1-	5	6	PS_ON_ALL	
USB6	USB6_N	7	8	USB6_P	USB6
USB7	USB7_N	9	10	USB7_P	USB7
	GND	11	12	Ground	

	NA	13	14	NA	
	NA	15	16	NA	
COM4 (UART)	COM4_RI-	17	18	COM4_DCD-	COM4 (UART)
	COM4_TXD	19	20	COM4_RXD-	
	COM4_DTR-	21	22	RICOM4_RTS-	
	COM4_DSR-	23	24	COM4_CTS-	
	GND	25	26	GND	
COM3 (UART)	COM3_RI-	27	28	COM3_DCD-	COM3 (UART)
	COM3_TXD	29	30	COM3_RXD	
	COM3_DTR-	31	32	COM3_RTS-	
	COM3_DSR-	33	34	COM3_CTS-	
GPIO16	SOC_5V_GPIO16	35	36	SOC_5V_GPIO17	GPIO17
GPIO18	SOC_5V_GPIO18	37	38	SOC_5V_GPIO19	GPIO19
	GND	39	40	Ground	
PCIe1x	PE3_TX_N0	41	42	PE3_TX_P0	PCIe1x
	PE3_RX_N0	43	44	PE3_RX_P0	
	GND	45	46	GND	
	CLK_100M_PE3_N	47	48	CLK_100M_PE3_P	
	PCIE_WAKE3-	49	50	PLT_RST_BUF1-	
SMBUS	SMB_CLK_S5	51	52	SMB_DATA_S5	SMBUS
	CLKREQ0_PE3-	53	54	GND	
	3P3V_S5	55	56	FP_PWRBTN_ON-	PWR AUTO ON
	3P3V_S5	57	58	3P3V_S5	
12V	12V_S0	59	60	12V_S0	12V

12. BAT1:

(1.25mm Pitch 1x2 Wafer Pin Header, SMD) 3.0V Li Battery is embedded to provide power for CMOS. CMOS clear operation will permanently reset old BIOS settings to factory defaults.

Pin#	Signal Name
Pin1	Battery 3V
Pin2	Battery 0V



Procedures of CMOS clear:

- Turn off the system and unplug the power cord from the power outlet.
- Remove the lithium battery connection from BAT1 for 10 seconds, and then connect it.
- Power on the system again.
- When entering the POST screen, press the <ESC> or key to enter CMOS Setup Utility to load optimal defaults.
- After the above operations, save changes and exit BIOS Setup.

13. CN1:

(1.25mm Pitch 2x20 Connector, DF13-40P), For 18/24-bit LVDS output, contains LVDS output, USB2.0 and power LED.

Function	Signal Name	Pin#		Signal Name	Function
LVDS Signal	12V_S0	2	1	12V_S0	LVDS Signal
	BKLT_EN_OUT	4	3	BKLT_CTRL	
	GND	6	5	GND	
	LVDS_VDD5	8	7	LVDS_VDD5	
	LVDS_VDD3	10	9	LVDS_VDD3	
	GND	12	11	GND	
	LA_D0_P	14	13	LA_D0_N	
	LA_D1_P	16	15	LA_D1_N	
	LA_D2_P	18	17	LA_D2_N	
	LA_D3_P	20	19	LA_D3_N	
	LA_CLKP	22	21	LA_CLKN	
	LB_D0_P	24	23	LB_D0_N	
	LB_D1_P	26	25	LB_D1_N	
	LB_D2_P	28	27	LB_D2_N	
	LB_D3_P	30	29	LB_D3_N	
LB_CLKP	32	31	LB_CLKN		
USB7 (option)	GND	34	33	LCD_EDID_DET	
	USB2_CN1_P	36	35	USB2_CN1_N	
	5V_S5_USB	38	37	LVDS1_DDC_DATA	
Power LED	PWR_LED+	40	39	LVDS1_DDC_CLK	

14. SATA1:

(SATA 7Pin+15Pin), SATA Connectors, one SATA connector is provided with transfer speed up to 6.0Gb/s.

15. SD1:



Micro SD/Micro SIM combo socket

16. MPCIE1 (miniPCI express/mini SATA):

(50.95mm x 30mm Socket 52Pin), Mini PCI express socket. Support mini-PCIe (full size) devices with PCIe1, USB2.0, LPCbus, SMBus and SIM card via SD1. Share with mini SATA, select via S_1.

Function	Support
Mini SATA(Signal share with SATA2)	○(Option, S_1 setting)
Mini PCIe	●(Default, S_1 setting)
SM bus	●
SIM	●
USB2.0	●

17. CN3:

(DF13-30P Connector), for expanding output connector, it provides 8xGPIO, 2xRS-422/RS-485, USB2.0, Power on/off, Reset, HDD LED.

Function	Signal Name	Pin#		Signal Name	Function
5V	5V_S5	2	1	5V_S5	5V
6106_GPIO41	GPIO_IN2	4	3	GPIO_IN1	6106_GPIO40
6106_GPIO43	GPIO_IN4	6	5	GPIO_IN3	6106_GPIO42
6106_GPIO45	GPIO_OUT2	8	7	GPIO_OUT1	6106_GPIO44
6106_GPIO47	GPIO_OUT4	10	9	GPIO_OUT3	6106_GPIO46
	GND	12	11	GND	
485 or 422(COM5)	485+_422TX5+	14	13	485-_422TX5-	485 or 422(COM5)
	422_RX5+	16	15	422_RX5-	
485 or 422(COM6)	485+_422TX6+	18	17	485-_422TX6-	485 or 422(COM6)
	422_RX6+	20	19	422_RX6-	
5V	5V_S0	22	21	HDD_LED+	HDD LED
USB2.0	5V_USB5	24	23	5V_USB5	USB2.0
	USB5_P	26	25	USB5_N	
	GND	28	27	FP_RST-	RESET
Power auto on	FP_PWRBTN_ON-	30	29	GND	

COM5 BIOS Setup:

Advanced /NCT6106D Super IO Configuration/ COM5 Configuration [RS4-422]

Advanced /NCT6106D Super IO Configuration/ COM5 Configuration [RS4-485]

COM6BIOS Setup:

Advanced /NCT6106D Super IO Configuration/ COM6 Configuration [RS4-422]

Advanced /NCT6106D Super IO Configuration/ COM6 Configuration [RS4-485]

18. DC_IN1:

(5.08mm Pitch 1x3 Pin Connector),DC 9V~36V System power input connector.

Pin#	Power Input
Pin1	DC_IN+(DC+9V~36V)

Pin2	GND
Pin3	FG

Model	DC_IN1
SBC-7118-N4200-4G	180°Connector
SBC-7118-N4200P-4G	45°Connector
SBC-7118-N4200-8G	180°Connector
SBC-7118-N4200P-8G	45°Connector
SBC-7118-N3350-4G	180°Connector
SBC-7118-N3350P-4G	45°Connector
SBC-7118-N3350-8G	180°Connector
SBC-7118-N3350P-8G	45°Connector

Connector	Power input
DC_IN1 (Default)	DC_IN1
BAT2 (option)	BAT2
DC_IN1 + BAT2 (option)	DC_IN1

19. VGA1 :

(CRT 2.0mm Pitch 2x6 Pin Header) Video Graphic Array port

Signal Name	Pin#	Pin#	Signal Name
CRT_RED	1	2	GND
CRT_GREEN	3	4	GND
CRT_BLUE	5	6	NA
CRT_H_SYNC	7	8	CRT_DDCDATA
CRT_V_SYNC	9	10	CRT_DDCCLK
GND	11	12	GND

VGA hot plug setting

VGA1 (Pin Header)	Function
Pin4-Pin6 (Close)	VGA Simulation Disabled
Pin4-Pin6 (Open)	VGA Simulation Enabled

Please use 2.0mm jumper cap to close pin4 and pin6.

20. Line_Out:

(Diameter 3.5mm Jack), HD Audio port. An onboard Realtek ALC269Q codec is used to provide high quality audio I/O ports. Line Out can be connected to a headphone or amplifier.



Line out

21. P_SW1/BT1, BT2:

Power on/off button: Use to connect external power switch button. The two pins are disconnected under normal condition. You may short them temporarily to realize system startup & shutdown or awaken the system from sleep state. P_SW1 or BT1 need to be selected before manufacturing.

(2.0mm Pitch 1x2 Wafer Pin Header), Power on/off button, used to connect power switch button

P_SW1 or BT2	Function
P_SW1 (Button)	○ (Option)
BT2 (1x2Pin connect)	● (Default)

22. HDMI1:

(HDMI 19P Connector), HDMI 1.4b Port. High Definition Multimedia Interface connector.



23. USB1:

USB3-1/USB3-2 : (Double stack USB type A), Rear USB connector, it provides up to two USB3.0 ports, High-speed USB 2.0 allows data transfers up to 480 Mb/s, USB 3.0 allows data transfers up to 5.0Gb/s, support USB full-speed and low-speed signaling.

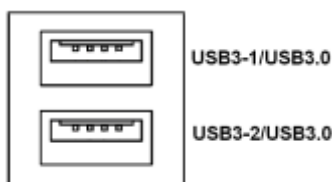

Each USB Type A Receptacle (2 Ports) Current limited value is **2.0A**.

If the external USB device current exceeds 1.5A, please separate connectors into different Receptacle.

24. LAN1/LAN2:

LAN1/LAN2: (RJ45 Connector), Rear LAN port, Two standard 10/100/1000M RJ-45 Ethernet ports are provided. Use Intel 82574L chipset, LINK LED (green) and ACTIVE LED (green or orange) respectively located at the left-hand and right-hand side of the Ethernet port indicate the activity and transmission state of LAN.

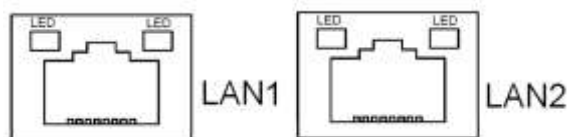

25. BUZ1:

Onboard buzzer.

26. SPK1:

(2.0mm Pitch 1x4 Wafer Pin Header), support a stereo Class-D Speaker Amplifier with 2 watt per channel output power

Pin#	Signal Name
1	SPK_OUTL_P
2	SPK_OUTL_N
3	SPK_OUTR_N
4	SPK_OUTR_P

27. BAT_LED1:

(2.0mm Pitch 1x4 Wafer Pin Header) The Charge status indicator for BAT2.

Pin1-Pin3: Charge LED status.

Pin2-Pin3: Discharge LED status.

Pin4-Pin3: This is reserved for LVDS MCU IC reset.

Pin#	Signal Name
Pin1	BAT1_LED+
Pin2	BAT1_LED-
Pin3	SBW_TCK
Pin4	SBW_TDIO_RST-

28. S_1(Switch):

Pin#	ON/OFF	Function
Pin1 AT/ATX Select	ON	Auto Power On (Default)
	OFF	ATX Power
Pin2 RTC Reset	ON	RTC Reset
	OFF	Normal
Pin3 LVDS Setting	ON	Single channel LVDS
	OFF	Dual channel LVDS
Pin4 LVDS Setting	ON	8/24 bit
	OFF	6/18 bit
Pin5 EDID Setting	ON	Panel EDID (Reserved)
	OFF	Onboard EDID (Reserved)
Pin6 MPCIE Signal Select	ON	mPCIe (Default)
	OFF	mSATA

29. COM1:

(Type DB9M),Rear serial port, standard DB9 Male serial port is provided to make a direct connection to serial devices. COM1 port is controlled by pins No.1~6 of JP1, select output Signal RI or 5V or 12V, for details, please refer to description of JP1 setting.

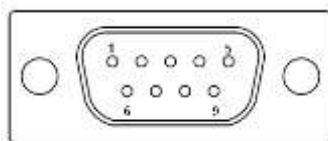

RS232 (Default):	
Pin#	Signal Name
1	DCD# (Data Carrier Detect)
2	RXD (Received Data)
3	TXD (Transmit Data)
4	DTR (Data Terminal Ready)
5	Ground
6	DSR (Data Set Ready)
7	RTS (Request To Send)
8	CTS (Clear To Send)
9	JP1 select Setting (RI/5V/12V)
BIOS Setup : Advanced/NCT6106D Super IO Configuration/F75111 COM1 Configuration 【RS-232】	

RS422 (option):	
Pin#	Signal Name
1	422_TX-
2	422_TX+
3	422_RX+
4	422_RX-
5	Ground
6	NC
7	NC
8	NC
9	NC
BIOS Setup : Advanced/NCT6106D Super IO Configuration/F75111 COM1 Configuration 【RS-422】	

RS485 (option):	
Pin#	Signal Name
1	485-
2	485+
3	NC
4	NC
5	Ground

6	NC
7	NC
8	NC
9	NC
BIOS Setup : Advanced/NCT6106D Super IO Configuration/F75111 COM1 Configuration 【RS-485】	

30. JP2:

(2.0mm Pitch 2x3 Pin Header), COM1 jumper setting, pin 1~6 are used to select signal out of pin 9 of COM1 port.

JP2 Pin#	Function
Close 1-2	COM1 RI (Ring Indicator) (default)
Close 3-4	COM1 Pin9 : DC+5V (option)
Close 5-6	COM1 Pin9 : DC+12V (option)

31. COM2:

(Type DB9M), Rear serial port, standard DB9 Male serial port is provided to make a direct connection to serial devices.

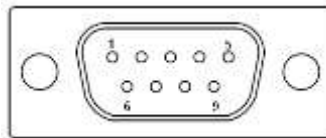

Pin#	Signal Name
1	DCD# (Data Carrier Detect)
2	RXD (Received Data)
3	TXD (Transmit Data)
4	DTR (Data Terminal Ready)
5	Ground
6	DSR (Data Set Ready)
7	RTS (Request To Send)
8	CTS (Clear To Send)
9	JP2 select Setting (RI/5V/12V)

32. JP3:

(2.0mm Pitch 2x3 Pin Header), COM2 jumper setting, pin1~6 are used to select signal out of pin9 of COM2 port.

JP2 Pin#	Function
Close 1-2	COM2 RI (Ring Indicator) (Default)

Close 3-4	COM2 Pin9: DC+5V (option)
Close 5-6	COM2 Pin9: DC+12V (option)

33. AUDIO1:

(2.0mm Pitch 2X6 Pin Header), Front Audio, An onboard Realtek ALC269Q codec is used to provide high-quality audio I/O ports. Line Out can be connected to a headphone or amplifier. Line In is used for the connection of external audio source via a Line in cable. MIC is the port for microphone input audio.

Signal Name	Pin#	Pin#	Signal Name
5V_F_AUDIO	1	2	GND_AUD
OUT-L	3	4	OUT-R
HPOUT_JD	5	6	LINE_IN_JD
LINE-IN-L	7	8	LINE-IN-R
MIC-IN-L	9	10	MIC-IN-R
GND_AUD	11	12	MIC1_JD

34. DEBUG1:

(2.0mm Pitch 1x9 Pin Header), For motherboard debug

Pin#	Signal Name
1	LPC_FRAME
2	LPC_AD3
3	LPC_AD2
4	LPC_AD1
5	LPC_AD0
6	GND
7	PLT_RST_BUF1-
8	LPC_DEBUG_CLK
9	3P3V_S0

35. EC_GPIO1 : (Reserved)

(2.0mm Pitch 1X10 Pin Header), for expand connector, it provides eight GPIO.

Pin#	Signal Name	GPIO Name
1	Ground	Ground
2	GPA0_ONOFF	EC_GPA0
3	GPA1_SPK-	EC_GPA1
4	GPE6_BKLT-	EC_GPE6
5	GPE0_BKLT+	EC_GPE0
6	GPH3_SPK+	EC_GPH3
7	BKLT_CTRL_PWR	BKLT_CTRL_PWR
8	ADC6_BKLT_CTRL	EC_ADC6

9	ADC7_RSV	EC_ADC7
10	3P3V_ALLS_EC	3.3V_ALLS_EC

36. U104:

Infineon’s Trusted Platform Module (TPM2.0) SLB 9665 is a fully standard compliant TPM based on the latest Trusted Computing Group (TCG) specification 2.0.

Note: Only support Windows 10 IOT 2019 LTSC.

TPM_U1	SLB 9665 TT2.0
--------	----------------

37. LED1:

LED1: LED STATUS. Green LED for Touch status.

38. LED2/LED3/LED4/LED5/LED6:

LED2: LED STATUS. Green LED for 3P3V_ALLS_EC power status.

LED3: LED STATUS. Green LED for 3P3V_S5 power status.

LED4: LED STATUS. Green LED for motherboard standby power good status.

LED5: LED STATUS. Green LED for charge status

LED6: LED STATUS. Green LED for charge complete status.

39. BT1:

(A2001WV-2P, 2.0mm Pitch 2 Pin Wafer Header), DC 9~36V output. Connect with DC power input.

40. TB-528 Series:

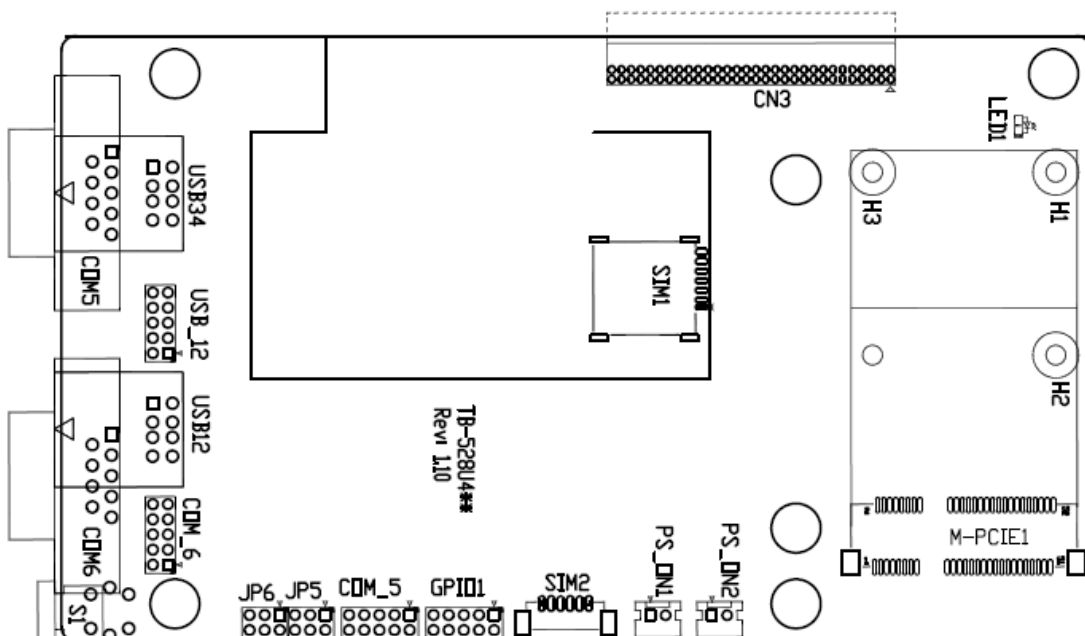

No.	Model	CN3 2*30P	S1	USB12 TypeA	USB34 TypeA	USB_12 2*5P	COM5 DB9	COM6 DB9	COM_5 2*5P	COM_6 2*5P	JP5 2*3P	JP6 2*3P	GPIO 2*5P	SIM1 Socket	SIM2 1*6P	M_PCIE1 52P	PS_ON1 1*2P	PS_ON2 1*2P
1	TB-528U4C2ME1P1 R110	●	●	●	●	●	●	●	●	●	●	●	●	●	●	●	●	●
2	TB-528U4ME1 R110	●	●	●	●	○	○	○	○	○	○	○	●	●	○	●	●	●
3	TB-528U4 R110	●	○	●	●	○	○	○	○	○	○	○	○	○	○	○	○	○
4	TB-528C1U2P1 R110	●	●	●	○	○	●	○	○	○	●	○	●	○	○	○	●	●
5	TB-528C1U2 R110	●	○	●	○	○	●	○	○	○	●	○	●	○	○	○	●	●
6	TB-528C2ME1 R110	●	○	○	○	○	●	●	○	○	●	●	●	●	○	●	●	●
7	TB-528C2 R110	●	○	○	○	○	●	●	○	○	●	●	○	○	○	○	○	○

CN3 :

(1.27mm Pitch 2X30 Pin Header), connect to SBC-7118 CN2 pin Header.

M-PCIE1 :

(Socket 52Pin), mini PCIe socket, it is located at the top, it supports mini PCIe devices with **USB2.0(USB3)**, Smbus, SIM and PCIe signal. MPCle card size is 30x30mm or 30x50.95mm.

Signal Name	Function support
PCIe 1X	Yes
USB2.0 (USB2)	Yes
SMBus	Yes
SIM	Yes

H1/H2:

MPCIE1 SCREW HOLES, H2 for mini PCIE card (30mmx30mm) assemble. H1 for mini PCIE card (30mmx50.95mm) assemble.

LED1 :

Mini PCIe devices LED Status.

SIM1 :

(SIM Socket 6 Pin), Support SIM Card devices.

SIM2 (Option) :

(1.25mm Pitch 1x6 Pin Wafer), For SIM card devices' expansion

GPIO1 :

(2.0mm Pitch 2x5 Pin Header), General-purpose input/output port, it provides a group of self-programming interfaces to customers for flexible use.

Signal Name	Pin#	Pin#	Signal Name
Ground	1	2	GPIO_OUT1
GPIO_OUT2	3	4	SMB_DATA_R
SMB_CLK_R	5	6	GPIO_IN1
GPIO_IN2	7	8	GPIO_IN3
GPIO_IN4	9	10	+5V

USB12/USB34 (USB-HUB):

(Double stack USB type A), Rear USB connector, it provides up to 4 USB 2.0 ports, speed up to 480Mb/s.

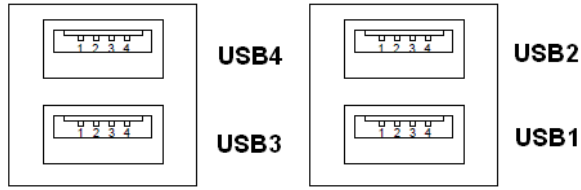

USB12:

(2.0mm Pitch 2x5 Pin Header), Front USB connector, it provides two USB port via a dedicated USB cable, speed up to 480Mb/s.

Signal Name	Pin#	Pin#	Signal Name
5V_USB12	1	2	5V_USB12
E_USB1_N	3	4	E_USB2_N
E_USB1_P	5	6	E_USB2_P
Ground	7	8	Ground
NC	9	10	Ground



Note:

Before connection, make sure that pinout of the USB Cable is in accordance with that of the said tables. Any inconformity may cause system down and even hardware damages.

JP5 :

(2.0mm Pitch 2x3 Pin Header), COM5 setting jumper, pin 1~6 are used to select signal out of pin 9 of COM5 port.

JP5 Pin#	Function
Close 1-2	RI (Ring Indicator) (default)
Close 3-4	COM5 Pin9=+5V (option)
Close 5-6	COM5 Pin9=+12V (option)

COM5:

(Type DB9), serial port, standard DB9 serial port is provided to make a direct connection to serial devices. COM5 port is controlled by pins No.1~6 of **JP5**, select output Signal RI or 5V or 12v, for details, please refer to description of JP3.

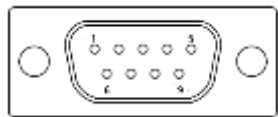

Pin#	Signal Name
1	DCD# (Data Carrier Detect)
2	RXD (Received Data)
3	TXD (Transmit Data)
4	DTR (Data Terminal Ready)
5	Ground
6	DSR (Data Set Ready)
7	RTS (Request To Send)
8	CTS (Clear To Send)
9	JP5 Setting: Pin1-2 : RI (Ring Indicator) (default) Pin3-4 : 5V Standby power (option) Pin5-6:12V Standby power (option)

COM_5:

(2.0mm Pitch 2x5 Pin Header), COM5 Port, up to one standard RS232 port is provided. It can be used directly via COM cable connection.

Signal Name	Pin#	Pin#	Signal Name
DCD	1	2	RXD
TXD	3	4	DTR
Ground	5	6	DSR
RTS	7	8	CTS
JP6 Setting RI/5V/12V	9	10	NC

JP6 :

(2.0mm Pitch 2x3 Pin Header),COM6 setting jumper, pin 1~6 are used to select signal out of pin 9 of COM6 port.

JP6 Pin#	Function
Close 1-2	RI (Ring Indicator) (default)
Close 3-4	COM6 Pin9=+5V (option)
Close 5-6	COM6 Pin9=+12V (option)

COM6 :

(Type DB9),serial port, standard DB9 serial port is provided to make a direct connection to serial devices. COM6 port is controlled by pins No.1~6 of **JP6**, select output Signal RI or 5V or 12v, for details, please refer to description of JP6.

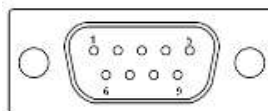

Pin#	Signal Name
1	DCD# (Data Carrier Detect)
2	RXD (Received Data)
3	TXD (Transmit Data)
4	DTR (Data Terminal Ready)
5	Ground
6	DSR (Data Set Ready)
7	RTS (Request To Send)
8	CTS (Clear To Send)
9	JP6 Setting: Pin1-2 : RI (Ring Indicator) (default) Pin3-4 : 5V Standby power (option) Pin5-6: 12V Standby power (option)

COM_6:

(2.0mm Pitch 2x5 Pin Header), COM6 Port, up to one standard RS232 port is provided. It can be used directly via COM cable connection.

Signal Name	Pin#	Pin#	Signal Name
DCD	1	2	RXD
TXD	3	4	DTR
Ground	5	6	DSR
RTS	7	8	CTS
JP6 Setting RI/5V/12V	9	10	NC

PS_ON1 :

(2.0mm Pitch 1X2 Pin Wafer), ATX Power and Auto Power on jumper setting.

PS_ON	Mode
Close 1-2	Auto Power on (Default)
Open 1-2	ATX Power

PS_ON2 (option):

(2.0mm Pitch 1x2 Pin Wafer)

S1:

PWR BT: POWER on/off BUTTON. It is used to connect power switch button. The two pins are disconnected under normal condition. You may short them temporarily to realize system startup & shutdown or awaken the system from sleep state.

PWR LED: POWER LED status.

41. TB-528CAN2 R2.00 (option):

SBC-7118 IO expansion card, it provides two CAN-bus interfaces.

TB-528CAN2 Top :

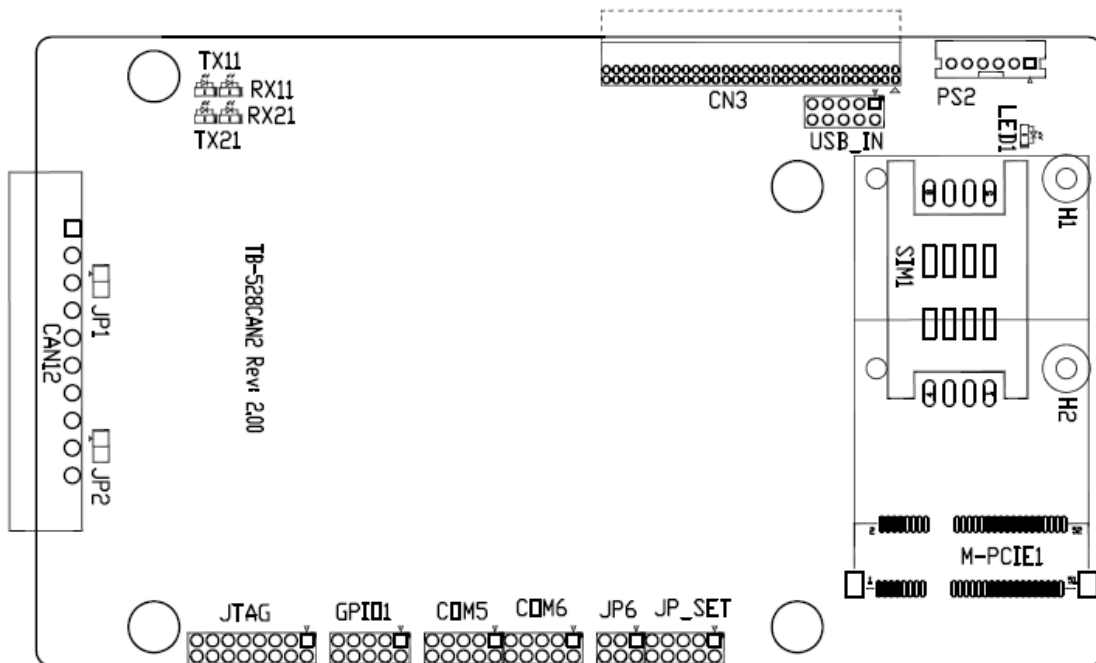

CN3 :

(1.27mm Pitch 2X30 Pin Header), connect to SBC-7118 CN2 pin Header.

M-PCIE1:

(Socket 52Pin), mini PCIe socket, it is located at the top, it supports mini PCIe devices with SMBus, USB2.0, SIM and PCIe signal. MPCie card size is 30x30mm or 30x50.95mm.

Signal Name	Function support
PCIe 1X	YES
USB2.0 (USB2)	YES
SMBus	YES
SIM	YES

H1/H2:

MPCIE1 SCREW HOLES, H2 for mini PCIE card (30 x 30mm) assemble. H1 for mini PCIE card (30 x 50.95mm) assemble.

LED1:

Mini PCIe devices LED Status

SIM1 (option):

(SIM Socket 6 Pin), Support SIM Card devices.

PS2:

(2.0mm Pitch 1x6 Pin Wafer), PS/2 keyboard and mouse port, the port can be connected to PS/2 keyboard or mouse via a dedicated cable for direct use.

Pin#	Signal Name
1	KBDATA
2	MSDATA
3	Ground
4	+5V
5	KBCLK
6	MSCLK

USB_IN (option):

(2.0mm Pitch 2x5 Pin Header), Front USB connector, it provides two USB ports via a dedicated USB cable, speed up to 480Mb/s.

Signal Name	Pin#	Pin#	Signal Name
5V_USB34	1	2	5V_USB34
NC(USB4_N)	3	4	NC(USB3_N)
NC(USB4_P)	5	6	NC(USB3_P)
Ground	7	8	Ground
NC	9	10	Ground



Note:

Before connection, make sure that pinout of the USB cable is in accordance with that of the said tables. Any inconformity may cause system down and even hardware damages.

JP_SET(option) :

(2.0mm Pitch 2x5 Pin Header)

Signal Name	Pin#	Pin#	Signal Name
3P3V_S5_USB	1	2	3P3V_S5
3P3V_S5_USB	3	4	3P3V_S5
3P3V_S5_USB	5	6	3P3V_S5
PSON_ATX	7	8	Ground
PSON_ATX	9	10	Ground

JP6 :

(2.0mm Pitch 2x3 Pin Header), COM6 setting jumper, pin 1~6 are used to select signal out of pin9 of COM6 port.

JP3 Pin#	Function
Close 1-2	RI (Ring Indicator) (default)
Close 3-4	COM6 Pin9 : +5V (option)
Close 5-6	COM6 Pin9 : +12V (option)

COM6(SBC-7118/COM4) :

(2.0mm Pitch 2x5 Pin Header), COM6 port, up to one standard RS232 port is provided. It can be used directly via COM cable connection.

Signal Name	Pin#	Pin#	Signal Name
DCD	1	2	RXD
TXD	3	4	DTR
Ground	5	6	DSR
RTS	7	8	CTS
JP6 Setting: RI/5V/12V	9	10	NC

COM5(SBC-7118/COM3) :

(2.0mm Pitch 2x5 Pin Header), COM5 Port, up to one standard RS232 port is provided. It can be used directly via COM cable connection.

Signal Name	Pin#	Pin#	Signal Name
DCD	1	2	RXD
TXD	3	4	DTR
Ground	5	6	DSR
RTS	7	8	CTS
JP6 Setting: RI/5V/12V	9	10	NC

GPIO1 :

(2.0mm Pitch 2x5 Pin Header), General-purpose input/output port, it provides a group of self-programming interfaces to customers for flexible use.

Signal Name	Pin#	Pin#	Signal Name
Ground	1	2	NC
NC	3	4	SMB_DATA_R
SMB_CLK_R	5	6	PCH-GPIO56
PCH-GPIO57	7	8	PCH-GPIO59
PCH-GPIO58	9	10	+5V

JTAG :

(2.0mm Pitch 2x5 Pin Header), Reserve.

JP1 :

(2.0mm Pitch 1x2 Pin Header), Reserve.

JP2 :

(2.0mm Pitch 1x2 Pin Header), Reserve.

CAN1/CAN2:

(3.5mm Pitch 1x10 Pin connector), it provides two CAN-bus interfaces.

Pin#	Channel	Signal Name	Function
1	CAN2	CANL2	CAN bus Signal L
2		R2-	Terminal resistor R-(internally connected to CANL2)
3		FG	Shield cable (FG)
4		R2+	Terminal resistor R+(internally connected to CANH2)
5		CANH2	CAN bus Signal H
6	CAN1	CANL1	CAN bus Signal L
7		R1-	Terminal resistor R-(internally connected to CANL1)
8		FG	Shield cable (FG)
9		R1+	Terminal resistor R+(internally connected to CANH1)
10		CANH1	CAN bus Signal H

【 See TB-528CAN2 Manual 】

42. TB-528E1U2/TB-528E1U2POE/ TB-528E1U2UPOE:

SBC-7118 IO expansion card, providing USB2.0 and 1xGbE LAN expansion can support POE (Power over Ethernet) powered device via onboard POE module.

TB-528E1U2POE Top :

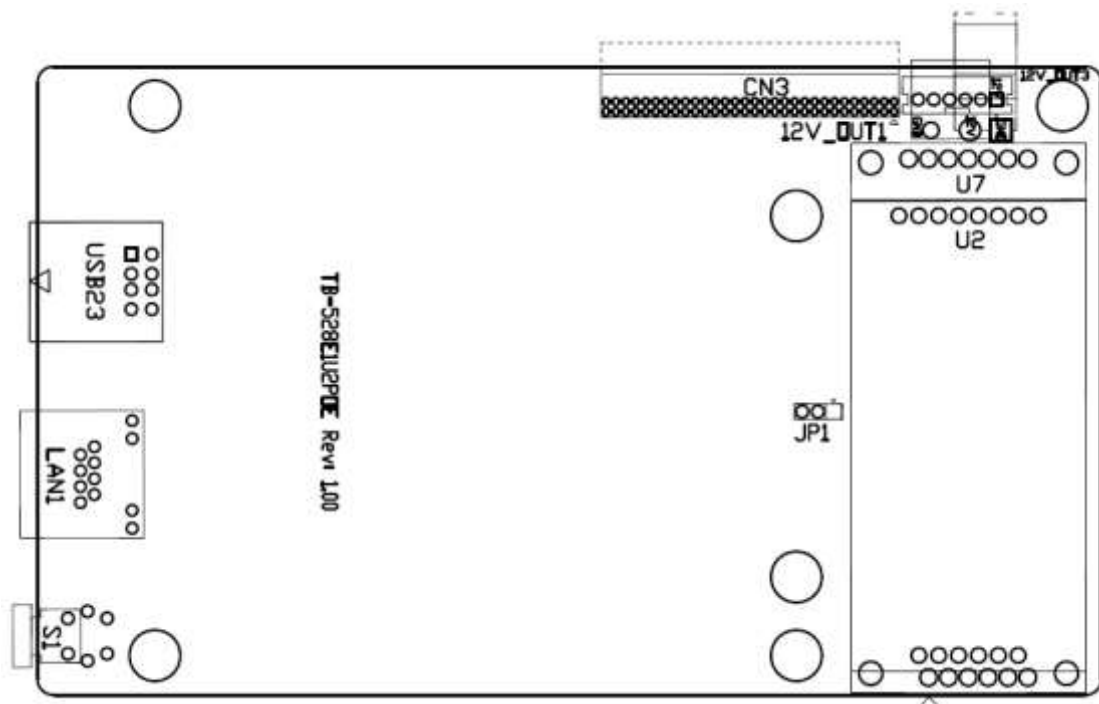

CN3 :

(1.27mm Pitch 2X30 Pin Header), connect to SBC-7118 CN2 pin Header.

USB23(SBC-7118 USB3/USB4) :

(Double stack USB type A), Rear USB connector, it provides up to 2 USB2.0 ports, speed up to 480Mb/s.



LAN1 :

(RJ45 Connector), Rear LAN port, one standard 10/100/1000M RJ-45 Ethernet port is provided. Use Intel I211-AT chipset, LINK LED (green) and ACTIVE LED (green) respectively located at the left-hand and right-hand side of the Ethernet port indicate the activity and transmission state of LAN.

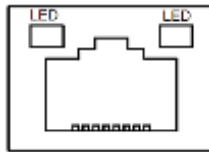

PSE Function support	
PSE output Voltage	DC44~ 57V

U2/U7(option) :

For onboard POE powered device module.

12V_OUT1 :

(3.96mm Pitch 1x2 Pin Header), POE DC12V Output.

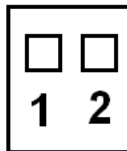

Pin#	Output Voltage
1	12V_POE
2	Ground

Model	U7	Maximum output Power	SBC-7118
TB-528E1UPOE	AG5510	40W	●

12V_OUT3 (option) :

(2.0mm Pitch 1X6 Pin Header), Reserve.

12V_OUT1 (option) :

(3.96mm Pitch 1x2 Pin Header), Reserve.

JP3 (option):

(2.0mm Pitch 1X3 Pin Header), Reserve.

S1 (option) : Reserve.

3.1 Operations after POST Screen

After CMOS discharge or BIOS flashing operation, press [Delete] key to enter CMOS Setup.



After optimizing and exiting CMOS Setup

3.2 BIOS Setup Utility

Press [Delete] key to enter BIOS Setup utility during POST, and then a main menu containing system summary information will appear.

3.3 Main Settings

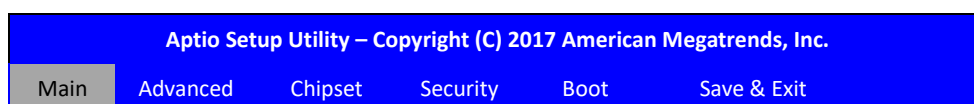

BIOS Information		Set the Time. Use Tab to Switch between Time elements.
BIOS Vendor	American Megatrends	
Core Version	5.12	
Compliance	UEFI 2.4; PI 1.3	
Project Version	7118v 0.16 x64	
Build Date and Time	06/19/2017 13:51:32	
Access Level	Administrator	
Platform firmware Information		
BXT SOC	B1	
MRC Version	Intel® Core™	
PUNIT FW	0.56	→←: Select Screen ↑↓ : Select Item Enter: Select +/- : Change Opt. F1 : General Help F2: Previous Values F3:Optimized Defaults F4:Save and Exit ESC Exit
PMC FW	28	
TXE FW	03.28	
ISH FW	N/A	
GOP	0.0.0036	
CPU Flavor	BXT Notebook/Desktop..	
Board ID	Oxbow Hill CRB (06)	
Fab ID	FAB1	
Memory Information		
Total Memory	4096 MB	
System Language	[English]	
System Date	[Sun 01/01/2009]	
System Time	[00:00:00]	
Version 2.18.1263. Copyright (C) 2017 American Megatrends , Inc.		

System Time:

Set the system time, the time format is:

Hour : 0 to 23

Minute : 0 to 59

Second : 0 to 59

System Date:

Set the system date, the date format is:

Day: Note that the 'Day' automatically changes when you set the date.

Month: 01 to 12

Date: 01 to 31

Year: 1998 to 2099

3.4 Advanced Settings

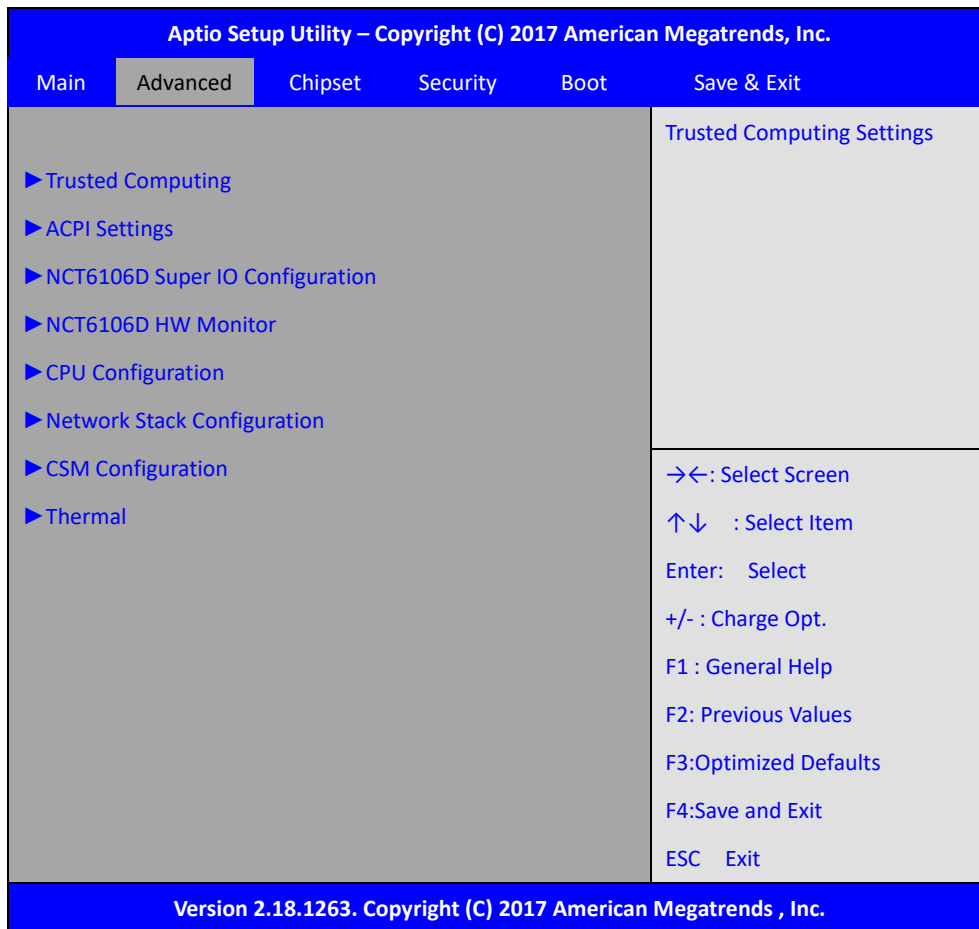

3.4.1 Trusted Computing

Security device Support	[Enabled]
SHA-1 PCR Bank	[Enabled]
SHA256 PCR Bank	[Enabled]
Pending operation	[None] [TPM Clare]
Platform Hierarchy	[Enabled]
Storage Hierarchy	[Enabled]
Endorsement Hierarchy	[Enabled]
Tpm2.0 UEFI Spec Version	[TCG_2] [TCG_1_2]
Physical Presence Spec Version	[1.3] [1.2]

TPM 20 Interface type	[TIS]
Device Select	[Auto] [TPM1.2] [TPM2.0]

3.4.2 ACPI Settings

Enable ACPI Auto Configuration:	[Disabled] [Enabled]
Enable Hibernation:	[Enabled] [Disabled]
ACPI Sleep State:	[S3 (Suspend to RAM)] [Suspend Disabled]
Lock Legacy Resources:	[Disabled] [Enabled]

3.4.3 NCT6106D Super IO Configuration

Super IO Chip	NCT6106D
Serial Port 1 Configuration	
Serial port	[Enabled] [Disabled]
Device Settings	IO=3F8h ; IRQ=4 ;
Change Settings	[Auto]
F75111 COM1 Config	[RS-232 Mode] [RS-485 Mode] [RS-422 Mode]
Serial Port 2 Configuration	
Serial port	[Enabled] [Disabled]
Device Settings	IO=2F8h ; IRQ=3 ;
Change Settings	[Auto]
Serial Port 3 Configuration	
Serial port	[Enabled] [Disabled]

Device Settings	IO=3E8h ; IRQ=7 ;
Change Settings	[Auto]
Serial Port 4 Configuration	
Serial port	[Enabled] [Disabled]
Device Settings	IO=2E8h ; IRQ=7 ;
Change Settings	[Auto]
Serial Port 5 Configuration	
Serial port	[Enabled] [Disabled]
Device Settings	IO=2F0h ; IRQ=7 ;
Change Settings	[Auto]
COM5 Config	[RS-485 Mode] [RS-422 Mode]
Serial Port 6 Configuration	
Serial port	[Enabled] [Disabled]
Device Settings	IO=2E0h ; IRQ=7 ;
Change Settings	[Auto]
COM6 Config	[RS-485 Mode] [RS-422 Mode]

3.4.4 NCT6106D HW Monitor

Pc Health Status

System temperature1	: +380°C
System temperature2	: +460°C
System temperature3	: +80 °C
System temperature4	: N/A
System temperature5	: NA
System temperature6	: +380°C

Fan1 speed	: NA
Fan2 speed	: NA
Fan3 speed	: NA

VCORE : +0.760 V

VIN0	: +6.441V
VIN1	: +6.864V
VIN2	: +8.870V
AVCC	: +3.456V
VSBB	: +3.440V
VCC3V	: +3.472V
VBAT	: +3.376V

3.4.5 CPU Configuration

CPU Configuration

Socket 0 cpu Information

Intel® Pentium® CPU N4200 @1.10GHz

CPU Signature	506C9
Microcode Patch	28
Max CPU Speed	1100 MHz
Mix CPU Speed	800 MHz

Processor Cores	4
Intel HT Technology	Not Supported
Intel VT-X Technology	Supported

L1 Data Cache	24KB x 4
L1 Code Cache	32KB x 4
L2 Cache	1024 KB x 2
L3 Cache	Not Present

Speed	1100 MHZ
64-bit	Supported

CPU Power Management

EIST	[Enabled]
Turbo Mode	[Enabled]
Boot performance mode	[Max Performance]
Power Limit 1 Enable	[Disabled]

Active Processor Cores	[Disabled]
Intel Virtualization Technology	[Enabled]
VT-d	[Disabled]

Bi-directional PROCHOT	[Enabled]
Thermal Monitor	[Enabled]
Monitor Mwait	[Disabled]
P-STATE Coordination	[HW_ALL]
	[SW_ALL]
	[SW_ANY]

DTS [Disabled]

Network Stack Configuration

Network Stack [Disabled]

3.4.6 CSM Configuration

CSM Support [Enabled]

CSM16 Module Version 07.79

GateA20 Active [Upon Request]

Option ROM Messages [Force BIOS]

INT19 Trap Response [Immediate]

Boot option filter [UEFI and Legacy]

Option ROM execution

Network [Do not launch]

Storage [Do not launch]

Video [Legacy]

Other PCI devices [Do not launch]

3.4.7 Thermal

Automatic Thermal Reporting [Enabled]

DPTF [Enabled]

DPTF Configuration [0]

DPTF Processor [Enabled]

Active Thermal Trip Point 90

Passive Thermal Trip point 100

S3/CS Thermal Trip Point 110

HOT Thermal Trip point	110
Critical Thermal Trip Point	105
Thermal Sampling Period	0
Display participant	[Enabled]
FAN Device	[Enabled]
Sensor Device 1	
Charger Participant	[Enabled]
Power participant	[Enabled]
Polling Rate	0
Generic Device 1	[Enabled]
Active Thermal Trip Point	60
Passive Thermal Trip point	65
S3/CS Thermal Trip Point	70
HOT Thermal Trip point	75
Critical Thermal Trip Point	80
Thermal Sampling Period	50
Generic Device 2	[Enabled]
Active Thermal Trip Point	60
Passive Thermal Trip point	65
S3/CS Thermal Trip Point	70
HOT Thermal Trip point	75
Critical Thermal Trip Point	80
Thermal Sampling Period	50
Generic Device 3	[Enabled]
Active Thermal Trip Point	60
Passive Thermal Trip point	65
S3/CS Thermal Trip Point	70
HOT Thermal Trip point	75
Critical Thermal Trip Point	80
Thermal Sampling Period	50
Generic Device 4	[Enabled]
Active Thermal Trip Point	60
Passive Thermal Trip point	65
S3/CS Thermal Trip Point	70
HOT Thermal Trip point	75
Critical Thermal Trip Point	80
Thermal Sampling Period	50

Design Variable 0	0
Design Variable 1	0
Design Variable 2	0
Design Variable 3	0
Design Variable 4	0
Design Variable 5	0

Virtual Sensor participant 1	[Disabled]
Virtual Sensor participant 2	[Disabled]
Virtual Sensor participant 3	[Disabled]

DPTF Policies

Active Policy	[Enabled]
Passive Policy	[Passive Policy 2.0]
TRT Revision	[Priority]
Critical Policy	[Enabled]
Power Boss	[Enabled]
Virtual Sensor	[Disabled]

3.5 Chipset Settings

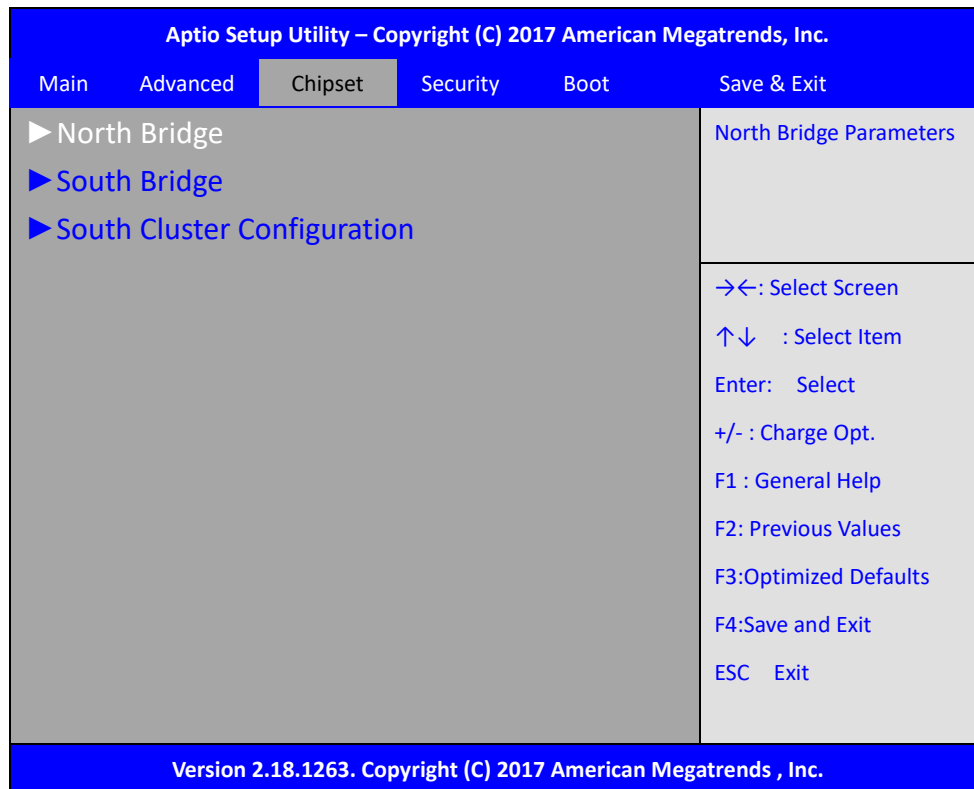

3.5.1 North Bridge

LCD Control	
Primary IGFX Boot Display	[Auto]
IGD Flat Panel	[Auto]
Active LFP	[eDP Port-A]
GMCH BLC Control	[PWM-Normal]
Panel Color	[8bit VESA]
Panel link	[Single link]
Memory Information	
Total Memory	4096 MB (LPDDR3)
Memory Slot0	2048 MB (LPDDR3)
Memory Slot1	2048 MB (LPDDR3)
Memory Slot2	Not Present
Memory Slot3	Not Present
Max TOLUD	[2 GB]
Above 4GB MMIO BIOS assignment	[Disabled]
Max TOLUD	[Disabled]

South Bridge

Serial IRQ Mode	[Continuous]
SMBus Support	[Enabled]
OS Selection	[Windows]
PCI CLOCK RUN	[Enabled]
State After G3	[S0 State]
F75111 GPIO20 Config	[Output]
F75111 GPIO20 Output setting	[Low]
F75111 GPIO21 Config	[Output]
F75111 GPIO21 Output setting	[Low]
F75111 GPIO22 Config	[Output]
F75111 GPIO22 Output setting	[Low]
F75111 GPIO23 Config	[Output]
F75111 GPIO23 Output setting	[Low]
F75111 GPIO24 Config	[Output]
F75111 GPIO24 Output setting	[Low]
F75111 GPIO25 Config	[Output]
F75111 GPIO25 Output setting	[Low]
F75111 GPIO26 Config	[Output]
F75111 GPIO26 Output setting	[Low]
F75111 GPIO27 Config	[Output]
F75111 GPIO27 Output setting	[Low]
F75111 COM1 Config	[RS232 mode]
F75111 COM5 Config	[RS485 mode]
F75111 COM6 Config	[RS485 mode]

South Cluster Configuration

PCI Express Configuration	
PCI Express Clock Gating	[Enabled]
PCIE Port assigned to LAN	5
Port8xh Decode	[Disabled]

Peer Memory Write Enable	[Disabled]
Compliance Mode	
PCI Express Root Port 1	
PCI Express Root Port 2	
PCI Express Root Port 3	
PCI Express Root Port 4	
PCI Express Root Port 5	
PCI Express Root Port 6	

SATA Drives

Chipset-SATA Controller Configuration

Chipset SATA	[Disabled]
SATA Mode Selection	[AHCI]
SATA Test Mode	[Disabled]
Aggressive LPM Support	[Enabled]

SATA Port 0	16GB SATA Flags (16.0GB)
Software Preserve	Unknown
Port 0	[Enabled]
SATA Port 0 Hot Plug Capability	[Disabled]
Configured as eSATA	Hot Plug supported
Mechanical Presence Switch	[Enabled]
Spin Up Device	[Disabled]
SATA Device Type	[Hard Disk Drive]
SATA Port 0 DevSlp	[Disabled]
DITO Configuration	[Disabled]
DITO Value	625
DM Value	15

SATA Port 0	[Not Installed]
Software Preserve	Unknown
Port 0	[Enabled]
SATA Port 0 Hot Plug Capability	[Disabled]
Configured as eSATA	Hot Plug supported
Mechanical Presence Switch	[Enabled]
Spin Up Device	[Disabled]
SATA Device Type	[Hard Disk Drive]
SATA Port 0 DevSlp	[Disabled]

DITO Configuration	[Disabled]
DITO Value	625
DM Value	15

SCC Configuration

SCC SD Card Support (D27:F0)	[Disabled]
SCC eMMC Support (D28:F0)	[Disabled]
SCC UFS Support (D29:F0)	[Disabled]
SCC SDIO Support (D30:F0)	[Disabled]

USB Configuration

XHCI Pre-Boot Driver	[Disabled]
XHCI Mode	[Disabled]

USB VBUS Support	[ON]
USB HSIC1 Support	[Disabled]
USB SSIC1 Support	[Disabled]

USB Port Disable Override	[Disabled]
XDCI Support	[Disabled]
XHCI Disable Compliance Mode	[FALSE]

Miscellaneous Configuration

BIOS LOCK	[Enabled]
-----------	-----------

3.6 Security Settings

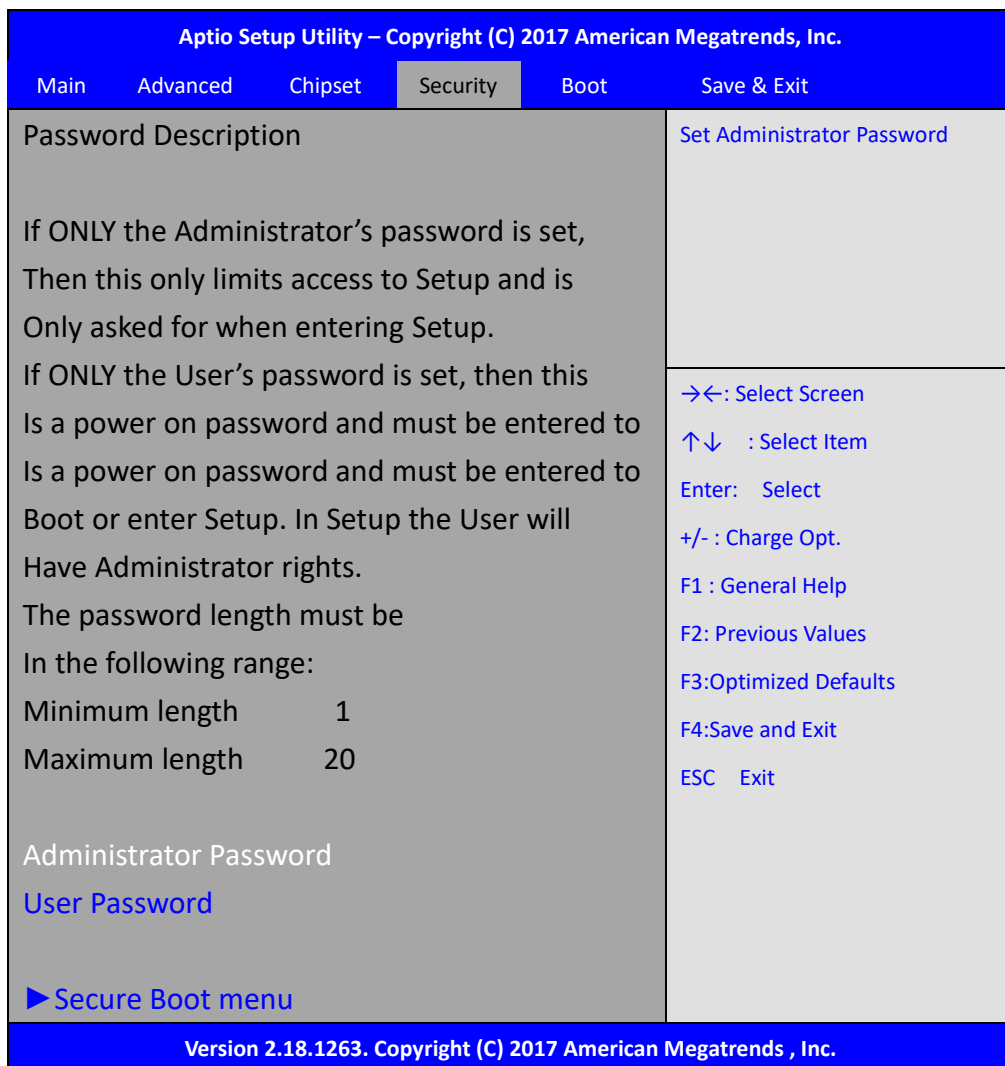

3.6.1 Setup Administrator Password



3.6.2 User Password



Type the password with up to 20 characters and then press <Enter> key. This will clear all previously typed CMOS passwords. You will be requested to confirm the password. Type the password again and press <Enter> key. You may press <Esc> key to abandon password entry operation.

To clear the password, just press <Enter> key when password input window pops up. A confirmation message will be shown on the screen as to whether the password will be disabled. You will have direct access to BIOS setup without typing any password after system reboot once the password is disabled.

Once the password feature is used, you will be requested to type the password each time you enter BIOS setup. This will prevent unauthorized persons from changing your system configurations.

Also, the feature is capable of requesting users to enter the password prior to system boot to control unauthorized access to your computer. Users may enable the feature in Security Option of Advanced BIOS Features. If Security Option is set to System, you will be requested to enter the password before system boot and when entering BIOS setup; if Security Option is set to Setup, you will be requested for password for entering BIOS setup.

3.7 Boot Settings

Aptio Setup Utility – Copyright (C) 2017 American Megatrends, Inc.					
Main	Advanced	Chipset	Security	Boot	Save & Exit
Boot Configuration				Controls the placement of newly detected UEFI boot options	
Setup Prompt Timeout		1			
Bootup Numlock State		[On]			
Quiet Boot		[Disabled]			
Boot Option Priorities					
Boot Option #1				→←: Select Screen	
Fast Boot		[Enabled]		↑↓ : Select Item	
				Enter: Select	
				+/- : Change Opt.	
Driver Option Priorities				F1 : General Help	
New Boot Option Policy		[Default]		F2: Previous Values	
				F3:Optimized Defaults	
				F4:Save and Exit	
				ESC Exit	
Version 2.18.1263. Copyright (C) 2017 American Megatrends , Inc.					

Setup Prompt Timeout	1
Bootup Numlock State	[On]
Quiet Boot	[Disabled]
Boot Option Priorities	
Fast Boot	[Disabled]
Driver Option Priorities	
New Boot Option Policy	[Default]

3.8 Save & Exit Settings

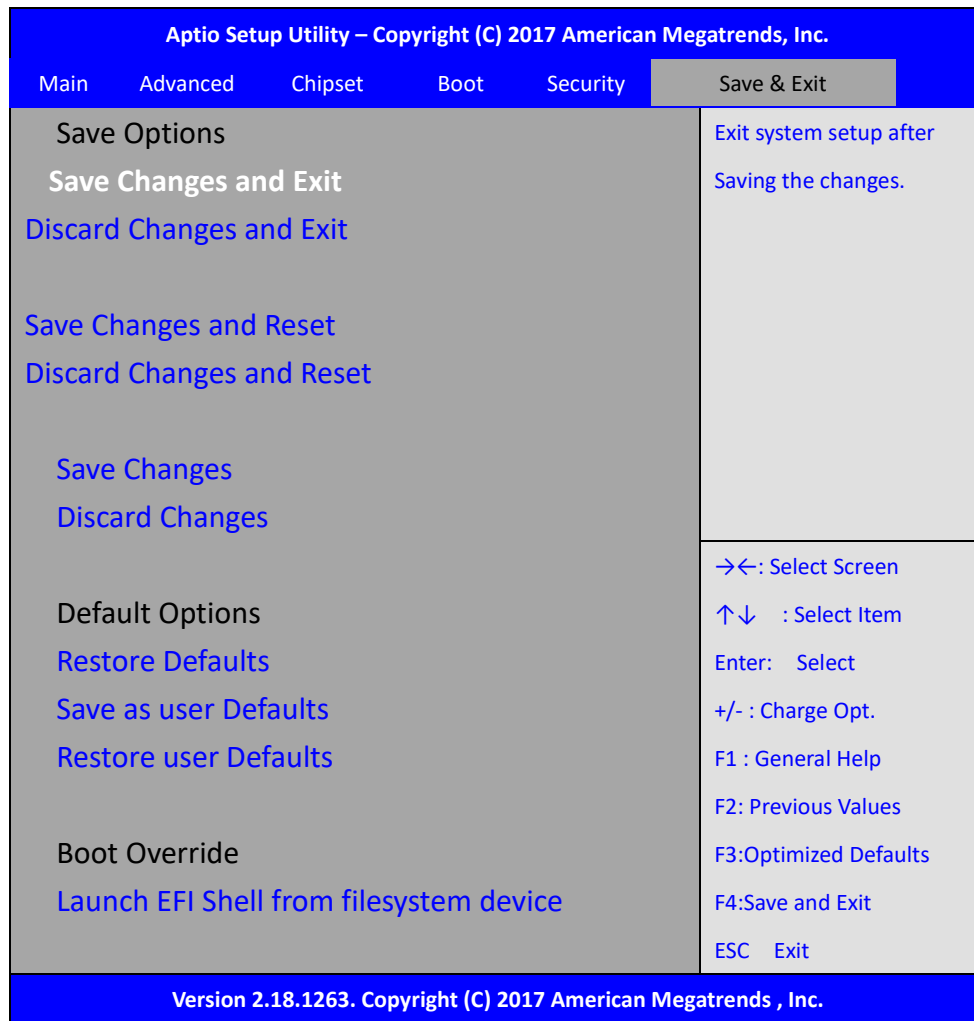

Save Changes and Exit

Save & Exit Setup save Configuration and exit ?

[Yes]

[No]

Discard Changes and Ext

Exit Without Saving Quit without saving?

[Yes]

[No]

Save Changes and Reset

Reset the system after Saving The changes?

[Yes]

[No]

Discard Changes and Reset

Reset system setup without Saving any changes?

[Yes]

[No]

Save Changes

Save Setup done so far to any of the setup options?

[Yes]

[No]

Discard Changes

Discard Changes done so far to any of the setup options?

[Yes]

[No]

Restore Defaults

Restore /Load Defaults values for all the setup options?

[Yes]

[No]

Save as user Defaults

Save the changes done so far as User Defaults?

[Yes]

[No]

Restore user Defaults

Restore the User Defaults to all the setup options?

[Yes]

[No]

Boot Override

Launch EFI Shell from filesystem device

WARNING Not Found

[ok]

Chapter 4 Installation of Drivers

This chapter describes the installation procedures for software and drivers under Windows 10. The software and drivers are included with the motherboard. The contents include **Intel® Apollo Lake SoC Chipset, Intel® VGA chipset, Intel® I210 LAN Driver, Realtek ALC 269Q HD Audio Driver, Intel® TXE, Touch Panel Driver and DPTF Driver** Installation instructions are given below.

Important Note:

After installing your Windows operating system, you must install first the Intel Chipset Software Installation Utility before proceeding with the installation of drivers.



4.1 Intel® Apollo Lake SoC Chipset

To install Intel® Apollo Lake SoC Chipset driver, please follow the steps below.

Step 1. Select **Intel® Apollo Lake SoC Chipset** from the list



Step 2. Here is welcome page. Please make sure you save and exit all programs before install. Click **Next**.

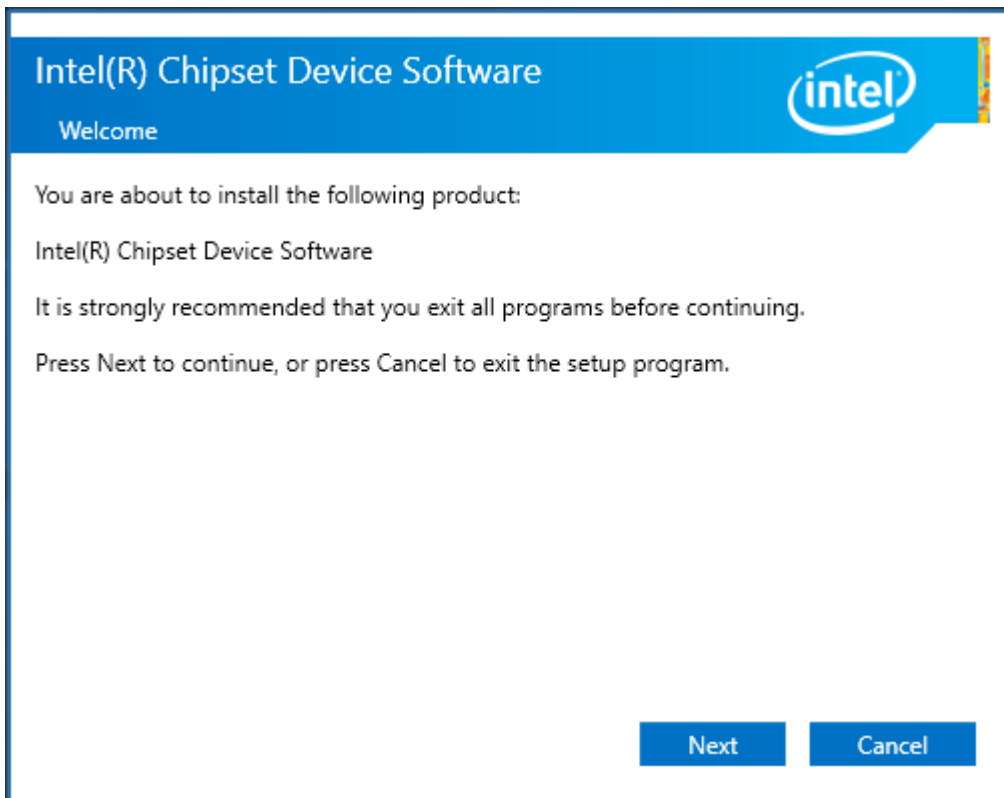

Step 3. Read the license agreement. Click **Accept** to accept all of the terms of the license agreement.

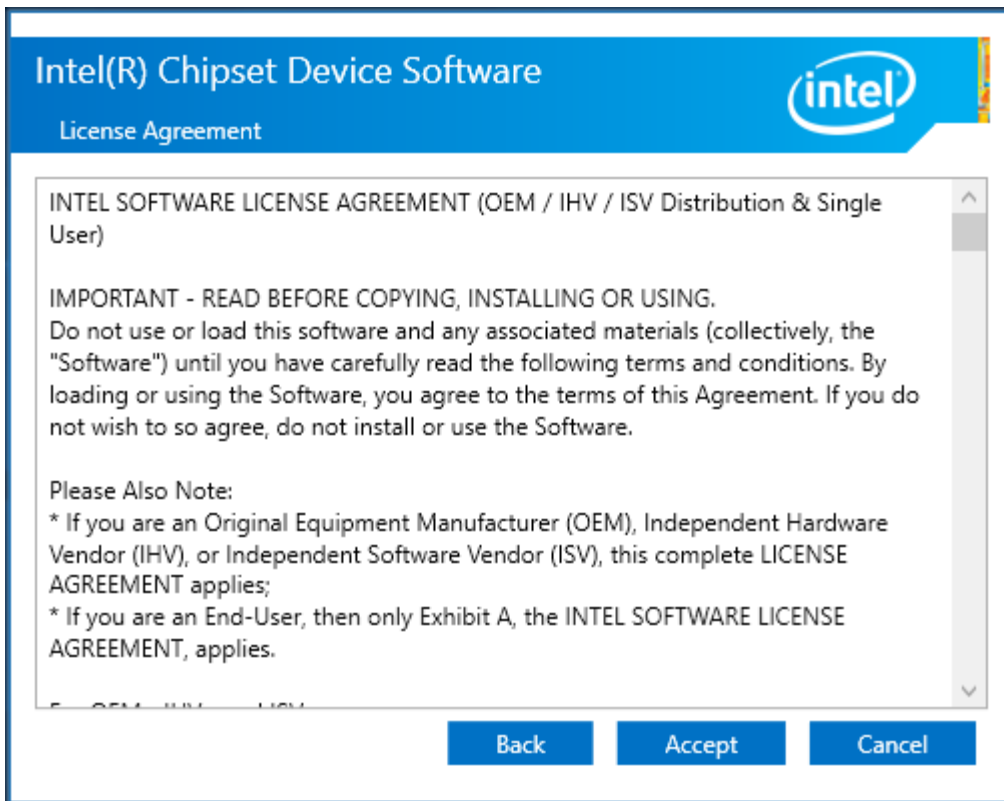

Step 4. Click **Install** to begin the installation.

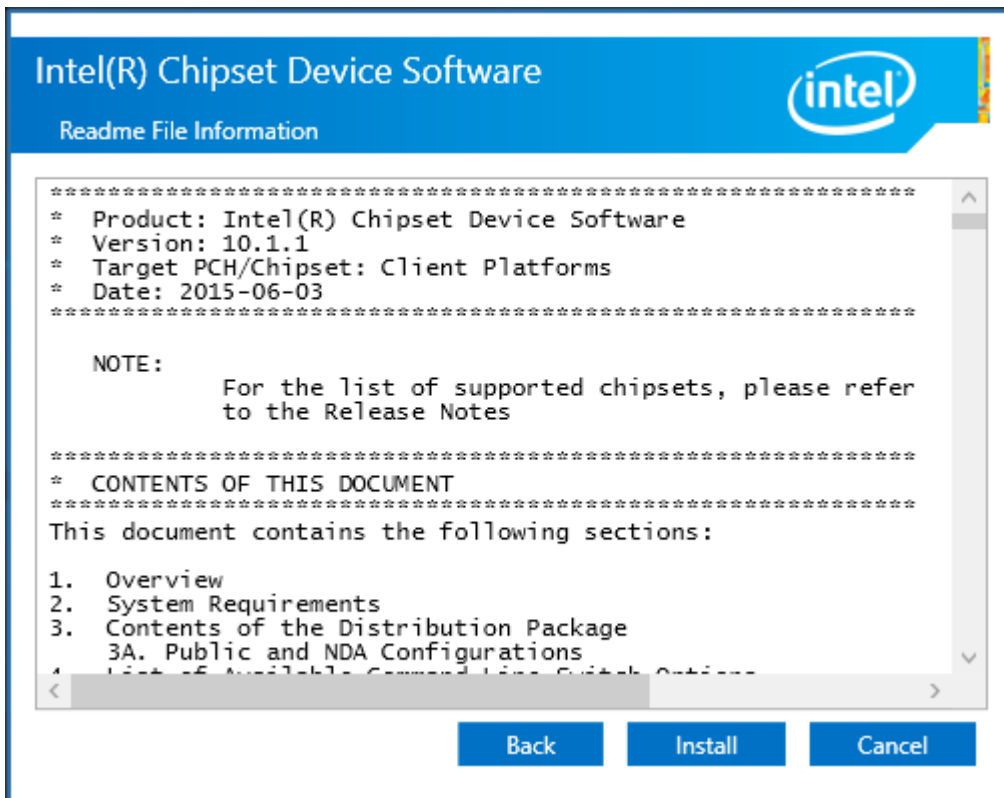

Step 5. Select **Restart Now** to reboot your computer for the changes to take effect.

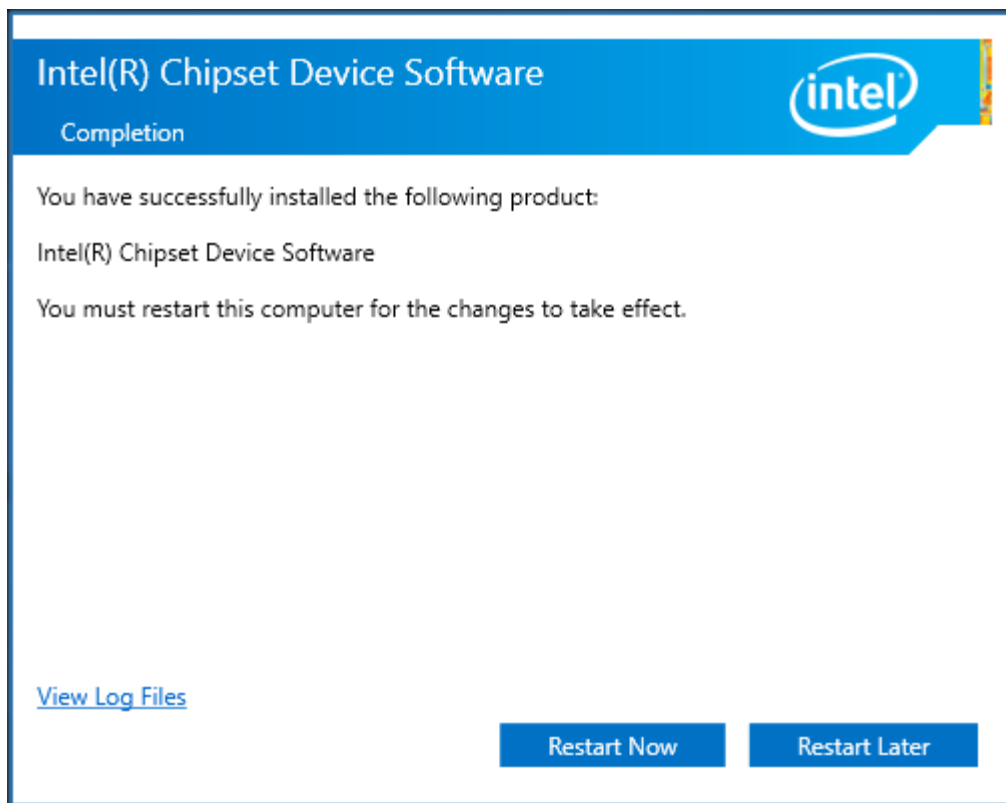

4.2 Intel® VGA Chipset

To install the Intel® VGA Chipset, please follow the steps below.

Step 1. Select **Intel® VGA Chipset** from the list.



Step 2. Choose **automatically run** function and Click **Next** to setup program.

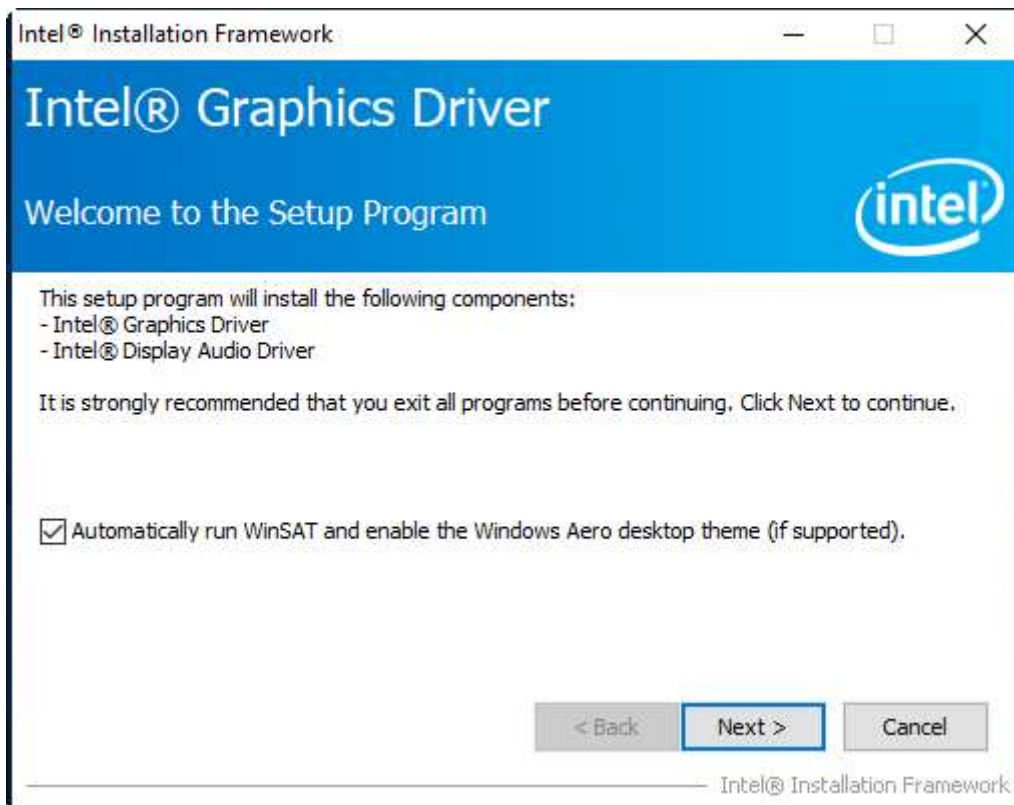

Step 3. Read the license agreement. Click **Yes** to accept all of the terms of the license agreement.

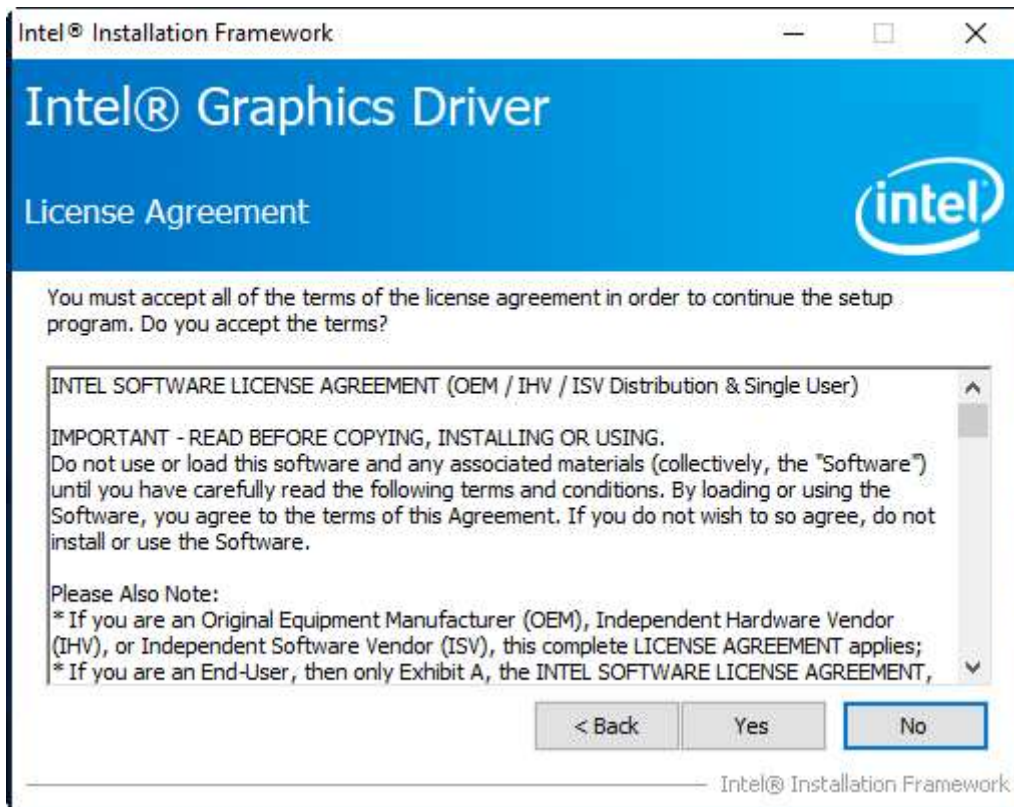

Step 4. Click **Next** to continue.

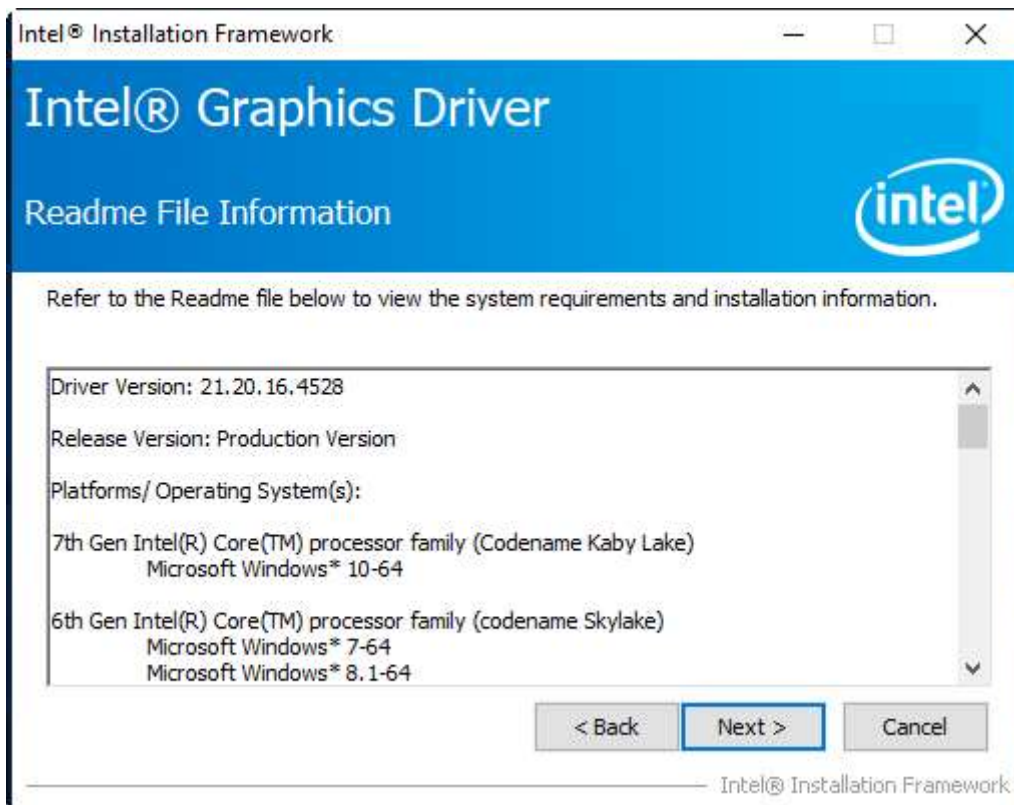

Step 5. Click **Next** to continue.

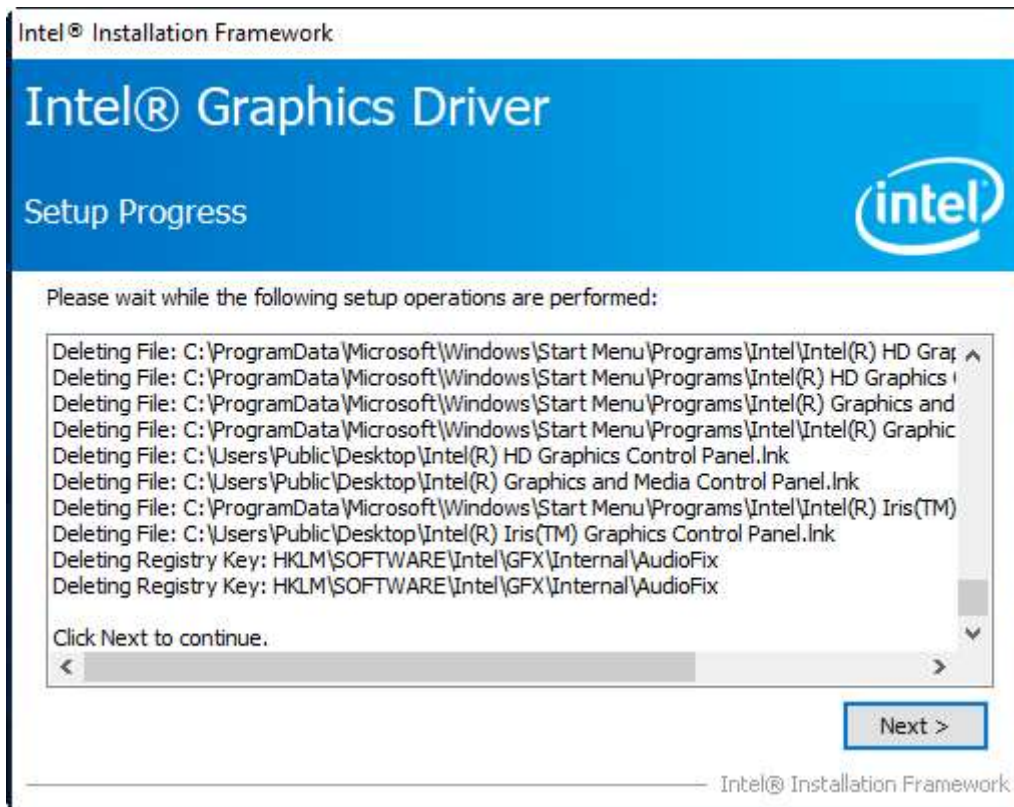

Step 6. Select **Yes, I want to restart this computer now.** Click **Finish** to complete installation.

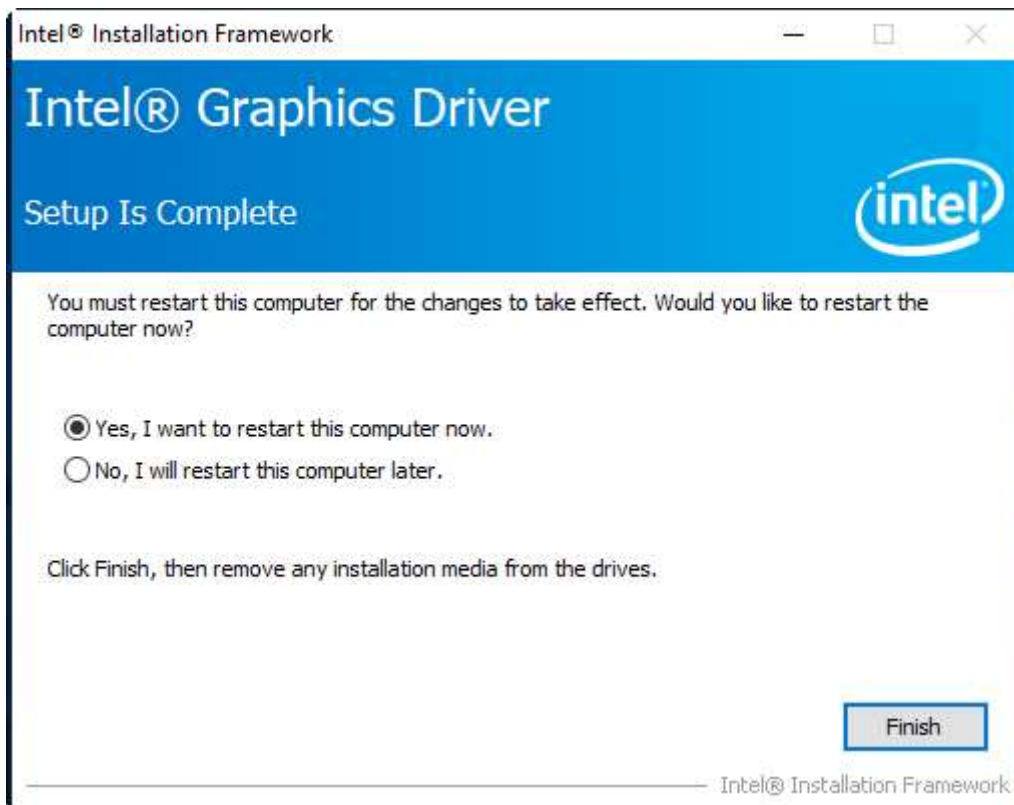

4.3 Intel® I210 LAN Driver

To install Intel® I210 LAN Driver Driver, please follow the steps below.

Step 1. Select Intel® I210 LAN Driver from the list



Step 2. Intel® Network Connections appear. Click Install Drivers and Software.

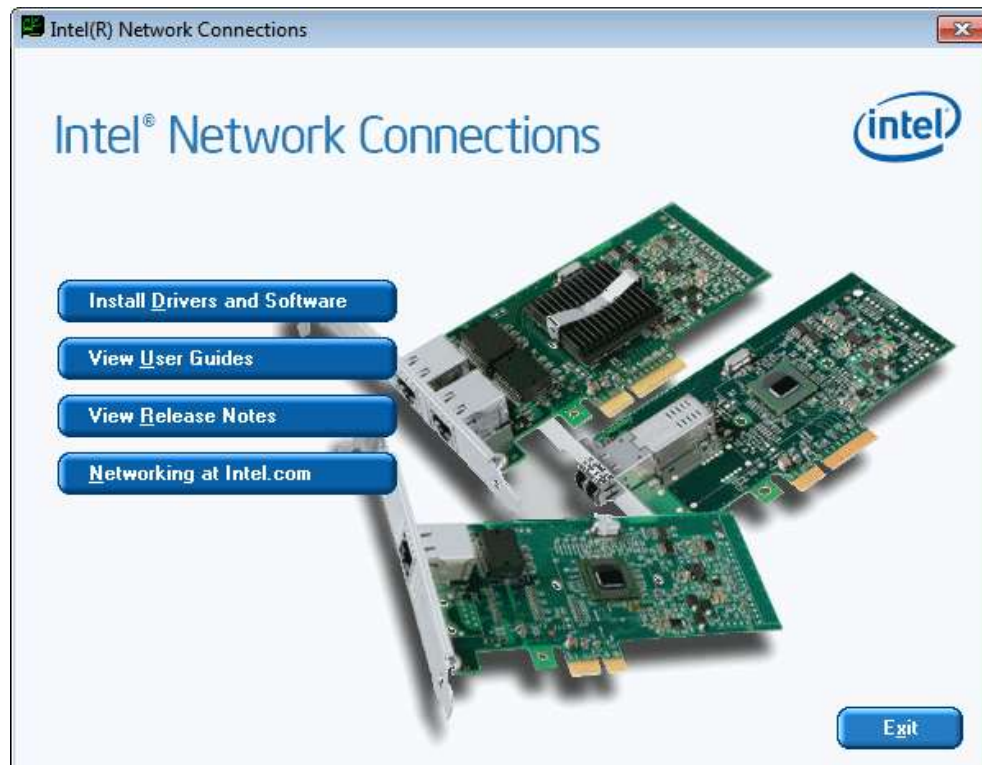

Step 3. Enter into **Install Wizard** welcome page. Click **Next** to continue.

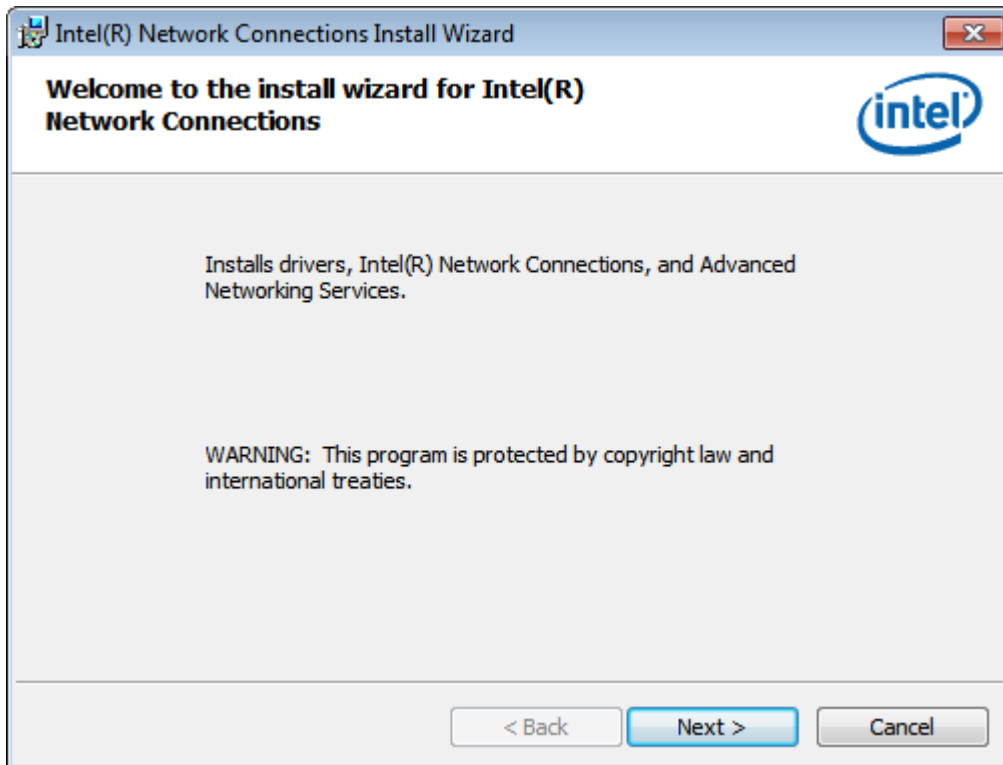

Step 4. Enter into **Intel® Network Connections License Agreement** welcome page. Click **Next** to continue.



Step 5. Enter into **Intel® Network Connections Setup Options** page and choose as example. Click **Next** to continue.

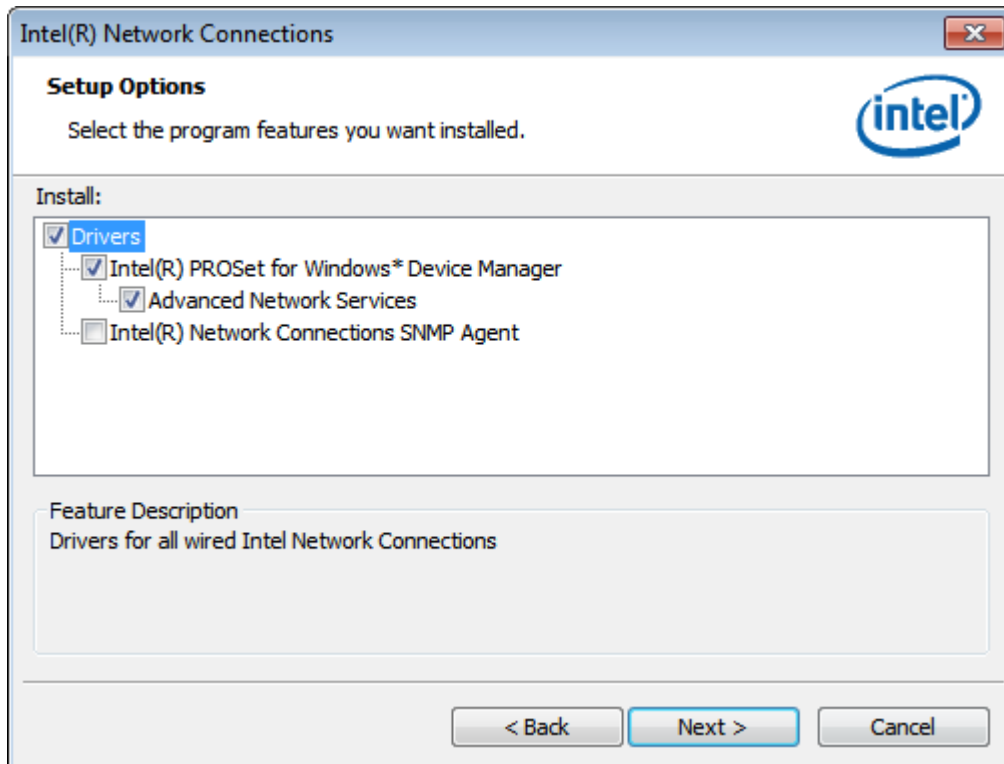

Step 6. Enter into **Intel® Network Connections Install Wizard** page. Click **Install** to start installation.

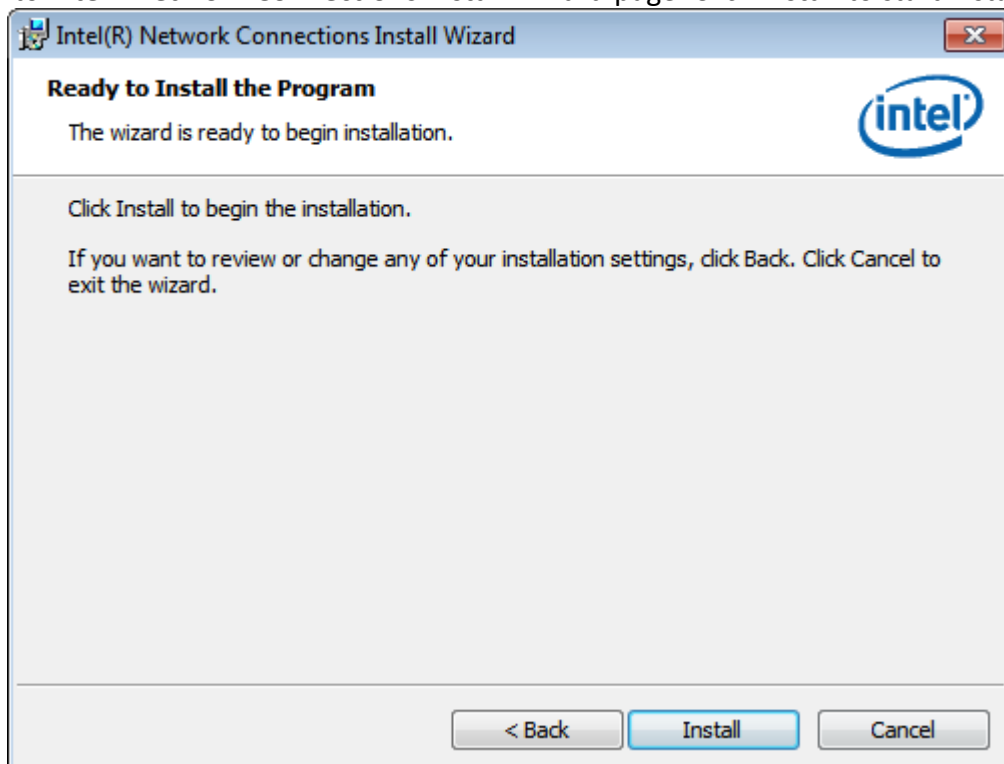

Step 6. Click **Finish** to end your installation.

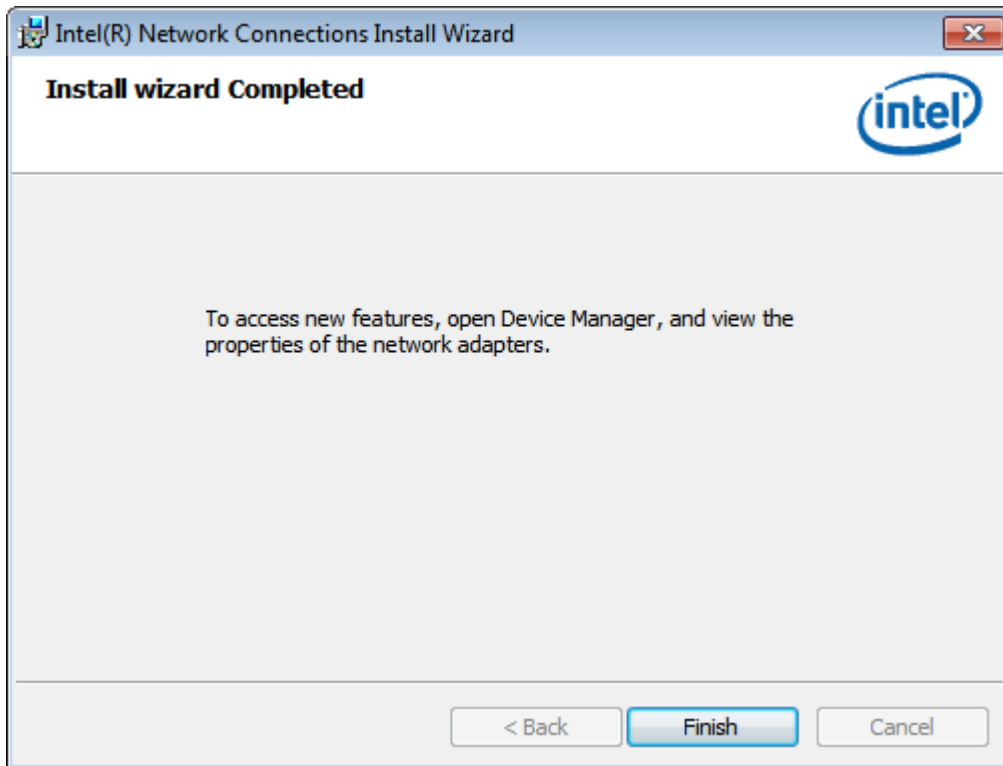

4.4 Realtek ALC269Q HD Audio Driver

To install Realtek ALC269Q HD Audio Driver, please follow the steps below.

Step 1. Select **Realtek ALC269Q HD Audio Driver** from the list



Step 2. Enter into **Install Wizard** page and wait for extracting files.

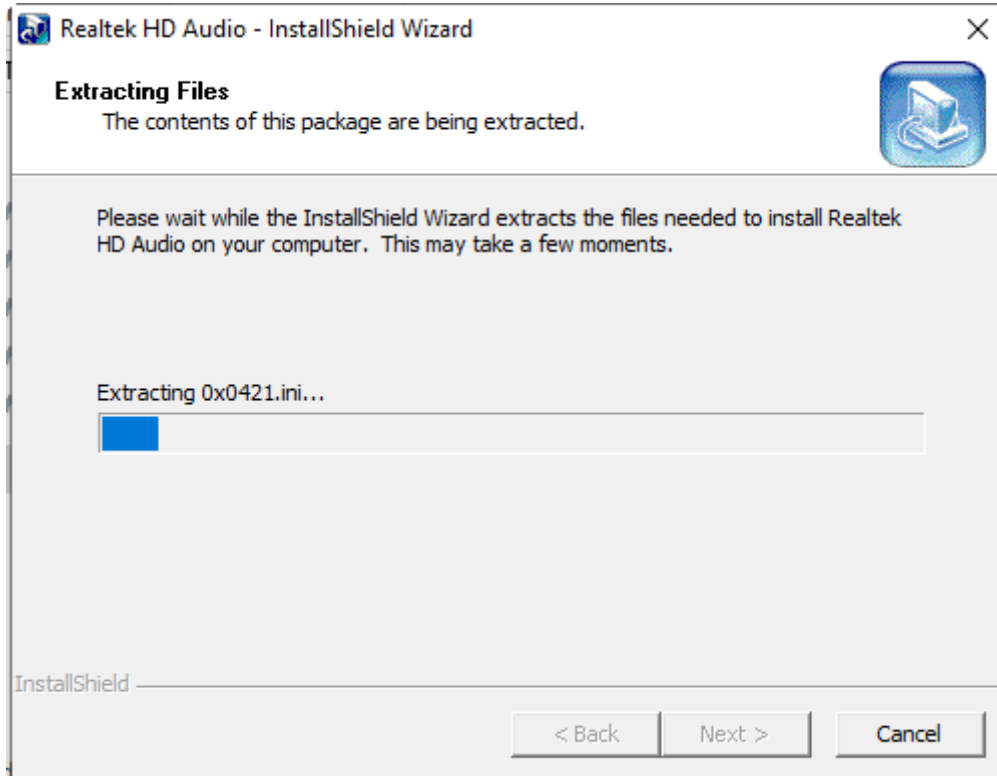

Step 3. Enter into Audio Driver Setup page. Click **Yes** to continue the installation.

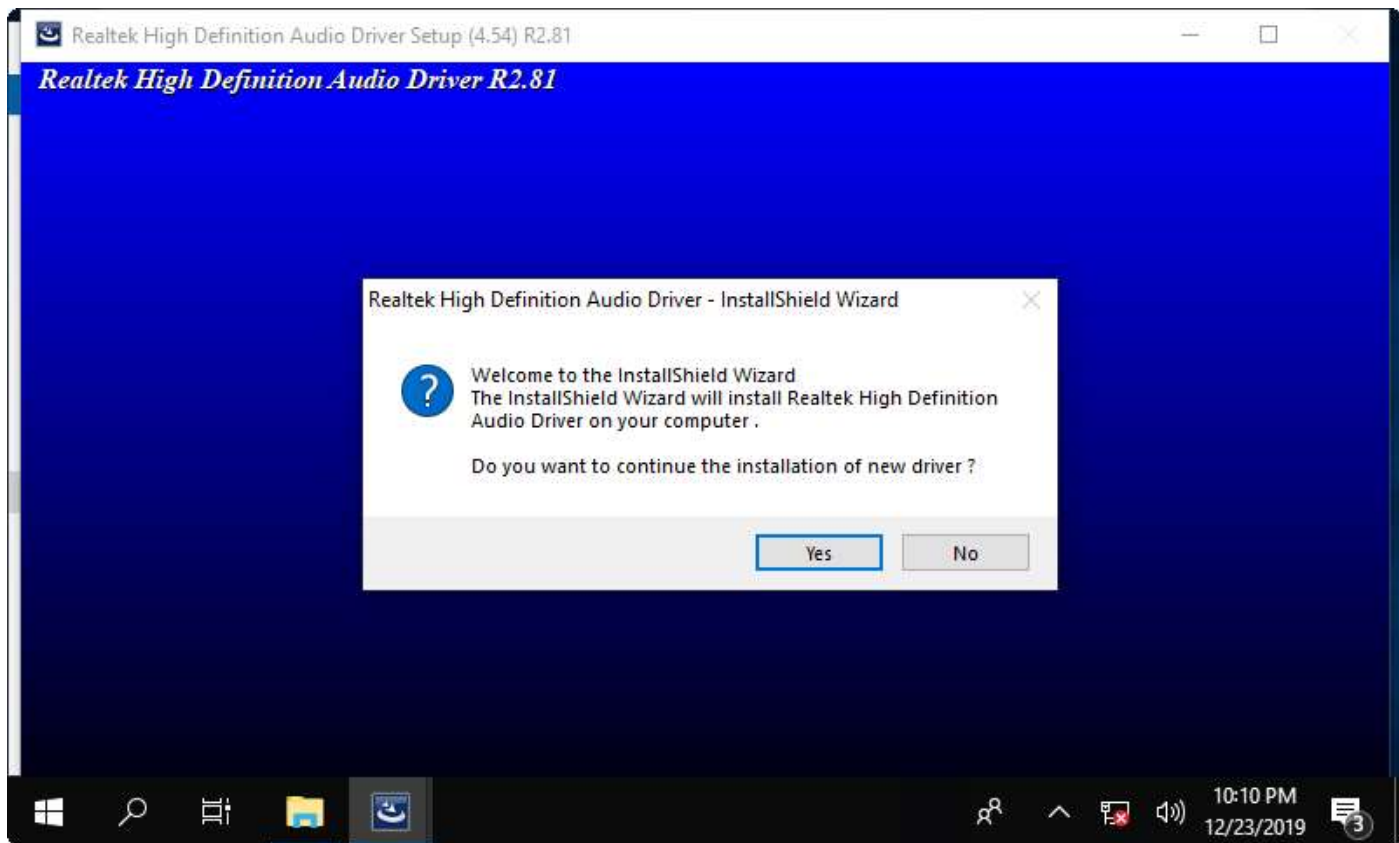

4.5 Intel® TXE

To install Intel® TXE, please follow the steps below.

Step 1. Select Intel® TXE from the list



Step 2. Enter into Intel® Trusted Execution Engine welcome page. Click **Next** to continue.

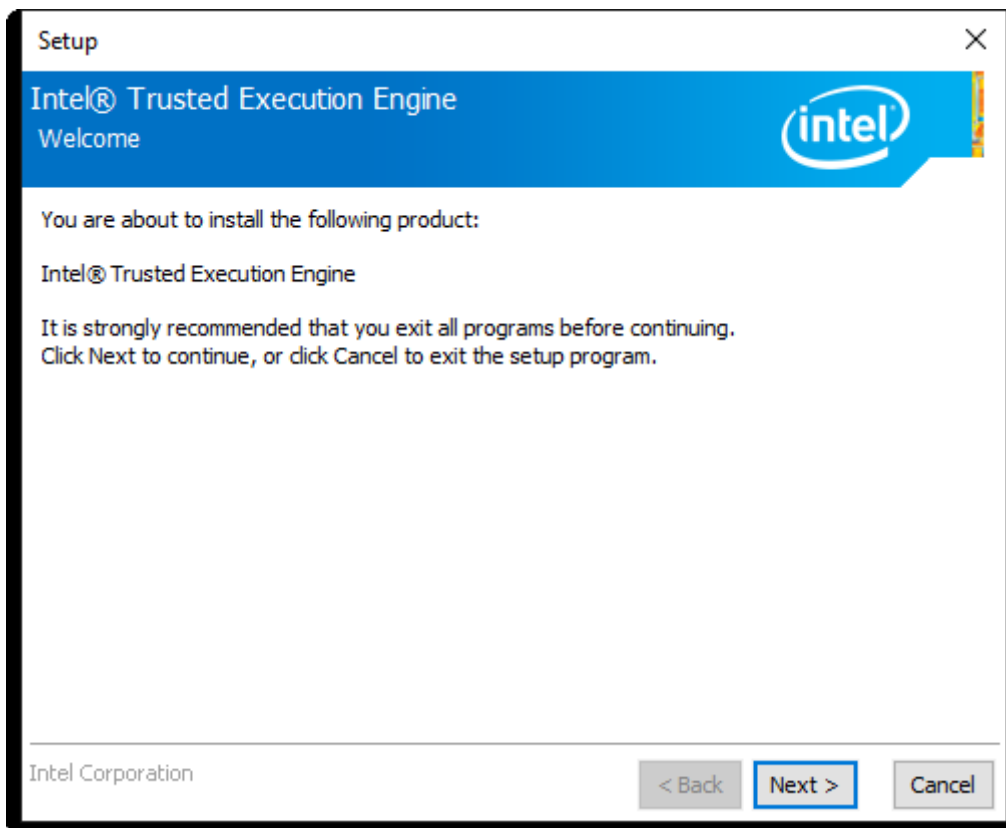

Step 3. Enter into **Intel® Trusted Execution Engine License Agreement** page. Click **Next** to continue.

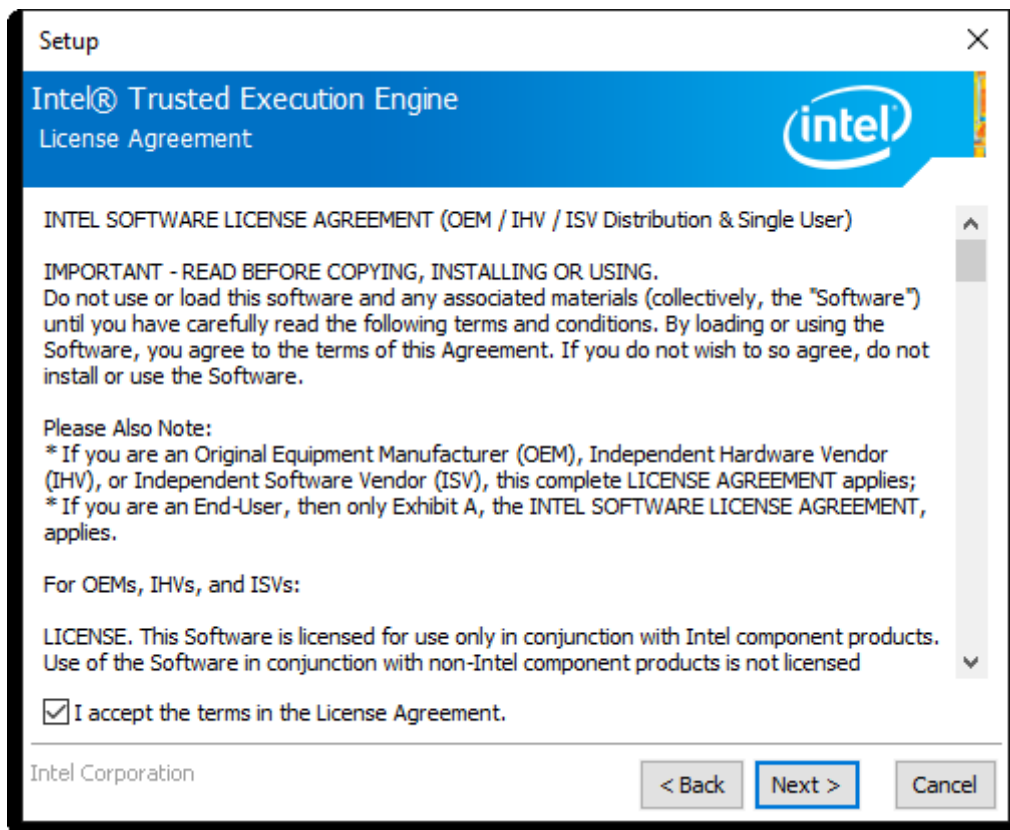

Step 4. Click **Next** to continue.

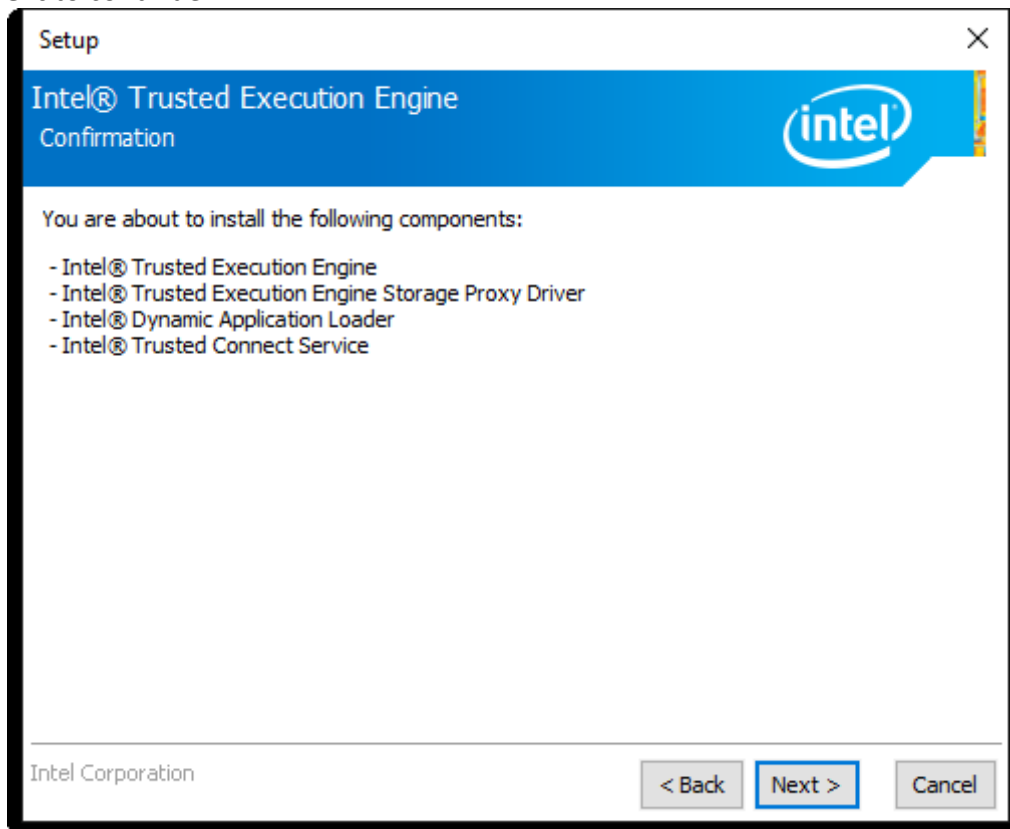

Step 5. Choose **Yes, I want to restart this computer now** to finish the installation.

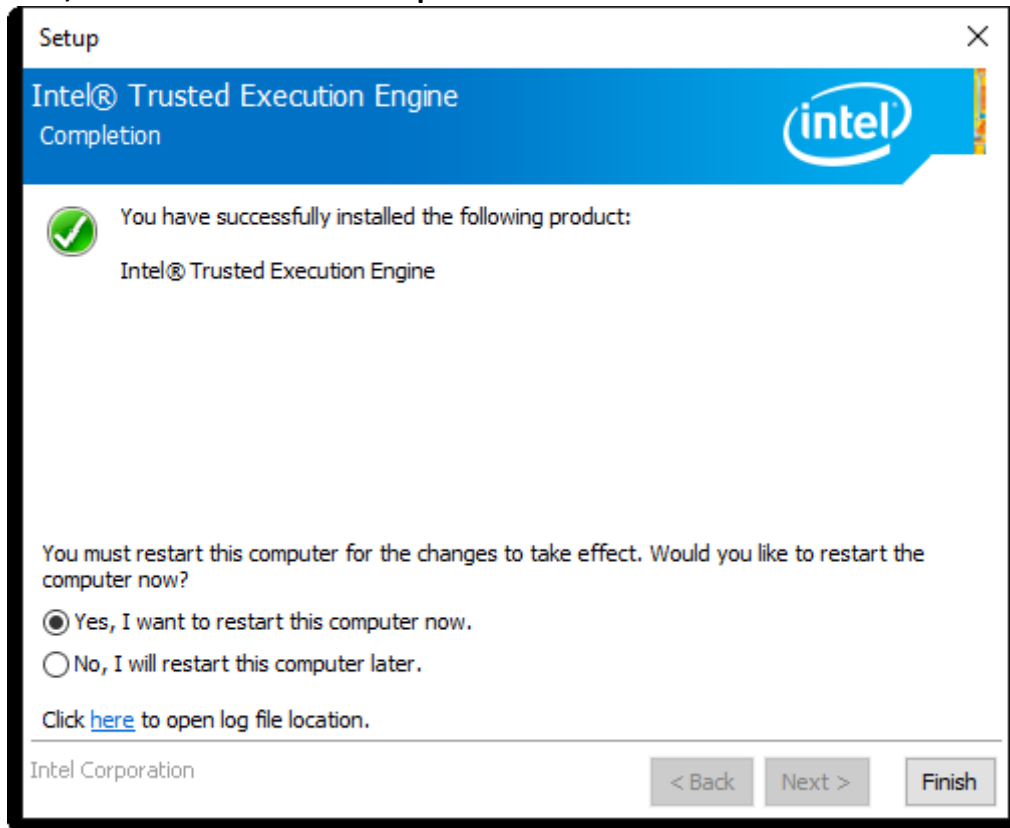

4.6 Touch Panel Driver

To install Touch Panel Driver, please follow the steps below.

Step 1. Select **Touch Panel Driver** from the list



Step 2. Enter into **Penmount USB Windows Driver Setup Wizard** page. Click **Next** to continue.

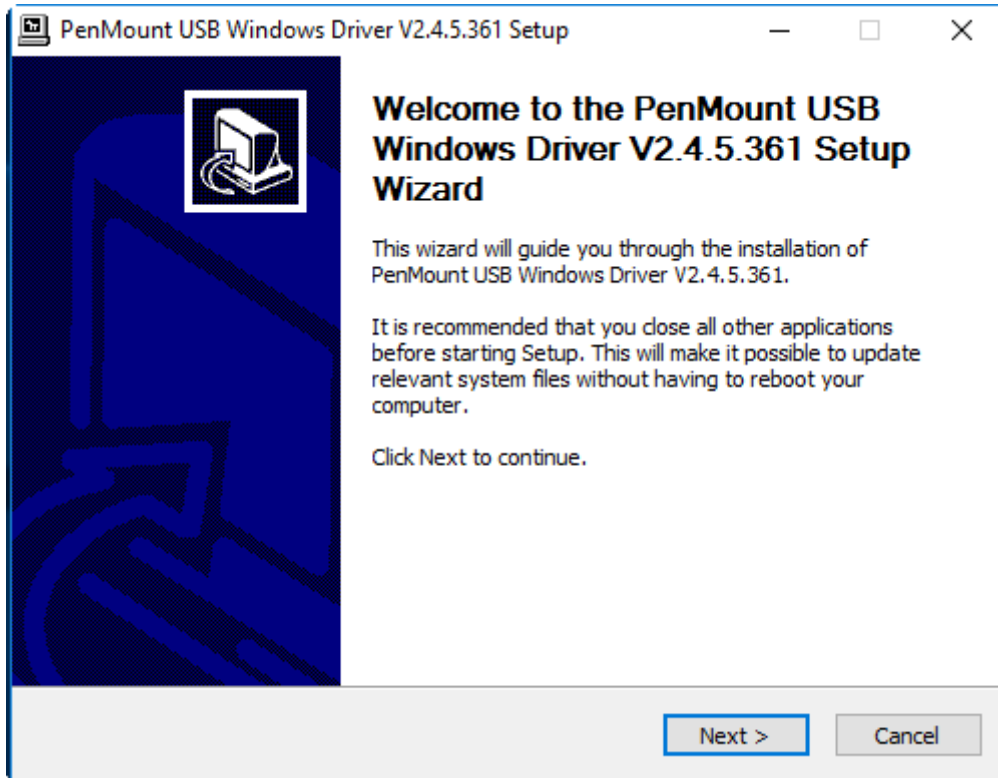

Step 3. Read the **License Agreement**. Click **I Agree** to continue.

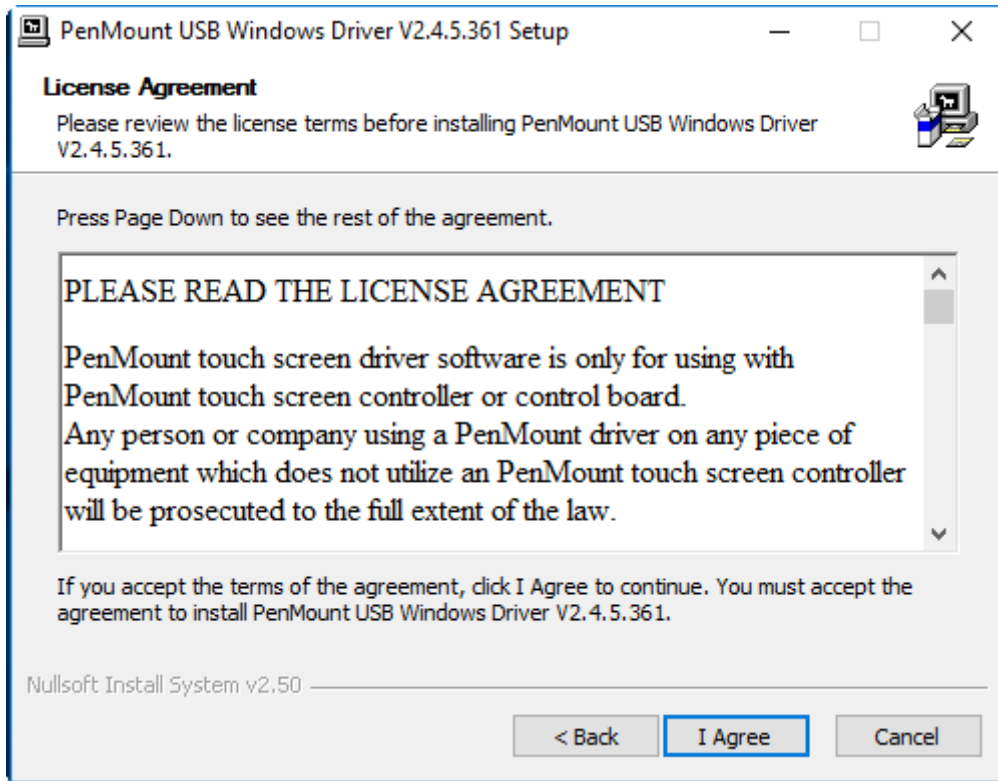

Step 4. Choose the installation data location you preferred. Click **Install** to continue.

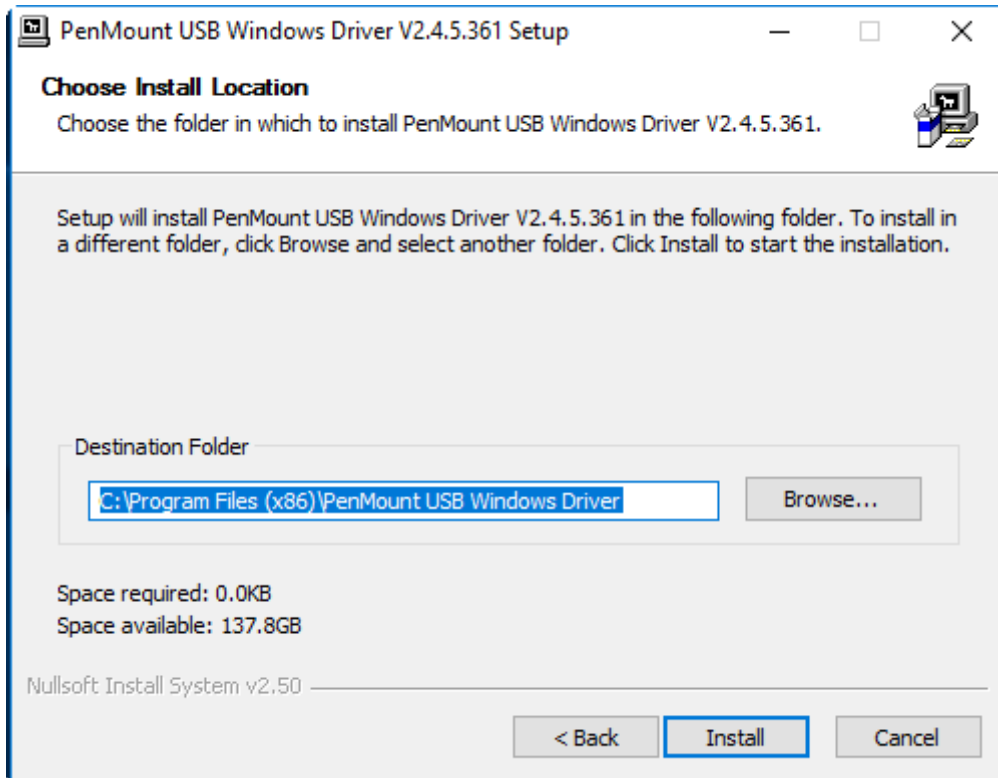

Step 5. Enter into Penmount USB Windows Driver Setup page. Click **Yes** to continue.

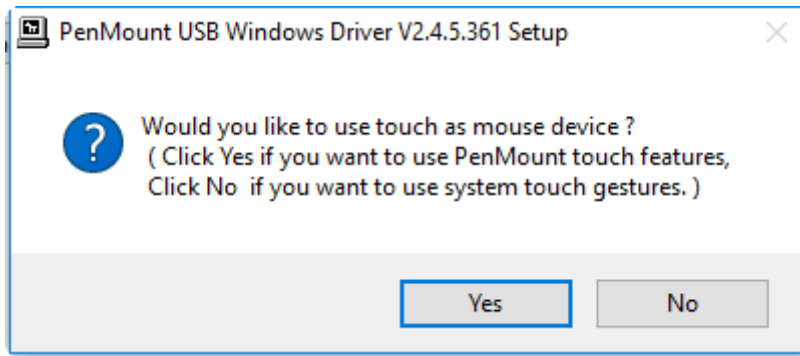

Step 6. Enter into Penmount USB Windows Driver Setup page. Click **Finish** to finish installation.

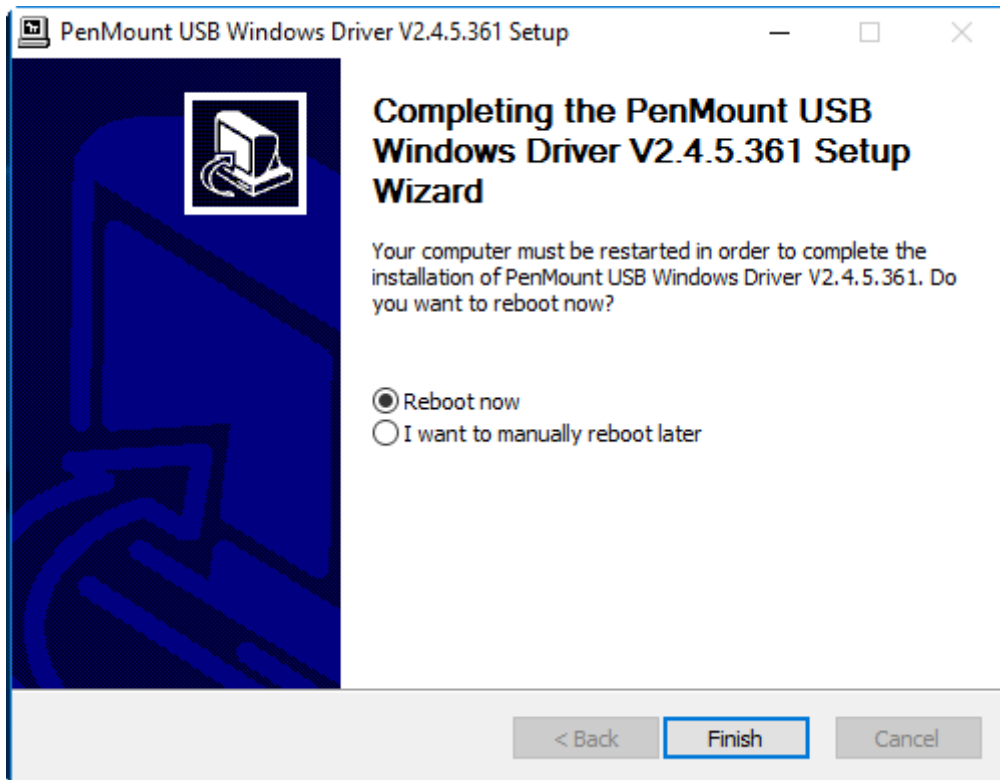

4.7 DPTF Driver

To install DPTF Driver, please follow the steps below.

Step 1. Select **DPTF Driver** from the list



Step 2. Click **Next** to continue.

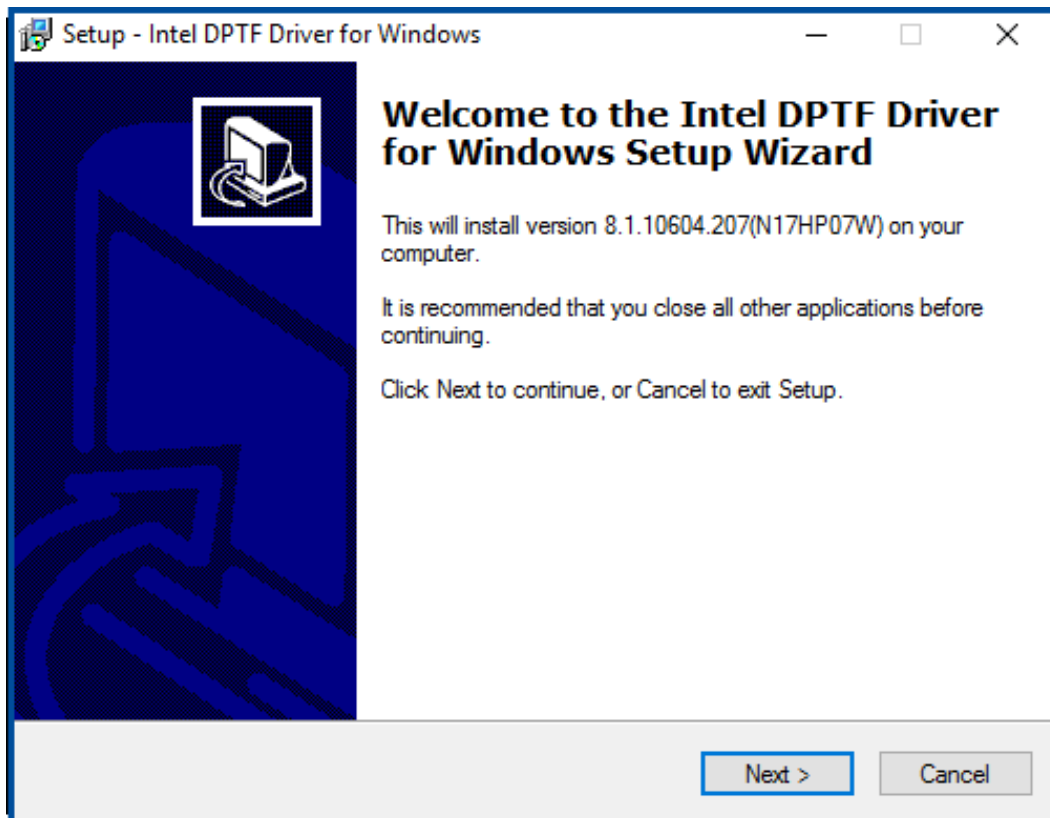

Step 3. Read the license agreement. Choose **Accept** and click **Next** to accept all of the terms of the license agreement.

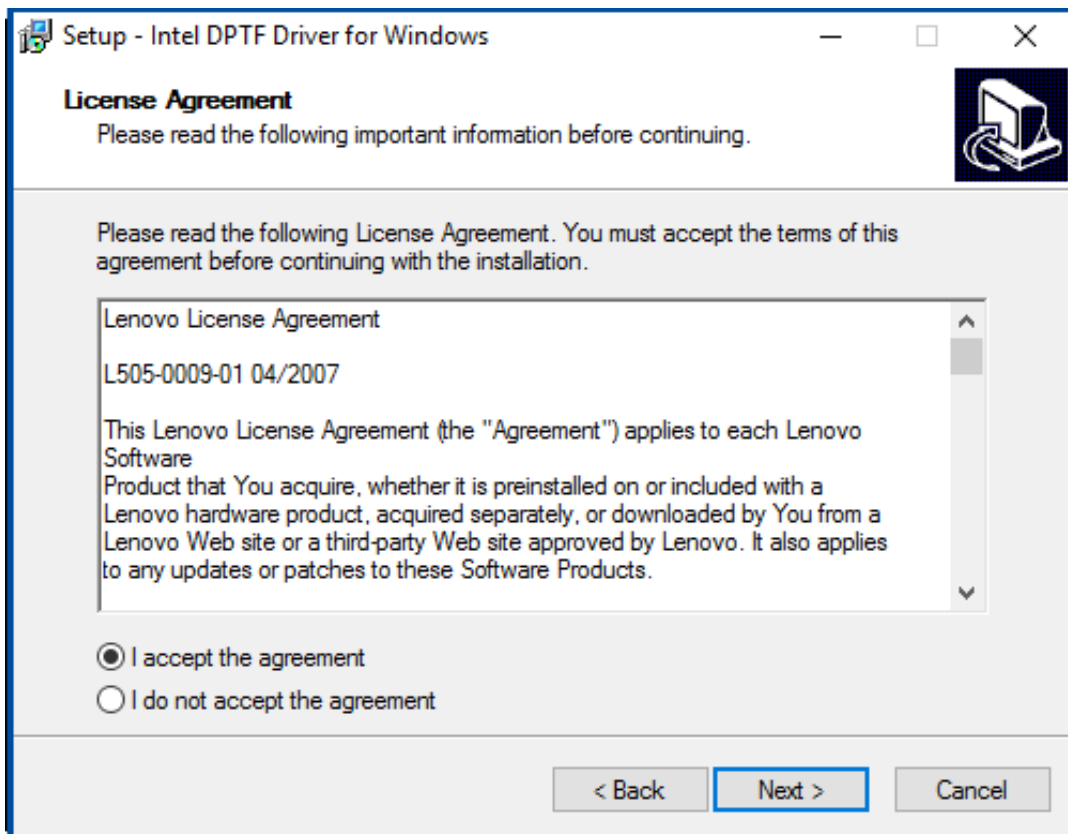

Step 4. Select destination location by your option and click **Next** to continue.

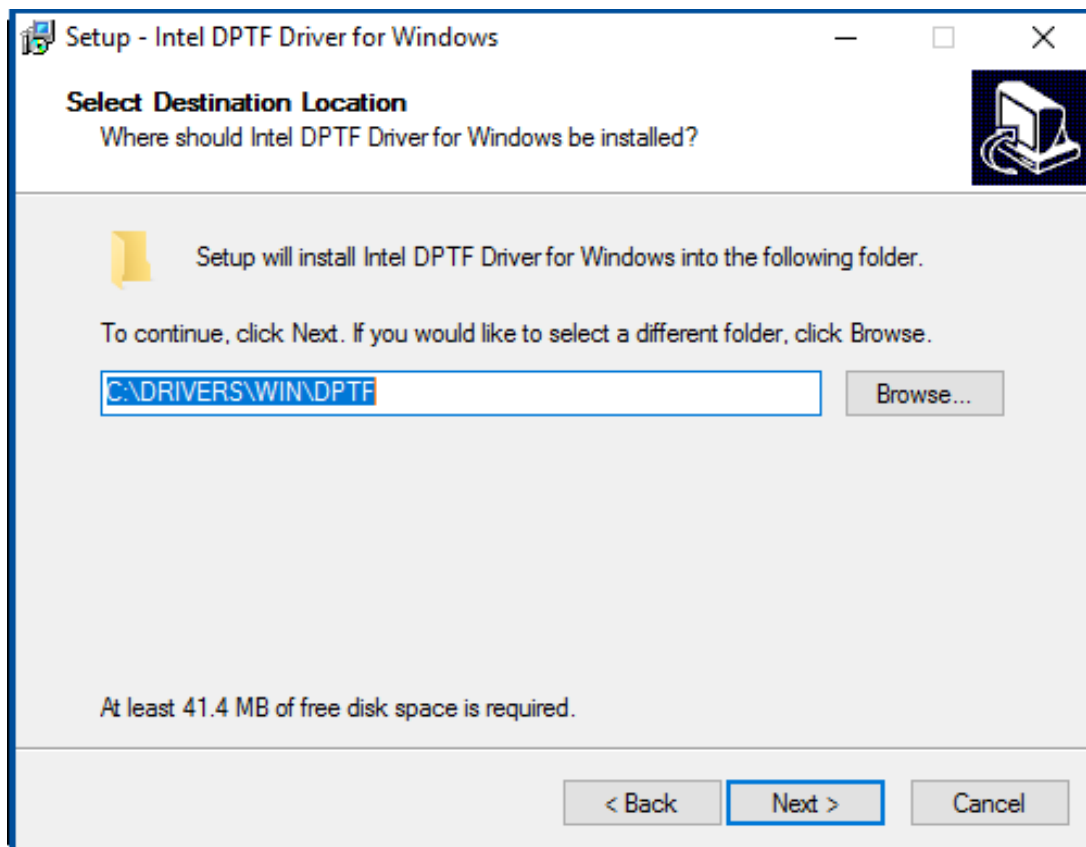

Step 5. Click **Install** to continue the installing.

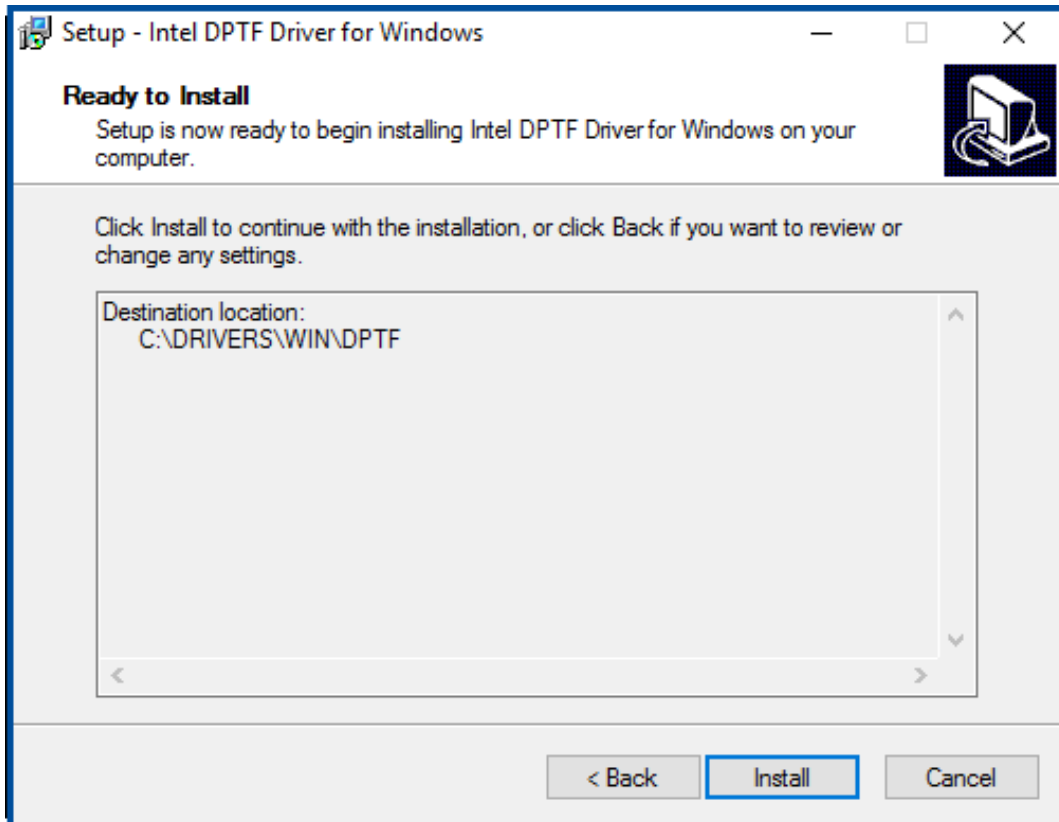

Step 6. Click **Finish** to complete the installation and start install Intel DPTF driver for Windows.

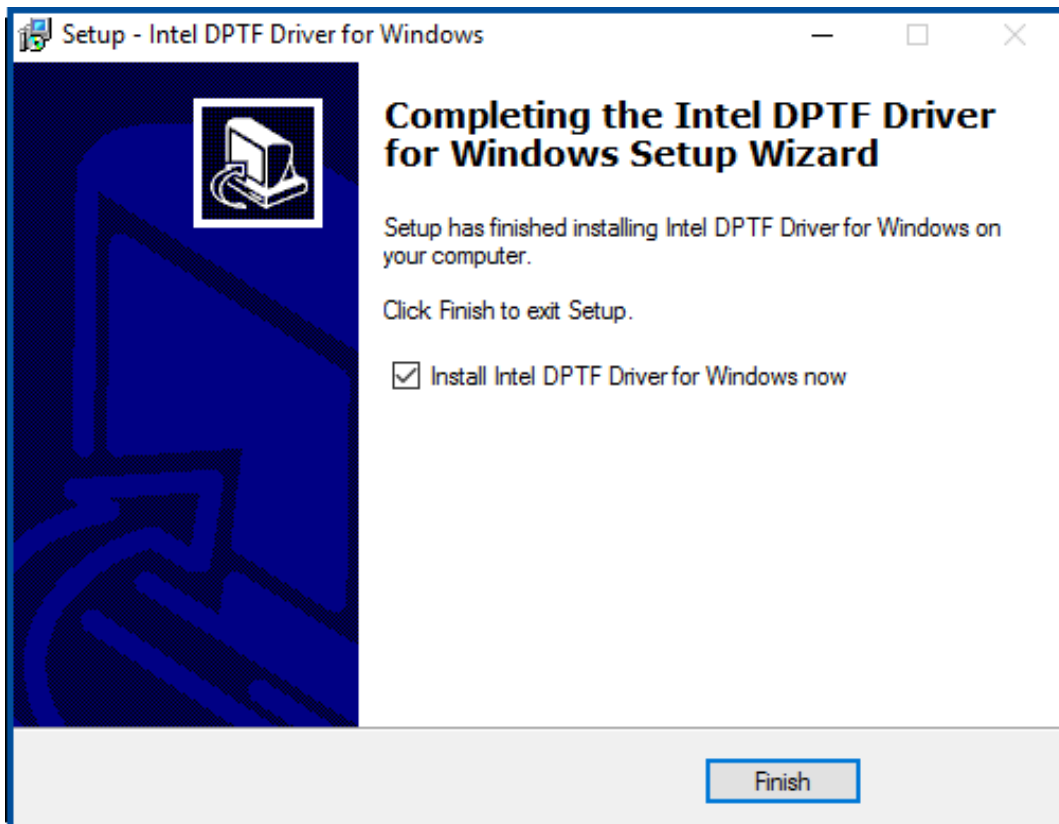

Step 7. Click **Next** to start the installation.

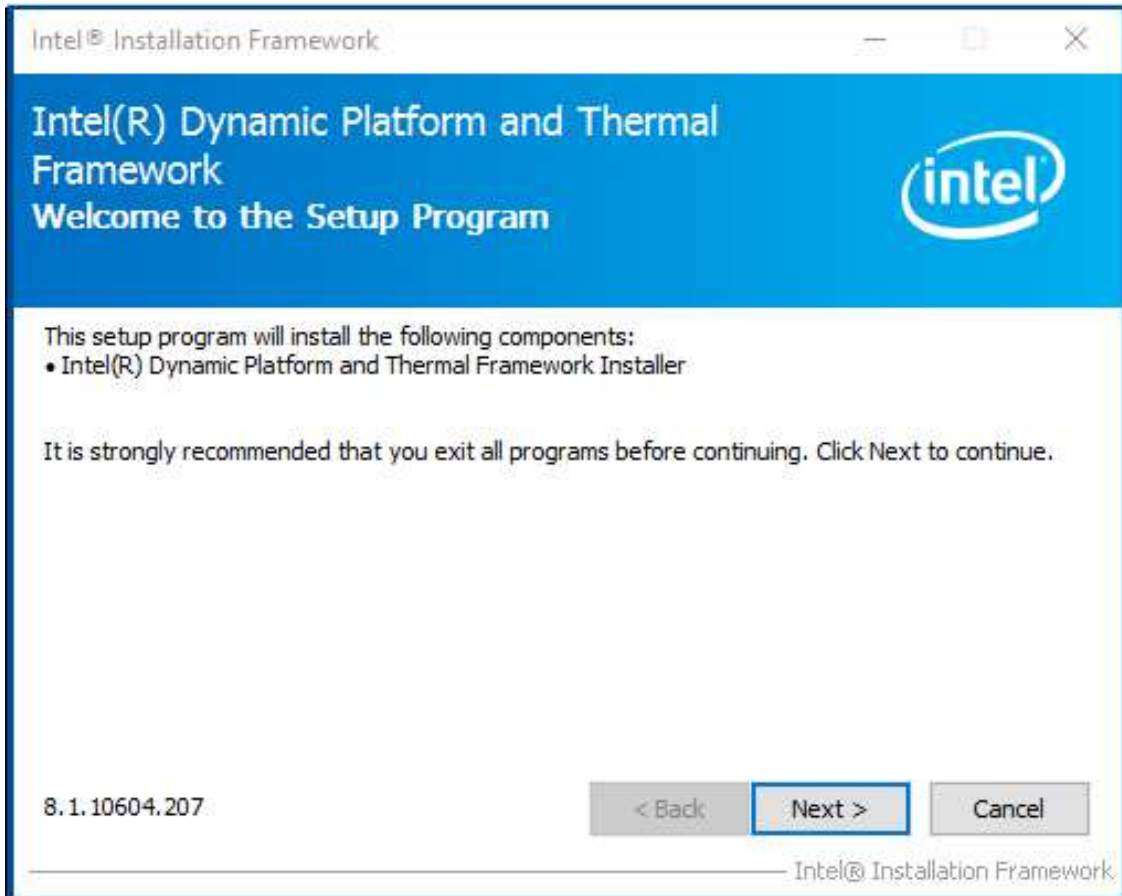

Step 8. Read the license agreement. Click **Yes** to accept all of the terms of the license agreement.

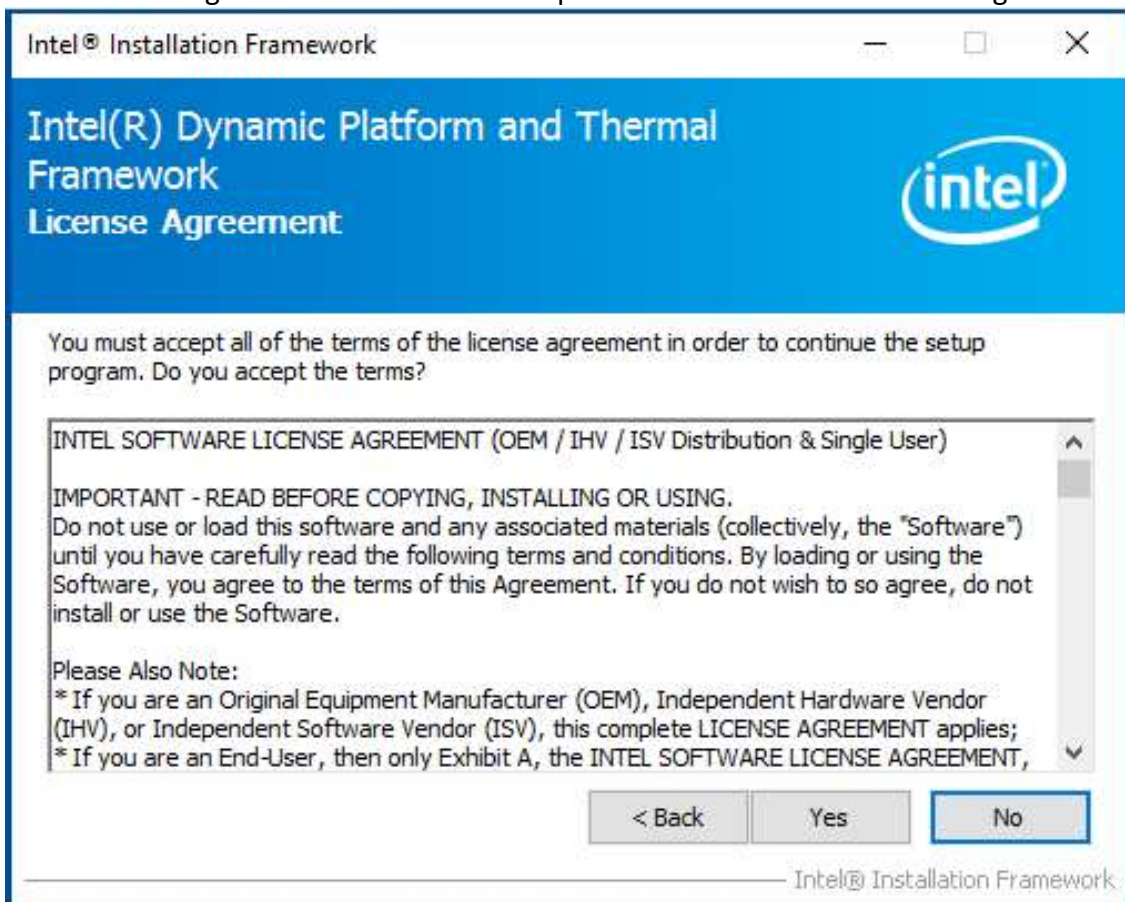

Step 9. Click **Next** to continue.

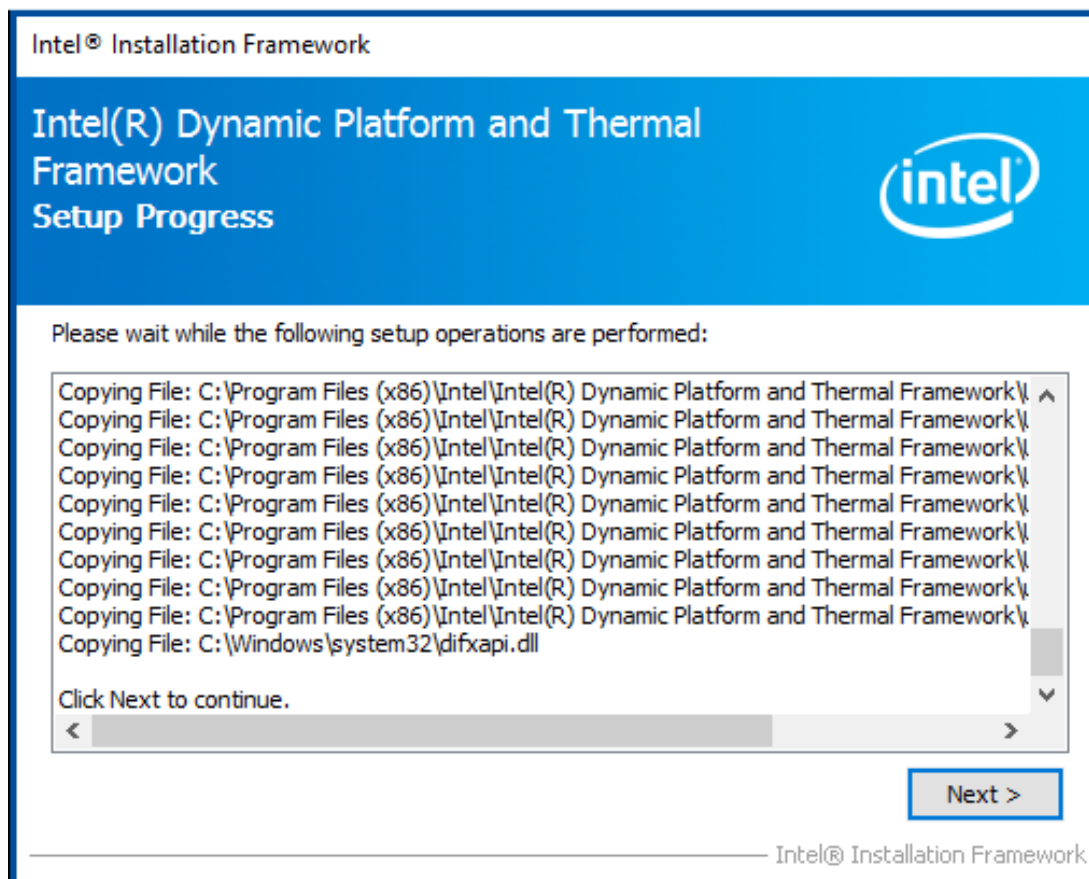

Step 10. Click **Finish** to complete the installation.

