



CMS171/CMS173

10th Gen Intel® Core™
User's Manual

Copyright

This publication contains information that is protected by copyright. No part of it may be reproduced in any form or by any means or used to make any transformation/adaptation without the prior written permission from the copyright holders.

This publication is provided for informational purposes only. The manufacturer makes no representations or warranties with respect to the contents or use of this manual and specifically disclaims any express or implied warranties of merchantability or fitness for any particular purpose. The user will assume the entire risk of the use or the results of the use of this document. Further, the manufacturer reserves the right to revise this publication and make changes to its contents at any time, without obligation to notify any person or entity of such revisions or changes.

Changes after the publication's first release will be based on the product's revision. The website will always provide the most updated information.

© 2023. All Rights Reserved.

Trademarks

Product names or trademarks appearing in this manual are for identification purpose only and are the properties of the respective owners.

FCC and DOC Statement on Class B

This equipment has been tested and found to comply with the limits for a Class B digital device, pursuant to Part 15 of the FCC rules. These limits are designed to provide reasonable protection against harmful interference when the equipment is operated in a residential installation. This equipment generates, uses and can radiate radio frequency energy and, if not installed and used in accordance with the instruction manual, may cause harmful interference to radio communications. However, there is no guarantee that interference will not occur in a particular installation. If this equipment does cause harmful interference to radio or television reception, which can be determined by turning the equipment off and on, the user is encouraged to try to correct the interference by one or more of the following measures:

- Reorient or relocate the receiving antenna.
- Increase the separation between the equipment and the receiver.
- Connect the equipment into an outlet on a circuit different from that to which the receiver is connected.
- Consult the dealer or an experienced radio TV technician for help.

Notice:

1. The changes or modifications not expressly approved by the party responsible for compliance could void the user's authority to operate the equipment.
2. Shielded interface cables must be used in order to comply with the emission limits.

Table of Contents

Chapter 1 - Introduction.....	6
Specifications	6
Block Diagram	8
Dimension	8
Chapter 2 - Hardware Installation.....	9
Board Layout.....	9
Installing the heat sink.....	10
Installing the Heat Sink	10
Jumper Settings	11
Clear CMOS (JP1)	11
Power Selection COM 1 (JP2).....	11
Pin Assignment	12
System Fan (J9)	12
SATA Power (CN1)	12
CPU Fan (J10).....	13
DIO Power (J12)	13
SATA0 (J1)	14
SATA1 (J2)	14
COM1 (J17).....	15
Front Audio (AUJ2).....	15
Front Panel (J11).....	16
DIO (J13)	16
LPC (J14)	17
System Memory	18
Installing the SO-DIMM Module	18
Expansion Slots.....	19
Installing the M.2 Module	19
Chapter 3 - BIOS Settings.....	21
Overview	21
Updating the BIOS	22
Notice: BIOS SPI ROM.....	22
Main.....	23
Advanced	23
RC ACPI Settings.....	24
CPU Configuration	24
Power & Performance.....	25
PCH-FW Configuration	25
Trusted Computing.....	26
NCT6126D Super IO Configuration	26
NCT5525D Super IO Configuration ▶ Serial Port 1 Configuration	27
NCT6126D HW Monitor	27
NCT6126D HW Monitor ▶ Smart FAN Function	28
Serial Port Console Redirection	28
Serial Port Console Redirection ▶ Console Redirection Settings.....	29
USB Configuration	29
Network Stack Configuration.....	30
CSM Configuration	30
USB Power Control.....	31
Chipset	32
Graphics Configuration	32
PEG Port Configuration	33
PEG Port Configuration ▶ PEG Port Feature Configuration.....	33

PCH-IO Configuration	34
Security	35
Secure Boot.....	35
Boot	36
Save & Exit	36
Updating the BIOS	37
Notice: BIOS SPI ROM.....	37

About this Manual

This manual can be downloaded from the website.

The manual is subject to change and update without notice, and may be based on editions that do not resemble your actual products. Please visit our website or contact our sales representatives for the latest editions.

Warranty

1. Warranty does not cover damages or failures that occur from misuse of the product, inability to use the product, unauthorized replacement or alteration of components and product specifications.
2. The warranty is void if the product has been subjected to physical abuse, improper installation, modification, accidents or unauthorized repair of the product.
3. Unless otherwise instructed in this user's manual, the user may not, under any circumstances, attempt to perform service, adjustments or repairs on the product, whether in or out of warranty. It must be returned to the purchase point, factory or authorized service agency for all such work.
4. We will not be liable for any indirect, special, incidental or consequential damages to the product that has been modified or altered.

Static Electricity Precautions

It is quite easy to inadvertently damage your PC, system board, components or devices even before installing them in your system unit. Static electrical discharge can damage computer components without causing any signs of physical damage. You must take extra care in handling them to ensure against electrostatic build-up.

1. To prevent electrostatic build-up, leave the system board in its anti-static bag until you are ready to install it.
2. Wear an antistatic wrist strap.
3. Do all preparation work on a static-free surface.
4. Hold the device only by its edges. Be careful not to touch any of the components, contacts or connections.
5. Avoid touching the pins or contacts on all modules and connectors. Hold modules or connectors by their ends.



Important:

Electrostatic discharge (ESD) can damage your processor, disk drive and other components. Perform the upgrade instruction procedures described at an ESD workstation only. If such a station is not available, you can provide some ESD protection by wearing an antistatic wrist strap and attaching it to a metal part of the system chassis. If a wrist strap is unavailable, establish and maintain contact with the system chassis throughout any procedures requiring ESD protection.

Safety Measures

- To avoid damage to the system, use the correct AC input voltage range.
- To reduce the risk of electric shock, unplug the power cord before removing the system chassis cover for installation or servicing. After installation or servicing, cover the system chassis before plugging the power cord.

About the Package

The package contains the following items. If any of these items are missing or damaged, please contact your dealer or sales representative for assistance.

- 1 CMS171/CMS173 motherboard
- 1 Serial ATA data cable w/lock (Length: 500mm)
- 1 Serial ATA power Y cable (Length: 300mm, 1 x SATA POWER 15P*2 TO 4P HSG)
- 1 COM port cable (Length: 250mm, 1 x COM port)

The board and accessories in the package may not come similar to the information listed above. This may differ in accordance with the sales region or models in which it was sold. For more information about the standard package in your region, please contact your dealer or sales representative.

Before Using the System Board

When installing the system board in a new system, you will need at least the following internal components.

- Memory module
- Storage device such as a hard disk drive.
- Power supply

External system peripherals may also be required for navigation and display, including at least a keyboard, a mouse and a video display monitor.

Chapter 1 - Introduction

► Specifications

SYSTEM	Processor	10th Gen Intel® LGA 1200 Socket Processors, TDP support up to 125W Intel® Xeon® W-1290E (10 Cores, 20M Cache, up to 4.8 GHz; 95W (ECC support on W480E SKU only) Intel® Xeon® W-1290TE (10 Cores, 20M Cache, up to 4.5 GHz); 35W (ECC support on W480E SKU only) Intel® Xeon® W-1270E (8 Cores, 16M Cache, up to 4.8 GHz); 80W (ECC support on W480E SKU only) Intel® Xeon® W-1270TE (8 Cores, 16M Cache, up to 4.4 GHz); 35W (ECC support on W480E SKU only) Intel® Xeon® W-1250E (6 Cores, 12M Cache, up to 4.7 GHz); 80W (ECC support on W480E SKU only) Intel® Xeon® W-1250TE (6 Cores, 12M Cache, up to 3.8 GHz); 35W (ECC support on W480E SKU only) Intel® Core™ i9-10900E (10 Cores, 20M Cache, up to 4.7 GHz); 65W Intel® Core™ i9-10900TE (10 Cores, 20M Cache, up to 4.5 GHz); 35W Intel® Core™ i7-10700E (8 Cores, 16M Cache, up to 4.5 GHz); 65W Intel® Core™ i7-10700TE (8 Cores, 16M Cache, up to 4.4 GHz); 35W Intel® Core™ i5-10500E (6 Cores, 12M Cache, up to 4.2 GHz); 65W Intel® Core™ i5-10500TE (6 Cores, 12M Cache, up to 3.7 GHz); 35W Intel® Core™ i3-10100E (4 Cores, 6M Cache, 3.8 GHz); 65W (ECC support on W480E SKU only) Intel® Core™ i3-10100TE (4 Cores, 6M Cache, to 3.6 GHz); 35W (ECC support on W480E SKU only) Intel® Pentium® G6400E (2 Cores, 4M Cache, 3.8 GHz); 58W (Not support on W480E SKU) Intel® Celeron® G5900E (2 Cores, 2M Cache, 3.2 GHz); 58W (Not support on W480E SKU) Intel® Celeron® G5900TE (2 Cores, 2M Cache, 3.0 GHz); 35W (Not support on W480E SKU)	
	Chipset	Intel® W480E/Q470E Chipset	
	Memory	Two 260-pin SODIMM up to 64GB Dual Channel DDR4 2933MHz (ECC supported by W480E only)	
	BIOS	AMI SPI 256Mbit	
	GRAPHICS	Controller	Intel® UHD Graphics 630 (only Pentium G5400/Celeron G4900 support 610)
		Feature	OpenGL 4.5, DirectX 12, OpenCL 2.1 HW Decode: AVC/H.264, MPEG2, VC1/WMV9, JPEG/MJPEG, HEVC/H265, VP8, VP9 HW Encode: AVC/H.264, MPEG2, JPEG, HEVC/H265, VP8, VP9
		Display	2 x DP++, resolution up to 4096 x 2106 @ 60Hz
		Dual Displays	2 x DP++
	EXPANSION	Interface	1 x PCIe x16 (Gen 3) (x8 signal) 1 x M.2 2230 E key (PCIe/USB 2.0/Intel CNVi support) for WiFi6 1 x M.2 2280 M key (PCIe x4 Gen3 NVMe/SATA/Intel Optane Memory support) for SSD 1 x M.2 3042/3052 B key (PCIe/USB3.0) for 4G LTE/5G with SIM holder
	AUDIO	Audio Codec	Realtek ALC888

ETHERNET	Controller	1 x Intel® I219LM PHY with iAMT12 and vPro (10/100/1000Mbps) (Core i7/i5 supports iAMT) 1 x Intel® I211AT PCIe (10/100/1000Mbps)
	REAR I/O	
	Ethernet	2 x GbE (RJ-45)
	Serial	1 x RS-232/422/485 (RS-232 w/ power) (DB-9)
	USB	8 x USB 3.2 Gen2 4 x USB 3.2
	Display	2 x DP++
INTERNAL I/O	Serial	1 x RS-232/422/485 (RS-232 w/ power) (2.0mm pitch)
	Audio	1 x Front Audio Header
	SATA	2 x SATA 3.0 (up to 6Gb/s) 1 x SATA Power RAID 0/1
	DIO	1 x 8-bit DIO
	LPC	1 x LPC
	SMBus	1 x SMBus
	WATCHDOG TIMER	Output & Interval
SECURITY	TPM	Infineon TPM1.2/2.0 (optional)
POWER	Type	Single 12V +/-10% DC (CMS171) Wide Range 15~36V (CMS173)
	Connector	8-pin ATX 12V power 24-pin ATX power
	Consumption	TBD
	RTC Battery	CR2032 Coin Cell
	OS SUPPORT	Microsoft
	Linux	Ubuntu 20.04
ENVIRONMENT	Temperature	Operating: -5 to 65°C Storage: -40 to 85°C with RTC Battery; -40 to 85°C without RTC Battery
	Humidity	Operating: 5 to 90% RH Storage: 5 to 90% RH
	MTBF	TBD
MECHANISM	Dimensions	Mini-ITX Form Factor : 170mm (6.7") x 170mm (6.7")
	Height	PCB: 1.6mm

► Block Diagram

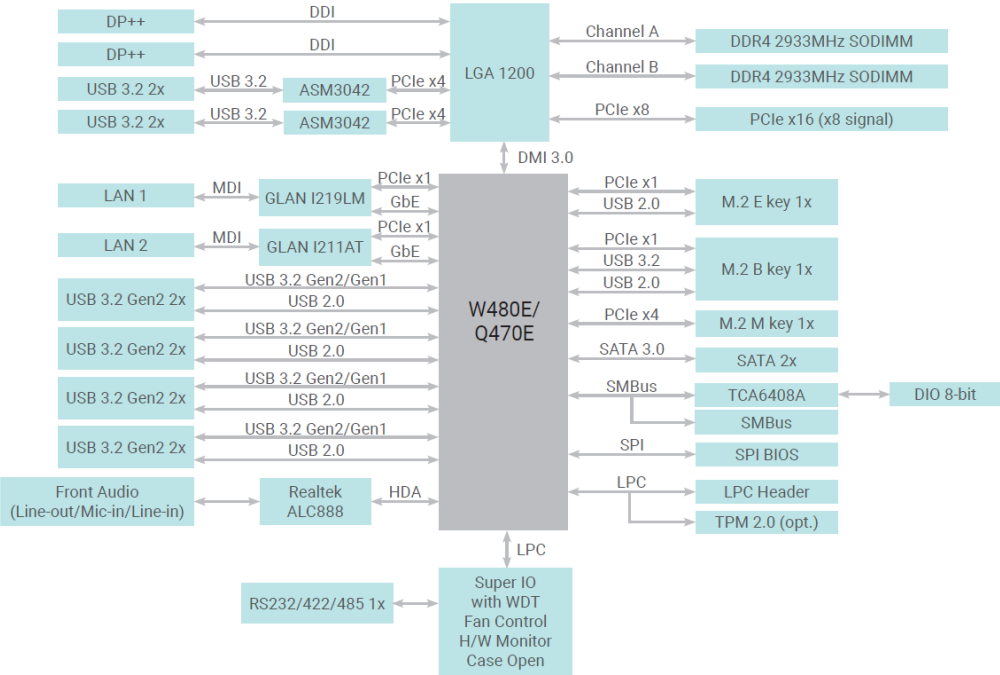

► Dimension

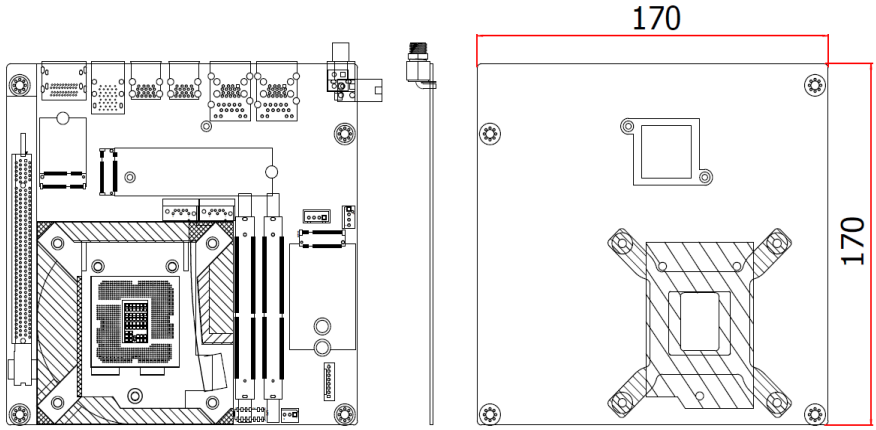

Chapter 2 - Hardware Installation

► Board Layout

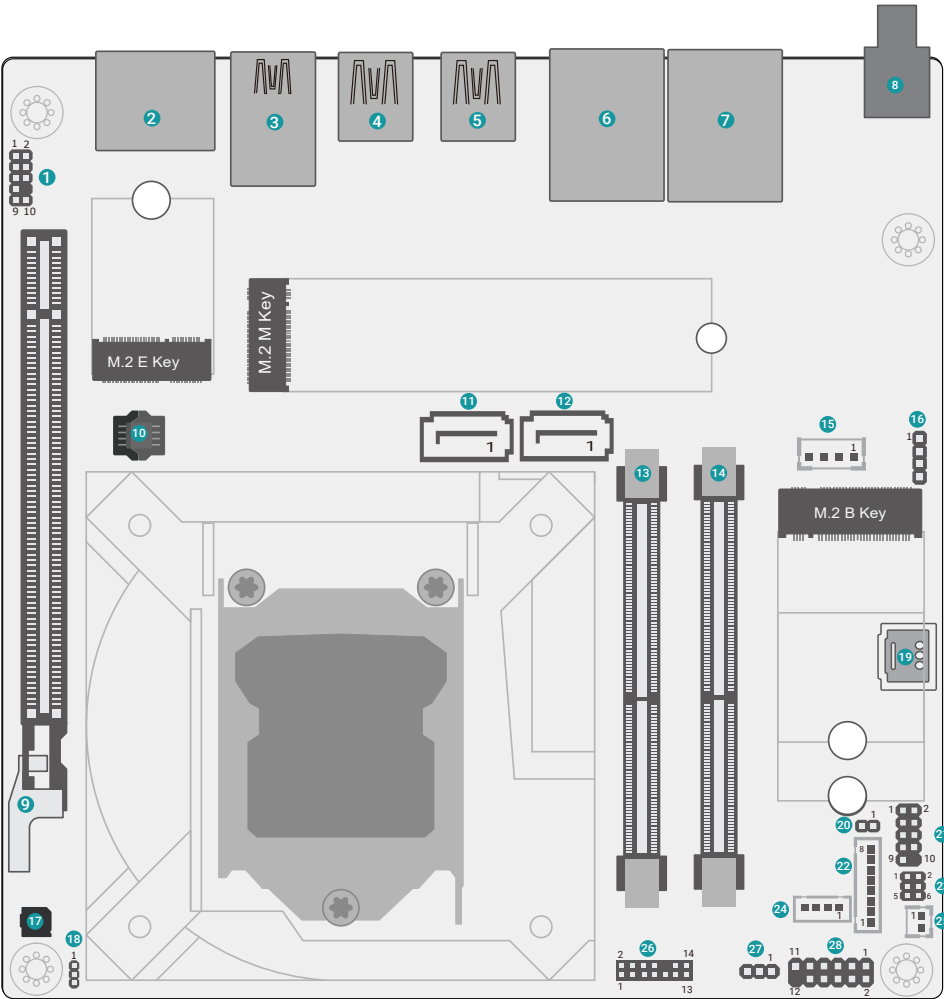

- 1 Front Audio
- 2 DP++
- 3 USB3.2
- 4 USB3.2 Gen2
- 5 USB3.2 Gen2
- 6 ▲LAN2
▼USB3.2 Gen2
- 7 ▲LAN1
▼USB3.2 Gen2
- 8 DC-in
- 9 PCIe x16
- 10 SPI
- 11 SATA1
- 12 SATA0
- 13 SO-DIMM1
- 14 SO-DIMM2
- 15 SATA Power
- 16 CPU Fan
- 17 Buzzer
- 18 CLEAR CMOS
- 19 SIM Card Slot
- 20 Caseopen
- 21 COM1
- 22 8-bit DIO
- 23 Power Selection COM 1
- 24 DIO Power
- 25 Battery
- 26 LPC
- 27 System Fan
- 28 Front Panel

► Installing the heat sink

Installing the Heat Sink

The CPU must be kept cool by using a heat sink, otherwise the CPU will overheat damaging both the CPU and system board.

1. Before you install the fan / heat sink, you must apply a thermal paste onto the top of the CPU. The thermal paste is usually supplied when you purchase the fan / heat sink assembly. Do not spread the paste all over the surface. When you later place the heat sink on top of the CPU, the compound will disperse evenly.

Some heat sinks come with a patch of preapplied thermal paste. Do not apply thermal paste if the fan / heat sink already has a patch of thermal paste on its underside. Peel the strip that covers the paste before you place the fan / heat sink on top of the CPU.

2. Place the heat sink on top of the CPU. The 4 spring screws around the heat sink, which are used to secure the heat sink onto the system board, must match the 4 mounting holes around the board.
3. Screw tight two of the spring screws at opposite corners into the mounting holes. And then proceed with the other two spring screws.

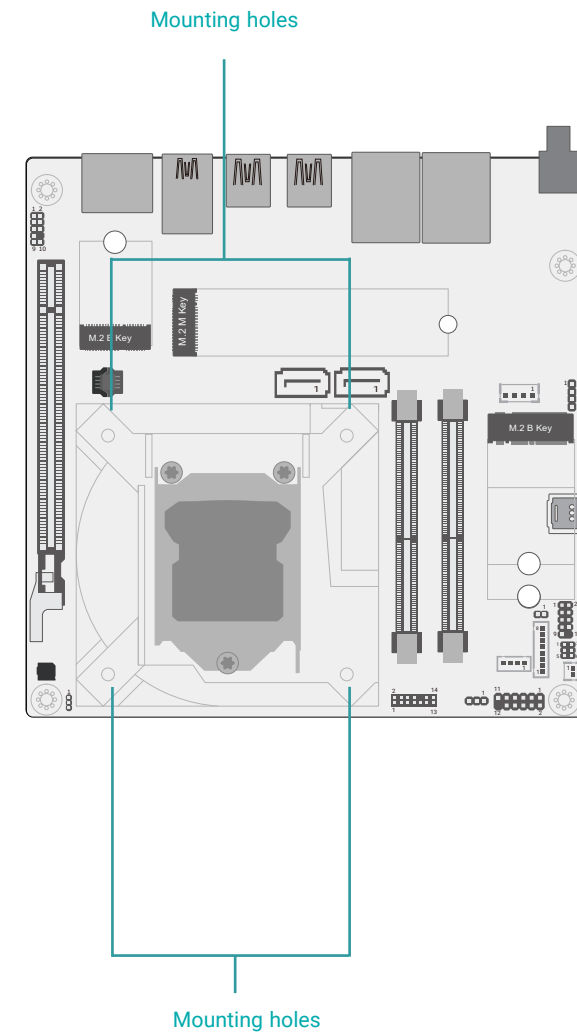

► Jumper Settings

Clear CMOS (JP1)

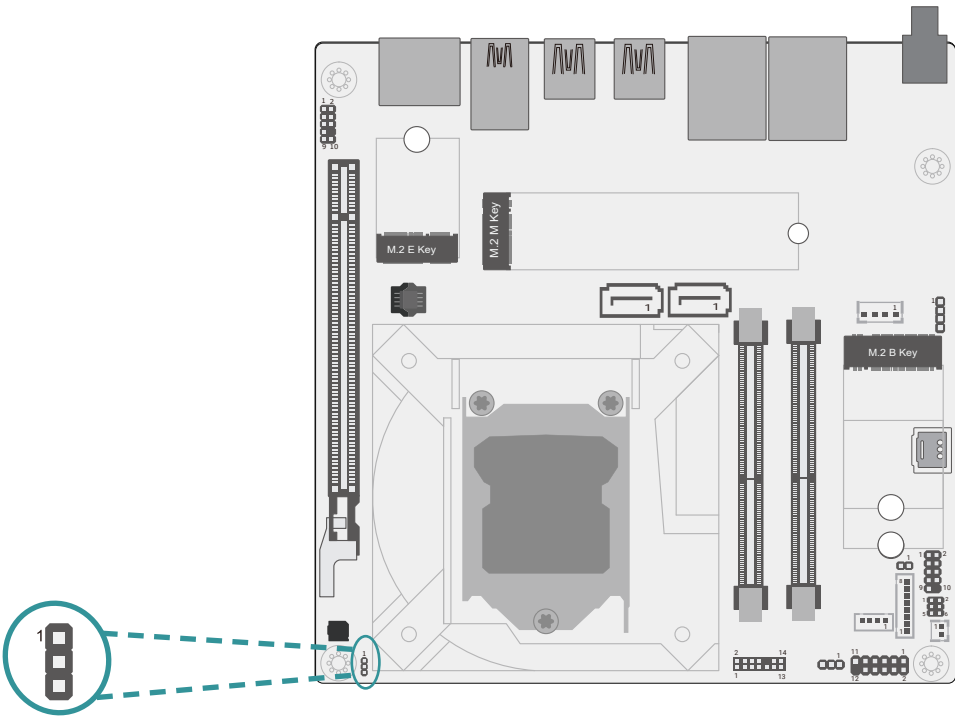

■ 1-2 On: Default



■ 2-3 Off: Clear

Power Selection COM 1 (JP2)

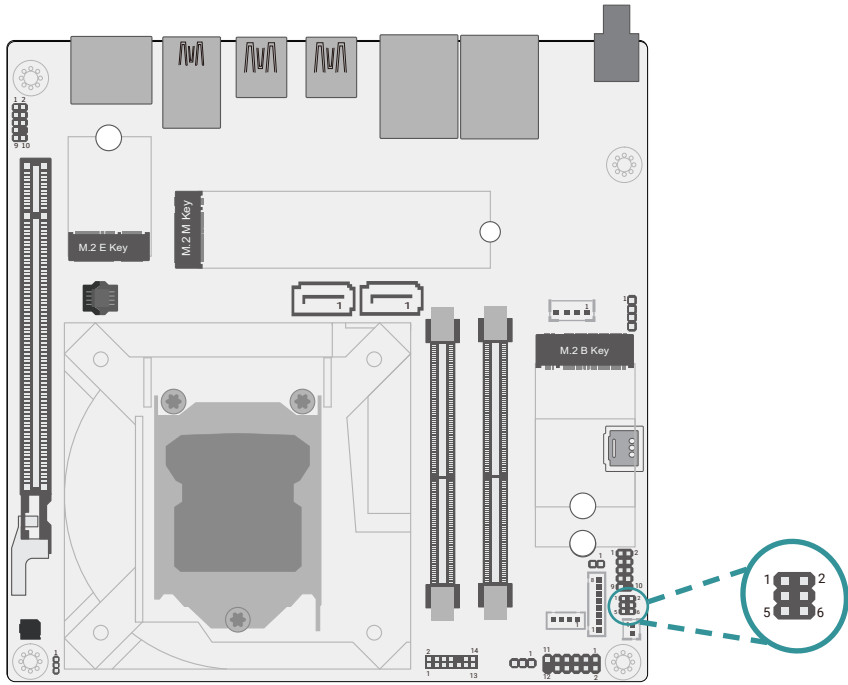

■ 1-3 /2-4 On:
RS232 Standard (Default)

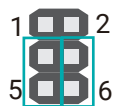

■ 3-5 /4-6 On:
RS232 with Power

► Pin Assignment

System Fan (J9)

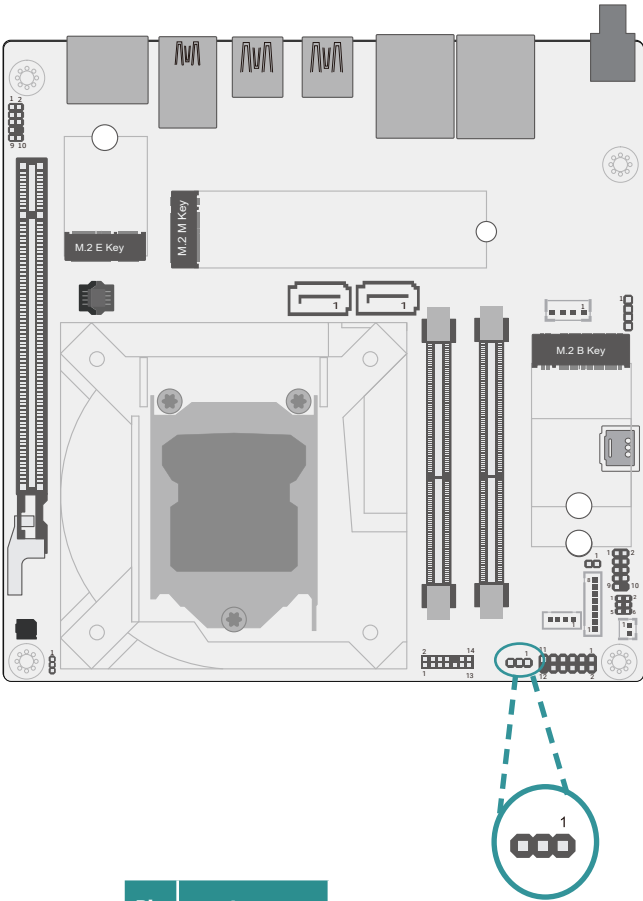

Pin	Assignment
1	GND
2	PWM
3	TACH

SATA Power (CN1)

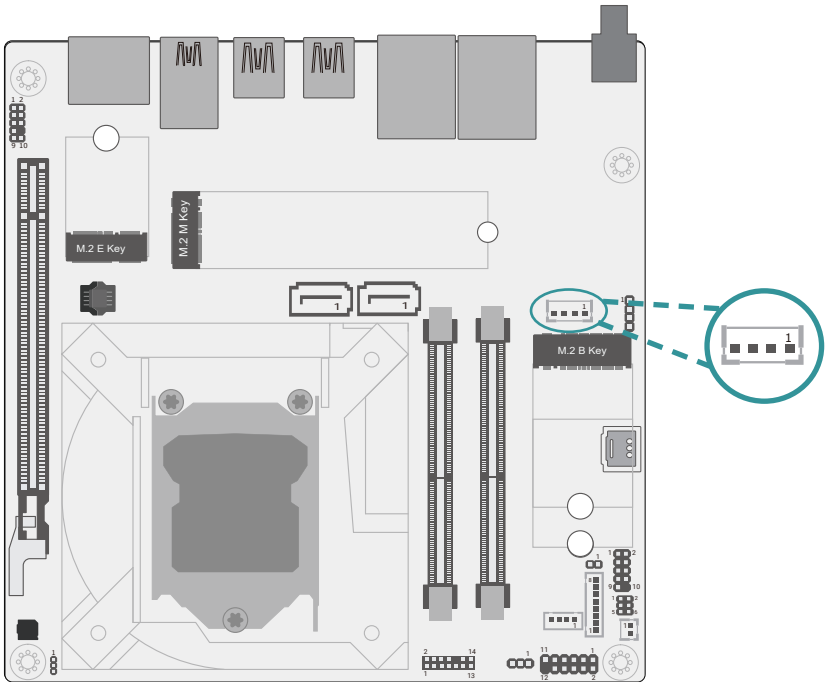

Pin	Assignment
1	+12V DC
2	GND
3	GND
4	+5V DC

CPU Fan (J10)

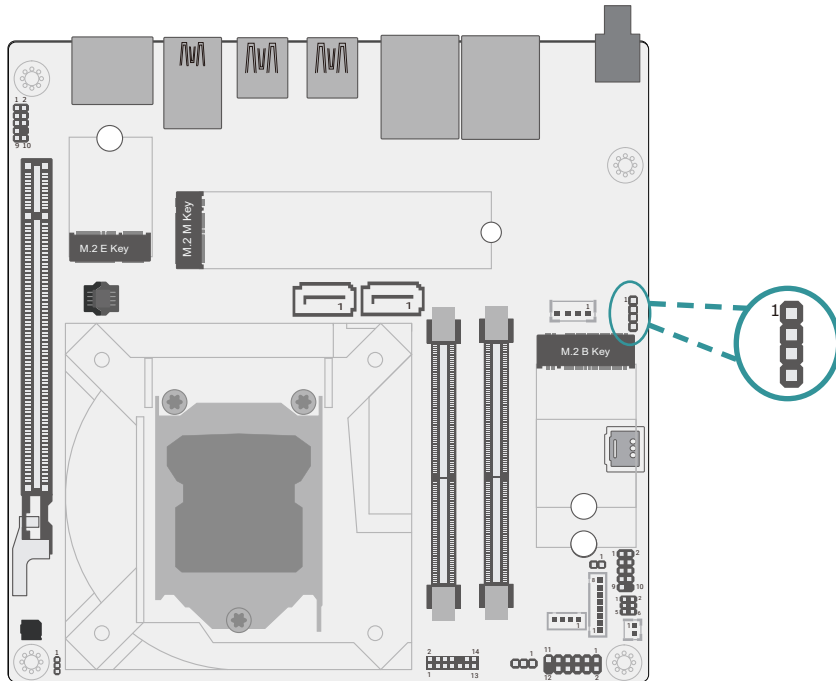

Pin	Assignment
1	GND
2	12V
3	RPM
4	CTRL

DIO Power (J12)

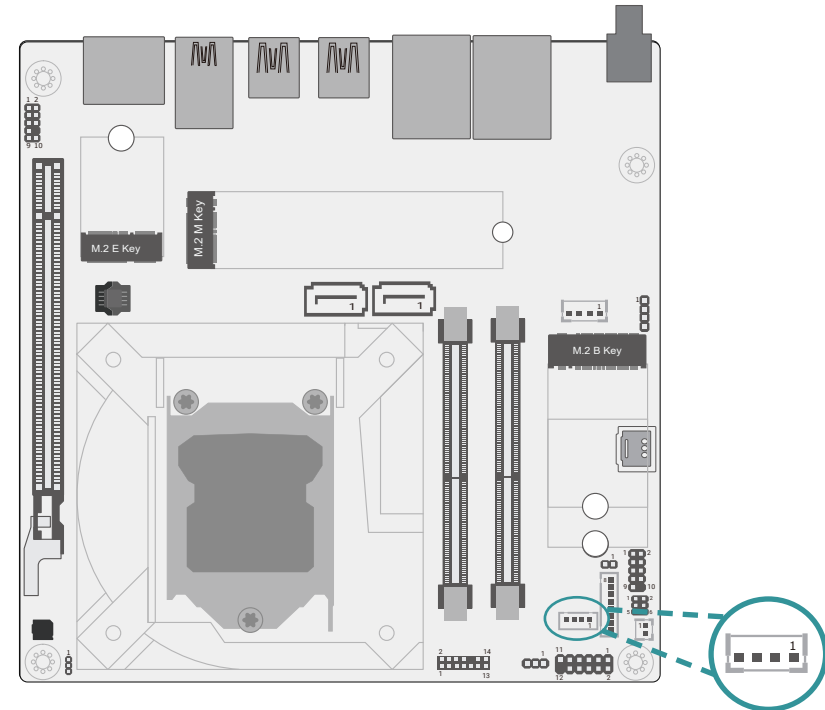

Pin	Assignment
1	12V
2	GND
3	5VDU
4	5V

SATA0 (J1)

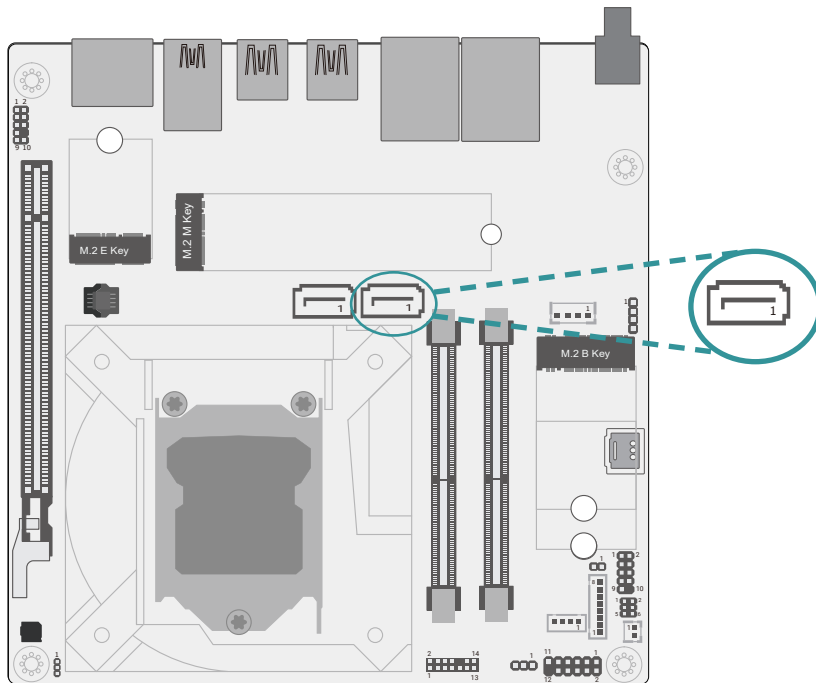

Pin	Assignment
1	GND
2	TXP
3	TXN
4	GND
5	RXN
6	RXP
7	GND

SATA1 (J2)

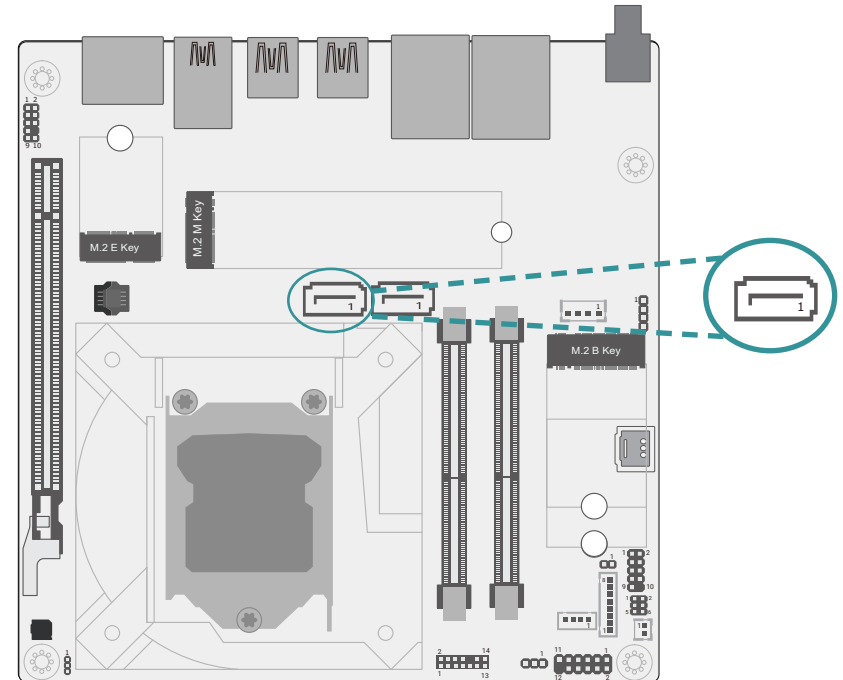

Pin	Assignment
1	GND
2	TXP
3	TXN
4	GND
5	RXN
6	RXP
7	GND

COM1 (J17)

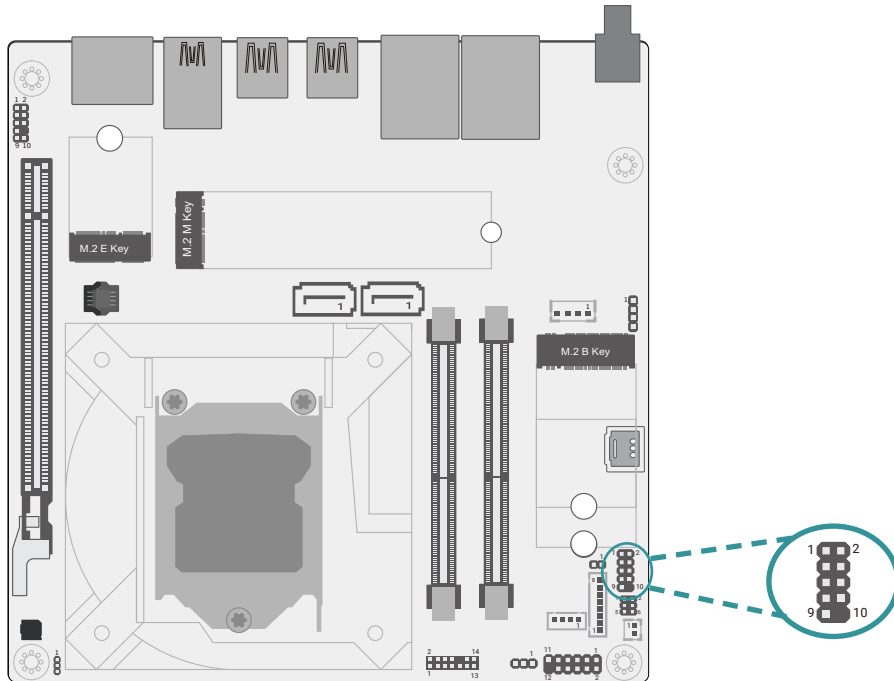

Pin	Assignment	Pin	Assignment
1	MDCD-	2	MSIN-
3	MSO-	4	MDTR-
5	GND	6	MDSR-
7	MRTS-	8	MCTS-
9	MRI-	10	----

Front Audio (AUJ2)

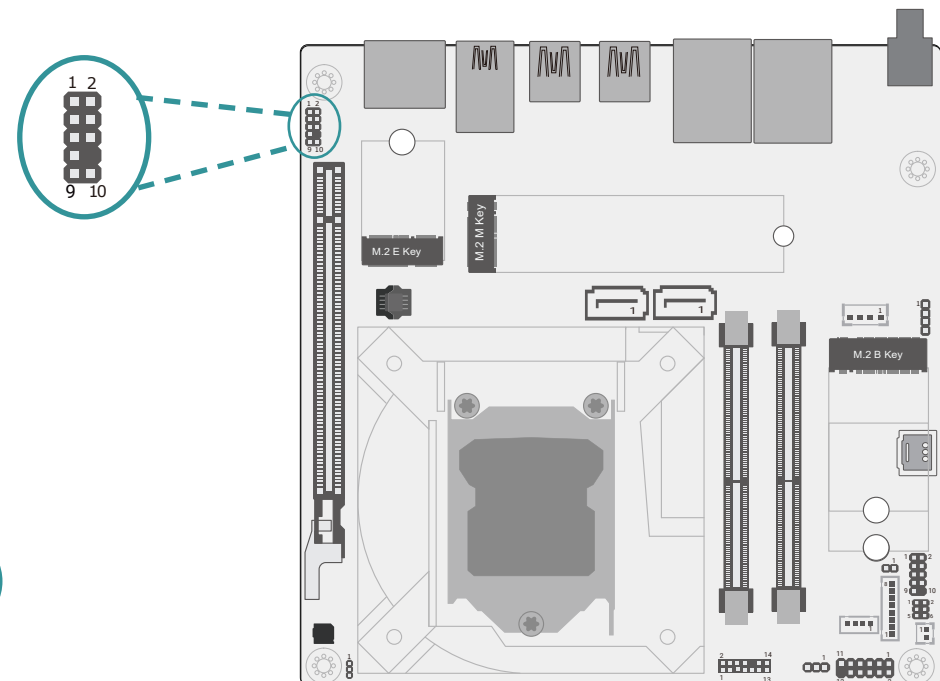

Pin	Assignment	Pin	Assignment
1	MIC2_L	2	GND
3	MIC2_R	4	-ACZ_DET
5	LINE2_R	6	FSENSE1
7	FAUDIO_JD	8	NC
9	LINE2_L	10	FSENSE2

Front Panel (J11)

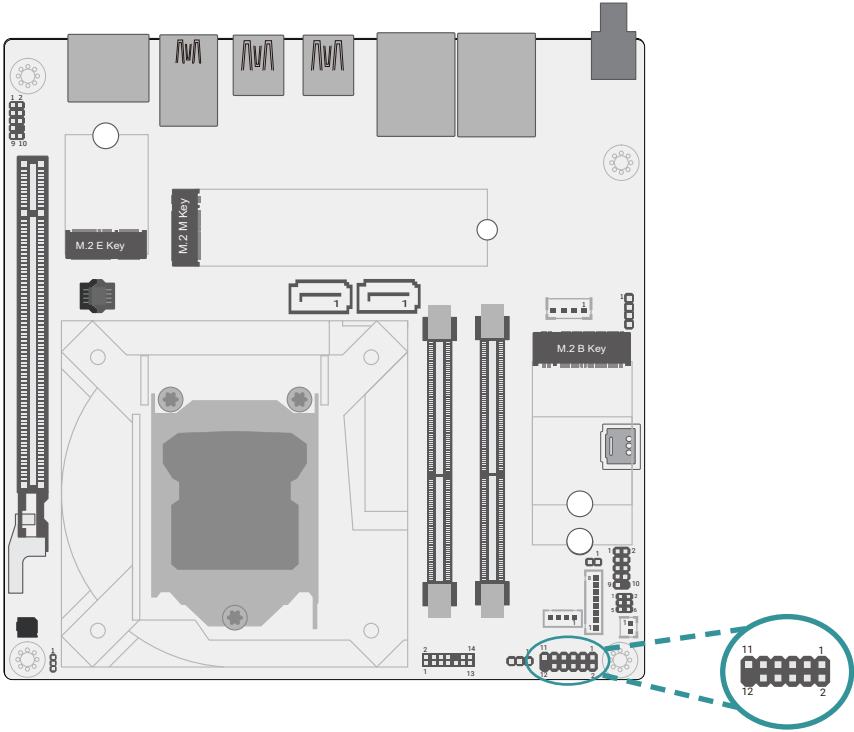

Pin	Assignment	Pin	Assignment
1	NC	2	V_SUS_LED
3	3V3	4	V_SUS_LED
5	HDD_LED	6	SUS_LED
7	GND	8	GND
9	SYS_RST-	10	PWR_BTN-
11	NC	12	---

DIO (J13)

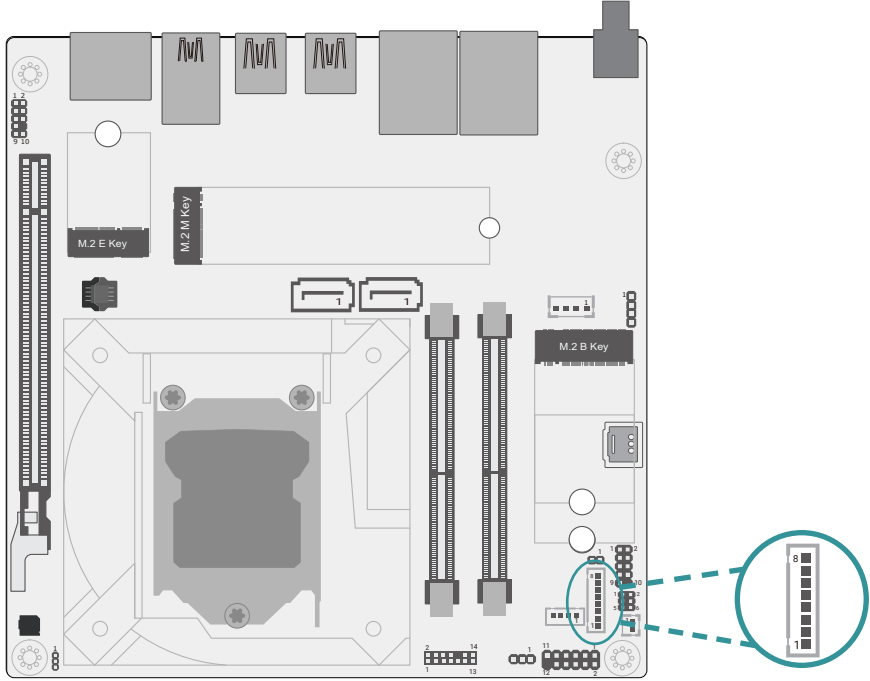

Pin	Assignment
1	DIO0
2	DIO1
3	DIO2
4	DIO3
5	DIO4
6	DIO5
7	DIO6
8	DIO7

LPC (J14)

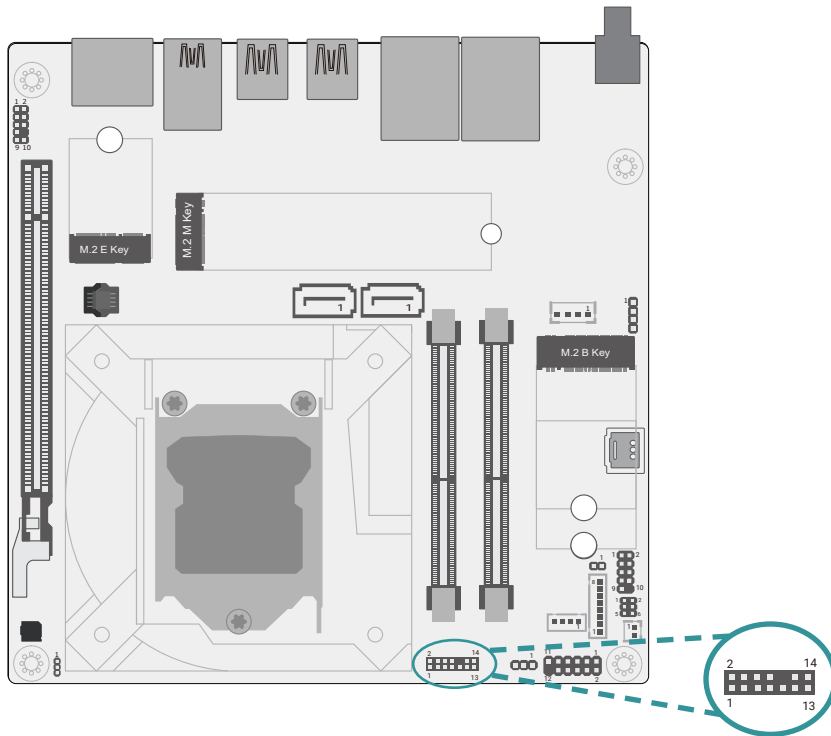

Pin	Assignment	Pin	Assignment
1	CLK	2	LAD1
3	RST#	4	LAD0
5	FRAME#	6	VCC3
7	LAD3	8	GND1
9	LAD2	10	---
11	SERIRQ	12	GND2
13	5VSB	14	5V

► **System Memory**

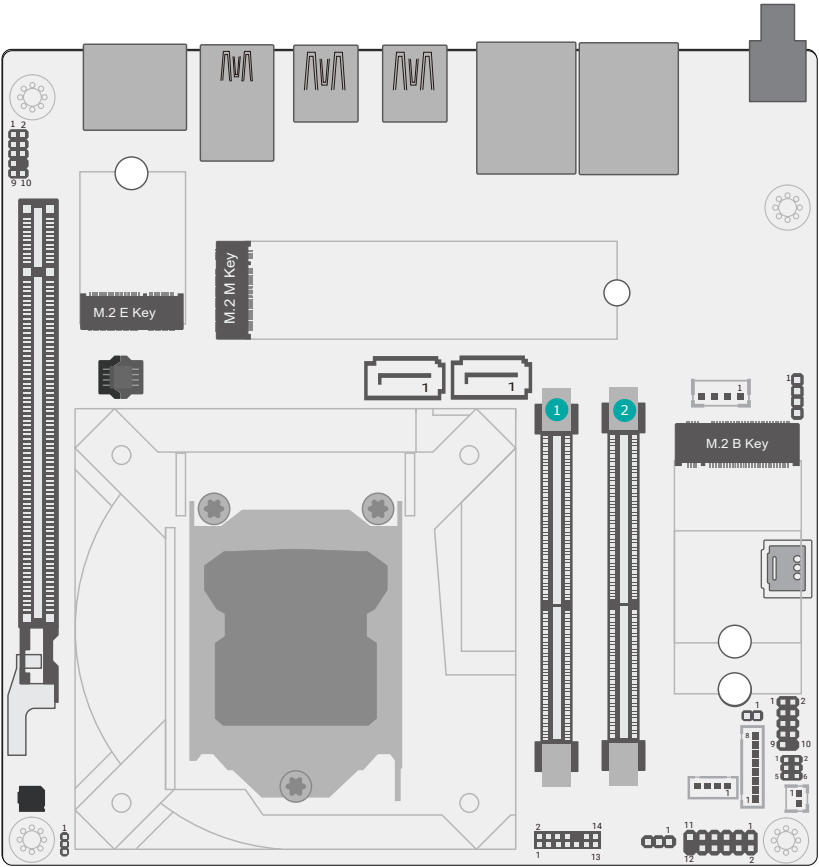

- 1 SO-DIMM1
- 2 SO-DIMM2

Installing the SO-DIMM Module

Before installing the memory module, please make sure that the following safety cautions are well-attended.

1. Make sure the PC and all other peripheral devices connected to it has been powered down.
2. Disconnect all power cords and cables.
3. Locate the SO-DIMM socket on the system board
4. Make sure the notch on memory card is aligned to the key on the socket.

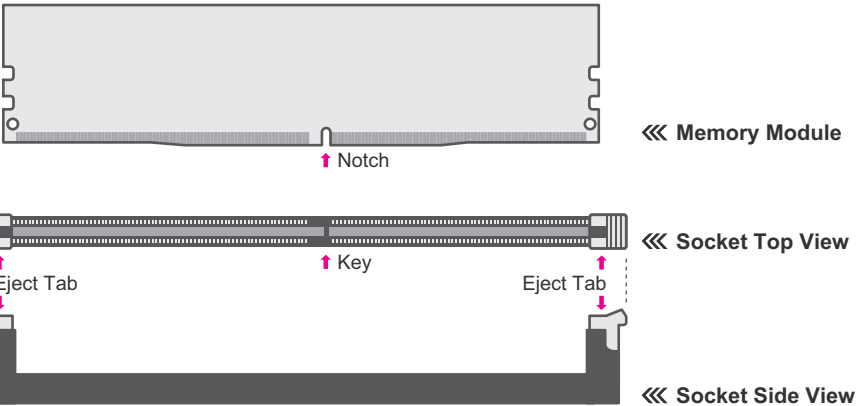

The system board supports the following memory interface.

Single Channel (SC)
Data will be accessed in chunks of 64 bits from the memory channels. DIMMs are on the same channel. DIMMs in a channel can be identical or completely different. However, we highly recommend using identical DIMMs. Not all slots need to be populated.

Dual Channel (DC)
Data will be accessed in chunks of 128 bits from the memory channels. Dual channel provides better system performance because it doubles the data transfer rate.

► Expansion Slots

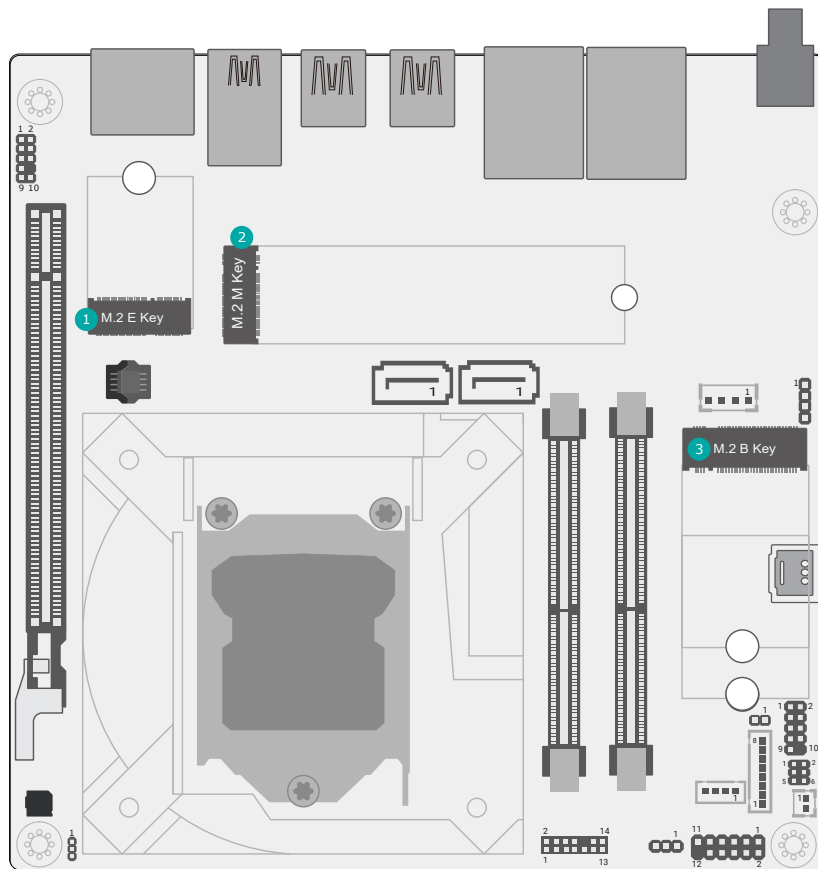

- 1 M.2 E-Key
- 2 M.2 M-Key
- 3 M.2 B-Key

Installing the M.2 Module

Before installing the M.2 module into the M.2 socket, please make sure that the following safety cautions are well-attended.

1. Make sure the PC and all other peripheral devices connected to it has been powered down.
2. Disconnect all power cords and cables.
3. Locate the M.2 socket on the system board
4. Make sure the notch on card is aligned to the key on the socket.
5. Make sure the standoff screw is removed from the standoff.

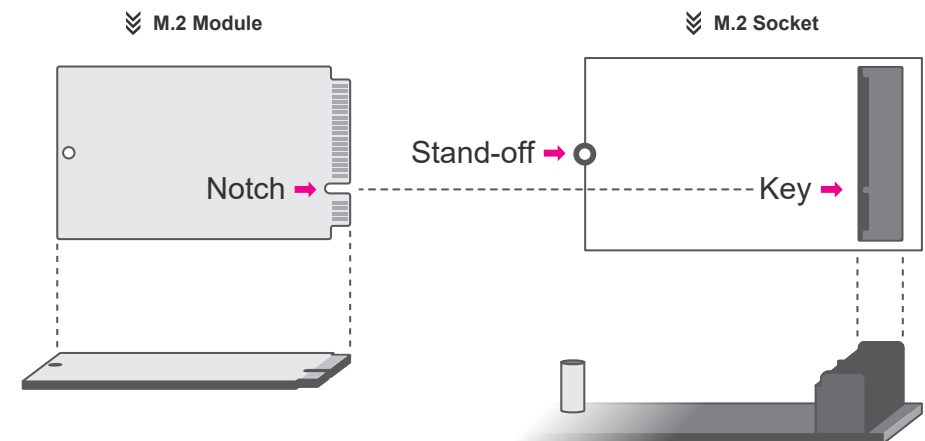

Please follow the steps below to install the card into the socket.

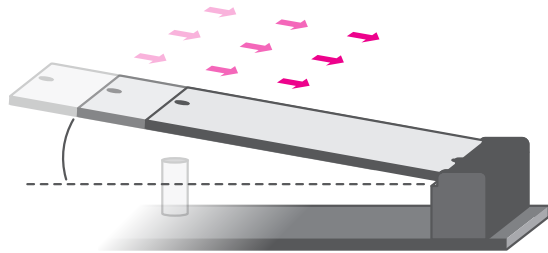

Step 1:
Insert the card into the socket at an angle while making sure the notch and key are perfectly aligned.

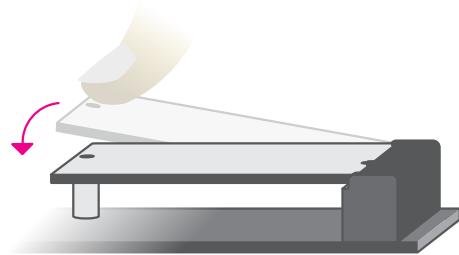

Step 2:
Press the end of the card far from the socket down until against the stand-off.

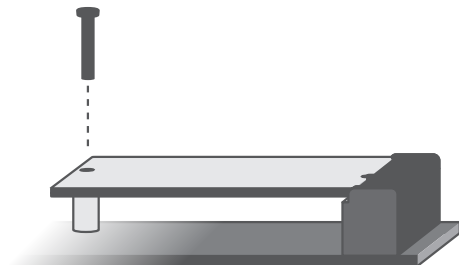

Step 3:
Screw tight the card onto the stand-off with a screw driver and a stand-off screw until the gap between the card and the stand-off closes up. The card should be lying parallel to the board when it's correctly mounted.

Chapter 3 - BIOS Settings

► Overview

The BIOS is a program that takes care of the basic level of communication between the CPU and peripherals. It contains codes for various advanced features found in this system board.

The BIOS allows you to configure the system and save the configuration in a battery-backed CMOS so that the data retains even when the power is off. In general, the information stored in the CMOS RAM of the EEPROM will stay unchanged unless a configuration change has been made such as a hard drive replaced or a device added.

It is possible that the CMOS battery will fail causing CMOS data loss. If this happens, you need to install a new CMOS battery and reconfigure the BIOS settings.



Note:

The BIOS is constantly updated to improve the performance of the system board; therefore the BIOS screens in this chapter may not appear the same as the actual one. These screens are for reference purpose only.

Default Configuration

Most of the configuration settings are either predefined according to the Load Optimal Defaults settings which are stored in the BIOS or are automatically detected and configured without requiring any actions. There are a few settings that you may need to change depending on your system configuration.

Entering the BIOS Setup Utility

The BIOS Setup Utility can only be operated from the keyboard and all commands are keyboard commands. The commands are available at the right side of each setup screen.

The BIOS Setup Utility does not require an operating system to run. After you power up the system, the BIOS message appears on the screen and the memory count begins. After the memory test, the message "Press DEL to run setup" will appear on the screen. If the message disappears before you respond, restart the system or press the "Reset" button. You may also restart the system by pressing the <Ctrl> <Alt> and keys simultaneously.

Legends

Keys	Function
Right / Left arrow	Move the highlight left or right to select a menu
Up / Down arrow	Move the highlight up or down between submenus or fields
<Enter>	Enter the highlighted submenu
+ (plus key)/F6	Scroll forward through the values or options of the highlighted field
- (minus key)/F5	Scroll backward through the values or options of the highlighted field
<F1>	Display general help
<F2>	Display previous values
<F9>	Optimized defaults
<F10>	Save and Exit
<Esc>	Return to previous menu

Scroll Bar

When a scroll bar appears to the right of the setup screen, it indicates that there are more available fields not shown on the screen. Use the up and down arrow keys to scroll through all the available fields.

Submenu

When "►" appears on the left of a particular field, it indicates that a submenu which contains additional options are available for that field. To display the submenu, move the highlight to that field and press <Enter>.

► Updating the BIOS

To update the BIOS, you will need the new BIOS file and a flash utility. Please contact technical support or your sales representative for the files and specific instructions about how to update BIOS with the flash utility.

► Notice: BIOS SPI ROM

1. The Intel® Management Engine has already been integrated into this system board. Due to the safety concerns, the BIOS (SPI ROM) chip cannot be removed from this system board and used on another system board of the same model.
2. The BIOS (SPI ROM) on this system board must be the original equipment from the factory and cannot be used to replace one which has been utilized on other system boards.
3. If you do not follow the methods above, the Intel® Management Engine will not be updated and will cease to be effective.



Note:

- a. You can take advantage of flash tools to update the default configuration of the BIOS (SPI ROM) to the latest version anytime.
- b. When the BIOS IC needs to be replaced, you have to populate it properly onto the system board after the EEPROM programmer has been burned and follow the technical person's instructions to confirm that the MAC address should be burned or not.
- c. After updating unique MAC Address from manufacturing, NVM will be protected immediately after power cycle. Users cannot update NVM or MAC address.

► Main

The Main menu is the first screen that you will see when you enter the BIOS Setup Utility.

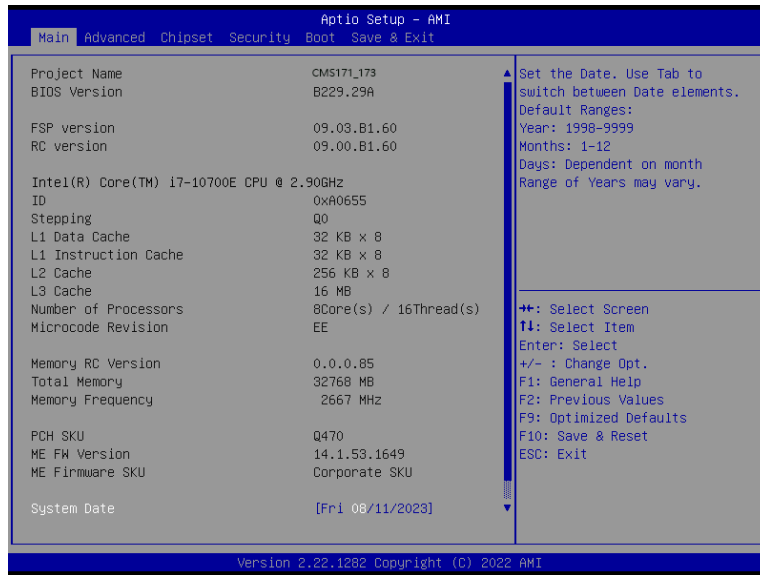

System Date

The date format is <month>, <date>, <year>. Press "Tab" to switch to the next field and press "-" or "+" to modify the value.

System Time

The time format is <hour>, <minute>, <second>. The time is based on the 24-hour military-time clock. For example, 1 p.m. is 13:00:00. Hour displays hours from 00 to 23. Minute displays minutes from 00 to 59. Second displays seconds from 00 to 59.

► Advanced

The Advanced menu allows you to configure your system for basic operation. Some entries are defaults required by the system board, while others, if enabled, will improve the performance of your system or let you set some features according to your preference.



Important:
Setting incorrect field values may cause the system to malfunction.

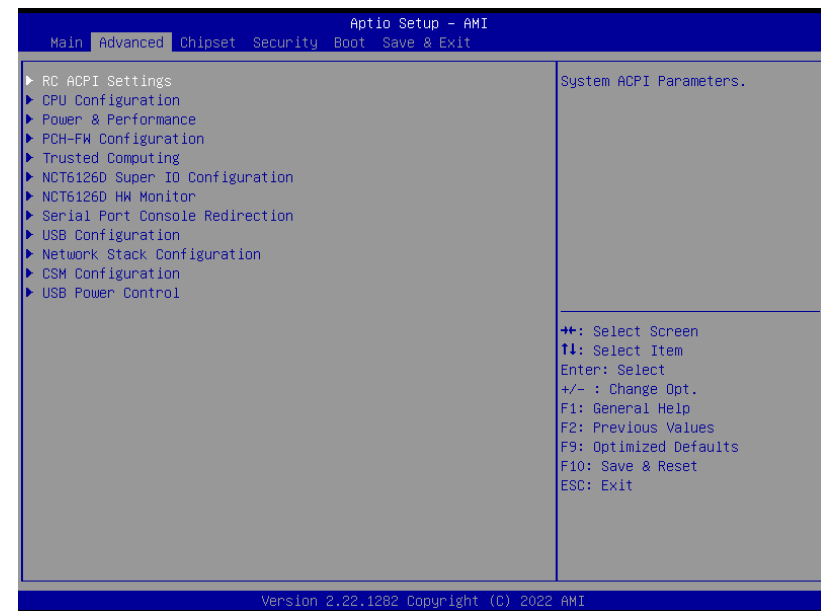

▶ Advanced

RC ACPI Settings

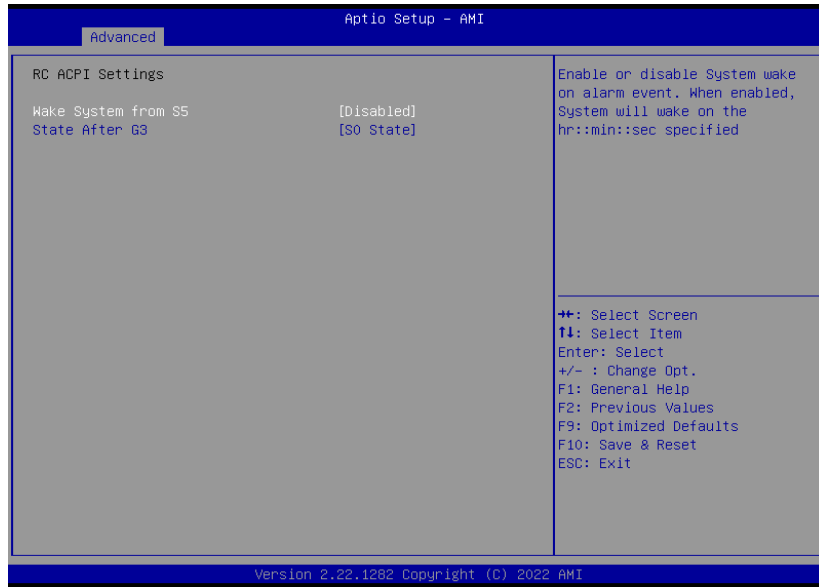

Wake system from S5 via RTC

When Enabled, the system will automatically power up at a designated time every day. Once it's switched to [Enabled], please set up the time of day – hour, minute, and second – for the system to wake up.

State After G3

Select between S0 State, and S5 State. This field is used to specify what state the system is set to return to when power is re-applied after a power failure (G3 state).

- **S0 State** The system automatically powers on after power failure.
- **S5 State** The system enter soft-off state after power failure. Power-on signal input is required to power up the system.
- **Last State** The system returns to the last state right before power failure.

▶ Advanced

CPU Configuration

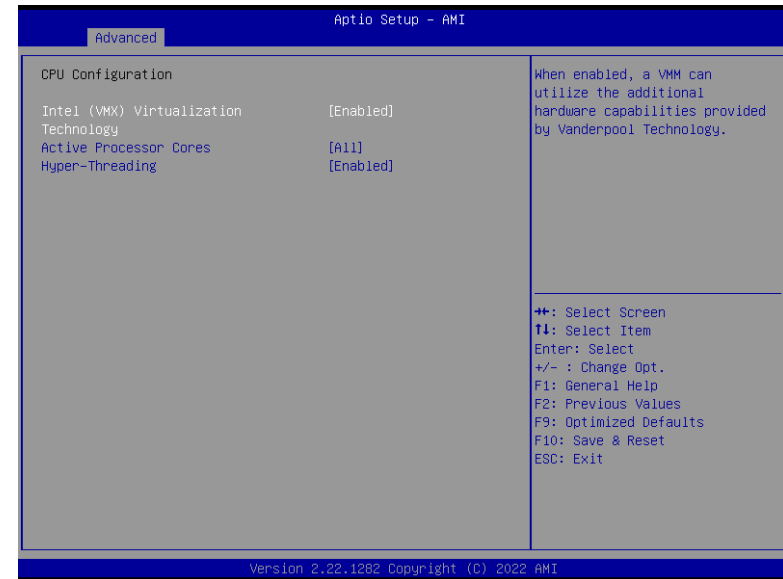

Intel (VMX) Virtualization Technology

When this field is set to Enabled, the VMM can utilize the additional hardware capabilities provided by Vanderpool Technology.

Active Processor Cores

Select number of cores to enable in each processor package: all or 1.

Hyper-threading

Enables this field for Windows XP and Linux which are optimized for Hyper-Threading technology. Select disabled for other OSes not optimized for Hyper-Threading technology. When disabled, only one thread per enabled core is enabled.

▶ Advanced

Power & Performance

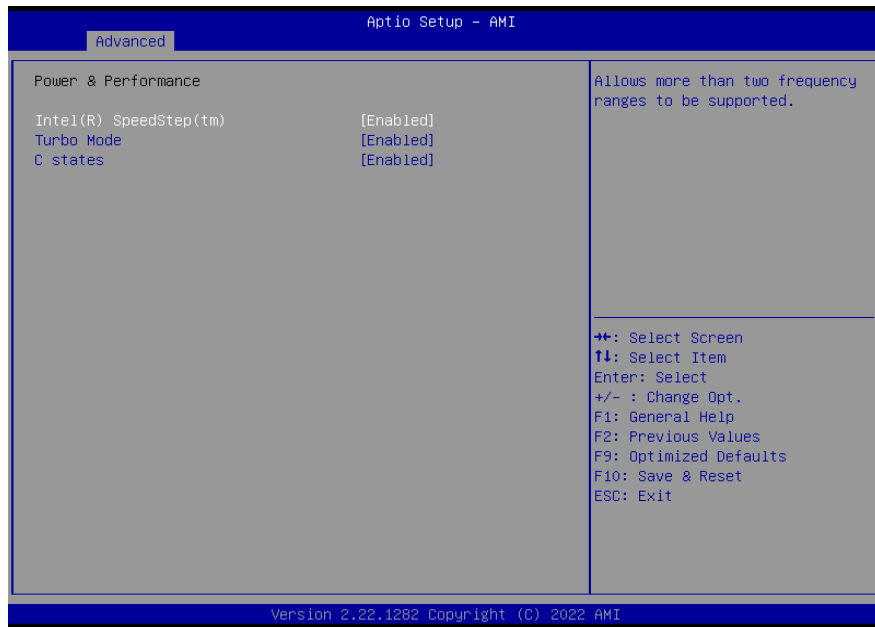

Intel (R) SpeedStep(tm)

This field is used to enable or disable the Intel SpeedStep® Technology, which helps optimize the balance between system's power consumption and performance. After it is enabled in the BIOS, EIST features can then be enabled via the operating system's power management.

Turbo Mode

Enable or disable turbo mode of the processor. This field will only be displayed when EIST is enabled.

C states

Enable or disable CPU Power Management. It allows CPU to enter "C states" when it's idle and nothing is executing.

▶ Advanced

PCH-FW Configuration

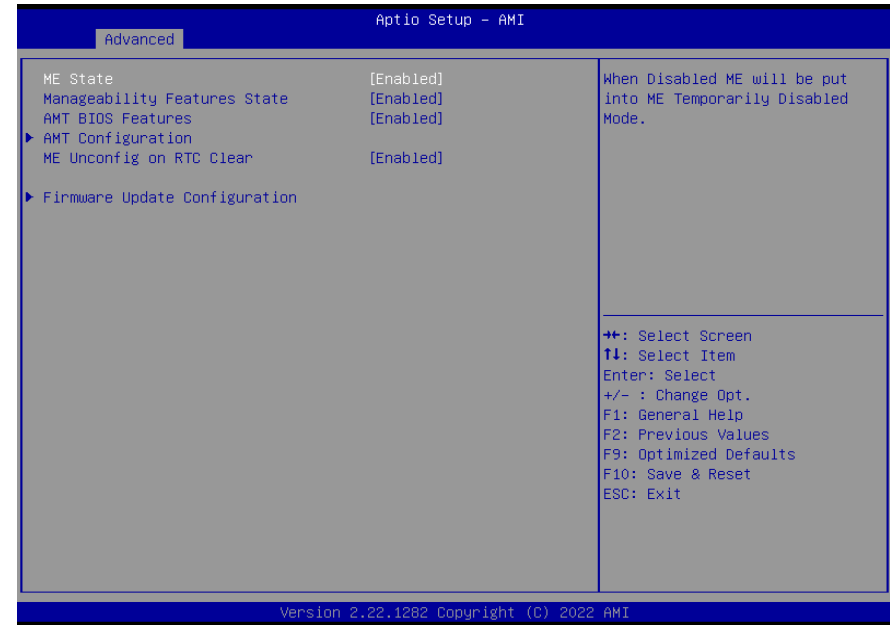

ME State

When this field is set to Disabled, ME will be put into ME Temporarily Disabled Mode.

Manageability Features State

Enable or disable Intel(R) Manageability features. This option disables/enables Manageability Features support in FW. To disable, support platform must be in an unprovisioned state first.

AMT BIOS Features

When disabled, AMT BIOS features are no longer supported and user is no longer able to access MEBx Setup. This option does not disable manageability features in FW.

AMT Configuration

Configure Intel(R) Active Management Technology Parameters.

ME Unconfig on RTC Clear

When disabled, ME will not be unconfigured on RTC Clear.

Firmware Update Configuration

Configure Management Engine Technology Parameters.

▶ Advanced

Trusted Computing

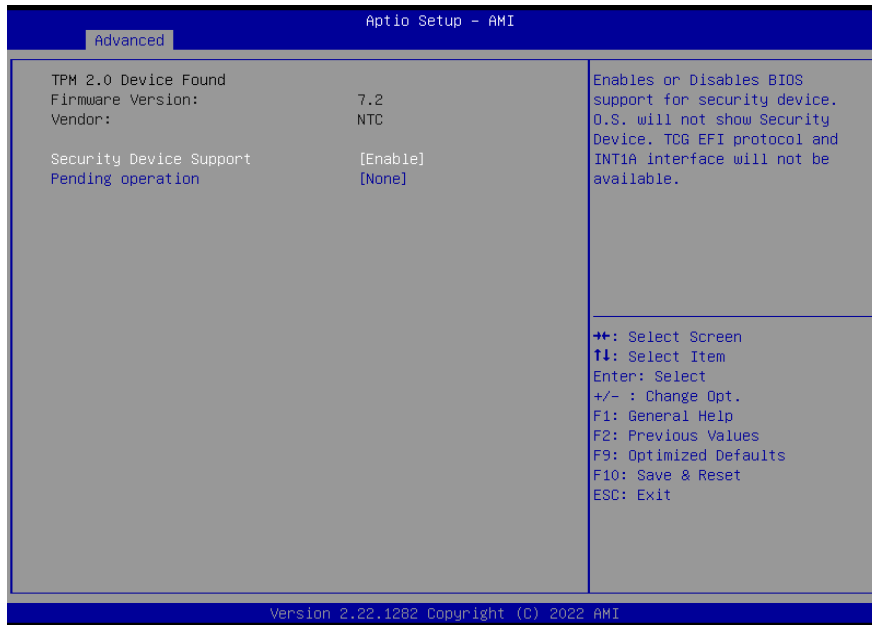

Security Device Support

This field is used to enable or disable BIOS support for the security device such as an TPM 2.0 to achieve hardware-level security via cryptographic keys.

Pending operation

To clear the existing TPM encryption, select "TPM Clear" and restart the system. This field is not available when "Security Device Support" is disabled.

▶ Advanced

NCT6126D Super IO Configuration



WatchDog Output Options

Select The Output Options.
 Mode1 (System Reset) = A Watchdog Timeout causes the system to be reset.
 Mode2 (Output Only) = WDT pin goes high upon timeout of the watchdog timer.
 Mode3 (Generate NMI) = Generate NMI upon timeout of the watchdog timer.

WatchDog Timer Unit

Select WatchDog Timer Unit – Second or Minute.

SuperIO WatchDog Timer

Set SuperIO WatchDog Timer Timeout value. The range is from 0 (disabled) to 255.

► **Advanced**

NCT5525D Super IO Configuration ► **Serial Port 1 Configuration**

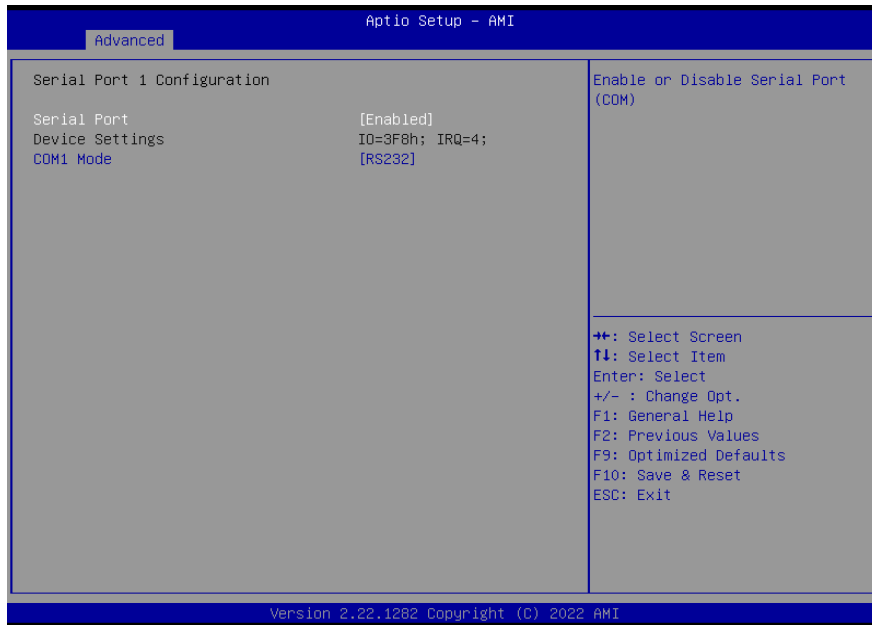

Serial Port

Enable or disable serial port.

► **Advanced**

NCT6126D HW Monitor

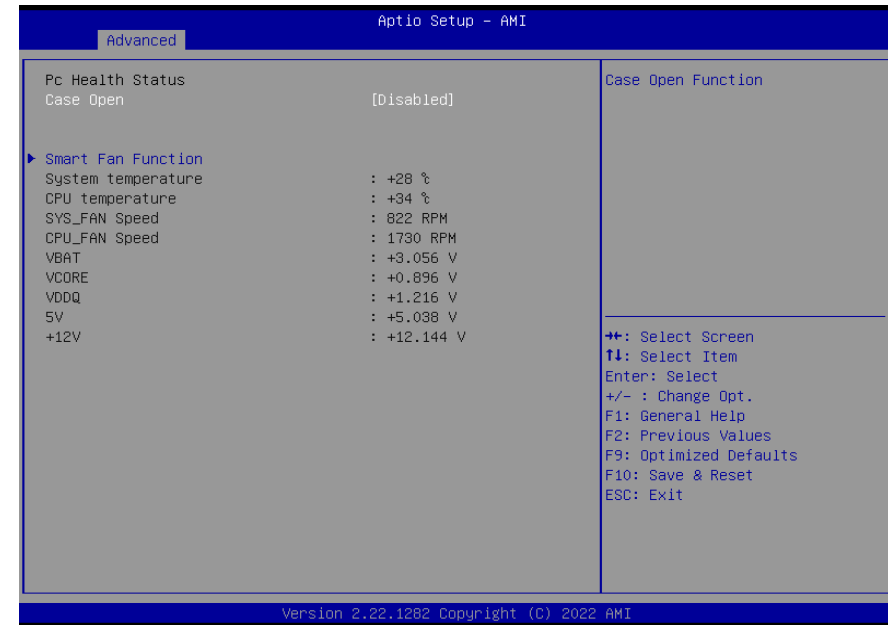

This section displays the system's health information, i.e. voltage readings, CPU and system temperatures, and fan speed readings

▶ Advanced

NCT6126D HW Monitor ▶ Smart FAN Function

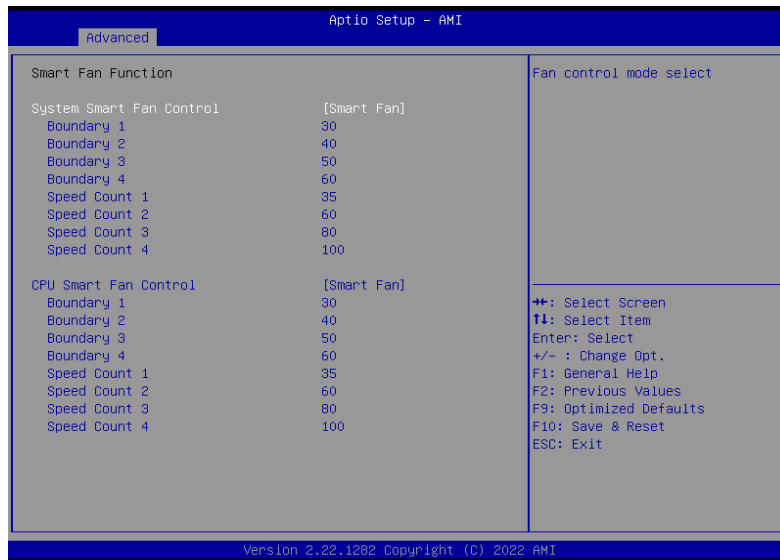

▼ CPU/SYS Smart Fan Control = [Smart Fan]

Boundary 1 to Boundary 4

Set the boundary temperatures that determine the fan speeds accordingly, the value ranging from 0-127°C. For example, when the system temperature reaches Boundary 1 setting, the fan speed will be turned up to the designated speed of the Fan Speed Count 1 field.

Fan Speed Count 1 to Fan Speed Count 4

Set the fan speed, the value ranging from 1-100%, 100% being full speed. The fans will operate according to the specified boundary temperatures above-mentioned.

▶ Advanced

Serial Port Console Redirection



Console Redirection

By enabling Console Redirection of a COM port, the sub-menu of console redirection settings will become available for configuration as detailed in the following.

► Advanced

Serial Port Console Redirection ► Console Redirection Settings



Terminal Type

Select terminal type: VT100, VT100+, VT-UTF8 or ANSI.

Bits per second

Select serial port transmission speed: 9600, 19200, 38400, 57600 or 115200.

Data Bits

Select data bits: 7 bits or 8 bits.

Parity

Select parity bits: None, Even, Odd, Mark or Space.

Stop Bits

Select stop bits: 1 bit or 2 bits.

Flow Control

Select flow control type: None or Hardware RTS/CTS. Flow Control is for RS485 mode and is only supported by Serial Port 1 (COM1).

► Advanced

USB Configuration



Legacy USB Support

- **Enabled** Enable Legacy USB support.
- **Disabled** Keep USB devices available only for EFI applications.
- **Auto** Disable Legacy support if no USB devices are connected.

XHCI Hand-off

Enable or disable XHCI Hand-off.

USB Mass Storage Driver Support

Enable or disable USB Mass Storage Driver Support.

► Advanced

Network Stack Configuration

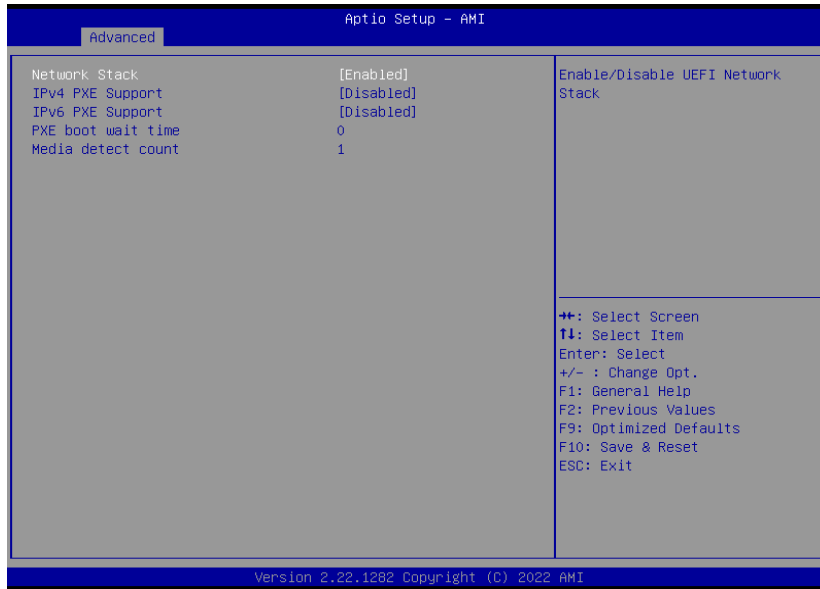

Network Stack

Enable or disable UEFI network stack. The following fields will appear when this field is enabled.

IPv4 PXE Support

Enable or disable IPv4 PXE boot support. If disabled, IPv4 PXE boot support will not be available.

IPv6 PXE Support

Enable or disable IPv6 PXE boot support. If disabled, IPv6 PXE boot support will not be available.

PXE boot wait time

Set the wait time in seconds to press ESC key to abort the PXE boot. Use either +/- or numeric keys to set the value.

Media detect count

Set the number of times the presence of media will be checked. Use either +/- or numeric keys to set the value.

► Advanced

CSM Configuration

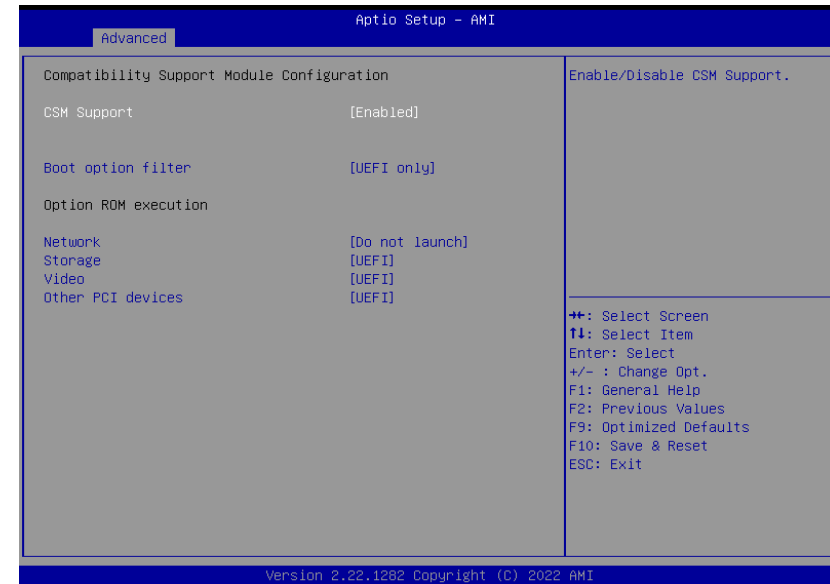

CSM (Compatibility Support Module) Support

Enable or disable CSM Support.

Boot option filter

This option controls Legacy/UEFI ROMs priority.

Network

Controls the execution of UEFI and Legacy Network OpROM

Storage

Controls the execution of UEFI and Legacy Storage OpROM

Video

Controls the execution of UEFI and Legacy Video OpROM

Other PCI devices

Determines OpROM execution policy for devices otherthan Network, Storage, or Video.

► **Advanced**

USB Power Control

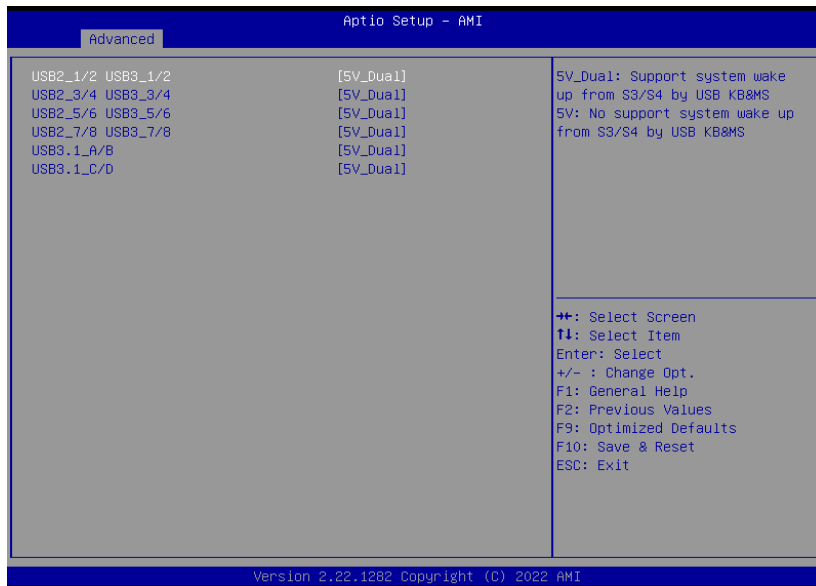

Server CA Configuration

5_Dual: Support system wake up from S3/S4 by USB KB&MS

5V: No support system wake up from S3/S4 by USB KB&MS

► Chipset

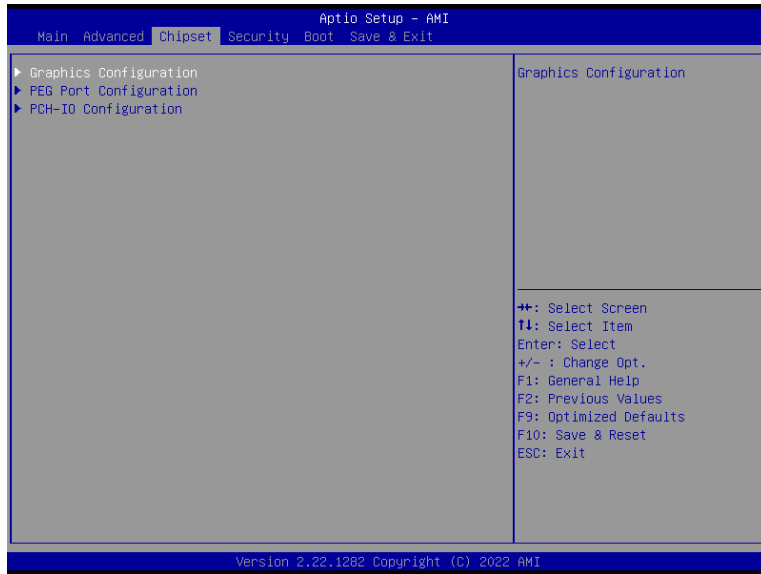

Please select a submenu and press Enter. The submenus are detailed in the following pages.

► Chipset

Graphics Configuration

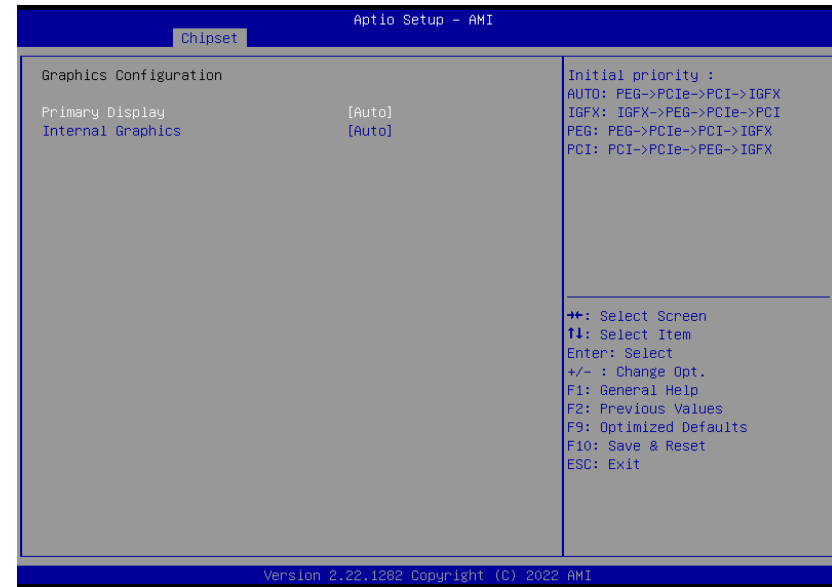

Primary Display

Select which of IGFX/PEG/PCI Graphics device to be the primary display.

Internal Graphics

Keep IGFX "Enabled" or "Disabled" based on the setup options, or select "Auto" for auto-detection.

► Chipset

PEG Port Configuration

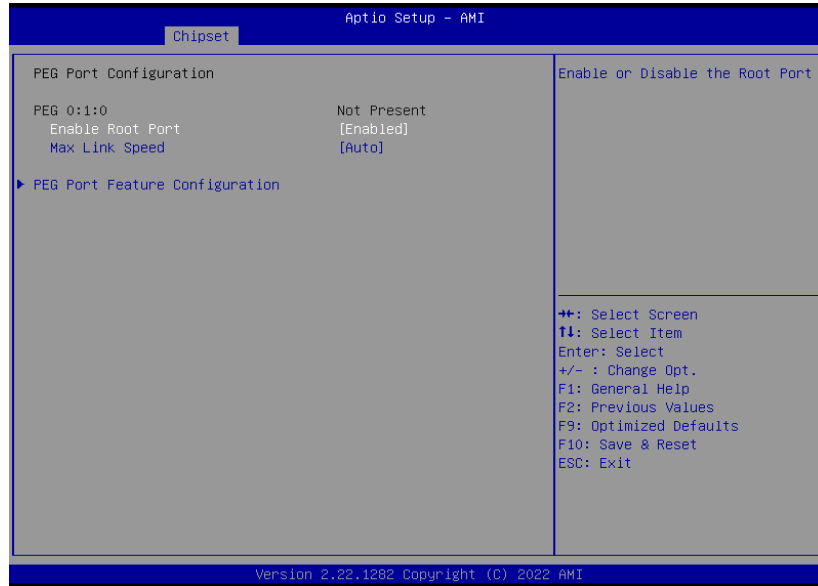

Enable Root Port

Enable/Disable the Root Port

Max Link Speed

Configure PEG 0:1:0 Max Speed

► Chipset

PEG Port Configuration ► PEG Port Feature Configuration

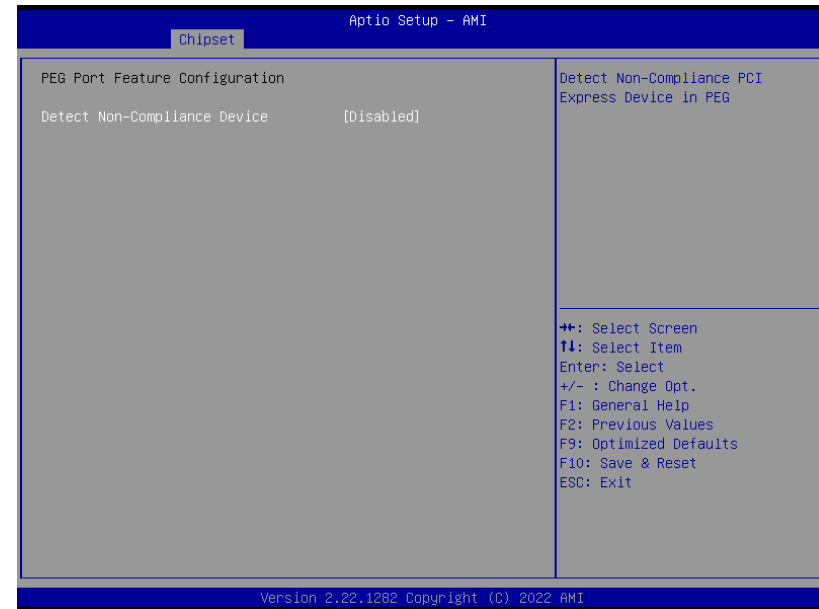

Detect Non-Compliance Device

Detect Non-Compliance PCI Express Device in PEG

PCH-IO Configuration

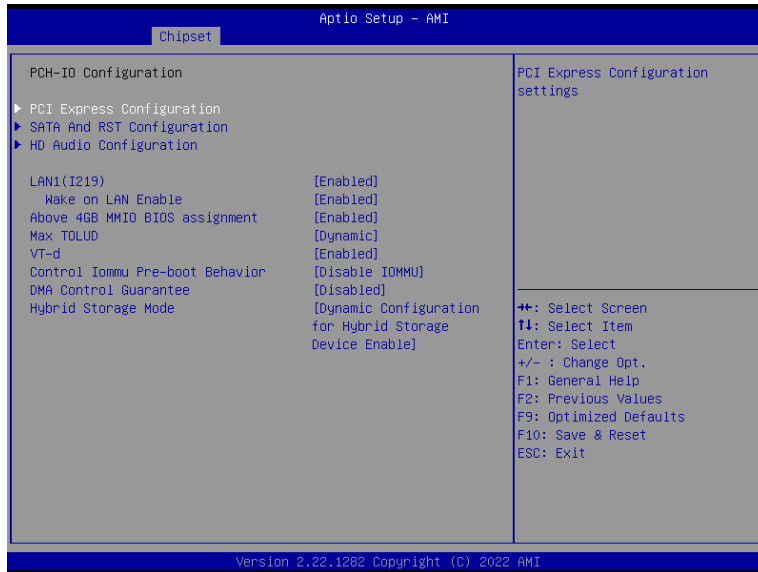

PCI Express Configuration

PCI Express Configuration Settings

SATA And RST Configuration

SATA Device Options Settings

HD Audio Configuration

HD Audio Subsystem Configuration Settings

LAN1(I219)

Enable or disable onboard NIC.

Wake on LAN Enable

Enable or disable integrated LAN to wake the system.

Above 4GB MMIO BIOS assignment

Enable/Disable above 4GB MemoryMappedIO BIOS assignment. This is enabled automatically when Aperture Size is set to 2048MB.

Max TOLUD

Assign the maximum value of Top Of Lower Usable DRAM (TOLUD). Select to specify a fixed value, or select "Dynamic" so that the assignment would adjust TOLUD automatically based on largest MMIO length of installed graphic controller.

VT-d

VT-d capability

Control Iommu Pre-boot Behavior

Enable dTBT and PCH USB topology IOMMU in Pre-boot environment (If DMAR table is installed in DXE and If VTD_INFO_PPI is installed in PEI.) TBT tree won't be included in the exception list.

DMA Control Guarantee

Enable/Disable DMA_CONTROL_GUARANTEE bit.

Hybrid Storage Mode

Select Hybrid Storage detection and configuration Mode.

► Security

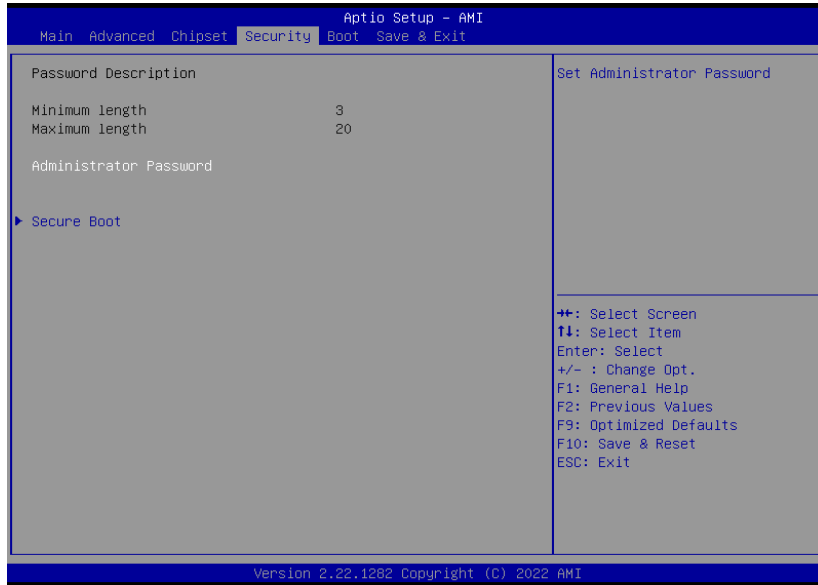

Administrator Password

Set the administrator password. To clear the password, input nothing and press enter when a new password is asked. Administrator Password will be required when entering the BIOS.

► Security

Secure Boot



Secure Boot

The Secure Boot store a database of certificates in the firmware and only allows the OSEs with authorized signatures to boot on the system. To activate Secure Boot, please make sure that "Secure Boot" is "[Enabled]", Platform Key (PK) is enrolled, "System Mode" is "User", and CSM is disabled. After enabling/disabling Secure Boot, please save the configuration and restart the system. When configured and activated correctly, the Secure Boot status will be "Active".

Secure Boot Mode

Select the secure boot mode – Standard or Custom. When set to Custom, the following fields will be configurable for the user to manually modify the key database.

Restore Factory Keys

Force system to User Mode. Load OEM-defined factory defaults of keys and databases onto the Secure Boot. Press Enter and a prompt will show up for you to confirm.

Reset To Setup Mode

Clear the database from the NVRAM, including all the keys and signatures installed in the Key Management menu. Press Enter and a prompt will show up for you to confirm.

► Boot

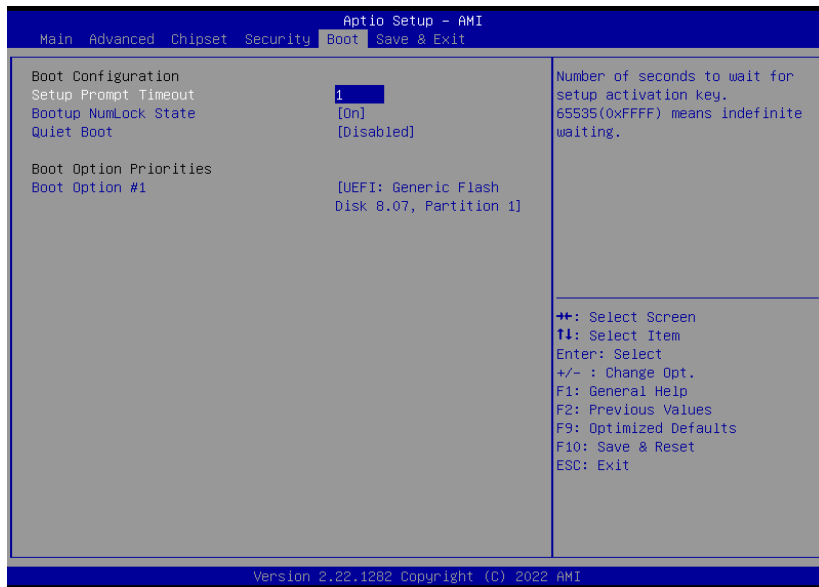

Setup Prompt Timeout

Set the number of seconds to wait for the setup activation key. 65535 (0xFFFF) denotes indefinite waiting.

Bootup NumLock State

Select the keyboard NumLock state: On or Off.

Quiet Boot

This section is used to enable or disable quiet boot option.

Boot Option Priorities

Rearrange the system boot order of available boot devices.



Note:

If “Boot option filter” of “CSM Configuration” is set to “UEFI and Legacy” or “UEFI only”, and “Quiet Boot” is set to enabled, “BGRT Logo” will show up for configuration. Refer to the Advanced > CSM Configuration submenu for more information.

► Save & Exit

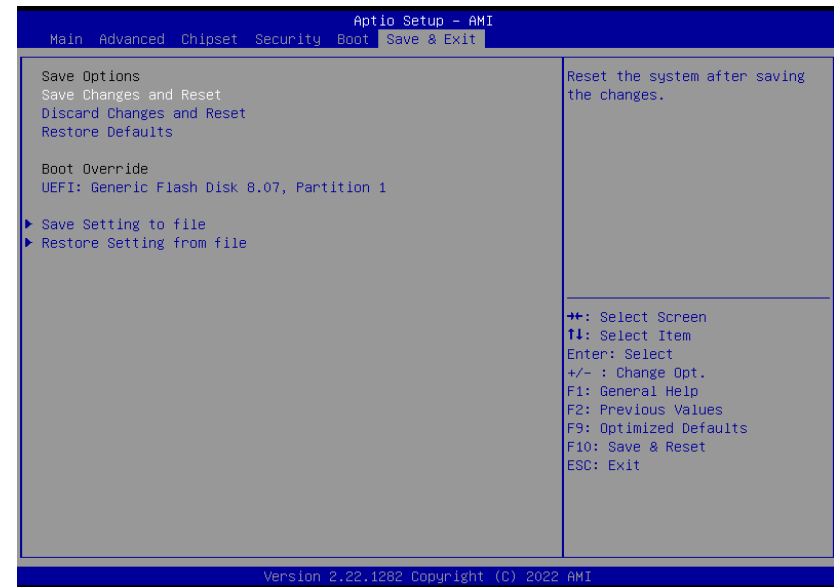

Save Changes and Reset

To save the changes, select this field and then press <Enter>. A dialog box will appear. Select Yes to reset the system after saving all changes made.

Discard Changes and Reset

To discard the changes, select this field and then press <Enter>. A dialog box will appear. Select Yes to reset the system setup without any changes.

Restore Defaults

To restore and load the optimized default values, select this field and then press <Enter>. A dialog box will appear. Select Yes to restore the default values of all the setup options.

Boot Override

Move the cursor to an available boot device and press Enter, and then the system will immediately boot from the selected boot device. The Boot Override function will only be effective for the current boot. The “Boot Option Priorities” configured in the Boot menu will not be changed.

- **Save Setting to file** Select this option to save BIOS configuration settings to a USB flash device.
- **Restore Setting from file** This field will appear only when a USB flash device is detected. Select this field to restore setting from the USB flash device.

► Updating the BIOS

To update the BIOS, you will need the new BIOS file and a flash utility. Please contact technical support or your sales representative for the files and specific instructions about how to update BIOS with the flash utility.

► Notice: BIOS SPI ROM

1. The Intel® Management Engine has already been integrated into this system board. Due to the safety concerns, the BIOS (SPI ROM) chip cannot be removed from this system board and used on another system board of the same model.
2. The BIOS (SPI ROM) on this system board must be the original equipment from the factory and cannot be used to replace one which has been utilized on other system boards.
3. If you do not follow the methods above, the Intel® Management Engine will not be updated and will cease to be effective.



Note:

- a. You can take advantage of flash tools to update the default configuration of the BIOS (SPI ROM) to the latest version anytime.
- b. When the BIOS IC needs to be replaced, you have to populate it properly onto the system board after the EEPROM programmer has been burned and follow the technical person's instructions to confirm that the MAC address should be burned or not.
- c. After updating unique MAC Address from manufacturing, NVM will be protected immediately after power cycle. Users cannot update NVM or MAC address.