

GA-IMBLAP3350

User's Manual

Rev. 1001



For more product details, please visit GIGABYTE's website.



To reduce the impacts on global warming, the packaging materials of this product are recyclable and reusable. GIGABYTE works with you to protect the environment.

Declaration of Conformity

We, Manufacturer/Importer,

G.B.T. Technology Trading GmbH

Address: **Bu**enkoppel 16, 22047 Hamburg, Germany

Declare that the product

Product Type: **Motherboard**

Product Name: **GA-IMBLAP3350**

conforms with the essential requirements of the following directives:

EMC Directive 2014/30/EU:

- | | |
|--|---------------------------|
| <input checked="" type="checkbox"/> Conduction & Radiated Emissions: | EN 55022:2010/AC2011 |
| <input checked="" type="checkbox"/> Immunity: | EN 55024:2010 |
| <input checked="" type="checkbox"/> Power-line harmonics: | EN 61000-3-2:2006+A2:2009 |
| <input checked="" type="checkbox"/> Power-line flicker: | EN 61000-3-3:2013 |

Low Voltage Directive 2014/35/EU:

- | | |
|---|--|
| <input checked="" type="checkbox"/> Safety: | EN60950-1:2006+A11:2009+A12:2011+A2:2013 |
|---|--|

RoHS Directive 2011/65/EU

- | | |
|---|--|
| <input checked="" type="checkbox"/> Restriction of use of certain substances in electronic equipment: | This product does not contain any of the restricted substances listed in Annex II, in concentrations and applications banned by the directive. |
|---|--|

CE marking



Signature: Timmy Huang

(stamp)

Date: Aug. 25, 2017

Name: Timmy Huang

DECLARATION OF CONFORMITY

Per FCC Part 2 Section 2.1077(a)



Responsible Party Name: **G.B.T. INC. (U.S.A.)**

Address: **17358 Railroad Street**

City of Industry, CA 91748

Phone/Fax No: (626) 854-9338/ (626) 854-9326

hereby declares that the product

Product Name: Motherboard

Model Number: GA-IMBLAP3350

Conforms to the following specifications:

FCC Part 15, Subpart B, Section 15.107(a) and Section 15.109 (a), Class B Digital Device

Supplementary Information:

This device complies with part 15 of the FCC Rules. Operation is subject to the following two conditions: (1) This device may not cause harmful and (2) this device must accept any interference received, including that may cause undesired operation.

Representative Person's Name: ERIC LU

Signature: Eric Lu

Date: Aug. 25, 2017

Copyright

© 2017 GIGA-BYTE TECHNOLOGY CO., LTD. All rights reserved.

The trademarks mentioned in this manual are legally registered to their respective owners.

Disclaimer

Information in this manual is protected by copyright laws and is the property of GIGABYTE.

Changes to the specifications and features in this manual may be made by GIGABYTE without prior notice.

No part of this manual may be reproduced, copied, translated, transmitted, or published in any form or by any means without GIGABYTE's prior written permission.

- In order to assist in the use of this product, carefully read the User's Manual.
- For product-related information, check on our website at: <http://www.gigabyte.com>

Identifying Your Motherboard Revision

The revision number on your motherboard looks like this: "REV: X.X." For example, "REV: 1.0" means the revision of the motherboard is 1.0. Check your motherboard revision before updating motherboard BIOS, drivers, or when looking for technical information.

Example:

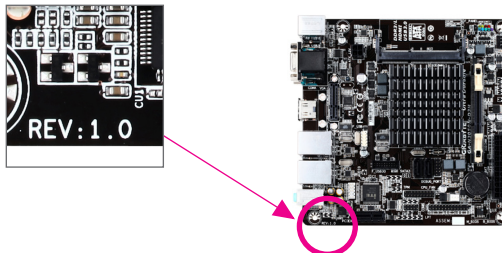
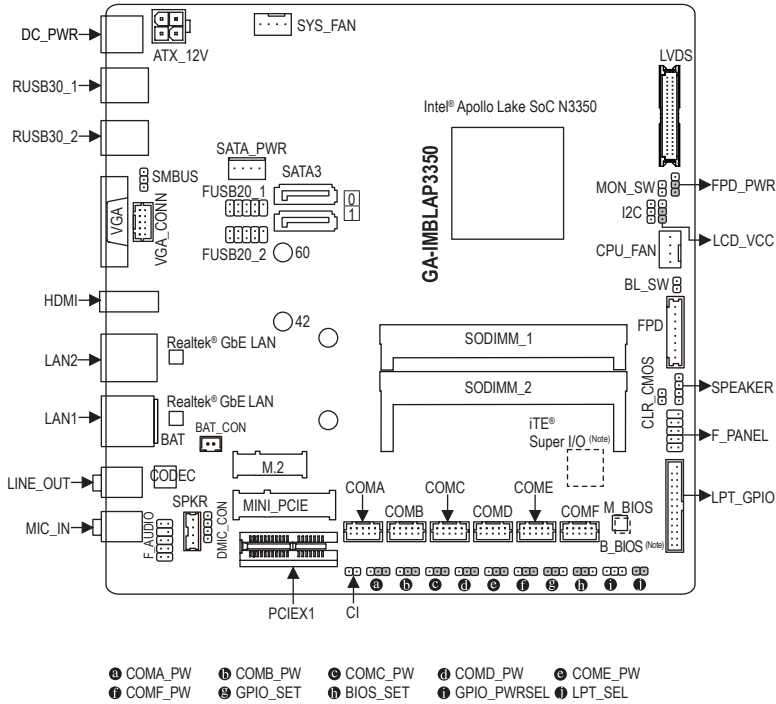

Table of Contents

GA-IMBLAP3350 Motherboard Layout.....	4
Chapter 1 Hardware Installation	5
1-1 Installation Precautions.....	5
1-2 Product Specifications.....	6
1-3 Installing the Memory.....	8
1-4 Installing an Expansion Card	8
1-5 Back Panel Connectors.....	8
1-6 Internal Connectors.....	10
Chapter 2 BIOS Setup	23
2-1 Startup Screen	23
2-2 Main	24
2-3 Advanced	25
2-4 Security	29
2-5 Boot.....	31
2-6 Save & Exit.....	33
Chapter 3 Appendix.....	34
Drivers Installation.....	34
Regulatory Statements.....	35
Contact Us	37

GA-IMBLAP3350 Motherboard Layout



(Note) This chip is on the back of the motherboard.

Box Contents

- GA-IMBLAP3350 motherboard
- Motherboard driver disk
- User's Manual
- Two SATA cables
- Two I/O Shields (high/low)
- One SATA power cable
- One COM port cable
- One LPT port cable

* The box contents above are for reference only and the actual items shall depend on the product package you obtain. The box contents are subject to change without notice.











Chapter 1 Hardware Installation









1-1 Installation Precautions

The motherboard contains numerous delicate electronic circuits and components which can become damaged as a result of electrostatic discharge (ESD). Prior to installation, carefully read the user's manual and follow these procedures:

- Prior to installation, make sure the chassis is suitable for the motherboard.
- Prior to installation, do not remove or break motherboard S/N (Serial Number) sticker or warranty sticker provided by your dealer. These stickers are required for warranty validation.
- Always remove the AC power by unplugging the power cord from the power outlet before installing or removing the motherboard or other hardware components.
- When connecting hardware components to the internal connectors on the motherboard, make sure they are connected tightly and securely.
- When handling the motherboard, avoid touching any metal leads or connectors.
- It is best to wear an electrostatic discharge (ESD) wrist strap when handling electronic components such as a motherboard, CPU or memory. If you do not have an ESD wrist strap, keep your hands dry and first touch a metal object to eliminate static electricity.
- Prior to installing the motherboard, please have it on top of an antistatic pad or within an electrostatic shielding container.
- Before connecting or unplugging the power supply cable from the motherboard, make sure the power supply has been turned off.
- Before turning on the power, make sure the power supply voltage has been set according to the local voltage standard.
- Before using the product, please verify that all cables and power connectors of your hardware components are connected.
- To prevent damage to the motherboard, do not allow screws to come in contact with the motherboard circuit or its components.
- Make sure there are no leftover screws or metal components placed on the motherboard or within the computer casing.
- Do not place the computer system on an uneven surface.
- Do not place the computer system in a high-temperature or wet environment.
- Turning on the computer power during the installation process can lead to damage to system components as well as physical harm to the user.
- If you are uncertain about any installation steps or have a problem related to the use of the product, please consult a certified computer technician.
- If you use an adapter, extension power cable, or power strip, ensure to consult with its installation and/or grounding instructions.

1-2 Product Specifications

	CPU	<ul style="list-style-type: none"> ◆ Built in with an Intel® Dual-Core Celeron® N3350 SoC (2.4 GHz) <ul style="list-style-type: none"> * Do not disassemble the onboard SoC and the heatsinks by yourself to avoid damage to these components.
	Memory	<ul style="list-style-type: none"> ◆ 2 MB Cache
	Onboard Graphics	<ul style="list-style-type: none"> ◆ 2 x DDR3L SO-DIMM socket supporting up to 16 GB of system memory ◆ Dual channel memory architecture ◆ Support for DDR3L 1866/1600 MHz memory module (Go to GIGABYTE's website for the latest supported memory speeds and memory modules.)
	Audio	<ul style="list-style-type: none"> ◆ Integrated in the SoC: <ul style="list-style-type: none"> - 1 x D-Sub port, supporting a maximum resolution of 1920x1200@60 Hz - 1 x HDMI port, supporting a maximum resolution of 3840x2160@30 Hz ◆ Maximum shared memory of 512 MB
	LAN	<ul style="list-style-type: none"> ◆ Realtek® ALC887codec ◆ High Definition Audio ◆ 2/4/5-channel
	Expansion Slots	<ul style="list-style-type: none"> ◆ 2 x Realtek® GbE LAN chips (10/100/1000 Mbit)
	Storage Interface	<ul style="list-style-type: none"> ◆ 1 x PCI Express x1 slot ◆ 1 x Mini PCIe slot (MINI_PCIE) (The PCIe Express x1 and Mini PCIe slots conform to PCI Express 2.0 standard.)
	USB	<ul style="list-style-type: none"> ◆ Integrated in the SoC: <ul style="list-style-type: none"> - 2 x SATA 6Gb/s connectors - 1 x M.2 connector (Socket 3, M key, type 2242/2260 SATA and PCIe x4/x2 SSD support) * The M.2 connector operates at up to x1 mode.
	Internal Connectors	<ul style="list-style-type: none"> - 4 x USB 3.1 Gen 1 ports on the back panel - 4 x USB 2.0/1.1 ports available through the internal USB headers
	Internal Connectors	<ul style="list-style-type: none"> ◆ 1 x 4-pin ATX 12V power connector ◆ 1 x CPU fan header ◆ 1 x system fan header ◆ 2 x SATA 6Gb/s connectors ◆ 1 x M.2 Socket 3 connector ◆ 1 x SATA power connector ◆ 1 x front panel header ◆ 1 x front panel audio header ◆ 1 x battery cable header ◆ 2 x USB 2.0/1.1 headers ◆ 6 x serial port headers ◆ 6 x serial port power select jumpers ◆ 1 x D-Sub header ◆ 1 x LVDS header ◆ 1 x LVDS drive voltage jumper (LCD_VCC) ◆ 1 x flat panel display header (FPD) ◆ 1 x flat panel display power select jumper (FPD_PWR) ◆ 1 x flat panel display switch header (MON_SW) ◆ 1 x backlight switch header (BL_SW)

 Internal Connectors	<ul style="list-style-type: none"> ◆ 1 x digital microphone header (DMIC_CON) ◆ 1 x speaker header (SPKR) ◆ 1 x buzzer header (SPEAKER) ◆ 1 x chassis intrusion jumper ◆ 1 x LPT/GPIO header (LPT_GPIO) ◆ 1 x LPT configuration jumper (LPT_SEL) ◆ 1 x GPIO power selection jumper (GPIO_PWRSEL) ◆ 1 x GPIO status configuration jumper (GPIO_SET) ◆ 1 x BIOS Select jumper (BIOS_SET) ◆ 1 x Clear CMOS jumper ◆ 1 x I2C ◆ 1 x SMBUS
 Back Panel Connectors	<ul style="list-style-type: none"> ◆ 1 x DC-In power connector ◆ 1 x HDMI port ◆ 1 x D-Sub port ◆ 4 x USB 3.1 Gen 1 ports ◆ 2 x RJ-45 ports ◆ 2 x audio jacks (Line In, Mic In)
 I/O Controller	<ul style="list-style-type: none"> ◆ iTE® I/O Controller Chip
 Hardware Monitor	<ul style="list-style-type: none"> ◆ Voltage detection ◆ Temperature detection ◆ Fan speed detection
 BIOS	<ul style="list-style-type: none"> ◆ 2 x 64 Mbit flash ◆ Use of licensed AMI UEFI BIOS ◆ PnP 1.0a, DMI 2.7, WfM 2.0, SM BIOS 2.7, ACPI 5.0
 Unique Features	<ul style="list-style-type: none"> ◆ Support for Xpress Install ◆ Support for @BIOS ◆ Support for APP Center <p>* Available applications in APP Center may vary by motherboard model. Supported functions of each application may also vary depending on motherboard specifications</p>
 Bundled Software	<ul style="list-style-type: none"> ◆ Norton® Internet Security (OEM version)
 Operating System	<ul style="list-style-type: none"> ◆ Support for Windows 10 64-bit
 Form Factor	<ul style="list-style-type: none"> ◆ Thin Mini-ITX Form Factor; 17.0cm x 17.0cm

* GIGABYTE reserves the right to make any changes to the product specifications and product-related information without prior notice.



Please visit GIGABYTE's website for support lists of CPU, memory modules, and SSDs.



Please visit the **SupportUtility List** page on GIGABYTE's website to download the latest version of apps.

1-3 Installing the Memory



Read the following guidelines before you begin to install the memory:

- Make sure that the motherboard supports the memory. It is recommended that memory of the same capacity, brand, speed, and chips be used. (Go to GIGABYTE's website for the latest supported memory speeds and memory modules.)
- Always turn off the computer and unplug the power cord from the power outlet before installing the memory to prevent hardware damage.
- Memory modules have a foolproof design. A memory module can be installed in only one direction. If you are unable to insert the memory, switch the direction.

Dual Channel Memory Configuration

This motherboard provides two memory sockets and supports Dual Channel Technology. After the memory is installed, the BIOS will automatically detect the specifications and capacity of the memory. Enabling Dual Channel memory mode will double the original memory bandwidth.

The two memory sockets are divided into two channels and each channel has one memory socket as following:

- ▶▶ Channel A: SODIMM_1
- ▶▶ Channel B: SODIMM_2

Due to CPU limitations, read the following guidelines before installing the memory in Dual Channel mode.

1. Dual Channel mode cannot be enabled if only one memory module is installed.
2. When enabling Dual Channel mode with two or four memory modules, it is recommended that memory of the same capacity, brand, speed, and chips be used.

1-4 Installing an Expansion Card



Read the following guidelines before you begin to install an expansion card:

- Make sure the motherboard supports the expansion card. Carefully read the manual that came with your expansion card.
- Always turn off the computer and unplug the power cord from the power outlet before installing an expansion card to prevent hardware damage.

1-5 Back Panel Connectors

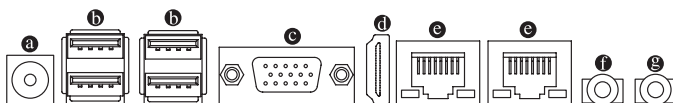

a DC In Power Connector

Connect the DC power to this port. This port supports 12V/19V/24V power adapter of up to 150w. Note: The DC power jack cannot be used with the 4-pin ATX 12V power connector simultaneously as a source of power input.

b USB 3.1 Gen 1 Port

The USB 3.1 Gen 1 port supports the USB 3.1 Gen 1 specification and is compatible to the USB 2.0 specification. Use this port for USB devices.

c D-Sub Port

The D-Sub port supports a 15-pin D-Sub connector and supports a maximum resolution of 1920x1200@60 Hz (the actual resolutions supported depend on the monitor being used). Connect a monitor that supports D-Sub connection to this port.

④ HDMI Port

HDMI[™] HIGH-DEFINITION MULTIMEDIA INTERFACE The HDMI port is HDCP compliant and supports Dolby TrueHD and DTS HD Master Audio formats. It also supports up to 192KHz/24bit 8-channel LPCM audio output. You can use this port to connect your HDMI-supported monitor. The maximum supported resolution is 3840x2160@30 Hz, but the actual resolutions supported are dependent on the monitor being used.



After installing the HDMI device, make sure to set the default sound playback device to HDMI. (The item name may differ depending on your operating system.)

Dual-Display Configurations for the Onboard Graphics:

Dual-display configurations are supported after you install motherboard drivers in OS.

⑤ RJ-45 LAN Port

The Gigabit Ethernet LAN port provides Internet connection at up to 1 Gbps data rate. The following describes the states of the LAN port LEDs.

LAN Port	
	
Activity LED	Connection/Speed LED

Connection/Speed LED:	
State	Description
Orange	1 Gbps data rate
Green	100 Mbps data rate
Off	10 Mbps data rate

Activity LED:	
State	Description
Blinking	Data transmission or receiving is occurring
Off	No data transmission or receiving is occurring

⑥ Line Out

The line out jack. Use this audio jack for a headphone or 2-channel speaker. This jack can be used to connect front speakers in a 4/5.1-channel audio configuration.

⑦ Mic In

The Mic in jack.



Please visit GIGABYTE's website for more software information.



- When removing the cable connected to a back panel connector, first remove the cable from your device and then remove it from the motherboard.
- When removing the cable, pull it straight out from the connector. Do not rock it side to side to prevent an electrical short inside the cable connector.

1-6 Internal Connectors

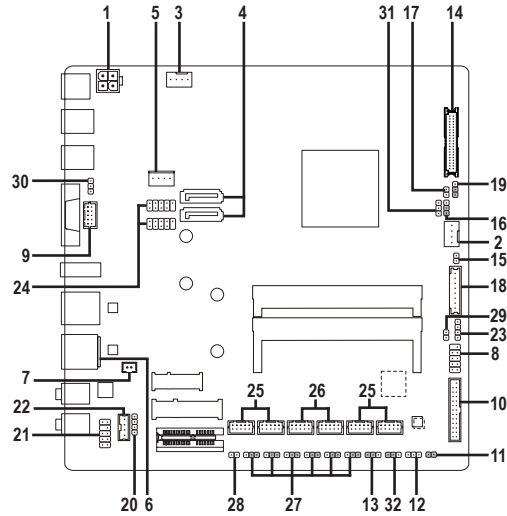

1) ATX_12V	17) MON_SW
2) CPU_FAN	18) FPD
3) SYS_FAN	19) FPD_PWR
4) SATA3_0/1	20) DMIC_CON
5) SATA_PWR	21) F_AUDIO
6) BAT	22) SPKR
7) BAT_CON	23) SPEAKER
8) F_PANEL	24) FUSB20_1/FUSB20_2
9) VGA_CONN	25) COMA/COMB/COME/COMF
10) LPT_GPIO	26) COMC/COMD
11) LPT_SEL	27) COMA/B/C/D/E/F_PW
12) GPIO_PWRSEL	28) CI
13) GPIO_SET	29) CLR_CMOS
14) LVDS	30) SMBUS
15) BL_SW	31) I2C
16) LCD_VCC	32) BIOS_SET



Read the following guidelines before connecting external devices:

- First make sure your devices are compliant with the connectors you wish to connect.
- Before installing the devices, be sure to turn off the devices and your computer. Unplug the power cord from the power outlet to prevent damage to the devices.
- After installing the device and before turning on the computer, make sure the device cable has been securely attached to the connector on the motherboard.

1) ATX_12V (2x2 12V Power Connector)

This connector can be used to input power when the DC power jack on the rear panel is not connected. However, if the DC power jack is connected, this connector can only be used to output power.

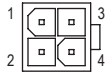

When used to input power:

Pin No.	Definition
1	GND
2	GND
3	+12V
4	+12V

When used to output power:

Pin No.	Definition
1	GND
2	GND
3	DC_OUT
4	DC_OUT



Note: The two connectors cannot be used simultaneously as a source of power input.

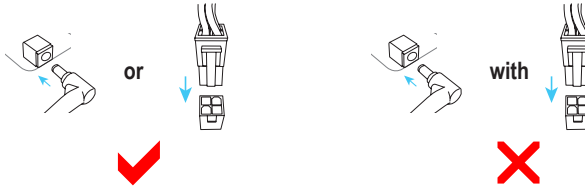

2/3) CPU_FAN/SYS_FAN (Fan Headers)

The fan headers on this motherboard are 4-pin. Most fan headers possess a foolproof insertion design. When connecting a fan cable, be sure to connect it in the correct orientation (the black connector wire is the ground wire). The speed control function requires the use of a fan with fan speed control design. For optimum heat dissipation, it is recommended that a system fan be installed inside the chassis.

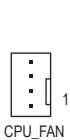

CPU_FAN:

Pin No.	Definition
1	GND
2	+12V
3	Sense
4	Speed Control



SYS_FAN:

Pin No.	Definition
1	GND
2	Speed Control
3	Sense
4	VCC



- Be sure to connect fan cables to the fan headers to prevent your CPU and system from overheating. Overheating may result in damage to the CPU or the system may hang.
- These fan headers are not configuration jumper blocks. Do not place a jumper cap on the headers.

4) SATA3 0/1 (SATA 6Gb/s Connectors)

The SATA connectors conform to SATA 6Gb/s standard and are compatible with SATA 3Gb/s and SATA 1.5Gb/s standard. Each SATA connector supports a single SATA device.

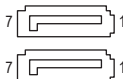

Pin No.	Definition
1	GND
2	TXP
3	TXN
4	GND
5	RXN
6	RXP
7	GND

5) SATA_PWR (SATA Power Connector)

This connector provides power to installed SATA devices.

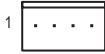

Pin No.	Definition
1	VCC
2	GND
3	GND
4	+12V

6) BAT (Battery)

The battery provides power to keep the values (such as BIOS configurations, date, and time information) in the CMOS when the computer is turned off. Replace the battery when the battery voltage drops to a low level, or the CMOS values may not be accurate or may be lost.

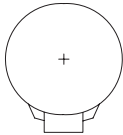

You may clear the CMOS values by removing the battery cable:

1. Turn off your computer and unplug the power cord.
2. Unplug the the battery cable from the battery cable header and wait for one minute.
3. Plug in the battery cable.
4. Plug in the power cord and restart your computer.



- Always turn off your computer and unplug the power cord before replacing the battery.
- Replace the battery with an equivalent one. Damage to your devices if the battery is replaced with an incorrect model.
- Contact the place of purchase or local dealer if you are not able to replace the battery by yourself or uncertain about the battery model.
- When installing the battery, note the orientation of the positive side (+) and the negative side (-) of the battery (the positive side should face up).
- Used batteries must be handled in accordance with local environmental regulations.

7) BAT_CON (Battery Cable Header)



Pin No.	Definition
1	RTC Power
2	GND

8) F_PANEL (Front Panel Header)

Connect the power switch, reset switch, and system status indicator on the chassis to this header according to the pin assignments below. Note the positive and negative pins before connecting the cables.

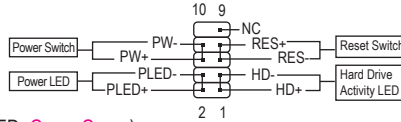

- **PLED** (Power LED, **Grass Green**):

System Status	LED
S0	On
S3/S4/S5	Off

Connects to the power status indicator on the chassis front panel. The LED is on when the system is operating. The LED is off when the system is in S3/S4 sleep state or powered off (S5).

- **PW** (Power Switch, **Red**):

Connects to the power switch on the chassis front panel. You may configure the way to turn off your system using the power switch (refer to Chapter 2, "BIOS Setup," "Power," for more information).

- **HD** (Hard Drive Activity LED, **Blue**):

Connects to the hard drive activity LED on the chassis front panel. The LED is on when the hard drive is reading or writing data.

- **RES** (Reset Switch, **Lake Green**):

Connects to the reset switch on the chassis front panel. Press the reset switch to restart the computer if the computer freezes and fails to perform a normal restart.

- **NC** (Purple):

No connection.



The front panel design may differ by chassis. A front panel module mainly consists of power switch, reset switch, power LED, hard drive activity LED and etc. When connecting your chassis front panel module to this header, make sure the wire assignments and the pin assignments are matched correctly.

9) VGA_CONN (D-Sub Header)

This header can be used to connect a D-Sub monitor by an adapter.

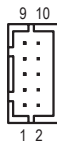

Pin No.	Definition	Pin No.	Definition
1	VGA_R	6	GND
2	GND	7	HSYNC
3	VGA_G	8	VSYNC
4	GND	9	VGA_SCL
5	VGA_B	10	VGA_SDA

10) LPT_GPIO (LPT/GPIO Header)

Use this header to connect a LPT or GPIO device. Refer to the descriptions of the LPT_SEL and GPIO_PWRSEL jumpers below for further configuration.



LPT:

Pin No.	Definition	Pin No.	Definition	Pin No.	Definition
1	STB-	10	GND	19	ACK-
2	AFD-	11	PD4	20	GND
3	PD0	12	GND	21	BUSY
4	ERR-	13	PD5	22	GND
5	PD1	14	GND	23	PE
6	INIT-	15	PD6	24	GND
7	PD2	16	GND	25	SLCT
8	SLIN-	17	PD7	26	No Pin
9	PD3	18	GND		

GPIO:

Pin No.	Definition	Pin No.	Definition	Pin No.	Definition
1	SIO_GP87	10	GPIOPWR	19	SIO_GP83
2	SIO_GP86	11	SIO_GP74	20	GND
3	SIO_GP70	12	GPIOPWR	21	SIO_GP82
4	NC	13	SIO_GP75	22	GND
5	SIO_GP71	14	GND	23	SIO_GP81
6	SIO_GP85	15	SIO_GP76	24	GND
7	SIO_GP72	16	GND	25	SIO_GP80
8	SIO_GP84	17	SIO_GP77	26	No Pin
9	SIO_GP73	18	GND		

11) LPT_SEL (LPT Configuration Jumper)

Place the jumper cap on the two pins to configure the LPT_GPIO header to support LPT device. Note: If the jumper cap is removed from this jumper, be sure to place it on the GPIO_PWRSEL pins.



Short: Configure the LPT_GPIO header to support LPT device. (Default)

12) GPIO_PWRSEL (GPIO Power Selection Jumper)

Move the jumper cap from the LPT_SEL jumper to this jumper to configure the LPT_GPIO header to support GPIO device and also to specify the GPIO voltage.



1-2 Close: Set GPIO voltage to +12V.



2-3 Close: Set GPIO voltage to 5V.

13) GPIO_SET (GPIO Status Configuration Jumper)

Use this jumper to set the GPIO status of the LPT_GPIO header to HIGH or LOW.

1  1-2 Close: Set to HIGH level (3V) (Default)

1  2-3 Close: Set to LOW level.

14) LVDS (LVDS Header)

LVDS stands for Low-voltage differential signaling, which uses high-speed analog circuit techniques to provide multigigabit data transfers on copper interconnects and is a generic interface standard for high-speed data transmission.

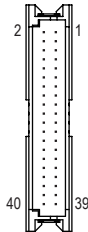

Pin No.	Definition	Pin No.	Definition
1	LCD_VCC	21	-RXE0_C
2	LCD_VCC	22	+RXE0_C
3	VCC3	23	GND
4	NC	24	-RXE1_C
5	NC	25	+RXE1_C
6	-RXO0_C	26	GND
7	+RXO0_C	27	-RXE2_C
8	GND	28	+RXE2_C
9	-RXO1_C	29	CABLE_DET ^(Note)
10	+RXO1_C	30	-RXE3_C
11	GND	31	+RXE3_C
12	-RXO2_C	32	GND
13	+RXO2_C	33	-RXECLKE_C
14	GND	34	+RXECLKE_C
15	-RXO3_C	35	GND
16	+RXO3_C	36	SC_BKLT_EN
17	GND	37	SC_BKLT_CTL
18	-RXECLKO_C	38	FPD_PWR
19	+RXECLKO_C	39	FPD_PWR
20	GND	40	FPD_PWR

(Note) Connects to Pin 29 and the ground pin of the LVDS.

15) BL_SW (Back Light Switch)

The Back Light switch provides the function for screen back light adjustment.



Pin No.	Definition
1	BL_DOWN
2	BL_UP

16) LCD_VCC (LVDS Drive Voltage Jumper)

This jumper can be used to provide different screen voltage settings.



1-2 Close: Set to 3V. (Default setting)



2-3 Close: Set to 5V.

17) MON_SW (Flat Panel Display Switch Header)

This header allows you to connect an on/off switch for the display.



Pin No.	Definition
1	Mon_SW
2	GND

18) FPD (Flat Panel Display Header)

The FPD is a high-speed interface connecting the output of a video controller in a laptop computer, computer monitor or LCD television set to the display panel. Most laptops, LCD computer monitors and LCD TVs use this interface internally. The header conforms to FPD specification.



Pin No.	Definition
1	BKLT_EN
2	BKLT_PWM
3	BKLT_PWR (FPD_PWR)
4	BKLT_PWR (FPD_PWR)
5	BKLT_GND/Brightness_GND
6	BKLT_GND/Brightness_GND
7	Brightness_Up
8	Brightness_Down

19) FPD_PWR (Flat Panel Display Power Select Jumper)

The power select jumper can be used to select the working voltage of the flat panel display. Make use your flat panel display supports DC In power. If not, use a DC In power adapter that meets the voltage requirements of your flat panel display.



1-2 Close: Set to 12V. (Default setting)



2-3 Close: Set to DC In.

20) DMIC_CON (Digital Microphone Header)

This header can be used to connect a digital microphone.



Pin No.	Definition
1	VCC
2	DMIC_DATA
3	GND
4	DMIC_CLK

21) F_AUDIO (Front Panel Audio Header)

The front panel audio header supports Intel® High Definition audio (HD). You may connect your chassis front panel audio module to this header. Make sure the wire assignments of the module connector match the pin assignments of the motherboard header. Incorrect connection between the module connector and the motherboard header will make the device unable to work or even damage it.



Pin No.	Definition
1	MIC2_L
2	GND
3	MIC2_R
4	NC
5	LINE2_R
6	Sense
7	FAUDIO_JD
8	No Pin
9	LINE2_L
10	Sense



Some chassis provide a front panel audio module that has separated connectors on each wire instead of a single plug. For information about connecting the front panel audio module that has different wire assignments, please contact the chassis manufacturer.

22) SPKR (Speaker Header)

This header connects to the L/R Audio output of the motherboard and supports 3W stereo speaker (4 Ohm) in an AIO chassis.



Pin No.	Definition
1	Speaker OUT R-
2	Speaker OUT R+
3	Speaker OUT L-
4	Speaker OUT L+

23) SPEAKER (Buzzer Header)

Connects to the buzzer on the chassis front panel. The system reports system startup status by issuing a beep code. One single short beep will be heard if no problem is detected at system startup.



Pin No.	Definition
1	VCC
2	NC
3	NC
4	SPK-

24) FUSB20_1/FUSB20_2 (USB 2.0/1.1 Headers)

The headers conform to USB 2.0/1.1 specification. Each USB header can provide two USB ports via an optional USB bracket. For purchasing the optional USB bracket, please contact the local dealer.



Pin No.	Definition	Pin No.	Definition
1	Power (5V)	6	USB DY+
2	Power (5V)	7	GND
3	USB DX-	8	GND
4	USB DY-	9	No Pin
5	USB DX+	10	NC



- Do not plug the IEEE 1394 bracket (2x5-pin) cable into the USB header.
- Prior to installing the USB bracket, be sure to turn off your computer and unplug the power cord from the power outlet to prevent damage to the USB bracket.

25) COMA/COMB/COME/COMF (Serial Port Headers)

Each COM header can provide one serial port via an optional COM port cable. For purchasing the optional COM port cable, please contact the local dealer.



RS232 device:

Pin No.	Definition
1	NDCD-
2	NDSR-
3	NSIN
4	NRTS-
5	NSOUT
6	NCTS-
7	NDTR-
8	+5V/+12V
9	GND
10	NC

26) COMC/COMD (Serial Port Headers)

Each COM header can provide one serial port via an optional COM port cable. For purchasing the optional COM port cable, please contact the local dealer. The two headers support RS232, RS422, and RS485 devices.



RS232 device:

Pin No.	Definition
1	NDCD-
2	NDSR-
3	NSIN
4	NRTS-
5	NSOUT
6	NCTS-
7	NDTR-
8	+5V/+12V
9	GND
10	NC

RS422 device:

Pin No.	Definition
1	TX(B)
2	NC
3	TX(A)
4	NC
5	RX(A)
6	NC
7	RX(B)
8	+5V/+12V
9	GND
10	NC

RS485 device:

Pin No.	Definition
1	D-
2	NC
3	D+
4	NC
5	NC
6	NC
7	NC
8	+5V/+12V
9	GND
10	NC

27) COMA_PW/COMB_PW/COMC_PW/COMD_PW/COME_PW/COMF_PW (Serial Port Header Power Select Jumpers)

The power select jumpers are used to select serial port power.

1  1-2 Close: Set to 12V.

1  2-3 Close: Set to 5V. (Default setting)

28) CI (Chassis Intrusion Header)

This motherboard provides a chassis detection feature that detects if the chassis cover has been removed. This function requires a chassis with chassis intrusion detection design.



Pin No.	Definition
1	Signal
2	GND

29) CLR_CMOS (Clear CMOS Jumper)

Use this jumper to clear the BIOS configuration and reset the CMOS values to factory defaults. To clear the CMOS values, use a metal object like a screwdriver to touch the two pins for a few seconds.



Open: Normal



Short: Clear CMOS Values



- Always turn off your computer and unplug the power cord from the power outlet before clearing the CMOS values.
- After system restart, go to BIOS Setup to load factory defaults (select Load Optimized Defaults) or manually configure the BIOS settings.

30) SMBUS (System Management Bus)



Pin No.	Definition
1	SMB_CLK
2	SMB_DATA
3	GND

31) I2C (Inter-Integrated Circuit)



Pin No.	Definition
1	I2C_SCL
2	I2C_SDA
3	GND

32) BIOS_SET (BIOS Select Jumper)

The jumper allows users to easily select a different BIOS for boot up.

1  1-2 Close: M_BIOS (Boot from the main BIOS)

1  2-3 Close: B_BIOS (Boot from the backup BIOS)

Chapter 2 BIOS Setup

BIOS (Basic Input and Output System) records hardware parameters of the system in the CMOS on the motherboard. Its major functions include conducting the Power-On Self-Test (POST) during system startup, saving system parameters and loading operating system, etc. BIOS includes a BIOS Setup program that allows the user to modify basic system configuration settings or to activate certain system features.

When the power is turned off, the battery on the motherboard supplies the necessary power to the CMOS to keep the configuration values in the CMOS.

To access the BIOS Setup program, press the <Delete> key during the POST when the power is turned on.

To upgrade the BIOS, use the GIGABYTE @BIOS utility, which is a Windows-based utility that searches and downloads the latest version of BIOS from the Internet and updates the BIOS.



- Because BIOS flashing is potentially risky, if you do not encounter problems using the current version of BIOS, it is recommended that you not flash the BIOS. To flash the BIOS, do it with caution. Inadequate BIOS flashing may result in system malfunction.
- It is recommended that you not alter the default settings (unless you need to) to prevent system instability or other unexpected results. Inadequately altering the settings may result in system's failure to boot. If this occurs, try to clear the CMOS values and reset the board to default values. (Refer to the "Load Optimized Defaults" section in this chapter or introductions of the battery/clear CMOS jumper in Chapter 1 for how to clear the CMOS values.)

2-1 Startup Screen

The following startup Logo screen will appear when the computer boots.



2-2 Main

Once you enter the BIOS Setup program, the Main Menu (as shown below) appears on the screen. Use arrow keys to move among the items and press <Enter> to accept or enter a sub-menu.

Main Menu Help

The on-screen description of a highlighted setup option is displayed on the bottom line of the Main Menu.

Submenu Help

While in a submenu, press <F1> to display a help screen (General Help) of function keys available for the menu. Press <Esc> to exit the help screen. Help for each item is in the Item Help block on the right side of the submenu.

(Sample BIOS Version: D11)



- When the system is not stable as usual, select the **Load Optimized Defaults** item to set your system to its defaults.
- The BIOS Setup menus described in this chapter are for reference only and may differ by BIOS version.

Aptio Setup Utility - Copyright (C) 2017 American Megatrends, Inc.				
Main	Advanced	Security	Boot	Save & Exit
BIOS Information		American Megatreds		
BIOS Vendor		D2		
BIOS Version		07/24/2017 14:43:10		
Build Date and Time		Administrator		
Access Level		IMBLAP3350		
Project Name		8A0AAG09		
BIOS ID				
Memory Information				
Total Memory		8192 MB		
Memory Speed		1600 MHz		
System Language		[English]		→ ←: Select Screen
System Date		[Mon 04/24/2017]		↑ ↓: Select Item
System Time		[11:35:04]		Enter: Select
				+/-: Change Opt.
				F1: General Help
				F2: Previous Values
				F3: Optimized Defaults
				F4: Save & Exit
				ESC: Exit

This section provides information on your motherboard model and BIOS version. You can also select the default language used by the BIOS and manually set the system time.

☞ Access Level

Displays the current access level depending on the type of password protection used. (If no password is set, the default will display as **Administrator**.) The Administrator level allows you to make changes to all BIOS settings; the User level only allows you to make changes to certain BIOS settings but not all.

☞ System Language

Selects the default language used by the BIOS.

☞ System Date

Sets the system date. The date format is week (read-only), month, date, and year. Use <Tab> to switch between the Month, Date, and Year fields and use the <+> or <-> key to set the desired value.

☞ System Time

Sets the system time. The time format is hour, minute, and second. For example, 1 p.m. is 13:00:00. Use <Tab> to switch between the Hour, Minute, and Second fields and use the <+> or <-> key to set the desired value.

2-3 Advanced

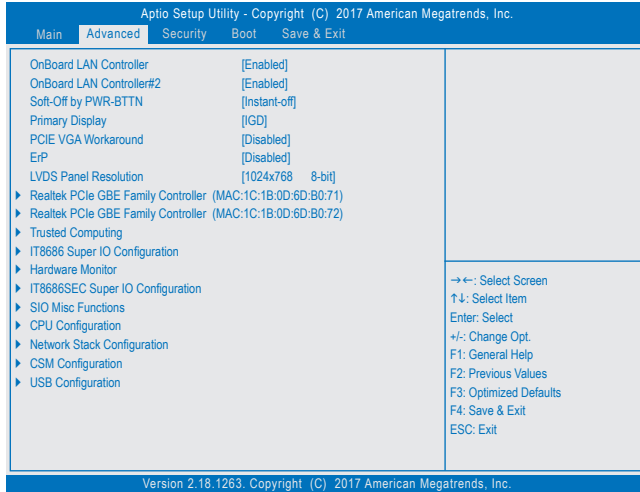

- ☞ **OnBoard LAN Controller (LAN1)**
 Enables or disables the onboard LAN function. (Default: Enabled)
 If you wish to install a 3rd party add-in network card instead of using the onboard LAN, set this item to **Disabled**.
- ☞ **OnBoard LAN Controller#2 (LAN2)**
 Enables or disables the onboard LAN function. (Default: Enabled)
 If you wish to install a 3rd party add-in network card instead of using the onboard LAN, set this item to **Disabled**.
- ☞ **Soft-Off by PWR-BTTN**
 Configures the way to turn off the computer in MS-DOS mode using the power button.

 - ▶▶ Instant-Off Press the power button and then the system will be turned off instantly. (Default)
 - ▶▶ Delay 4 Sec. Press and hold the power button for 4 seconds to turn off the system. If the power button is pressed for less than 4 seconds, the system will enter suspend mode.
- ☞ **Primary Display**
 Specifies the first initiation of the monitor display from the installed PCI graphics card or the onboard graphics.

 - ▶▶ IGD Sets the onboard graphics as the first display. (Default)
 - ▶▶ PCIe Sets the graphics card on the PCIe slot as the first display.
- ☞ **PCIE VGA Workaround**
 Allows you to increase the compatibility of the PCIe graphics card. (Default: Disabled)
- ☞ **ErP**
 Determines whether to let the system consume least power in S5 (shutdown) state. (Default: Disabled)
 Note: When this item is set to **Enabled**, the following functions will become unavailable: Resume by Alarm, PME event wake up, power on by mouse, power on by keyboard, and wake on LAN.
- ☞ **LVDS Panel Resolution**
 Allows you to set LVDS resolution and bit rate.
- ▶ **Realtek PCIe GBE Family Controller**
 This sub-menu provides information on LAN configuration and related configuration options.

▶ **Realtek PCIe GBE Family Controller**

This sub-menu provides information on LAN configuration and related configuration options.

▶ **Trusted Computing**

Enables or disables Trusted Platform Module (TPM).

▶ **IT8686 Super IO Configuration**

This section provides information on the super I/O chip and allows you to configure the parallel port.

▶ **Hardware Monitor**

☞ **CPU Temperature/System Temperature**

Displays current CPU/system temperature.

☞ **System Fan Speed**

Displays current system fan speeds.

☞ **VCCGI/VCC3/+12V/VCC/Vnn/DDR_VDDQ**

Displays the current system voltages.

▶ **IT8686SEC Super IO Configuration**

This section provides information on the super I/O chip and allows you to configure the serial port.

▶ **SIO Misc Functions**

☞ **AC BACK**

Determines the state of the system after the return of power from an AC power loss.

▶▶ Memory The system returns to its last known awake state upon the return of the AC power.

▶▶ Always On The system is turned on upon the return of the AC power.

▶▶ Always Off The system stays off upon the return of the AC power. (Default)

☞ **Case Open**

Displays the detection status of the chassis intrusion detection device attached to the motherboard CI header. If the system chassis cover is removed, this field will show "Open", otherwise it will show "Close." To clear the chassis intrusion status record, set **Reset Case Open Status** to **Enabled**, save the settings to the CMOS, and then restart your system.

☞ **Reset Case Open Status**

▶▶ Disabled Keeps or clears the record of previous chassis intrusion status. (Default)

▶▶ Enabled Clears the record of previous chassis intrusion status and the **Case Open** field will show "No" at next boot.

☞ **Case intrusion Prompt**

Allows you to determine whether to display chassis intrusion notification at system startup. (Default: Disabled)

▶ **CPU Configuration**

▶ **CPU Power Management**

☞ **EIST**

Enables or disables Enhanced Intel® Speed Step Technology (EIST). Depending on CPU loading, Intel® EIST technology can dynamically and effectively lower the CPU voltage and core frequency to decrease average power consumption and heat production. **Auto** lets the BIOS automatically configure this setting. (Default: Enabled)

☞ **Turbo Mode**

Allows you to determine whether to enable the Intel® CPU Turbo Boost technology. (Default: Enabled)

☞ **C-States**

Enables or disables support for C-States. (Default: Enabled)

☞ **Enhanced C-states**

Allows you to determine whether to let the CPU enter C states. When enabled, the CPU core frequency will be reduced during system halt state to decrease power consumption. This item is configurable only when **C-States** is enabled. (Default: Enabled)

☞ **Active Processor Cores**

Allows you to select the number of CPU cores to enable. (Default: Disabled)

☞ **Intel Virtualization Technology**

Enables or disables Intel® Virtualization Technology. Virtualization enhanced by Intel® Virtualization Technology will allow a platform to run multiple operating systems and applications in independent partitions. With virtualization, one computer system can function as multiple virtual systems. (Default: Enabled)

☞ **VT-d**

Enables or disables Intel® Virtualization Technology for Directed I/O. (Default: Disabled)

▶ **Network Stack Configuration**

☞ **Network Stack**

Disables or enables booting from the network to install a GPT format OS, such as installing the OS from the Windows Deployment Services server. (Default: Disabled)

☞ **IPv4 PXE Support**

Enables or disables IPv4 PXE Support. This item is configurable only when **Network Stack** is enabled.

☞ **IPv4 HTTP Support**

Enables or disables HTTP boot support for IPv4. This item is configurable only when **Network Stack** is enabled.

☞ **IPv6 PXE Support**

Enables or disables IPv6 PXE Support. This item is configurable only when **Network Stack** is enabled.

☞ **IPv6 HTTP Support**

Enables or disables HTTP boot support for IPv6. This item is configurable only when **Network Stack** is enabled.

☞ **PXE boot wait time**

Allows you to configure how long to wait before you can press <Esc> to abort the PXE boot. This item is configurable only when **Network Stack** is enabled. (Default: 0)

☞ **Media detect count**

Allows you to set the number of times to check the presence of media. This item is configurable only when **Network Stack** is enabled. (Default: 1)

▶ **CSM Configuration**

☞ **CSM Support**

Enables or disables UEFI CSM (Compatibility Support Module) to support a legacy PC boot process.

▶▶ Enabled Enables UEFI CSM. (Default)

▶▶ Disabled Disables UEFI CSM and supports UEFI BIOS boot process only.

☞ **Network**

Allows you to select whether to enable the UEFI or legacy option ROM for the LAN controller.

▶▶ Do not launch Disables option ROM.

- ▶▶ UEFI Enables UEFI option ROM only. (Default)
- ▶▶ Legacy Enables legacy option ROM only.

This item is configurable only when **CSM Support** is set to **Enabled**.

☞ **Storage**

Allows you to select whether to enable the UEFI or legacy option ROM for the storage device controller.

- ▶▶ Do not launch Disables option ROM.
- ▶▶ UEFI Enables UEFI option ROM only. (Default)
- ▶▶ Legacy Enables legacy option ROM only.

This item is configurable only when **CSM Support** is set to **Enabled**.

☞ **Video**

Allows you to select whether to enable the UEFI or legacy option ROM for the graphics controller.

- ▶▶ Do not launch Disables option ROM.
- ▶▶ UEFI Enables UEFI option ROM only. (Default)
- ▶▶ Legacy Enables legacy option ROM only.

This item is configurable only when **CSM Support** is set to **Enabled**.

☞ **Other PCI devices**

Allows you to select whether to enable the UEFI or Legacy option ROM for the PCI device controller other than the LAN, storage device, and graphics controllers.

- ▶▶ Do not launch Disables option ROM.
- ▶▶ UEFI Enables UEFI option ROM only. (Default)
- ▶▶ Legacy Enables legacy option ROM only.

This item is configurable only when **CSM Support** is set to **Enabled**.

▶ **USB Configuration**

☞ **Onboard USB Feature**

Enables or disables the onboard USB function. (Default: Enabled)

☞ **Legacy USB Support**

Allows USB keyboard/mouse to be used in MS-DOS. (Default: Enabled)

☞ **XHCI Hand-off**

Determines whether to enable XHCI Hand-off feature for an operating system without XHCI Hand-off support. (Default: Enabled)

☞ **USB Mass Storage Driver Support**

Enables or disables support for USB storage devices. (Default: Enabled)

☞ **Mass Storage Devices**

Displays a list of connected USB mass storage devices. This item appears only when a USB storage device is installed.

2-4 Security

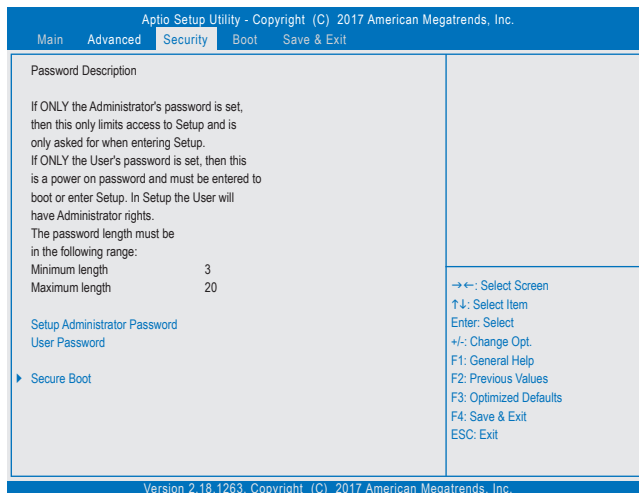

🔑 Setup Administrator Password

Allows you to configure an administrator password. Press <Enter> on this item, type the password, and then press <Enter>. You will be requested to confirm the password. Type the password again and press <Enter>. You must enter the administrator password (or user password) at system startup and when entering BIOS Setup. Differing from the user password, the administrator password allows you to make changes to all BIOS settings.

🔑 User Password

Allows you to configure a user password. Press <Enter> on this item, type the password, and then press <Enter>. You will be requested to confirm the password. Type the password again and press <Enter>. You must enter the administrator password (or user password) at system startup and when entering BIOS Setup. However, the user password only allows you to make changes to certain BIOS settings but not all. To cancel the password, press <Enter> on the password item and when requested for the password, enter the correct one first. When prompted for a new password, press <Enter> without entering any password. Press <Enter> again when prompted to confirm.

NOTE: Before setting the User Password, be sure to set the Administrator Password first.

🔑 HDD Security Configuration

Displays a list of connected hard drives and allows you to set a password for a specific hard drive. This item appears only when a hard drive is installed.

▶ Secure Boot

🔑 System Mode

Displays the current system mode.

🔑 Secure Boot

Displays the current secure boot state.

🔑 Vendor Keys

Displays the vendor keys.

☞ **Attempt Secure Boot**

Enables or disables the secure boot function. Secure Boot requires all the applications that are running during the booting process to be pre-signed with valid digital certificates. This way, the system knows all the files being loaded before Windows 8 loads and gets to the login screen have not been tampered with. (Default: Disabled)

☞ **Secure Boot Mode**

Allows you to configure the secure boot mode. (Default: Customized)

▶ **Key Management**

This section provides you with configuration options for secure boot key management.

2-5 Boot

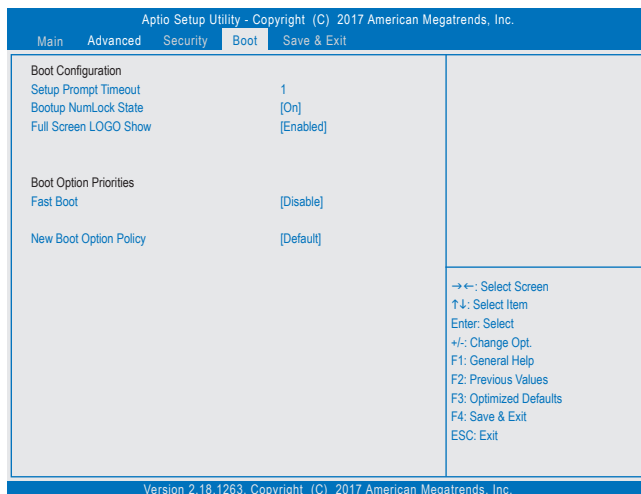

- ☞ **Setup Prompt Timeout**
Allows you to configure the number of seconds to stay in BIOS setup prompt screen. (Default: 1)
- ☞ **Bootup NumLock State**
Enables or disables Numlock feature on the numeric keypad of the keyboard after the POST. (Default: On)
- ☞ **Full Screen LOGO Show**
Allows you to determine whether to display the GIGABYTE Logo at system startup. **Disabled** skips the GIGABYTE Logo when the system starts up. (Default: Enabled)
- ☞ **Boot Option Priorities #1/2**
Specifies the overall boot order from the available devices.
Removable storage devices that support GPT format will be prefixed with "UEFI:" string on the boot device list. To boot from an operating system that supports GPT partitioning, select the device prefixed with "UEFI:" string.
Or if you want to install an operating system that supports GPT partitioning such as Windows 10 64-bit, select the optical drive that contains the Windows 10 64-bit installation disk and is prefixed with "UEFI:" string.
- ☞ **Hard Drive/CD/DVD ROM Drive/Floppy Drive/Network Device BBS Priorities**
Specifies the boot order for a specific device type, such as hard drives, optical drives, floppy disk drives, and devices that support Boot from LAN function, etc. Press <Enter> on this item to enter the submenu that presents the devices of the same type that are connected. This item is present only if at least one device for this type is installed.
- ☞ **Fast Boot**
Enables or disables Fast Boot to shorten the OS boot process. (Default: Disabled)
- ☞ **SATA Support**
 - ▶▶ All Sata Devices All SATA devices are functional in the operating system and during the POST. (Default)
 - ▶▶ Last Boot HDD Only Except for the previous boot drive, all SATA devices are disabled before the OS boot process completes.This item is configurable only when **Fast Boot** is set to **Enabled**.

☞ **VGA Support**

Allows you to select which type of operating system to boot.

- ▶▶ Auto Enables legacy option ROM only.
- ▶▶ EFI Driver Enables EFI option ROM. (Default)

This item is configurable only when **Fast Boot** is set to **Enabled**.

☞ **USB Support**

- ▶▶ Disabled All USB devices are disabled before the OS boot process completes.
- ▶▶ Full Initial All USB devices are functional in the operating system and during the POST.
- ▶▶ Partial Initial Part of the USB devices are disabled before the OS boot process completes. (Default)

This item is configurable only when **Fast Boot** is set to **Enabled**.

☞ **PS2 Devices Support**

- ▶▶ Disable All PS/2 devices are disabled before the OS boot process completes.
- ▶▶ Enable All PS/2 devices are functional in the operating system and during the POST. (Default)

This item is configurable only when **Fast Boot** is set to **Enabled**.

☞ **NetWork Stack Driver Support**

- ▶▶ Disable Disables booting from the network. (Default)
- ▶▶ Enable Enables booting from the network.

This item is configurable only when **Fast Boot** is set to **Enabled**.

☞ **New Boot Option Policy**

Allows you to determine whether to change the boot order when a new device is added.

- ▶▶ Dedault Keeps the previous boot order settings. (Default)
- ▶▶ Place First Set the newly added device as the first boot device.
- ▶▶ Place Last Set the newly added device as the last boot device.

2-6 Save & Exit

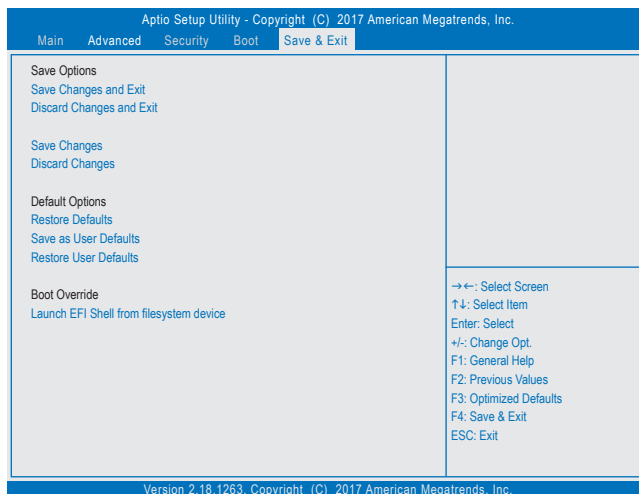

☞ **Save Changes and Exit**

Press <Enter> on this item and select **Yes**. This saves the changes to the CMOS and exits the BIOS Setup program. Select **No** or press <Esc> to return to the BIOS Setup Main Menu.

☞ **Discard Changes and Exit**

Press <Enter> on this item and select **Yes**. This exits the BIOS Setup without saving the changes made in BIOS Setup to the CMOS. Select **No** or press <Esc> to return to the BIOS Setup Main Menu.

☞ **Save Changes**

Press <Enter> on this item and select **Yes** to save the changes to the CMOS. Select **No** or press <Esc> to return to the BIOS Setup Main Menu.

☞ **Discard Changes**

Press <Enter> on this item and select **Yes** to cancel the BIOS changes. Select **No** or press <Esc> to return to the BIOS Setup Main Menu.

☞ **Restore Defaults**

Press <Enter> on this item and select **Yes** to load the BIOS factory default settings. The BIOS defaults settings help the system to operate in optimum state. Always load the Optimized defaults after updating the BIOS or after clearing the CMOS values.

☞ **Save as User Defaults**

Save to current BIOS settings as user-defined default settings.

☞ **Restore User Defaults**

Load the user-define default settings for all BIOS options.

☞ **Boot Override**

Allows you to select a device to boot immediately. Press <Enter> on the device you select and select **Yes** to confirm. Your system will restart automatically and boot from that device.

☞ **Launch EFI Shell from filesystem device**

Allows you to launch the EFI Shell application (shell.efi) from one of the available filesystem devices. Press <Enter> on this option and the system will restart to the EFI Shell screen automatically.

Chapter 3 Appendix

Drivers Installation



- Before installing the drivers, first install the operating system.
- After installing the operating system, insert the motherboard driver disk into your optical drive. Click on the message "Tap to choose what happens with this disc" on the top-right corner of the screen and select "Run Run.exe." (Or go to My Computer, double-click the optical drive and execute the Run.exe program.)

"Xpress Install" will automatically scan your system and then list all of the drivers that are recommended to install. You can click the **Xpress Install** button and "Xpress Install" will install all of the selected drivers. Or click the arrow  icon to individually install the drivers you need.

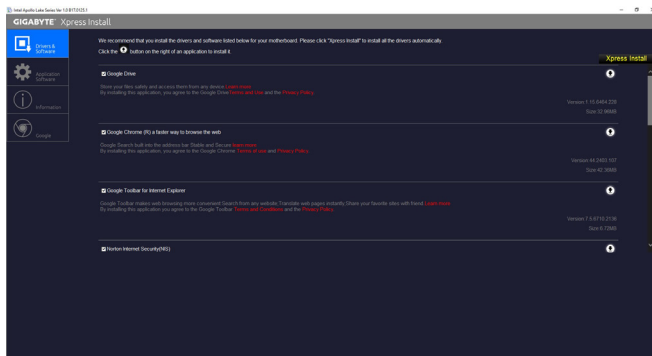

Regulatory Statements

Regulatory Notices

This document must not be copied without our written permission, and the contents there of must not be imparted to a third party nor be used for any unauthorized purpose.

Contravention will be prosecuted. We believe that the information contained herein was accurate in all respects at the time of printing. GIGABYTE cannot, however, assume any responsibility for errors or omissions in this text. Also note that the information in this document is subject to change without notice and should not be construed as a commitment by GIGABYTE.

Our Commitment to Preserving the Environment

In addition to high-efficiency performance, all GIGABYTE motherboards fulfill European Union regulations for RoHS (Restriction of Certain Hazardous Substances in Electrical and Electronic Equipment) and WEEE (Waste Electrical and Electronic Equipment) environmental directives, as well as most major worldwide safety requirements. To prevent releases of harmful substances into the environment and to maximize the use of our natural resources, GIGABYTE provides the following information on how you can responsibly recycle or reuse most of the materials in your "end of life" product.

Restriction of Hazardous Substances (RoHS) Directive Statement

GIGABYTE products have not intended to add and safe from hazardous substances (Cd, Pb, Hg, Cr+6, PBDE and PBB). The parts and components have been carefully selected to meet RoHS requirement. Moreover, we at GIGABYTE are continuing our efforts to develop products that do not use internationally banned toxic chemicals.

Waste Electrical & Electronic Equipment (WEEE) Directive Statement

GIGABYTE will fulfill the national laws as interpreted from the 2002/96/EC WEEE (Waste Electrical and Electronic Equipment) directive. The WEEE Directive specifies the treatment, collection, recycling and disposal of electric and electronic devices and their components. Under the Directive, used equipment must be marked, collected separately, and disposed of properly.

WEEE Symbol Statement



The symbol shown below is on the product or on its packaging, which indicates that this product must not be disposed of with other waste. Instead, the device should be taken to the waste collection centers for activation of the treatment, collection, recycling and disposal procedure. The separate collection and recycling of your waste equipment at the time of disposal will help to conserve natural resources and ensure that it is recycled in a manner that protects human health and the environment.

For more information about where you can drop off your waste equipment for recycling, please contact your local government office, your household waste disposal service or where you purchased the product for details of environmentally safe recycling.

- ◆ When your electrical or electronic equipment is no longer useful to you, "take it back" to your local or regional waste collection administration for recycling.
- ◆ If you need further assistance in recycling, reusing in your "end of life" product, you may contact us at the Customer Care number listed in your product's user's manual and we will be glad to help you with your effort.

Finally, we suggest that you practice other environmentally friendly actions by understanding and using the energy-saving features of this product (where applicable), recycling the inner and outer packaging (including shipping containers) this product was delivered in, and by disposing of or recycling used batteries properly. With your help, we can reduce the amount of natural resources needed to produce electrical and electronic equipment, minimize the use of landfills for the disposal of "end of life" products, and generally improve our quality of life by ensuring that potentially hazardous substances are not released into the environment and are disposed of properly.

FCC Notice (U.S.A. Only)

This equipment has been tested and found to comply with the limits for a Class B digital device, pursuant to Part 15 of the FCC Rules. These limits are designed to provide reasonable protection against harmful interference in a residential installation. This equipment generates, uses, and can radiate radio frequency energy and, if not installed and used in accordance with the instructions, may cause harmful interference to radio communications. However, there is no guarantee that interference will not occur in a particular installation. If this equipment does cause harmful interference to radio or television reception, which can be determined by turning the equipment off and on, the user is encouraged to try to correct the interference by one or more of the following measures:

- ◆ Reorient or relocate the receiving antenna.
- ◆ Increase the separation between the equipment and receiver.
- ◆ Connect the equipment into an outlet on a circuit different from that to which the receiver is connected.
- ◆ Consult a dealer or experienced TV/radio technician for help.

Canada, Industry Canada (IC) Notices / Canada, avis d'Industry Canada (IC)

- ◆ This Class B digital apparatus complies with Canadian ICES-003 and RSS-210.
- ◆ Operation is subject to the following two conditions: (1) this device may not cause interference, and (2) this device must accept any interference, including interference that may cause undesired operation of the device.
- ◆ Cet appareil numérique de classe B est conforme aux normes canadiennes ICES-003 et RSS-210.
- ◆ Son fonctionnement est soumis aux deux conditions suivantes : (1) cet appareil ne doit pas causer d'interférence et (2) cet appareil doit accepter toute interférence, notamment les interférences qui peuvent affecter son fonctionnement.



Contact Us

GIGA-BYTE TECHNOLOGY CO., LTD.

Address: No.6, Baoqiang Rd., Xindian Dist., New Taipei City 231, Taiwan

TEL: +886-2-8912-4000, FAX: +886-2-8912-4005

Tech. and Non-Tech. Support (Sales/Marketing) : <http://esupport.gigabyte.com>

WEB address (English): <http://www.gigabyte.com>

WEB address (Chinese): <http://www.gigabyte.tw>

- **GIGABYTE eSupport**

To submit a technical or non-technical (Sales/Marketing) question, please link to:
<http://esupport.gigabyte.com>

The screenshot shows the GIGABYTE eSupport website. At the top left is the GIGABYTE logo. To the right is the 'eSupport' logo. Below these are three icons: 'Downloads', 'FAQ', and 'Warranty'. In the center, there is a 'Sign in with' section featuring social media icons for Facebook, Google+, and a generic user icon. Below this is the 'GIGABYTE Passport' login form, which includes fields for 'E-mail' and 'Password', a 'Forgot password?' link, and a red 'Login' button with a right-pointing arrow. A link for 'Not a member yet!!' is located to the right of the login button. At the bottom of the page, there is a small copyright notice: 'All intellectual property rights, including without limitation to copyright and trademark of this work and its derivative works are the property of, or are licensed to, GIGA-BYTE TECHNOLOGY CO., LTD. Any unauthorized use is strictly prohibited.'