

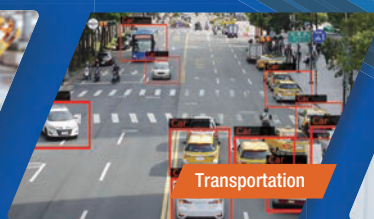

# Building a Smarter Tomorrow

 IoT Solutions Alliance

## 2022 Product Catalog 1H



# Company Profile



GIGAIPC, established in 2018 as an independent IPC-focused spin-off from GIGABYTE, is driven by a passion for technology and agile intuition of our customer's requirements. GIGAIPC has an exceptionally sophisticated Research & Development department, enabling us to keep up with the rapid pace of today's technology. Combined with our outstanding research and design ability, GIGAIPC also has an award-winning Taiwan-based manufacturing facility, synchronizing with GIGAIPC's R&D department to deliver high quality and reliable products. GIGAIPC is a young and energetic organization driven by surpassing our customer's expectations, and we promise to offer our customers not only high-quality computing platforms but also world-class service and support. As a result, GIGAIPC's service centers have been established in most major cities worldwide, and our global presence is still being actively expanding, all ready to offer the best service to our customers.

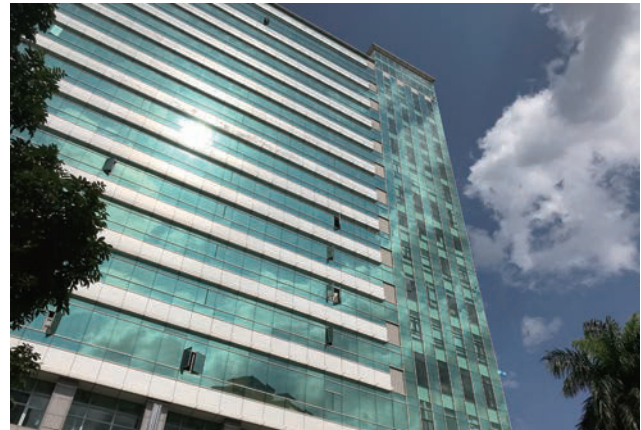

Company Profile/ Naming Rule

GIGAIPC is an Associate member of the Intel® Internet of Things Solutions Alliance.



## “Building a SMARTER Tomorrow”

The strengths of GIGAIPC are based on the advantages, skills and expertise we have built to realize this vision, including being customer focused and striving for high quality. GIGAIPC is determined to keep reinforcing these strengths as our principles to achieve maximum customer satisfaction.

## Key Advantages to work with GIGAIPC

<b>Technology</b>	<ol style="list-style-type: none"> <li>1. Intel®, AMD etc. Key vendor direct support</li> <li>2. Latest technical and over 10 years RD development experiences</li> <li>3. Large coverage rate of design verification</li> </ol>
<b>Flexibility</b>	<ol style="list-style-type: none"> <li>1. Huge off-the-shelf products combination and rich ODM/OEM experiences</li> <li>2. Multiple manufacturing sites for different high-mix and low-volume requirements</li> <li>3. Task-force team with multiple functions to align customer's requirements</li> </ol>
<b>Quality</b>	<ol style="list-style-type: none"> <li>1. Component IPC, audit and approval system</li> <li>2. Rich resources and equipments on design and manufacture quality system</li> <li>3. Emphasizing closed-loop of PDCA cycle for continuous improvement</li> </ol>
<b>Service</b>	<ol style="list-style-type: none"> <li>1. Worldwide RMA service coverage more than 80 service centers globally</li> </ol>
<b>Capability</b>	<ol style="list-style-type: none"> <li>1. Customization capability</li> <li>2. Direct field application engineer support and quick response</li> <li>3. Customized manufacturing process, quality control and delivery solutions</li> </ol>

## Motherboard's Naming Rule -

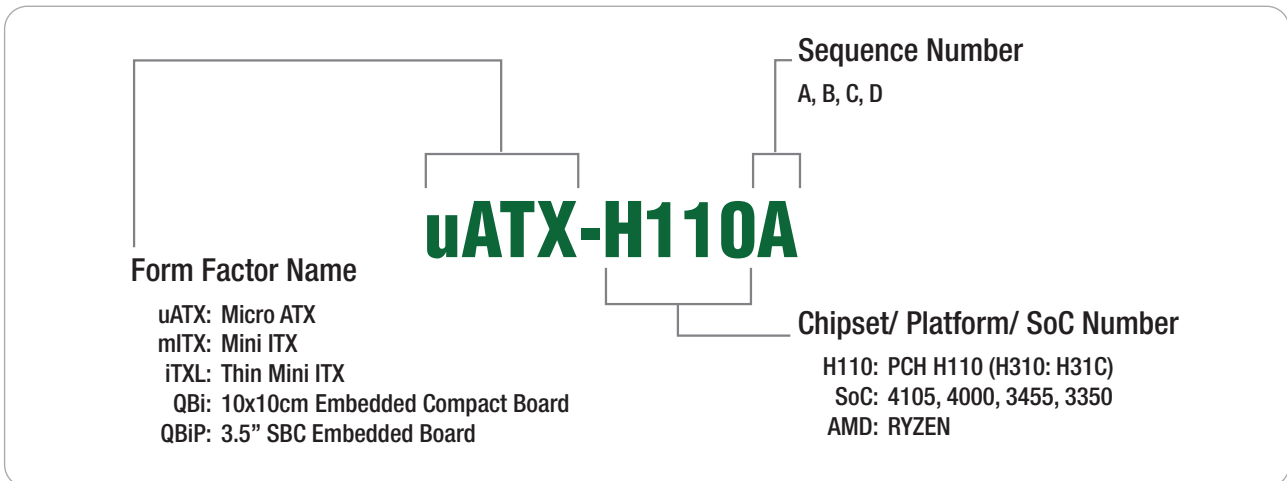

## System's Naming Rule -

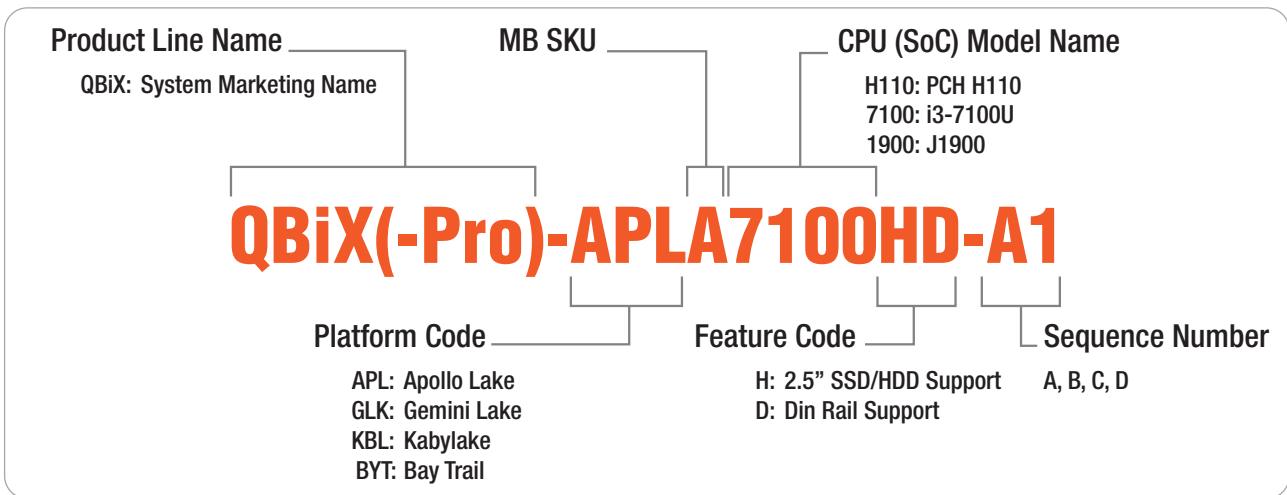

## Motherboard's Form Factor -

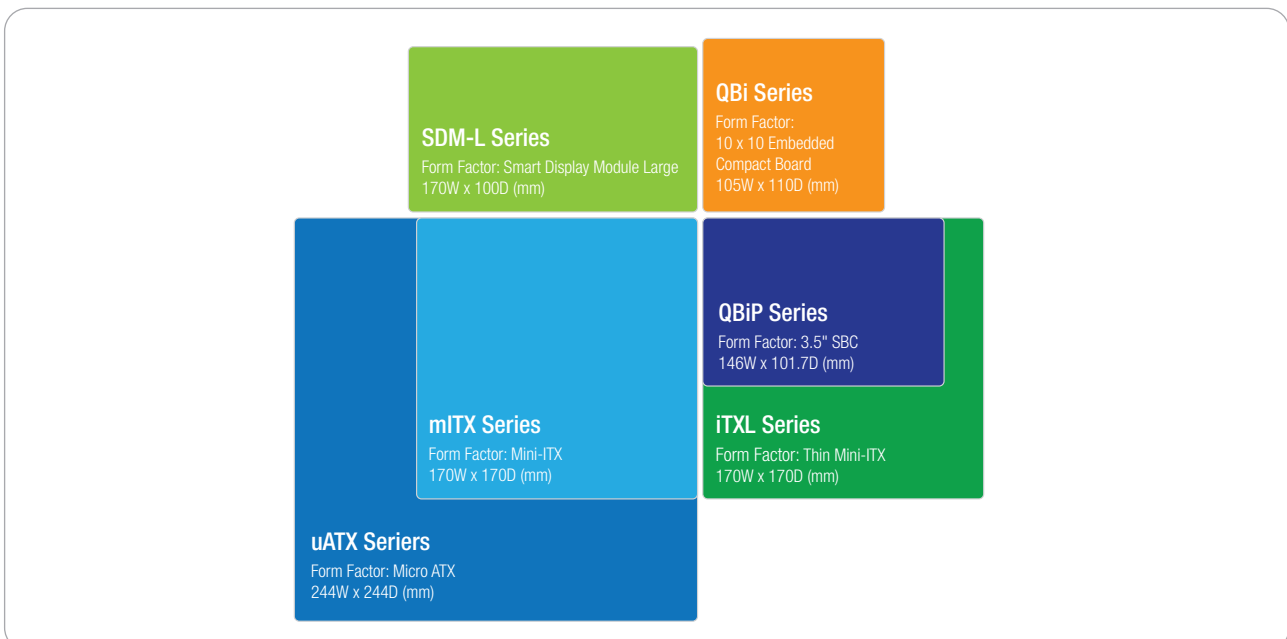



**Company Profile** ..... 1

**Product’s Naming Rule** ..... 2

**Index** ..... 3

## Embedded Computing Systems

### QBiX Series ..... 5

QBiX-TGLA1115G4E-A1 ..... 5

QBiX-WHLA8565H-A1 ..... 5

QBiX-WHLA8265H-A1..... 5

QBiX-WHLA8145H-A1..... 5

QBiX-KBLA7100H-A1 ..... 5

QBiX-EHLA6412-A1 ..... 6

QBiX-GLKB4125-A1..... 6

### QBiX Series ..... 7

QBiX-GLKA5005H-A1..... 7

QBiX-APLA4200H-A1 ..... 7

### QBiX-Pro Series ..... 8

QBiX-Pro-TGLA1115G4EH-A1/A2 ..... 8

QBiX-Pro-WHLA8565H-A1 ..... 8

QBiX-Pro-WHLA8265H-A1 ..... 8

QBiX-Pro-WHLA8145H-A1 ..... 8

QBiX-Pro-WHLA8565H-A2 ..... 8

QBiX-Pro-WHLA8265H-A2 ..... 8

QBiX-Pro-WHLA8145H-A2 ..... 8

QBiX-Pro-KBLB7200H-A2 ..... 9

QBiX-Pro-KBLB7100H-A1 ..... 9

QBiX-Pro-KBLB3965H-A1 ..... 10

QBiX-Pro-EHLA6412H-A1 ..... 10

QBiX-Pro-APLB4200H-A1 ..... 10

QBiX-Pro-APLB4200H-B1 ..... 11

QBiX-Pro-BYTA1900H-A1 ..... 11

QBiX-Pro-AMDA1605H-A1..... 11

QBiX-Pro-GLKA5040HD-A1..... 12

QBiX-Pro-BYTA1900HD-A1 ..... 12

### QBiX-Expert Series..... 13

QBiX-Exp-TGLA1165G7H-A1 ..... 13

QBiX-Exp-TGLA1135G7H-A1 ..... 13

### QBiX-ITX Series..... 14

QBiX-ITX-Chassis Kit ..... 14

### QBiX-Jumbo Series ..... 15

QBiX-JMB-CMLA47EH-A1..... 15

QBiX-JMB-CMLA47EHG-B1 ..... 15

QBiX-JMB-CFLA310H-A1 ..... 16

QBiX-JMB-CFLA310HG-A1..... 16

QBiX-JMB-CFLA310HG-B1 ..... 16

### QBiX-WP Series ..... 17

QBiX-WP-WHLA8265H-A1 ..... 17

QBiX-WP-APLA3940H-A1..... 17

### QBiX-Jetson Series..... 18

QBiX-Jetson-NanoAHP-A1..... 18

QBiX-Jetson-XavierAHP-A1..... 18

### Embedded IoT Series ..... 19

EL-30-4200 (rev. 1.0) ..... 19

EL-30-3350 (rev. 1.0)..... 19

EL-20-3710-32G (rev. 1.0) ..... 19

EL-20-3060-32G (rev. 1.0) ..... 19

### QBiX-Plus Series ..... 20

QBiX-Plus-KBLA7100-A1..... 20

QBiX-Plus-APLA3450-A1 ..... 20

### QBiX-Lite Series ..... 21

QBiX-Lite-TGLA1135G7-A1 ..... 21

QBiX-Lite-AMDA1605H-A1..... 21

QBiX-Lite SDM Kits ..... 22

### SDM-L Series ..... 23

SDM-1135G7L ..... 23

SDM-1115G4L ..... 23

SDM-7300L ..... 23

SDM-7100L ..... 23

SDM-4000L..... 23

SDM Docking Board ..... 24

## Embedded Boards

### Micro-ATX Series ..... 25

uATX-W48EA .....	25
uATX-Q47EA .....	25
uATX-H410A.....	25
uATX-Q370A .....	26
uATX-H310A.....	26
uATX-H110A .....	27
uATX-RYZEN.....	27

### Mini-ITX Series ..... 28

mITX-Q47EA .....	28
mITX-H42EA .....	28
mITX-Q370A .....	28
mITX-H310A.....	29
mITX-Q170A .....	29
mITX-H110A.....	29
mITX-H110B.....	30
mITX-4125A .....	30
mITX-1900A.....	31
mITX-1605A .....	31

### Thin Mini-ITX Series..... 32

iTXL-Q47EA .....	32
iTXL-H42EA .....	32
iTXL-Q370A.....	32
iTXL-H110C.....	33
iTXL-5105A/ iTXL-4500A .....	33
iTXL-3350A.....	33

### QBiP Series (3.5" SBC) ..... 34

QBiP-1165G7A/ QBiP-1135G7A/ QBiP-1115G4EA.....	34
QBiP-1165G7B/ QBiP-1135G7B/ QBiP-1115G4EB .....	34
QBiP-8665A/ QBiP-8365A .....	35
QBiP-8565A/ QBiP-8265A/ QBiP-8145A .....	35
QBiP-7600A/ QBiP-7200A/ QBiP-7100A.....	36
QBiP-3965A .....	36
QBiP-6412A/ QBiP-6210A .....	37

QBiP-4200B/ QBiP-4200C/ QBiP-3350A .....	37
QBiP-E3940A .....	38
QBiP-1900A .....	38
QBiP-1605B.....	38
QBiP-7200AT/ QBiP-7100AT.....	39
QBiP-E3940AT .....	39
QBiP-1900AT.....	39

### QBi Series (10 x 10 Embedded Compact Board) 40

QBi-1165G7A/ QBi-1135G7A/ QBi-1115G4EA.....	40
QBi-8665A/ QBi-8365A .....	40
QBi-8565A/ QBi-8265A/ QBi-8145A.....	41
QBi-7100B.....	41
QBi-3965B.....	41
QBi-6412A / QBi-6210A.....	42
QBi-4125A.....	42
QBi-4200B .....	42

## QBiX Series

Preliminary



QBiX Series

Model Name	QBiX-TGLA1115G4E-A1	QBiX-WHLA8565H-A1 QBiX-WHLA8265H-A1 QBiX-WHLA8145H-A1	QBiX-KBLA7100H-A1
<b>Dimension</b>	138W x 118D x 74.2H (mm)	138W x 118D x 74.2H (mm)	138W x 118D x 74.2H (mm)
<b>CPU</b>	Intel® Core™ i3-1115G4E Processor, 10nm SuperFin, 2 cores, 4 threads, up to 3.90 GHz	Intel® Core™ i7-8565U Processor, 14nm, 4 cores, 8 threads, up to 4.6 GHz Intel® Core™ i5-8265U Processor, 14nm, 4 cores, 8 threads, up to 3.9 GHz Intel® Core™ i3-8145UE Processor, 14nm, 2 cores, 4 threads, up to 3.9 GHz	Intel® Core™ i3-7100U Processor, 14nm, 2 cores, 4 threads, 2.4 GHz
<b>Chipset</b>	SoC	SoC	SoC
<b>Memory</b>	2 x DDR4 SO-DIMM sockets, Max. Capacity 64 GB, Support Dual Channel DDR4 3200 MHz	2 x DDR4 SO-DIMM sockets, Max. Capacity 32 GB, Support Dual Channel DDR4 2400 MHz	2 x DDR4 SO-DIMM sockets, Max. Capacity 32 GB, Support Dual Channel DDR4 2133 MHz
<b>Ethernet</b>	2 x GbE LAN Ports (Intel® I219V and Realtek® RTL8111HS)	2 x GbE LAN Ports (Intel® I219V and Realtek® RTL8111HS)	1 x GbE LAN Port (Intel® I219V)
<b>Graphic</b>	Integrated Graphics Processor - Intel® UHD Graphics for 11th Gen Intel® Processors: 2 x HDMI 2.0 2 independent display outputs	Integrated Graphics Processor - Intel® UHD Graphics 620: 2 x HDMI 1.4 2 independent display outputs	Integrated Graphics Processor - Intel® HD Graphics 620: 1 x HDMI 2.0 1 x Mini Display Port 2 independent display outputs
<b>Audio</b>	Realtek® Audio Codec	Realtek® Audio Codec	Intel® Integrated Audio
<b>Storage</b>	—	1 x 2.5" HDD/SSD (SATA 6Gb/s)	1 x 2.5" HDD/SSD (SATA 6Gb/s)
<b>Expansion Slots</b>	1 x 2280 M.2 M-Key (PCIe x4, SATA 6Gb/s) 1 x 2230 M.2 E-Key	1 x 2280 M.2 M-Key (PCIe x4, SATA 6Gb/s) 1 x 2230 M.2 E-Key 1 x Vertical USB 3.2 Gen 1	1 x 2280 M.2 M-Key (PCIe x4, SATA 6Gb/s) 1 x 2230 M.2 E-Key
<b>Front I/O</b>	2 x USB 3.2 Gen 2x1 1 x Power button with LED 2 x External Antenna Holes (Optional) 1 x HDD LED 1 x COM Port (RS-232/422/485) 1 x Headphone Jack	2 x USB 3.2 Gen 2x1 1 x Power button with LED 2 x External Antenna Holes (Optional) 1 x HDD LED 1 x COM Port (RS-232/422/485) 1 x Headphone Jack	2 x USB 3.2 Gen 1 1 x Power switch 2 x External Antenna Holes (Optional) 1 x Power LED 1 x HDD LED
<b>Rear I/O</b>	2 x HDMI 2 x RJ45 LAN Ports 2 x USB 3.2 Gen 2x1 1 x Screw type DC Jack	2 x HDMI 2 x RJ45 LAN Ports 2 x USB 3.2 Gen 2x1 1 x Screw Type DC Jack	1 x RJ45 LAN Port 2 x USB 3.2 Gen 1 1 x HDMI 1 x Mini Display Port 1 x COM Port (RS-232) 1 x Screw Type DC Jack
<b>Side I/O</b>	—	—	—
<b>TPM</b>	—	—	—
<b>Power</b>	+9V~48VDC (Adapter 19V/90W)	+9V~36VDC (Adapter 19V/90W)	+12V~24VDC (Adapter 19V/65W)
<b>Operating Temp.</b>	0°C to 50°C	0°C to 50°C	0°C to 50°C
<b>Mounting</b>	Wall mount	Wall mount	Wall mount
<b>Ordering Information</b>	—	6BQB8565AMR-SI (Box packing) 6BQB8265AMR-SI (Box packing) 6BQB8145AMR-SI (Box packing)	6BCKAAMR-SI (Box packing)
<b>Built-in Components</b>	—	—	—

## QBiX Series

Preliminary



Model Name	QBiX-EHLA6412-A1	QBiX-GLKB4125-A1
<b>Dimension</b>	118W x 109.4D x 44.4H (mm)	118W x 109.4D x 44.4H (mm)
<b>CPU</b>	Intel® Celeron® J6412 Processor, 10nm, 4 cores, 4 threads, 2.0 to 2.6 GHz	Intel® Celeron® J4125 Processor, 14nm, 4 cores, 4 threads, up to 2.7 GHz
<b>Chipset</b>	SoC	SoC
<b>Memory</b>	1 x DDR4 SO-DIMM socket, Max. Capacity 16 GB, Support Single Channel DDR4 3200 MHz	1 x DDR4 SO-DIMM socket, Max. Capacity 8 GB, Support Single Channel DDR4 2400 MHz
<b>Ethernet</b>	2 x GbE LAN Ports (Intel® I211AT and Realtek® RTL8111HS)	2 x GbE LAN Ports (Intel® I211AT and Realtek® RTL8111HS)
<b>Graphic</b>	Integrated Graphics Processor - Intel® UHD Graphics for 10th Gen Intel® Processors : 2 x HDMI 2.0 2 independent display outputs	Integrated Graphics Processor - Intel® UHD Graphics 600: 2 x HDMI 1.4 2 independent display outputs
<b>Audio</b>	Realtek® Audio Codec	Realtek® Audio Codec
<b>Storage</b>	—	—
<b>Expansion Slots</b>	1 x 2280 M.2 M-Key (SATA 6Gb/s) 1 x 2230 M.2 E-Key	1 x 2280 M.2 M-Key (SATA 6Gb/s) 1 x 2230 M.2 E-Key
<b>Front I/O</b>	2 x USB 3.2 Gen 1 1 x COM Port (RS-232) 1 x Headphone Jack 1 x Power button with LED	2 x USB 3.2 Gen 1 1 x COM Port (RS-232) 1 x Headphone Jack 1 x Power button with LED
<b>Rear I/O</b>	2 x RJ45 LAN Ports 2 x USB 3.2 Gen 1 2 x HDMI 2 x External Antenna Holes (Optional) 1 x Screw Type DC Jack	2 x RJ45 LAN Ports 2 x USB 3.2 Gen 1 2 x HDMI 2 x External Antenna Holes (Optional) 1 x Screw Type DC Jack
<b>Side I/O</b>	—	—
<b>TPM</b>	—	—
<b>Power</b>	+12V~19VDC (Adapter 19V/65W)	+12V~19VDC (Adapter 19V/65W)
<b>Operating Temp.</b>	0°C to 50°C	0°C to 50°C
<b>Mounting</b>	VESA 75/100	VESA 75/100
<b>Ordering Information</b>	—	6BQB4125AMR-SI (Box packing)
<b>Built-in Components</b>	—	—

## QBiX Series



QBiX Series/ QBiX-Pro Series

Model Name	QBiX-GLKA5005H-A1	QBiX-APLA4200H-A1
<b>Dimension</b>	118W x 109.4D x 54.4H (mm)	118W x 109.4D x 54.4H (mm)
<b>CPU</b>	Intel® Pentium® Silver J5005 Processor, 14nm, 4 cores, 4 threads, up to 2.8 GHz	Intel® Pentium® N4200 Processor, 14nm, 4 cores, 4 threads, up to 2.5 GHz
<b>Chipset</b>	SoC	SoC
<b>Memory</b>	1 x DDR4 SO-DIMM socket, Max. Capacity 8 GB, Support Single Channel DDR4 2400 MHz	1 x DDR3L SO-DIMM socket, Max. Capacity 8 GB, Support Single Channel DDR3L 1866 MHz
<b>Ethernet</b>	1 x GbE LAN Port (Realtek® RTL8111HS)	1 x GbE LAN Port (Realtek® RTL8111HS)
<b>Graphic</b>	Integrated Graphics Processor - Intel® UHD Graphics 605: 1 x HDMI 1.4 1 x VGA 2 independent display outputs	Integrated Graphics Processor - Intel® HD Graphics 505: 1 x HDMI 1.4 1 x VGA 2 independent display outputs
<b>Audio</b>	Realtek® Audio Codec	Realtek® Audio Codec
<b>Storage</b>	1 x 2.5" HDD/SSD (SATA 6Gb/s)	1 x 2.5" HDD/SSD (SATA 6Gb/s)
<b>Expansion Slots</b>	1 x 2230 M.2 E-Key	1 x 2230 M.2 E-Key
<b>Front I/O</b>	2 x USB 3.2 Gen 1 1 x COM Port (RS-232) 1 x Headphone Jack 1 x Microphone Jack 1 x Power button with LED	2 x USB 3.2 Gen 1 1 x Power button with LED 1 x Headphone Jack
<b>Rear I/O</b>	1 x RJ45 LAN Port 2 x USB 3.2 Gen 1 1 x HDMI 1 x VGA 2 x External Antenna Holes (Optional)	1 x RJ45 LAN Port 2 x USB 3.2 Gen 1 1 x HDMI 1 x VGA 2 x External Antenna Holes (Optional)
<b>Side I/O</b>	1 x DC Jack	1 x DC Jack
<b>TPM</b>	—	—
<b>Power</b>	+12V~19VDC (Adapter 19V/65W)	+12V~24VDC (Adapter 19V/65W)
<b>Operating Temp.</b>	0°C to 50°C	0°C to 50°C
<b>Mounting</b>	VESA 75/100	VESA 75/100
<b>Ordering Information</b>	6BCGAAMR-SI (Box packing)	6BCBAAMR-SI (Box packing)
<b>Built-in Components</b>	—	—



## QBiX-Pro Series



Model Name	QBiX-Pro-TGLA1115G4EH-A1/A2	QBiX-Pro-WHLA8565H-A1 QBiX-Pro-WHLA8265H-A1 QBiX-Pro-WHLA8145H-A1	QBiX-Pro-WHLA8565H-A2 QBiX-Pro-WHLA8265H-A2 QBiX-Pro-WHLA8145H-A2
<b>Dimension</b>	178W x 125D x 52.7H (mm)	178W x 125D x 52.7H (mm)	178W x 125D x 52.7H (mm)
<b>CPU</b>	Intel® Core™ i3-1115G4E Processor, 10nm SuperFin, 2 cores, 4 threads, up to 3.9GHz	Intel® Core™ i7-8565U Processor, 14nm, 4 cores, 8 threads, up to 4.6 GHz Intel® Core™ i5-8265U Processor, 14nm, 4 cores, 8 threads, up to 3.9 GHz Intel® Core™ i3-8145UE Processor, 14nm, 2 cores, 4 threads, up to 3.9 GHz	Intel® Core™ i7-8565U Processor 14nm, 4 cores, 8 threads, up to 4.6 GHz Intel® Core™ i5-8265U Processor 14nm, 4 cores, 8 threads, up to 3.9 GHz Intel® Core™ i3-8145UE Processor 14nm, 2 cores, 4 threads, up to 3.9 GHz
<b>Chipset</b>	SoC	SoC	SoC
<b>Memory</b>	2 x DDR4 SO-DIMM sockets, Max. Capacity 64 GB, Support Dual Channel DDR4 3200 MHz	2 x DDR4 SO-DIMM sockets, Max. Capacity 32 GB, Support Dual Channel DDR4 2400 MHz	2 x DDR4 SO-DIMM sockets, Max. Capacity 32 GB, Support Dual Channel DDR4 2400 MHz
<b>Ethernet</b>	2 x GbE LAN Ports (Intel® I219V and Intel® I211AT)	2 x GbE LAN Ports (Intel® I219V and Intel® I211AT)	2 x GbE LAN Ports (Intel® I219V and Intel® I211AT)
<b>Graphic</b>	Integrated Graphics Processor - Intel® UHD Graphics for 11th Gen Intel® Processors : 2 x HDMI 2.0 2 independent display outputs	Integrated Graphics Processor - Intel® UHD Graphics 620 : 2 x HDMI 1.4 2 independent display outputs	Integrated Graphics Processor - Intel® UHD Graphics 620 : 2 x HDMI 1.4 2 independent display outputs
<b>Audio</b>	Realtek® Audio Codec	Realtek® Audio Codec	Realtek® Audio Codec
<b>Storage</b>	1 x 2.5" HDD/SSD (SATA 6Gb/s)	1 x 2.5" HDD/SSD (SATA 6Gb/s)	1 x 2.5" HDD/SSD (SATA 6Gb/s)
<b>Expansion Slots</b>	1 x 2280 M.2 M-Key (PCIe x2, SATA 6Gb/s) 1 x 2230 M.2 E-Key 1 x Full-size Mini PCIe with SIM slot	1 x 2280 M.2 M-Key (PCIe x4, SATA 6Gb/s) 1 x 2230 M.2 E-Key 1 x Full-size Mini PCIe with SIM slot	1 x 2280 M.2 M-Key (PCIe x4, SATA 6Gb/s) 1 x 2230 M.2 E-Key 1 x Full-size Mini PCIe with SIM slot
<b>Front I/O</b>	2 x RJ45 LAN Ports 4 x USB 3.2 Gen 2x1 2 x HDMI 1 x Power button with LED 1 x HDD LED 1 x COM Port (RS-232/422/485 & RI/5V/12V)	2 x RJ45 LAN Ports 4 x USB 3.2 Gen 2x1 2 x HDMI 1 x Power button with LED 1 x HDD LED 1 x COM Port (RS-232/422/485 & RI/5V/12V)	2 x RJ45 LAN Ports 4 x USB 3.2 Gen 2x1 2 x HDMI 1 x Power button with LED 1 x HDD LED 1 x COM Port (RS-232/422/485 & RI/5V/12V)
<b>Rear I/O</b>	2 x USB 2.0 2 x COM Ports (RS-232/422/485) 1 x GPIO (8 bits) 1 x Headphone Jack 1 x 3-pin Terminal Block/Screw Type DC Jack	2 x USB 2.0 2 x COM Ports (RS-232) 1 x GPIO (8 bits) 1 x Headphone Jack 1 x 3-pin Terminal Block	2 x USB 2.0 2 x COM Ports (RS-232) 1 x GPIO (8 bits) 1 x Headphone Jack 1 x Screw Type DC Jack
<b>Side I/O</b>	2 x External Antenna Holes (Optional)	2 x External Antenna Holes (Optional)	2 x External Antenna Holes (Optional)
<b>TPM</b>	—	—	—
<b>Power</b>	A1 : +9V~48VDC (Full Range) A2 : +9V~48VDC (Adapter 1 9V/90W)	+9V~36VDC (Full Range)	+9V~36VDC (Adapter 19V/90W)
<b>Operating Temp.</b>	0°C to 50°C	0°C to 50°C	0°C to 50°C
<b>Mounting</b>	Wall mount (Optional)	Wall mount (Optional)	Wall mount (Optional)
<b>Ordering Information</b>	6BQP1115AMR-SI (Box packing)	6BQP8565AMR-SI (Box packing) 6BQP8265AMR-SI (Box packing) 6BQP8145AMR-SI (Box packing)	6BQP8565AMR-SI (Box packing) 6BQP8265AMR-SI (Box packing) 6BQP8145AMR-SI (Box packing)
<b>Built-in COM Portponents</b>	—	—	—

## QBiX-Pro Series



QBiX-Pro Series

Model Name	QBiX-Pro-KBLB7200H-A2	QBiX-Pro-KBLB7100H-A1
<b>Dimension</b>	178W x 125D x 52.7H (mm)	178W x 125D x 52.7H (mm)
<b>CPU</b>	Intel® Core™ i5-7200U Processor, 14nm, 2 cores, 4 threads, up to 3.1 GHz	Intel® Core™ i3-7100U Processor, 14nm, 2 cores, 4 threads, 2.4 GHz
<b>Chipset</b>	SoC	SoC
<b>Memory</b>	2 x DDR4 SO-DIMM sockets, Max. Capacity 32 GB, Support Dual Channel DDR4 2133 MHz	2 x DDR4 SO-DIMM sockets, Max. Capacity 32 GB, Support Dual Channel DDR4 2133 MHz
<b>Ethernet</b>	2 x GbE LAN Ports (Intel® I219V and Intel® I211AT)	2 x GbE LAN Ports (Intel® I219V and Intel® I211AT)
<b>Graphic</b>	Integrated Graphics Processor - Intel® HD Graphics 620: 1 x HDMI 2.0 1 x Display Port 2 independent display outputs	Integrated Graphics Processor - Intel® HD Graphics 620: 1 x HDMI 2.0 1 x Display Port 2 independent display outputs
<b>Audio</b>	Realtek® Audio Codec	Realtek® Audio Codec
<b>Storage</b>	1 x 2.5" HDD/SSD (SATA 6Gb/s)	1 x 2.5" HDD/SSD (SATA 6Gb/s)
<b>Expansion Slots</b>	1 x 2280 M.2 M-Key (PCIe x4, SATA 6Gb/s) 1 x 2230 M.2 E-Key 1 x Full-size Mini PCIe with SIM slot	1 x 2280 M.2 M-Key (PCIe x4, SATA 6Gb/s) 1 x 2230 M.2 E-Key 1 x Full-size Mini PCIe with SIM slot
<b>Front I/O</b>	2 x RJ45 LAN Ports 4 x USB 3.2 Gen 1 1 x HDMI 1 x Display Port 1 x Power switch 1 x Power & HDD LED 1 x COM Port (RS-232/422/485 & RI/5V/12V)	2 x RJ45 LAN Ports 4 x USB 3.2 Gen 1 1 x HDMI 1 x Display Port 1 x Power switch 1 x Power & HDD LED 1 x COM Port (RS-232/422/485 & RI/5V/12V)
<b>Rear I/O</b>	2 x USB 2.0 3 x COM Ports (RS-232) 1 x Screw Type DC Jack	2 x USB 2.0 3 x COM Ports (RS-232) 1 x 3-pin Terminal Block
<b>Side I/O</b>	2 x External Antenna Holes (Optional)	2 x External Antenna Holes (Optional)
<b>TPM</b>	—	—
<b>Power</b>	+9V~36VDC (Adapter 19V/65W)	+9V~36VDC (Full Range)
<b>Operating Temp.</b>	0°C to 50°C	0°C to 50°C
<b>Mounting</b>	Wall mount (Optional)	Wall mount (Optional)
<b>Ordering Information</b>	6BQP7200AMR-SI (Box packing)	6BCKACMR-SI (Box packing)
<b>Built-in COM Portponents</b>	—	—

## QBiX-Pro Series



Preliminary



Model Name	QBiX-Pro-KBLB3965H-A1	QBiX-Pro-EHLA6412H-A1	QBiX-Pro-APLB4200H-A1
<b>Dimension</b>	178W x 125D x 52.7H (mm)	178W x 125D x 52.7H (mm)	178W x 125D x 52.7H (mm)
<b>CPU</b>	Intel® Celeron® 3965U Processor, 14nm, 2 cores, 2 threads, 2.2 GHz	Intel® Celeron® J6412 Processor, 10nm, 4 cores, 4 threads, 2.0 to 2.6 GHz	Intel® Pentium® N4200 Processor, 14nm, 4 cores, 4 threads, up to 2.5 GHz
<b>Chipset</b>	SoC	SoC	SoC
<b>Memory</b>	2 x DDR4 SO-DIMM sockets, Max. Capacity 32 GB, Support Dual Channel DDR4 2133 MHz	2 x DDR4 SO-DIMM sockets, Max. Capacity 8 GB, Support Dual Channel DDR4 3200 MHz	2 x DDR3L SO-DIMM sockets, Max. Capacity 8 GB, Support Dual Channel DDR3L 1866 MHz
<b>Ethernet</b>	2 x GbE LAN Ports (Intel® I219V and Intel® I211AT)	2 x GbE LAN Ports (Intel® I211AT)	2 x GbE LAN Ports (Intel® I211AT)
<b>Graphic</b>	Integrated Graphics Processor - Intel® HD Graphics 610: 1 x HDMI 2.0 1 x Display Port 2 independent display outputs	Integrated Graphics Processor - Intel® UHD Graphics for 10th Gen Intel® Processors : 2 x HDMI 2.0 2 independent display outputs	Integrated Graphics Processor - Intel® HD Graphics 505: 1 x HDMI 1.4 1 x VGA 2 independent display outputs
<b>Audio</b>	Realtek® Audio Codec	Realtek® Audio Codec	Realtek® Audio Codec
<b>Storage</b>	1 x 2.5" HDD/SSD (SATA 6Gb/s)	1 x 2.5" HDD/SSD (SATA 6Gb/s)	1 x 2.5" HDD/SSD (SATA 6Gb/s)
<b>Expansion Slots</b>	1 x 2280 M.2 M-Key (SATA 6Gb/s) 1 x 2230 M.2 E-Key 1 x Full-size Mini PCIe with SIM slot	1 x 2280 M.2 M-Key (SATA 6Gb/s) 1 x Full-size Mini PCIe with SIM slot	1 x 2242 M.2 M-Key (SATA 6Gb/s) 1 x Full-size Mini PCIe with SIM slot
<b>Front I/O</b>	2 x RJ45 LAN Ports 4 x USB 3.2 Gen 1 1 x HDMI 1 x Display Port 1 x Power switch 1 x Power & HDD LED 1 x COM Port (RS-232/422/485 & RI/5V/12V)	2 x RJ45 LAN Ports 4 x USB 3.2 Gen 1 2 x HDMI 1 x Power switch 1 x Power & HDD LED 1 x Headphone Jack 1 x Audio Jack	2 x RJ45 LAN Ports 2 x USB 3.2 Gen 1 1 x HDMI 1 x VGA 1 x Power switch 1 x Power & HDD LED 1 x Headphone Jack
<b>Rear I/O</b>	2 x USB 2.0 3 x COM Ports (RS-232) 1 x 3-pin Terminal Block	2 x USB 2.0 1 x COM Port (RS-232/422/485 & RI/5V/12V) 1 x COM Port (RS-232) 1 x GPIO (8 bits) 1 x 3-pin Terminal Block	2 x USB 2.0 1 x COM Port (RS-232/422/485 & RI/5V/12V) 3 x COM Ports (RS-232) 1 x 3-pin Terminal Block
<b>Side I/O</b>	2 x External Antenna Holes (Optional)	2 x External Antenna Holes (Optional)	2 x External Antenna Holes (Optional)
<b>TPM</b>	—	—	—
<b>Power</b>	+9V~36VDC (Full Range)	+9V~36VDC (Full Range)	+9V~36VDC (Full Range)
<b>Operating Temp.</b>	0°C to 50°C	0°C to 50°C	0°C to 50°C
<b>Mounting</b>	Wall mount (Optional)	Wall mount (Optional)	Wall mount (Optional)
<b>Ordering Information</b>	6BQP3965AMR-SI (Box packing)	—	6BCBABMR-SI (Box packing)
<b>Built-in COM Portponents</b>	—	—	—

## QBiX-Pro Series



QBiX-Pro Series

Model Name	QBiX-Pro-APLB4200H-B1	QBiX-Pro-BYTA1900H-A1	QBiX-Pro-AMDA1605H-A1
<b>Dimension</b>	178W x 125D x 52.7H (mm)	178W x 125D x 52.7H (mm)	178W x 125D x 52.7H (mm)
<b>CPU</b>	Intel® Pentium® N4200 Processor, 14nm, 4 cores, 4 threads, up to 2.5 GHz	Intel® Celeron® J1900 Processor, 22nm, 4 cores, 4 threads, up to 2.42 GHz	AMD® RYZEN™ V1605B Embedded Processor, 14nm, 4 cores, 8 threads, 2.0 GHz, up to 3.6 GHz
<b>Chipset</b>	SoC	SoC	SoC
<b>Memory</b>	2 x DDR3L SO-DIMM sockets, Max. Capacity 8 GB, Support Dual Channel DDR3L 1866 MHz	1 x DDR3L SO-DIMM socket, Max. Capacity 8 GB, Support Single Channel DDR3L 1333 MHz	2 x DDR4 SO-DIMM sockets, Max. Capacity 32 GB, Support Dual Channel DDR4 2400 MHz
<b>Ethernet</b>	2 x GbE LAN Ports (Intel® I211AT)	2 x GbE LAN Ports (Intel® I211AT)	2 x GbE LAN Ports (Realtek® RTL8111HS)
<b>Graphic</b>	Integrated Graphics Processor - Intel® HD Graphics 505: 1 x HDMI 1.4 1 x VGA 2 independent display outputs	Integrated Graphics Processor - Intel® HD Graphics: 1 x HDMI 1.4 1 x VGA 2 independent display outputs	Integrated Graphics Processor - AMD® Radeon™ Vega 8 Graphics: 4 x HDMI 2.0 4 independent display outputs
<b>Audio</b>	Realtek® Audio Codec	Realtek® Audio Codec	Realtek® Audio Codec
<b>Storage</b>	1 x 2.5" HDD/SSD (SATA 6Gb/s)	1 x 2.5" HDD/SSD (SATA 3Gb/s)	1 x 2.5" HDD/SSD (SATA 6Gb/s)
<b>Expansion Slots</b>	1 x 2242 M.2 M-Key (SATA 6Gb/s) 1 x Full-size Mini PCIe with SIM slot	1 x 2280 M.2 M-Key (SATA 3Gb/s) 1 x Full-size Mini PCIe with SIM slot	1 x 2280 M.2 M-Key (PCIe x4, SATA 6Gb/s) 1 x 2230 M.2 E-Key 1 x Full-size Mini PCIe with SIM slot
<b>Front I/O</b>	2 x RJ45 LAN Ports 2 x USB 3.2 Gen 1 1 x HDMI 1 x VGA 1 x Power switch 1 x Power & HDD LED 1 x Headphone Jack	2 x RJ45 LAN Ports 1 x USB 3.2 Gen 1 1 x USB 2.0 1 x HDMI 1 x VGA 1 x Power switch 1 x Power & HDD LED 1 x Headphone Jack	2 x RJ45 LAN Ports 2 x USB 3.2 Gen 1 4 x HDMI 1 x Power switch 1 x Power & HDD LED
<b>Rear I/O</b>	2 x USB 2.0 1 x COM Port (RS-232/422/485 & RI/5V/12V) 2 x COM Ports (RS-232) 1 x GPIO (8 bits) 1 x 3-pin Terminal Block	2 x USB 2.0 1 x COM Port (RS-232/422/485 & RI/5V/12V) 1 x COM Port (RS-232/422/485) 2 x COM Ports (RS-232) 1 x 3-pin Terminal Block	2 x USB 2.0 2 x COM Ports (RS-232/422/485 & RI/5V/12V) 2 x COM Ports (RS-232) 1 x Screw Type DC Jack
<b>Side I/O</b>	2 x External Antenna Holes (Optional)	2 x External Antenna Holes (Optional)	2 x External Antenna Holes (Optional)
<b>TPM</b>	—	—	Onboard TPM 2.0 security chip INFINEON SLB9665TT2.0
<b>Power</b>	+9V~36VDC (Full Range)	+9V~36VDC (Full Range)	+9V~36VDC (Adapter 19V/65W)
<b>Operating Temp.</b>	0°C to 50°C	0°C to 50°C	0°C to 50°C
<b>Mounting</b>	Wall mount (Optional)	Wall mount (Optional)	Wall mount (Optional)
<b>Ordering Information</b>	6BQP4200BMR-SI (Box packing)	6BQP1900AMR-SI (Box packing)	6BQP1605AMR-SI (Box packing)
<b>Built-in Components</b>	—	—	—

## QBiX-Pro Series



Model Name	QBiX-Pro-GLKA5040HD-A1	QBiX-Pro-BYTA1900HD-A1
<b>Dimension</b>	160W x 118D x 62.6H (mm)	160W x 118D x 62.6H (mm)
<b>CPU</b>	Intel® Pentium® Silver J5040 Processor, 14nm, 4 cores, 4 threads, up to 3.2 GHz	Intel® Celeron® J1900 Processor, 22nm, 4 cores, 4 threads, up to 2.42 GHz
<b>Chipset</b>	SoC	SoC
<b>Memory</b>	1 x DDR4 SO-DIMM socket, Max. Capacity 8 GB, Support Single Channel DDR4 2400 MHz	1 x DDR3L SO-DIMM socket, Max. Capacity 8 GB, Support Single Channel DDR3L 1333 MHz
<b>Ethernet</b>	2 x GbE LAN Ports (Intel® I211AT)	2 x GbE LAN Ports (Intel® I211AT)
<b>Graphic</b>	Integrated Graphics Processor - Intel® UHD Graphics 605: 1 x HDMI 2.0 1 x VGA 2 independent display outputs	Integrated Graphics Processor - Intel® HD Graphics: 1 x HDMI 1.4 1 x VGA 2 independent display outputs
<b>Audio</b>	Realtek® Audio Codec	Realtek® Audio Codec
<b>Storage</b>	1 x 2.5" HDD/SSD (SATA 6Gb/s)	1 x 2.5" HDD/SSD (SATA 3Gb/s)
<b>Expansion Slots</b>	1 x 2280 M.2 M-Key (SATA 6Gb/s) 1 x 2230 M.2 E-Key 1 x Full-size Mini PCIe with SIM slot 1 x Vertical USB 2.0	1 x 2280 M.2 M-Key (SATA 3Gb/s) 1 x Full-size Mini PCIe with SIM slot
<b>Front I/O</b>	2 x RJ45 LAN Ports 4 x USB 3.2 Gen 1 1 x HDMI 1 x VGA 2 x COM Ports (RS-232/422/485 & RI/5V/12V) 1 x Power button with LED 1 x WiFi/HDD LED 1 x Remote control connector 1 x Headphone Jack 1 x External Antenna Hole (Optional)	2 x RJ45 LAN Ports 1 x USB 3.2 Gen 1 3 x USB 2.0 1 x HDMI 1 x VGA 1 x COM Port (RS-232/422/485 & RI/5V/12V) 1 x COM Port (RS-232) 1 x Power button with LED 1 x HDD LED 1 x Headphone Jack
<b>Rear I/O</b>	1 x Din Rail Mounting Support	1 x Din Rail Mounting Support
<b>Side I/O</b>	1 x GPIO (8 bits) 1 x 3-pin Terminal Block 2 x COM Ports (RS-232/422/485) 2 x External Antenna Holes (Optional)	1 x GPIO (8 bits) 1 x 3-pin Terminal Block 3 x External Antenna Holes (Optional)
<b>TPM</b>	—	—
<b>Power</b>	+9V~36VDC (Full Range)	+9V~36VDC (Full Range)
<b>Operating Temp.</b>	0°C to 50°C	0°C to 50°C
<b>Mounting</b>	DIN Rail	DIN Rail
<b>Ordering Information</b>	6BQP5040AMR-SI (Box packing)	6BQP1900BMR-SI (Box packing)
<b>Built-in Components</b>	—	—



## QBiX-Expert Series

Preliminary



Preliminary



QBiX-Expert Series / QBiX-ITX Series

Market Name	QBiX-Exp-TGLA1165G7H-A1	QBiX-Exp-TGLA1135G7H-A1
<b>Dimension</b>	210.36W x 165D x 65H (mm)	210.36W x 165D x 65H (mm)
<b>CPU</b>	Intel® Core™ i7-1165G7 Processor, 10nm SuperFin, 4 cores, 8 threads, up to 4.7 GHz	Intel® Core™ i5-1135G7 Processor, 10nm SuperFin, 4 cores, 8 threads, up to 4.2 GHz
<b>Chipset</b>	SoC	SoC
<b>Memory</b>	2 x DDR4 SO-DIMM sockets, Max. Capacity 64 GB, Support Dual Channel DDR4 3200 MHz	2 x DDR4 SO-DIMM sockets, Max. Capacity 64 GB, Support Dual Channel DDR4 3200 MHz
<b>Ethernet</b>	2 x GbE LAN Ports (Intel® I219V and Intel® I211AT) 4 x PoE GbE LAN Ports (Intel® I211AT)	2 x GbE LAN Ports (Intel® I219V and Intel® I211AT) 4 x PoE GbE LAN Ports (Intel® I211AT)
<b>Graphic</b>	Integrated Graphics Processor - Intel® Iris X <sup>e</sup> Graphics : 2 x HDMI 2.0 2 independent display outputs	Integrated Graphics Processor - Intel® Iris X <sup>e</sup> Graphics : 2 x HDMI 2.0 2 independent display outputs
<b>Audio</b>	Realtek® Audio Codec	Realtek® Audio Codec
<b>Storage</b>	1 x Swappable 2.5" HDD/SSD (SATA 6Gb/s)	1 x Swappable 2.5" HDD/SSD (SATA 6Gb/s)
<b>Expansion Slots</b>	1 x 2280 M.2 M-Key (PCIe x2, SATA 6Gb/s) 1 x 2230 M.2 E-Key 1 x Full-size Mini PCIe with SIM slot	1 x 2280 M.2 M-Key (PCIe x2, SATA 6Gb/s) 1 x 2230 M.2 E-Key 1 x Full-size Mini PCIe with SIM slot
<b>Front I/O</b>	4 x RJ45 LAN Ports 2 x USB 2.0 1 x Power button with LED 1 x HDD LED 2 x COM Ports (RS-232/422/485) 2 x External Antenna Holes (Optional)	4 x RJ45 LAN Ports 2 x USB 2.0 1 x Power button with LED 1 x HDD LED 2 x COM Ports (RS-232/422/485) 2 x External Antenna Holes (Optional)
<b>Rear I/O</b>	2 x RJ45 LAN Ports 4 x USB 3.2 Gen 2x1 1 x COM Port (RS-232/422/485, RI/5V/12V) 1 x COM Port (RS-232/422/485) 1 x GPIO (8 bits) 1 x Headphone Jack 1 x 4-pin Terminal Block	2 x RJ45 LAN Ports 4 x USB 3.2 Gen 2x1 1 x COM Port (RS-232/422/485, RI/5V/12V) 1 x COM Port (RS-232/422/485) 1 x GPIO (8 bits) 1 x Headphone Jack 1 x 4-pin Terminal Block
<b>Side I/O</b>	4 x External Antenna Holes (Optional)	4 x External Antenna Holes (Optional)
<b>TPM</b>	—	—
<b>Power</b>	+9V~48VDC (non PoE) +12~24VDC (PoE support)	+9V~48VDC (non PoE) +12~24VDC (PoE support)
<b>Operating Temp.</b>	0°C to 50°C	0°C to 50°C
<b>Mounting</b>	Wall mount (Optional)	Wall mount (Optional)
<b>Ordering Information</b>	—	—
<b>Built-in COM portponents</b>	—	—

## QBiX-ITX Series



Market Name	QBiX-ITX-Chassis Kit
<b>Dimension</b>	210W x 200D x 58H (mm)
<b>Support Model</b>	mITX-Q47EA mITX-H42EA mITX-Q370A mITX-H310A mITX-Q170A mITX-H110B mITX-1605A
<b>Chipset</b>	Refer to MB
<b>Storage Drive Bay</b>	1 x 2.5" Drive Bay
<b>Expansion Slots</b>	Refer to Motherboard
<b>Front I/O</b>	4 x USB 2.0 1 x Power button with LED 1 x Power / HDD LED
<b>Rear I/O</b>	2 x External Antenna Holes Others are refer to Motherboard
<b>Side I/O</b>	—
<b>TPM</b>	Refer to Motherboard
<b>Power</b>	Refer to Motherboard
<b>Operating Temp.</b>	0°C to 50°C
<b>Mounting</b>	Wall Mount, VESA 75/100
<b>Ordering Information</b>	6BQIH310AMR-SI (Box packing)-MITX-H310A
<b>Built-in COM Portponents</b>	—

## QBiX-Jumbo Series

Preliminary



Preliminary



QBiX-Jumbo Series

Model Name	QBiX-JMB-CMLA47EH-A1	QBiX-JMB-CMLA47EHG-B1
<b>Dimension</b>	244W x 257D x 91H (mm)	224W x 368D x 166.3H(mm)
<b>CPU</b>	Support for 10th Generation Intel® Core™ i7/ i5/ i3 processors in the LGA1151 package	Support for 10th Generation Intel® Core™ i7/ i5/ i3 processors in the LGA1151 package
<b>Chipset</b>	Intel® Q470E Chipset	Intel® Q470E Chipset
<b>Memory</b>	2 x DDR4 SO-DIMM sockets, Max. Capacity 64 GB, Support Dual Channel DDR4 3200 MHz	2 x DDR4 SO-DIMM sockets, Max. Capacity 64 GB, Support Dual Channel DDR4 3200 MHz
<b>Ethernet</b>	4 x GbE LAN Ports (1 x Intel® I219V and 3 x Intel® I211AT)	4 x GbE LAN Ports (1 x Intel® I219V and 3 x Intel® I211AT)
<b>Graphic</b>	Integrated Graphics Processor - Intel® HD Graphics: 1 x Display Port 1 x DVI-D 1 x VGA 3 independent display outputs	Integrated Graphics Processor - Intel® HD Graphics: 1 x Display Port 1 x DVI-D 1 x VGA 2 independent display outputs
<b>Audio</b>	Realtek® Audio Codec	Realtek® Audio Codec
<b>Storage</b>	4 x 2.5" HDD/SSD (SATA 6Gb/s) 1 x 2280 M.2 M-Key (SATA 6Gb/s) 1 x 2230 M.2 E-Key	4 x 2.5" HDD/SSD (SATA 6Gb/s) 1 x 2280 M.2 M-Key (SATA 6Gb/s) 1 x 2230 M.2 E-Key
<b>Expansion Slots</b>	1 x Full-size Mini PCIe with SIM slot	1 x Full-size Mini PCIe with SIM slot 1 x PCIe x4 (Gen3 x4) 1 x PCIe x16 (Gen3 0/x8) 1 x PCIe x16 (Gen3 x16/x8) - Auto switch
<b>Front I/O</b>	1 x Power Switch /Power/ HDD LED 3 x Audio Jacks (Line in, Line out, Mic in) 1 x Display Port 1 x DVI-D 1 x VGA 2 x COM Ports (RS-232/422/485 & RI/5V/12V) 2 x COM Ports (RS-232) 4 x RJ45 LAN Ports 4 x USB 3.2 Gen 1 6 x USB 2.0 1 x 4-pin Terminal Block 2 x External Antenna Holes (Optional)	1 x Power Switch /Power/ HDD LED 3 x Audio Jacks (Line in, Line out, Mic in) 1 x Display Port 1 x DVI-D 1 x VGA 2 x COM Ports (RS-232/422/485 & RI/5V/12V) 2 x COM Ports (RS-232) 4 x RJ45 LAN Ports 4 x USB 3.2 Gen 1 6 x USB 2.0 1 x 4-pin Terminal Block 2 x External Antenna Holes (Optional)
<b>Rear I/O</b>	—	—
<b>Power</b>	+12V~48VDC (Full Range)	+24V~48VDC (Full Range)
<b>Operating Temp.</b>	-20°C to 50°C (CPU TDP 65W) -20°C to 60°C (CPU TDP 35W)	-20°C to 50°C (CPU TDP 65W) -20°C to 60°C (CPU TDP 35W)
<b>Ordering Information</b>	6BQJQ47EAMR-SI (Box Packing)	—
<b>Build in Components</b>	Please contact with your sales representative for more information or e-mailed to : <a href="mailto:sales@gigaipc.com">sales@gigaipc.com</a>	
<b>Note</b>	※Support Discrete GFX Max. 350W	

## QBiX-Jumbo Series



Model Name	QBiX-JMB-CFLA310H-A1	QBiX-JMB-CFLA310HG-A1	QBiX-JMB-CFLA310HG-B1
<b>Dimension</b>	224W x 257D x 77H (mm)	224W x 343D x 146H (mm)	224W x 368D x 166.3H (mm)
<b>CPU</b>	Support for 9th/8th Generation Intel® Core™ i7/ i5/ i3 processors in the LGA1151 package	Support for 9th/8th Generation Intel® Core™ i7/ i5/ i3 processors in the LGA1151 package	Support for 9th/8th Generation Intel® Core™ i7/ i5/ i3 processors in the LGA1151 package
<b>Chipset</b>	Intel® H310 Chipset	Intel® H310 Chipset	Intel® H310 Chipset
<b>Memory</b>	2 x DDR4 SO-DIMM sockets, Max. Capacity 32 GB, Support Dual Channel DDR4 2666/2400 MHz	2 x DDR4 SO-DIMM sockets, Max. Capacity 32 GB, Support Dual Channel DDR4 2666/2400 MHz	2 x DDR4 SO-DIMM sockets, Max. Capacity 32 GB, Support Dual Channel DDR4 2666/2400 MHz
<b>Ethernet</b>	4 x GbE LAN Ports (1 x Intel® I219V and 3 x Intel® I211AT)	4 x GbE LAN Ports (1 x Intel® I219V and 3 x Intel® I211AT)	4 x GbE LAN Ports (1 x Intel® I219V and 3 x Intel® I211AT)
<b>Graphic</b>	Integrated Graphics Processor - Intel® HD Graphics: 1 x Display Port 1 x DVI-D 1 x VGA 2 independent display outputs	Integrated Graphics Processor - Intel® HD Graphics: 1 x Display Port 1 x DVI-D 1 x VGA 2 independent display outputs	Integrated Graphics Processor - Intel® HD Graphics: 1 x Display Port 1 x DVI-D 1 x VGA 2 independent display outputs
<b>Audio</b>	Realtek® Audio Codec	Realtek® Audio Codec	Realtek® Audio Codec
<b>Storage</b>	3 x 2.5" HDD/SSD (SATA 6Gb/s) 1 x 2280 M.2 M-Key (SATA 6Gb/s) 1 x 2230 M.2 E-Key	3 x 2.5" HDD/SSD (SATA 6Gb/s) 1 x 2280 M.2 M-Key (SATA 6Gb/s) 1 x 2230 M.2 E-Key	3 x 2.5" HDD/SSD (SATA 6Gb/s) 1 x 2280 M.2 M-Key (SATA 6Gb/s) 1 x 2230 M.2 E-Key
<b>Expansion Slots</b>	1 x Full-size Mini PCIe with SIM slot	1 x Full-size Mini PCIe with SIM slot 1 x PCIe x4 (Gen3 x1) 1 x PCIe x16 (Gen3 x16)	1 x Full-size Mini PCIe with SIM slot 1 x PCIe x4 (Gen3 x1) 1 x PCIe x16 (Gen3 x16)
<b>Front I/O</b>	1 x Power Switch/ Power/ HDD LED 3 x Audio Jacks (Line in, Line out, Mic in) 1 x Display Port 1 x DVI-D 1 x VGA 2 x COM Ports (RS-232/422/485 & RI/5V/12V) 2 x COM Ports (RS-232) 4 x RJ45 LAN Ports 4 x USB 3.2 Gen 1 4 x USB 2.0 1 x 4-pin Terminal Block 2 x External Antenna Holes (Optional)	1 x Power Switch/ Power/ HDD LED 3 x Audio Jacks (Line in, Line out, Mic in) 1 x Display Port 1 x DVI-D 1 x VGA 2 x COM Ports (RS-232/422/485 & RI/5V/12V) 2 x COM Ports (RS-232) 4 x RJ45 LAN Ports 4 x USB 3.2 Gen 1 4 x USB 2.0 1 x 4-pin Terminal Block 2 x External Antenna Holes (Optional)	1 x Power Switch/ Power/ HDD LED 3 x Audio Jacks (Line in, Line out, Mic in) 1 x Display Port 1 x DVI-D 1 x VGA 2 x COM Ports (RS-232/422/485 & RI/5V/12V) 2 x COM Ports (RS-232) 4 x RJ45 LAN Ports 4 x USB 3.2 Gen 1 4 x USB 2.0 1 x 4-pin Terminal Block 2 x External Antenna Holes (Optional)
<b>Rear I/O</b>	—	—	—
<b>Power</b>	+12V~48VDC (Full Range)	+24V~36VDC (Full Range)	+24V~48VDC (Full Range)
<b>Operating Temp.</b>	-20°C to 50°C (CPU TDP 65W) -20°C to 60°C (CPU TDP 35W) -20°C to 50°C (CPU TDP 35W, i3-8100T, Tj 82°C)	-20°C to 50°C (CPU TDP 65W) -20°C to 60°C (CPU TDP 35W) -20°C to 50°C (CPU TDP 35W, i3-8100T, Tj 82°C)	-20°C to 50°C (CPU TDP 65W) -20°C to 60°C (CPU TDP 35W) -20°C to 50°C (CPU TDP 35W, i3-8100T, Tj 82°C)
<b>Ordering Information</b>	9BQJH310AMR-SI (Box Packing)	9BQJH310AMR-SI + 6BQJH310APR-SI	9BQJH310AMR-SI + 6BQJH310BPR-SI
<b>Build in Components</b>	Please contact with your sales representative for more information or e-mailed to : <a href="mailto:sales@gigaipc.com">sales@gigaipc.com</a>		
<b>Note</b>		※Support Discrete GFX Max. 250W	※Support Discrete GFX Max. 250W

## QBiX-WP Series



QBiX-WP series/QBiX-Jetson series

Model Name	QBiX-WP-WHLA8265H-A1	QBiX-WP-APLA3940H-A1
<b>Dimension</b>	188W x 155D x 72H (mm)	188W x 155D x 72H (mm)
<b>CPU</b>	Intel® Core™ i5-8265U Processor, 14nm, 4 cores, 8 threads, up to 3.9 GHz	Intel® Atom® x5-E3940 Processor, 14nm, 4 cores, 4 threads, up to 1.8 GHz
<b>Chipset</b>	—	—
<b>Memory</b>	2 x DDR4 SO-DIMM sockets, Max. Capacity 32 GB, Support Dual Channel DDR4 2400 MHz	2 x DDR3L SO-DIMM sockets, Max. Capacity 8 GB, Support Dual Channel DDR3L 1866 MHz
<b>Ethernet</b>	2 x GbE LAN Ports (Intel® I219V and Intel® I211AT)	2 x GbE LAN Ports (Intel® I211AT)
<b>Graphic</b>	Integrated Graphics Processor - Intel® UHD Graphics 620: 1 x HDMI 1.4	Integrated Graphics Processor - Intel® HD Graphics 500: 1 x HDMI 1.4
<b>Audio</b>	Realtek® Audio Codec	Realtek® Audio Codec
<b>Storage</b>	1 x 2.5" HDD/SSD (SATA 6Gb/s)	1 x 2.5" HDD/SSD (SATA 6Gb/s)
<b>Expansion Slots</b>	1 x 2280 M.2 M-Key (PCIe x4, SATA 6Gb/s) 1 x 2230 M.2 E-Key 1 x Full-size Mini PCIe with SIM slot	1 x 2242 M.2 M-Key (SATA 6Gb/s) 1 x Full-size Mini PCIe with SIM slot
<b>Front I/O</b>	2 x (M12) RJ45 LAN Ports 2 x (IP67) USB 2.0 connector 1 x (IP67) HDMI connector 1 x (IP67) Power switch 1 x (M8) Power & HDD LED	2 x (M12) RJ45 LAN Ports 2 x (IP67) USB 2.0 connector 1 x (IP67) HDMI connector 1 x (IP67) Power switch 1 x (M8) Power & HDD LED
<b>Rear I/O</b>	1 x (M12) COM Port (RS-232/422/485 & RI/5V/12V) 2 x (M12) COM Ports (RS-232) 1 x (M12) GPIO (8 bits) 1 x (M12) DC IN	1 x (M12) COM Port (RS-232/422/485 & RI/5V/12V) 2 x (M12) COM Ports (RS-232) 1 x (M12) GPIO (8 bits) 1 x (M12) DC Jack
<b>Power</b>	+9V~36VDC	+9V~36VDC
<b>Operating Temp.</b>	-20°C to 70°C	-20°C to 80°C
<b>Ordering Information</b>	9BQW8265AMR-SI (Box packing)	9BQW3940AMR-SI (Box packing)
<b>Build in Components</b>	Please contact with your sales representative for more information or e-mailed to : <a href="mailto:sales@gigaipc.com">sales@gigaipc.com</a>	



## QBiX-Jetson Series



Model Name	QBiX-Jetson-NanoAHP-A1	QBiX-Jetson-XavierAHP-A1
<b>Dimension</b>	210W x 169.8D x 55.2H (mm)	210W x 169.8D x 55.2H (mm)
<b>CPU</b>	ARM® Cortex® A57 MPCore (Quad-Core) Processor with NEON Technology	6-core NVIDIA® Carmel Arm® v8.2 64-bit CPU 6MB L2 cache + 4MB L3 cache
<b>Chipset</b>	—	—
<b>Memory</b>	4GB LPDDR4 (module)	8GB LPDDR4 (module)
<b>Ethernet</b>	8 x GbE LAN with PoE 15W/Port (PoE Optional) 2 x GbE LAN	8 x GbE LAN with PoE 15W/Port (PoE Optional) 2 x GbE LAN
<b>Graphic</b>	NVIDIA® Maxwell™ architecture with 128 NVIDIA® CUDA® cores 1 x HDMI 1 x Display Port	384-core NVIDIA® Volta™ GPU with 48 Tensor Cores 1 x HDMI 1 x Display Port
<b>Audio</b>	—	—
<b>Storage</b>	1 x 16G eMMC 5.1 (Module) 1 x SATA 6Gb/s (Swappable 2.5" HDD/SSD)	1 x 16G eMMC 5.1 (Module) 1 x SATA 6Gb/s (Swappable 2.5" HDD/SSD)
<b>Expansion Slots</b>	1 x 3052 M.2 B-Key (USB 3.2 Gen 1x1) 1 x Mini PCIe (USB 2.0 only) 1 x 2230 M.2 E-Key - Intel AC 8265 (Optional) 1 x SIM slot	1 x 3052 M.2 B-Key (PCIe x1+ USB3.2 Gen1x1) 1 x Mini PCIe (USB2.0 only) 1 x 2230 M.2 E-Key - Intel AC 8265 (Optional) 1 x SIM slot
<b>Front I/O</b>	1 x Micro SD card 1 x Micro USB 2.0 (OTD) 1 x HDMI 2.0 1 x Display Port 1 x Power button with LED 1 x HDD LED 1 x GPIO (8 bits) 1 x Recovery button 2 x External Antenna Holes (Optional)	1 x Micro SD card 1 x Micro USB 2.0 (OTD) 1 x HDMI 2.0 1 x Display Port 1 x Power button with LED 1 x HDD LED 1 x GPIO (8 bits) 1 x Recovery button 2 x External Antenna Holes (Optional)
<b>Rear I/O</b>	4 x COM Ports (RS-232/422/485) 1 x 3-pin Terminal block 8 x GbE LAN Ports with PoE 15W/Port 2 x GbE LAN Ports 4 x USB 3.2 Gen 1	4 x COM Ports (RS-232/422/485) 1 x 3-pin Terminal block 8 x GbE LAN Ports with PoE 15W/Port 2 x GbE LAN Ports 4 x USB 3.2 Gen 1
<b>Power</b>	+12V~54VDC (non PoE) +54VDC (PoE support)	+12V~54VDC (non PoE) +54VDC (PoE support)
<b>Operating Temp.</b>	-20°C to 70°C	-20°C to 70°C
<b>Ordering Information</b>	9BQNNANOAMR-SI (Box Packing)	9BQNXAVNAMR-SI (Box Packing)
<b>Build in Components</b>	—	—

## Embedded IoT Series



Model Name	EL-30-4200 (rev. 1.0) EL-30-3350 (rev. 1.0)	EL-20-3710-32G (rev. 1.0) EL-20-3060-32G (rev. 1.0)
<b>Dimension</b>	140.8W x 107.5D x 29.5H (mm)	140.8W x 107.5D x 27H (mm)
<b>CPU</b>	Intel® Pentium® Processor N4200, 14nm, 4 cores, 4 threads, up to 2.5 GHz (EL-30-4200) Intel® Celeron® Processor N3350, 14nm, 2 cores, 2 threads, up to 2.4 GHz (EL-30-3350)	Intel® Pentium® processor N3710, 14nm, 4 cores, 4 threads, up to 2.56 GHz (EL-20-3710-32G) Intel® Celeron® processor N3060, 14nm, 2cores, 2 threads, up to 2.48 GHz (EL-20-3060-32G)
<b>Chipset</b>	FCBGA1296	FCBGA1170
<b>Memory</b>	2 x DDR3L SO-DIMM sockets, Max. Capacity 8 GB, Support Dual Channel DDR3L 1866 MHz	2 x DDR3L SO-DIMM sockets, Max. Capacity 8 GB, Support Dual Channel DDR3L 1600 MHz
<b>Ethernet</b>	2 x GbE LAN Ports (Realtek® RTL8111HS)	2 x GbE LAN Ports (Realtek® RTL8111HS)
<b>Graphic</b>	EL-30-4200: Integrated Graphics Processor - Intel® HD Graphics 505: 2 x HDMI 1.4 EL-30-3350: Integrated Graphics Processor - Intel® HD Graphics 500: 2 x HDMI 1.4 2 independent display outputs	Integrated Graphics Processor - Intel® HD Graphics 500: 2 x HDMI 1.4 2 independent display outputs
<b>Audio</b>	Realtek® Audio Codec	Realtek® Audio Codec
<b>Storage</b>	1 x eMMC 32GB	1 x eMMC 32GB
<b>Expansion Slots</b>	1 x Full-size Mini PCIe with SIM slot/ mSATA 1 x 2230 M.2 E-Key (Wi-Fi preinstalled) 1 x Zigbee module (Optional)	1 x Full-size Mini PCIe/mSATA 1 x Half-size Mini PCIe
<b>Front I/O</b>	4 x USB 3.2 Gen 1 1 x Micro SD Card Slot 1 x Audio Combo Jack (Headphone & Microphone) 1 x Power button with LED 1 x HDD LED	4 x USB 3.2 Gen 1 1 x Micro SD Card Slot 1 x Audio Combo Jack (Headphone & Microphone) 1 x Power button with LED 1 x HDD LED 3 x LED reserved for user configuration
<b>Rear I/O</b>	2 x RJ45 LAN Ports 2 x HDMI 1 x COM Port (RS-232/485)(RJ45 Type) 1 x DC Jack	2 x RJ45 LAN Ports 2 x HDMI 1 x DC Jack
<b>Side I/O</b>	1 x COM Port (RS-232)(Micro-B 5-pin) 1 x Kensington Lock 4 x External Antenna Holes	1 x USB 2.0 (Micro-B) 1 x COM Port (RS-232)(Micro-B 5-pin) 1 x Kensington Lock 3 x External Antenna Holes
<b>TPM</b>	1 x TPM header	1 x TPM header
<b>Power</b>	+12V~19VDC (Adapter 19V/65W)	+12V~19VDC (Adapter 19V/65W)
<b>Operating Temp.</b>	0°C to 40°C	0°C to 40°C
<b>Ordering Information</b>	9BTCV9WMR-SI (Box packing) (EL-30-4200) 9BTCV8WMR-SI (Box packing) (EL-30-3350)	9BTCV5MR-SI (Box packing)(EL-20-3710-32G) 9BTCV7MR-SI (Box packing)(EL-20-3060-32G)
<b>Built-in Components</b>	Memory: 2 x 2GB DDR3L SO-DIMM ZigBee Module MS5168-M03 WiFi/BT Combo module: Intel® AC3168	Memory: 2 x 2GB DDR3L SO-DIMM (EL-20-3710-32G) Memory: 2 x 1GB DDR3L SO-DIMM (EL-20-3060-32G)

## QBiX-Plus Series



Model Name	QBiX-Plus-KBLA7100-A1	QBiX-Plus-APLA3450-A1
<b>Dimension</b>	180W x 117D x 36H (mm)	165W x 105D x 27H (mm)
<b>CPU</b>	Intel® Core™ i3-7100U Processor, 14nm, 2 cores, 4 threads, 2.40 GHz	Intel® Celeron® N3450 Processor, 14nm, 4 cores, 4 threads, up to 2.2 GHz
<b>Chipset</b>	SoC	SoC
<b>Memory</b>	2 x DDR4 SO-DIMM sockets, Max. Capacity 32 GB, Support Dual Channel DDR4 2133 MHz	2 x DDR3L SO-DIMM sockets, Max. Capacity 8 GB, Support Dual Channel DDR3L 1866 MHz
<b>Ethernet</b>	2 x GbE LAN Ports (Intel® I219LM and Intel® I210AT)	2 x GbE LAN Ports (Realtek® RTL8111HS)
<b>Graphic</b>	Integrated Graphics Processor - Intel® HD Graphics 620: 2 x HDMI 2.0 2 independent display outputs	Integrated Graphics Processor - Intel® HD Graphics 500: 2 x HDMI 1.4 2 independent display outputs
<b>Audio</b>	Realtek® Audio Codec	Realtek® Audio Codec
<b>Storage</b>	—	—
<b>Expansion Slots</b>	1 x 2280 M.2 M-Key (PCIe x4, SATA 6Gb/s) 1 x 2230 M.2 E-Key 1 x Full-size Mini PCIe with SIM slot	1 x 2280 M.2 M-Key (SATA 6Gb/s) 1 x 2230 M.2 E-Key 1 x Full-size Mini PCIe with SIM slot
<b>Front I/O</b>	1 x USB 3.2 Gen 2x1 Type C 1 x USB 3.2 Gen 2x1 Type A 2 x USB 3.2 Gen 1 1 x COM Port (RS-232/422/485) 1 x Micro SD card slot 1 x Power button	2 x USB 3.2 Gen 1 1 x COM Port (RS-232/422/485)(RJ45 Type) 1 x Micro SD card slot 1 x Power button
<b>Rear I/O</b>	1 x Combo Audio Jack (Microphone & Headphone) 2 x RJ45 LAN Ports 2 x USB 3.2 Gen 1 2 x HDMI 1 x DC Jack	1 x Combo Audio Jack (Microphone & Headphone) 2 x RJ45 LAN Ports 2 x USB 3.2 Gen 1 2 x HDMI 1 x DC Jack
<b>Side I/O</b>	3 x External Antenna Holes (Optional)	3 x External Antenna Holes (Optional)
<b>TPM</b>	—	—
<b>Power</b>	+19VDC (Adapter 19V/90W)	+19VDC (Adapter 19V/65W)
<b>Operating Temp.</b>	0°C to 40°C	0°C to 50°C
<b>Mounting</b>	VESA 75/100	VESA 75/100
<b>Ordering Information</b>	9BCKABZAMR-SI (Box packing)	9BCBBAZAMR-SI (Box packing)
<b>Built-in Components</b>	Please contact with your sales representative for more information or e-mailed to : <a href="mailto:sales@gigaipc.com">sales@gigaipc.com</a>	

## QBiX-Lite Series

Preliminary



QBiX-Lite Series

Market Name	QBiX-Lite-TGLA1135G7-A1	QBiX-Lite-AMDA1605H-A1
<b>Dimension</b>	234W x 155D x 30H (mm)	234W x 155D x 30H (mm)
<b>CPU</b>	Intel® Core™ i5-1135G7 Processor 10nm SuperFin, 4 cores, 8 threads, up to 4.2 GHz	AMD® RYZEN™ V1605B Embedded Processor, 14nm, 4 cores, 8 threads, up to 3.6GHz
<b>Chipset</b>	SoC	SoC
<b>Memory</b>	2 x DDR4 SO-DIMM sockets, Max. Capacity 64 GB, Support Dual Channel DDR4 3200 MHz	2 x DDR4 SO-DIMM sockets, Max. Capacity 32 GB, Support Dual Channel DDR4 2400 MHz
<b>Ethernet</b>	2 x GbE LAN Ports (Intel® I219V and Intel® I211AT)	2 x GbE LAN Ports (Realtek® RTL8111HS)
<b>Graphic</b>	Integrated Graphics Processor - Intel® Iris X <sup>e</sup> Graphics 2 x HDMI 2.0 2 x DP 1.4 (8K) 4 independent display outputs	Integrated Graphics Processor - AMD® Radeon™ Vega 8 Graphics: 4 x HDMI 2.0 4 independent display outputs EDID Emulation support with AMD utility
<b>Audio</b>	Realtek® Audio Codec	Realtek® Audio Codec
<b>Storage</b>	—	1 x 2.5" HDD/SSD Drive (Optional kit)
<b>Expansion Slots</b>	1 x 2280 M.2 M-Key (PCIe x2, SATA 6Gb/s) 1 x 2230 M.2 E-Key 1 x 3052 M.2 B-Key with SIM Slot (Support 5G)	1 x 2280 M.2 M-Key (PCIe x4, SATA 6Gb/s) 1 x 2230 M.2 E-Key 1 x Full-size Mini PCIe with SIM slot
<b>Front I/O</b>	1 x USB type C (USB 3.2 Gen 2x1, DP Alt Mode & PD Out -30W) (-100W requests to use 250W adapter) 1 x USB type C (USB 3.2 Gen 2x1, PD input-100W) 4 x USB 3.2 Gen 2x1 2 x HDMI 2 x DP 2 x RJ45 LAN Ports 2 x USB 2.0 1 x HDD LED 1 x Screw Type DC Jack	2 x RJ45 LAN Ports 2 x USB 3.2 Gen 1 2 x USB 2.0 4 x HDMI 1 x Power button with LED 1 x HDD LED 1 x Screw Type DC Jack
<b>Rear I/O</b>	1 x COM Port (RS-232) 2 x USB 2.0 2 x Headphone Jack	1 x COM Port (RS-232/422/485 & RI/5V/12V) 2 x USB 2.0 1 x Line out phone jack 2 x External Antenna Holes (Optional)
<b>Side I/O</b>	4 x External Antenna Holes (Optional)	—
<b>TPM</b>	—	Onboard TPM 2.0 security chip INFINEON SLB9665TT2.0
<b>Power</b>	+12V~24VDC (Adapter 19V/135W)	+9V~36VDC (Adapter 19V/65W)
<b>Operating Temp.</b>	0°C to 50°C	0°C to 50°C
<b>Mounting</b>	Wall mount (Default)	Wall mount (Default)
<b>Ordering Information</b>	6BQL1135AMR-SI (Box packing)	6BQL1605AMR-SI (Box packing)
<b>Built-in COM Portponents</b>	—	—

## QBiX-Lite Series



Market Name	QBiX-Lite SDM Kits
<b>Dimension</b>	195W x 158D x 30H (mm)
<b>Support Model</b>	Support SDM module as follows. SDM-1135G7L SDM-1115G4L SDM-7300L – Intel vPro support SDM-7100L SDM-4000L SDM-3350L-QV SDM-3350L-HW
<b>Chipset</b>	—
<b>Memory</b>	Depends on SDM module
<b>Ethernet</b>	Depends on SDM module
<b>Graphic</b>	Depends on SDM module
<b>Audio</b>	Intel® Integrated Audio
<b>Storage</b>	Depends on SDM module
<b>Expansion Slots</b>	Depends on SDM module
<b>Front I/O</b>	Depends on SDM module
<b>Rear I/O</b>	1 x USB 3.2 Gen 1 1 x Display Port (Co-lay with front Display port) 1 x HDMI 1 x UART 1 x DC-Jack 1 x 2x2 Power connector
<b>Side I/O</b>	—
<b>TPM</b>	—
<b>Power</b>	+12V/19V/24VDC (Adapter 19V/65W) (Adapter 19V/90W for SDM-1135G7L , SDM-1115G4L)
<b>Operating Temp.</b>	0°C to 50°C
<b>Mounting</b>	Wall mount, VESA 75/100 (Optional)
<b>Ordering Information</b>	6BSD4000AMR-SI (Box packing)
<b>Built-in COM Portponents</b>	—



## SDM-L Series

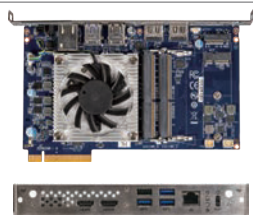

SDM-L Series

Model Name	SDM-1135G7L SDM-1115G4L	SDM-7300L SDM-7100L	SDM-4000L
<b>Dimensions</b>	SDM-Large, 175W x 100D (mm)	SDM-Large, 175W x 100D (mm)	SDM-Large, 175W x 100D (mm)
<b>CPU</b>	Intel® Core™ i5-1135G7 Processor, 10nm SuperFin, 4 cores, 8 threads, up to 4.20 GHz (SDM-1135G7L) Intel® Core™ i3-1115G4 Processor, 10nm SuperFin, 2 cores, 4 threads, up to 4.10 GHz (SDM-1115G4L)	Intel® Core™ i5-7300U Processor, 14nm, 2 cores, 4 threads, up to 3.5 GHz, vPro support (SDM-7300L) Intel® Core™ i3-7100U Processor, 14nm, 2 cores, 4 threads, 2.40 GHz (SDM-7100L)	Intel® Celeron® N4000 Processor, 14nm, 2 Cores, 2 threads, up to 2.6 GHz
<b>VPro</b>	—	Intel® vPro™ Platform Eligibility (SDM-7300L)	—
<b>Memory</b>	2 x DDR4 SO-DIMM sockets, Max. Capacity 64 GB, Support Dual Channel DDR4 3200 MHz	2 x DDR4 SO-DIMM sockets, Max. Capacity 32 GB, Support Dual Channel DDR4 2133 MHz	2 x DDR4 SO-DIMM sockets, Max. Capacity 8 GB, Support Dual Channel DDR4 2400 MHz
<b>Ethernet</b>	1 x GbE LAN Port (Intel® I219V)	1 x GbE LAN Port (7300L: Intel® I219LM) (7100L: Intel® I219V)	1 x GbE LAN Port (Realtek® RTL8111HS)
<b>Graphic</b>	Integrated Graphics Processor - Intel® Iris X®/UHD Graphics: 1 x HDMI 2.0 (SDM), 2 x HDMI 2.0 (Rear), 1 x DisplayPort (SDM) 4 independent display outputs	Integrated Graphics Processor - Intel® HD Graphics 620: 1 x HDMI 2.0 (SDM), 1 x Display Port (Rear/SDM) 2 independent display outputs	Integrated Graphics Processor - Intel® UHD Graphics 600: 1 x HDMI 2.0 (SDM), 1 x Display Port (Rear/SDM) 2 independent display outputs
<b>Audio</b>	Intel® Integrated Audio	Intel® Integrated Audio	Intel® Integrated Audio
<b>Storage</b>	—	—	1 x eMMC 32GB
<b>Expansion Slots</b>	1 x 2280 M.2 M-Key (PCIe x4, SATA 6Gb/s) 1 x 2230 M.2 E-Key	1 x 2280 M.2 M-Key (PCIe x4, SATA 6Gb/s) 1 x 2230 M.2 E-Key	1 x 2280 M.2 M-Key (SATA 6Gb/s) 1 x 2230 M.2 E-Key
<b>Internal I/O</b>	—	—	—
<b>Rear I/O</b>	2 x HDMI 1 x RJ45 LAN Port 3 x USB 3.2 Gen 1 1 x USB 2.0 1 x Power/ HDD LED 2 x External Antenna Holes (Optional) 1 x Reset button 1 x Power button	1 x Display Port 1 x RJ45 LAN Port 4 x USB 3.2 Gen 1 1 x Power/ HDD LED 2 x External Antenna Holes (Optional) 1 x Reset button 1 x Power button	1 x Display Port 1 x RJ45 LAN Port 4 x USB 3.2 Gen 1 1 x Power/ HDD LED 2 x External Antenna Holes (Optional) 1 x Reset button 1 x Power button
<b>TPM</b>	1 x TPM header	1 x TPM header	—
<b>Operating Temp.</b>	0°C to 55°C	0°C to 55°C	0°C to 55°C
<b>Ordering Information</b>	9MTGU5ALMR-SI (Box packing) (SDM-1135G7L) 9MTGU3ALMR-SI (Box packing) (SDM-1115G4L)	9MFLP5ALMR-SI (Box packing) (SDM-7300L) 9MFLP3ALMR-SI (Box packing) (SDM-7100L)	9MZGLKALMR-SI (Box packing)
<b>Built-in Components</b>	—	—	—

## SDM-L Series

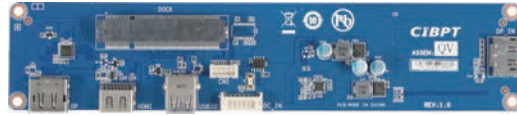

Model Name	SDM Docking Board
<b>Dimensions</b>	190W x 62D (mm)
<b>CPU</b>	—
<b>VPro</b>	—
<b>Memory</b>	—
<b>Ethernet</b>	—
<b>Graphic</b>	—
<b>Audio</b>	—
<b>Storage</b>	—
<b>Expansion Slots</b>	1 x PCIe x8 slot for SDM-L module 1 x Full-size Mini PCIe (PCIe only)
<b>Internal I/O</b>	2 x I2C 1 x GPIO 1 x COM (TX, RX only)
<b>Rear I/O</b>	1 x USB 3.2 Gen 1 1 x Display Port 1 x HDMI 1 x UART 1 x DC-Jack 1 x 2x2 Power connector
<b>TPM</b>	—
<b>Operating Temp.</b>	0°C to 60°C
<b>Ordering Information</b>	—
<b>Built-in Components</b>	—

## Micro-ATX Series



Micro-ATX Series

Model Name	uATX-W48EA	uATX-Q47EA	uATX-H410A
<b>CPU</b>	Support for 11th/10th Generation Intel® Xeon® W12xx, Core™ i3, Pentium® & Celeron® processors	Support for 10th Generation Intel® Core™ i9/i7/i5/i3, Pentium® & Celeron® processors	Support for 10th Generation Intel® Core™ i9/i7/i5/i3, Pentium® & Celeron® processors
<b>Socket</b>	LGA 1200	LGA 1200	LGA 1200
<b>Chipset</b>	Intel® W480E Chipset	Intel® Q470E Chipset	Intel® H410 Chipset
<b>Memory</b>	4 x DDR4 DIMM sockets, Max. Capacity 128 GB, Support Dual Channel DDR4 2933/2666 MHz	4 x DDR4 DIMM sockets, Max. Capacity 128 GB, Support Dual Channel DDR4 2933/2666 MHz	2 x DDR4 DIMM sockets, Max. Capacity 64 GB, Support Dual Channel DDR4 2933/2666 MHz
<b>Ethernet</b>	4 x GbE LAN Ports (Intel® I219LM and Intel® I211AT)	4 x GbE LAN Ports (Intel® I219LM and Intel® I211AT)	2 x GbE LAN Ports (Intel® I219V and Realtek® RTL8111HS)
<b>Graphic</b>	Integrated Graphics Processor - Intel® HD Graphics: 1 x HDMI 1.4, 1 x DP, 1 x VGA, 1 x LVDS 3 independent display outputs	Integrated Graphics Processor - 1 x HDMI 1.4, 1 x DP, 1 x VGA, 1 x LVDS 3 independent display outputs	Integrated Graphics Processor - 1 x HDMI 1.4, 1 x DVI-D, 1 x VGA 2 independent display outputs
<b>Audio</b>	Realtek® Audio Codec	Realtek® Audio Codec	Realtek® Audio Codec
<b>Storage</b>	6 x SATA 6Gb/s Ports (RAID 0/1/5/10)	4 x SATA 6Gb/s Ports (RAID 0/1/5/10)	4 x SATA 6Gb/s Ports
<b>Expansion Slots</b>	2 x PCIe Gen3 x8 (or only 1 x PCIe Gen3 x16 on PCIe x16_A slot as optional) 1 x PCIe x4 (Gen3 x4) 1 x PCIe x1 (Gen3 x1) 1 x 2230 M.2 E-Key (PCIe x1 + USB 2.0) 1 x 2280/2242 M.2 M-Key (PCIe x4, SATA 6Gb/s)	2 x PCIe Gen3 x8 (or only 1 x PCIe Gen3 x16 on PCIe x16_A slot as optional) 1 x PCIe x4 (Gen3 x4) 1 x PCIe x1 (Gen3 x1) 1 x 2230 M.2 E-Key (PCIe x1 + USB 2.0) 1 x 2280/2242 M.2 M-Key (PCIe x4, SATA 6Gb/s)	1 x PCIe x16 (Gen3 x16) 1 x PCIe x4 (Gen3 x2) 2 x PCIe x1 (Gen3 x1)
<b>Internal I/O</b>	1 x 24-pin ATX main power connector 1 x 8-pin ATX 12V power connector 1 x CPU fan header 1 x System fan header 1 x Front panel audio header 1 x VGA header 1 x Backlight Control header 1 x AT/ATX mode select jumper 1 x Front panel header 4 x USB 2.0 headers 1 x COM header (RS-232/422/485 & RI/5V/12V) 1 x COM header (RS-232 & RI/5V/12V) 2 x COM headers (RS-232) 1 x GPIO (8 bits) & SMBUS header 1 x Clear CMOS jumper 1 x Buzzer	1 x 24-pin ATX main power connector 1 x 8-pin ATX 12V power connector 1 x CPU fan header 1 x System fan header 1 x Front panel audio header 1 x VGA header 1 x Backlight Control header 1 x AT/ATX mode select jumper 1 x Front panel header 4 x USB 2.0 headers 1 x COM header (RS-232/422/485 & RI/5V/12V) 1 x COM header (RS-232 & RI/5V/12V) 2 x COM headers (RS-232) 1 x GPIO (8 bits) & SMBUS header 1 x Clear CMOS jumper 1 x Buzzer	1 x 24-pin ATX main power connector 1 x 8-pin ATX 12V power connector 1 x CPU fan header 2 x System fan headers 1 x Front panel header 1 x Front panel audio header 4 x USB 2.0 headers 3 x COM headers (RS-232) 1 x Clear CMOS jumper 1 x Buzzer 1 x Case open header
<b>Rear I/O</b>	1 x HDMI 1 x Display Port 4 x RJ45 LAN Ports 8 x USB 3.2 Gen 1 4 x USB 2.0	1 x HDMI 1 x Display Port 4 x RJ45 LAN Ports 8 x USB 3.2 Gen 1 4 x USB 2.0	3 x Audio Jacks (Line in, Line out, Mic in) 1 x COM Port (RS-232) 1 x HDMI 1 x DVI-D 1 x VGA 2 x RJ45 LAN Ports 4 x USB 3.2 Gen 1
<b>TPM</b>	1 x TPM header	1 x TPM header	Onboard TPM 2.0 security chip INFINEON SLB9670VQ2.0
<b>Operating Temp.</b>	0°C to 60°C	0°C to 60°C	0°C to 60°C
<b>Ordering Information</b>	9MW48EAMMR-SI(Box packing)	9MQ47EAMMR-SI(Box packing)	9MH410AMNR-SI (Bulk packing)

## Micro-ATX Series



Model Name	uATX-Q370A	uATX-H310A
<b>CPU</b>	Support for 9th/8th Generation Intel® Core™ i7/i5/i3, Pentium® & Celeron® processors	Support for 9th/8th Generation Intel® Core™ i7/i5/i3, Pentium® & Celeron® processors
<b>Socket</b>	LGA 1151	LGA 1151
<b>Chipset</b>	Intel® Q370 Chipset	Intel® H310 Chipset
<b>Memory</b>	4 x DDR4 DIMM sockets, Max. Capacity 64 GB, Support Dual Channel DDR4 2666/2400 MHz	2 x DDR4 DIMM sockets, Max. Capacity 32 GB, Support Dual Channel DDR4 2666/2400 MHz
<b>Ethernet</b>	2 x GbE LAN Ports (Intel® I219V and Realtek® RTL8111HS)	2 x GbE LAN Ports (Intel® I219V and Realtek® RTL8111HS)
<b>Graphic</b>	Integrated Graphics Processor - depends on CPU: 1 x HDMI 1.4 1 x DVI-D 1 x VGA 3 independent display outputs	Integrated Graphics Processor - depends on CPU: 1 x HDMI 1.4 1 x DVI-D 1 x VGA 2 independent display outputs
<b>Audio</b>	Realtek® Audio Codec	Realtek® Audio Codec
<b>Storage</b>	6 x SATA 6Gb/s Ports (RAID 0/1/5/10)	4 x SATA 6Gb/s Ports
<b>Expansion Slots</b>	1 x PCIe x16 (Gen3 x16) 1 x PCIe x4 (Gen3 x4) 2 x PCIe x1 (Gen3 x1) 1 x 2280/2260 M.2 M-Key (PCIe x4)	1 x PCIe x16 (Gen3 x16) 1 x PCIe x4 (Gen2 x2) 2 x PCIe x1 (Gen2 x1)
<b>Internal I/O</b>	1 x 24-pin ATX main power connector 1 x 8-pin ATX 12V power connector 1 x CPU fan header 2 x System fan headers 1 x Front panel header 1 x Front panel audio header 4 x USB 2.0 headers 2 x USB 3.2 Gen 1 headers 3 x COM headers (RS-232) 1 x Clear CMOS jumper 1 x Buzzer 1 x AT/ATX mode select jumper	1 x 24-pin ATX main power connector 1 x 8-pin ATX 12V power connector 1 x CPU fan header 2 x System fan headers 1 x Front panel header 1 x Front panel audio header 4 x USB 2.0 headers 3 x COM headers (RS-232) 1 x Clear CMOS jumper 1 x Buzzer
<b>Rear I/O</b>	3 x Audio Jacks (Line in, Line out, Mic in) 1 x COM Port (RS-232) 1 x HDMI 1 x DVI-D 1 x VGA 2 x RJ45 LAN Ports 3 x USB 3.2 Gen 1 1 x USB 3.2 Gen 2x1	3 x Audio Jacks (Line in, Line out, Mic in) 1 x COM Port (RS-232) 1 x HDMI 1 x DVI-D 1 x VGA 2 x RJ45 LAN Ports 4 x USB 3.2 Gen 1
<b>TPM</b>	Onboard TPM 2.0 security chip INFINEON SLB9665VQ2.0	Onboard TPM 2.0 security chip INFINEON SLB9665VQ2.0
<b>Operating Temp.</b>	0°C to 60°C	0°C to 60°C
<b>Ordering Information</b>	9MQ370AMNR-SI (Bulk packing)	9MCH31AMNR-SI (Bulk packing)

## Micro-ATX Series



Micro-ATX Series/ Mini-ITX Series

Model Name	uATX-H110A	uATX-RYZEN
<b>CPU</b>	Support for 7th/6th Generation Intel® Core™ i7/i5/i3, Pentium® & Celeron® processors	Support AMD® RYZEN™ 2 7'5'3 CPU AM4 μPGA (Matisse/ Picasso/ Raven2/ Pinnacle/ Raven/ Summit Ridge)
<b>Socket</b>	LGA 1151	Socket AM4
<b>Chipset</b>	Intel® H110 Chipset	AMD® B450
<b>Memory</b>	2 x DDR4 DIMM sockets, Max. Capacity 32 GB, Support Dual Channel DDR4 2400/2133 MHz	4 x DDR4 DIMM sockets, Max. Capacity 64 GB, Support Dual Channel DDR4 2666/2400/2133 MHz
<b>Ethernet</b>	2 x GbE LAN Ports (Intel® I219LM and Realtek® RTL8111HS)	2 x GbE LAN Ports (Realtek® RTL8111HS)
<b>Graphic</b>	Integrated Graphics Processor - depends on CPU: 1 x HDMI 1.4, 1 x DVI-D, 1 x VGA 2 independent display outputs	Integrated Graphics Processor - Radeon™ Vega 11/ 8/ 3/ Graphics 1 x HDMI 1.4, 1 x Display Port, 1 x VGA 3 independent display outputs
<b>Audio</b>	Realtek® Audio Codec	Realtek® Audio Codec
<b>Storage</b>	4 x SATA 6Gb/s Ports	4 x SATA 6Gb/s Ports (RAID 0/1/10)
<b>Expansion Slots</b>	1 x PCIe x16 (Gen3 x16) 1 x PCIe x4 (Gen2 x2) 2 x PCIe x1 (Gen2 x1)	1 x PCIe x16 (Gen3 x16) 1 x PCIe x4 (Gen2 x2) 2 x PCIe x1 (Gen2 x1) 1 x 2280/2260/2242 M.2 M-Key (PCIe x4, SATA 6Gb/s)
<b>Internal I/O</b>	1 x 24-pin ATX main power connector 1 x 8-pin ATX 12V power connector 1 x CPU fan header 2 x System fan headers 1 x Front panel header 1 x Front panel audio header 2 x USB 2.0 headers 3 x COM headers (RS-232) 1 x Clear CMOS jumper 1 x Buzzer	1 x 24-pin ATX main power connector 1 x 4-pin ATX 12V power connector 1 x CPU fan header 2 x System fan headers 1 x Front panel header 1 x Front audio header 1 x 2W Speaker out header 4 x USB 2.0 headers 2 x USB 3.2 Gen 1 headers 5 x COM headers (RS-232) 1 x PS/2 Keyboard/ Mouse Connector 1 x GPIO (8 bits) & SMBUS header 1 x Clear CMOS jumper 1 x Buzzer 1 x AT/ATX mode select jumper
<b>Rear I/O</b>	3 x Audio Jacks (Line in, Line out, Mic in) 1 x COM Port (RS-232) 1 x HDMI 1 x DVI-D 1 x VGA 2 x RJ45 LAN Ports 4 x USB 3.2 Gen 1	3 x Audio Jacks (Line in, Line out, Mic in) 1 x COM Port (RS-232/422/485 & RI/5V/12V) 1 x HDMI 1 x Display Port 1 x VGA 2 x RJ45 LAN Ports 4 x USB 3.2 Gen 1 1 x USB 3.2 Gen 2x1 1 x USB 3.2 Gen 2x1 (Type C)
<b>TPM</b>	Onboard TPM 2.0 security chip INFINEON SLB9665VQ2.0	1 x TPM header
<b>Operating Temp.</b>	0°C to 60°C	0°C to 60°C
<b>Ordering Information</b>	9MDH11BMNR-SI (Bulk packing)	9MZRYZBMNR-SI (Bulk packing)

## Mini-ITX Series

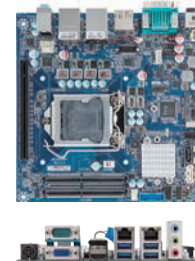
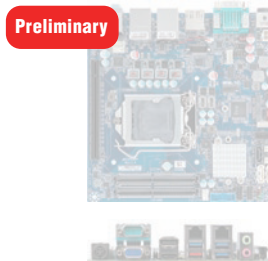

Model Name	mITX-Q47EA	mITX-H42EA	mITX-Q370A
<b>CPU</b>	Support for 10th Generation Intel® Core™ i9/i7/i5/i3, Pentium® & Celeron® processors	Support for 10th Generation Intel® Core™ i9/i7/i5/i3, Pentium® & Celeron® processors	Support for 9th/8th Generation Intel® Core™ i7/i5/i3, Pentium® & Celeron® processors
<b>Socket</b>	LGA 1200	LGA 1200	LGA 1151
<b>Chipset</b>	Intel® Q470E Chipset	Intel® H420E Chipset	Intel® Q370 Chipset
<b>Memory</b>	2 x DDR4 SO-DIMM sockets, Max. Capacity 64 GB, Support Dual Channel DDR4 2933/2666 MHz	2 x DDR4 SO-DIMM sockets, Max. Capacity 64 GB, Support Dual Channel DDR4 2933/2666 MHz	2 x DDR4 SO-DIMM sockets, Max. Capacity 32 GB, Support Dual Channel DDR4 2666/2400 MHz
<b>Ethernet</b>	2 x GbE LAN Ports (Intel® I219LM and Intel® I211AT)	2 x GbE LAN Ports (Intel® I219V and Intel® I211AT)	2 x GbE LAN Ports (Intel® I219LM and Intel® I211AT)
<b>Graphic</b>	Integrated Graphics Processor - depends on CPU: 1 x HDMI 2.0 1 x Display Port 1 x VGA 1 x eDP/LVDS 3 independent display outputs	Integrated Graphics Processor - depends on CPU: 1 x HDMI 2.0 1 x Display Port 1 x VGA 1 x eDP/LVDS 2 independent display outputs	Integrated Graphics Processor - depends on CPU: 1 x HDMI 1.4 1 x Display Port 1 x VGA 1 x eDP 3 independent display outputs
<b>Audio</b>	Realtek® Audio codec	Realtek® Audio Codec	Realtek® Audio Codec
<b>Storage</b>	3 x SATA 6Gb/s Ports (RAID 0/1/5/10)	3 x SATA 6Gb/s Ports	3 x SATA 6Gb/s Ports (RAID 0/1/5/10)
<b>Expansion Slots</b>	1 x PCIe x16 (Gen3 x16) 1 x 2280/2242 M.2 M-Key (PCIe x4, SATA 6Gb/s) 1 x 2230 M.2 E-Key	1 x PCIe x16 (Gen3 x16) 1 x 2280/2242 M.2 M-Key (PCIe x2) 1 x 2230 M.2 E-Key	1 x PCIe x16 (Gen3 x16) 1 x 2280/2242 M.2 M-Key (PCIe x4, SATA 6Gb/s, Optane memory) 1 x 2230 M.2 E-Key
<b>Internal I/O</b>	1 x 4-pin ATX main power connector 2 x SATA power connectors 1 x CPU fan header 1 x System fan header 1 x Front panel header 1 x Front panel audio header 1 x 2W Speaker out header 4 x USB 2.0 headers 1 x COM header (RS-232) 1 x GPIO (8 bits) & SMBUS header 1 x Backlight Control header 1 x Clear CMOS jumper 1 x Buzzer 2 x USB 3.2 Gen 1 headers 1 x ATX Control header 1 x AT/ATX mode select jumper	1 x 4-pin ATX main power connector 2 x SATA power connectors 1 x CPU fan header 1 x System fan header 1 x Front panel header 1 x Front panel audio header 1 x 2W Speaker out header 3 x USB 2.0 headers 2 x USB 3.2 Gen 1 headers 1 x GPIO (8 bits) & SMBUS header 1 x Backlight Control header 1 x Clear CMOS jumper 1 x Buzzer 1 x ATX Control header 1 x AT/ATX mode select jumper	1 x 4-pin ATX main power connector 2 x SATA power connectors 1 x CPU fan header 1 x System fan header 1 x Front panel header 1 x Front panel audio header 1 x 2W Speaker out header 4 x USB 2.0 headers 2 x USB 3.2 Gen 1 headers 1 x COM header (RS-232) 1 x GPIO (8 bits) & SMBUS header 1 x Backlight Control header 1 x Clear CMOS jumper 1 x Buzzer 1 x Case open header 1 x AT/ATX mode select jumper
<b>Rear I/O</b>	2 x Audio Jacks (Line out, Mic in) 1 x COM Port (RS-232/422/485 & RI/5V/12V) 1 x HDMI 1 x Display Port 1 x VGA 2 x RJ45 LAN Ports 1 x USB 3.2 Gen 2x1 1 x DC Jack (+12V/+19~24VDC) 3 x USB 3.2 Gen 1	2 x Audio Jacks (Line out, Mic in) 1 x COM Port (RS-232/422/485 & RI/5V/12V) 1 x HDMI 1 x Display Port 1 x VGA 2 x RJ45 LAN Ports 4 x USB 3.2 Gen 2x1 1 x DC Jack (+12V/+19V~24VDC)	3 x Audio Jacks (Line in, Line out, Mic in) 1 x COM Port (RS-232/422/485 & RI/5V/12V) 1 x HDMI 1 x Display Port 1 x VGA 2 x RJ45 LAN Ports 3 x USB 3.2 Gen 1 1 x USB 3.2 Gen 2x1 1 x DC Jack (+12V/+19V/+24VDC)
<b>TPM</b>	1 x TPM header	1 x TPM header	1 x TPM header
<b>Operating Temp.</b>	0°C to 60°C	0°C to 60°C	0°C to 60°C
<b>Ordering Information</b>	9MQ47EAIMR-SI (Box packing)	9MH42EAIMR-SI (Box packing)	9MCQ37A1NR-SI (Bulk packing)



## Mini-ITX Series

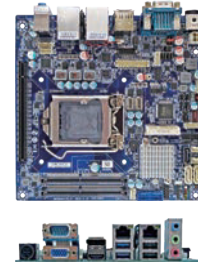

Mini-ITX Series

Model Name	mITX-H310A	mITX-Q170A	mITX-H110A
<b>CPU</b>	Support for 9th/8th Generation Intel® Core™ i7/i5/i3, Pentium® & Celeron® processors	Support for 7th/6th Generation Intel® Core™ i7/i5/i3, Pentium® & Celeron® processors	Support for 7th/6th Generation Intel® Core™ i7/i5/i3, Pentium® & Celeron® processors
<b>Socket</b>	LGA 1151	LGA 1151	LGA 1151
<b>Chipset</b>	Intel® H310 Chipset	Intel® Q170 Chipset	Intel® H110 Chipset
<b>Memory</b>	2 x DDR4 SO-DIMM sockets, Max. Capacity 32 GB, Support Dual Channel DDR4 2666/2400 MHz	2 x DDR4 SO-DIMM sockets, Max. Capacity 32 GB, Support Dual Channel DDR4 2400/2133 MHz	2 x DDR4 SO-DIMM sockets, Max. Capacity 32 GB, Support Dual Channel DDR4 2400/2133 MHz
<b>Ethernet</b>	2 x GbE LAN Ports (Intel® I219V and Intel® I211AT)	2 x GbE LAN Ports (Intel® I219LM and Intel® I211AT)	2 x GbE LAN Ports (Intel® I219V and Intel® I211AT)
<b>Graphic</b>	Integrated Graphics Processor - depends on CPU: 1 x HDMI 1.4, 1 x Display Port 1 x VGA, 1 x LVDS or eDP 2 independent display outputs	Integrated Graphics Processor - depends on CPU: 1 x HDMI 1.4, 1 x Display Port 1 x LVDS or eDP 3 independent display outputs	Integrated Graphics Processor - depends on CPU: 1 x HDMI 1.4, 1 x Display Port, 1 x VGA, 1 x LVDS or eDP 2 independent display outputs
<b>Audio</b>	Realtek® Audio Codec	Realtek® Audio Codec	Realtek® Audio Codec
<b>Storage</b>	2 x SATA 6Gb/s Ports	3 x SATA 6Gb/s Ports (RAID 0/1/5/10) (incl. 1 x SATA supports SATA DOM)	3 x SATA 6Gb/s Ports (incl. 1 x SATA supports SATA DOM)
<b>Expansion Slots</b>	1 x PCIe x16 (Gen3 x16) 1 x 2280/2242 M.2 M-Key (SATA 6Gb/s) 1 x 2230 M.2 E-Key	1 x PCIe x16 (Gen3 x16) 1 x 2280/2242 M.2 M-Key (PCIe x4, SATA 6Gb/s) 1 x Full-size Mini PCIe/mSATA	1 x PCIe x16 (Gen3 x16) 1 x 2280/2242 M.2 M-Key (SATA 6Gb/s) 1 x Full-size Mini PCIe
<b>Internal I/O</b>	1 x 4-pin ATX main power connector 1 x SATA power connector 1 x CPU fan header 1 x System fan header 1 x Front panel header 1 x Front panel audio header 1 x 2W Speaker out header 4 x USB 2.0 headers 2 x COM headers (RS-232) 1 x COM header (RS-232/422/485 & RI/5V/12V) 1 x GPIO (8 bits) & SMBUS header 1 x Backlight Control header 1 x Clear CMOS jumper 1 x Buzzer 1 x ATX Control header 1 x AT/ATX mode select jumper	1 x 4-pin ATX main power connector 2 x SATA power connectors 1 x CPU fan header 1 x System fan header 1 x Front panel header 1 x Front panel audio header 1 x 2W Speaker out header 4 x USB 2.0 headers 2 x USB 3.2 Gen 1 headers 1 x COM header (RS-232/422/485 & RI/5V/12V) 1 x GPIO (8 bits) & SMBUS header 1 x Backlight Control header 1 x Clear CMOS jumper 1 x Buzzer 1 x AT/ATX mode select jumper	1 x 4-pin ATX main power connector 2 x SATA power connectors 1 x CPU fan header 1 x System fan header 1 x Front panel header 1 x Front panel audio header 1 x 2W Speaker out header 3 x USB 2.0 headers 2 x USB 3.2 Gen 1 headers 1 x COM header (RS-232/422/485 & RI/5V/12V) 1 x GPIO (8 bits) & SMBUS header 1 x Backlight Control header 1 x Clear CMOS jumper 1 x Buzzer 1 x AT/ATX mode select jumper
<b>Rear I/O</b>	3 x Audio Jacks (Line in, Line out, Mic in) 1 x COM Port (RS-232/422/485 & RI/5V/12V) 1 x HDMI 1 x Display Port 1 x VGA 2 x RJ45 LAN Ports 4 x USB 3.2 Gen 1 1 x DC Jack (+12V/+19V/+24VDC)	3 x Audio Jacks (Line in, Line out, Mic in) 1 x COM Port (RS-232/422/485 & RI/5V/12V) 1 x HDMI 1 x Display Port 1 x VGA 2 x RJ45 LAN Ports 4 x USB 3.2 Gen 1 1 x DC Jack (+12V/+19V/+24VDC)	3 x Audio Jacks (Line in, Line out, Mic in) 1 x COM Port (RS-232/422/485 & RI/5V/12V) 1 x HDMI 1 x Display Port 1 x VGA 2 x RJ45 LAN Ports 2 x USB 2.0 2 x USB 3.2 Gen 1 1 x DC Jack (+12/+19/+24VDC)
<b>TPM</b>	1 x TPM header	1 x TPM header	1 x TPM header
<b>Operating Temp.</b>	0°C to 60°C	0°C to 60°C	0°C to 60°C
<b>Ordering Information</b>	9MH310AIMR-SI (Box packing)	9MDQ17BIMR-SI (Box packing)	9MDH11LIMR-SI (Box packing)

## Mini-ITX Series

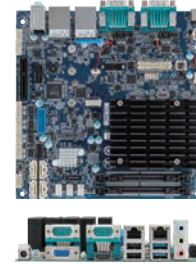

Model Name	mITX-H110B	mITX-4125A
<b>CPU</b>	Support for 7th/6th Generation Intel® Core™ i7/i5/i3, Pentium® & Celeron® processors	Intel® Celeron® J4125 Processor, 14nm, 4 cores, 4 threads, up to 2.7 GHz, fan-less design
<b>Socket</b>	LGA 1151	FCBGA1090
<b>Chipset</b>	Intel® H110 Chipset	—
<b>Memory</b>	2 x DDR4 SO-DIMM sockets, Max. Capacity 32 GB, Support Dual Channel DDR4 2400/2133 MHz	2 x DDR4 SO-DIMM sockets, Max. Capacity 8 GB, Support Dual Channel DDR4 2400 MHz
<b>Ethernet</b>	6 x GbE LAN Ports (1 x Intel® I219V and 5 x Intel® I211AT)	2 x GbE LAN Ports (Realtek® RTL8111HS)
<b>Graphic</b>	Integrated Graphics Processor - depends on CPU: 1 x HDMI 1.4, 1 x VGA 2 independent display outputs	Integrated Graphics Processor - Intel® UHD Graphics 600: 1 x HDMI 2.0, 1 x VGA, 1 x LVDS or eDP 3 independent display outputs
<b>Audio</b>	Realtek® Audio Codec	Realtek® Audio Codec
<b>Storage</b>	2 x SATA 6Gb/s Ports	5 x SATA 6Gb/s Ports (4 x Marvell 88SE9230, support RAID 0/1/10) (1 x supports SATA DOM)
<b>Expansion Slots</b>	1 x PCIe x16 (Gen3 x16) 1 x 2280/2242 M.2 M-Key (SATA 6Gb/s) 1 x Full-size mSATA	1 x PCIe x4 (Gen2 x2) 1 x 2280/2260/2242 M.2 M-Key (SATA 6Gb/s) 1 x 2230 M.2 E-Key (CNVi cards only)
<b>Internal I/O</b>	1 x 4-pin ATX main power connector 2 x SATA power connectors 1 x CPU fan header 1 x System fan header 1 x Front panel header 1 x Front panel audio header 1 x 2W Speaker out header 6 x USB 2.0 headers 2 x COM headers (RS-232/422/485 & RI/5V/12V) 1 x GPIO (8 bits) & SMBUS header 1 x Clear CMOS jumper 1 x Buzzer 1 x AT/ATX mode select jumper	1 x 4-pin ATX main power connector 3 x SATA power connectors 1 x CPU fan header 1 x System fan header 1 x Front panel header 1 x Front panel audio header 1 x 2W Speaker out header 2 x USB 2.0 headers 2 x USB 3.2 Gen 1 headers 4 x COM headers (RS-232) 1 x GPIO (8 bits) & SMBUS header 1 x Case open header 1 x AT/ATX mode select jumper 1 x Backlight Control header 1 x RAID LED header 2 x LAN LED headers 1 x Buzzer
<b>Rear I/O</b>	3 x Audio Jacks (Line in, Line out, Mic in) 1 x HDMI 1 x VGA 6 x RJ45 LAN Ports 4 x USB 3.2 Gen 1 1 x DC Jack (+12V/+19V/+24VDC)	3 x Audio Jacks (Line in, Line out, Mic in) 2 x COM Ports (RS-232/422/485 & RI/5V/12V) 1 x HDMI 1 x VGA 2 x RJ45 LAN Ports 2 x USB 2.0 2 x USB 3.2 Gen 1 1 x DC Jack (+12VDC)
<b>TPM</b>	1 x TPM header	1 x TPM header
<b>Operating Temp.</b>	0°C to 60°C	0°C to 60°C
<b>Ordering Information</b>	9MH110AIMR-SI (Box packing)	9MGMLJAINR-SI (Bulk packing)

## Mini-ITX Series

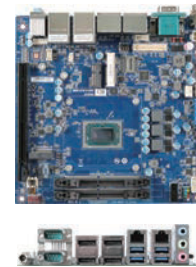

Mini-ITX Series/ Thin-Mini-ITX Series

Model Name	mITX-1900A	mITX-1605A
<b>CPU</b>	Intel® Celeron® J1900 Processor, 22nm, 4 cores, 4 threads, up to 2.42 GHz	AMD® RYZEN™ V1605B Embedded Processor, 14nm, 4 cores, 8 threads, 2.0 GHz, up to 3.6 GHz
<b>Socket</b>	FCBGA1170	FP5 BGA
<b>Chipset</b>	—	—
<b>Memory</b>	2 x DDR3L SO-DIMM sockets, Max. Capacity 8 GB, Support Dual Channel DDR3L 1333 MHz	2 x DDR4 SO-DIMM sockets, Max. Capacity 32 GB, Support Dual Channel DDR4 2400 MHz
<b>Ethernet</b>	2 x GbE LAN Ports (Realtek® RTL8111G)	2 x GbE LAN Ports (Realtek® RTL8111HS)
<b>Graphic</b>	Integrated Graphics Processor - Intel® HD Graphics: 1 x HDMI 1.4 1 x VGA 1 x LVDS 2 independent display outputs	Integrated Graphics Processor - AMD Radeon™ Vega 8 Graphics: 4 x Display Port 1 x LVDS (Share from DP) 4 independent display outputs
<b>Audio</b>	Realtek® Audio Codec	Realtek® Audio Codec
<b>Storage</b>	1 x SATA 3Gb/s Port (incl. 1 x SATA supports SATA DOM)	1 x SATA 6Gb/s Port
<b>Expansion Slots</b>	1 x PCI 1 x Full-size Mini PCIe 1 x Full-size mSATA	1 x PCIe x16 (Gen3 x8) 1 x 2280 M.2 M-Key (SATA 6Gb/s) 1 x 2230 M.2 E-Key 1 x Full-size Mini PCIe with SIM slot
<b>Internal I/O</b>	1 x 4-pin ATX power connector 1 x SATA power header 1 x CPU fan header 1 x System fan header 1 x Front panel header 1 x Front panel audio header 1 x 2W Speaker out header 2 x USB 2.0 headers 1 x COM header (RS-232/422/485) 3 x COM headers (RS-232) 1 x COM header (RS-232 & RI/5V/12V) 1 x GPIO (8 bits) & SMBUS header 1 x PS/2 KB/MS Connector 1 x AT/ATX mode select jumper 1 x Backlight Control header 1 x Clear CMOS jumper 1 x Buzzer	1 x 4-pin ATX power connector 1 x SATA power connector 1 x CPU fan header 1 x System fan header 1 x Front panel header 1 x Front panel audio header 1 x 2W Speaker out header 6 x USB 2.0 headers 2 x COM headers (RS-232) 1 x GPIO (8 bits) & SMBUS header 1 x Backlight Control header 1 x LVDS/ DP jumper 1 x AT/ATX mode select jumper 1 x Clear CMOS jumper
<b>Rear I/O</b>	3 x Audio Jacks (Line in, Line out, Mic in) 1 x COM Port (RS-232) 1 x HDMI 1 x VGA 2 x RJ45 LAN Ports 4 x USB 2.0 1 x USB 3.2 Gen 1 1 x DC Jack (+12VDC)	3 x Audio Jacks (Line in, Line out, Mic in) 2 x COM Ports (RS-232/422/485 & RI/5V/12V) 4 x Display Ports 2 x RJ45 LAN Ports 4 x USB 3.2 Gen 1 1 x DC Jack (+12V~24VDC)
<b>TPM</b>	1 x TPM header	1 x TPM header
<b>Operating Temp.</b>	0°C to 60°C	0°C to 60°C
<b>Ordering Information</b>	Fan version: 9MVBAYAINS-SI (Bulk packing) Fanless version: 9MVBAYAINS-00 (Bulk packing)	Fan version: 9MRZNMIMR-SI (Box packing)

## Thin Mini-ITX Series

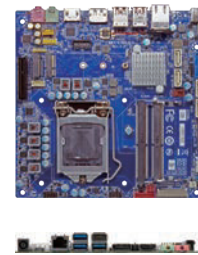
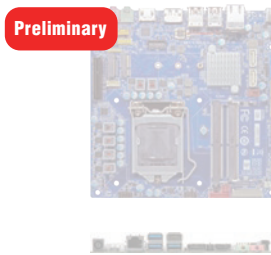

Model Name	iTXL-Q47EA	iTXL-H42EA	iTXL-Q370A
<b>CPU</b>	Support for 10th Generation Intel® Core™ i9/i7/i5/i3, Pentium® & Celeron® processors	Support for 10th Generation Intel® Core™ i9/i7/i5/i3, Pentium® & Celeron® processors	Support for 9th/8th Generation Intel® Core™ i7/i5/i3, Pentium® & Celeron® processors
<b>Socket</b>	LGA 1200	LGA 1200	LGA 1151
<b>Chipset</b>	Intel® Q470E Chipset	Intel® H420E Chipset	Intel® Q370 Chipset
<b>Memory</b>	2 x DDR4 SO-DIMM sockets, Max. Capacity 64 GB, Support Dual Channel DDR4 2933/2666 MHz	2 x DDR4 SO-DIMM sockets, Max. Capacity 64 GB, Support Dual Channel DDR4 2933/2666 MHz	2 x DDR4 SO-DIMM sockets, Max. Capacity 32 GB, Support Dual Channel DDR4 2666/2400 MHz
<b>Ethernet</b>	2 x GbE LAN Ports (Intel® I219LM and Intel® I211AT)	2 x GbE LAN Ports (Intel® I219V and Intel® I211AT)	1 x GbE LAN Port (Intel® I219LM)
<b>Graphic</b>	Integrated Graphics Processor - depends on CPU: 1 x HDMI 2.0 1 x Display Port 1 x LVDS/eDP 3 independent display outputs	Integrated Graphics Processor - depends on CPU: 1 x HDMI 2.0 1 x Display Port 1 x LVDS/eDP 3 independent display outputs	Integrated Graphics Processor - depends on CPU: 1 x HDMI 2.0 1 x Display Port 1 x LVDS 3 independent display outputs
<b>Audio</b>	Realtek® Audio codec with 2W amplifier	Realtek® Audio Codec	Realtek® Audio Codec
<b>Storage</b>	4 x SATA 6Gb/s Ports (RAID 0/1/5/10)	2 x SATA 6Gb/s Ports	4 x SATA 6Gb/s Ports (RAID 0/1/5/10)
<b>Expansion Slots</b>	1 x PCIe x16 (Gen3 x8) 1 x 2280 M.2 M-Key (PCIe x4, SATA 6Gb/s) 1 x 2230 M.2 E-Key	1 x PCIe x16 (Gen3 x8) 1 x 2280 M.2 M-Key (PCIe x2) 1 x 2230 M.2 E-Key	1 x PCIe x4 (Gen3 x4) 1 x 2280/2260 M.2 M-Key (PCIe x4, SATA 6Gb/s, Optane memory) 1 x 2230 M.2 E-Key
<b>Internal I/O</b>	1 x 4-pin ATX main power connector 2 x SATA Power connectors 1 x CPU fan header 1 x System fan header 1 x Front panel header 1 x Front panel audio header 1 x 2W Speaker out header 6 x USB 2.0 headers 1 x COM header (RS-232) 1 x COM header (RS-232/422/485 & RI/5V/12V) 1 x GPIO (8 bits) & SMBUS header 1 x Clear CMOS jumper 1 x Backlight Control header 1 x ATX Control header 1 x AT/ATX mode select jumper	1 x 4-pin ATX main power connector 2 x SATA Power connectors (5V) 1 x CPU fan header 1 x System fan header 1 x Front panel header 1 x Front panel audio header 1 x 2W Speaker out header 3 x USB 2.0 headers 1 x COM header (RS-232) 1 x COM header (RS-232/422/485) 1 x GPIO (8 bits) & SMBUS header 1 x FPD (For LVDS 19V) 1 x FPD_SW 1x3 (For Panel Power SW) 1 x LCD_VCC Pin header 1 x Backlight Control header 1 x ATX Control header 1 x AT/ATX mode select jumper	1 x 2-pin ATX main power connector 1 x SATA Power connector 1 x CPU fan header 1 x System fan header 1 x Front panel header 1 x Front panel audio header 1 x 3W Speaker out header 1 x DMIC header 5 x USB 2.0 headers 2 x USB 3.2 Gen 1 headers 1 x COM header (RS-232) 1 x FPD (For LVDS 19V) 1 x FPD_SW 1x3 (For Panel Power SW) 1 x LCD_VCC Pin header 1 x Backlight Control header 1 x Clear CMOS jumper
<b>Rear I/O</b>	2 x Audio Jacks (Line out, Mic in) 1 x HDMI 1 x Display Port 2 x RJ45 LAN Ports 4 x USB 3.2 Gen 1 1 x DC Jack (+12V/+19~24VDC)	2 x Audio Jacks (Line out, Mic in) 1 x HDMI 1 x Display Port 2 x RJ45 LAN Ports 4 x USB 3.2 Gen 2x1 1 x DC Jack (+12V/+19~24VDC)	2 x Audio Jacks (Line out, Mic in) 1 x HDMI 1 x Display Port 1 x RJ45 LAN Port 3 x USB 3.2 Gen 1 1 x USB 3.2 Gen 1 (Type C) 1 x DC Jack (+12V/+19VDC)
<b>TPM</b>	1 x TPM header	1 x TPM header	1 x TPM header
<b>Operating Temp.</b>	0°C to 60°C	0°C to 60°C	0°C to 60°C
<b>Ordering Information</b>	9MQ47EATMR-SI (Box packing)	9MH42EATMR-SI (Box packing)	9MQ370ATMR-SI (Box packing)

## Thin Mini-ITX Series

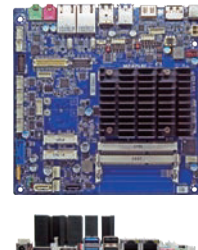

Thin Mini-ITX Series/ QBIP Series (3.5" SBC)

Model Name	iTXL-H110C	iTXL-5105A/ iTXL-4500A	iTXL-3350A
<b>CPU</b>	Support for 7th/6th Generation Intel® Core™ i7/i5/i3, Pentium® & Celeron® processors	Intel® Celeron® N5105 Processor, 10nm, 4 cores, 4 threads, up to 2.9 GHz Intel® Celeron® N4500 Processor, 10nm, 2 cores, 2 threads, up to 2.8 GHz	Intel® Celeron® N3350 Processor, 14nm, 2 cores, 2 threads, up to 2.4 GHz
<b>Socket</b>	LGA 1151	FCBGA1338	FCBGA1296
<b>Chipset</b>	Intel® H110 Chipset	—	—
<b>Memory</b>	2 x DDR4 SO-DIMM sockets, Max. Capacity 32 GB, Support Dual Channel DDR4 2400/2133 MHz	2 x DDR4 SO-DIMM sockets, Max. Capacity 16 GB, Support Dual Channel DDR4 2933 MHz	2 x DDR3L SO-DIMM sockets, Max. Capacity 8 GB, Support Dual Channel DDR3L 1866 MHz
<b>Ethernet</b>	1 x GbE LAN Port (Realtek® RTL8111HS)	2 x GbE LAN Ports (Realtek® RTL8118)	2 x GbE LAN Ports (Realtek® RTL8111HS)
<b>Graphic</b>	Integrated Graphics Processor - depends on CPU: 1 x HDMI 1.4 1 x Display Port 1 x LVDS 2 independent display outputs	Integrated Graphics Processor - Intel® UHD Graphics: 2 x HDMI 2.0 1 x LVDS or eDP 3 independent display outputs	Integrated Graphics Processor - Intel® HD Graphics 500: 1 x HDMI 1.4 1 x Display Port 1 x LVDS or eDP 3 independent display outputs
<b>Audio</b>	Realtek® Audio Codec	Realtek® Audio Codec	Realtek® Audio Codec
<b>Storage</b>	2 x SATA 6Gb/s Ports	1 x SATA 6Gb/s Port	2 x SATA 6Gb/s Ports (1 x switches with mSATA) (incl. 1 x SATA supports SATA DOM)
<b>Expansion Slots</b>	1 x 2280/2260 M.2 M-Key (PCIe x2, SATA 6Gb/s) 1 x 2230 M.2 E-Key	1 x PCIe x1 (Gen3 x1) 1 x 2280 M.2 M-Key (SATA 6Gb/s) 1 x 2230 M.2 E-Key	1 x Full-size Mini PCIe/mSATA 1 x Half-size Mini PCIe (PCIe Only)
<b>Internal I/O</b>	1 x 2-pin ATX main power connector 1 x SATA Power connector 1 x CPU fan header 1 x System fan header 1 x Front panel header 1 x Front panel audio header 1 x 2W Speaker out header 1 x DMIC header 5 x USB 2.0 headers 1 x COM header (RS-232) 1 x FPD (For LVDS 19V) 1 x FPD_SW 1x3 (For Panel Power SW) 1 x LCD_VCC Pin header 1 x Backlight Control header 1 x Clear CMOS jumper	1 x 4-pin ATX main power connector 1 x SATA Power connector 1 x System fan header 1 x Front panel header 1 x Front panel audio header 1 x 2W Speaker out header 6 x USB 2.0 headers 1 x COM header (RS-232/422/485 & RI/5V/12V) 3 x COM headers (RS-232) 1 x GPIO (8 bits) & SMBus header 1 x Backlight Control header 1 x AT/ATX mode select jumper 1 x ATX Control header	1 x 4-pin ATX main power connector 2 x SATA Power connectors 1 x CPU fan header 1 x System fan header 1 x Front panel header 1 x Front panel audio header 1 x 2W Speaker out header 1 x USB 2.0 header 2 x USB 3.2 Gen 1 headers 4 x COM headers (RS-232) 2 x COM headers (RS-232/422/485 & RI/5V/12V) 1 x Backlight Control header 1 x PS/2 KB/MS Connector 1 x GPIO (8 bits) & SMBUS header 1 x Buzzer 1 x Clear CMOS jumper 1 x AT/ATX mode select jumper 1 x Case open header
<b>Rear I/O</b>	2 x Audio Jacks (Line out, Mic in) 1 x HDMI 1 x Display Port 1 x RJ45 LAN Port 4 x USB 3.2 Gen 1 1 x DC Jack (+12V/+19VDC)	2 x Audio Jacks (Line out, Mic in) 2 x HDMI 2 x RJ45 LAN Ports 4 x USB 3.2 Gen 1 1 x DC Jack (+12V~24VDC)	2 x Audio Jacks (Line out, Mic in) 1 x HDMI 1 x Display Port 2 x RJ45 LAN Ports 2 x USB 2.0 2 x USB 3.2 Gen 1 1 x DC Jack (+12VDC)
<b>TPM</b>	1 x TPM header	1 x TPM header	1 x TPM header
<b>Operating Temp.</b>	0°C to 60°C	0°C to 60°C	0°C to 60°C
<b>Ordering Information</b>	9MDH11KINR-SI (Bulk packing)	9MJPLNATMR-SI (Box packing) 9MJPLNBTR-SI (Box packing)	9MZAPLBIMR-SI (Box packing)



## QBiP Series (3.5" SBC)



Model Name	QBiP-1165G7A/ QBiP-1135G7A/ QBiP-1115G4EA	QBiP-1165G7B/ QBiP-1135G7B/ QBiP-1115G4EB
<b>CPU</b>	Intel® Core™ i7-1165G7 Processor, 10nm SuperFin, 4 cores, 8 threads, up to 4.7 GHz Intel® Core™ i5-1135G7 Processor, 10nm SuperFin, 4 cores, 8 threads, up to 4.2 GHz Intel® Core™ i3-1115G4E Processor, 10nm SuperFin, 2 cores, 4 threads, up to 3.9 GHz	Intel® Core™ i7-1165G7 Processor, 10nm SuperFin, 4 cores, 8 threads, up to 4.7 GHz Intel® Core™ i5-1135G7 Processor, 10nm SuperFin, 4 cores, 8 threads, up to 4.2 GHz Intel® Core™ i3-1115G4E Processor, 10nm SuperFin, 2 cores, 4 threads, up to 3.9 GHz
<b>Socket</b>	FCBGA1449	FCBGA1449
<b>Chipset</b>	SoC	SoC
<b>Memory</b>	2 x DDR4 SO-DIMM sockets, Max. Capacity 64 GB, Support Dual Channel DDR4 3200 MHz	2 x DDR4 SO-DIMM sockets, Max. Capacity 64 GB, Support Dual Channel DDR4 3200 MHz
<b>Ethernet</b>	2 x GbE LAN Ports (Intel® I219V and Intel® I211AT)	2 x GbE LAN Ports (Intel® I219V and Intel® I211AT)
<b>Graphic</b>	Integrated Graphics Processor - Intel® Iris X® /UHD Graphics 2 x HDMI 2.0 2 x DP 1.4 (8K) 1 x DP 1.4 (USB Type C (8K)) 1 x eDP 4 independent display outputs	Integrated Graphics Processor - Intel® Iris X® /UHD Graphics 2 x HDMI 2.0 1 x LVDS 3 independent display outputs
<b>Audio</b>	Realtek® Audio Codec	Realtek® Audio Codec
<b>Storage</b>	1 x SATA 6Gb/s Port (RAID 0/1)	1 x SATA 6Gb/s Port (RAID 0/1)
<b>Expansion Slots</b>	1 x 2280 M.2 M-Key (PCIe x2, SATA 6Gb/s) 1 x 2230 M.2 E-Key 1 x 3052 M.2 B-Key with SIM Slot (Support 5G) 1 x PCIe x4 (Board to Wire connector)	1 x 2280 M.2 M-Key (PCIe x2, SATA 6Gb/s) 1 x 2230 M.2 E-Key 1 x Full-size Mini PCIe with SIM slot 1 x PCIe x1 (Board to Wire connector)
<b>Internal I/O</b>	1 x 4-pin box power connector (+12V~24VDC) 1 x SATA Power header 1 x CPU fan header 1 x Front panel header 1 x Front panel audio header 1 x 2W Speaker out header 4 x USB 2.0 headers 1 x COM header (RS-232 & RI/5V/12V) 1 x eDP power header	1 x 4-pin box power connector (+9V~48VDC) 1 x SATA Power header 1 x CPU fan header 1 x System fan header 1 x Front panel header 1 x Front panel audio header 1 x 2W Speaker out header 4 x USB 2.0 headers 3 x COM headers (RS-232/422/485) 1 x Backlight Control header 1 x AT/ATX mode select jumper 1 x GPIO (8 bits) & SMBus header
<b>Rear I/O</b>	1 x USB type C (USB 3.2 Gen 2x1 + DP output-share with DP) & PD Out -100W 1 x USB type C (USB 3.2 Gen 2x1, PD input-100W ) 4 x USB 3.2 Gen 2x1 2 x HDMI 2 x DP 2 x RJ45 LAN Ports	1 x COM Port (RS-232/422/485 & RI/5V/12V) 2 x HDMI 2 x RJ45 LAN Ports 4 x USB 3.2 Gen 2x1
<b>TPM</b>	1 x TPM header	1 x TPM header
<b>Operating Temp.</b>	0°C to 60°C	0°C to 60°C
<b>Ordering Information</b>	9MTGU7ASMR-SI (Box Packing) 9MTGU5ASMR-SI (Box Packing) 9MTGU3ASMR-SI (Box Packing)	9MTGU7BSMR-SI (Box Packing) 9MTGU5BSMR-SI (Box Packing) 9MTGU3BSMR-SI (Box Packing)



## QBiP Series (3.5" SBC)

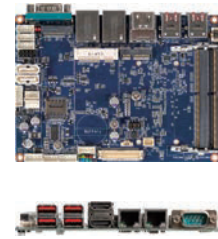
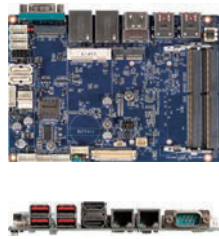

QBiP Series (3.5" SBC)

Model Name	QBiP-8665A/ QBiP-8365A	QBiP-8565A/ QBiP-8265A/ QBiP-8145A
<b>CPU</b>	Intel® Core™ i7-8665UE Processor, 14nm, 4 cores, 8 threads, up to 4.4 GHz, vPro support (QBiP-8665A) Intel® Core™ i5-8365UE Processor, 14nm, 4 cores, 8 threads, up to 4.1 GHz, vPro support (QBiP-8365A)	Intel® Core™ i7-8565U Processor, 14nm, 4 cores, 8 threads, up to 4.6 GHz (QBiP-8565A) Intel® Core™ i5-8265U Processor, 14nm, 4 cores, 8 threads, up to 3.9 GHz (QBiP-8265A) Intel® Core™ i3-8145UE Processor, 14nm, 2 cores, 4 threads, up to 3.9 GHz (QBiP-8145A)
<b>Socket</b>	FCBGA1528	FCBGA1528
<b>Chipset</b>	SoC	SoC
<b>Memory</b>	2 x DDR4 SO-DIMM sockets, Max. Capacity 32 GB, Support Dual Channel DDR4 2400 MHz	2 x DDR4 SO-DIMM sockets, Max. Capacity 32 GB, Support Dual Channel DDR4 2400 MHz
<b>Ethernet</b>	2 x GbE LAN Ports (Intel® I219LM and Intel® I211AT)	2 x GbE LAN Ports (Intel® I219V and Intel® I211AT)
<b>Graphic</b>	Integrated Graphics Processor - Intel® UHD Graphics 620: 2 x HDMI 1.4 1 x LVDS 3 independent display outputs	Integrated Graphics Processor - Intel® UHD Graphics 620: 2 x HDMI 1.4 1 x LVDS 3 independent display outputs
<b>Audio</b>	Realtek® Audio Codec	Realtek® Audio Codec
<b>Storage</b>	2 x SATA 6Gb/s Ports (RAID 0/1/5)	2 x SATA 6Gb/s Ports (RAID 0/1/5)
<b>Expansion Slots</b>	1 x 2280 M.2 M-Key (PCIe x4, SATA 6Gb/s) 1 x 2230 M.2 E-Key 1 x Full-size Mini PCIe with SIM slot	1 x 2280 M.2 M-Key (PCIe x4, SATA 6Gb/s) 1 x 2230 M.2 E-Key 1 x Full-size Mini PCIe with SIM slot
<b>Internal I/O</b>	1 x 4-pin box power connector (+9V~36VDC) (48VDC Optional) 2 x SATA power headers 1 x CPU fan header 1 x System fan header 1 x Front panel header 1 x Front panel audio header 1 x 2W Speaker out header 2 x USB 2.0 headers 3 x COM headers (RS-232) 1 x Backlight Control header 1 x AT/ATX mode select jumper 1 x GPIO (8 bits) & SMBUS header	1 x 4-pin box power connector (+9V~36VDC) (48VDC Optional) 2 x SATA power headers 1 x CPU fan header 1 x System fan header 1 x Front panel header 1 x Front panel audio header 1 x 2W Speaker out header 2 x USB 2.0 headers 3 x COM headers (RS-232) 1 x Backlight Control header 1 x AT/ATX mode select jumper 1 x GPIO (8 bits) & SMBUS header
<b>Rear I/O</b>	1 x COM Port (RS-232/422/485 & RI/5V/12V) 2 x HDMI 2 x RJ45 LAN Ports 4 x USB 3.2 Gen 2x1	1 x COM Port (RS-232/422/485 & RI/5V/12V) 2 x HDMI 2 x RJ45 LAN Ports 4 x USB 3.2 Gen 2x1
<b>TPM</b>	1 x TPM header	1 x TPM header
<b>Operating Temp.</b>	0°C to 60°C	0°C to 60°C
<b>Ordering Information</b>	9MWHLUASMR-SI (Box packing) (QBiP-8665A) 9MWHLUESMR-SI (Box packing) (QBiP-8365A)	9MWHLUASMR-SI (Box packing) (QBiP-8565A) 9MWHLUBSMR-SI (Box packing) (QBiP-8265A) 9MWHLUCSMR-SI (Box packing) (QBiP-8145A)

## QBiP Series (3.5" SBC)

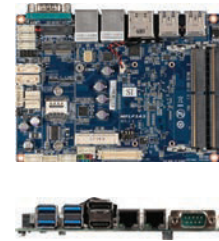
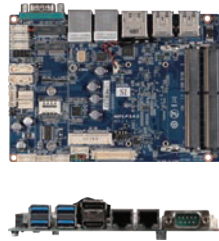

Model Name	QBiP-7600A/ QBiP-7200A/ QBiP-7100A	QBiP-3965A
<b>CPU</b>	Intel® Core™ i7-7600U Processor, 14nm, 2 cores, 4 threads, up to 3.9 GHz, vPro support (QBiP-7600A) Intel® Core™ i5-7200U Processor, 14nm, 2 cores, 4 threads, up to 3.1 GHz (QBiP-7200A) Intel® Core™ i3-7100U Processor, 14nm, 2 cores, 4 threads, 2.4 GHz (QBiP-7100A)	Intel® Celeron® 3965U Processor, 14nm, 2 cores, 2 threads, 2.2 GHz
<b>Socket</b>	FCBGA1356	FCBGA1356
<b>Chipset</b>	SoC	SoC
<b>Memory</b>	2 x DDR4 SO-DIMM sockets, Max. Capacity 32 GB, Support Dual Channel DDR4 2133 MHz	2 x DDR4 SO-DIMM sockets, Max. Capacity 32 GB, Support Dual Channel DDR4 2133 MHz
<b>Ethernet</b>	2 x GbE LAN Ports (Intel® I219V and Intel® I211AT) (7600A: Intel® I219LM and Intel® I211AT)	2 x GbE LAN Ports (Intel® I219V and Intel® I211AT)
<b>Graphic</b>	Integrated Graphics Processor - Intel® HD Graphics 620: 1 x HDMI 2.0 1 x Display Port 1 x LVDS 3 independent display outputs	Integrated Graphics Processor - Intel® HD Graphics 610: 1 x HDMI 2.0 1 x Display Port 1 x LVDS 3 independent display outputs
<b>Audio</b>	Realtek® Audio Codec	Realtek® Audio Codec
<b>Storage</b>	2 x SATA 6Gb/s Ports (RAID 0/1/5)	2 x SATA 6Gb/s Ports
<b>Expansion Slots</b>	1 x 2280 M.2 M-Key (PCIe x4, SATA 6Gb/s) 1 x 2230 M.2 E-Key 1 x Full-size Mini PCIe with SIM slot	1 x 2280 M.2 M-Key (SATA 6Gb/s) 1 x 2230 M.2 E-Key 1 x Full-size Mini PCIe with SIM slot
<b>Internal I/O</b>	1 x 4-pin box power connector (+9V~36VDC) 2 x SATA power headers 1 x CPU fan header 1 x System fan header 1 x Front panel header 1 x Front panel audio header 1 x 2W Speaker out header 2 x USB 2.0 headers 3 x COM headers (RS-232) 1 x Backlight Control header 1 x AT/ATX mode select jumper 1 x GPIO (8 bits) & SMBUS header	1 x 4-pin box power connector (+9V~36VDC) 2 x SATA power headers 1 x CPU fan header 1 x System fan header 1 x Front panel header 1 x Front panel audio header 1 x 2W Speaker out header 2 x USB 2.0 headers 3 x COM headers (RS-232) 1 x Backlight Control header 1 x AT/ATX mode select jumper 1 x GPIO (8 bits) & SMBUS header
<b>Rear I/O</b>	1 x COM Port (RS-232/422/485 & RI/5V/12V) 1 x HDMI 1 x Display Port 2 x RJ45 LAN Ports 4 x USB 3.2 Gen 1	1 x COM Port (RS-232/422/485 & RI/5V/12V) 1 x HDMI 1 x Display Port 2 x RJ45 LAN Ports 4 x USB 3.2 Gen 1
<b>TPM</b>	1 x TPM header	1 x TPM header
<b>Operating Temp.</b>	0°C to 60°C	0°C to 60°C
<b>Ordering Information</b>	9MFLP7BSMR-SI (Box packing) (QBiP-7600A) 9MFLP5ASMR-SI (Box packing) (QBiP-7200A) 9MFLP3ASMR-SI (Box packing) (QBiP-7100A)	9MFLPCASMR-SI (Box packing)

## QBiP Series (3.5" SBC)

Preliminary

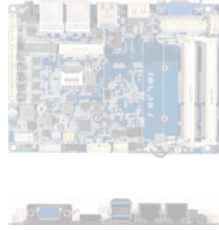

QBiP Series (3.5" SBC)

Model Name	QBiP-6412A/ QBiP-6210A	QBiP-4200B/ QBiP-4200C/ QBiP-3350A
<b>CPU</b>	Intel® Celeron® J6412 Processor, 10nm, 4 cores, 4 threads, up to 2.6 GHz Intel® Celeron® N6210 Processor, 10nm, 2 cores, 2 threads, up to 2.6 GHz	Intel® Pentium® N4200 Processor, 14nm, 4 cores, 4 threads, up to 2.5 GHz (QBiP-4200B/4200C) Intel® Celeron® N3350 Processor, 14nm, 2 cores, 2 threads, up to 2.4 GHz (QBiP-3350A)
<b>Socket</b>	FCBGA1493	FCBGA1296
<b>Chipset</b>	SoC	SoC
<b>Memory</b>	2 x DDR4 SO-DIMM sockets, Max. Capacity 32 GB, Support Dual Channel DDR4 3200 MHz	2 x DDR3L SO-DIMM sockets, Max. Capacity 8 GB, Support Dual Channel DDR3L 1866 MHz
<b>Ethernet</b>	2 x GbE LAN Ports (Intel® I211AT)	2 x GbE LAN Ports (Intel® I211AT)
<b>Graphic</b>	Intel® UHD Graphics for 10th Gen Intel® Processors: 2 x HDMI 2.0 1 x LVDS 3 independent display outputs	Integrated Graphics Processor - Intel® HD Graphics 505: 1 x HDMI 1.4, 1 x VGA, 1 x LVDS 3 independent display outputs
<b>Audio</b>	Realtek® Audio Codec	Realtek® Audio Codec
<b>Storage</b>	1 x SATA 6Gb/s Port	1 x SATA 6Gb/s Port 1 x eMMC 32GB (4200B only)
<b>Expansion Slots</b>	1 x 2280 M.2 M-Key (SATA 6Gb/s) 1 x Full-size Mini PCIe with SIM slot	1 x 2242 M.2 M-Key (SATA 6Gb/s) 1 x Full-size Mini PCIe with SIM slot
<b>Internal I/O</b>	1 x 4-pin box power connector (+9V~36VDC) 1 x SATA Power header 1 x CPU fan header 1 x Front panel header 1 x Front panel audio header 1 x 2W Speaker out header 2 x USB 2.0 headers 1 x COM header (RS-232/422/485 & RI/5V/12V) 3 x COM headers (RS-232) 1 x Backlight Control header 1 x AT/ATX mode select jumper 1 x GPIO (8 bits) & SMBus header 1 x Buzzer header	1 x 4-pin box power connector (+9V~36VDC) 1 x SATA power header 1 x System fan header 1 x Front panel header 1 x 2W Speaker out header 4 x USB 2.0 headers 3 x COM headers (RS-232) 1 x COM header (RS-232/422/485 & RI/5V/12V) 1 x Backlight Control header 1 x AT/ATX mode select jumper 1 x GPIO (8 bits) & SMBUS header 1 x Buzzer header
<b>Rear I/O</b>	1 x Headphone Jack 2 x HDMI 2 x RJ45 LAN Ports 4 x USB 3.2 Gen 2x1	1 x Headphone Jack 1 x HDMI 1 x VGA 2 x RJ45 LAN Ports 2 x USB 3.2 Gen 1
<b>TPM</b>	1 x TPM header	1 x TPM header
<b>Operating Temp.</b>	0°C to 60°C	0°C to 60°C
<b>Ordering Information</b>	9MEHLJASMR-SI (Box packing) (QBiP-6412A) 9MEHLNASMR-SI (Box packing) (QBiP-6210A)	9MZAPLCSMR-SI (Box packing) (QBiP-4200B) 9MZAPLDSMR-SI (Box packing) (QBiP-4200C) 9MZAPLESMSR-SI (Box packing) (QBiP-3350A)

## QBiP Series (3.5" SBC)

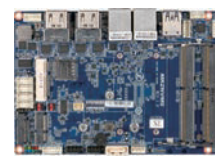
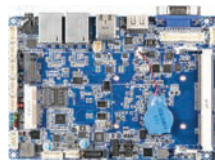

Model Name	QBiP-E3940A	QBiP-1900A	QBiP-1605B
<b>CPU</b>	Intel Atom® x5-E3940 Processor 14nm, 4 cores, 4 threads, up to 1.8 GHz 2M Cache	Intel® Celeron® J1900 Processor 22nm, 4 cores, 4 threads, up to 2.42 GHz	AMD® RYZEN™ V1605B Embedded Processor, 14nm, 4 cores, 8 threads, 2.0 GHz, up to 3.6 GHz
<b>Socket</b>	FCBGA 1296	FCBGA1170	FP5 type 1
<b>Chipset</b>	SoC	SoC	SoC
<b>Memory</b>	2 x DDR3L SO-DIMM sockets, Max. Capacity 8GB Support Dual channel DDR3L 1866 MHz	1 x DDR3L SO-DIMM sockets, Max. Capacity 8GB Support Single channel DDR3L 1333 MHz	2 x DDR4 SO-DIMM sockets, Max. Capacity 32 GB, Support Dual Channel DDR4 2400/2133 MHz
<b>Ethernet</b>	2 x GbE LAN Ports (Intel® i211AT)	2 x GbE LAN Ports (Intel® i211AT)	2 x GbE LAN Ports (Realtek® RTL8111HS)
<b>Graphic</b>	Integrated Graphics Processor - Intel® HD Graphics 500: 1 x HDMI 1.4 1 x VGA 1 x LVDS 3 independent display outputs	Integrated Graphics Processor - Intel® HD Graphics 500: 1 x HDMI 1.4 1 x VGA 1 x LVDS 2 independent display outputs	Integrated Graphics Processor - AMD® Radeon™ Vega 8 Graphics: 4 x HDMI 2.0 1 x eDP (share from HDMI) 4 independent display outputs
<b>Audio</b>	Realtek® Audio Codec	Realtek® Audio Codec	Realtek® Audio Codec
<b>Storage</b>	1 x SATA 6Gb/s Port	1 x SATA 3Gb/s Port	1 x SATA 6Gb/s Port
<b>Expansion Slots</b>	1 x 2242 M.2 M-Key (SATA 6Gb/s) 1 x Full-size Mini PCIe with SIM slot (PCIe x1 + USB2.0) -- support 3G module	1 x 2280 M.2 M-Key (SATA 3Gb/s) 1 x Full-size Mini PCIe with SIM slot	1 x 2280 M.2 M-Key (PCIe x4, SATA 6Gb/s) 1 x 2230 M.2 E-Key 1 x Full-size Mini PCIe with SIM slot
<b>Internal I/O</b>	1 x 4-pin box power connector (+9V~36VDC Full Range) 1 x SATA Power header 1 x System fan header 1 x Front panel header 1 x 2W Speaker out header 4 x USB 2.0 headers 3 x COM headers (RS-232) 1 x COM header (RS-232/422/485 and RI/5V/12V) 1 x Backlight Control header 1 x AT/ATX mode select jumper 1 x GPIO (8-bits) & SMBUS header 1 x Buzzer header	1 x 4-pin box power connector (DC in +9V~36VDC) (+48VDC Optional) 1 x SATA Power header 1 x System fan header 1 x Front panel header 1 x 2W Speaker out header 4 x USB 2.0 headers 2 x COM headers (RS-232) 1 x COM header (RS-232/422/485) 1 x COM header (RS-232/422/485 and RI/5V/12V) 1 x Backlight Control header 1 x AT/ATX mode select jumper 1 x GPIO (8-bits) & SMBUS header 1 x Buzzer header	1 x 4-pin box power connector (+9V~36VDC) 1 x SATA power header 1 x CPU fan header 1 x System fan header 1 x Front panel header 1 x 2W Speaker out header 1 x Front panel audio header 1 x 2W Speaker out header 4 x USB 2.0 headers 2 x COM headers (RS-232) 2 x COM headers (RS-232/422/485 & RI/5V/12V) 1 x Backlight Control header 1 x AT/ATX mode select jumper 1 x eDP/HDMI jumper 1 x GPIO (8 bits) & SMBUS header 1 x Buzzer
<b>Rear I/O</b>	1 x Headphone jack 1 x HDMI 1 x VGA 2 x RJ45 LAN Ports 2 x USB 3.2 Gen 1	1 x Headphone jack 1 x HDMI 1 x VGA 2 x RJ45 LAN Ports 1 x USB 2.0 1 x USB 3.2 Gen 1	4 x HDMI 2 x RJ45 LAN Ports 2 x USB 3.2 Gen 1
<b>TPM</b>	1 x TPM Header	1 x TPM Header	Onboard TPM 2.0 security chip INFINEON SLB9665TT2.0
<b>Operating Temp.</b>	0°C to 60°C	0°C to 60°C	0°C to 60°C
<b>Ordering Information</b>	9MAPLKASMR-SI (Box Packing)	9MBAYTASMR-SI (Box Packing)	9MRZNVOSMR-SI (Box packing)

## QBiP Wide Temperature Series

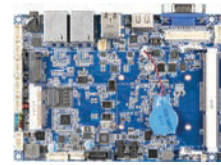
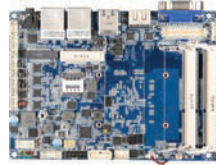
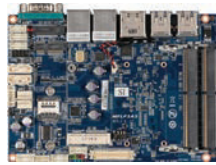

QBiP Wide Temperature Series/ QBi Series (10 x 10 Embedded Compact Board)

Model Name	QBiP-7200AT/ QBiP-7100AT	QBiP-E3940AT	QBiP-1900AT
<b>CPU</b>	Intel® Core™ i5-7200U Processor, 14nm, 2 cores, 4 threads, up to 3.1GHz (QBiP-7200AT) Intel® Core™ i3-7100U Processor, 14nm, 2 cores, 4 threads, 2.4GHz (QBiP-7100AT)	Intel® Atom® x5-E3940 Processor, 14nm, 4 cores, 4 threads, up to 1.8 GHz	Intel® Celeron® J1900 Processor, 22nm, 4 cores, 4 threads, up to 2.42 GHz
<b>Socket</b>	FCBGA1356	FCBGA1296	FCBGA1170
<b>Chipset</b>	SoC	SoC	SoC
<b>Memory</b>	2 x DDR4 SO-DIMM sockets, Max. Capacity 32 GB, Support Dual Channel DDR4 2133 MHz	2 x DDR3L SO-DIMM sockets, Max. Capacity 8 GB, Support Dual Channel DDR3L 1866 MHz	1 x DDR3L SO-DIMM socket, Max. Capacity 8 GB, Support Single Channel DDR3L 1333 MHz
<b>Ethernet</b>	2 x GbE LAN Ports (Intel® I219V and Intel® I211AT)	2 x GbE LAN Ports (Intel® I211AT)	2 x GbE LAN Ports (Intel® I211AT)
<b>Graphic</b>	Integrated Graphics Processor - Intel® HD Graphics 620: 1 x HDMI 2.0, 1 x Display Port 1 x LVDS 3 independent display outputs	Integrated Graphics Processor - Intel® HD Graphics 500: 1 x HDMI 1.4, 1 x VGA, 1 x LVDS 3 independent display outputs	Integrated Graphics Processor - Intel® HD Graphics: 1 x HDMI 1.4, 1 x VGA, 1 x LVDS 2 independent display outputs
<b>Audio</b>	Realtek® Audio Codec	Realtek® Audio Codec	Realtek® Audio Codec
<b>Storage</b>	2 x SATA 6Gb/s Ports (RAID 0/1/5)	1 x SATA 6Gb/s Port	1 x SATA 3Gb/s Port
<b>Expansion Slots</b>	1 x 2280 M.2 M-Key (PCIe x4, SATA 6Gb/s) 1 x 2230 M.2 E-Key 1 x Full-size Mini PCIe with SIM slot	1 x 2242 M.2 M-Key (SATA 6Gb/s) 1 x Full-size Mini PCIe with SIM slot	1 x 2280 M.2 M-Key (SATA 3Gb/s) 1 x Full-size Mini PCIe with SIM slot
<b>Internal I/O</b>	1 x 4-pin box power connector (+9V~36VDC) 2 x SATA power headers 1 x CPU fan header 1 x System fan header 1 x Front panel header 1 x Front panel audio header 1 x 2W Speaker out header 2 x USB 2.0 headers 3 x COM headers (RS-232) 1 x Backlight Control header 1 x AT/ATX mode select jumper 1 x GPIO (8 bits) & SMBUS header	1 x 4-pin box power connector (+9V~36VDC) 1 x SATA power header 1 x System fan header 1 x Front panel header 1 x 2W Speaker out header 4 x USB 2.0 headers 3 x COM headers (RS-232) 1 x COM header (RS-232/422/485 & RI/5V/12V) 1 x Backlight Control header 1 x AT/ATX mode select jumper 1 x GPIO (8 bits) & SMBUS header 1 x Buzzer header	1 x 4-pin box power connector (+9V~36VDC) (+48VDC optional) 1 x SATA power header 1 x System fan header 1 x Front panel header 1 x 2W Speaker out header 4 x USB 2.0 headers 2 x COM headers (RS-232) 1 x COM header (RS-232/422/485) 1 x COM header (RS-232/422/485 & RI/5V/12V) 1 x Backlight Control header 1 x AT/ATX mode select jumper 1 x GPIO (8 bits) & SMBUS header 1 x Buzzer header
<b>Rear I/O</b>	1 x COM Port (RS-232/422/485 & RI/5V/12V) 1 x HDMI 1 x Display Port 2 x RJ45 LAN Ports 4 x USB 3.2 Gen 1	1 x Headphone Jack 1 x HDMI 1 x VGA 2 x RJ45 LAN Ports 2 x USB 3.2 Gen 1	1 x Headphone Jack 1 x HDMI 1 x VGA 2 x RJ45 LAN Ports 1 x USB 2.0 1 x USB 3.2 Gen 1
<b>TPM</b>	1 x TPM header	1 x TPM header	1 x TPM header
<b>Operating Temp.</b>	-20°C to 70°C	-40°C to 85°C	-40°C to 85°C
<b>Ordering Information</b>	9MFLP5ASMR-SI1 (Box packing) (QBiP-7200AT) 9MFLP3ASMR-SI1 (Box packing) (QBiP-7100AT)	9MAPLKASMR-SI1 (Box packing)	9MBAYTASMR-SI1 (Box packing)

## QBi Series (10 x 10 Embedded Compact Board)

Preliminary

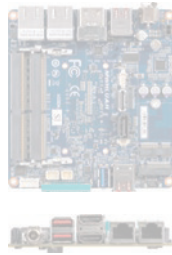

Model Name	QBi-1165G7A/ QBi-1135G7A/ QBi-1115G4EA	QBi-8665A/ QBi-8365A
<b>CPU</b>	Intel® Core™ i7-1165G7 Processor, 10nm SuperFin, 4 cores, 8 threads, up to 4.7 GHz (QBi-1165G7A) Intel® Core™ i5-1135G7 Processor, 10nm SuperFin, 4 cores, 8 threads, up to 4.2 GHz (QBi-1135G7A) Intel® Core™ i3-1115G4E Processor, 10nm SuperFin, 2 cores, 4 threads, up to 3.90 GHz (QBi-1115G4EA)	Intel® Core™ i7-8665UE Processor, 14nm, 4 cores, 8 threads, up to 4.4 GHz, vPro support (QBi-8665A) Intel® Core™ i5-8365UE Processor, 14nm, 4 cores, 8 threads, up to 4.1 GHz, vPro support (QBi-8365A)
<b>Socket</b>	FCBGA1449	FCBGA1528
<b>Chipset</b>	SoC	SoC
<b>Memory</b>	2 x DDR4 SO-DIMM sockets, Max. Capacity 64 GB, Support Dual Channel DDR4 3200 MHz	2 x DDR4 SO-DIMM sockets, Max. Capacity 32 GB, Support Dual Channel DDR4 2400 MHz
<b>Ethernet</b>	2 x GbE LAN Ports (Intel® I219V and Realtek® RTL8111HS)	2 x GbE LAN Ports (Intel® I219LM and Realtek® RTL8111HS)
<b>Graphic</b>	Integrated Graphics Processor - Intel® Iris X®/UHD Graphics 620: 2 x HDMI 2.0 2 independent display outputs	Integrated Graphics Processor - Intel® UHD Graphics 620: 2 x HDMI 1.4 1 x eDP 3 independent display outputs
<b>Audio</b>	Realtek® Audio Codec	Realtek® Audio Codec
<b>Storage</b>	—	1 x SATA 6Gb/s Port (RAID 0/1)
<b>Expansion Slots</b>	1 x 2280 M.2 M-Key (PCIe x4, SATA 6Gb/s) 1 x 2230 M.2 E-Key	1 x 2280 M.2 M-Key (PCIe x4, SATA 6Gb/s) 1 x 2230 M.2 E-Key
<b>Internal I/O</b>	1 x 2-pin power connector 1 x CPU fan header 1 x Front panel header 1 x Front panel audio header 1 x USB 2.0 header	1 x 2-pin power connector 1 x SATA/eDP Power header 1 x CPU fan header 1 x Front panel header 1 x Front panel audio header/GPIO (8 bits) & SMBUS header 1 x USB 2.0 header 1 x Vertical USB 3.2 Gen 1 (Flexible to PCIe x1)
<b>Front IO</b>	2 x USB 3.2 Gen 2x1 1 x Power button 1 x COM Port (RS-232/422/485)	2 x USB 3.2 Gen 2x1 1 x Power button 1 x COM Port (RS-232/422/485)
<b>Rear IO</b>	2 x HDMI 2 x RJ45 LAN Ports 2 x USB 3.2 Gen 2x1 1 x Screw type DC Jack (+9V~48VDC)	2 x HDMI 2 x RJ45 LAN Ports 2 x USB 3.2 Gen 2x1 1 x Screw type DC Jack (+9V~36VDC)
<b>Side IO</b>	—	—
<b>TPM</b>	—	—
<b>Operating Temp.</b>	0°C to 60°C	0°C to 60°C
<b>Ordering Information</b>	9MTGU7AHMR-SI (Box packing)(QBi-1165G7A) 9MTGU5AHMR-SI (Box packing)(QBi-1135G7A) 9MTGU3AHMR-SI (Box packing)(QBi-1115G4EA)	9MWHLUDHMR-SI (Box packing) (QBi-8665A) 9MWHLUEHMR-SI (Box packing) (QBi-8365A)



## QBi Series (10 x 10 Embedded Compact Board)



QBi Series (10 x 10 Embedded Compact Board)

Model Name	QBi-8565A/ QBi-8265A/ QBi-8145A	QBi-7100B	QBi-3965B
<b>CPU</b>	Intel® Core™ i7-8565U Processor, 14nm, 4 cores, 8 threads, up to 4.6 GHz (QBi-8565A) Intel® Core™ i5-8265U Processor, 14nm, 4 cores, 8 threads, up to 3.9 GHz (QBi-8265A) Intel® Core™ i3-8145UE Processor, 14nm, 2 cores, 4 threads, up to 3.9 GHz (QBi-8145A)	Intel® Core™ i3-7100U Processor, 14nm, 2 cores, 4 threads, 2.4 GHz	Intel® Celeron® 3965U Processor, 14nm, 2 cores, 2 threads, 2.2 GHz
<b>Socket</b>	FCBGA1528	FCBGA1356	FCBGA1356
<b>Chipset</b>	SoC	SoC	SoC
<b>Memory</b>	2 x DDR4 SO-DIMM sockets, Max. Capacity 32 GB, Support Dual Channel DDR4 2400 MHz	2 x DDR4 SO-DIMM sockets, Max. Capacity 32 GB, Support Dual Channel DDR4 2133 MHz	2 x DDR4 SO-DIMM sockets, Max. Capacity 32 GB, Support Dual Channel DDR4 2133 MHz
<b>Ethernet</b>	2 x GbE LAN Ports (Intel® I219V and Realtek® RTL8111HS)	1 x GbE LAN Port (Intel® I219V)	1 x GbE LAN Port (Intel® I219V)
<b>Graphic</b>	Integrated Graphics Processor - Intel® UHD Graphics 620: 2 x HDMI 1.4 1 x eDP 3 independent display outputs	Integrated Graphics Processor - Intel® HD Graphics 620: 1 x HDMI 2.0 1 x Mini Display Port 1 x eDP 3 independent display outputs	Integrated Graphics Processor - Intel® HD Graphics 620: 1 x HDMI 2.0 1 x Mini Display Port 1 x eDP 3 independent display outputs
<b>Audio</b>	Realtek® Audio Codec	Intel® Integrated Audio	Intel® Integrated Audio
<b>Storage</b>	1 x SATA 6Gb/s Port (RAID 0/1) 1 x 2280 M.2 M-Key (PCIe x4, SATA 6Gb/s)	1 x SATA 6Gb/s Port (RAID 0/1) 1 x 2280 M.2 M-Key (PCIe x4, SATA 6Gb/s)	1 x SATA 6Gb/s Port 1 x 2280 M.2 M-Key (SATA 6Gb/s)
<b>Expansion Slots</b>	1 x 2230 M.2 E-Key	1 x 2230 M.2 E-Key	1 x 2230 M.2 E-Key
<b>Internal I/O</b>	1 x 2-pin power connector 1 x SATA/eDP power header 1 x CPU fan header 1 x Front panel header 1 x Front panel audio header/ GPIO (8 bits) & SMBUS header 1 x USB 2.0 header 1 x Vertical USB 3.2 Gen 1 (Flexible to PCIe x1)	1 x 2-pin power connector 1 x SATA power header 1 x CPU fan header 1 x Front panel header 2 x USB 2.0 headers 1 x USB 3.2 Gen 1 header 1 x COM header (RS-232)	1 x 2-pin power connector 1 x SATA power header 1 x CPU fan header 1 x Front panel header 2 x USB 2.0 headers 1 x USB 3.2 Gen 1 header 1 x COM header (RS-232)
<b>Front IO</b>	2 x USB 3.2 Gen 2x1 1 x Power button 1 x COM Port (RS-232/422/485)	2 x USB 3.2 Gen 1 1 x Power button	2 x USB 3.2 Gen 1 1 x Power button
<b>Rear IO</b>	2 x HDMI 2 x RJ45 LAN Ports 2 x USB 3.2 Gen 2x1 1 x Screw type DC Jack (+9V~36VDC)	1 x HDMI 1 x Mini Display Port 1 x RJ45 LAN Port 2 x USB 3.2 Gen 1 1 x DC Jack (+12V~24VDC)	1 x HDMI 1 x Mini Display Port 1 x RJ45 LAN Port 2 x USB 3.2 Gen 1 1 x DC Jack (+12V~24VDC)
<b>Side IO</b>	—	—	—
<b>TPM</b>	—	—	—
<b>Operating Temp.</b>	0°C to 60°C	0°C to 60°C	0°C to 60°C
<b>Ordering Information</b>	9MWHLUAHMR-SI (Box packing) (QBi-8565A) 9MWHLUBHMR-SI (Box packing) (QBi-8265A) 9MWHLUCHMR-SI (Box packing) (QBi-8145A)	9MFLP3AHNR-SI (Bulk packing)	9MFLPCAHR-SI (Box packing)

## QBi Series (10 x 10 Embedded Compact Board)

Preliminary



Model Name	QBi-6412A / QBi-6210A	QBi-4125A	QBi-4200B
<b>CPU</b>	Intel® Celeron® J6412 Processor, 10nm, 4 cores, 4 threads, up to 2.6 GHz Intel® Celeron® N6210 Processor, 10nm, 2 cores, 2 threads, up to 2.6 GHz	Intel® Celeron® J4125 Processor, 14nm, 4 cores, 4 threads, up to 2.7 GHz	Intel® Pentium® N4200 Processor, 14nm, 4 cores, 4 threads, up to 2.5 GHz
<b>Socket</b>	FCBGA1493	FCBGA1090	FCBGA1296
<b>Chipset</b>	SoC	SoC	SoC
<b>Memory</b>	1 x DDR4 SO-DIMM socket, Max. Capacity 32 GB, Support Single Channel DDR4 3200 MHz	1 x DDR4 SO-DIMM socket, Max. Capacity 8 GB, Support Single Channel DDR4 2400 MHz	1 x DDR3L SO-DIMM socket, Max. Capacity 8 GB, Support Single Channel DDR3L 1866 MHz
<b>Ethernet</b>	2 x GbE LAN Ports (Intel® I211AT and Realtek® RTL8111HS)	2 x GbE LAN Ports (Intel® I211AT and Realtek® RTL8111HS)	1 x GbE LAN Port (Realtek® RTL8111HS)
<b>Graphic</b>	Intel® UHD Graphics for 10th Gen Intel® Processors: 2 x HDMI 1.4 1 x eDP 3 independent display outputs	Integrated Graphics Processor - Intel® UHD Graphics 600: 2 x HDMI 1.4 1 x eDP 3 independent display outputs	Integrated Graphics Processor - Intel® HD Graphics 505: 1 x HDMI 1.4 1 x VGA 1 x eDP 3 independent display outputs
<b>Audio</b>	Realtek® Audio Codec	Realtek® Audio Codec	Realtek® Audio Codec
<b>Storage</b>	1 x SATA 6Gb/s Port	1 x SATA 6Gb/s Port	1 x SATA 6Gb/s Port
<b>Expansion Slots</b>	1 x 2280 M.2 M-Key (SATA 6Gb/s) 1 x 2230 M.2 E-Key	1 x 2280 M.2 M-Key (SATA 6Gb/s) 1 x 2230 M.2 E-Key	1 x 2230 M.2 E-Key
<b>Internal I/O</b>	1 x 2-pin power connector 1 x SATA Power header 1 x CPU fan header 1 x Front panel header 2 x USB 2.0 headers 1 x Speaker out header	1 x SATA power header 1 x CPU fan header 1 x power button header 2 x USB 2.0 headers 1 x Speaker out header	1 x 2-pin power connector 1 x SATA power header 1 x CPU fan header 1 x power button header 1 x Front panel header 2 x USB 2.0 headers 1 x USB 3.2 Gen 1 header 1 x COM header (RS-232)
<b>Front IO</b>	2 x USB 3.2 Gen 1 1 x COM Port (RS-232) 1 x Headphone Jack 1 x Power button	2 x USB 3.2 Gen 1 1 x COM Port (RS-232) 1 x Headphone Jack 1 x Power button	2 x USB 3.2 Gen 1 1 x Power button 1 x Audio Combo Jack (Headphone & Microphone)
<b>Rear IO</b>	2 x RJ45 LAN Ports 2 x USB 3.2 Gen 1 2 x HDMI 1 x DC Jack (+12V~19VDC)	2 x RJ45 LAN Ports 2 x USB 3.2 Gen 1 2 x HDMI 1 x DC Jack (+12V~19VDC)	1 x HDMI 1 x VGA 1 x RJ45 LAN Port 2 x USB 3.2 Gen 1
<b>Side IO</b>	—	—	1 x DC Jack (+12V~24VDC)
<b>TPM</b>	—	—	—
<b>Operating Temp.</b>	0°C to 60°C	0°C to 60°C	0°C to 60°C
<b>Ordering Information</b>	9MEHLJAHMR-SI (Box packing) (QBi-6412A) 9MEHLNAHMR-SI (Box packing) (QBi-6210A)	9MGMLKAHMR-SI (Box packing)	9MZAPLBHMR-SI (Box packing)

## Building a **SMARTER** Tomorrow



# GIGAIPC

**GIGAIPC CO., LTD.**

GIGABYTE TECHNOLOGY GROUP

B1-A, No.205, Sec. 3, Beixin Rd., Xindian Dist.,  
New Taipei City 23143, Taiwan (R.O.C)

TEL: +886-2-89131312    FAX: +886-2-89131332  
Email: [sales@gigaipc.com](mailto:sales@gigaipc.com)    URL: [www.gigaipc.com](http://www.gigaipc.com)

技宸股份有限公司

技嘉科技集團

新北市 231 新店區北新路三段 205 號 B1-A

TEL: +886-2-89131312    FAX: +886-2-89131332  
Email: [sales@gigaipc.com](mailto:sales@gigaipc.com)    URL: [www.gigaipc.com](http://www.gigaipc.com)



GMKT-C2022001