



Building a Smarter Tomorrow

2022 Product Catalog 2H

intel partner Titanium IoT Solutions



Automation



Transportation



Digital Signage



Retail



Company Profile



GIGAIPC, established in 2018 as an independent IPC-focused spin-off from GIGABYTE, is driven by a passion for technology and agile intuition of our customer's requirements. GIGAIPC has an exceptionally sophisticated Research & Development department, enabling us to keep up with the rapid pace of today's technology. Combined with our outstanding research and design ability, GIGAIPC also has an award-winning Taiwan-based manufacturing facility, synchronizing with GIGAIPC's R&D department to deliver high quality and reliable products. GIGAIPC is a young and energetic organization driven by surpassing our customer's expectations, and we promise to offer our customers not only high-quality computing platforms but also world-class service and support. As a result, GIGAIPC's service centers have been established in most major cities worldwide, and our global presence is still being actively expanding, all ready to offer the best service to our customers.



Company Profile/ Naming Rule

GIGAIPC is an Associate member of the Intel® Internet of Things Solutions Alliance.



“Building a SMARTER Tomorrow”

The strengths of GIGAIPC are based on the advantages, skills and expertise we have built to realize this vision, including being customer focused and striving for high quality. GIGAIPC is determined to keep reinforcing these strengths as our principles to achieve maximum customer satisfaction.

Key Advantages to work with GIGAIPC

Technology	<ol style="list-style-type: none"> 1. Intel®, AMD etc. Key vendor direct support 2. Latest technical and over 10 years RD development experiences 3. Large coverage rate of design verification
Flexibility	<ol style="list-style-type: none"> 1. Huge off-the-shelf products combination and rich ODM/OEM experiences 2. Multiple manufacturing sites for different high-mix and low-volume requirements 3. Task-force team with multiple functions to align customer's requirements
Quality	<ol style="list-style-type: none"> 1. Component IPC, audit and approval system 2. Rich resources and equipments on design and manufacture quality system 3. Emphasizing closed-loop of PDCA cycle for continuous improvement
Service	<ol style="list-style-type: none"> 1. Worldwide RMA service coverage more than 80 service centers globally
Capability	<ol style="list-style-type: none"> 1. Customization capability 2. Direct field application engineer support and quick response 3. Customized manufacturing process, quality control and delivery solutions

Motherboard's Naming Rule -

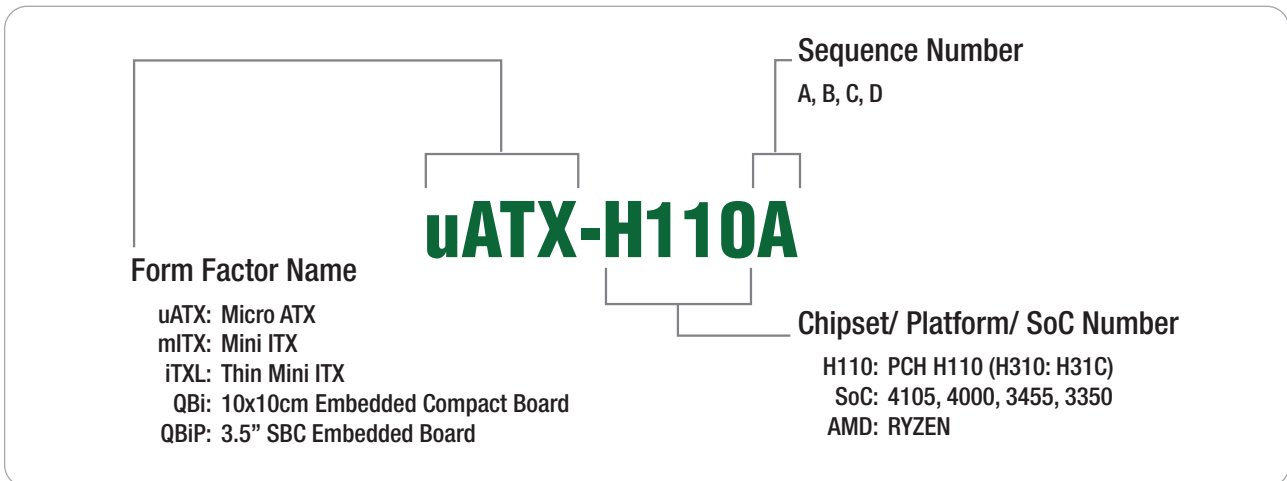

System's Naming Rule -

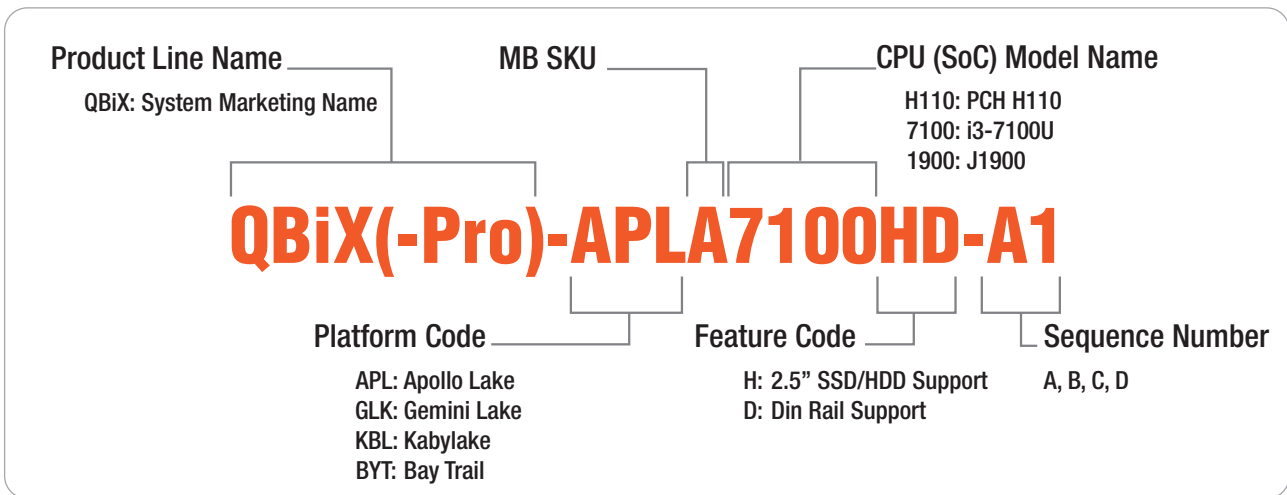

Motherboard's Form Factor -

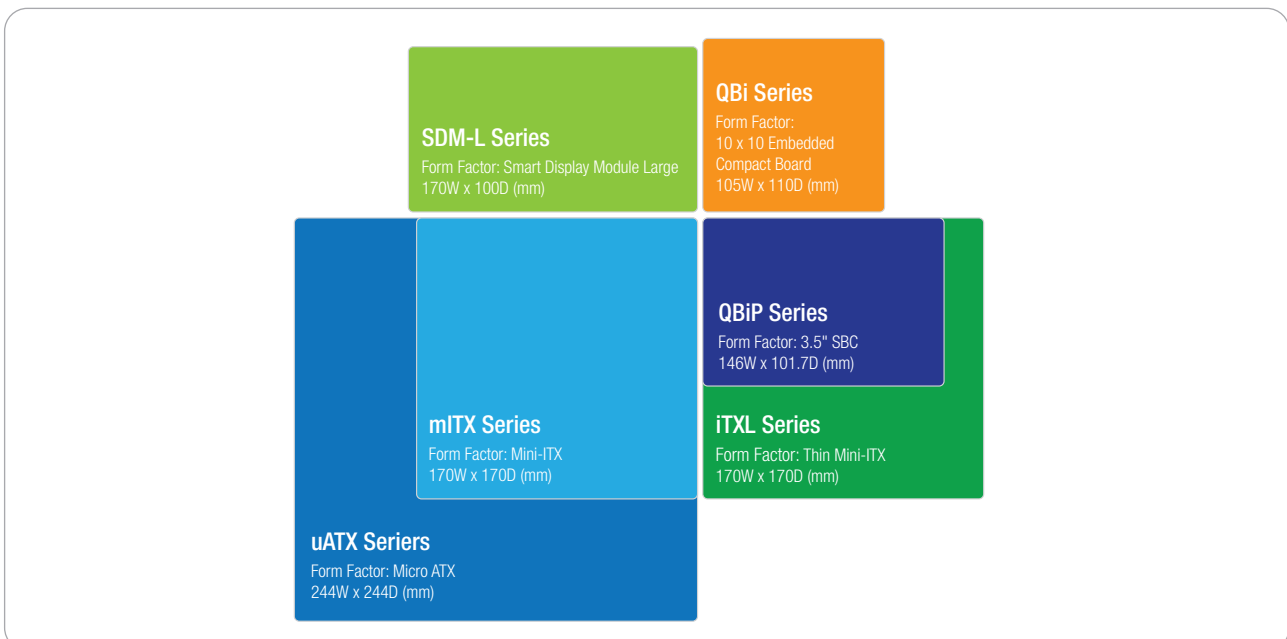

Company Profile	1	QBiX-Expert Series	15
Product’s Naming Rule	2	QBiX-Expert-TGLA1165G7H-A1	15
Index	3	QBiX-Expert-TGLA1135G7H-A1	15
Embedded Computing Systems	5	QBiX-Expert-TGLA1115G4EH-A1	15
QBiX Series	5	QBiX-ITX Series	16
QBiX-TGLA1135G7-A1.....	5	QBiX-ITX-Chassis Kit	16
QBiX-TGLA1115G4E-A1	5	QBiX-Jumbo Series	17
QBiX-WHLA8565H-A1	5	QBiX-JMB-CMLA47EH-A1.....	17
QBiX-WHLA8265H-A1.....	5	QBiX-JMB-CMLA47EH-B1.....	17
QBiX-WHLA8145H-A1.....	5	QBiX-JMB-CMLA47EHGP-A1	17
QBiX-KBLA7100H-A1	5	QBiX-JMB-CFLA310H-A1	18
QBiX-EHLA6412-A1	6	QBiX-JMB-CFLA310HG-A1.....	18
QBiX-GLKB4125-A1	6	QBiX-JMB-CFLA310HG-B1.....	18
QBiX-GLKA5005H-A1.....	7	QBiX-WP Series	19
QBiX-APLA4200H-A1	7	QBiX-WP-WHLA8265H-A1	19
QBiX-Pro Series	8	QBiX-WP-APLA3940H-A1.....	19
QBiX-Pro-TGLA1135G7H-A1.....	8	QBiX-Jetson Series	20
QBiX-Pro-TGLA1115G4EH-A1	8	QBiX-Jetson-NanoAHP-A1.....	20
QBiX-Pro-TGLA1135G7H-A2	8	QBiX-Jetson-XavierAHP-A1.....	20
QBiX-Pro-TGLA1115G4EH-A2	8	QBiX-Plus Series	21
QBiX-Pro-WHLA8565H-A1	9	QBiX-Plus-KBLA7100-A1.....	21
QBiX-Pro-WHLA8265H-A1	9	QBiX-Plus-EHLA6412-A1.....	21
QBiX-Pro-WHLA8145H-A1	9	QBiX-Lite Series	22
QBiX-Pro-WHLA8565H-A2.....	9	QBiX-Lite-TGLA1135G7-A1	22
QBiX-Pro-WHLA8265H-A2	9	QBiX-Lite-AMDA1605H-A1.....	22
QBiX-Pro-WHLA8145H-A2	9	QBiX-Lite SDM Kits	23
QBiX-Pro-KBLB7200H-A2	10	SDM-L Series	24
QBiX-Pro-KBLB7100H-A1	10	SDM-1185G7EL.....	24
QBiX-Pro-KBLB3965H-A1	10	SDM-1135G7L	24
QBiX-Pro-EHLA6412H-A1	11	SDM-1115G4L	24
QBiX-Pro-EHLA6412H-A2	11	SDM-7300L	25
QBiX-Pro-APLB4200H-A1	12	SDM-7100L	25
QBiX-Pro-APLB4200H-B1	12	SDM-4000L.....	25
QBiX-Pro-BYTA1900H-A1	13	SDM Docking Board Series	26
QBiX-Pro-AMDA1605H-A1.....	13	CIBPT	26
QBiX-Pro DIN Rail Series	13	CIBPX.....	26
QBiX-DR-EHLA6412H-A1	14		
QBiX-Pro-GLKB5040HD-A1	14		
QBiX-Pro-BYTA1900HD-A1	14		

Embedded Boards 27

Micro-ATX Series 27

- uATX-H61EA 27
- uATX-W48EA 27
- uATX-Q47EA 28
- uATX-H410A 28
- uATX-Q370A 28
- uATX-H310A 29
- uATX-H110A 29
- uATX-RYZEN 29

Mini-ITX Series 30

- mITX-Q47EA 30
- mITX-H42EA 30
- mITX-Q370A 30
- mITX-H310A 31
- mITX-Q170A 31
- mITX-H110A 31
- mITX-H110B 32
- mITX-4125A 32
- mITX-1900A 33
- mITX-2748A 33
- mITX-1605A 33

Thin Mini-ITX Series 34

- iTXL-H610A 34
- iTXL-Q47EA 34
- iTXL-H42EA 34
- iTXL-Q370A 35
- iTXL-1135G7A/ iTXL-1115G4EA 35
- iTXL-6412A/ iTXL-6210A 36
- iTXL-5105A/ iTXL-4500A 36
- iTXL-3350A 36

QBiP Series (3.5" SBC) 37

- QBiP-1185G7EB /QBiP-1145G7EB 37
- QBiP-1165G7A/ QBiP-1135G7A/ QBiP-1115G4EA .. 37
- QBiP-1165G7B/ QBiP-1135G7B/ QBiP-1115G4EB.... 37
- QBiP-8665A/ QBiP-8365A 38
- QBiP-8565A/ QBiP-8265A/ QBiP-8145A 38
- QBiP-7600A/ QBiP-7200A/ QBiP-7100A..... 39
- QBiP-3965A 39
- QBiP-6412A/ QBiP-6210A 40
- QBiP-4200B/ QBiP-4200C/ QBiP-3350A 40

- QBiP-E3940A 40

- QBiP-1900A 41

- QBiP-2718A..... 41

- QBiP-1605B..... 41

QBiP Wide Temperature Series 42

- QBiP-7200AT/ QBiP-7100AT 42

- QBiP-E3940AT 42

- QBiP-1900AT 42

QBi Series (10 x 10 Embedded Compact Board) 43

- QBi-1165G7A/ QBi-1135G7A/ QBi-1115G4EA..... 43

- QBi-8665A/ QBi-8365A 43

- QBi-8565A/ QBi-8265A/ QBi-8145A..... 44

- QBi-7100B 44

- QBi-3965B..... 45

- QBi-6412A/ QBi-6210A 45

- QBi-4125A..... 46

- QBi-4200B 46

QBiX Series



QBiX Series

Model Name	QBIX-TGLA1135G7-A1 QBIX-TGLA1115G4E-A1	QBIX-WHLA8565H-A1 QBIX-WHLA8265H-A1 QBIX-WHLA8145H-A1	QBIX-KBLA7100H-A1
Dimension	138W x 118D x 74.2H (mm)	138W x 118D x 74.2H (mm)	138W x 118D x 74.2H (mm)
CPU	Intel® Core™ i5-1135G7 Processor 10nm SuperFin, 4 cores, 8 threads, up to 4.2 GHz Intel® Core™ i3-1115G4E Processor, 10nm SuperFin, 2 cores, 4 threads, up to 3.90 GHz	Intel® Core™ i7-8565U Processor, 14nm, 4 cores, 8 threads, up to 4.6 GHz Intel® Core™ i5-8265U Processor, 14nm, 4 cores, 8 threads, up to 3.9 GHz Intel® Core™ i3-8145UE Processor, 14nm, 2 cores, 4 threads, up to 3.9 GHz	Intel® Core™ i3-7100U Processor, 14nm, 2 cores, 4 threads, 2.4 GHz
Chipset	SoC	SoC	SoC
Memory	2 x DDR4 SO-DIMM sockets, Max. Capacity 64 GB, Support Dual Channel DDR4 3200 MHz	2 x DDR4 SO-DIMM sockets, Max. Capacity 64 GB, Support Dual Channel DDR4 2400 MHz	2 x DDR4 SO-DIMM sockets, Max. Capacity 32 GB, Support Dual Channel DDR4 2133 MHz
Ethernet	2 x GbE LAN Ports (Intel® I219V and Realtek® RTL8111HS)	2 x GbE LAN Ports (Intel® I219V and Realtek® RTL8111HS)	1 x GbE LAN Port (Intel® I219V)
Graphic	Integrated Graphics Processor - Intel® Iris® Xe Graphics: 2 x HDMI 2.0 2 independent display outputs	Integrated Graphics Processor - Intel® UHD Graphics 620: 2 x HDMI 1.4 2 independent display outputs	Integrated Graphics Processor - Intel® HD Graphics 620: 1 x HDMI 2.0 1 x Mini Display Port 2 independent display outputs
Audio	Realtek® Audio Codec	Realtek® Audio Codec	Intel® Integrated Audio
Storage	—	1 x 2.5" HDD/SSD (SATA 6Gb/s)	1 x 2.5" HDD/SSD (SATA 6Gb/s)
Expansion Slots	1 x 2280 M.2 M-Key (PCIe x4, SATA 6Gb/s) 1 x 2230 M.2 E-Key	1 x 2280 M.2 M-Key (PCIe x4, SATA 6Gb/s) 1 x 2230 M.2 E-Key 1 x Vertical USB 3.2 Gen 1	1 x 2280 M.2 M-Key (PCIe x4, SATA 6Gb/s) 1 x 2230 M.2 E-Key
Front I/O	2 x USB 3.2 Gen 2x1 1 x Power button with LED 2 x External Antenna Holes (Optional) 1 x HDD LED 1 x COM Port (RS-232/422/845) 1 x Headphone Jack	2 x USB 3.2 Gen 2x1 1 x Power button with LED 2 x External Antenna Holes (Optional) 1 x HDD LED 1 x COM Port (RS-232/422/845) 1 x Headphone Jack	2 x USB 3.2 Gen 1 1 x Power switch 2 x External Antenna Holes (Optional) 1 x Power LED 1 x HDD LED
Rear I/O	2 x HDMI 2 x RJ45 LAN Ports 2 x USB 3.2 Gen 2x1 1 x Screw type DC Jack	2 x HDMI 2 x RJ45 LAN Ports 2 x USB 3.2 Gen 2x1 1 x Screw Type DC Jack	1 x RJ45 LAN Port 2 x USB 3.2 Gen 1 1 x HDMI 1 x Mini Display Port 1 x COM Port (RS-232) 1 x Screw Type DC Jack
Side I/O	—	—	—
TPM	—	—	—
Power	+9V~48VDC (Adapter 19.5V/135W)	+9V~36VDC (Adapter 19V/90W)	+12V~24VDC (Adapter 19V/65W)
Operating Temp.	0°C to 50°C	0°C to 50°C	0°C to 50°C
Mounting	Wall mount	Wall mount	Wall mount
Ordering Information	6BQB1135AMR-SI (Box packing) 6BQB1115AMR-SI (Box packing)	6BQB8565AMR-SI (Box packing) 6BQB8265AMR-SI (Box packing) 6BQB8145AMR-SI (Box packing)	6BCKAAMR-SI (Box packing)
Built-in Components	—	—	—

QBiX Series

New



Model Name	QBiX-EHLA6412-A1	QBiX-GLKB4125-A1
Dimension	118W x 109.4D x 44.4H (mm)	118W x 109.4D x 44.4H (mm)
CPU	Intel® Celeron® J6412 Processor, 10nm, 4 cores, 4 threads, up to 2.6 GHz	Intel® Celeron® J4125 Processor, 14nm, 4 cores, 4 threads, up to 2.7 GHz
Chipset	SoC	SoC
Memory	1 x DDR4 SO-DIMM socket, Max. Capacity 32 GB, Support Single Channel DDR4 3200 MHz	1 x DDR4 SO-DIMM socket, Max. Capacity 8 GB, Support Single Channel DDR4 2400 MHz
Ethernet	2 x GbE LAN Ports (Intel® I211AT)	2 x GbE LAN Ports (Intel® I211AT and Realtek® RTL8111HS)
Graphic	Integrated Graphics Processor - Intel® UHD Graphics for 10th Gen Intel® Processors : 2 x HDMI 2.0 2 independent display outputs	Integrated Graphics Processor - Intel® UHD Graphics 600: 2 x HDMI 1.4 2 independent display outputs
Audio	Realtek® Audio Codec	Realtek® Audio Codec
Storage	—	—
Expansion Slots	1 x 2280 M.2 M-Key (PCIe x2, SATA 6Gb/s) 1 x 2230 M.2 E-Key	1 x 2280 M.2 M-Key (SATA 6Gb/s) 1 x 2230 M.2 E-Key
Front I/O	2 x USB 3.2 Gen 2x1 1 x COM Port (RS-232) 1 x Headphone Jack 1 x Power button with LED	2 x USB 3.2 Gen 1 1 x COM Port (RS-232) 1 x Headphone Jack 1 x Power button with LED
Rear I/O	2 x RJ45 LAN Ports 2 x USB 3.2 Gen 2x1 2 x HDMI 2 x External Antenna Holes (Optional) 1 x Screw Type DC Jack	2 x RJ45 LAN Ports 2 x USB 3.2 Gen 1 2 x HDMI 2 x External Antenna Holes (Optional) 1 x Screw Type DC Jack
Side I/O	—	—
TPM	—	—
Power	+12V~19VDC (Adapter 19V/65W)	+12V~19VDC (Adapter 19V/65W)
Operating Temp.	0°C to 50°C	0°C to 50°C
Mounting	VESA 75/100	VESA 75/100
Ordering Information	6BQB6412AMR-SI (Box packing)	6BQB4125AMR-SI (Box packing)
Built-in Components	—	—

QBiX Series



QBiX Series/ QBiX-Pro Series

Model Name	QBiX-GLKA5005H-A1	QBiX-APLA4200H-A1
Dimension	118W x 109.4D x 54.4H (mm)	118W x 109.4D x 54.4H (mm)
CPU	Intel® Pentium® Silver J5005 Processor, 14nm, 4 cores, 4 threads, up to 2.8 GHz	Intel® Pentium® N4200 Processor, 14nm, 4 cores, 4 threads, up to 2.5 GHz
Chipset	SoC	SoC
Memory	1 x DDR4 SO-DIMM socket, Max. Capacity 8 GB, Support Single Channel DDR4 2400 MHz	1 x DDR3L SO-DIMM socket, Max. Capacity 8 GB, Support Single Channel DDR3L 1866 MHz
Ethernet	1 x GbE LAN Port (Realtek® RTL8111HS)	1 x GbE LAN Port (Realtek® RTL8111HS)
Graphic	Integrated Graphics Processor - Intel® UHD Graphics 605: 1 x HDMI 1.4 1 x VGA 2 independent display outputs	Integrated Graphics Processor - Intel® HD Graphics 505: 1 x HDMI 1.4 1 x VGA 2 independent display outputs
Audio	Realtek® Audio Codec	Realtek® Audio Codec
Storage	1 x 2.5" HDD/SSD (SATA 6Gb/s)	1 x 2.5" HDD/SSD (SATA 6Gb/s)
Expansion Slots	1 x 2230 M.2 E-Key	1 x 2230 M.2 E-Key
Front I/O	2 x USB 3.2 Gen 1 1 x COM Port (RS-232) 1 x Headphone Jack 1 x Microphone Jack 1 x Power button with LED	2 x USB 3.2 Gen 1 1 x Power button with LED 1 x Headphone Jack
Rear I/O	1 x RJ45 LAN Port 2 x USB 3.2 Gen 1 1 x HDMI 1 x VGA 2 x External Antenna Holes (Optional)	1 x RJ45 LAN Port 2 x USB 3.2 Gen 1 1 x HDMI 1 x VGA 2 x External Antenna Holes (Optional)
Side I/O	1 x DC Jack	1 x DC Jack
TPM	—	—
Power	+12V~19VDC (Adapter 19V/65W)	+12V~24VDC (Adapter 19V/65W)
Operating Temp.	0°C to 50°C	0°C to 50°C
Mounting	VESA 75/100	VESA 75/100
Ordering Information	6BCGAAMR-SI (Box packing)	6BCBAAMR-SI (Box packing)
Built-in Components	—	—

QBiX-Pro Series

New



New



Model Name	QBiX-Pro-TGLA1135G7H-A1 QBiX-Pro-TGLA1115G4EH-A1	QBiX-Pro-TGLA1135G7H-A2 QBiX-Pro-TGLA1115G4EH-A2
Dimension	178W x 125D x 52.7H (mm)	178W x 125D x 52.7H (mm)
CPU	Intel® Core™ i5-1135G7 Processor, 10nm SuperFin, 4 cores, 8 threads, up to 4.2 GHz Intel® Core™ i3-1115G4E Processor, 10nm SuperFin, 2 cores, 4 threads, up to 3.9GHz	Intel® Core™ i5-1135G7 Processor, 10nm SuperFin, 4 cores, 8 threads, up to 4.2 GHz Intel® Core™ i3-1115G4E Processor, 10nm SuperFin, 2 cores, 4 threads, up to 3.9GHz
Chipset	SoC	SoC
Memory	2 x DDR4 SO-DIMM sockets, Max. Capacity 64 GB, Support Dual Channel DDR4 3200 MHz	2 x DDR4 SO-DIMM sockets, Max. Capacity 64 GB, Support Dual Channel DDR4 3200 MHz
Ethernet	2 x GbE LAN Ports (Intel® I219V and Intel® I211AT)	2 x GbE LAN Ports (Intel® I219V and Intel® I211AT)
Graphic	Integrated Graphics Processor - Intel® UHD Graphics for 11th Gen Intel® Processors : 2 x HDMI 2.0 2 independent display outputs	Integrated Graphics Processor - Intel® UHD Graphics for 11th Gen Intel® Processors : 2 x HDMI 2.0 2 independent display outputs
Audio	Realtek® Audio Codec	Realtek® Audio Codec
Storage	1 x 2.5" HDD/SSD (SATA 6Gb/s)	1 x 2.5" HDD/SSD (SATA 6Gb/s)
Expansion Slots	1 x 2280 M.2 M-Key (PCIe x2, SATA 6Gb/s) 1 x 2230 M.2 E-Key 1 x Full-size Mini PCIe with SIM slot	1 x 2280 M.2 M-Key (PCIe x2, SATA 6Gb/s) 1 x 2230 M.2 E-Key 1 x Full-size Mini PCIe with SIM slot
Front I/O	2 x RJ45 LAN Ports 4 x USB 3.2 Gen 2x1 2 x HDMI 1 x Power button with LED 1 x HDD LED 1 x COM Port (RS-232/422/485 & RI/5V/12V)	2 x RJ45 LAN Ports 4 x USB 3.2 Gen 2x1 2 x HDMI 1 x Power button with LED 1 x HDD LED 1 x COM Port (RS-232/422/485 & RI/5V/12V)
Rear I/O	2 x USB 2.0 2 x COM Ports (RS-232/422/485) 1 x GPIO (8 bits) 1 x Headphone Jack 1 x 3-pin Terminal Block	2 x USB 2.0 2 x COM Ports (RS-232/422/485) 1 x GPIO (8 bits) 1 x Headphone Jack 1 x Screw Type DC Jack
Side I/O	2 x External Antenna Holes (Optional)	2 x External Antenna Holes (Optional)
TPM	—	—
Power	A1 : +9V~36VDC (Full Range)	A2 : +9V~36VDC (Adapter 19.5V/135W)
Operating Temp.	0°C to 50°C	0°C to 50°C
Mounting	Wall mount (Optional)	Wall mount (Optional)
Ordering Information	6BQP1135AMR-SI (Box packing) 6BQP1115AMR-SI (Box packing)	6BQP1135AMR-SI (Box packing) 6BQP1115AMR-SI (Box packing)
Built-in COM Portponents	—	—

QBiX-Pro Series



QBiX-Pro Series

Model Name	QBiX-Pro-WHLA8565H-A1 QBiX-Pro-WHLA8265H-A1 QBiX-Pro-WHLA8145H-A1	QBiX-Pro-WHLA8565H-A2 QBiX-Pro-WHLA8265H-A2 QBiX-Pro-WHLA8145H-A2
Dimension	178W x 125D x 52.7H (mm)	178W x 125D x 52.7H (mm)
CPU	Intel® Core™ i7-8565U Processor, 14nm, 4 cores, 8 threads, up to 4.6 GHz Intel® Core™ i5-8265U Processor, 14nm, 4 cores, 8 threads, up to 3.9 GHz Intel® Core™ i3-8145UE Processor, 14nm, 2 cores, 4 threads, up to 3.9 GHz	Intel® Core™ i7-8565U Processor 14nm, 4 cores, 8 threads, up to 4.6 GHz Intel® Core™ i5-8265U Processor 14nm, 4 cores, 8 threads, up to 3.9 GHz Intel® Core™ i3-8145UE Processor 14nm, 2 cores, 4 threads, up to 3.9 GHz
Chipset	SoC	SoC
Memory	2 x DDR4 SO-DIMM sockets, Max. Capacity 64 GB, Support Dual Channel DDR4 2400 MHz	2 x DDR4 SO-DIMM sockets, Max. Capacity 64 GB, Support Dual Channel DDR4 2400 MHz
Ethernet	2 x GbE LAN Ports (Intel® I219V and Intel® I211AT)	2 x GbE LAN Ports (Intel® I219V and Intel® I211AT)
Graphic	Integrated Graphics Processor - Intel® UHD Graphics 620 : 2 x HDMI 1.4 2 independent display outputs	Integrated Graphics Processor - Intel® UHD Graphics 620 : 2 x HDMI 1.4 2 independent display outputs
Audio	Realtek® Audio Codec	Realtek® Audio Codec
Storage	1 x 2.5" HDD/SSD (SATA 6Gb/s)	1 x 2.5" HDD/SSD (SATA 6Gb/s)
Expansion Slots	1 x 2280 M.2 M-Key (PCIe x4, SATA 6Gb/s) 1 x 2230 M.2 E-Key 1 x Full-size Mini PCIe with SIM slot	1 x 2280 M.2 M-Key (PCIe x4, SATA 6Gb/s) 1 x 2230 M.2 E-Key 1 x Full-size Mini PCIe with SIM slot
Front I/O	2 x RJ45 LAN Ports 4 x USB 3.2 Gen 2x1 2 x HDMI 1 x Power button with LED 1 x HDD LED 1 x COM Port (RS-232/422/485 & RI/5V/12V)	2 x RJ45 LAN Ports 4 x USB 3.2 Gen 2x1 2 x HDMI 1 x Power button with LED 1 x HDD LED 1 x COM Port (RS-232/422/485 & RI/5V/12V)
Rear I/O	2 x USB 2.0 2 x COM Ports (RS-232) 1 x GPIO (8 bits) 1 x Headphone Jack 1 x 3-pin Terminal Block	2 x USB 2.0 2 x COM Ports (RS-232) 1 x GPIO (8 bits) 1 x Headphone Jack 1 x Screw Type DC Jack
Side I/O	2 x External Antenna Holes (Optional)	2 x External Antenna Holes (Optional)
TPM	—	—
Power	+9V~36VDC (Full Range)	+9V~36VDC (Adapter 19V/90W)
Operating Temp.	0°C to 50°C	0°C to 50°C
Mounting	Wall mount (Optional)	Wall mount (Optional)
Ordering Information	6BQP8565AMR-SI (Box packing) 6BQP8265AMR-SI (Box packing) 6BQP8145AMR-SI (Box packing)	6BQP8565AMR-SI (Box packing) 6BQP8265AMR-SI (Box packing) 6BQP8145AMR-SI (Box packing)
Built-in COM Portponents	—	—

QBiX-Pro Series



Model Name	QBiX-Pro-KBLB7200H-A2	QBiX-Pro-KBLB7100H-A1	QBiX-Pro-KBLB3965H-A1
Dimension	178W x 125D x 52.7H (mm)	178W x 125D x 52.7H (mm)	178W x 125D x 52.7H (mm)
CPU	Intel® Core™ i5-7200U Processor, 14nm, 2 cores, 4 threads, up to 3.1 GHz	Intel® Core™ i3-7100U Processor, 14nm, 2 cores, 4 threads, 2.4 GHz	Intel® Celeron® 3965U Processor, 14nm, 2 cores, 2 threads, 2.2 GHz
Chipset	SoC	SoC	SoC
Memory	2 x DDR4 SO-DIMM sockets, Max. Capacity 32 GB, Support Dual Channel DDR4 2133 MHz	2 x DDR4 SO-DIMM sockets, Max. Capacity 32 GB, Support Dual Channel DDR4 2133 MHz	2 x DDR4 SO-DIMM sockets, Max. Capacity 32 GB, Support Dual Channel DDR4 2133 MHz
Ethernet	2 x GbE LAN Ports (Intel® I219V and Intel® I211AT)	2 x GbE LAN Ports (Intel® I219V and Intel® I211AT)	2 x GbE LAN Ports (Intel® I219V and Intel® I211AT)
Graphic	Integrated Graphics Processor - Intel® HD Graphics 620: 1 x HDMI 2.0 1 x Display Port 2 independent display outputs	Integrated Graphics Processor - Intel® HD Graphics 620: 1 x HDMI 2.0 1 x Display Port 2 independent display outputs	Integrated Graphics Processor - Intel® HD Graphics 610: 1 x HDMI 2.0 1 x Display Port 2 independent display outputs
Audio	Realtek® Audio Codec	Realtek® Audio Codec	Realtek® Audio Codec
Storage	1 x 2.5" HDD/SSD (SATA 6Gb/s)	1 x 2.5" HDD/SSD (SATA 6Gb/s)	1 x 2.5" HDD/SSD (SATA 6Gb/s)
Expansion Slots	1 x 2280 M.2 M-Key (PCIe x4, SATA 6Gb/s) 1 x 2230 M.2 E-Key 1 x Full-size Mini PCIe with SIM slot	1 x 2280 M.2 M-Key (PCIe x4, SATA 6Gb/s) 1 x 2230 M.2 E-Key 1 x Full-size Mini PCIe with SIM slot	1 x 2280 M.2 M-Key (SATA 6Gb/s) 1 x 2230 M.2 E-Key 1 x Full-size Mini PCIe with SIM slot
Front I/O	2 x RJ45 LAN Ports 4 x USB 3.2 Gen 1 1 x HDMI 1 x Display Port 1 x Power switch 1 x Power & HDD LED 1 x COM Port (RS-232/422/485 & RI/5V/12V)	2 x RJ45 LAN Ports 4 x USB 3.2 Gen 1 1 x HDMI 1 x Display Port 1 x Power switch 1 x Power & HDD LED 1 x COM Port (RS-232/422/485 & RI/5V/12V)	2 x RJ45 LAN Ports 4 x USB 3.2 Gen 1 1 x HDMI 1 x Display Port 1 x Power switch 1 x Power & HDD LED 1 x COM Port (RS-232/422/485 & RI/5V/12V)
Rear I/O	2 x USB 2.0 3 x COM Ports (RS-232) 1 x Screw Type DC Jack	2 x USB 2.0 3 x COM Ports (RS-232) 1 x 3-pin Terminal Block	2 x USB 2.0 3 x COM Ports (RS-232) 1 x 3-pin Terminal Block
Side I/O	2 x External Antenna Holes (Optional)	2 x External Antenna Holes (Optional)	2 x External Antenna Holes (Optional)
TPM	—	—	—
Power	+9V~36VDC (Adapter 19V/65W)	+9V~36VDC (Full Range)	+9V~36VDC (Full Range)
Operating Temp.	0°C to 50°C	0°C to 50°C	0°C to 50°C
Mounting	Wall mount (Optional)	Wall mount (Optional)	Wall mount (Optional)
Ordering Information	6BQP7200AMR-SI (Box packing)	6BCKACMR-SI (Box packing)	6BQP3965AMR-SI (Box packing)
Built-in COM portponents	—	—	—

QBiX-Pro Series

New



New



QBiX-Pro Series

Model Name	QBiX-Pro-EHLA6412H-A1	QBiX-Pro-EHLA6412H-A2
Dimension	178W x 125D x 52.7H (mm)	178W x 125D x 52.7H (mm)
CPU	Intel® Celeron® J6412 Processor, 10nm, 4 cores, 4 threads, up to 2.6 GHz	Intel® Celeron® J6412 Processor, 10nm, 4 cores, 4 threads, up to 2.6 GHz
Chipset	SoC	SoC
Memory	2 x DDR4 SO-DIMM sockets, Max. Capacity 32 GB, Support Dual Channel DDR4 3200 MHz	2 x DDR4 SO-DIMM sockets, Max. Capacity 32 GB, Support Dual Channel DDR4 3200 MHz
Ethernet	2 x GbE LAN Ports (Intel® I211AT)	2 x GbE LAN Ports (Intel® I211AT)
Graphic	Integrated Graphics Processor - Intel® UHD Graphics for 10th Gen Intel® Processors : 2 x HDMI 2.0 2 independent display outputs	Integrated Graphics Processor - Intel® UHD Graphics for 10th Gen Intel® Processors : 2 x HDMI 2.0 2 independent display outputs
Audio	Realtek® Audio Codec	Realtek® Audio Codec
Storage	1 x 2.5" HDD/SSD (SATA 6Gb/s)	1 x 2.5" HDD/SSD (SATA 6Gb/s)
Expansion Slots	1 x 2280 M.2 M-Key (PCIex2, SATA 6Gb/s) 1 x Full-size Mini PCIe with SIM slot	1 x 2280 M.2 M-Key (PCIex2, SATA 6Gb/s) 1 x Full-size Mini PCIe with SIM slot
Front I/O	2 x RJ45 LAN Ports 4 x USB 3.2 Gen 1 2 x HDMI 1 x Power button with LED 1 x HDD LED 1 x Headphone Jack	2 x RJ45 LAN Ports 4 x USB 3.2 Gen 1 2 x HDMI 1 x Power button with LED 1 x HDD LED 1 x Headphone Jack
Rear I/O	2 x USB 2.0 1 x COM Port (RS-232/422/485 & RI/5V/12V) 1 x COM Port (RS-232/422/485) 1 x COM Port (RS-232) 1 x GPIO (8 bits) 1 x 3-pin Terminal Block	2 x USB 2.0 1 x COM Port (RS-232/422/485 & RI/5V/12V) 1 x COM Port (RS-232/422/485) 1 x COM Port (RS-232) 1 x GPIO (8 bits) 1 x Screw Type DC Jack
Side I/O	2 x External Antenna Holes (Optional)	2 x External Antenna Holes (Optional)
TPM	—	—
Power	+9V~36VDC (Full Range)	+9V~36VDC (Adapter 19V/65W)
Operating Temp.	0°C to 50°C	0°C to 50°C
Mounting	Wall mount (Optional)	Wall mount (Optional)
Ordering Information	6BQP6412AMR-SI (Box packing)	6BQP6412AMR-SI (Box packing)
Built-in COM Portponents	—	—

QBiX-Pro Series



Model Name	QBiX-Pro-APLB4200H-A1	QBiX-Pro-APLB4200H-B1
Dimension	178W x 125D x 52.7H (mm)	178W x 125D x 52.7H (mm)
CPU	Intel® Pentium® N4200 Processor, 14nm, 4 cores, 4 threads, up to 2.5 GHz	Intel® Pentium® N4200 Processor, 14nm, 4 cores, 4 threads, up to 2.5 GHz
Chipset	SoC	SoC
Memory	2 x DDR3L SO-DIMM sockets, Max. Capacity 8 GB, Support Dual Channel DDR3L 1866 MHz	2 x DDR3L SO-DIMM sockets, Max. Capacity 8 GB, Support Dual Channel DDR3L 1866 MHz
Ethernet	2 x GbE LAN Ports (Intel® I211AT)	2 x GbE LAN Ports (Intel® I211AT)
Graphic	Integrated Graphics Processor - Intel® HD Graphics 505: 1 x HDMI 1.4 1 x VGA 2 independent display outputs	Integrated Graphics Processor - Intel® HD Graphics 505: 1 x HDMI 1.4 1 x VGA 2 independent display outputs
Audio	Realtek® Audio Codec	Realtek® Audio Codec
Storage	1 x 2.5" HDD/SSD (SATA 6Gb/s)	1 x 2.5" HDD/SSD (SATA 6Gb/s)
Expansion Slots	1 x 2242 M.2 M-Key (SATA 6Gb/s) 1 x Full-size Mini PCIe with SIM slot	1 x 2242 M.2 M-Key (SATA 6Gb/s) 1 x Full-size Mini PCIe with SIM slot
Front I/O	2 x RJ45 LAN Ports 2 x USB 3.2 Gen 1 1 x HDMI 1 x VGA 1 x Power switch 1 x Power & HDD LED 1 x Headphone Jack	2 x RJ45 LAN Ports 2 x USB 3.2 Gen 1 1 x HDMI 1 x VGA 1 x Power switch 1 x Power & HDD LED 1 x Headphone Jack
Rear I/O	2 x USB 2.0 1 x COM Port (RS-232/422/485 & RI/5V/12V) 3 x COM Ports (RS-232) 1 x 3-pin Terminal Block	2 x USB 2.0 1 x COM Port (RS-232/422/485 & RI/5V/12V) 2 x COM Ports (RS-232) 1 x GPIO (8 bits) 1 x 3-pin Terminal Block
Side I/O	2 x External Antenna Holes (Optional)	2 x External Antenna Holes (Optional)
TPM	—	—
Power	+9V~36VDC (Full Range)	+9V~36VDC (Full Range)
Operating Temp.	0°C to 50°C	0°C to 50°C
Mounting	Wall mount (Optional)	Wall mount (Optional)
Ordering Information	6BCBABMR-SI (Box packing)	6BQP4200BMR-SI (Box packing)
Built-in COM Portponents	—	—

QBiX-Pro Series



QBiX-Pro Series/ QBiX-Pro DIN Rail Series

Model Name	QBiX-Pro-BYTA1900H-A1	QBiX-Pro-AMDA1605H-A1
Dimension	178W x 125D x 52.7H (mm)	178W x 125D x 52.7H (mm)
CPU	Intel® Celeron® J1900 Processor, 22nm, 4 cores, 4 threads, up to 2.42 GHz	AMD® RYZEN™ V1605B Embedded Processor, 14nm, 4 cores, 8 threads, 2.0 GHz, up to 3.6 GHz
Chipset	SoC	SoC
Memory	1 x DDR3L SO-DIMM socket, Max. Capacity 8 GB, Support Single Channel DDR3L 1333 MHz	2 x DDR4 SO-DIMM sockets, Max. Capacity 32 GB, Support Dual Channel DDR4 2400 MHz
Ethernet	2 x GbE LAN Ports (Intel® I211AT)	2 x GbE LAN Ports (Realtek® RTL8111HS)
Graphic	Integrated Graphics Processor - Intel® HD Graphics: 1 x HDMI 1.4 1 x VGA 2 independent display outputs	Integrated Graphics Processor- AMD® Radeon™ Vega 8 Graphics: 4 x HDMI 2.0 4 independent display outputs
Audio	Realtek® Audio Codec	Realtek® Audio Codec
Storage	1 x 2.5" HDD/SSD (SATA 3Gb/s)	1 x 2.5" HDD/SSD (SATA 6Gb/s)
Expansion Slots	1 x 2280 M.2 M-Key (SATA 3Gb/s) 1 x Full-size Mini PCIe with SIM slot	1 x 2280 M.2 M-Key (PCIe x4, SATA 6Gb/s) 1 x 2230 M.2 E-Key 1 x Full-size Mini PCIe with SIM slot
Front I/O	2 x RJ45 LAN Ports 1 x USB 3.2 Gen 1 1 x USB 2.0 1 x HDMI 1 x VGA 1 x Power switch 1 x Power & HDD LED 1 x Headphone Jack	2 x RJ45 LAN Ports 2 x USB 3.2 Gen 1 4 x HDMI 1 x Power switch 1 x Power & HDD LED
Rear I/O	2 x USB 2.0 1 x COM Port (RS-232/422/485 & RI/5V/12V) 1 x COM Port (RS-232/422/485) 2 x COM Ports (RS-232) 1 x 3-pin Terminal Block	2 x USB 2.0 2 x COM Ports (RS-232/422/485 & RI/5V/12V) 2 x COM Ports (RS-232) 1 x Screw Type DC Jack
Side I/O	2 x External Antenna Holes (Optional)	2 x External Antenna Holes (Optional)
TPM	—	Onboard TPM 2.0 security chip INFINEON SLB9665TT2.0
Power	+9V~36VDC (Full Range)	+9V~36VDC (Adapter 19V/65W)
Operating Temp.	0°C to 50°C	0°C to 50°C
Mounting	Wall mount (Optional)	Wall mount (Optional)
Ordering Information	6BQP1900AMR-SI (Box packing)	6BQP1605AMR-SI (Box packing)
Built-in Components	—	—

QBiX-Pro DIN Rail Series

New



Model Name	QBiX-DR-EHLA6412H-A1	QBiX-Pro-GLKB5040HD-A1	QBiX-Pro-BYTA1900HD-A1
Dimension	160W x 118D x 62.6H (mm)	160W x 118D x 62.6H (mm)	160W x 118D x 62.6H (mm)
CPU	Intel® Celeron® J6412 Processor, 10nm, 4 cores, 4 threads, up to 2.6 GHz	Intel® Pentium® Silver J5040 Processor, 14nm, 4 cores, 4 threads, up to 3.2 GHz	Intel® Celeron® J1900 Processor, 22nm, 4 cores, 4 threads, up to 2.42 GHz
Chipset	SoC	SoC	SoC
Memory	1 x DDR4 SO-DIMM socket, Max. Capacity 16 GB, Support Single Channel DDR4 2600 MHz	1 x DDR4 SO-DIMM socket, Max. Capacity 8 GB, Support Single Channel DDR4 2400 MHz	1 x DDR3L SO-DIMM socket, Max. Capacity 8 GB, Support Single Channel DDR3L 1333 MHz
Ethernet	2 x LAN ports (Intel® I210AT)	2 x GbE LAN Ports (Intel® I211AT)	2 x GbE LAN Ports (Intel® I211AT)
Graphic	Integrated Graphics Processor 1 x HDMI 1.4, 1 x VGA 2 independent display outputs	Integrated Graphics Processor - Intel® UHD Graphics 605: 1 x HDMI 2.0 1 x VGA 2 independent display outputs	Integrated Graphics Processor - Intel® HD Graphics: 1 x HDMI 1.4 1 x VGA 2 independent display outputs
Audio	Realtek® Audio codec with 2W amplifier	Realtek® Audio Codec	Realtek® Audio Codec
Storage	1 x 2.5" HDD/SSD (SATA 6Gb/s)	1 x 2.5" HDD/SSD (SATA 6Gb/s)	1 x 2.5" HDD/SSD (SATA 3Gb/s)
Expansion Slots	1 x 2280 M.2 M-Key (SATA 6Gb/s) 1 x 2230 M.2 E-Key 1 x 3042/3052 M.2 B key with SIM Slot -5G Support	1 x 2280 M.2 M-Key (SATA 6Gb/s) 1 x 2230 M.2 E-Key 1 x Full-size Mini PCIe with SIM slot 1 x Vertical USB 2.0	1 x 2280 M.2 M-Key (SATA 3Gb/s) 1 x Full-size Mini PCIe with SIM slot
Front I/O	2 x RJ45 LAN Ports 4 x USB 3.2 Gen1 1 x HDMI 1 x VGA 2 x COM Ports (RS-232/422/485 & RI/5V/12V) 1 x Power switch 1 x HDD & Wi-Fi LED 1 x Remote control pin 1 x Headphone Jack 1 x External Antenna Hole (Optional)	2 x RJ45 LAN Ports 4 x USB 3.2 Gen 1 1 x HDMI 1 x VGA 2 x COM Ports (RS-232/422/485 & RI/5V/12V) 1 x Power button with LED 1 x WiFi/HDD LED 1 x Remote control connector 1 x Headphone Jack 1 x External Antenna Hole (Optional)	2 x RJ45 LAN Ports 1 x USB 3.2 Gen 1 3 x USB 2.0 1 x HDMI 1 x VGA 1 x COM Port (RS-232/422/485 & RI/5V/12V) 1 x COM Port (RS-232/422/485) 1 x Power button with LED 1 x HDD LED 1 x Headphone Jack
Rear I/O	1 x Din Rail Mounting Support	1 x Din Rail Mounting Support	1 x Din Rail Mounting Support
Side I/O	1 x GPIO (8 bits) 1 x 3-pin Terminal Block 2 x COM Ports (RS-232/422/485) 2 x External Antenna Holes (Optional)	1 x GPIO (8 bits) 1 x 3-pin Terminal Block 2 x COM Ports (RS-232/422/485) 2 x External Antenna Holes (Optional)	1 x GPIO (8 bits) 1 x 3-pin Terminal Block 3 x External Antenna Holes (Optional)
TPM	1 x TPM header	—	1 x TPM header
Power	+9~36VDC (Full Range)	+9V~36VDC (Full Range)	+9V~36VDC (Full Range)
Operating Temp.	0°C to 50°C	0°C to 50°C	0°C to 50°C
Mounting	DIN Rail	DIN Rail	DIN Rail
Ordering Information	6BDR6412AMR-SI (Box packing)	6BQP5040BMR-SI (Box packing)	6BQP1900BMR-SI (Box packing)
Built-in Components	—	—	—

QBiX-Expert Series



QBiX-Expert Series / QBiX-ITX Series

Market Name	QBiX-Expert-TGLA1165G7H-A1	QBiX-Expert-TGLA1135G7H-A1	QBiX-Expert-TGLA1115G4EH-A1
Dimension	210.36W x 165D x 67H (mm)	210.36W x 165D x 67H (mm)	210.36W x 165D x 67H (mm)
CPU	Intel® Core™ i7-1165G7 Processor, 10nm SuperFin, 4 cores, 8 threads, up to 4.7 GHz	Intel® Core™ i5-1135G7 Processor, 10nm SuperFin, 4 cores, 8 threads, up to 4.2 GHz	Intel® Core™ i3-1115G4E Processor, 10nm SuperFin, 2 cores, 4 threads, up to 3.90 GHz
Chipset	SoC	SoC	SoC
Memory	2 x DDR4 SO-DIMM sockets, Max. Capacity 64 GB, Support Dual Channel DDR4 3200 MHz	2 x DDR4 SO-DIMM sockets, Max. Capacity 64 GB, Support Dual Channel DDR4 3200 MHz	2 x DDR4 SO-DIMM sockets, Max. Capacity 64 GB, Support Dual Channel DDR4 3200 MHz
Ethernet	2 x GbE LAN Ports (Intel® I219V and Intel® I211AT) 4 x PoE GbE LAN Ports (Intel® I211AT)	2 x GbE LAN Ports (Intel® I219V and Intel® I211AT) 4 x PoE GbE LAN Ports (Intel® I211AT)	2 x GbE LAN Ports (Intel® I219V and Intel® I211AT) 4 x PoE GbE LAN Ports (Intel® I211AT)
Graphic	Integrated Graphics Processor - Intel® Iris X ^e Graphics : 2 x HDMI 2.0 2 independent display outputs	Integrated Graphics Processor - Intel® Iris X ^e Graphics : 2 x HDMI 2.0 2 independent display outputs	Integrated Graphics Processor - Intel® Iris X ^e Graphics: 2 x HDMI 2.0 2 independent display outputs
Audio	Realtek® Audio Codec	Realtek® Audio Codec	Realtek® Audio Codec
Storage	1 x Swappable 2.5" HDD/SSD (SATA 6Gb/s)	1 x Swappable 2.5" HDD/SSD (SATA 6Gb/s)	1 x Swappable 2.5" HDD/SSD (SATA 6Gb/s)
Expansion Slots	1 x 2280 M.2 M-Key (PCIe x2, SATA 6Gb/s) 1 x 2230 M.2 E-Key 1 x Full-size Mini PCIe with SIM slot	1 x 2280 M.2 M-Key (PCIe x2, SATA 6Gb/s) 1 x 2230 M.2 E-Key 1 x Full-size Mini PCIe with SIM slot	1 x 2280 M.2 M-Key (PCIe x2, SATA 6Gb/s) 1 x 2230 M.2 E-Key (WiFi/BT) 1 x Full-size Mini PCIe with SIM slot
Front I/O	4 x RJ45 LAN Ports with PoE 2 x USB 2.0 1 x Power button with LED 1 x HDD LED 2 x COM Ports (RS-232/422/485) 2 x External Antenna Holes (Optional)	4 x RJ45 LAN Ports with PoE 2 x USB 2.0 1 x Power button with LED 1 x HDD LED 2 x COM Ports (RS-232/422/485) 2 x External Antenna Holes (Optional)	4 x RJ45 LAN Ports with PoE 2 x USB 2.0 1 x Power button with LED 1 x HDD LED 2 x COM Ports (RS-232/422/485) 2 x External Antenna Holes (Optional)
Rear I/O	2 x RJ45 LAN Ports 4 x USB 3.2 Gen 2x1 1 x COM Port (RS-232/422/485 & RI/5V/12V) 1 x COM Port (RS-232/422/485) 1 x GPIO (8 bits) 1 x Headphone Jack 1 x 4-pin Terminal Block	2 x RJ45 LAN Ports 4 x USB 3.2 Gen 2x1 1 x COM Port (RS-232/422/485 & RI/5V/12V) 1 x COM Port (RS-232/422/485) 1 x GPIO (8 bits) 1 x Headphone Jack 1 x 4-pin Terminal Block	2 x RJ45 LAN Ports 4 x USB 3.2 Gen 2x1 1 x COM Port (RS-232/422/485 & RI/5V/12V) 1 x COM Port (RS-232/422/485) 1 x GPIO (8 bits) 1 x Headphone Jack 1 x 4-pin Terminal Block
Side I/O	4 x External Antenna Holes (Optional)	4 x External Antenna Holes (Optional)	4 x External Antenna Holes (Optional)
TPM	—	—	—
Power	+9V~48VDC (non PoE) +12~24VDC (PoE support)	+9V~48VDC (non PoE) +12~24VDC (PoE support)	+9V~48VDC (non PoE) +12~24VDC (PoE support)
Operating Temp.	0°C to 50°C	0°C to 50°C	0°C to 50°C
Mounting	Wall mount (Optional)	Wall mount (Optional)	Wall mount (Optional)
Ordering Information	6BQE1165AMR-SI (Box packing)	6BQE1135AMR-SI (Box packing)	6BQE1115AMR-SI (Box packing)
Built-in COM portponents	—	—	—

QBiX-ITX Series



Market Name	QBiX-ITX-Chassis Kit
Dimension	210W x 200D x 58H (mm)
Support Model	mITX-Q47EA mITX-H42EA mITX-Q370A mITX-H310A mITX-Q170A mITX-H110B mITX-1605A
Chipset	Refer to MB
Storage Drive Bay	1 x 2.5" Drive Bay
Expansion Slots	Refer to Motherboard
Front I/O	4 x USB 2.0 1 x Power button with LED 1 x Power/HDD LED
Rear I/O	2 x External Antenna Holes Others are refer to Motherboard
Side I/O	—
TPM	Refer to Motherboard
Power	Refer to Motherboard
Operating Temp.	0°C to 50°C
Mounting	Wall Mount, VESA 75/100
Ordering Information	6BQIH310AMR-SI (Box packing)-MITX-H310A
Built-in COM portponents	—

QBiX-Jumbo Series

New



Preliminary



New



QBiX-Jumbo Series

Model Name	QBiX-JMB-CMLA47EH-A1	QBiX-JMB-CMLA47EH-B1	QBiX-JMB-CMLA47EHGP-A1
Dimension	224W x 256.1D x 77.7H (mm)	224W x 368D x 166.3H (mm)	224W x 368D x 166.3H (mm)
CPU	Support for 10th Generation Intel® Core™ i9/i7/ i5/ i3, Pentium® and Celeron® processors in the LGA1200 package	Support for 10th Generation Intel® Core™ i9/i7/ i5/ i3, Pentium® and Celeron® processors in the LGA1200 package	Support for 10th Generation Intel® Core™ i9/i7/ i5/ i3 processors in the LGA1200 package
Chipset	Intel® Q470E Chipset	Intel® Q470E Chipset	Intel® Q470E Chipset
Memory	2 x DDR4 SO-DIMM sockets, Max. Capacity 64 GB, Support Dual Channel DDR4 3200 MHz	2 x DDR4 SO-DIMM sockets, Max. Capacity 64 GB, Support Dual Channel DDR4 3200 MHz	2 x DDR4 SO-DIMM sockets, Max. Capacity 64 GB, Support Dual Channel DDR4 3200 MHz
Ethernet	4 x GbE LAN Ports (1 x Intel® I219V and 3 x Intel® I211AT)	4 x GbE LAN Ports (1 x Intel® I219V and 3 x Intel® I211AT)	4 x GbE LAN Ports (1 x Intel® I219V and 3 x Intel® I211AT)
Graphic	Integrated Graphics Processor - Intel® HD Graphics: 1 x Display Port 1 x DVI-D 1 x VGA 3 independent display outputs	Integrated Graphics Processor - Intel® HD Graphics: 1 x Display Port 1 x DVI-D 1 x VGA 3 independent display outputs	Integrated Graphics Processor - Intel® HD Graphics: 1 x Display Port 1 x DVI-D 1 x VGA 2 independent display outputs
Audio	Realtek® Audio Codec	Realtek® Audio Codec	Realtek® Audio Codec
Storage	4 x 2.5" HDD/SSD (SATA 6Gb/s)	4 x 2.5" HDD/SSD (SATA 6Gb/s)	4 x 2.5" HDD/SSD (SATA 6Gb/s)
Expansion Slots	1 x 2280 M.2 M-Key (PCIe x 4, SATA 6Gb/s) 1 x 2230 M.2 E-Key 1 x Full-size Mini PCIe with SIM slot	1 x 2280 M.2 M-Key (SATA 6Gb/s) 1 x 2230 M.2 E-Key 1 x Full-size Mini PCIe with SIM slot 1 x PCIe x4 (Gen3 x4) 1 x PCIe x16 (Gen3 0/x8) 1 x PCIe x16 (Gen3 x16/x8) - Auto switch	1 x 2280 M.2 M-Key (SATA 6Gb/s) 1 x 2230 M.2 E-Key 1 x Full-size Mini PCIe with SIM slot 1 x PCIe x4 (Gen3 x4) 1 x PCIe x16 (Gen3 0/x8) 1 x PCIe x16 (Gen3 x16/x8) - Auto switch
Front I/O	1 x Power Switch /Power/ HDD LED 3 x Audio Jacks (Line in, Line out, Mic in) 1 x Display Port 1 x DVI-D 1 x VGA 2 x COM Ports (RS-232/422/485 & RI/5V/12V) 2 x COM Ports (RS-232) 4 x RJ45 LAN Ports 4 x USB 3.2 Gen 1 6 x USB 2.0 1 x 4-pin Terminal Block 2 x External Antenna Holes (Optional)	1 x Power Switch /Power/ HDD LED 3 x Audio Jacks (Line in, Line out, Mic in) 1 x Display Port 1 x DVI-D 1 x VGA 2 x COM Ports (RS-232/422/485 & RI/5V/12V) 2 x COM Ports (RS-232) 4 x RJ45 LAN Ports 4 x USB 3.2 Gen 1 6 x USB 2.0 1 x 4-pin Terminal Block 2 x External Antenna Holes (Optional)	1 x Power Switch /Power/ HDD LED 3 x Audio Jacks (Line in, Line out, Mic in) 1 x Display Port 1 x DVI-D 1 x VGA 2 x COM Ports (RS-232/422/485 & RI/5V/12V) 2 x COM Ports (RS-232) 4 x RJ45 LAN Ports 4 x USB 3.2 Gen 1 6 x USB 2.0 1 x 4-pin Terminal Block 2 x External Antenna Holes (Optional)
Rear I/O	—	—	—
Power	+12V~48VDC (Full Range)	+12V~48VDC (Full Range)	+24V~48VDC (Full Range) 850W Power Supply Built-in
Operating Temp.	-20°C to 50°C (CPU TDP 65W) -20°C to 60°C (CPU TDP 35W)	-20°C to 50°C (CPU TDP 65W) -20°C to 60°C (CPU TDP 35W)	-20°C to 50°C (CPU TDP 65W) -20°C to 60°C (CPU TDP 35W)
Ordering Information	6BQJQ47EAMR-SI (Box Packing)	—	—
Build in Components	Please contact with your sales representative for more information or e-mailed to : sales@gigaipc.com		
Note			※Support Discrete GFX Max. 350W

QBiX-Jumbo Series



Model Name	QBiX-JMB-CFLA310H-A1	QBiX-JMB-CFLA310HG-A1	QBiX-JMB-CFLA310HG-B1
Dimension	224W x 257D x 77H (mm)	224W x 343D x 146H (mm)	224W x 368D x 166.3H (mm)
CPU	Support for 9th/8th Generation Intel® Core™ i7/ i5/ i3 processors in the LGA1151 package	Support for 9th/8th Generation Intel® Core™ i7/ i5/ i3 processors in the LGA1151 package	Support for 9th/8th Generation Intel® Core™ i7/ i5/ i3 processors in the LGA1151 package
Chipset	Intel® H310 Chipset	Intel® H310 Chipset	Intel® H310 Chipset
Memory	2 x DDR4 SO-DIMM sockets, Max. Capacity 32 GB, Support Dual Channel DDR4 2666/2400 MHz	2 x DDR4 SO-DIMM sockets, Max. Capacity 32 GB, Support Dual Channel DDR4 2666/2400 MHz	2 x DDR4 SO-DIMM sockets, Max. Capacity 32 GB, Support Dual Channel DDR4 2666/2400 MHz
Ethernet	4 x GbE LAN Ports (1 x Intel® I219V and 3 x Intel® I211AT)	4 x GbE LAN Ports (1 x Intel® I219V and 3 x Intel® I211AT)	4 x GbE LAN Ports (1 x Intel® I219V and 3 x Intel® I211AT)
Graphic	Integrated Graphics Processor - Intel® HD Graphics: 1 x Display Port 1 x DVI-D 1 x VGA 2 independent display outputs	Integrated Graphics Processor - Intel® HD Graphics: 1 x Display Port 1 x DVI-D 1 x VGA 2 independent display outputs	Integrated Graphics Processor - Intel® HD Graphics: 1 x Display Port 1 x DVI-D 1 x VGA 2 independent display outputs
Audio	Realtek® Audio Codec	Realtek® Audio Codec	Realtek® Audio Codec
Storage	3 x 2.5" HDD/SSD (SATA 6Gb/s) 1 x 2280 M.2 M-Key (SATA 6Gb/s) 1 x 2230 M.2 E-Key	3 x 2.5" HDD/SSD (SATA 6Gb/s) 1 x 2280 M.2 M-Key (SATA 6Gb/s) 1 x 2230 M.2 E-Key	3 x 2.5" HDD/SSD (SATA 6Gb/s) 1 x 2280 M.2 M-Key (SATA 6Gb/s) 1 x 2230 M.2 E-Key
Expansion Slots	1 x Full-size Mini PCIe with SIM slot	1 x Full-size Mini PCIe with SIM slot 1 x PCIe x4 (Gen3 x1) 1 x PCIe x16 (Gen3 x16)	1 x Full-size Mini PCIe with SIM slot 1 x PCIe x4 (Gen3 x1) 1 x PCIe x16 (Gen3 x16)
Front I/O	1 x Power Switch/ Power/ HDD LED 3 x Audio Jacks (Line in, Line out, Mic in) 1 x Display Port 1 x DVI-D 1 x VGA 2 x COM Ports (RS-232/422/485 & RI/5V/12V) 2 x COM Ports (RS-232) 4 x RJ45 LAN Ports 4 x USB 3.2 Gen 1 4 x USB 2.0 1 x 4-pin Terminal Block 2 x External Antenna Holes (Optional)	1 x Power Switch/ Power/ HDD LED 3 x Audio Jacks (Line in, Line out, Mic in) 1 x Display Port 1 x DVI-D 1 x VGA 2 x COM Ports (RS-232/422/485 & RI/5V/12V) 2 x COM Ports (RS-232) 4 x RJ45 LAN Ports 4 x USB 3.2 Gen 1 4 x USB 2.0 1 x 4-pin Terminal Block 2 x External Antenna Holes (Optional)	1 x Power Switch/ Power/ HDD LED 3 x Audio Jacks (Line in, Line out, Mic in) 1 x Display Port 1 x DVI-D 1 x VGA 2 x COM Ports (RS-232/422/485 & RI/5V/12V) 2 x COM Ports (RS-232) 4 x RJ45 LAN Ports 4 x USB 3.2 Gen 1 4 x USB 2.0 1 x 4-pin Terminal Block 2 x External Antenna Holes (Optional)
Rear I/O	—	—	—
Power	+12V~48VDC (Full Range)	+24V~36VDC (Full Range)	+24V~48VDC (Full Range)
Operating Temp.	-20°C to 50°C (CPU TDP 65W) -20°C to 60°C (CPU TDP 35W) -20°C to 50°C (CPU TDP 35W, i3-8100T, Tj 82°C)	-20°C to 50°C (CPU TDP 65W) -20°C to 60°C (CPU TDP 35W) -20°C to 50°C (CPU TDP 35W, i3-8100T, Tj 82°C)	-20°C to 50°C (CPU TDP 65W) -20°C to 60°C (CPU TDP 35W) -20°C to 50°C (CPU TDP 35W, i3-8100T, Tj 82°C)
Ordering Information	9BQJH310AMR-SI (Box Packing)	9BQJH310AMR-SI + 6BQJH310APR-SI	9BQJH310AMR-SI + 6BQJH310BPR-SI
Build in Components	Please contact with your sales representative for more information or e-mailed to : sales@gigaipc.com		
Note		※Support Discrete GFX Max. 250W	※Support Discrete GFX Max. 250W

QBiX-WP Series



QBiX-WP series/ QBiX-Jetson series

Model Name	QBiX-WP-WHLA8265H-A1	QBiX-WP-APLA3940H-A1
Dimension	188W x 155D x 72H (mm)	188W x 155D x 72H (mm)
CPU	Intel® Core™ i5-8265U Processor, 14nm, 4 cores, 8 threads, up to 3.9 GHz	Intel® Atom® x5-E3940 Processor, 14nm, 4 cores, 4 threads, up to 1.8 GHz
Chipset	—	—
Memory	2 x DDR4 SO-DIMM sockets, Max. Capacity 64 GB, Support Dual Channel DDR4 2400 MHz	2 x DDR3L SO-DIMM sockets, Max. Capacity 8 GB, Support Dual Channel DDR3L 1866 MHz
Ethernet	2 x GbE LAN Ports (Intel® I219V and Intel® I211AT)	2 x GbE LAN Ports (Intel® I211AT)
Graphic	Integrated Graphics Processor - Intel® UHD Graphics 620: 1 x HDMI 1.4	Integrated Graphics Processor - Intel® HD Graphics 500: 1 x HDMI 1.4
Audio	Realtek® Audio Codec	Realtek® Audio Codec
Storage	1 x 2.5" HDD/SSD (SATA 6Gb/s)	1 x 2.5" HDD/SSD (SATA 6Gb/s)
Expansion Slots	1 x 2280 M.2 M-Key (PCIe x4, SATA 6Gb/s) 1 x 2230 M.2 E-Key 1 x Full-size Mini PCIe with SIM slot	1 x 2242 M.2 M-Key (SATA 6Gb/s) 1 x Full-size Mini PCIe with SIM slot
Front I/O	2 x (M12) RJ45 LAN Ports 2 x (IP67) USB 2.0 connector 1 x (IP67) HDMI connector 1 x (IP67) Power switch 1 x (M8) Power & HDD LED	2 x (M12) RJ45 LAN Ports 2 x (IP67) USB 2.0 connector 1 x (IP67) HDMI connector 1 x (IP67) Power switch 1 x (M8) Power & HDD LED
Rear I/O	1 x (M12) COM Port (RS-232/422/485 & RI/5V/12V) 2 x (M12) COM Ports (RS-232) 1 x (M12) GPIO (8 bits) 1 x (M12) DC IN	1 x (M12) COM Port (RS-232/422/485 & RI/5V/12V) 2 x (M12) COM Ports (RS-232) 1 x (M12) GPIO (8 bits) 1 x (M12) DC Jack
Power	+9V~36VDC	+9V~36VDC
Operating Temp.	-20°C to 70°C	-20°C to 80°C
Ordering Information	9BQW8265AMR-SI (Box packing)	9BQW3940AMR-SI (Box packing)
Build in Components	Please contact with your sales representative for more information or e-mailed to : sales@gigaipc.com	

QBiX-Jetson Series



Model Name	QBiX-Jetson-NanoAHP-A1	QBiX-Jetson-XavierAHP-A1
Dimension	210W x 169.8D x 55.2H (mm)	210W x 169.8D x 55.2H (mm)
CPU	ARM® Cortex® A57 MPCore (Quad-Core) Processor with NEON Technology	6-core NVIDIA® Carmel Arm® v8.2 64-bit CPU 6MB L2 cache + 4MB L3 cache
Chipset	—	—
Memory	4GB LPDDR4 (module)	8GB LPDDR4 (module)
Ethernet	8 x GbE LAN with PoE 15W/Port (PoE Optional) 2 x GbE LAN	8 x GbE LAN with PoE 15W/Port (PoE Optional) 2 x GbE LAN
Graphic	NVIDIA® Maxwell™ architecture with 128 NVIDIA® CUDA® cores 1 x HDMI 1 x Display Port	384-core NVIDIA® Volta™ GPU with 48 Tensor Cores 1 x HDMI 1 x Display Port
Audio	—	—
Storage	1 x 16G eMMC 5.1 (Module) 1 x SATA 6Gb/s (Swappable 2.5" HDD/SSD)	1 x 16G eMMC 5.1 (Module) 1 x SATA 6Gb/s (Swappable 2.5" HDD/SSD)
Expansion Slots	1 x 3052 M.2 B-Key (USB 3.2 Gen 1x1) 1 x Mini PCIe (USB 2.0 only) 1 x 2230 M.2 E-Key - Intel AC 8265 (Optional) 1 x SIM slot	1 x 3052 M.2 B-Key (PCIe x1+ USB3.2 Gen1x1) 1 x Mini PCIe (USB2.0 only) 1 x 2230 M.2 E-Key - Intel AC 8265 (Optional) 1 x SIM slot
Front I/O	1 x Micro SD card 1 x Micro USB 2.0 (OTD) 1 x HDMI 2.0 1 x Display Port 1 x Power button with LED 1 x HDD LED 1 x GPIO (8 bits) 1 x Recovery button 2 x External Antenna Holes (Optional)	1 x Micro SD card 1 x Micro USB 2.0 (OTD) 1 x HDMI 2.0 1 x Display Port 1 x Power button with LED 1 x HDD LED 1 x GPIO (8 bits) 1 x Recovery button 2 x External Antenna Holes (Optional)
Rear I/O	4 x COM Ports (RS-232/422/485) 1 x 3-pin Terminal block 8 x GbE LAN Ports with PoE 15W/Port 2 x GbE LAN Ports 4 x USB 3.2 Gen 1	4 x COM Ports (RS-232/422/485) 1 x 3-pin Terminal block 8 x GbE LAN Ports with PoE 15W/Port 2 x GbE LAN Ports 4 x USB 3.2 Gen 1
Power	+12V~54VDC (non PoE) +54VDC (PoE support)	+12V~54VDC (non PoE) +54VDC (PoE support)
Operating Temp.	-20°C to 70°C	-20°C to 70°C
Ordering Information	9BQNNANOAMR-SI (Box Packing)	9BQNXAVNAMR-SI (Box Packing)
Build in Components	—	—

QBiX-Plus Series



New



QBiX-Plus Series/ QBiX-Lite Series

Model Name	QBiX-Plus-KBLA7100-A1	QBiX-Plus-EHLA6412-A1
Dimension	180W x 117D x 36H (mm)	165W x 105D x 27H (mm)
CPU	Intel® Core™ i3-7100U Processor, 14nm, 2 cores, 4 threads, 2.40 GHz	Intel® Celeron® J6412 Processor, 10nm, 4 cores, 4 threads, up to 2.6 GHz
Chipset	SoC	SoC
Memory	2 x DDR4 SO-DIMM sockets, Max. Capacity 32 GB, Support Dual Channel DDR4 2133 MHz	2 x DDR4 SO-DIMM sockets, Max. Capacity 32 GB, Support Dual Channel DDR4 3200MHz
Ethernet	2 x GbE LAN Ports (Intel® I219LM and Intel® I210AT)	2 x GbE LAN Ports (Realtek® RTL8118)
Graphic	Integrated Graphics Processor - Intel® HD Graphics 620: 2 x HDMI 2.0 2 independent display outputs	Integrated Graphics Processor - Intel® UHD Graphics for 10th Intel Processor 3 x HDMI 2.0 3 independent display outputs
Audio	Realtek® Audio Codec	Realtek® Audio Codec
Storage	—	—
Expansion Slots	1 x 2280 M.2 M-Key (PCIe x4, SATA 6Gb/s) 1 x 2230 M.2 E-Key 1 x Full-size Mini PCIe with SIM slot	1 x 2280 M.2 M-Key (PCIe x2, SATA 6Gb/s) 1 x 2230 M.2 E-Key 1 x 3052/3042 M.2 B-key (USB 3.0)
Front I/O	1 x USB 3.2 Gen 2x1 Type C 1 x USB 3.2 Gen 2x1 Type A 2 x USB 3.2 Gen 1 1 x COM Port (RS-232/422/485) 1 x Micro SD card slot 1 x Power button	2 x USB 3.2 Gen 1 1 x COM Port (RS-232) 1 x Micro SD card slot (USB 2.0) 1 x Power button with LED 1 x HDMI 1 x External Antenna Hole (Optional)
Rear I/O	1 x Combo Audio Jack (Microphone & Headphone) 2 x RJ45 LAN Ports 2 x USB 3.2 Gen 1 2 x HDMI 1 x DC Jack	1 x Combo Audio Jack (Microphone & Headphone) 2 x RJ45 LAN Ports 2 x USB 3.2 Gen 1 2 x HDMI 1 x DC Jack
Side I/O	3 x External Antenna Holes (Optional)	3 x External Antenna Holes (Optional)
TPM	—	—
Power	+19VDC (Adapter 19V/90W)	+12V~19VDC (Adapter 19V/65W)
Operating Temp.	0°C to 40°C	0°C to 50°C
Mounting	VESA 75/100	VESA 75/100
Ordering Information	9BCKABZAMR-SI (Box packing)	6BQS6412AMR-SI (Box packing)
Built-in Components	Please contact with your sales representative for more information or e-mailed to : sales@gigaipc.com	—

QBiX-Lite Series

New



Market Name	QBiX-Lite-TGLA1135G7-A1	QBiX-Lite-AMDA1605H-A1
Dimension	234W x 155D x 30H (mm)	234W x 155D x 30H (mm)
CPU	Intel® Core™ i5-1135G7 Processor 10nm SuperFin, 4 cores, 8 threads, up to 4.2 GHz	AMD® RYZEN™ V1605B Embedded Processor, 14nm, 4 cores, 8 threads, up to 3.6GHz
Chipset	SoC	SoC
Memory	2 x DDR4 SO-DIMM sockets, Max. Capacity 64 GB, Support Dual Channel DDR4 3200 MHz	2 x DDR4 SO-DIMM sockets, Max. Capacity 32 GB, Support Dual Channel DDR4 2400 MHz
Ethernet	2 x GbE LAN Ports (Intel® I219V and Intel® I211AT)	2 x GbE LAN Ports (Realtek® RTL8111HS)
Graphic	Integrated Graphics Processor - Intel® Iris Xe Graphics 2 x HDMI 2.0 2 x DP 1.4 (8K) 1 x DP 1.4 (USB Type C (8K)) 4 independent display outputs	Integrated Graphics Processor - AMD® Radeon™ Vega 8 Graphics: 4 x HDMI 2.0 4 independent display outputs EDID Emulation support with AMD utility
Audio	Realtek® Audio Codec	Realtek® Audio Codec
Storage	1 x 2.5" HDD/SSD (SATA 6Gb/s)	1 x 2.5" HDD/SSD (SATA 6Gb/s)
Expansion Slots	1 x 2280 M.2 M-Key (PCIe x2, SATA 6Gb/s) 1 x 2230 M.2 E-Key 1 x 3052 M.2 B-Key with SIM Slot (Support 5G)	1 x 2280 M.2 M-Key (PCIe x4, SATA 6Gb/s) 1 x 2230 M.2 E-Key 1 x Full-size Mini PCIe with SIM slot
Front I/O	1 x USB type C (USB 3.2 Gen 2x1, DP Alt Mode & PD Out -30W) (-100W requests to use 250W adapter) 1 x USB type C (USB 3.2 Gen 2x1, PD input-100W) 4 x USB 3.2 Gen 2x1 2 x HDMI 2 x DP 2 x RJ45 LAN Ports 2 x USB 2.0 1 x HDD LED 1 x Power button with LED 2 x External Antenna Holes (Optional)	2 x RJ45 LAN Ports 2 x USB 3.2 Gen 1 2 x USB 2.0 4 x HDMI 1 x Power button with LED 1 x HDD LED 1 x Screw Type DC Jack
Rear I/O	1 x COM Port (RS-232) 2 x USB 2.0 1 x Headphone Jack 1 x Screw type DC Jack 2 x External Antenna Holes (Optional)	1 x COM Port (RS-232/422/485 & RI/5V/12V) 2 x USB 2.0 1 x Line out phone jack 2 x External Antenna Holes (Optional)
Side I/O	1 x External Antenna Hole (on each side)	—
TPM	—	Onboard TPM 2.0 security chip INFINEON SLB9665TT2.0
Power	+12V~24VDC (Adapter 19.5V/135W)	+9V~36VDC (Adapter 19V/65W)
Operating Temp.	0°C to 50°C	0°C to 50°C
Mounting	Wall mount (Default)	Wall mount (Default)
Ordering Information	6BQL1135AMR-SI (Box packing)	6BQL1605AMR-SI (Box packing)
Built-in COM portponents	—	—

QBiX-Lite Series



QBiX-Lite Series/ SDM-L Series

Market Name	QBiX-Lite SDM Kits
Dimension	195W x 158D x 30H (mm)
Support model	Support SDM module as follows. SDM-1185G7EL SDM-1135G7L SDM-1115G4L SDM-7300L – Intel vPro support SDM-7100L SDM-4000L SDM-3350L-QV SDM-3350L-HW
Chipset	—
Memory	Depends on SDM module
Ethernet	Depends on SDM module
Graphic	Depends on SDM module
Audio	Intel® Integrated Audio
Storage	Depends on SDM module
Expansion Slots	Depends on SDM module
Front I/O	Depends on SDM module
Rear I/O	1 x USB 3.2 Gen 1 1 x Display Port (Co-lay with front Display port) 1 x HDMI (2 x HDMI for SDM-1185G7EL) 1 x UART 1 x DC-Jack 1 x 2x2 Power connector
Side I/O	—
TPM	—
Power	+12V/19V/24VDC (Adapter 19V/65W) (Adapter 19V/90W for SDM-1135G7L , SDM-1115G4L) (Adapter 12V/120W for SDM-1185G7EL)
Operating Temp.	0°C to 50°C
Mounting	Wall mount, VESA 75/100 (Optional)
Ordering Information	6BSD4000AMR-SI (Box packing)
Built-in COM portponents	—

SDM-L Series

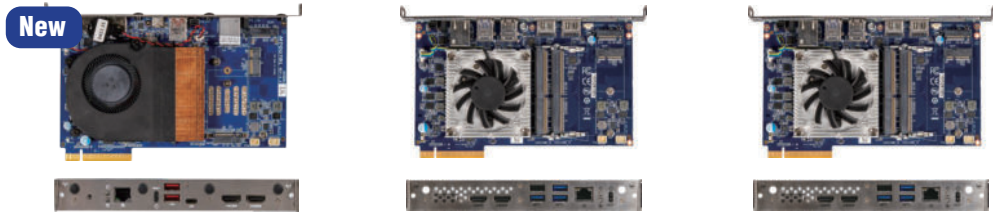

Model Name	SDM-1185G7EL	SDM-1135G7L	SDM-1115G4L
Dimensions	SDM-Large, 175W x 100D (mm)	SDM-Large, 175W x 100D (mm)	SDM-Large, 175W x 100D (mm)
CPU	Intel® Core™ i7-1185G7E Processor 10nm SuperFin, 4 cores, 8 threads, up to 4.40 GHz	Intel® Core™ i5-1135G7 Processor, 10nm SuperFin, 4 cores, 8 threads, up to 4.20 GHz	Intel® Core™ i3-1115G4 Processor , 10nm SuperFin, 2 cores, 4 threads, up to 4.10 GHz
VPro	—	—	—
Memory	4 x LPDDR4x-4267, Max. Capacity 16 GB	2 x DDR4 SO-DIMM sockets, Max. Capacity 64 GB, Support Dual Channel DDR4 3200 MHz	2 x DDR4 SO-DIMM sockets, Max. Capacity 64 GB, Support Dual Channel DDR4 3200 MHz
Ethernet	1 x 2.5GbE LAN Port (Intel® I225LM)	1 x GbE LAN Port (Intel® I219V)	1 x GbE LAN Port (Intel® I219V)
Graphic	Integrated Graphics Processor - Intel® Iris X ^e Graphics: 2 x HDMI 2.1 (SDM), 2 x HDMI 2.0 (Rear), 1 x DP 1.4 through USB type C (8k) 4 independent display outputs	Integrated Graphics Processor - Intel® Iris X ^e Graphics: 1 x HDMI 2.0 (SDM), 2 x HDMI 2.0 (Rear), 1 x DisplayPort (SDM) 4 independent display outputs	Integrated Graphics Processor - Intel® UHD Graphics: 1 x HDMI 2.0 (SDM), 2 x HDMI 2.0 (Rear), 1 x DisplayPort (SDM) 4 independent display outputs
Audio	Intel® Integrated Audio	Intel® Integrated Audio	Intel® Integrated Audio
Storage	—	—	—
Expansion Slots	1 x 2280 M.2 M-Key (Support NVME only) 1 x 2230 M.2 E-Key (WiFi 6E AX210 GIG+ 2230 CARD)	1 x 2280 M.2 M-Key (PCIe x4, SATA 6Gb/s) 1 x 2230 M.2 E-Key	1 x 2280 M.2 M-Key (PCIe x4, SATA 6Gb/s) 1 x 2230 M.2 E-Key
Internal I/O	—	—	—
Rear I/O	2 x HDMI 1 x RJ45 LAN Port 2 x USB 3.2 Type A Gen 2x1 1 x USB 3.2 Type C Gen 2x1 1 x PWR LED 1 x HDD LED 4 x External Antenna Holes (Optional) 1 x Reset button 1 x Power button	2 x HDMI 1 x RJ45 LAN Port 3 x USB 3.2 Gen 1 1 x USB 2.0 1 x Power/ HDD LED 2 x External Antenna Holes (Optional) 1 x Reset button 1 x Power button	2 x HDMI 1 x RJ45 LAN Port 3 x USB 3.2 Gen 1 1 x USB 2.0 1 x Power/ HDD LED 2 x External Antenna Holes (Optional) 1 x Reset button 1 x Power button
TPM	1 x TPM header	1 x TPM header	1 x TPM header
Operating Temp.	0°C to 55°C	0°C to 55°C	0°C to 55°C
Ordering Information	9MTGU7BLMR-IA (Box packing)	9MTGU5ALMR-SI (Box packing)	9MTGU3ALMR-SI (Box packing)
Built-in Components	—	—	—

SDM-L Series



Model Name	SDM-7300L	SDM-7100L	SDM-4000L
Dimensions	SDM-Large, 175W x 100D (mm)	SDM-Large, 175W x 100D (mm)	SDM-Large, 175W x 100D (mm)
CPU	Intel® Core™ i5-7300U Processor, 14nm, 2 cores, 4 threads, up to 3.5 GHz, vPro support	Intel® Core™ i3-7100U Processor, 14nm, 2 cores, 4 threads, 2.40 GHz	Intel® Celeron® N4000 Processor, 14nm, 2 Cores, 2 threads, up to 2.6 GHz
VPro	Intel® vPro™ Platform Eligibility	—	—
Memory	2 x DDR4 SO-DIMM sockets, Max. Capacity 32 GB, Support Dual Channel DDR4 2133 MHz	2 x DDR4 SO-DIMM sockets, Max. Capacity 32 GB, Support Dual Channel DDR4 2133 MHz	2 x DDR4 SO-DIMM sockets, Max. Capacity 8 GB, Support Dual Channel DDR4 2400 MHz
Ethernet	1 x GbE LAN Port (Intel® I219LM)	1 x GbE LAN Port (Intel® I219V)	1 x GbE LAN Port (Realtek® RTL8111HS)
Graphic	Integrated Graphics Processor - Intel® HD Graphics 620: 1 x HDMI 2.0 (SDM), 1 x Display Port (Rear/SDM) 2 independent display outputs	Integrated Graphics Processor - Intel® HD Graphics 620: 1 x HDMI 2.0 (SDM), 1 x Display Port (Rear/SDM) 2 independent display outputs	Integrated Graphics Processor - Intel® UHD Graphics 600: 1 x HDMI 2.0 (SDM), 1 x Display Port (Rear/SDM) 2 independent display outputs
Audio	Intel® Integrated Audio	Intel® Integrated Audio	Intel® Integrated Audio
Storage	—	—	1 x eMMC 32GB
Expansion Slots	1 x 2280 M.2 M-Key (PCIe x4, SATA 6Gb/s) 1 x 2230 M.2 E-Key	1 x 2280 M.2 M-Key (PCIe x4, SATA 6Gb/s) 1 x 2230 M.2 E-Key	1 x 2280 M.2 M-Key (SATA 6Gb/s) 1 x 2230 M.2 E-Key
Internal I/O	—	—	—
Rear I/O	1 x Display Port 1 x RJ45 LAN Port 4 x USB 3.2 Gen 1 1 x Power/ HDD LED 2 x External Antenna Holes (Optional) 1 x Reset button 1 x Power button	1 x Display Port 1 x RJ45 LAN Port 4 x USB 3.2 Gen 1 1 x Power/ HDD LED 2 x External Antenna Holes (Optional) 1 x Reset button 1 x Power button	1 x Display Port 1 x RJ45 LAN Port 4 x USB 3.2 Gen 1 1 x Power/ HDD LED 2 x External Antenna Holes (Optional) 1 x Reset button 1 x Power button
TPM	1 x TPM header	1 x TPM header	—
Operating Temp.	0°C to 55°C	0°C to 55°C	0°C to 55°C
Ordering Information	9MFLP5ALMR-SI (Box packing)	9MFLP3ALMR-SI (Box packing)	9MZGLKALMR-SI (Box packing)
Built-in Components	—	—	—

SDM Docking Board Series



Model Name	CIBPT	CIBPX
Dimensions	227W x 49D (mm)	190W x 54.7D (mm)
CPU	—	—
VPro	—	—
Memory	—	—
Ethernet	—	—
Graphic	—	—
Audio	—	—
Storage	—	—
Expansion Slots	1 x PCIe x8 slot for SDM-L module 1 x Full-size Mini PCIe (PCIe only)	1 x PCIe x8 slot for SDM-L module 1 x Full-size Mini PCIe (PCIe only)
Internal I/O	2 x I2C 1 x GPIO 1 x UART (TX, RX only)	2 x I2C 1 x GPIO 1 x UART (TX, RX only)
Rear I/O	1 x USB 3.2 Gen 1 1 x Display Port 1 x HDMI 1 x DC-Jack 1 x 2x2 Power connector	1 x USB 3.2 Gen 2x1 2 x HDMI 1 x DC-Jack 1 x 2x2 Power connector
TPM	—	—
Operating Temp.	0°C to 60°C	0°C to 60°C
Ordering Information	—	—
Built-in Components	—	—

Micro-ATX Series

Preliminary

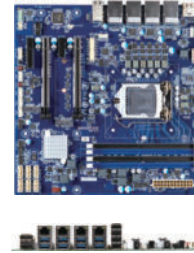

Micro-ATX Series

Model Name	uATX-H61EA	uATX-W48EA
CPU	Support for 12th Generation Intel® Core™i9/i7/i5/i3, Pentium® & Celeron® processors	Support for 11th/10th Generation Intel® Xeon® W-1200 series, Core™ i3, Pentium® & Celeron® processors
Socket	LGA 1700	LGA 1200
Chipset	Intel® H610E Chipset	Intel® W480E Chipset
Memory	2 x DDR4 SO-DIMM sockets, Max. Capacity 128 GB, Support Dual Channel DDR4 3200MHz	4 x DDR4 DIMM sockets, Max. Capacity 128 GB, Support Dual Channel DDR4 2933/2666 MHz
Ethernet	1 x 2.5GbE LAN Port (Intel® I226V) 1 x GbE LAN Port (Intel® I219AT or equivalent)	4 x GbE LAN Ports (Intel® I219LM and Intel® I211AT)
Graphic	Integrated Graphics Processor - Intel® HD Graphics: 2 x HDMI 2.0, 1 x DP 1.4, 1 x VGA, 1 x eDP/LVDS 3 independent display outputs	Integrated Graphics Processor - Depends on CPU: 1 x HDMI 1.4, 1 x DP, 1 x VGA, 1 x LVDS 3 independent display outputs
Audio	Realtek® Audio Codec	Realtek® Audio Codec
Storage	3 x SATA 6Gb/s Ports	6 x SATA 6Gb/s Ports (RAID 0/1/5/10)
Expansion Slots	1 x PCIe x16 (Gen3 x16 from CPU) 1 x 2280 M.2 M-Key (PCIe x4, SATA 6Gb/s) 1 x 2230 M.2 E-Key	2 x PCIe Gen3 x8 (or only 1 x PCIe Gen3 x16 on PCIe x16_A slot as optional) 1 x PCIe x4 (Gen3 x4) 1 x PCIe x1 (Gen3 x1) 1 x 2230 M.2 E-Key (PCIe x1 + USB 2.0) 1 x 2280/2242 M.2 M-Key (PCIe x4, SATA 6Gb/s)
Internal I/O	1 x 4-pin ATX main power connector 2 x SATA power connectors 1 x CPU fan header 1 x System fan header 1 x Front panel header 1 x Front panel audio header 1 x 2W Speaker out header 4 x USB 2.0 headers 1 x COM header (RS-232) 1 x GPIO (8 bits) & SMBus 1 x Backlight Control header 1 x Clear CMOS jumper 1 x Buzzer 1 x ATX control header 1 x AT/ATX mode select jumper	1 x 24-pin ATX main power connector 1 x 8-pin ATX 12V power connector 1 x CPU fan header 1 x System fan header 1 x Front panel header 1 x Front panel audio header 1 x VGA header 1 x Backlight Control header 1 x AT/ATX mode select jumper 4 x USB 2.0 headers 1 x COM header (RS-232/422/485 & RI/5V/12V) 1 x COM header (RS-232 & RI/5V/12V) 2 x COM headers (RS-232) 1 x GPIO (8 bits) & SMBUS header 1 x Buzzer 1 x Clear CMOS jumper
Rear I/O	2 x Audio Jacks (Line out, Mic in) 1 x COM Port (RS-232/422/485 & RI/5V/12V) 2 x HDMI 1 x Display Port 1 x VGA 2 x RJ45 LAN Ports 3 x USB 3.2 Gen 1 1 x USB 3.2 Gen 2x1 1 x DC Jack (+12V/+19V~+24VDC)	1 x HDMI 1 x Display Port 4 x RJ45 LAN Ports 8 x USB 3.2 Gen 1 4 x USB 2.0
TPM	1 x TPM header	1 x TPM header
Operating Temp.	0°C to 60°C	0°C to 60°C
Ordering Information	9MH61EAMMR-SI (Box packing)	9MW48EAMMR-SI (Box packing)

Micro-ATX Series



Model Name	uATX-Q47EA	uATX-H410A	uATX-Q370A
CPU	Support for 11th/10th Generation Intel® Core™ i9/i7/i5/i3, Pentium® & Celeron® processors	Support for 10th Generation Intel® Core™ i9/i7/i5/i3, Pentium® & Celeron® processors	Support for 9th/8th Generation Intel® Core™ i7/i5/i3, Pentium® & Celeron® processors
Socket	LGA 1200	LGA 1200	LGA 1151
Chipset	Intel® Q470E Chipset	Intel® H410 Chipset	Intel® Q370 Chipset
Memory	4 x DDR4 DIMM sockets, Max. Capacity 128 GB, Support Dual Channel DDR4 2933/2666 MHz	2 x DDR4 DIMM sockets, Max. Capacity 64 GB, Support Dual Channel DDR4 2933/2666 MHz	4 x DDR4 DIMM sockets, Max. Capacity 64 GB, Support Dual Channel DDR4 2666/2400 MHz
Ethernet	4 x GbE LAN Ports (Intel® I219LM and Intel® I211AT)	2 x GbE LAN Ports (Intel® I219V and Realtek® RTL8111HS)	2 x GbE LAN Ports (Intel® I219V and Realtek® RTL8111HS)
Graphic	Integrated Graphics Processor - Depends on CPU: 1 x HDMI 1.4, 1 x DP, 1 x VGA, 1 x LVDS 3 independent display outputs	Integrated Graphics Processor - Depends on CPU: 1 x HDMI 1.4, 1 x DVI-D, 1 x VGA 2 independent display outputs	Integrated Graphics Processor - depends on CPU: 1 x HDMI 1.4, 1 x DVI-D, 1 x VGA 3 independent display outputs
Audio	Realtek® Audio Codec	Realtek® Audio Codec	Realtek® Audio Codec
Storage	4 x SATA 6Gb/s Ports (RAID 0/1/5/10)	4 x SATA 6Gb/s Ports	6 x SATA 6Gb/s Ports (RAID 0/1/5/10)
Expansion Slots	2 x PCIe Gen3 x8 (or only 1 x PCIe Gen3 x16 on PCIe x16_A slot as optional) 1 x PCIe x4 (Gen3 x4) 1 x PCIe x1 (Gen3 x1) 1 x 2230 M.2 E-Key (PCIe x1 + USB 2.0) 1 x 2280/2242 M.2 M-Key (PCIe x4, SATA 6Gb/s)	1 x PCIe x16 (Gen3 x16) 1 x PCIe x4 (Gen3 x2) 2 x PCIe x1 (Gen3 x1)	1 x PCIe x16 (Gen3 x16) 1 x PCIe x4 (Gen3 x4) 2 x PCIe x1 (Gen3 x1) 1 x 2280/2260 M.2 M-Key (PCIe x4)
Internal I/O	1 x 24-pin ATX main power connector 1 x 8-pin ATX 12V power connector 1 x CPU fan header 1 x System fan header 1 x Front panel header 1 x Front panel audio header 1 x VGA header 1 x Backlight Control header 1 x AT/ATX mode select jumper 4 x USB 2.0 headers 1 x COM header (RS-232/422/485 & RI/5V/12V) 1 x COM header (RS-232 & RI/5V/12V) 2 x COM headers (RS-232) 1 x GPIO (8 bits) & SMBUS header 1 x Buzzer 1 x Clear CMOS jumper	1 x 24-pin ATX main power connector 1 x 8-pin ATX 12V power connector 1 x CPU fan header 2 x System fan headers 1 x Front panel header 1 x Front panel audio header 4 x USB 2.0 headers 3 x COM headers (RS-232) 1 x Clear CMOS jumper 1 x Buzzer 1 x Case open header	1 x 24-pin ATX main power connector 1 x 8-pin ATX 12V power connector 1 x CPU fan header 2 x System fan headers 1 x Front panel header 1 x Front panel audio header 4 x USB 2.0 headers 2 x USB 3.2 Gen 1 headers 3 x COM headers (RS-232) 1 x Clear CMOS jumper 1 x Buzzer 1 x AT/ATX mode select jumper
Rear I/O	1 x HDMI 1 x Display Port 4 x RJ45 LAN Ports 8 x USB 3.2 Gen 1 4 x USB 2.0	3 x Audio Jacks (Line in, Line out, Mic in) 1 x COM Port (RS-232) 1 x HDMI 1 x DVI-D 1 x VGA 2 x RJ45 LAN Ports 4 x USB 3.2 Gen 1	3 x Audio Jacks (Line in, Line out, Mic in) 1 x COM Port (RS-232) 1 x HDMI 1 x DVI-D 1 x VGA 2 x RJ45 LAN Ports 3 x USB 3.2 Gen 1 1 x USB 3.2 Gen 2x1
TPM	1 x TPM header	Onboard TPM 2.0 security chip INFINEON SLB9670VQ2.0	Onboard TPM 2.0 security chip INFINEON SLB9665VQ2.0
Operating Temp.	0°C to 60°C	0°C to 60°C	0°C to 60°C
Ordering Information	9MQ47EAMMR-SI (Box packing)	9MH410AMNR-SI (Bulk packing)	9MQ370AMNR-SI (Bulk packing)

Micro-ATX Series



Micro-ATX Series/ Mini-ITX Series

Model Name	uATX-H310A	uATX-H110A	uATX-RYZEN
CPU	Support for 9th/8th Generation Intel® Core™ i7/i5/i3, Pentium® & Celeron® processors	Support for 7th/6th Generation Intel® Core™ i7/i5/i3, Pentium® & Celeron® processors	Support AMD® RYZEN™ 2 7'5'3 CPU AM4 μPGA (Matisse/ Picasso/ Raven2/ Pinnacle/ Raven/Summit Ridge)
Socket	LGA 1151	LGA 1151	Socket AM4
Chipset	Intel® H310 Chipset	Intel® H110 Chipset	AMD® B450
Memory	2 x DDR4 DIMM sockets, Max. Capacity 32 GB, Support Dual Channel DDR4 2666/2400 MHz	2 x DDR4 DIMM sockets, Max. Capacity 32 GB, Support Dual Channel DDR4 2400/2133 MHz	4 x DDR4 DIMM sockets, Max. Capacity 64 GB, Support Dual Channel DDR4 2666/2400/2133 MHz
Ethernet	2 x GbE LAN Ports (Intel® I219V and Realtek® RTL8111HS)	2 x GbE LAN Ports (Intel® I219LM and Realtek® RTL8111HS)	2 x GbE LAN Ports (Realtek® RTL8111HS)
Graphic	Integrated Graphics Processor - depends on CPU: 1 x HDMI 1.4 1 x DVI-D 1 x VGA 2 independent display outputs	Integrated Graphics Processor - depends on CPU: 1 x HDMI 1.4, 1 x DVI-D, 1 x VGA 2 independent display outputs	Integrated Graphics Processor - Radeon™ Vega 11/ 8/ 3/ Graphics 1 x HDMI 1.4, 1 x Display Port, 1 x VGA 3 independent display outputs
Audio	Realtek® Audio Codec	Realtek® Audio Codec	Realtek® Audio Codec
Storage	4 x SATA 6Gb/s Ports	4 x SATA 6Gb/s Ports	4 x SATA 6Gb/s Ports (RAID 0/1/10)
Expansion Slots	1 x PCIe x16 (Gen3 x16) 1 x PCIe x4 (Gen2 x2) 2 x PCIe x1 (Gen2 x1)	1 x PCIe x16 (Gen3 x16) 1 x PCIe x4 (Gen2 x2) 2 x PCIe x1 (Gen2 x1)	1 x PCIe x16 (Gen3 x16) 1 x PCIe x4 (Gen2 x2) 2 x PCIe x1 (Gen2 x1) 1 x 2280/2260/2242 M.2 M-Key (PCIe x4, SATA 6Gb/s)
Internal I/O	1 x 24-pin ATX main power connector 1 x 8-pin ATX 12V power connector 1 x CPU fan header 2 x System fan headers 1 x Front panel header 2 x Front panel audio headers 1 x Front panel header 1 x Front panel audio header 4 x USB 2.0 headers 3 x COM headers (RS-232) 1 x Clear CMOS jumper 1 x Buzzer	1 x 24-pin ATX main power connector 1 x 8-pin ATX 12V power connector 1 x CPU fan header 2 x System fan headers 1 x Front panel header 1 x Front panel audio header 2 x USB 2.0 headers 3 x COM headers (RS-232) 1 x Clear CMOS jumper 1 x Buzzer	1 x 24-pin ATX main power connector 1 x 4-pin ATX 12V power connector 1 x CPU fan header 2 x System fan headers 1 x Front panel header 1 x Front panel audio header 1 x 2W Speaker out header 4 x USB 2.0 headers 2 x USB 3.2 Gen 1 headers 5 x COM headers (RS-232) 1 x PS/2 Keyboard/ Mouse Connector 1 x GPIO (8 bits) & SMBUS header 1 x Clear CMOS jumper 1 x Buzzer 1 x AT/ATX mode select jumper
Rear I/O	3 x Audio Jacks (Line in, Line out, Mic in) 1 x COM Port (RS-232) 1 x HDMI 1 x DVI-D 1 x VGA 2 x RJ45 LAN Ports 4 x USB 3.2 Gen 1	3 x Audio Jacks (Line in, Line out, Mic in) 1 x COM Port (RS-232) 1 x HDMI 1 x DVI-D 1 x VGA 2 x RJ45 LAN Ports 4 x USB 3.2 Gen 1	3 x Audio Jacks (Line in, Line out, Mic in) 1 x COM Port (RS-232/422/485 & RI/5V/12V) 1 x HDMI 1 x Display Port 1 x VGA 2 x RJ45 LAN Ports 4 x USB 3.2 Gen 1 1 x USB 3.2 Gen 2x1 1 x USB 3.2 Gen 2x1 (Type C)
TPM	Onboard TPM 2.0 security chip INFINEON SLB9665VQ2.0	Onboard TPM 2.0 security chip INFINEON SLB9665VQ2.0	1 x TPM header
Operating Temp.	0°C to 60°C	0°C to 60°C	0°C to 60°C
Ordering Information	9MCH31AMNR-SI (Bulk packing)	9MDH11BMNR-SI (Bulk packing)	9MZRYZBMNR-SI (Bulk packing)

Mini-ITX Series

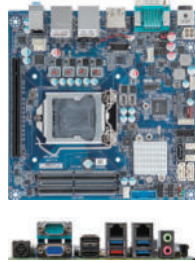

New

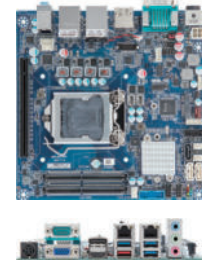

Model Name	mITX-Q47EA	mITX-H42EA	mITX-Q370A
CPU	Support for 10th Generation Intel® Core™ i9/i7/i5/i3, Pentium® & Celeron® processors	Support for 10th Generation Intel® Core™ i9/i7/i5/i3, Pentium® & Celeron® processors	Support for 9th/8th Generation Intel® Core™ i7/i5/i3, Pentium® & Celeron® processors
Socket	LGA 1200	LGA 1200	LGA 1151
Chipset	Intel® Q470E Chipset	Intel® H420E Chipset	Intel® Q370 Chipset
Memory	2 x DDR4 SO-DIMM sockets, Max. Capacity 64 GB, Support Dual Channel DDR4 2933/2666 MHz	2 x DDR4 SO-DIMM sockets, Max. Capacity 64 GB, Support Dual Channel DDR4 2933/2666 MHz	2 x DDR4 SO-DIMM sockets, Max. Capacity 32 GB, Support Dual Channel DDR4 2666/2400 MHz
Ethernet	2 x GbE LAN Ports (Intel® I219LM and Intel® I211AT)	2 x GbE LAN Ports (Intel® I219V and Intel® I211AT)	2 x GbE LAN Ports (Intel® I219LM and Intel® I211AT)
Graphic	Integrated Graphics Processor - depends on CPU: 1 x HDMI 2.0 1 x Display Port 1 x VGA 1 x eDP 1 x LVDS 3 independent display outputs	Integrated Graphics Processor - depends on CPU: 1 x HDMI 2.0 1 x Display Port 1 x VGA 1 x eDP 1 x LVDS 2 independent display outputs	Integrated Graphics Processor - depends on CPU: 1 x HDMI 1.4 1 x Display Port 1 x VGA 1 x eDP 3 independent display outputs
Audio	Realtek® Audio Codec	Realtek® Audio Codec	Realtek® Audio Codec
Storage	3 x SATA 6Gb/s Ports (RAID 0/1/5/10)	3 x SATA 6Gb/s Ports	3 x SATA 6Gb/s Ports (RAID 0/1/5/10)
Expansion Slots	1 x PCIe x16 (Gen3 x16) 1 x 2280/2242 M.2 M-Key (PCIe Gen3 x4, SATA 6Gb/s) 1 x 2230 M.2 E-Key	1 x PCIe x16 (Gen3 x16) 1 x 2280/2242 M.2 M-Key (PCIe x2) 1 x 2230 M.2 E-Key	1 x PCIe x16 (Gen3 x16) 1 x 2280/2242 M.2 M-Key (PCIe x4, SATA 6Gb/s, Optane memory) 1 x 2230 M.2 E-Key
Internal I/O	1 x 4-pin ATX main power connector 2 x SATA power connectors 1 x CPU fan header 1 x System fan header 1 x Front panel header 1 x Front panel audio header 1 x 2W Speaker out header 4 x USB 2.0 headers 2 x USB 3.2 Gen 1 headers 1 x COM header (RS-232) 1 x Clear CMOS jumper 1 x GPIO (8 bits) & SMBUS header 1 x Backlight Control header 1 x Buzzer 1 x ATX Control header 1 x AT/ATX mode select jumper	1 x 4-pin ATX main power connector 2 x SATA power connectors 1 x CPU fan header 1 x System fan header 1 x Front panel header 1 x Front panel audio header 1 x 2W Speaker out header 3 x USB 2.0 headers 2 x USB 3.2 Gen 1 headers 1 x GPIO (8 bits) & SMBUS header 1 x COM header (RS-232) 1 x Backlight Control header 1 x Clear CMOS jumper 1 x Buzzer 1 x ATX Control header 1 x AT/ATX mode select jumper	1 x 4-pin ATX main power connector 2 x SATA power connectors 1 x CPU fan header 1 x System fan header 1 x Front panel header 1 x Front panel audio header 1 x 2W Speaker out header 4 x USB 2.0 headers 2 x USB 3.2 Gen 1 headers 1 x COM header (RS-232) 1 x GPIO (8-bits) & SMBUS header 1 x Backlight Control header 1 x Clear CMOS jumper 1 x Buzzer 1 x Case open header 1 x AT/ATX mode select jumper
Rear I/O	2 x Audio Jacks (Line out, Mic in) 1 x COM Port (RS-232/422/485 & RI/5V/12V) 1 x HDMI 1 x Display Port 1 x VGA 2 x RJ45 LAN Ports 3 x USB 3.2 Gen 1 1 x USB 3.2 Gen 2x1 1 x DC Jack (+12V/+19V~+24VDC)	2 x Audio Jacks (Line out, Mic in) 1 x COM Port (RS-232/422/485 & RI/5V/12V) 1 x HDMI 1 x Display Port 1 x VGA 2 x RJ45 LAN Ports 4 x USB 3.2 Gen 1 1 x DC Jack (+12V/+19V~+24VDC)	3 x Audio Jacks (Line in, Line out, Mic in) 1 x COM Port (RS-232/422/485 & RI/5V/12V) 1 x HDMI 1 x Display Port 1 x VGA 2 x RJ45 LAN Ports 3 x USB 3.2 Gen 1 1 x USB 3.2 Gen 2x1 1 x DC Jack (+12V/+19V/+24VDC)
TPM	1 x TPM header (LPC)	1 x TPM header	1 x TPM header
Operating Temp.	0°C to 60°C	0°C to 60°C	0°C to 60°C
Ordering Information	9MQ47EAIMR-SI (Box packing)	9MH42EAIMR-SI (Box packing)	9MCQ37AINR-SI (Bulk packing)

Mini-ITX Series

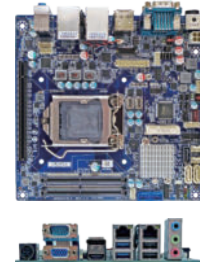

Mini-ITX Series

Model Name	mITX-H310A	mITX-Q170A	mITX-H110A
CPU	Support for 9th/8th Generation Intel® Core™ i7/i5/i3, Pentium® & Celeron® processors	Support for 7th/6th Generation Intel® Core™ i7/i5/i3, Pentium® & Celeron® processors	Support for 7th/6th Generation Intel® Core™ i7/i5/i3, Pentium® & Celeron® processors
Socket	LGA 1151	LGA 1151	LGA 1151
Chipset	Intel® H310 Chipset	Intel® Q170 Chipset	Intel® H110 Chipset
Memory	2 x DDR4 SO-DIMM sockets, Max. Capacity 32 GB, Support Dual Channel DDR4 2666/2400 MHz	2 x DDR4 SO-DIMM sockets, Max. Capacity 32 GB, Support Dual Channel DDR4 2400/2133 MHz	2 x DDR4 SO-DIMM sockets, Max. Capacity 32 GB, Support Dual Channel DDR4 2400/2133 MHz
Ethernet	2 x GbE LAN Ports (Intel® I219V and Intel® I211AT)	2 x GbE LAN Ports (Intel® I219LM and Intel® I211AT)	2 x GbE LAN Ports (Intel® I219V and Intel® I211AT)
Graphic	Integrated Graphics Processor - depends on CPU: 1 x HDMI 1.4, 1 x Display Port 1 x VGA, 1 x LVDS or eDP 2 independent display outputs	Integrated Graphics Processor - depends on CPU: 1 x HDMI 1.4, 1 x Display Port 1 x LVDS or eDP 3 independent display outputs	Integrated Graphics Processor - depends on CPU: 1 x HDMI 1.4, 1 x Display Port, 1 x VGA, 1 x LVDS or eDP 2 independent display outputs
Audio	Realtek® Audio Codec	Realtek® Audio Codec	Realtek® Audio Codec
Storage	2 x SATA 6Gb/s Ports	3 x SATA 6Gb/s Ports (RAID 0/1/5/10) (incl. 1 x SATA supports SATA DOM)	3 x SATA 6Gb/s Ports (incl. 1 x SATA supports SATA DOM)
Expansion Slots	1 x PCIe x16 (Gen3 x16) 1 x 2280/2242 M.2 M-Key (SATA 6Gb/s) 1 x 2230 M.2 E-Key (WiFi/BT)	1 x PCIe x16 (Gen3 x16) 1 x 2280/2242 M.2 M-Key (PCIe x4, SATA 6Gb/s) 1 x Full-size Mini PCIe/mSATA	1 x PCIe x16 (Gen3 x16) 1 x 2280/2242 M.2 M-Key (SATA 6Gb/s) 1 x Full-size Mini PCIe
Internal I/O	1 x 4-pin ATX main power connector 1 x SATA power connector 1 x CPU fan header 1 x System fan header 1 x Front panel header 1 x Front panel audio header 1 x 2W Speaker out header 4 x USB 2.0 headers 2 x COM headers (RS-232) 1 x COM header (RS-232/422/485 & RI/5V/12V) 1 x GPIO (8-bits) & SMBUS header 1 x Backlight Control header 1 x Clear CMOS jumper 1 x Buzzer 1 x ATX Control header 1 x AT/ATX mode select jumper	1 x 4-pin ATX main power connector 2 x SATA power connectors 1 x CPU fan header 1 x System fan header 1 x Front panel header 1 x Front panel audio header 1 x 2W Speaker out header 4 x USB 2.0 headers 2 x USB 3.2 Gen 1 headers 1 x COM header (RS-232/422/485 & RI/5V/12V) 1 x GPIO (8 bits) & SMBUS header 1 x Backlight Control header 1 x Clear CMOS jumper 1 x Buzzer 1 x AT/ATX mode select jumper	1 x 4-pin ATX main power connector 2 x SATA power connectors 1 x CPU fan header 1 x System fan header 1 x Front panel header 1 x Front panel audio header 1 x 2W Speaker out header 3 x USB 2.0 headers 2 x USB 3.2 Gen 1 headers 1 x COM header (RS-232/422/485 & RI/5V/12V) 1 x GPIO (8 bits) & SMBUS header 1 x Backlight Control header 1 x Clear CMOS jumper 1 x Buzzer 1 x AT/ATX mode select jumper
Rear I/O	3 x Audio Jacks (Line in, Line out, Mic in) 1 x COM Port (RS-232/422/485 & RI/5V/12V) 1 x HDMI 1 x Display Port 1 x VGA 2 x RJ45 LAN Ports 4 x USB 3.2 Gen 1 1 x DC Jack (+12V/+19V/+24VDC)	3 x Audio Jacks (Line in, Line out, Mic in) 1 x COM Port (RS-232/422/485 & RI/5V/12V) 1 x HDMI 1 x Display Port 1 x VGA 2 x RJ45 LAN Ports 4 x USB 3.2 Gen 1 1 x DC Jack (+12V/+19V/+24VDC)	3 x Audio Jacks (Line in, Line out, Mic in) 1 x COM Port (RS-232/422/485 & RI/5V/12V) 1 x HDMI 1 x Display Port 1 x VGA 2 x RJ45 LAN Ports 2 x USB 2.0 2 x USB 3.2 Gen 1 1 x DC Jack (+12V/+19V/+24VDC)
TPM	1 x TPM header	1 x TPM header	1 x TPM header
Operating Temp.	0°C to 60°C	0°C to 60°C	0°C to 60°C
Ordering Information	9MH310AIMR-SI (Box packing)	9MDQ17BIMR-SI (Box packing)	9MDH11LIMR-SI (Box packing)

Mini-ITX Series

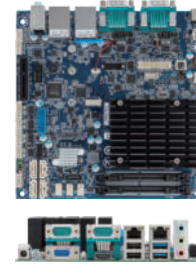

Model Name	mITX-H110B	mITX-4125A
CPU	Support for 7th/6th Generation Intel® Core™ i7/i5/i3, Pentium® & Celeron® processors	Intel® Celeron® J4125 Processor, 14nm, 4 cores, 4 threads, up to 2.7 GHz, fan-less design
Socket	LGA 1151	FCBGA1090
Chipset	Intel® H110 Chipset	—
Memory	2 x DDR4 SO-DIMM sockets, Max. Capacity 32 GB, Support Dual Channel DDR4 2400/2133 MHz	2 x DDR4 SO-DIMM sockets, Max. Capacity 8 GB, Support Dual Channel DDR4 2400 MHz
Ethernet	6 x GbE LAN Ports (1 x Intel® I219V and 5 x Intel® I211AT)	2 x GbE LAN Ports (Realtek® RTL8111HS)
Graphic	Integrated Graphics Processor - depends on CPU: 1 x HDMI 1.4, 1 x VGA 2 independent display outputs	Integrated Graphics Processor - Intel® UHD Graphics 600: 1 x HDMI 2.0, 1 x VGA, 1 x LVDS or eDP 3 independent display outputs
Audio	Realtek® Audio Codec	Realtek® Audio Codec
Storage	2 x SATA 6Gb/s Ports	5 x SATA 6Gb/s Ports (4 x Marvell 88SE9230, support RAID 0/1/10) (1 x supports SATA DOM)
Expansion Slots	1 x PCIe x16 (Gen3 x16) 1 x 2280/2242 M.2 M-Key (SATA 6Gb/s) 1 x Full-size mSATA	1 x PCIe x4 (Gen2 x2) 1 x 2280/2260/2242 M.2 M-Key (SATA 6Gb/s) 1 x 2230 M.2 E-Key (CNVi cards only)
Internal I/O	1 x 4-pin ATX main power connector 2 x SATA power connectors 1 x CPU fan header 1 x System fan header 1 x Front panel header 1 x Front panel audio header 1 x 2W Speaker out header 6 x USB 2.0 headers 2 x COM headers (RS-232/422/485 & RI/5V/12V) 1 x GPIO (8 bits) & SMBUS header 1 x Clear CMOS jumper 1 x Buzzer 1 x AT/ATX mode select jumper	1 x 4-pin ATX main power connector 3 x SATA power connectors 1 x CPU fan header 1 x System fan header 1 x Front panel header 1 x Front panel audio header 1 x 2W Speaker out header 2 x USB 2.0 headers 2 x USB 3.2 Gen 1 headers 4 x COM headers (RS-232) 1 x GPIO (8 bits) & SMBUS header 1 x Case open header 1 x AT/ATX mode select jumper 1 x Backlight Control header 1 x RAID LED header 2 x LAN LED headers 1 x Buzzer
Rear I/O	3 x Audio Jacks (Line in, Line out, Mic in) 1 x HDMI 1 x VGA 6 x RJ45 LAN Ports 4 x USB 3.2 Gen 1 1 x DC Jack (+12V/+19V/+24VDC)	3 x Audio Jacks (Line in, Line out, Mic in) 2 x COM Ports (RS-232/422/485 & RI/5V/12V) 1 x HDMI 1 x VGA 2 x RJ45 LAN Ports 2 x USB 2.0 2 x USB 3.2 Gen 1 1 x DC Jack (+12VDC)
TPM	1 x TPM header	1 x TPM header
Operating Temp.	0°C to 60°C	0°C to 60°C
Ordering Information	9MH110AIMR-SI (Box packing)	9MGMLJAINR-SI (Bulk packing)

Mini-ITX Series

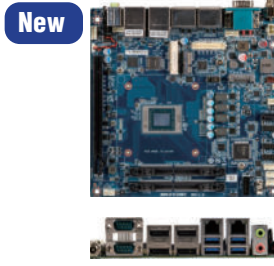

Mini-ITX Series/Thin-Mini-ITX Series

Model Name	mITX-1900A	mITX-2748A	mITX-1605A
CPU	Intel® Celeron® J1900 Processor, 22nm, 4 cores, 4 threads, up to 2.42 GHz	AMD Ryzen™ V2748 Embedded Processor, 7nm, 8 cores, 16 threads, 2.9 GHz, up to 4.25GHz	AMD® RYZEN™ V1605B Embedded Processor, 14nm, 4 cores, 8 threads, 2.0 GHz, up to 3.6 GHz
Socket	FCBGA1170	FP6 BGA	FP5 BGA
Chipset	—	—	—
Memory	2 x DDR3L SO-DIMM sockets, Max. Capacity 8 GB, Support Dual Channel DDR3L 1333 MHz	2 x DDR4 SO-DIMM sockets, Max. Capacity 32 GB, Support Dual channel DDR4 3200 MHz	2 x DDR4 SO-DIMM sockets, Max. Capacity 32 GB, Support Dual Channel DDR4 2400 MHz
Ethernet	2 x GbE LAN Ports (Realtek® RTL8111G)	2 x GbE LAN Ports (Realtek® RTL8118-CG)	2 x GbE LAN Ports (Realtek® RTL8111HS)
Graphic	Integrated Graphics Processor - Intel® HD Graphics: 1 x HDMI 1.4 1 x VGA 1 x LVDS 2 independent display outputs	Integrated Graphics Processor - AMD Radeon™ Graphics: 4 x Display Ports 1 x LVDS port (switch from DP) 4 independent display outputs	Integrated Graphics Processor - AMD Radeon™ Vega 8 Graphics: 4 x Display Ports 1 x LVDS (switch from DP) 4 independent display outputs
Audio	Realtek® Audio Codec	Realtek® Audio Codec	Realtek® Audio Codec
Storage	1 x SATA 3Gb/s Port (incl. 1 x SATA supports SATA DOM)	1 x SATA 6Gb/s Port	1 x SATA 6Gb/s Port
Expansion Slots	1 x PCI 1 x Full-size Mini PCIe 1 x Full-size mSATA	1 x PCIe x16 (Gen3x8) 1 x 2280 M.2 M-Key (SATA 6Gb/s) 1 x 2230 M.2 E-Key 1 x Full-size mini PCIe with SIM slot	1 x PCIe x16 (Gen3 x8) 1 x 2280 M.2 M-Key (SATA 6Gb/s) 1 x 2230 M.2 E-Key 1 x Full-size Mini PCIe with SIM slot
Internal I/O	1 x 4-pin ATX power connector 1 x SATA power header 1 x CPU fan header 1 x System fan header 1 x Front panel header 1 x Front panel audio header 1 x 2W Speaker out header 2 x USB 2.0 headers 1 x COM header (RS-232/422/485) 3 x COM headers (RS-232) 1 x COM header (RS-232 & RI/5V/12V) 1 x GPIO (8 bits) & SMBUS header 1 x PS/2 KB/MS Connector 1 x AT/ATX mode select jumper 1 x Backlight Control header 1 x Clear CMOS jumper 1 x Buzzer	1 x 4-pin ATX power connector 1 x SATA power connector 1 x CPU fan header 1 x System fan header 1 x Front panel header 1 x Front panel audio header 1 x 2W Speaker out header 6 x USB 2.0 headers 2 x COM headers (RS-232/422/485) 1 x GPIO (8 bits) & SMBus header 1 x Backlight Control header 1 x LVDS/ DP Jumper 1 x AT/ATX mode select jumper 1 x ATX Control header 1 x Clear CMOS jumper	1 x 4-pin ATX power connector 1 x SATA power connector 1 x CPU fan header 1 x System fan header 1 x Front panel header 1 x Front panel audio header 1 x 2W Speaker out header 6 x USB 2.0 headers 2 x COM headers (RS-232) 1 x GPIO (8 bits) & SMBUS header 1 x Backlight Control header 1 x LVDS/ DP jumper 1 x AT/ATX mode select jumper 1 x Clear CMOS jumper
Rear I/O	3 x Audio Jacks (Line in, Line out, Mic in) 1 x COM Port (RS-232) 1 x HDMI 1 x VGA 2 x RJ45 LAN Ports 4 x USB 2.0 1 x USB 3.2 Gen 1 1 x DC Jack (+12VDC)	2 x Audio Jacks (Line out, Mic in) 2 x COM Ports (RS-232/422/485 & RI/5V/12V) 4 x Display Ports 2 x RJ45 LAN Ports 4 x USB 3.2 Gen 1 1 x DC Jack (+12V~24VDC)	3 x Audio Jacks (Line in, Line out, Mic in) 2 x COM Ports (RS-232/422/485 & RI/5V/12V) 4 x Display Ports 2 x RJ45 LAN Ports 4 x USB 3.2 Gen 1 1 x DC Jack (+12V~24VDC)
TPM	1 x TPM header	1 x TPM header	1 x TPM header
Operating Temp.	0°C to 60°C	0°C to 60°C	0°C to 60°C
Ordering Information	Fan version: 9MVBAYAINS-SI (Bulk packing) Fanless version: 9MVBAYAINS-00 (Bulk packing)	Fan version: 9MRZV2MIMR-SI (Box packing)	Fan version: 9MRZNMIMR-SI (Box packing)

Thin Mini-ITX Series

Preliminary

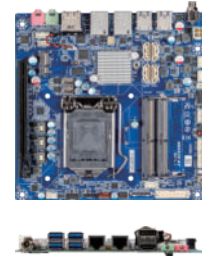
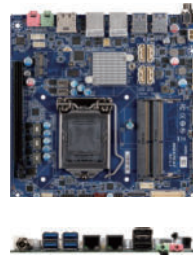
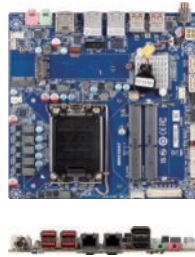

Model Name	iTXL-H610A	iTXL-Q47EA	iTXL-H42EA
CPU	Support for 12th Generation Intel® Core™ i9/i7/i5/i3, Pentium® & Celeron® processors	Support for 10th Generation Intel® Core™ i9/i7/i5/i3, Pentium® & Celeron® processors	Support for 10th Generation Intel® Core™ i9/i7/i5/i3, Pentium® & Celeron® processors
Socket	LGA 1700	LGA 1200	LGA 1200
Chipset	Intel® H610 Chipset	Intel® Q470E Chipset	Intel® H420E Chipset
Memory	2 x DDR4 SO-DIMM sockets, Max. Capacity 128 GB, Support Dual Channel DDR4 3200 MHz	2 x DDR4 SO-DIMM sockets, Max. Capacity 64 GB, Support Dual Channel DDR4 2933/2666 MHz	2 x DDR4 SO-DIMM sockets, Max. Capacity 64 GB, Support Dual Channel DDR4 2933/2666 MHz
Ethernet	2 x GbE LAN Ports (Realtek® RTL8118-CG)	2 x GbE LAN Ports (Intel® I219LM and Intel® I211AT)	2 x GbE LAN Ports (Intel® I219V and Intel® I211AT)
Graphic	Integrated Graphics Processor - depends on CPU: 1 x HDMI 2.0 1 x Display Port 1 x LVDS 2 independent display outputs	Integrated Graphics Processor - depends on CPU: 1 x HDMI 2.0 1 x Display Port 1 x LVDS 1 x eDP 3 independent display outputs	Integrated Graphics Processor - depends on CPU: 1 x HDMI 2.0 1 x Display Port 1 x LVDS 1 x eDP 2 independent display outputs
Audio	Realtek® Audio codec	Realtek® Audio codec	Realtek® Audio Codec
Storage	2 x SATA 6Gb/s Ports	4 x SATA 6Gb/s Ports (RAID 0/1/5/10)	4 x SATA 6Gb/s Ports
Expansion Slots	1 x 2280 M.2 M-Key (PCIe x4, SATA) 1 x 2230 M.2 E-Key	1 x PCIe x16 (Gen3 x8) 1 x 2280 M.2 M-Key (PCIe x4, SATA 6Gb/s) 1 x 2230 M.2 E-Key	1 x PCIe x16 (Gen3 x8) 1 x 2280 M.2 M-Key (PCIe x2) 1 x 2230 M.2 E-Key
Internal I/O	1 x 4-pin ATX main power connector 1 x SATA Power connector 1 x CPU fan header 1 x System fan header 1 x Front panel header 1 x Front panel audio header 1 x 2W Speaker out header 1 x GPIO (8 bits) & SMBus header 4 x USB 2.0 headers 1 x COM header (RS-232/422/485 & RI/5V/12V) 1 x COM header (RS-232) 1 x Backlight Control header 1 x LSW header 1 x ATX Control header	1 x 4-pin ATX main power connector 2 x SATA Power connectors 1 x CPU fan header 1 x System fan header 1 x Front panel header 1 x Front panel audio header 1 x 2W Speaker out header 6 x USB 2.0 headers 1 x COM header (RS-232) 1 x COM header (RS-232/422/485 & RI/5V/12V) 1 x GPIO (8 bits) & SMBus header 1 x Clear CMOS jumper 1 x Backlight Control header 1 x ATX Control header 1 x AT/ATX mode select jumper	1 x 4-pin ATX main power connector 2 x SATA Power connectors 1 x CPU fan header 1 x System fan header 1 x Front panel header 1 x Front panel audio header 1 x 2W Speaker out header 5 x USB 2.0 headers 1 x COM header (RS-232) 1 x COM header (RS-232/422/485 & RI/5V/12V) 1 x GPIO (8 bits) & SMBus header 1 x Clear CMOS jumper 1 x Backlight Control header 1 x ATX Control header 1 x AT/ATX mode select jumper
Rear I/O	2 x Audio Jacks (Line out, Mic in) 1 x HDMI 1 x Display Port 2 x RJ45 LAN Ports 4 x USB 3.2 Gen 2x1 1 x DC Jack (+12V/+19V~24VDC)	2 x Audio Jacks (Line out, Mic in) 1 x HDMI 1 x Display Port 2 x RJ45 LAN Ports 4 x USB 3.2 Gen 1 1 x DC Jack (+12V/+19V~24VDC)	2 x Audio Jacks (Line out, Mic in) 1 x HDMI 1 x Display Port 2 x RJ45 LAN Ports 4 x USB 3.2 Gen 1 1 x DC Jack (+12V/+19V~24VDC)
TPM	1 x TPM header	1 x TPM header	1 x TPM header
Operating Temp.	0°C to 60°C	0°C to 60°C	0°C to 60°C
Ordering Information	9MH610ATMR-SI (Box packing)	9MQ47EATMR-SI (Box packing)	9MH42EATMR-SI (Box packing)

Thin Mini-ITX Series



New



Thin Mini-ITX Series

Model Name	iTXL-Q370A	iTXL-1135G7A/ iTXL-1115G4EA
CPU	Support for 9th/8th Generation Intel® Core™ i7/i5/i3, Pentium® & Celeron® processors	Intel® Core™ i5-1135G7 Processor 10nm SuperFin, 4 cores, 8 threads, up to 4.2 GHz Intel® Core™ i3-1115G4E Processor 10nm SuperFin, 2 cores, 4 threads, up to 3.90 GHz
Socket	LGA 1151	FCBGA1449
Chipset	Intel® Q370 Chipset	—
Memory	2 x DDR4 SO-DIMM sockets, Max. Capacity 32 GB, Support Dual Channel DDR4 2666/2400 MHz	2 x DDR4 SO-DIMM sockets, Max. Capacity 64 GB, Support Dual Channel DDR4 3200 MHz
Ethernet	1 x GbE LAN Port (Intel® I219LM)	1 x GbE LAN Port (Intel® I219V) 1 x 2.5GbE LAN Port (Intel® I226V)
Graphic	Integrated Graphics Processor - depends on CPU: 1 x HDMI 2.0 1 x Display Port 1 x LVDS 3 independent display outputs	Integrated Graphics Processor - Intel® Iris® X* Graphics: 4 x HDMI 2.0, 1 x LVDS or eDP 3 independent display outputs
Audio	Realtek® Audio Codec	Realtek® Audio Codec
Storage	4 x SATA 6Gb/s Ports (RAID 0/1/5/10)	1 x SATA 6Gb/s Port (RAID 0/1/5)
Expansion Slots	1 x PCIe x4 (Gen3 x4) 1 x 2280/2260 M.2 M-Key (PCIe x4, SATA 6Gb/s, Optane memory) 1 x 2230 M.2 E-Key	1 x 2280 M.2 M-Key (PCIe x4, SATA 6Gb/s) 1 x Full-size Mini PCIe 1 x 2230 M.2 E-key
Internal I/O	1 x 2-pin ATX main power connector 1 x SATA Power connector 1 x CPU fan header 1 x System fan header 1 x Front panel header 1 x Front panel audio header 1 x 3W Speaker out header 1 x DMIC header 5 x USB 2.0 headers 2 x USB 3.2 Gen 1 headers 1 x COM header (RS-232) 1 x FPD (For LVDS 19V) 1 x FPD_SW 1x3 (For Panel Power SW) 1 x LCD_VCC Pin header 1 x Backlight Control header 1 x Clear CMOS jumper	1 x 4-pin ATX main power connector 1 x SATA Power connector 1 x CPU fan header 1 x System fan header 1 x Front panel header 1 x Front panel audio header 4 x USB 2.0 headers 2 x USB 3.2 Gen 1 headers 4 x COM headers (RS-232/422/485 & RI/5V/12V) 1 x 2W Speaker out header 1 x Backlight Control header for eDP 1 x Backlight Control header for LVDS 1 x GPIO (8 bits) & SMBus header 1 x Buzzer 1 x AT/ATX mode select jumper
Rear I/O	2 x Audio Jacks (Line out, Mic in) 1 x HDMI 1 x Display Port 1 x RJ45 LAN Port 3 x USB 3.2 Gen 1 1 x USB 3.2 Gen 1 (Type C) 1 x DC Jack (+12V/+19VDC)	2 x Audio Jacks (Line out, Mic in) 4 x HDMI 2 x RJ45 LAN Ports 2 x USB 3.2 Gen 2x1 2 x USB 3.2 Gen 1 1 x DC Jack (+12~24VDC)
TPM	1 x TPM header	1 x TPM header
Operating Temp.	0°C to 60°C	0°C to 60°C
Ordering Information	9MQ370ATMR-SI (Box packing)	9MTGU5ATMR-SI (Box packing) 9MTGU3ATMR-SI (Box packing)

Thin Mini-ITX Series

New



Model Name	iTXL-6412A/ iTXL-6210A	iTXL-5105A/ iTXL-4500A	iTXL-3350A
CPU	Intel® Celeron® J6412 Processor, 10nm, 4 cores, 4 threads, up to 2.6 GHz Intel® Celeron® N6210 Processor, 10nm, 2 cores, 2 threads, up to 2.6 GHz	Intel® Celeron® N5105 Processor, 10nm, 4 cores, 4 threads, up to 2.9 GHz Intel® Celeron® N4500 Processor, 10nm, 2 cores, 2 threads, up to 2.8 GHz	Intel® Celeron® N3350 Processor, 14nm, 2 cores, 2 threads, up to 2.4 GHz
Socket	FCBGA1493	FCBGA1338	FCBGA1296
Chipset	—	—	—
Memory	2 x DDR4 SO-DIMM sockets, Max. Capacity 32 GB, Support Dual Channel DDR4 3200 MHz	2 x DDR4 SO-DIMM sockets, Max. Capacity 16 GB, Support Dual Channel DDR4 2933 MHz	2 x DDR3L SO-DIMM sockets, Max. Capacity 8 GB, Support Dual Channel DDR3L 1866 MHz
Ethernet	2 x GbE LAN Ports (Realtek® RTL8118-CG)	2 x GbE LAN Ports (Realtek® RTL8118-CG)	2 x GbE LAN Ports (Realtek® RTL8111HS)
Graphic	Integrated Graphics Processor - Intel® UHD Graphics for 10th Gen Intel® Processors: 2 x HDMI 2.0, 1 x LVDS or eDP 3 independent display outputs	Integrated Graphics Processor - Intel® UHD Graphics: 2 x HDMI 2.0 1 x LVDS or eDP 3 independent display outputs	Integrated Graphics Processor - Intel® HD Graphics 500: 1 x HDMI 1.4 1 x Display Port 1 x LVDS or eDP 3 independent display outputs
Audio	Realtek® Audio Codec	Realtek® Audio Codec	Realtek® Audio Codec
Storage	1 x SATA 6Gb/s Port	1 x SATA 6Gb/s Port	2 x SATA 6Gb/s Ports (1 x switches with mSATA) (incl. 1 x SATA supports SATA DOM)
Expansion Slots	1 x PCIe x1 (Gen3 x1) 1 x 2280 M.2 M-Key (SATA 6Gb/s) 1 x 2230 M.2 E-Key (PCIe x1, USB 2.0)	1 x PCIe x1 (Gen3 x1) 1 x 2280 M.2 M-Key (SATA 6Gb/s) 1 x 2230 M.2 E-Key	1 x Full-size Mini PCIe/mSATA 1 x Half-size Mini PCIe (PCIe Only)
Internal I/O	1 x 4-pin ATX main power connector 1 x SATA Power connector 1 x System fan header 1 x Front panel header 1 x Front panel audio header 1 x 2W Speaker out header 5 x USB 2.0 headers 1 x Buzzer 1 x COM header (RS-232/422/485 & RI/5V/12V) 1 x COM header (RS-232 & RI/5V/12V) 2 x COM headers (RS-232) 1 x GPIO (8 bits) & SMBus header 1 x Backlight Control header 1 x AT/ATX mode select jumper 1 x ATX control header	1 x 4-pin ATX main power connector 1 x ATX control header (For Standard ATX PSU use) 1 x SATA Power connector 1 x System fan header 1 x Front panel header 1 x Front panel audio header 1 x 2W Speaker out header 6 x USB 2.0 headers 1 x COM header (RS-232/422/485 & RI/5V/12V) 3 x COM headers (RS-232) 1 x GPIO (8 bits) & SMBus header 1 x Backlight Control header 1 x AT/ATX mode select jumper	1 x 4-pin ATX main power connector 2 x SATA Power connectors 1 x CPU fan header 1 x System fan header 1 x Front panel header 1 x Front panel audio header 1 x 2W Speaker out header 1 x USB 2.0 header 2 x USB 3.2 Gen 1 headers 4 x COM headers (RS-232) 2 x COM headers (RS-232/422/485 & RI/5V/12V) 1 x Backlight Control header 1 x PS/2 KB/MS Connector 1 x GPIO (8 bits) & SMBUS header 1 x Buzzer 1 x Clear CMOS jumper 1 x AT/ATX mode select jumper 1 x Case open header
Rear I/O	2 x Audio Jacks (Line out, Mic in) 2 x HDMI 2 x RJ45 LAN Ports 3 x USB 3.2 Gen 1 1 x USB 2.0 1 x DC Jack (+12V/19V/24VDC)	2 x Audio Jacks (Line out, Mic in) 2 x HDMI 2 x RJ45 LAN Ports 4 x USB 3.2 Gen 1 1 x DC Jack (+12V~24VDC)	2 x Audio Jacks (Line out, Mic in) 1 x HDMI 1 x Display Port 2 x RJ45 LAN Ports 2 x USB 2.0, 2 x USB 3.2 Gen 1 1 x DC Jack (+12VDC)
TPM	1 x TPM header	1 x TPM header	1 x TPM header
Operating Temp.	0°C to 60°C	0°C to 60°C	0°C to 60°C
Ordering Information	9MEHLJATMR-SI (Box packing) 9MEHLNATMR-SI (Box packing)	9MJPLNATMR-SI (Box packing) 9MJPLNBTMR-SI (Box packing)	9MZAPLBIMR-SI (Box packing)

QBiP Series (3.5" SBC)

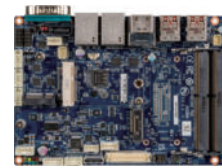
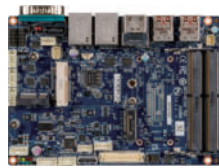

QBiP Series (3.5" SBC)

Model Name	QBiP-1185G7E/ QBiP-1145G7E	QBiP-1165G7A/ QBiP-1135G7A/ QBiP-1115G4EA	QBiP-1165G7B/ QBiP-1135G7B/ QBiP-1115G4EB
CPU	Intel® Core™ i7-1185G7E Processor 10nm SuperFin, 4 cores, 8 threads, up to 4.4 GHz, vPro support Intel® Core™ i5-1145G7E Processor 10nm SuperFin, 4 cores, 8 threads, up to 4.1 GHz, vPro support	Intel® Core™ i7-1165G7 Processor, 10nm SuperFin, 4 cores, 8 threads, up to 4.7 GHz Intel® Core™ i5-1135G7 Processor, 10nm SuperFin, 4 cores, 8 threads, up to 4.2 GHz Intel® Core™ i3-1115G4E Processor, 10nm SuperFin, 2 cores, 4 threads, up to 3.9 GHz	Intel® Core™ i7-1165G7 Processor, 10nm SuperFin, 4 cores, 8 threads, up to 4.7 GHz Intel® Core™ i5-1135G7 Processor, 10nm SuperFin, 4 cores, 8 threads, up to 4.2 GHz Intel® Core™ i3-1115G4E Processor, 10nm SuperFin, 2 cores, 4 threads, up to 3.9 GHz
Socket	FCBGA1449	FCBGA1449	FCBGA1449
Chipset	SoC	SoC	SoC
Memory	2 x DDR4 SO-DIMM sockets, Max. Capacity 64 GB, Support Dual Channel DDR4 3200 MHz	2 x DDR4 SO-DIMM sockets, Max. Capacity 64 GB, Support Dual Channel DDR4 3200 MHz	2 x DDR4 SO-DIMM sockets, Max. Capacity 64 GB, Support Dual Channel DDR4 3200 MHz
Ethernet	2 x GbE LAN Ports (Intel® I219LM and Intel® I211AT)	2 x GbE LAN Ports (Intel® I219V and Intel® I211AT)	2 x GbE LAN Ports (Intel® I219V and Intel® I211AT)
Graphic	Integrated Graphics Processor - Intel® Iris® X ^e Graphics 2 x HDMI 2.0 1 x LVDS 3 independent display outputs	Integrated Graphics Processor - Intel® Iris® X ^e /UHD Graphics 2 x HDMI 2.0, 2 x DP 1.4 (8K), 1 x DP 1.4 (USB Type C (8K)), 1 x eDP 4 independent display outputs	Integrated Graphics Processor - Intel® Iris® X ^e /UHD Graphics 2 x HDMI 2.0 1 x LVDS 3 independent display outputs
Audio	Realtek® Audio Codec	Realtek® Audio Codec	Realtek® Audio Codec
Storage	1 x SATA 6Gb/s Port (RAID 0/1)	1 x SATA 6Gb/s Port (RAID 0/1)	1 x SATA 6Gb/s Port (RAID 0/1)
Expansion Slots	1 x 2280 M.2 M-Key (PCIe x2, SATA 6Gb/s) 1 x 2230 M.2 E-Key 1 x Full-size Mini PCIe with SIM slot 1 x PCIe x1 (Board to Wire connector)	1 x 2280 M.2 M-Key (PCIe x2, SATA 6Gb/s) 1 x 2230 M.2 E-Key 1 x 3052 M.2 B-Key with SIM Slot (Support 5G) 1 x PCIe x4 (Board to Wire connector)	1 x 2280 M.2 M-Key (PCIe x2, SATA 6Gb/s) 1 x 2230 M.2 E-Key 1 x Full-size Mini PCIe with SIM slot 1 x PCIe x1 (Board to Wire connector)
Internal I/O	1 x 4-pin box power connector (+9V~48VDC) 1 x SATA Power header 1 x CPU fan header 1 x System fan header 1 x Front panel header 1 x Front panel audio header 1 x 2W Speaker out header 4 x USB 2.0 headers 3 x COM headers (RS-232/422/485) 1 x Backlight Control header 1 x AT/ATX mode select jumper 1 x GPIO (8-bits) & SMBUS header 1 x SPI header	1 x 4-pin box power connector (+12V~24VDC) 1 x SATA Power header 1 x CPU fan header 1 x Front panel header 1 x Front panel audio header 1 x 2W Speaker out header 4 x USB 2.0 headers 1 x COM header (RS-232 & RI/5V/12V) 1 x eDP power header	1 x 4-pin box power connector (+9V~48VDC) 1 x SATA Power header 1 x CPU fan header 1 x System fan header 1 x Front panel header 1 x Front panel audio header 1 x 2W Speaker out header 4 x USB 2.0 headers 3 x COM headers (RS-232/422/485) 1 x Backlight Control header 1 x AT/ATX mode select jumper 1 x GPIO (8-bits) & SMBUS header 1 x SPI header
Rear I/O	1 x COM Port (RS-232/422/485 & RI/5V/12V) 2 x HDMI 2 x RJ45 LAN Ports 4 x USB 3.2 Gen 2x1	1 x USB type C (USB 3.2 Gen 2x1 + DP output-share with DP) & PD Out -100W 1 x USB type C (USB 3.2 Gen 2x1, PD input-100W), 4 x USB 3.2 Gen 2x1 2 x HDMI, 2 x DP, 2 x RJ45 LAN Ports	1 x COM Port (RS-232/422/485 & RI/5V/12V) 2 x HDMI 2 x RJ45 LAN Ports 4 x USB 3.2 Gen 2x1
TPM	1 x TPM header	1 x TPM header	1 x TPM header
Operating Temp.	0°C to 60°C	0°C to 60°C	0°C to 60°C
Ordering Information	9MTGU7DSMR-SI (Box Packing) 9MTGU5DSMR-SI (Box Packing)	9MTGU7ASMR-SI (Box Packing) 9MTGU5ASMR-SI (Box Packing) 9MTGU3ASMR-SI (Box Packing)	9MTGU7BSMR-SI (Box Packing) 9MTGU5BSMR-SI (Box Packing) 9MTGU3BSMR-SI (Box Packing)

QBiP Series (3.5" SBC)



Model Name	QBiP-8665A/ QBiP-8365A	QBiP-8565A/ QBiP-8265A/ QBiP-8145A
CPU	Intel® Core™ i7-8665UE Processor, 14nm, 4 cores, 8 threads, up to 4.4 GHz, vPro support (QBiP-8665A) Intel® Core™ i5-8365UE Processor, 14nm, 4 cores, 8 threads, up to 4.1 GHz, vPro support (QBiP-8365A)	Intel® Core™ i7-8565U Processor, 14nm, 4 cores, 8 threads, up to 4.6 GHz (QBiP-8565A) Intel® Core™ i5-8265U Processor, 14nm, 4 cores, 8 threads, up to 3.9 GHz (QBiP-8265A) Intel® Core™ i3-8145UE Processor, 14nm, 2 cores, 4 threads, up to 3.9 GHz (QBiP-8145A)
Socket	FCBGA1528	FCBGA1528
Chipset	SoC	SoC
Memory	2 x DDR4 SO-DIMM sockets, Max. Capacity 64 GB, Support Dual Channel DDR4 2400 MHz	2 x DDR4 SO-DIMM sockets, Max. Capacity 64 GB, Support Dual Channel DDR4 2400 MHz
Ethernet	2 x GbE LAN Ports (Intel® I219LM and Intel® I211AT)	2 x GbE LAN Ports (Intel® I219V and Intel® I211AT)
Graphic	Integrated Graphics Processor - Intel® UHD Graphics 620: 2 x HDMI 1.4 1 x LVDS 3 independent display outputs	Integrated Graphics Processor - Intel® UHD Graphics 620: 2 x HDMI 1.4 1 x LVDS 3 independent display outputs
Audio	Realtek® Audio Codec	Realtek® Audio Codec
Storage	2 x SATA 6Gb/s Ports (RAID 0/1/5)	2 x SATA 6Gb/s Ports (RAID 0/1/5)
Expansion Slots	1 x 2280 M.2 M-Key (PCIe x4, SATA 6Gb/s) 1 x 2230 M.2 E-Key 1 x Full-size Mini PCIe with SIM slot	1 x 2280 M.2 M-Key (PCIe x4, SATA 6Gb/s) 1 x 2230 M.2 E-Key 1 x Full-size Mini PCIe with SIM slot
Internal I/O	1 x 4-pin box power connector (+9V~36VDC) (48VDC Optional) 2 x SATA power headers 1 x CPU fan header 1 x System fan header 1 x Front panel header 1 x Front panel audio header 1 x 2W Speaker out header 2 x USB 2.0 headers 3 x COM headers (RS-232) 1 x Backlight Control header 1 x AT/ATX mode select jumper 1 x GPIO (8 bits) & SMBUS header	1 x 4-pin box power connector (+9V~36VDC) (48VDC Optional) 2 x SATA power headers 1 x CPU fan header 1 x System fan header 1 x Front panel header 1 x Front panel audio header 1 x 2W Speaker out header 2 x USB 2.0 headers 3 x COM headers (RS-232) 1 x Backlight Control header 1 x AT/ATX mode select jumper 1 x GPIO (8 bits) & SMBUS header
Rear I/O	1 x COM Port (RS-232/422/485 & RI/5V/12V) 2 x HDMI 2 x RJ45 LAN Ports 4 x USB 3.2 Gen 2x1	1 x COM Port (RS-232/422/485 & RI/5V/12V) 2 x HDMI 2 x RJ45 LAN Ports 4 x USB 3.2 Gen 2x1
TPM	1 x TPM header	1 x TPM header
Operating Temp.	0°C to 60°C	0°C to 60°C
Ordering Information	9MWHLUASMR-SI (Box packing) (QBiP-8665A) 9MWHLUESMR-SI (Box packing) (QBiP-8365A)	9MWHLUASMR-SI (Box packing) (QBiP-8565A) 9MWHLUBSMR-SI (Box packing) (QBiP-8265A) 9MWHLUCSMR-SI (Box packing) (QBiP-8145A)

QBiP Series (3.5" SBC)

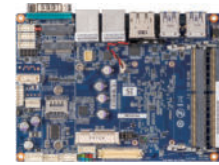
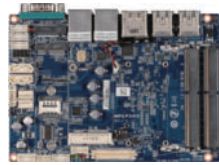

QBiP Series (3.5" SBC)

Model Name	QBiP-7600A/ QBiP-7200A/ QBiP-7100A	QBiP-3965A
CPU	Intel® Core™ i7-7600U Processor, 14nm, 2 cores, 4 threads, up to 3.9 GHz, vPro support (QBiP-7600A) Intel® Core™ i5-7200U Processor, 14nm, 2 cores, 4 threads, up to 3.1 GHz (QBiP-7200A) Intel® Core™ i3-7100U Processor, 14nm, 2 cores, 4 threads, 2.4 GHz (QBiP-7100A)	Intel® Celeron® 3965U Processor, 14nm, 2 cores, 2 threads, 2.2 GHz
Socket	FCBGA1356	FCBGA1356
Chipset	SoC	SoC
Memory	2 x DDR4 SO-DIMM sockets, Max. Capacity 32 GB, Support Dual Channel DDR4 2133 MHz	2 x DDR4 SO-DIMM sockets, Max. Capacity 32 GB, Support Dual Channel DDR4 2133 MHz
Ethernet	2 x GbE LAN Ports (Intel® I219V and Intel® I211AT) (7600A: Intel® I219LM and Intel® I211AT)	2 x GbE LAN Ports (Intel® I219V and Intel® I211AT)
Graphic	Integrated Graphics Processor - Intel® HD Graphics 620: 1 x HDMI 2.0 1 x Display Port 1 x LVDS 3 independent display outputs	Integrated Graphics Processor - Intel® HD Graphics 610: 1 x HDMI 2.0 1 x Display Port 1 x LVDS 3 independent display outputs
Audio	Realtek® Audio Codec	Realtek® Audio Codec
Storage	2 x SATA 6Gb/s Ports (RAID 0/1/5)	1 x SATA 6Gb/s Port
Expansion Slots	1 x 2280 M.2 M-Key (PCIe x4, SATA 6Gb/s) 1 x 2230 M.2 E-Key 1 x Full-size Mini PCIe with SIM slot	1 x 2280 M.2 M-Key (SATA 6Gb/s) 1 x 2230 M.2 E-Key 1 x Full-size Mini PCIe with SIM slot
Internal I/O	1 x 4-pin box power connector (+9V~36VDC) 2 x SATA power headers 1 x CPU fan header 1 x System fan header 1 x Front panel header 1 x Front panel audio header 1 x 2W Speaker out header 2 x USB 2.0 headers 3 x COM headers (RS-232) 1 x Backlight Control header 1 x AT/ATX mode select jumper 1 x GPIO (8 bits) & SMBUS header	1 x 4-pin box power connector (+9V~36VDC) 1 x SATA Power header 1 x CPU fan header 1 x System fan header 1 x Front panel header 1 x Front panel audio header 1 x 2W Speaker out header 2 x USB 2.0 headers 3 x COM headers (RS-232) 1 x Backlight Control header 1 x AT/ATX mode select jumper 1 x GPIO (8-bits) & SMBUS header
Rear I/O	1 x COM Port (RS-232/422/485 & RI/5V/12V) 1 x HDMI 1 x Display Port 2 x RJ45 LAN Ports 4 x USB 3.2 Gen 1	1 x COM Port (RS-232/422/485 & RI/5V/12V) 1 x HDMI 1 x Display Port 2 x RJ45 LAN Ports 4 x USB 3.2 Gen 1
TPM	1 x TPM header	1 x TPM header
Operating Temp.	0°C to 60°C	0°C to 60°C
Ordering Information	9MFLP7B5MR-SI (Box packing) (QBiP-7600A) 9MFLP5ASMR-SI (Box packing) (QBiP-7200A) 9MFLP3ASMR-SI (Box packing) (QBiP-7100A)	9MFLPCASMR-SI (Box packing)

QBiP Series (3.5" SBC)

New

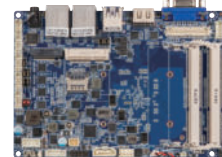
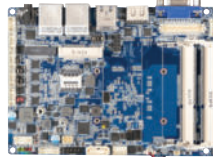
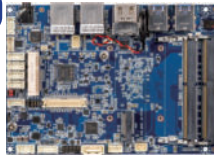

Model Name	QBiP-6412A/ QBiP-6210A	QBiP-4200B/ QBiP-4200C/ QBiP-3350A	QBiP-E3940A
CPU	Intel® Celeron® J6412 Processor, 10nm, 4 cores, 4 threads, up to 2.6 GHz Intel® Celeron® N6210 Processor, 10nm, 2 cores, 2 threads, up to 2.6 GHz	Intel® Pentium® N4200 Processor, 14nm, 4 cores, 4 threads, up to 2.5 GHz (QBiP-4200B/4200C) Intel® Celeron® N3350 Processor, 14nm, 2 cores, 2 threads, up to 2.4 GHz (QBiP-3350A)	Intel Atom® x5-E3940 Processor 14nm, 4 cores, 4 threads, up to 1.8 GHz 2M Cache
Socket	FCBGA1493	FCBGA1296	FCBGA1296
Chipset	SoC	SoC	SoC
Memory	2 x DDR4 SO-DIMM sockets, Max. Capacity 32 GB, Support Dual Channel DDR4 3200 MHz	2 x DDR3L SO-DIMM sockets, Max. Capacity 8 GB, Support Dual Channel DDR3L 1866 MHz	2 x DDR3L SO-DIMM sockets, Max. Capacity 8 GB Support Dual channel DDR3L 1866 MHz
Ethernet	2 x GbE LAN Ports (Intel® I211AT)	2 x GbE LAN Ports (Intel® I211AT)	2 x GbE LAN Ports (Intel® I211AT)
Graphic	Integrated Graphics Processor - Intel® UHD Graphics for 10th Gen Intel® Processors: 2 x HDMI 2.0 1 x LVDS 3 independent display outputs	Integrated Graphics Processor - Intel® HD Graphics 505: 1 x HDMI 1.4, 1 x VGA, 1 x LVDS 3 independent display outputs	Integrated Graphics Processor - Intel® HD Graphics 500: 1 x HDMI 1.4 1 x VGA 1 x LVDS 3 independent display outputs
Audio	Realtek® Audio Codec	Realtek® Audio Codec	Realtek® Audio Codec
Storage	1 x SATA 6Gb/s Port	1 x SATA 6Gb/s Port 1 x eMMC 32GB (4200B only)	1 x SATA 6Gb/s Port
Expansion Slots	1 x 2280 M.2 M-Key (PCIex2, SATA 6Gb/s) 1 x Full-size Mini PCIe with SIM slot	1 x 2242 M.2 M-Key (SATA 6Gb/s) 1 x Full-size Mini PCIe with SIM slot	1 x 2242 M.2 M-Key (SATA 6Gb/s) 1 x Full-size Mini PCIe with SIM slot (PCIe x1 + USB2.0) -- support 3G module
Internal I/O	1 x 4-pin box power connector (+9V~36VDC) 1 x SATA Power header 1 x CPU fan header 1 x Front panel header 1 x Front panel audio header 1 x 2W Speaker out header 2 x USB 2.0 headers 1 x COM header (RS-232/422/485 & RI/5V/12V) 1 x COM header (RS-232/422/485) 2 x COM headers (RS-232) 1 x Backlight Control header 1 x AT/ATX mode select jumper 1 x GPIO (8 bits) & SMBus header 1 x Buzzer header	1 x 4-pin box power connector (+9V~36VDC) 1 x SATA power header 1 x System fan header 1 x Front panel header 1 x 2W Speaker out header 4 x USB 2.0 headers 3 x COM headers (RS-232) 1 x COM header (RS-232/422/485 & RI/5V/12V) 1 x Backlight Control header 1 x AT/ATX mode select jumper 1 x GPIO (8 bits) & SMBUS header 1 x Buzzer header	1 x 4-pin box power connector (+9V~36VDC Full Range) 1 x SATA Power header 1 x System fan header 1 x Front panel header 1 x 2W Speaker out header 4 x USB 2.0 headers 3 x COM headers (RS-232) 1 x COM header (RS-232/422/485 & RI/5V/12V) 1 x Backlight Control header 1 x AT/ATX mode select jumper 1 x GPIO (8-bits) & SMBUS header 1 x Buzzer header
Rear I/O	1 x Headphone Jack 2 x HDMI 2 x RJ45 LAN Ports 4 x USB 3.2 Gen 1	1 x Headphone Jack 1 x HDMI 1 x VGA 2 x RJ45 LAN Ports 2 x USB 3.2 Gen 1	1 x Headphone jack 1 x HDMI 1 x VGA 2 x RJ45 LAN Ports 2 x USB 3.2 Gen 1
TPM	—	1 x TPM header	1 x TPM Header
Operating Temp.	0°C to 60°C	0°C to 60°C	0°C to 60°C
Ordering Information	9MEHLJASMR-SI (Box packing) (QBiP-6412A) 9MEHLNASMR-SI (Box packing) (QBiP-6210A)	9MZAPLCSMR-SI (Box packing) (QBiP-4200B) 9MZAPLDSMR-SI (Box packing) (QBiP-4200C) 9MZAPLESMSR-SI (Box packing) (QBiP-3350A)	9MAPLKASMR-SI (Box Packing)

QBiP Series (3.5" SBC)

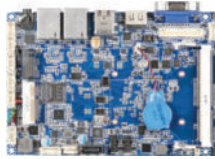

New

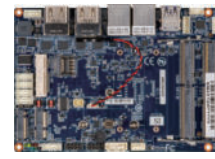

Model Name	QBiP-1900A	QBiP-2718A	QBiP-1605B
CPU	Intel® Celeron® J1900 Processor 22nm, 4 cores, 4 threads, up to 2.42 GHz	AMD Ryzen™ V2718 Embedded Processor, 7nm, 8 cores, 16 threads, 1.7 GHz, up to 4.15 GHz	AMD® RYZEN™ V1605B Embedded Processor, 14nm, 4 cores, 8 threads, 2.0 GHz, up to 3.6 GHz
Socket	FCBGA1170	FP6 BGA	FP5 type 1
Chipset	SoC	SoC	SoC
Memory	1 x DDR3L SO-DIMM sockets, Max. Capacity 8 GB Support Single channel DDR3L 1333 MHz	2 x DDR4 SO-DIMM sockets, Max. Capacity 32 GB, Support Dual Channel DDR4 3200 MHz	2 x DDR4 SO-DIMM sockets, Max. Capacity 32 GB, Support Dual Channel DDR4 2400/2133 MHz
Ethernet	2 x GbE LAN Ports (Intel® I211AT)	2 x GbE LAN Ports (Realtek® RTL8118-CG)	2 x GbE LAN Ports (Realtek® RTL8111HS)
Graphic	Integrated Graphics Processor - Intel® HD Graphics 500: 1 x HDMI 1.4 1 x VGA 1 x LVDS 2 independent display outputs	Integrated Graphics Processor - AMD Radeon™ Graphics: 4 x HDMI 2.1 4 independent display outputs	Integrated Graphics Processor - AMD® Radeon™ Vega 8 Graphics: 4 x HDMI 2.0 1 x eDP (share from HDMI) 4 independent display outputs
Audio	Realtek® Audio Codec	Realtek® Audio Codec	Realtek® Audio Codec
Storage	1 x SATA 3Gb/s Port	1 x SATA 6Gb/s Port	1 x SATA 6Gb/s Port
Expansion Slots	1 x 2280 M.2 M-Key (SATA 3Gb/s) 1 x Full-size Mini PCIe with SIM slot	1 x 2280 M.2 M-Key (PCIe x4, SATA 6Gb/s) 1 x 2230 M.2 E-Key 1 x Full-size Mini PCIe with SIM slot	1 x 2280 M.2 M-Key (PCIe x4, SATA 6Gb/s) 1 x 2230 M.2 E-Key 1 x Full-size Mini PCIe with SIM slot
Internal I/O	1 x 4-pin box power connector (DC in +9V~36VDC) (+48VDC Optional) 1 x SATA Power header 1 x System fan header 1 x Front panel header 1 x 2W Speaker out header 4 x USB 2.0 headers 2 x COM headers (RS-232) 1 x COM header (RS-232/422/485) 1 x COM header (RS-232/422/485 & RI/5V/12V) 1 x Backlight Control header 1 x AT/ATX mode select jumper 1 x GPIO (8-bits) & SMBUS header 1 x Buzzer header	1 x 4-pin box power connector (DC in +9V~48VDC) 1 x SATA Power header 1 x CPU fan header 1 x Front panel header 1 x Front panel audio header 1 x 2W Speaker out header 2 x USB 2.0 headers 3 x COM headers (RS-232/422/485) 1 x COM header (RS-232/422/485 & RI/5V/12V) 1 x AT/ATX mode select jumper 1 x GPIO (8-bits) & SMBUS header	1 x 4-pin box power connector (+9V~36VDC) 1 x SATA power header 1 x CPU fan header 1 x System fan header 1 x Front panel header 1 x Front panel audio header 1 x 2W Speaker out header 4 x USB 2.0 headers 2 x COM headers (RS-232) 2 x COM headers (RS-232/422/485 & RI/5V/12V) 1 x Backlight Control header 1 x AT/ATX mode select jumper 1 x eDP/HDMI jumper 1 x GPIO (8 bits) & SMBUS header 1 x Buzzer
Rear I/O	1 x Headphone jack 1 x HDMI 1 x VGA 2 x RJ45 LAN Ports 1 x USB 2.0 1 x USB 3.2 Gen 1	4 x HDMI 2 x RJ45 LAN Ports 2 x USB 3.2 Gen 2x1 2 x USB 2.0	4 x HDMI 2 x RJ45 LAN Ports 2 x USB 3.2 Gen 1
TPM	1 x TPM Header	—	Onboard TPM 2.0 security chip INFINEON SLB9665TT2.0
Operating Temp.	0°C to 60°C	0°C to 60°C	0°C to 60°C
Ordering Information	9MBAYTASMR-SI (Box Packing)	9MRZV2MSMR-SI (Box Packing)	9MRZNVOSMR-SI (Box packing)

QBiP Wide Temperature Series



Model Name	QBiP-7200AT/ QBiP-7100AT	QBiP-E3940AT	QBiP-1900AT
CPU	Intel® Core™ i5-7200U Processor, 14nm, 2 cores, 4 threads, up to 3.1GHz (QBiP-7200AT) Intel® Core™ i3-7100U Processor, 14nm, 2 cores, 4 threads, 2.4GHz (QBiP-7100AT)	Intel® Atom® x5-E3940 Processor, 14nm, 4 cores, 4 threads, up to 1.8 GHz	Intel® Celeron® J1900 Processor, 22nm, 4 cores, 4 threads, up to 2.42 GHz
Socket	FCBGA1356	FCBGA1296	FCBGA1170
Chipset	SoC	SoC	SoC
Memory	2 x DDR4 SO-DIMM sockets, Max. Capacity 32 GB, Support Dual Channel DDR4 2133 MHz	2 x DDR3L SO-DIMM sockets, Max. Capacity 8 GB, Support Dual Channel DDR3L 1866 MHz	1 x DDR3L SO-DIMM socket, Max. Capacity 8 GB, Support Single Channel DDR3L 1333 MHz
Ethernet	2 x GbE LAN Ports (Intel® I219V and Intel® I211AT)	2 x GbE LAN Ports (Intel® I211AT)	2 x GbE LAN Ports (Intel® I211AT)
Graphic	Integrated Graphics Processor - Intel® HD Graphics 620: 1 x HDMI 2.0, 1 x Display Port 1 x LVDS 3 independent display outputs	Integrated Graphics Processor - Intel® HD Graphics 500: 1 x HDMI 1.4, 1 x VGA, 1 x LVDS 3 independent display outputs	Integrated Graphics Processor - Intel® HD Graphics: 1 x HDMI 1.4, 1 x VGA, 1 x LVDS 2 independent display outputs
Audio	Realtek® Audio Codec	Realtek® Audio Codec	Realtek® Audio Codec
Storage	2 x SATA 6Gb/s Ports (RAID 0/1/5)	1 x SATA 6Gb/s Port	1 x SATA 3Gb/s Port
Expansion Slots	1 x 2280 M.2 M-Key (PCIe x4, SATA 6Gb/s) 1 x 2230 M.2 E-Key 1 x Full-size Mini PCIe with SIM slot	1 x 2242 M.2 M-Key (SATA 6Gb/s) 1 x Full-size Mini PCIe with SIM slot	1 x 2280 M.2 M-Key (SATA 3Gb/s) 1 x Full-size Mini PCIe with SIM slot
Internal I/O	1 x 4-pin box power connector (+9V~36VDC) 2 x SATA power headers 1 x CPU fan header 1 x System fan header 1 x Front panel header 1 x Front panel audio header 1 x 2W Speaker out header 2 x USB 2.0 headers 3 x COM headers (RS-232) 1 x Backlight Control header 1 x AT/ATX mode select jumper 1 x GPIO (8 bits) & SMBUS header	1 x 4-pin box power connector (+9V~36VDC) 1 x SATA power header 1 x System fan header 1 x Front panel header 1 x 2W Speaker out header 4 x USB 2.0 headers 3 x COM headers (RS-232) 1 x COM header (RS-232/422/485 & RI/5V/12V) 1 x Backlight Control header 1 x AT/ATX mode select jumper 1 x GPIO (8 bits) & SMBUS header 1 x Buzzer header	1 x 4-pin box power connector (+9V~36VDC) (+48VDC optional) 1 x SATA power header 1 x System fan header 1 x Front panel header 1 x 2W Speaker out header 4 x USB 2.0 headers 2 x COM headers (RS-232) 1 x COM header (RS-232/422/485) 1 x COM header (RS-232/422/485 & RI/5V/12V) 1 x Backlight Control header 1 x AT/ATX mode select jumper 1 x GPIO (8 bits) & SMBUS header 1 x Buzzer header
Rear I/O	1 x COM Port (RS-232/422/485 & RI/5V/12V) 1 x HDMI 1 x Display Port 2 x RJ45 LAN Ports 4 x USB 3.2 Gen 1	1 x Headphone Jack 1 x HDMI 1 x VGA 2 x RJ45 LAN Ports 2 x USB 3.2 Gen 1	1 x Headphone Jack 1 x HDMI 1 x VGA 2 x RJ45 LAN Ports 1 x USB 2.0 1 x USB 3.2 Gen 1
TPM	1 x TPM header	1 x TPM header	1 x TPM header
Operating Temp.	-20°C to 70°C	-40°C to 85°C	-40°C to 85°C
Ordering Information	9MFLP5ASMR-SI1 (Box packing) (QBiP-7200AT) 9MFLP3ASMR-SI1 (Box packing) (QBiP-7100AT)	9MAPLKASMR-SI1 (Box packing)	9MBAYTASMR-SI1 (Box packing)

QBi Series (10 x 10 Embedded Compact Board)

New



QBi Series (10 x 10 Embedded Compact Board)

Model Name	QBi-1165G7A/ QBi-1135G7A/ QBi-1115G4EA	QBi-8665A/ QBi-8365A
CPU	Intel® Core™ i7-1165G7 Processor, 10nm SuperFin, 4 cores, 8 threads, up to 4.7 GHz (QBi-1165G7A) Intel® Core™ i5-1135G7 Processor, 10nm SuperFin, 4 cores, 8 threads, up to 4.2 GHz (QBi-1135G7A) Intel® Core™ i3-1115G4E Processor, 10nm SuperFin, 2 cores, 4 threads, up to 3.90 GHz (QBi-1115G4EA)	Intel® Core™ i7-8665UE Processor, 14nm, 4 cores, 8 threads, up to 4.4 GHz, vPro support (QBi-8665A) Intel® Core™ i5-8365UE Processor, 14nm, 4 cores, 8 threads, up to 4.1 GHz, vPro support (QBi-8365A)
Socket	FCBGA1449	FCBGA1528
Chipset	SoC	SoC
Memory	2 x DDR4 SO-DIMM sockets, Max. Capacity 64 GB, Support Dual Channel DDR4 3200 MHz	2 x DDR4 SO-DIMM sockets, Max. Capacity 64 GB, Support Dual Channel DDR4 2400 MHz
Ethernet	2 x GbE LAN Ports (Intel® I219V and Realtek® RTL8111HS)	2 x GbE LAN Ports (Intel® I219LM and Realtek® RTL8111HS)
Graphic	Integrated Graphics Processor - Intel® Iris® Xe /UHD Graphics: 2 x HDMI 2.0, 2 independent display outputs	Integrated Graphics Processor - Intel® UHD Graphics 620: 2 x HDMI 1.4 1 x eDP 3 independent display outputs
Audio	Realtek® Audio Codec	Realtek® Audio Codec
Storage	—	1 x SATA 6Gb/s Port (RAID 0/1)
Expansion Slots	1 x 2280 M.2 M-Key (PCIe x4, SATA 6Gb/s) 1 x 2230 M.2 E-Key	1 x 2280 M.2 M-Key (PCIe x4, SATA 6Gb/s) 1 x 2230 M.2 E-Key
Internal I/O	1 x 2-pin power connector 1 x CPU fan header 1 x Front panel header 1 x Front panel audio header 1 x USB 2.0 header	1 x 2-pin power connector 1 x SATA/eDP Power header 1 x CPU fan header 1 x Front panel header 1 x Front panel audio header 1 x USB 2.0 header 1 x Vertical USB 3.2 Gen 1
Front IO	2 x USB 3.2 Gen 2x1 1 x Power button 1 x COM Port (RS-232/422/485)	2 x USB 3.2 Gen 2x1 1 x Power button 1 x COM Port (RS-232/422/485)
Rear IO	2 x HDMI 2 x RJ45 LAN Ports 2 x USB 3.2 Gen 2x1 1 x Screw type DC Jack (+9V~48VDC)	2 x HDMI 2 x RJ45 LAN Ports 2 x USB 3.2 Gen 2x1 1 x Screw type DC Jack (+9V~36VDC)
Side IO	—	—
TPM	1 x TPM header	—
Operating Temp.	0°C to 60°C	0°C to 60°C
Ordering Information	9MTGU7AHMR-SI (Box packing)(QBi-1165G7A) 9MTGU5AHMR-SI (Box packing)(QBi-1135G7A) 9MTGU3AHMR-SI (Box packing)(QBi-1115G4EA)	9MWHLUDHMR-SI (Box packing) (QBi-8665A) 9MWHLUEHMR-SI (Box packing) (QBi-8365A)

QBi Series (10 x 10 Embedded Compact Board)



Model Name	QBi-8565A/ QBi-8265A/ QBi-8145A	QBi-7100B
CPU	Intel® Core™ i7-8565U Processor, 14nm, 4 cores, 8 threads, up to 4.6 GHz (QBi-8565A) Intel® Core™ i5-8265U Processor, 14nm, 4 cores, 8 threads, up to 3.9 GHz (QBi-8265A) Intel® Core™ i3-8145UE Processor, 14nm, 2 cores, 4 threads, up to 3.9 GHz (QBi-8145A)	Intel® Core™ i3-7100U Processor, 14nm, 2 cores, 4 threads, 2.4 GHz
Socket	FCBGA1528	FCBGA1356
Chipset	SoC	SoC
Memory	2 x DDR4 SO-DIMM sockets, Max. Capacity 64 GB, Support Dual Channel DDR4 2400 MHz	2 x DDR4 SO-DIMM sockets, Max. Capacity 32 GB, Support Dual Channel DDR4 2133 MHz
Ethernet	2 x GbE LAN Ports (Intel® I219V and Realtek® RTL8111HS)	1 x GbE LAN Port (Intel® I219V)
Graphic	Integrated Graphics Processor - Intel® UHD Graphics 620: 2 x HDMI 1.4 1 x eDP 3 independent display outputs	Integrated Graphics Processor - Intel® HD Graphics 620: 1 x HDMI 2.0 1 x Mini Display Port 1 x eDP 3 independent display outputs
Audio	Realtek® Audio Codec	Intel® Integrated Audio
Storage	1 x SATA 6Gb/s Port (RAID 0/1)	1 x SATA 6Gb/s Port (RAID 0/1)
Expansion Slots	1 x 2280 M.2 M-Key (PCIe x4, SATA 6Gb/s) 1 x 2230 M.2 E-Key	1 x 2280 M.2 M-Key (PCIe x4, SATA 6Gb/s) 1 x 2230 M.2 E-Key
Internal I/O	1 x 2-pin power connector 1 x SATA/eDP power header 1 x CPU fan header 1 x Front panel header 1 x Front panel audio header 1 x USB 2.0 header 1 x Vertical USB 3.2 Gen 1	1 x 2-pin power connector 1 x SATA power header 1 x CPU fan header 1 x Front panel header 2 x USB 2.0 headers 1 x USB 3.2 Gen 1 header 1 x COM header (RS-232)
Front IO	2 x USB 3.2 Gen 2x1 1 x Power button 1 x COM Port (RS-232/422/485)	2 x USB 3.2 Gen 1 1 x Power button
Rear IO	2 x HDMI 2 x RJ45 LAN Ports 2 x USB 3.2 Gen 2x1 1 x Screw type DC Jack (+9V~36VDC)	1 x HDMI 1 x Mini Display Port 1 x RJ45 LAN Port 2 x USB 3.2 Gen 1 1 x DC Jack (+12V~24VDC)
Side IO	—	—
TPM	—	—
Operating Temp.	0°C to 60°C	0°C to 60°C
Ordering Information	9MWHLUAHMR-SI (Box packing) (QBi-8565A) 9MWHLUBHMR-SI (Box packing) (QBi-8265A) 9MWHLUCHMR-SI (Box packing) (QBi-8145A)	9MFLP3AHNR-SI (Bulk packing)

QBi Series (10 x 10 Embedded Compact Board)



New



QBi Series (10 x 10 Embedded Compact Board)

Model Name	QBi-3965B	QBi-6412A/ QBi-6210A
CPU	Intel® Celeron® 3965U Processor, 14nm, 2 cores, 2 threads, 2.2 GHz	Intel® Celeron® J6412 Processor, 10nm, 4 cores, 4 threads, up to 2.6 GHz (QBi-6412A) Intel® Celeron® N6210 Processor, 10nm, 2 cores, 2 threads, up to 2.6 GHz (QBi-6210A)
Socket	FCBGA1356	FCBGA1493
Chipset	SoC	SoC
Memory	2 x DDR4 SO-DIMM sockets, Max. Capacity 32 GB, Support Dual Channel DDR4 2133 MHz	1 x DDR4 SO-DIMM socket, Max. Capacity 32 GB, Support Single Channel DDR4 3200 MHz
Ethernet	1 x GbE LAN Port (Intel® I219V)	2 x GbE LAN Ports (Intel® I211AT)
Graphic	Integrated Graphics Processor - Intel® HD Graphics 620: 1 x HDMI 2.0 1 x Mini Display Port 1 x eDP 3 independent display outputs	Integrated Graphics Processor - Intel® UHD Graphics for 10th Gen Intel® Processors: 2 x HDMI 2.0 2 independent display outputs
Audio	Intel® Integrated Audio	Realtek® Audio Codec
Storage	1 x SATA 6Gb/s Port	1 x SATA 6Gb/s Port
Expansion Slots	1 x 2280 M.2 M-Key (SATA 6Gb/s) 1 x 2230 M.2 E-Key	1 x 2280 M.2 M-Key (PCIe x2, SATA 6Gb/s) 1 x 2230 M.2 E-Key
Internal I/O	1 x 2-pin power connector 1 x SATA power header 1 x CPU fan header 1 x Front panel header 2 x USB 2.0 headers 1 x USB 3.2 Gen 1 header 1 x COM header (RS-232)	1 x 2-pin power connector 1 x SATA power header 1 x CPU fan header 1 x Front panel header 2 x USB 2.0 headers
Front IO	2 x USB 3.2 Gen 1 1 x Power button	2 x USB 3.2 Gen 2x1 1 x COM Port (RS-232) 1 x Headphone Jack 1 x Power button
Rear IO	1 x HDMI 1 x Mini Display Port 1 x RJ45 LAN Port 2 x USB 3.2 Gen 1 1 x DC Jack (+12V~24VDC)	2 x RJ45 LAN Ports 2 x HDMI 2 x USB 3.2 Gen 2x1 1 x Screw type DC Jack (+12V~19VDC)
Side IO	—	—
TPM	—	—
Operating Temp.	0°C to 60°C	0°C to 60°C
Ordering Information	9MFLPCAHR-SI (Box packing)	9MEHLJAHMR-SI (Box packing) 9MEHLNAHMR-SI (Box packing)

QBi Series (10 x 10 Embedded Compact Board)



Model Name	QBi-4125A	QBi-4200B
CPU	Intel® Celeron® J4125 Processor, 14nm, 4 cores, 4 threads, up to 2.7 GHz	Intel® Pentium® N4200 Processor, 14nm, 4 cores, 4 threads, up to 2.5 GHz
Socket	FCBGA1090	FCBGA1296
Chipset	SoC	SoC
Memory	1 x DDR4 SO-DIMM socket, Max. Capacity 8 GB, Support Single Channel DDR4 2400 MHz	1 x DDR3L SO-DIMM socket, Max. Capacity 8 GB, Support Single Channel DDR3L 1866 MHz
Ethernet	2 x GbE LAN Ports (Intel® I211AT and Realtek® RTL8111HS)	1 x GbE LAN Port (Realtek® RTL8111HS)
Graphic	Integrated Graphics Processor - Intel® UHD Graphics 600: 2 x HDMI 1.4 1 x eDP 3 independent display outputs	Integrated Graphics Processor - Intel® HD Graphics 505: 1 x HDMI 1.4 1 x VGA 1 x eDP 3 independent display outputs
Audio	Realtek® Audio Codec	Realtek® Audio Codec
Storage	1 x SATA 6Gb/s Port	1 x SATA 6Gb/s Port
Expansion Slots	1 x 2280 M.2 M-Key (SATA 6Gb/s) 1 x 2230 M.2 E-Key	1 x 2230 M.2 E-Key
Internal I/O	1 x SATA power header 1 x CPU fan header 1 x power button header 2 x USB 2.0 headers 1 x Speaker out header	1 x 2-pin power connector 1 x SATA power header 1 x CPU fan header 1 x Front panel header 2 x USB 2.0 headers 1 x USB 3.2 Gen 1 header 1 x COM header (RS-232)
Front IO	2 x USB 3.2 Gen 1 1 x COM Port (RS-232) 1 x Headphone Jack 1 x Power button	2 x USB 3.2 Gen 1 1 x Power button 1 x Audio Combo Jack (Headphone & Microphone)
Rear IO	2 x RJ45 LAN Ports 2 x USB 3.2 Gen 1 2 x HDMI 1 x DC Jack (+12V~19VDC)	1 x HDMI 1 x VGA 1 x RJ45 LAN Port 2 x USB 3.2 Gen 1
Side IO	—	1 x DC Jack (+12V~24VDC)
TPM	—	—
Operating Temp.	0°C to 60°C	0°C to 60°C
Ordering Information	9MGMLKAHMR-SI (Box packing)	9MZAPLBHMR-SI (Box packing)

GIGAIPC

GIGABYTE™ GROUP

Building
a **SMARTER** Tomorrow



GIGAIPC

GIGAIPC CO., LTD.

GIGABYTE TECHNOLOGY GROUP

B1-A, No.205, Sec. 3, Beixin Rd., Xindian Dist.,
New Taipei City 23143, Taiwan (R.O.C)

TEL: +886-2-89131312 FAX: +886-2-89131332
Email: sales@gigaipc.com URL: www.gigaipc.com

技宸股份有限公司

技嘉集團

新北市 231 新店區北新路三段 205 號 B1-A

TEL: +886-2-89131312 FAX: +886-2-89131332
Email: sales@gigaipc.com URL: www.gigaipc.com



GMKT-C2022002