



Vol.22

---

# EMBEDDED COMPUTING

---



**iBASE**  
[www.ibase.com.tw](http://www.ibase.com.tw)

# Table of Contents

## Table of Contents

2 ~ 5

## IBASE Company Profile

6 ~ 7

## 1. CPU Modules

### COM Express

#### Comparison Table

1-1 ~ 1-3

ET981	13th Gen Intel® Core™ P-Series COM Express Type 6 (R3.0) CPU Module	1-4
<b>NEW</b> ET980	12th Gen Intel® Core™ P-series COM Express Type 6 (R3.0) CPU Module	1-5
ET977	AMD Ryzen™ Embedded V1000/ R1000 Series COM Express Type 6 (R3.0) CPU Module	1-6
ET976	AMD Ryzen™ Embedded V1000 Series COM Express Type 6 (R3.0) CPU Module	1-7
ET975	7th Gen Intel® Core™ U-Series COM Express Type 6 CPU Module	1-8
ET970	7th Gen Intel® Xeon® E3 / Core™ i7/i5/i3 COM Express Type 6 CPU Module	1-9
<b>NEW</b> ET880	Intel® Atom® x6000 Series COM Express Type 6 (R3.0) CPU Module	1-10
ET876	Intel® Atom® x7/x5 COM Express Type 10 (R3.0) CPU Module	1-11
ET875	Intel® Atom® x7/x5 / Pentium® / Celeron® COM Express Type 10 (R3.0) CPU Module	1-12
ET870	Intel® Atom® x7/x5 COM Express Type 6 (R3.0) CPU Module	1-13
ET860	Intel® Atom® Processor E3845/E3827 COM Express Type 6 CPU Module	1-14

### Qseven

IBQ800	Intel® Atom® x7/x5 Qseven® (R2.1) CPU Module	1-15
--------	--	------

### ETX

ET839	Intel® Atom® Processor E3845 ETX CPU Module	1-16
-------	---	------

### Carrier Board

#### Comparison Table

1-17~1-18

IP419	COM Express Type 6 (R3.0) Carrier Board (Mini-ITX)	1-19
IP418	COM Express Type 6 (R3.0) Carrier Board (ATX)	1-20
IP417	COM Express Type 10 (R3.0) Carrier Board (Mini-ITX)	1-21
IP416	Qseven Carrier Board (Micro ATX)	1-22
<b>NEW</b> IP414	COM Express Type 6 Carrier Board (ATX)	1-23
IP413	COM Express Type 6 Carrier Board (ATX)	1-24
IP412	ETX (3.0) Carrier Board (Micro ATX)	1-25
IP411	COM Express Type 6 Carrier Board (Mini-ITX)	1-26
IP409	COM Express Type 6 Carrier Board (Micro ATX)	1-27

## 2. Single Board Computers

### 3.5-inch Single Board Computer

#### Comparison Table

2-1~2-6

<b>NEW</b>	IB961 (i-Temp)	13th Gen Intel® Core™ i series / Intel® mobile Processor (RPL-P Platform) 3.5-inch Single Board Computer	2-7
	IB956	11th Gen Intel® Core™ i7/i5/i3 3.5-inch Single Board Computer	2-8
	IB953	11th Gen Intel® Core™ i7/i5/i3 / Celeron® 3.5-inch Single Board Computer	2-9
	IB952	AMD Ryzen™ Embedded V2000 Series 3.5-inch Single Board Computer	2-10
	IB919	8th Gen Intel® Core™ / Pentium® Gold / Celeron® 3.5-inch Single Board Computer	2-11
	IB918	AMD Ryzen™ Embedded V1000/R1000 Series 3.5-inch Single Board Computer	2-12
	IB917	7th Gen Intel® Core™ U-Series 3.5-inch Single Board Computer	2-13
	IB916	7th Gen Intel® Core™ U-Series 3.5-inch Single Board Computer	2-14
	IB915	6th Gen Intel® Core™ U-Series 3.5-inch Single Board Computer	2-15
	IB899	Intel® Pentium® / Celeron® 3.5-inch Single Board Computer	2-16
	IB898 (i-Temp)	Intel® Atom® Processor E3800 Series 3.5-inch Single Board Computer	2-17
	IB897 (i-Temp)	Intel® Atom® Processor E3800 Series 3.5-inch Single Board Computer	2-18
<b>NEW</b>	IB838	New Gen Intel® Core™ i3 Processor N-series / Intel® Processor N-series 3.5-inch Single Board Computer	2-19
<b>NEW</b>	IB837	Intel® Celeron® N & J Series 3.5-inch Single Board Computer	2-20
	IB836 (i-Temp)	Intel® Atom® x6000 series/ Pentium®/ Celeron® 3.5-inch Single Board Computer	2-21
	IB822	Intel® Pentium® Silver 3.5-inch Single Board Computer	2-22
	IB818 (i-Temp)	Intel® Atom® x7 / Pentium® / Celeron® 3.5-inch Single Board Computer	2-23
	IB811 (i-Temp)	Intel® Atom® x7/x5/ Pentium® / Celeron® 3.5-inch Single Board Computer	2-24

# Table of Contents

## 3. Motherboards

<b>Recommended 13th/12th Gen Intel® Processors List</b>	<b>3-1</b>
---	------------

<b>Recommended 12th/10th Gen Intel® Processors List</b>	<b>3-2</b>
---	------------

### ATX Motherboard

<b>Comparison Table</b>	<b>3-3</b>
-------------------------	------------

MBB-1000	12th Gen Intel® Core™ i9/i7/i5/i3 and Pentium/ Celeron ATX Motherboard with Intel® R680E/ Q670E PCH	<b>3-4</b>
----------	---	------------

MB997	9th Gen Intel® Xeon® E / Core™ i7/i5/i3 ATX Motherboard with Intel® C246/Q370/H310 PCH	<b>3-5</b>
-------	--	------------

MB995	8th Gen Intel® Xeon® E / Core™ i7/i5/i3 ATX Motherboard with Intel® C246/Q370 PCH	<b>3-6</b>
-------	---	------------

MB990	7th/6th Gen Intel® Core™ i7/i5/i3 / Pentium®/ Celeron® ATX Motherboard with Intel® Q170 PCH	<b>3-7</b>
-------	---	------------

### Micro ATX Motherboard

<b>NEW</b> MB998	13th/12th Gen Intel® Core™ i9/i7/i5/i3 / Pentium®/ Celeron® with Intel® R680E/Q670E/W680 PCH	<b>3-8</b>
------------------	--	------------

MB991	7th/6th Gen Intel® Xeon E3 / Core™ i7/i5/i3 / Pentium® / Celeron® Micro ATX Motherboard with Intel® C236/Q170 PCH	<b>3-9</b>
-------	---	------------

### Mini-ITX Motherboard

<b>Comparison Table</b>	<b>3-10~3-13</b>
-------------------------	------------------

MI999	10th Gen Intel® Xeon® W / Core™ / Pentium® / Celeron® Mini-ITX Motherboard with Intel® W480E/Q470E/H420E PCH	<b>3-14</b>
-------	--	-------------

MI998	9th/8th Gen Intel® Xeon® E / Core™ / Pentium® / Celeron® Mini-ITX Motherboard with Intel® C246/Q370/H310 PCH	<b>3-15</b>
-------	--	-------------

<b>NEW</b> MI997	12th Gen Intel® Core™ / Celeron® Mini-ITX Motherboard	<b>3-16</b>
------------------	---	-------------

MI996	9th Gen Intel® Xeon® E / Core™ i7/i5/i3 / Celeron® Mini-ITX Motherboard with Intel® CM246/QM370/HM370 PCH	<b>3-17</b>
-------	---	-------------

MI995	8th Gen Intel® Xeon® E / Core™ i7/i5/i3 Mini-ITX Motherboard with Intel® Intel® CM246/QM370/HM370 PCH	<b>3-18</b>
-------	---	-------------

<b>NEW</b> MI993	AMD Ryzen Embedded R2000 Series	<b>3-19</b>
------------------	---------------------------------	-------------



MI992	7th/6th Gen Intel® Xeon® E3 / Core™ i7/i5/i3 Mini-ITX Motherboard with Intel® CM238/HM175 PCH	3-20
MI991	7th/6th Gen Intel® Xeon® E3 / Core™ i7/i5/i3 / Pentium® / Celeron® Mini-ITX Motherboard with Intel® C236/Q170/H110 PCH	3-21
MI990	6th Gen Intel® Xeon® E3 / Core™ i7/i5/i3 / Celeron® Mini-ITX Motherboard with Intel® CM236/HM170 PCH	3-22
MI989	AMD Ryzen™ Embedded V2000 Series Mini-ITX Motherboard	3-23
MI988	AMD Ryzen™ Embedded V1000 Mini-ITX Motherboard	3-24
 MI836 (i-Temp)	Intel® Atom® x6000 series Mini-ITX Motherboard	3-25
MI811	Intel® Pentium® / Celeron® Mini-ITX Motherboard	3-26
MI808	Intel® Pentium® / Celeron® Mini-ITX Motherboard	3-27
MI805	Intel® Celeron® Processors J1900 Mini-ITX Motherboard	3-28
MBD301	AMD Ryzen™ 3000 Series Mini-ITX Motherboard with AMD X470 PCH	3-29

## 4. CPU Cards

### Full-Size CPU Card

#### Comparison Table 4-1

IB995	9th/8th Gen Intel® Xeon® E / Core™ i7/i5/i3 / Pentium® / Celeron® PICMG 1.3 Full-Size CPU Card with Intel® C246/Q370/H310 PCH	4-2
IB990	7th/6th Gen Intel® Xeon® E3 / Core™ i7/i5/i3 / Pentium® / Celeron® PICMG 1.3 Full-Size CPU Card with Intel® C236/Q170 PCH	4-3

#### Backplane 4-4

#### Mini PCI-E Cards for Expansion 4-5

#### Embedded Function Cards 4-6~4-7

#### Product Index 4-8

# About IBASE

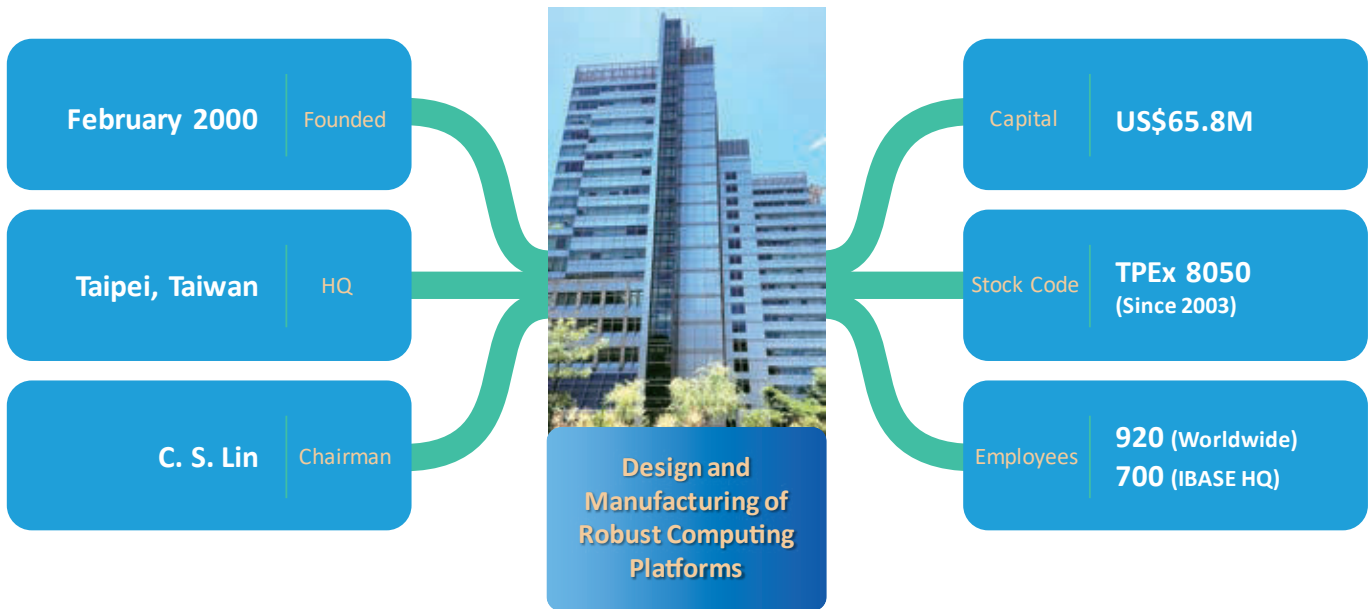

## Company Profile

IBASE Technology specializes in the design and manufacture of robust industrial PC, products since its establishment in 2000. IBASE carries out manufacturing and quality control at its own facilities in Taiwan that are certified with ISO 9001, ISO 13485, ISO 14001 and ISO 27001 standards. Current offerings comprise x86 and RISC-based industrial motherboards, embedded systems, panel PCs, network appliances and digital signage players. The company is publicly listed in the Taipei Exchange (TPEX: 8050) and is now a leading global provider of innovative industrial and embedded computing solutions.



## Core Competence

IBASE has three manufacturing sites in Taiwan, with two in New Taipei City and another one in Taoyuan City. We manufacture and implement strict quality control to supply excellent industrial computer products that are 100% made in Taiwan. In addition to off-the-shelf products, IBASE also specializes in OEM/ODM/JDM services, tailoring products to fully meet customers' expectations and the needs of various applications. With manufacturing and quality control capabilities recognized by major international companies, IBASE boasts of strong innovative R&D teams and flexible and timely products delivery.

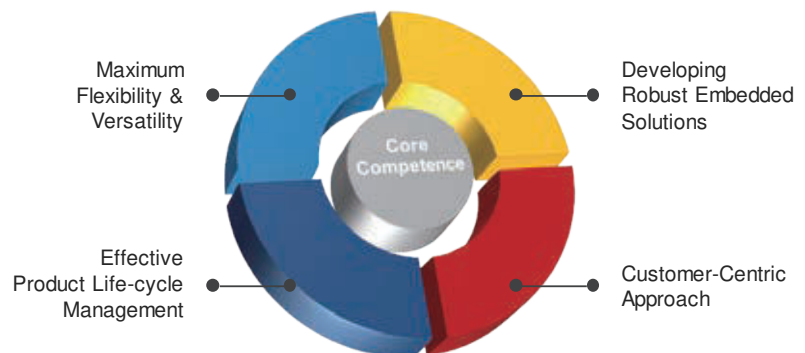

# Design & Manufacturing Services

Set up to become a global leading provider of embedded board and system solutions, IBASE manufacturers and supplies cutting-edge products based on the latest technologies to match market demands. Our R&D and product management teams have the expertise to design and develop products that are innovative and meet customers' requirements and design specifications. We attach great importance to research and development, investing heavily in manpower and resources to continuously provide high-quality innovative products. IBASE is also committed to compliance with environmental policies by working to prevent pollution with non-use of banned or restricted substances in our production process and products, helping our customers respond to their environmental challenges.

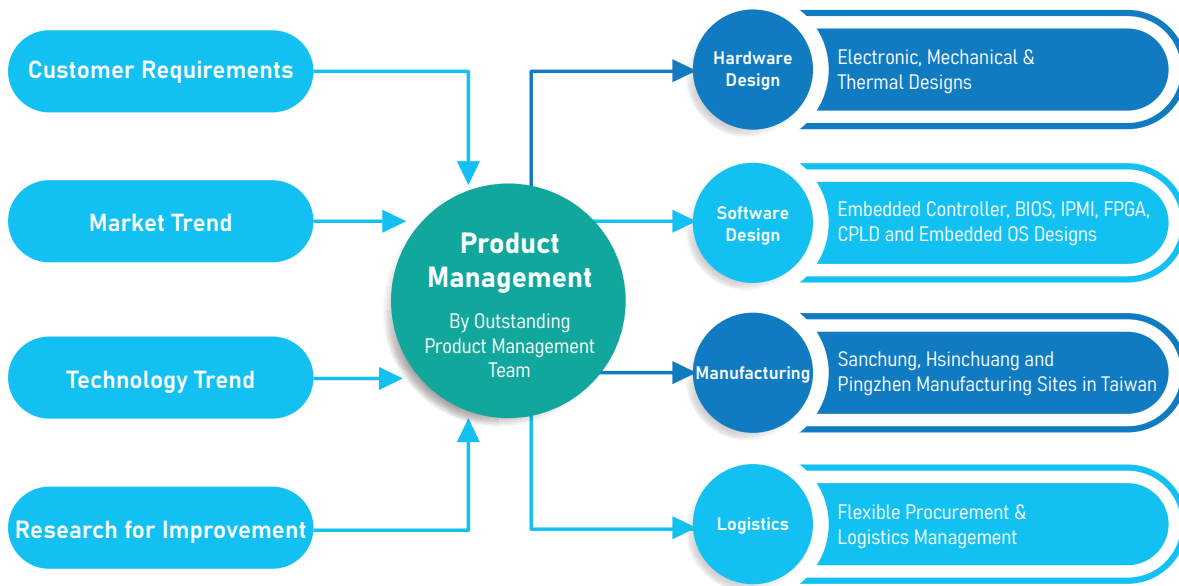

## IBASE Manufacturing Sites

Design & Manufacturing in Taiwan

**SANCHUNG**

- Board Production
- Validation

3,124 m<sup>2</sup> / 945 Ping

**HSINCHUANG**

- System Assembly
- Validation

6,070 m<sup>2</sup> / 1,840 Ping

**NEW PINGZHEN**

- Board Production
- System Assembly
- Validation

18,481 m<sup>2</sup> / 5,591 Ping

### Total Size

**297,891 Square-feet**  
(27,675 m<sup>2</sup> / 8,376 Ping)

### Capacity

- SMT Line x 5
- DIP Assembly Line x 4
- System Assembly Line x 10
- Cleanroom x 2
- Burn-in Room x 13

**PCBA**  
80K/month (In-house Production)  
+ Outsourcing

**System Assembly**  
50K/month (In-house Production)  
+ Outsourcing

### Certifications



# Comparison Table

## CPU Module

Models	ET839	ET860	ET870	ET875
<b>Form Factor</b>	ETX (3.0)	COM Express Type-6	COM Express Type-6 (R3.0)	COM Express Type-10 (R3.0)
<b>CPU Socket</b>	BGA1170 SoC on board	BGA1170 SoC on board	FCBGA1296 SoC on board	FCBGA1296 SoC on board
<b>CPU</b>	Intel® Atom® Processor E3845	Intel® Atom® Processor E3845/ E3827	Intel® Atom® Processor E3950/ E3940/ E3930	Intel® Atom® Processor E3950/E3940/ E3930 Intel® Pentium® QC N4200 Intel® Celeron® DC N3350
<b>CPU Max. Frequency</b>	1.91GHz	Up to 1.91GHz	Up to 2.5GHz	Up to 2.5GHz
<b>PCH</b>	N/A	N/A	N/A	N/A
<b>Memory</b>	1x DDR3L SO-DIMM	2x DDR3L SO-DIMM	2x DDR3L SO-DIMM	LPDDR4 Onboard Memory
<b>Max. Memory Size</b>	8GB	8GB	16GB	8GB
<b>BIOS</b>	AMI	AMI	AMI	AMI
<b>Graphics Controller</b>	Intel® Gen7 graphics	Intel® Core™ i integrated Gen7 graphics	Intel® Gen9-LP w/ 18 EUs graphics	Intel® Gen9-LP w/ 18 EUs graphics
<b>Video Output</b>	18/24-bit single-channel LVDS (on carrier board)	18/24-bit single-channel LVDS (on carrier board)	24-bit dual-channel LVDS (on carrier board)	24-bit dual-channel LVDS (on carrier board)
<b>Ethernet</b>	Intel® I210IT Gigabit LAN	Intel® I210IT Gigabit LAN	Intel® I210IT Gigabit LAN	Intel® I210IT Gigabit LAN
<b>Audio</b>	Realtek ALC662 or ALC888S HD audio codec (on carrier board)	Realtek ALC662 or ALC888S (on carrier board)	Realtek ALC662 or ALC888S (on carrier board)	Realtek ALC662 or ALC888S HD audio codec (on carrier board)
<b>SATA</b>	1x SATA II port	2x SATA III ports (on carrier board)	2x SATA III ports	2x SATA III ports
<b>I/O Chipset</b>	NCT6102D (on board)	NCT5523D (on board)	F81804U-I (on board)	F81804U-I (on board)
<b>Parallel Port</b>	1 SPP/EPP/ECP port (on carrier board)	1 SPP/EPP/ECP port (on carrier board)	1 SPP/EPP/ECP port (on carrier board)	1 SPP/EPP/ECP port (on carrier board)
<b>Serial Port</b>	2x RS232 COM ports, TTL Level (on carrier board)	2x RS232 COM ports (on carrier board)	2x COM ports (TX/RX) (on carrier board)	2x COM ports (TX/RX) (on carrier board)
<b>USB 2.0</b>	4x USB 2.0 (via carrier board)	8x USB 2.0 (via carrier board)	4x USB 2.0 (via carrier board)	4x USB 2.0 (via carrier board)
<b>USB 3.X</b>	N/A	1x USB 3.0 (via carrier board)	3x USB 3.0 (via carrier board)	2x USB 3.0 (via carrier board)
<b>TPM</b>	N/A	N/A	2.0	2.0
<b>KB / MS</b>	On carrier board	On carrier board	N/A	N/A
<b>Hardware Monitor</b>	Yes	Yes	Yes	Yes
<b>Storage Device Interface</b>	N/A	MicroSD	N/A	eMMC5.0 (optional)
<b>Watchdog Timer</b>	256 levels	256 levels	256 levels	256 levels
<b>Expansion slots</b>	On carrier board	1x PCI-E (x1) on carrier board (IP411)	4x PCI-E(x1)	4x PCI-E(x1)
<b>Digital I/O</b>	4-in / 4-out on carrier board (IP412)	4-in / 4-out on carrier board (IP411)	4-in / 4out on carrier board (IP419)	4-in / 4out on carrier board (IP417)
<b>Power Input</b>	On carrier board	On carrier board	On carrier board	On carrier board
<b>Power Consumption</b>	Intel® Atom® E3845 1.91GHz w/ 2x 4GB DDR3L-1600 +5V: 1.92A	Intel® Atom® E3845 1.91GHz w/ 2GB DDR3L-1600 +12V: 0.91A; +5V: 0.13A +5VSB: 0.05A; +3.3V: 0.24A	Intel® Atom® E3950 1.6GHz w/ 2x 8GB DDR3L-1600 +12V: 2.18A	Intel® Atom® Processor E3950 1.60GHz w/ Onboard LPDDR4 2400MHz 8GB +12V: 1.587A
<b>Dimensions (L x W)</b>	95mm x 114mm	95mm x 95mm	95mm x 95mm	84mm x 55mm
<b>Extra Features</b>	Four 100-pin ETX interface connectors to carrier board (for PCI, USB, Audio, ISA, LVDS, VGA, COM ports, LPT, PS/2 KB/MS, LAN, IDE, LPC), Boot on LAN	Two 220-pin COM Express Type-6 interface connectors to carrier board (for USB, expansion slots, SATA, LVDS, VGA, DVI, DisplayPort, LAN, audio, LPC, GPIO), Boot on LAN	Two 220-pin COM Express Type-6 interface connectors to carrier board (for USB, expansion slots, SATA, LVDS, VGA, DVI, DisplayPort, LAN, audio, LPC, GPIO), Boot on LAN	One 220-pin COM Express Type-10 interface connector to carrier board (for USB, expansion slots, SATA, LVDS, DisplayPort, LAN, audio, LPC, GPIO) Boot on LAN
<b>Page No.</b>	P.1-16	P.1-14	P.1-13	P.1-12

1

CPU Modules

2

Single Board Computers

3

Motherboards

4

CPU Cards

# Comparison Table

## CPU Module

ET876	ET880	ET970	ET975	ET976
COM Express Type-10 (R3.0)	COM Express Type-6 (R3.0)	COM Express Type-6	COM Express Type-6	COM Express Type-6
FCBGA1296 SoC on board	FCBGA1296 SoC on board	BGA1440 CPU on board	FCBGA1356 CPU on board	BGA1140 on board
Intel® Atom® Processor E3950/ E3940/E3930	Intel® Atom® QC x6425E Intel® Atom® DC x6211E	7th Gen Intel® Xeon®/ Core™ i7/i5/i3	7th Gen Intel® Core™ i7/i5/i3	AMD Ryzen™ V1000 series embedded APU
Up to 2.5GHz	Up to 3.0GHz	Up to 3.7GHz	Up to 3.9GHz	Up to 3.8GHz
N/A	N/A	Intel® CM238/QM175/QM170 PCH	N/A	N/A
Onboard DDR3L memory	Onboard DDR4 8GB 1x DDR4 SO-DIMM	2x DDR4 SO-DIMM	2x DDR4 SO-DIMM	DDR4 Memory on board
4GB	24GB	32GB	32GB	8GB
AMI	AMI	AMI	AMI	AMI
Intel® SoC integrated Gen9-LP graphics	Intel® SoC integrated Gen11 graph- ics	Intel® Core™ i integrated graphics	Intel® Core™ i integrated graphics	AMD Radeon™ Vega GPU integrat- ed
24-bit dual-channel LVDS or eDP (on carrier board)	24-bit dual-channel 2x DDI, LVDS or eDP (on carrier board)	24-bit dual-channel LVDS (on carrier board)	24-bit dual-channel LVDS (on carrier board)	24-bit dual-channel LVDS or eDP (on carrier board)
Intel® I210IT Gigabit LAN	Intel I226IT Gigabit LAN	Intel® I219LM Gigabit LAN PHY	Intel® I219LM Gigabit LAN PHY	Intel® I211AT or I210AT Gigabit LAN
Intel® Atom® SoC built-in HD audio controller	Intel® Atom® SoC built-in HD audio controller	Realtek ALC662 or ALC888S (on carrier board)	Realtek ALC662 or ALC888S (on carrier board)	AMD V1000 series APU built-in HD interface
2x SATA III	2x SATA III (on Carrier Board)	4x SATA III ports (on carrier board)	2x SATA III ports (on carrier board)	2x SATA III ports (on carrier board)
F81804U-I (on board)	F81804U-I (on board)	NCT5523D (on board)	NCT5523D (on board)	F81804U-I (on board)
1 SPP/EPP/ECP port (on carrier board)	1 SPP/EPP/ECP port (on Carrier Board)	1 SPP/EPP/ECP port (on carrier board)	1 SPP/EPP/ECP port (on carrier board)	1 SPP/EPP/ECP port (on carrier board)
2x UART (Tx/Rx only)	2x UART (Tx/Rx only)	2x RS-232 COM ports (on carrier board)	2x RS-232 COM ports (on carrier board)	2x RS-232 COM ports (on carrier board)
8x USB 2.0 (via carrier board)	4x USB 2.0 (via Carrier Board)	8x USB 2.0 (via carrier board)	8x USB 2.0 (via carrier board)	8x USB 2.0 (via carrier board)
2x USB 3.0 (via carrier board)	2x USB 3.1 (via Carrier Board)	4x USB 3.0 (via carrier board)	4x USB 3.0 (via carrier board)	4x USB 3.1 (via carrier board)
2.0	2.0	2.0	2.0	2.0
N/A	N/A	On carrier board	On carrier board	N/A
Yes	Yes	Yes	Yes	Yes
eMMC 5.0 up to 32GB (optional)	N/A	N/A	eMMC5.0 (optional)	N/A
256 levels	256 levels	256 levels	256 levels	256 levels
4x PCI-E(x1)	5x PCI-E(x1)	8x PCI-E(x1), 1x PCI-E(x16)	4x PCI-E(x1), 1x PCI-E(x4)	8x PCI-E(x1) 1x PCI-E(x1)
4-in/ 4-out on carrier board (IP417)	4-in/ 4-out on Carrier Board (IP419)	4-in / 4-out on carrier board (IP413)	N/A	4-in / 4-out on carrier board (IP418)
On carrier board	On Carrier Board	On carrier board	On carrier board	On carrier board
Intel® Atom® E3950 1.6GHz w/ 4GB LDDR3L 1600 +12V: 1.42A	Intel® Atom® x6425E Processor 2.00GHz w/ 8GB DDR4-3200 +12V:1.93A	Intel® i7-7820EQ, 3.0GHz w/ 16GB DDR4-2400 +12V: 4.48A; +5V: 0.65A +3.3V: 0.27A, +5VBS: 0.13A	Intel® i7-7600U, 2.8GHz w/ 8GB DDR4-2133 +12V: 3.47A; +5V: 1.4A +3.3V: 0.33, +5VBS: 0.10A	Intel® i7-7600U, 2.8GHz w/ 8GB DDR4-2133 +12V: 3.47A; +5V: 1.4A +3.3V: 0.33, +5VBS: 0.10A
84mm x 55mm	95mm x 95mm	95mm x 125mm	95mm x 95mm	125mm x 95mm
One 220-pin COM Express Type-10 interface connectors to carrier board (for USB, expansion slots, SATA, LVDS, VGA, DVI, DisplayPort, LAN, audio, LPC, GPIO), Boot on LAN	Two 220-pin COM Express Type-6 in- terface connectors to Carrier Board (for USB, expansion slots, SATA, LVDS, DVI, DisplayPort, LAN, audio, LPC, GPIO), Boot on LAN	Two 220-pin COM Express Type-6 interface connectors to carrier board (for USB, expansion slots, SATA, LVDS, VGA, DVI, DisplayPort, LAN, audio, LPC, GPIO), Boot on LAN	Two 220-pin COM Express Type-6 interface connectors to carrier board (for USB, expansion slots, SATA, LVDS, VGA, DVI, DisplayPort, LAN, audio, LPC), Boot on LAN	Two 220-pin COM Express Type-6 interface connectors to carrier board (for USB, expansion slots, SATA, LVDS, VGA, DVI, DisplayPort, LAN, audio, LPC, GPIO), Boot on LAN
P.1-11	P.1-10	P.1-9	P.1-8	P.1-7

1 CPU Modules

2 Single Board Computers

3 Motherboards

4 CPU Cards

# Comparison Table

## CPU Module

Models	ET977	ET980	ET981	IBQ800
<b>Form Factor</b>	COM Express Type-6 (R3.0)	COM Express Type-6 (R3.0)	COM Express Type-6 (R3.0)	QSeven (R2.1)
<b>CPU Socket</b>	BGA1140 on board	BGA1744 on board	BGA1744 on board	FCBGA1296 SoC on board
<b>CPU</b>	AMD Ryzen™ V1000 / R1000 series Embedded APU	12th Gen Intel® Core™ i7/i5/i3	13th Gen Intel® Core™ i7/i5/i3	Intel® Atom® Processor E3950/ E3940/ E3930
<b>CPU Max. Frequency</b>	Up to 3.8GHz	Up to 4.7GHz	TBD	Up to 2.5GHz
<b>PCH</b>	N/A	N/A	N/A	N/A
<b>Memory</b>	2x DDR4 SO-DIMM	2x DDR4 SO-DIMM	2x DDR5 SO-DIMM	LPDDR4 on board Memory
<b>Max. Memory Size</b>	32GB	64GB	64GB	8GB
<b>BIOS</b>	AMI	AMI	AMI	AMI
<b>Graphics Controller</b>	AMD Radeon™ Vega GPU integrated	Intel® Core™ i integrated graphics	Intel® Core™ i integrated graphics	Intel® Gen9-LP w/ 18 EUs graphics
<b>Video Output</b>	24-bit dual-channel LVDS or eDP (on carrier board)	24-bit dual-channel LVDS (on carrier board)	24-bit dual-channel LVDS (on Carrier Board)	24-bit dual-channel LVDS (on carrier board)
<b>Ethernet</b>	Intel® I211AT or I210AT Gigabit LAN	Intel® I225V 2.5 Gigabit LAN	Intel® I226LM 2.5 Gigabit LAN	Intel® I210IT Gigabit LAN
<b>Audio</b>	AMD Ryzen™ built-in HD audio controller	Realtek ALC662 or ALC888S HD audio codec (on carrier board)	Realtek ALC662 or ALC888S HD audio codec (on Carrier Board)	Realtek ALC662 or ALC888S HD audio codec (on carrier board)
<b>SATA</b>	2x SATA III (on carrier board)	2x SATA III ports (on Carrier Board)	2x SATA III (on Carrier Board)	2x SATA III ports (on Carrier Board)
<b>I/O Chipset</b>	Fintek F81804U-I	F81804U-I (on board)	F81804U-I (on board)	F81804U-I (on board)
<b>Parallel Port</b>	1 SPP/EPP/ECP port (on carrier board)	N/A	N/A	N/A
<b>Serial Port</b>	2x UART (Tx/Rx only)	2x RS-232 COM ports (Tx/Rx only)	2x RS-232 COM ports (Tx/Rx only)	1x UART (TX/RX) (on carrier board)
<b>USB 2.0</b>	8x USB 2.0 ports (Via carrier board)	8x USB 2.0 ports (Via carrier board)	8x USB2.0 ports (Via Carrier Board)	4x USB 2.0 (via carrier board)
<b>USB 3.X</b>	1x USB 3.1(10G), 3x USB 3.1 (via carrier board)	4x USB 3.1 Gen2 (via carrier board)	4x USB 3.1 Gen2 (Via Carrier Board)	3x USB 3.0 (via carrier board)
<b>TPM</b>	2.0	2.0	2.0	2.0
<b>KB / MS</b>	N/A	N/A	N/A	N/A
<b>Hardware Monitor</b>	Yes	Yes	Yes	Yes
<b>Storage Device Interface</b>	N/A	N/A	N/A	eMMC5.0 (optional)
<b>Watchdog Timer</b>	256 levels	256 levels	256 levels	256 levels
<b>Expansion slots</b>	V1000: 1x PEG(8x), 4x PCI-E(1x)(Gen3), 2x PCI-E(1x)(Gen2) R1000: 1x PEG(4x), 3x PCI-E(1x)(Gen3), 3x PCI-E(1x)(Gen2)	1x PCI-E(x16), 1x PCI-E(4x), 4x PCI-E(1x)	1x PCI-E(x16), 1x PCI-E(4x), 4x PCI-E(1x)	4x PCI-E(x1)
<b>Digital I/O</b>	4-in / 4-out on carrier board (IP418)	4-in / 4-out on carrier board	4-in / 4-out on Carrier Board	4-in / 4out on carrier board (IP416)
<b>Power Input</b>	On carrier board	On carrier board	On Carrier Board	On carrier board
<b>Power Consumption</b>	AMD V1605B w/ 2x 8GB DDR4-2133, +12V: 3.28A AMD R1606G w/ 2x 8GB DDR4-2133, +12V: 3.43A	Intel® Core™ i5-1250PE 1.50GHz w/ 2x 16GB DDR4-3200 +12V:2.6A	TBD	Intel® Atom® E3950 1.6GHz w/ 8GB LDDR4 1600 +12V: 1.7121A
<b>Dimensions (L x W)</b>	125mm x 95mm	125mm x 95mm	125mm x 95mm	70mm x 70mm
<b>Extra Features</b>	Two 220-pin COM Express Type-6 interface connectors to carrier board (for USB, expansion slots, SATA, LVDS, VGA, DVI, DisplayPort, LAN, audio, LPC, GPIO), Boot on LAN	Two 220-pin COM Express Type 6 interface connectors to carrier board (for USB, expansion slots, SATA, LVDS, VGA, DVI, DisplayPort, LAN, audio, LPC, GPIO), Boot on LAN	Two 220-pin COM Express Type 6 interface connectors to Carrier Board (for USB, expansion slots, SATA, LVDS, VGA, DVI, DisplayPort, LAN, audio, LPC, GPIO), Boot on LAN	One 230-pin golden finger Qseven interface connector to carrier board (for USB, expansion slots, SATA, LVDS, DisplayPort, LAN, audio) Boot on LAN
<b>Page No.</b>	R1-6	P1-5	P1-4	R1-15

1

CPU Modules

2

Single Board Computers

3

Motherboards

4

CPU Cards





## Features

- 13th Gen Intel® P-series Core™ i7/i5/i3 processors on board
- 2x DDR5-5600 SO-DIMM sockets, Max. 64GB
- 1x 2.5 GbE
- 4x USB 3.2, 8x USB 2.0, 2x SATA III, 2x COM
- Supports 3x independent displays from HDMI / DP / VGA / LVDS or eDP
- Digital I/O, TPM (2.0), Watchdog timer
- 1x PCI-E(x16), 1x PCI-E(x4), 4x PCI-E(x1) signals to carrier board

## Specifications

CPU	BGA1744 for 13th Intel® Gen P-series Core™ i7/i5/i3 processors (SoC)
PCH	N/A
Memory	2x DDR5-5600 SO-DIMM socket, Max. 64GB, ECC compatible
BIOS	AMI
Watchdog Timer	256 levels
H/W Monitor	Yes
Storage Device Interface	N/A
Expansion Slots	1x PCI-E(x16), 1x PCI-E(x4), 4x PCI-E(x1) to carrier board
Graphics Controller	13th Intel® Gen P-series Core™ processors integrated graphics
Video Output	HDMI, DisplayPort, VGA, LVDS or eDP on carrier board
Ethernet	Intel® I226LM 2.5 GbE RJ45 on carrier board
I/O Chipset	Fintek F81804U-I onboard
Serial Port	2x COM ports (Tx/Rx only)
USB 2.0	4x USB 3.2 (10bps) via carrier board
USB 3.X	8x USB 2.0 via carrier board
Serial ATA	2x SATA III via carrier board
Audio	Built-in HD Audio controller
TPM	N/A
Others	Shared memory Digital I/O (4-in/4-out), Watchdog timer, TPM (2.0)
Dimensions (L X W)	95mm x 125mm (3.74" x 4.92")
Power Consumption	TBD
Operating Temperature	0°C~60°C ( 32°F~140°F)
Storage Temperature	-20°C~80°C (-4°F~176°F)
Relative Humidity	90% (non-condensing @60°C)

## Ordering Information

ET981-I7U	COM Express (Type 6) module w/ Intel® i7-1365UE onboard, support LVDS
ET981LV-I7P	COM Express (Type 6) module w/ Intel® i7-1370PE onboard, support LVDS
ET981LV-I5U	COM Express (Type 6) module w/ Intel® i5-1345UE onboard, support LVDS
ET981-I5U	COM Express (Type 6) module w/ Intel® i5-1345UE onboard, support eDP
ET981LV-I5P	COM Express (Type 6) module w/ Intel® i5-1350PE onboard, support LVDS
ET981LV-I3P	COM Express (Type 6) module w/ Intel® i3-1320PE onboard, support LVDS



1 CPU Modules

2 Single Board Computers

3 Motherboards

4 CPU Cards

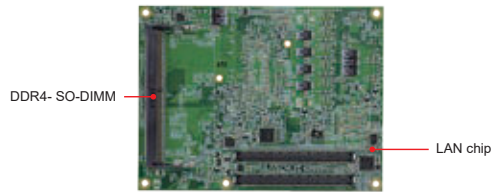
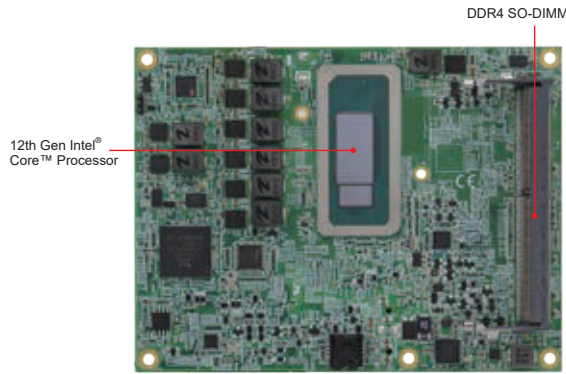

## Features

- Onboard 12th Gen Intel® Core™ i7/i5/i3 processors
- 2x DDR4-3200 SO-DIMM sockets, Max. 64GB
- Onboard 2.5 GbE
- Supports 3x independent displays from HDMI / DP / VGA / LVDS or eDP
- 4x USB 3.2, 8x USB 2.0, 2x SATA III, 2x COM
- 1x PCI-E(x16), 1x PCI-E(x4), 4x PCI-E(x1) to carrier board
- Digital I/O, TPM (2.0), Watchdog timer

## Specifications

CPU	BGA1744 for 12th Gen Intel® Core™ i7/i5/i3 processors
PCH	N/A
Memory	2x DDR4-3200 SO-DIMM sockets, Max. 64GB, ECC compatible
BIOS	AMI
Watchdog Timer	256 levels
H/W Monitor	Yes
Storage Device Interface	N/A
Expansion Slots	1x PCI-E(x16), 1x PCI-E(x4), 4x PCI-E(x1) to carrier board
Graphics Controller	12th Gen Intel® Core™ P-series processor integrated graphics
Video Output	HDMI, DisplayPort, VGA, LVDS or eDP on carrier board
Ethernet	Intel® I226LM 2.5 GbE RJ45 on carrier board
I/O Chipset	Fintek F81804U-I onboard
Serial Port	2x COM ports (Tx/Rx only)
USB 2.0	8x USB 2.0 via carrier board
USB 3.X	4x USB 3.2 (10bps) via carrier board
Serial ATA	2x SATA III via carrier board
Audio	Built-in HD Audio controller
TPM	TPM (2.0)
Others	Digital I/O (4-in/4-out) , Watchdog timer
Dimensions (L X W)	125mm x 95mm (4.92" x 3.74")
Power Consumption	TBD
Operating Temperature	0°C~60°C (32°F~140°F)
Storage Temperature	-20°C~80°C (-4°F~176°F)
Relative Humidity	90% (non-condensing @60)

## Ordering Information

ET980LV-I7U	COM Express (Type 6) CPU Module w/ Intel® Core™ i7-1265UE onboard, support LVDS
ET980LV-I7P	COM Express (Type 6) CPU Module w/ Intel® Core™ i7-1270PE onboard, support LVDS
ET980LV-I5U	COM Express (Type 6) CPU Module w/ Intel® Core™ i5-1245UE onboard, support LVDS
ET980-I5U	COM Express (Type 6) CPU Module w/ Intel® Core™ i5-1245UE onboard, support eDP
ET980LV-I5P	COM Express (Type 6) CPU Module w/ Intel® Core™ i5-1250PE onboard, support LVDS
ET980LV-I3P	COM Express (Type 6) CPU Module w/ Intel® Core™ i3-1220PE onboard, support LVDS
IP414	ATX COM Express Type-6 carrier board, Supports ATX
IP414-DC	ATX COM Express Type-6 carrier board, Supports DC-in (+8V ~ +20V)

## Dimensions and Drawing

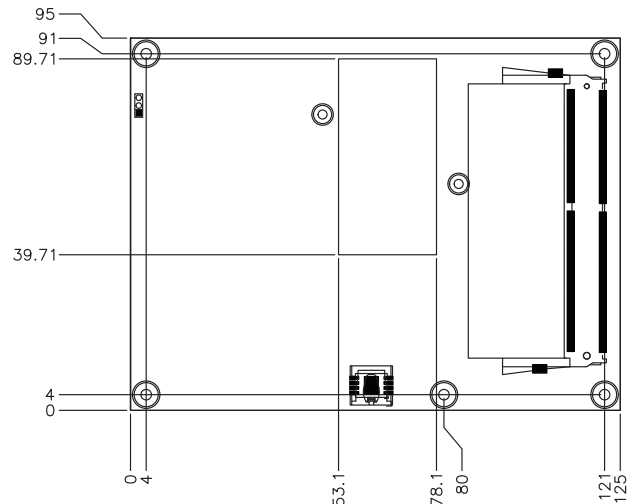

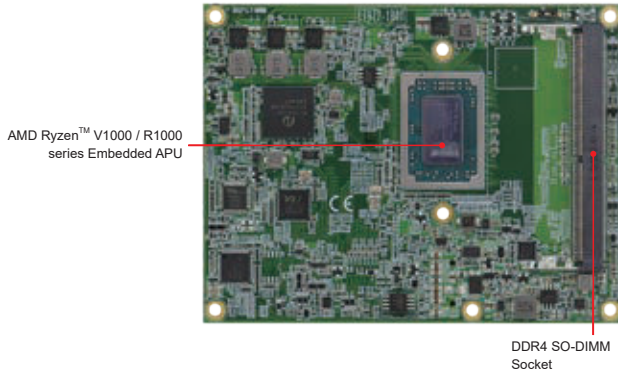

## Specifications

CPU	Onboard AMD Ryzen™ Embedded V1000 / R1000 Series
PCH	N/A
Memory	2x DDR4 SO-DIMM, Max. 32GB
BIOS	AMI
Watchdog Timer	256 levels
H/W Monitor	Yes
Storage Device Interface	N/A
Expansion Slots	V1000 Series: 1x PEG(8x)(Gen3), 4x PCI-E(1x)(Gen3), 2x PCI-E(1x) R1000 Series: 1x PEG(4x)(Gen3), 3x PCI-E(1x)(Gen3), 3x PCI-E(1x)
Graphics Controller	AMD Radeon™ Vega GPU integrated
Video Output	V1000 Series: 3x DDI R1000 Series: 2x DDI 1x LVDS or 1x eDP (By option)
Ethernet	Intel® I211AT or I210AT Gigabit LAN
I/O Chipset	Fintek F81804U-I
Serial Port	2x UART (Tx/Rx only)
USB 2.0	8x USB 2.0 Port [USB 2.0 Hub x 3 ports, (VL822-Q7)]
USB 3.X	1x USB 3.1 port (10G), 3x USB 3.1 ports (VL822-Q7)
Serial ATA	2x SATA III via carrier board
Audio	AMD Ryzen™ built-in HD audio controller
TPM	TPM (2.0)
Others	Digital I/O (4in/4-out)
Dimensions (L X W)	125mm x 95mm (4.92" x 3.74")
Power Consumption	AMD V1605B w/ 2x 8GB DDR4-2133, +12V: 3.28A AMD R1606G w/ 2x 8GB DDR4-2133, +12V: 3.43A
Operating Temperature	0°C~60°C (32°F~140°F)
Storage Temperature	-20°C~80°C (-4°F~176°F)
Relative Humidity	90% (non-condensing @60°C)

## Features

- Onboard AMD Ryzen™ Embedded V1000/ R1000 Series
- 2x DDR4-2400 SO-DIMM sockets, Max. 32GB, ECC compatible
- Supports up to 4x independent displays (HDMI/DVI/ DisplayPort, LVDS, and eDP) via the carrier board
- 4x USB 3.1, 8x USB 2.0, 2x SATA III
- Supports TPM (2.0)

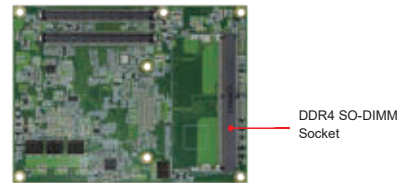

## Ordering Information

ET977-1605LV	COM Express (Type-6) CPU Module with AMD Ryzen™ V1605B QC APU (2.0GHz~3.6GHz), DDR4 dual-channel memory, LVDS support
ET977-1606LV	COM Express (Type-6) CPU Module with AMD Ryzen™ R1606G DC APU (2.6GHz~3.5GHz), DDR4 dual-channel memory, LVDS support
ET977-1505LV	COM Express (Type-6) CPU Module with AMD Ryzen™ R1505G DC APU (2.4GHz~3.5GHz), DDR4 dual-channel memory, LVDS support
HSET977-A	Heatsink with Fan for ET977
HSET977-1	Heat Spreader for ET977

## Dimensions and Drawing

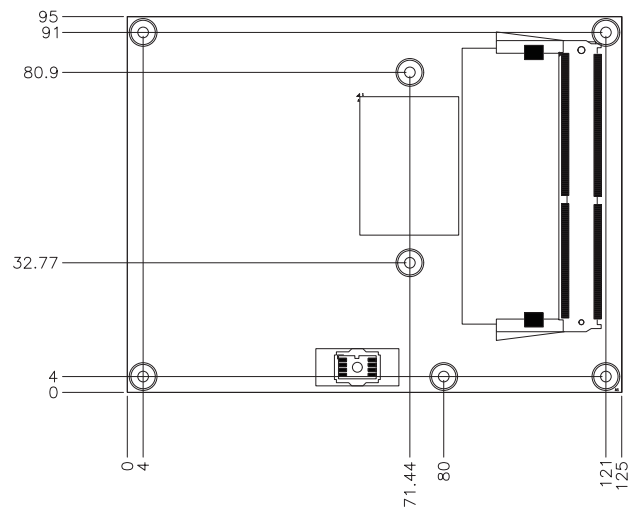

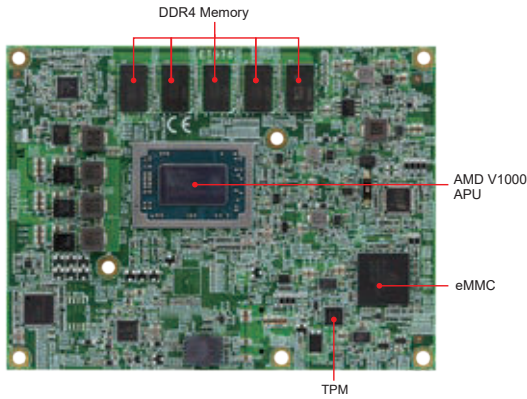

## Features

- Onboard AMD Ryzen™ Embedded V1000 Series
- Onboard DDR4 memory, Max. 8GB
- 3x independent displays, HDMI/DVI/DisplayPort & LVDS or eDP via carrier board
- 4x USB 3.1, 8x USB 2.0, 2x SATA III
- TPM (2.0)

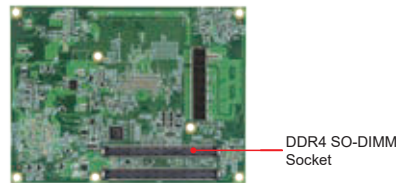

## Specifications

CPU	Onboard AMD Ryzen™ Embedded V1000 Series
PCH	N/A
Memory	Onboard Memory, DDR4, Max. 8GB
BIOS	AMI
Watchdog Timer	256 levels
H/W Monitor	Yes
Storage Device Interface	N/A
Expansion Slots	1x PEG(x8) 8x PCI-E(x1)
Graphics Controller	AMD Radeon™ Vega GPU integrated
Video Output	2x DDI 1x LVDS or 1x eDP (option)
Ethernet	Intel® I211AT or I210AT Gigabit LAN
I/O Chipset	Fintek F81804U-I
Serial Port	2x UART (Tx/Rx only)
USB 2.0	8x USB 2.0 via carrier board
USB 3.X	4x USB 3.1 via carrier board
Serial ATA	2x SATA III via carrier board
Audio	AMD Ryzen™ built-in HD audio controller
TPM	TPM (2.0)
Others	Digital I/O (4in/4-out)
Dimensions (L X W)	125mm x 95mm (4.92" x 3.74")
Power Consumption	AMD V1807B, 3.35GHz w/ 4GB DDR4-2666 +12V: 6.28A; +5V: 0.28A, +5VSB: 0.16A, +3.3V: 0.52A
Operating Temperature	0°C~60°C (32°F~140°F)
Storage Temperature	-20°C~80°C (-4°F~176°F)
Relative Humidity	90% (non-condensing @60°C)

## Ordering Information

ET976-1605LV-G	COM Express (Type-6) CPU Module with AMD Ryzen™ V1605B QC APU (3.6GHz), LVDS, 8GB DDR4 memory on board
ET976-1605LV-4G	COM Express (Type-6) CPU Module with AMD Ryzen™ V1605B QC APU (3.6GHz), LVDS, 4GB DDR4 memory on board
ET976-1605-8G	COM Express (Type-6) CPU Module with AMD Ryzen™ V1605B QC APU (3.6GHz), 8GB DDR4 memory on board
ET976-1605-4G	COM Express (Type-6) CPU Module with AMD Ryzen™ V1605B QC APU (3.6GHz), 4GB DDR4 memory on board
ET976-1202LV-E4G	COM Express (Type-6) CPU Module with AMD Ryzen™ V1202B DC APU (3.2GHz), LVDS, 4GB DDR4 memory on board with ECC
ET976-1202LV-4G	COM Express (Type-6) CPU Module with AMD Ryzen™ V1202B DC APU (3.2GHz), LVDS, 4GB DDR4 memory on board
HESET976-A	Heatsink with Fan for ET976
HSET976-1	Heat spreader for ET976

## Dimensions and Drawing

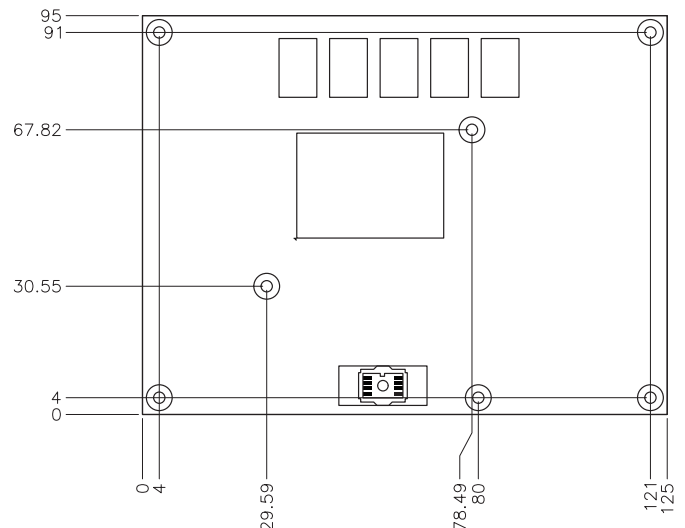

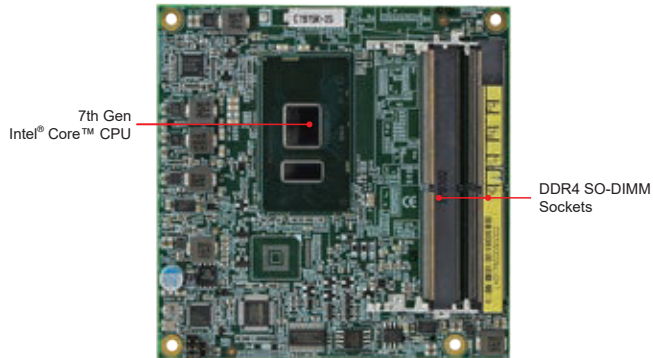

## Features

- Onboard 7th Gen Intel® Core™ i7/i5/i3 processors
- 2x DDR4 SO-DIMM, Max. 32GB
- Supports 2x DDI port or DDI + VGA
- 1x Intel® PCI-E GbE LAN
- Watchdog timer
- 8x USB 2.0, 4x USB 3.0, 2x COM, 2x SATA III
- 4x PCI-E(x1), 1x PCI-E(x4)
- TPM (2.0), eMMC5.0 (optional)

## Specifications

CPU	Onboard 7th Gen Intel® Core™ U-Series processors
PCH	N/A
Memory	2x DDR4 SO-DIMM, Max. 32GB
BIOS	AMI
Watchdog Timer	256 levels
H/W Monitor	Yes
Storage Device Interface	eMMC 5.0 up to 32GB (optional)
Expansion Slots	4x PCI-E(x1), 1x PCI-E(x4)
Graphics Controller	7th Gen Intel® Core™ U-Series processor integrated graphics, Supports DVI, HDMI, DisplayPort, LVDS
Video Output	24-bit dual-channels LVDS on carrier board
Ethernet	Intel® I219LM LAN PHY
I/O Chipset	Nuvoton NCT5523D on board (supports Tx/Rx only)
Serial Port	2x COM port (Tx/Rx only)
USB 2.0	8x USB 2.0 via baseboard
USB 3.X	4x USB 3.0 via baseboard
Serial ATA	2x SATA III via carrier board
Audio	7th Gen Intel® Core™ U-Series processor built-in HD audio + Realtek ALC662 or ALC888S codec
TPM	TPM (2.0)
Others	N/A
Dimensions (L X W)	95mm x 95mm (3.74" x 3.74")
Power Consumption	Intel® i7-7600U, 2.8GHz w/ 8GB DDR4-2133 +12V: 3.47A; +5V: 1.4A +3.3V: 0.33, +5VBS: 0.10A
Operating Temperature	-20°C~60°C (-4°F~140°F)
Storage Temperature	-20°C~80°C (-4°F~176°F)
Relative Humidity	10% ~ 90% (non-condensing)

## Ordering Information

ET975K-I7	COM Express (Type-6) CPU Module w/ Intel® Core™ i7-7600U, DDR4 dual-channel memory, 2x DDI
ET975K-I7V	COM Express (Type-6) CPU Module w/ Intel® Core™ i7-7600U, DDR4 dual-channel memory, 1x DDI+ 1x VGA
ET975K-I5	COM Express (Type-6) CPU Module w/ Intel® Core™ i5-7300U, DDR4 dual-channel memory, 2x DDI
ET975K-I5V	COM Express (Type-6) CPU Module w/ Intel® Core™ i5-7300U, DDR4 dual-channel memory, 1x DDI+ 1x VGA
ET975K-I3 (MOQ)	COM Express (Type-6) CPU Module w/ Intel® Core™ i3-7100U, DDR4 dual-channel memory, 2x DDI
ET975S-I7V	COM Express (Type-6) CPU Module w/ Intel® Core™ i7-6600U, DDR4 dual-channel memory, 1x DDI+ 1x VGA
ET975K-I7	COM Express (Type-6) CPU Module w/ Intel® Core™ i7-7600U, DDR4 dual-channel memory, 2x DDI
HSET975-A	Heatsink with Fan for ET975
HSET975-1	Heat Spreader for ET975

\*(S) means with Realtek ALC888S codec

## Dimensions and Drawing

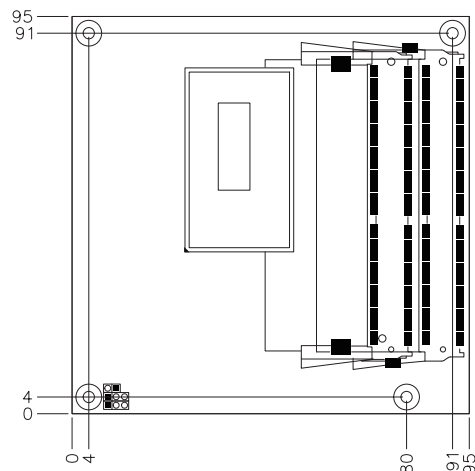





7th Gen Intel® Core™ CPU

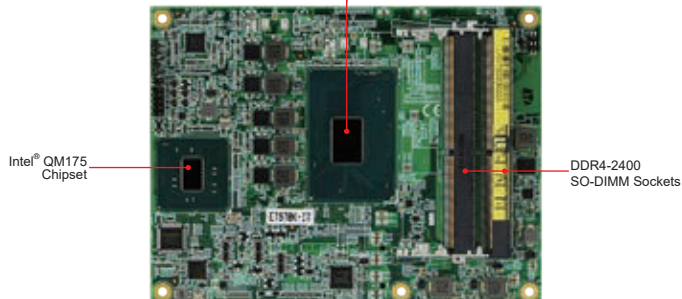

### Features

- Onboard 7th Gen Intel® Xeon® E3/ Core™ i7/i5/i3 processors
- 2x DDR4-2400 SO-DIMM, Max. 32GB
- 1x Intel® PCI-E GbE LAN
- Watchdog timer, Digital I/O
- 8x USB 2.0, 4x USB 3.0, 2x COM, 4x SATA III
- 3x independent displays
- TPM (2.0)
- 8x PCI-E(x1), 1x PCI-E(x16)

### Specifications

CPU	BGA1440 for 7th Gen Intel® Xeon® E3/ Core™ i7/i5/i3 processors
PCH	Intel® QM175 & CM238 & HM175 PCH
Memory	2x DDR4-2400 SO-DIMM, Max 32GB
BIOS	AMI
Watchdog Timer	256 levels
H/W Monitor	Yes
Storage Device Interface	N/A
Expansion Slots	8x PCI-E (x1), 1x PCI-E(x16)
Graphics Controller	7th Gen Intel® Core™ processor integrated graphics, Supports DVI, HDMI, DisplayPort, LVDS
Video Output	24-bit dual-channels LVDS on carrier board
Ethernet	Intel® I219LM LAN PHY/Intel® I219V LAN GbE
I/O Chipset	Nuvoton NCT5523D
Serial Port	(supports Tx/Rx only) 2x COM port
USB 2.0	8x USB 2.0 via carrier board
USB 3.X	4x USB 3.0 via carrier board
Serial ATA	4x SATA III via carrier board
Audio	Intel® QM175 PCH built-in HD audio w/ Realtek ALC662 or ALC888S codec on carrier board (IP413)
TPM	TPM (2.0)
Others	Digital I/O (4-in/4-out)
Dimensions (L X W)	95mm x 125mm (3.74" x 4.92")
Power Consumption	Intel® i7-7820EQ, 3.0GHz w/16GB DDR4-2400 +12V: 4.48A; +5V: 0.65A +3.3V: 0.27A, +5VBS: 0.13A
Operating Temperature	0°C~60°C (32°F~140°F) -40°C~75°C (-40°F~167°F)(ET970K-I3)
Storage Temperature	-20°C~80°C (-4°F~176°F)
Relative Humidity	10%~90% (non-condensing)

### Ordering Information

ET970K-X3G	COM Express (Type-6) CPU Module w/ Intel® Xeon® E3-1505M V6 (3.0GHz), CM238 PCH, DDR4 dual-channel memory
ET970K-I7	COM Express (Type-6) CPU Module w/ Intel® Core™ i7-7820EQ (3.0GHz~3.7GHz), QM175 PCH, DDR4 dual-channel memory
ET970K-I5	COM Express (Type-6) CPU Module w/ Intel® Core™ i5-7440EQ (2.9GHz~3.6GHz), QM175 PCH, DDR4 dual-channel memory
ET970K-I3	COM Express (Type-6) CPU Module w/ Intel® Core™ i3-71001E (2.9GHz), HM175 PCH, DDR4 dual-channel memory
ET970S-I7	COM Express (Type-6) CPU Module w/ Intel® Core™ i7-6820EQ (2.8GHz), QM170 PCH, DDR4 dual-channel memory
HSET970-B	Heatsink with fan for ET970
HSET970-2	Heat Spreader with fan for ET970

\*[S] means with Realtek ALC888S codec

### Dimensions and Drawing

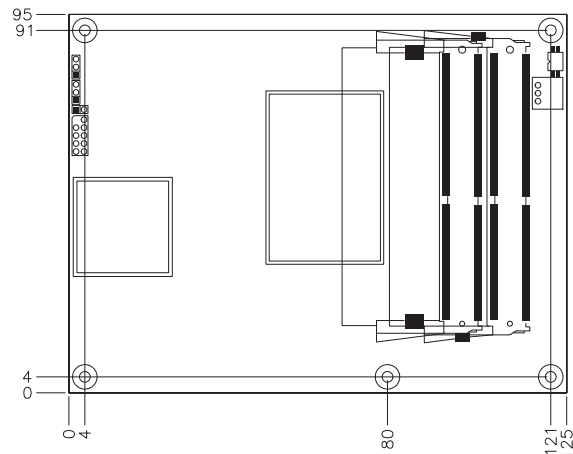



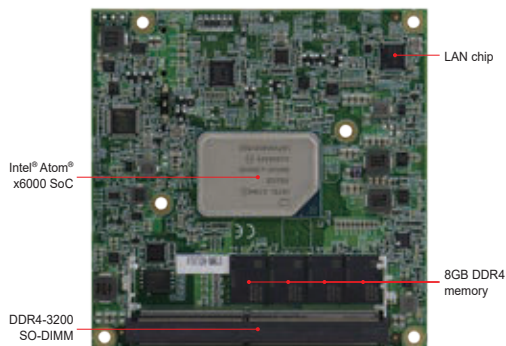

## Features

- Onboard Intel® Atom® x6000 series processors
- Onboard 8GB DDR4 memory + 1x DDR4 SO-DIMM, IB ECC compatible
- 1x I226IT PCI-E 2.5G LAN
- 2x USB 3.1, 4x USB 2.0, 2x SATA III, 2x UART (Tx/Rx only)
- 3x independent displays, DisplayPort /DVI-D / LVDS or eDP via carrier board (IP419)
- Wide-range operating temperature of -40°C ~ +85°C

## Specifications

CPU	Intel® Atom® QC x6425E (1.8Ghz/3.0Ghz) Intel® Atom® DC x6211E (1.2Ghz/3.0Ghz)
PCH	Integrated in Intel® SoC
Memory	Onboard DDR4 8GB & 1x DDR4 SO-DIMM, Max. support 24GB, IB ECC compatible
BIOS	AMI
Watchdog Timer	256 levels
H/W Monitor	Yes
Storage Device Interface	N/A
Expansion Slots	5x PCI-E(x1) to carrier board
Graphics Controller	Intel® Gen11 integrated graphics
Video Output	2x DDI, LVDS or eDP on carrier board
Ethernet	1x Intel I226IT 2.5GbE RJ45 on carrier board
I/O Chipset	Fintek F81804U-I
Serial Port	2x COM ports (Tx/Rx only)
USB 2.0	4x USB 2.0 via carrier board
USB 3.X	2x USB 3.1 (5Gbps) via carrier board
Serial ATA	2x SATA III via carrier board
Audio	Built-in HD Audio controller
TPM	TPM (2.0)
Others	Digital I/O (4-in/4-out)
Dimensions (L X W)	95mm x 95mm (3.74" x 3.74")
Power Consumption	TBD
Operating Temperature	-40°C ~ +85°C (-40°F ~ +185°F) ; exclude SO-DIMM memory module
Storage Temperature	-40°C ~ 90°C (-40°F ~ +194°F)
Relative Humidity	90% (non-condensing @60°C)

## Ordering Information

ET880-6425E	COM Express (Type-6) module w/ Intel® Atom® x6425E SoC on board, supports eDP
ET880-6425ELV	COM Express (Type-6) module w/ Intel® Atom® x6425E SoC on board, supports LVDS
ET880-6211E	COM Express (Type-6) module w/ Intel® Atom® x6211E SoC on board, supports eDP
ET880-6211ELV	COM Express (Type-6) module w/ Intel® Atom® x6211E SoC on board, supports LVDS
HSET880-A	Heatsink for ET880 with Atom® x6000 series SoC
HSET880-1	Heat spreader for ET880 with Atom® x6000 series SoC

## Dimensions and Drawing

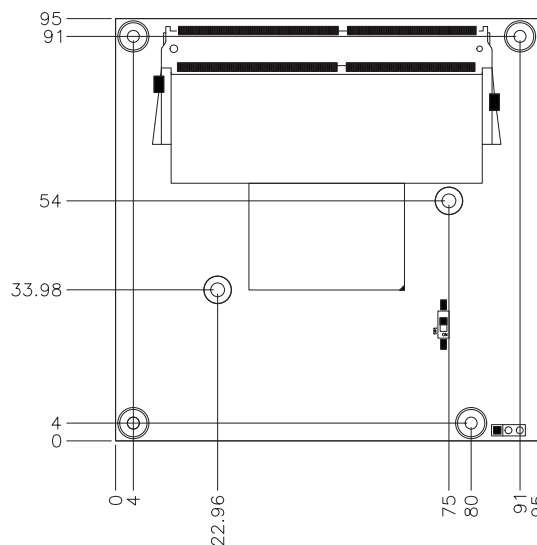

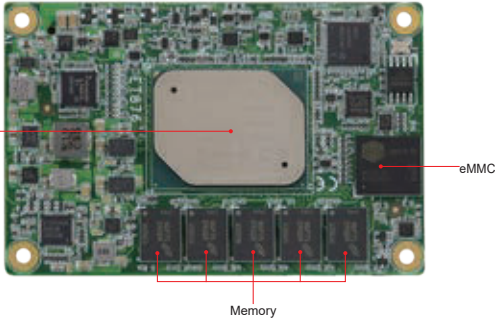

## Features

- Onboard Intel® Atom® x7-E3950/ x5-E3940/ x5-E3930 Processor [i-Temp support]
- Onboard DDR3L memory with ECC support
- 1x Intel® I210IT Gigabit LAN
- Supports TPM (2.0), eMMC5.0 (optional)
- Wide-range operating temperature from -40°C to 85°C

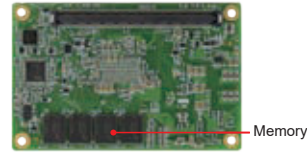

## Specifications

CPU	Intel Atom® x7-E3950 Processor (1.6GHz~2.0GHz) Intel Atom® x5-E3940 Processor (1.6 GHz~1.8GHz) Intel Atom® x5-E3930 Processor (1.3 GHz~1.8GHz)
PCH	Integrated in Intel® SoC
Memory	Onboard memory, DDR3L 1600MHz, 4GB with ECC
BIOS	AMI
Watchdog Timer	256 levels
H/W Monitor	Yes
Storage Device Interface	eMMC 5.0 up to 32GB (optional)
Expansion Slots	4x PCI-E(x1)
Graphics Controller	Intel® SoC integrated Gen9-LP graphics
Video Output	1x DDI 1x LVDS or 1x eDP (optional)
Ethernet	Intel® I210IT Gigabit LAN
I/O Chipset	F81804U-I
Serial Port	2x UART (Tx/Rx only)
USB 2.0	8x USB 2.0 via carrier board
USB 3.X	2x USB 3.0 via carrier board
Serial ATA	2x SATA III
Audio	Intel® Atom® SoC built-in HD audio controller
TPM	TPM (2.0)
Others	I2C
Dimensions (L X W)	84mm x 55mm (3.3" x 2.17")
Power Consumption	Intel® Atom® E3950 1.6GHz w/ 4GB LDDR3L 1600 +12V: 1.42A
Operating Temperature	-40°C ~ 85°C (-40°F ~ 185°F)
Storage Temperature	-40°C ~ 90°C (-40°F ~ 194°F)
Relative Humidity	90% (non-condensing @60°C)

## Ordering Information

ET876-X7LV	COM Express (Type-10) CPU Module with Intel® Atom® x7-E3950 (2.0GHz) on board, LVDS, 4GB DDR3L memory on board
ET876-X5QLV	COM Express (Type-10) CPU Module with Intel® Atom® x5-E3940 (1.8GHz) on board, LVDS, 4GB DDR3L memory on board
ET876-X5LV	COM Express (Type-10) CPU Module with Intel® Atom® x5-E3930 (1.8GHz) on board, LVDS, 4GB DDR3L memory on board
IP417	Mini-ITX COM Express Type-10 (R3.0) carrier board
HSET876-1	Heat spreader for ET876-420/ 335
HSET876-X-1	Heat spreader for ET876-X7/ X5Q/ X5
HSET876-A	Heat sink w/ FAN for ET876-420/ 335
HSET876-X-A	Heat sink w/ FAN for ET876-X7/ X5Q/ X5
HSET876-X-B	Heat sink w/o FAN for ET876-X5 (only temp -40°C ~80°C)

## Dimensions and Drawing

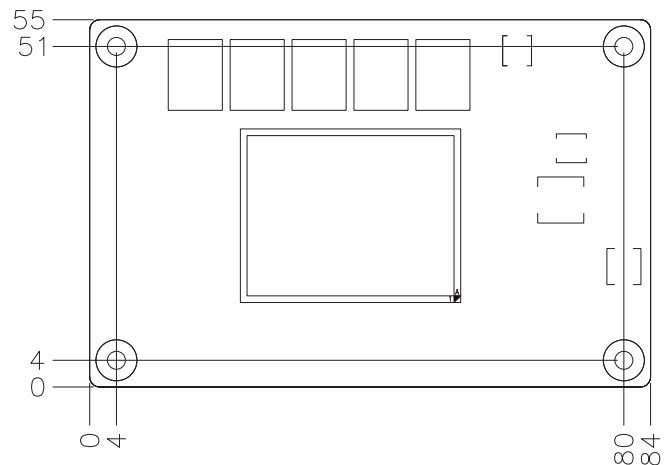

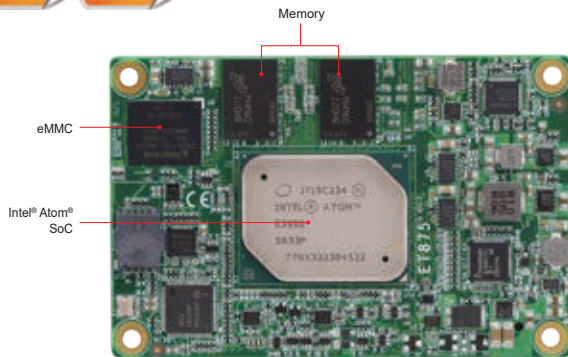

## Features

- Onboard Intel® Atom® x7-E3950/ x5-E3940/ x5-E3930 Processor [i-Temp support]
- Onboard Intel® Pentium® N4200/ Celeron® N3350
- Onboard LPDDR4 memory
- 1x Intel I210IT Gigabit LAN
- Supports TPM (2.0), eMMC5.0 (optional)
- Wide-range operating temperature in certain models

## Specifications

CPU	Intel Atom® x7-E3950 Processor (1.6GHz~2.0GHz) Intel Atom® x5-E3940 Processor (1.6 GHz~1.8GHz) Intel Atom® x5-E3930 Processor (1.3 GHz~1.8GHz) Intel® Pentium® Processor N4200 (1.1GHz~ 2.5GHz) Intel® Celeron® Processor N3350 (1.1GHz~ 2.4GHz)
PCH	Integrated in Intel® SoC
Memory	Onboard memory, LPDDR4, Max 8GB
BIOS	AMI
Watchdog Timer	256 levels
H/W Monitor	Yes
Storage Device Interface	eMMC 5.0 up to 32GB (optional)
Expansion Slots	4x PCI-E(x1)
Graphics Controller	Intel® SoC integrated Gen9-LP graphics
Video Output	1x DDI 1x LVDS or 1x eDP (optionl)
Ethernet	Intel® I210IT Gigabit LAN
I/O Chipset	Fintek F81804U-I
Serial Port	2x UART (Tx/Rx only))
USB 2.0	8x USB 2.0 via carrier board
USB 3.X	2x USB 3.0 via carrier board
Serial ATA	2x SATA III via carrier board
Audio	Intel® Atom® SoC built-in HD audio controller
TPM	TPM (2.0)
Others	I2C
Dimensions (L X W)	84mm x 55mm (3.3" x 2.17")
Power Consumption	Intel® Atom® Processor E3950 1.60GHz w/ Onboard LPDDR4 2400MHz 8GB +12V: 1.587A
Operating Temperature	-20°C ~ 60°C (-4°F ~ 176°F)(ET875-420/ET875-335) -40°C ~ 85°C (-40°F ~ 185°F)(ET875-x7/x5)
Storage Temperature	-40°C ~ 90°C (-40°F ~ 194°F)
Relative Humidity	90% (non-condensing @60°C)

## Ordering Information

ET875F1-X7	COM Express (Type-10) CPU Module with Intel® Atom® x7-E3950 (2.0GHz) on board, eDP, 4GB LPDDR4 memory on board
ET875F1-X5Q	COM Express (Type-10) CPU Module with Intel® Atom® x5-E3940 (1.8GHz) on board, eDP, 4GB LPDDR4 memory on board
ET875F1-X5QLV	COM Express (Type-10) CPU Module with Intel® Atom® x5-E3940 (1.8GHz) on board, LVDS, 4GB LPDDR4 memory on board
ET875F1-X5	COM Express (Type-10) CPU Module with Intel® Atom® x5-E3930 (1.8GHz) on board, eDP, 4GB LPDDR4 memory on board
ET875F1-420LVM8G	COM Express (Type-10) CPU Module with Intel® Pentium® N4200 (2.5GHz), LVDS, 8GB LPDDR4 memory on board, eMMC 32GB
ET875F1-335	COM Express (Type-10) CPU Module with Intel® Celeron® N3350 (2.4GHz), eDP, 4GB LPDDR4 memory on board
IP417	Mini-ITX COM Express Type-10 (R3.0) carrier board
HSET875-A	Heatsink with FAN for ET875-420/ 335
HSET875-X-B	Heatsink with FAN for ET875-X7/ X5
HSET875-1	Heat Spreader for ET875-420/335
HSET875-X-1	Heat Spreader for ET875-X7/ X5

## Dimensions and Drawing

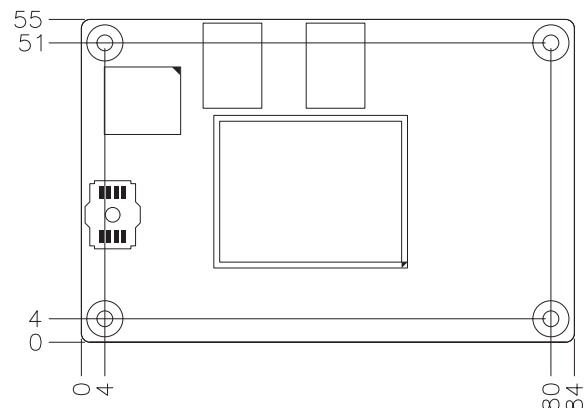

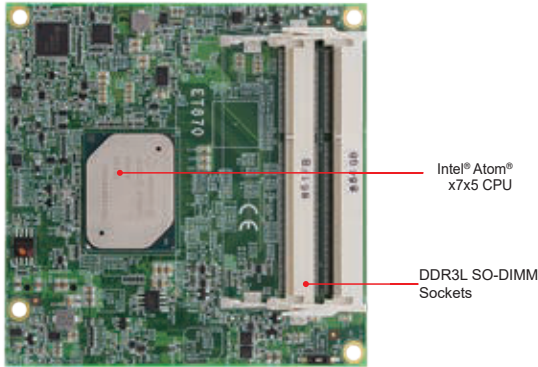

## Features

- Onboard Intel® Atom® x7-E3950/ x5-E3940/ x5-E3930 Processor [i-Temp support]
- 2x DDR3L-1866 SO-DIMM sockets, Max. 16GB
- Supports 2x independent displays, DisplayPort/ DVI-D/ LVDS or eDP via carrier board (IP419)
- Supports HD audio via carrier board (IP419)
- Wide-range operating temperature from -40°C to 85°C



## Ordering Information

ET870-I50	COM Express (Type-6) CPU Module with Intel® Atom® x7-E3950 (2.0GHz), DDR3L dual-channel memory, eDP support
ET870-I50LV	COM Express (Type-6) CPU Module with Intel® Atom® x7-E3950 (2.0GHz), DDR3L dual-channel memory, LVDS support
ET870-I40	COM Express (Type-6) CPU Module with Intel® Atom® x5-E3940 (1.8GHz), DDR3L dual-channel memory, eDP support
ET870-I40LV	COM Express (Type-6) CPU Module with Intel® Atom® x5-E3940 (1.8GHz), DDR3L dual-channel memory, LVDS support
ET870-I30	COM Express (Type-6) CPU Module with Intel® Atom® x5-E3930 (1.8GHz), DDR3L dual-channel memory, eDP support
ET870-I30LV	COM Express (Type-6) CPU Module with Intel® Atom® x5-E3930 (1.8GHz), DDR3L dual-channel memory, LVDS support
IP419	Mini-ITX COM Express Type-6 (R3.0) carrier board
HSET870-A	Heatsink for ET870
HSET870-1	Heat spreader for ET870

## Specifications

CPU	Intel Atom® x7-E3950 Processor (1.6GHz~2.0GHz) Intel Atom® x5-E3940 Processor (1.6 GHz~1.8GHz) Intel Atom® x5-E3930 Processor (1.3 GHz~1.8GHz)
PCH	Integrated in Intel® SoC
Memory	2x DDR3L-1866 SO-DIMM sockets, Max. 16GB
BIOS	AMI
Watchdog Timer	256 levels
H/W Monitor	Yes
Storage Device Interface	N/A
Expansion Slots	4x PCI-E(x1)
Graphics Controller	Intel® SoC integrated Gen9 18EUs graphics
Video Output	Supports 2x DDI (DisplayPort / DVI-D) 1x 24-bit dual-channel or eDP
Ethernet	Intel® I210IT Gigabit LAN
I/O Chipset	Fintek F81804U-I
Serial Port	2x COM ports (Tx/Rx only)
USB 2.0	4x USB 2.0 via carrier board
USB 3.X	3x USB 3.0 via carrier board
Serial ATA	2x SATA III via carrier board
Audio	Intel® Atom® SoC built-in HD Audio
TPM	TPM (2.0)
Others	Digital I/O (4-in / 4-out)
Dimensions (L X W)	95mm x 95mm
Power Consumption	Intel® Atom® E3950 1.6GHz w/ 2x 8GB DDR3L-1600 +12V: 2.18A
Operating Temperature	-40°C ~85°C (-40°F ~ 185°F)
Storage Temperature	-40°C ~ 90°C (-40°F ~ 194°F)
Relative Humidity	10~90% (non-condensing)

## Dimensions and Drawing

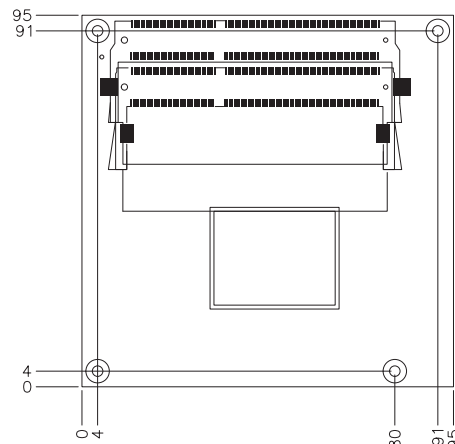



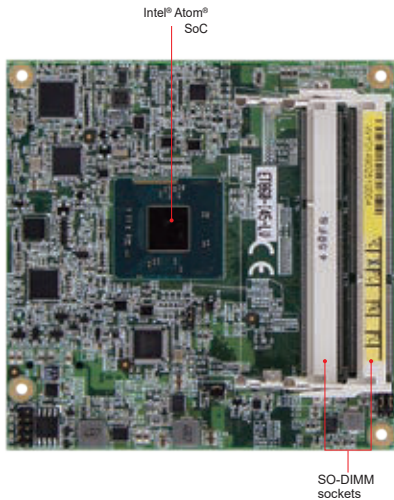

## Features

- Onboard Intel® Atom® Processor E3845/E3827
- 2x DDR3L SO-DIMM, Max. 8GB
- Single Gigabit LAN via carrier board (IP411)
- 2x SATA II, 1x USB 3.0, 8x USB 2.0, 2x COM via carrier board (IP411)
- Supports 2x independent displays, DisplayPort/CRT/LVDS via carrier board (IP411)
- Supports HD audio via carrier board (IP411)
- Wide-range operating temperature from -40°C to 85°C

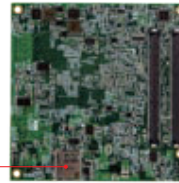

MicroSD

## Specifications

CPU	Intel® Atom® Processor E3845/E3827
PCH	Integrated in Intel® Atom® SoC
Memory	2x DDR3L@1.35V SO-DIMM, Max. 8GB (Non-ECC)
BIOS	AMI
Watchdog Timer	256 levels
H/W Monitor	Yes
Storage Device interface	N/A
Expansion Slots	1x PCI-E(x1)
Graphics Controller	Intel® Atom® E3845/E3827 SoC integrated graphics Supports CRT, DisplayPort & LVDS
Video Output	24-bit single-channel LVDS on carrier board (IP411)
Ethernet	1x Intel® I210IT Gigabit LAN
I/O Chipset	Nuvoton NCT5523D
Serial Port	2x COM ports (Tx/Rx only))
USB 2.0	8x USB 2.0 via carrier board (Supports 6x USB 2.0 only on IP411)
USB 3.X	1x USB 3.0 via carrier board (IP411)
Serial ATA	2x SATA III ports via carrier board (IP411)
Audio	Intel® Atom® E3845/E3827 SoC built-in audio with Realtek ALC662 or ALC888S codec on carrier board (IP411)
TPM	N/A
Others	MicroSD slot on board@ rear side Digital I/O (4-in / 4-out) on carrier board (IP411)
Dimensions (L x W)	95mm x 95mm (3.74" x 3.74")
Power Consumption	Intel® Atom® E3845 1.91GHz w/ 2x 2GB DDR3L-1600 +12V: 0.91A; +5V: 0.13A; +5VSB: 0.05A; +3.3V: 0.24A
Operating Temperature	-40°C~85°C (-40°F~185°F)
Storage Temperature	-40°C~90°C (-40°F~194°F)
Relative Humidity	90% (non-condensing @60°C)

## Ordering Information

ET860-I45-LV	COM Express (Type-6) CPU Module w/ Intel® Atom® Processor E3845 (1.91GHz) SoC, DDR3L dual-channel memory, LVDS
ET860-I27-LV	COM Express (Type-6) CPU Module w/ Intel® Atom® Processor E3827 (1.75GHz) SoC, DDR3L dual-channel memory, LVDS
IP411	Mini-ITX COM Express (Type-6) carrier board
HSET860-BGA-A	Heatsink for ET860
HSET860-BGA-1	Heat Spreader for ET860

## Dimensions and Drawing

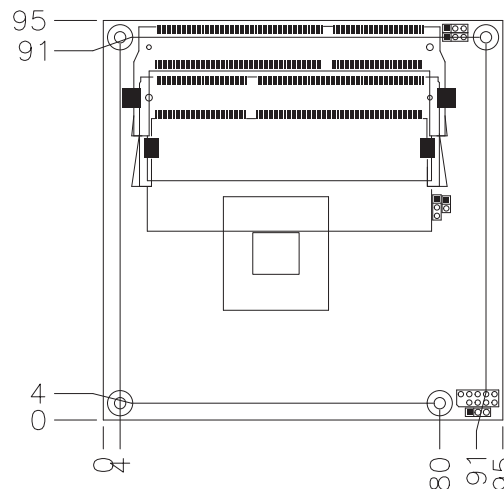

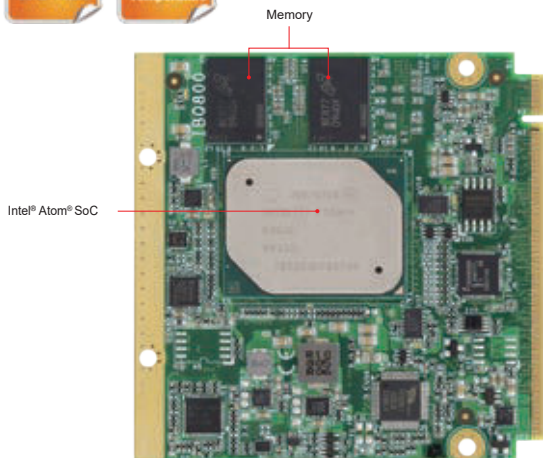

## Features

- Onboard Intel® Atom® x5-E3930, 1.8GHz or x7-E3950, 2.0GHz [i-Temp support]
- Onboard LPDDR4 memory
- 1x Intel I210IT Gigabit LAN
- Supports TPM (2.0), eMMC5.0 (optional)
- Wide-range operating temperature

## Specifications

CPU	Intel® Atom® QC x5/ E3930 (1.3 GHz~1.8GHz) Intel® Atom® QC x5/ E3940 (1.6 GHz~1.8GHz) Intel® Atom® QC x7/ E3950 (1.6 GHz~2.0GHz)
PCH	Integrated in Intel® SoC
Memory	Onboard memory, LPDDR4, Max 8GB
BIOS	AMI
Watchdog Timer	256 levels
H/W Monitor	Yes
Storage Device Interface	eMMC 5.0 up to 32GB (optional)
Expansion Slots	4x PCI-E(x1)
Graphics Controller	Intel® SoC integrated Gen9-LP graphics
Video Output	Supports 1x DDI port, 1x eDP or 1x dual-channel LVDS (option)
Ethernet	1x Intel® I210IT Gigabit LAN
I/O Chipset	Fintek F81804U-I
Serial Port	1x COM port (RX/TX/RTS/CTS only)
USB 2.0	4x USB 2.0, derived from Qseven CPU module
USB 3.X	3x USB 3.0, derived from Qseven CPU module
Serial ATA	2x SATA III via carrier board
Audio	Intel® Atom® SoC built-in HD audio controller
TPM	TPM (2.0)
Others	SD, from SoC CPU
Dimensions (L X W)	70mm x 70mm (2.75" x 2.75")
Power Consumption	Intel® Atom® E3950 1.6GHz w/ 8GB memory, DDR4 1600 +12V: 1.7121A
Operating Temperature	-40°C ~ 85°C (-40°F~185°F)
Storage Temperature	-40°C ~ 90°C (-40°F ~ 194°F)
Relative Humidity	90% (non-condensing @60°C)

## Ordering Information

IBQ800F1-X7LV	Qseven CPU module with Intel® Atom® E3950 (2.0GHz), 4GB LPDDR4 memory on board, LVDS support
IBQ800F1-X7	Qseven CPU module with Intel® Atom® E3950 (2.0GHz), 4GB LPDDR4 memory on board, eDP support
IBQ800F1-X5QLV	Qseven CPU module with Intel® Atom® E3940 (1.8GHz), 4GB LPDDR4 memory on board, LVDS support
IBQ800F1-X5Q	Qseven CPU module with Intel® Atom® E3940 (1.8GHz), 4GB LPDDR4 memory on board, eDP support
IBQ800F1-X5LV	Qseven CPU module with Intel® Atom® E3930 (1.8GHz), 4GB LPDDR4 memory on board, LVDS support
IBQ800F1-X5	Qseven CPU module with Intel® Atom® E3930 (1.8GHz), 4GB LPDDR4 memory on board, eDP support
IP416	Qseven (R2.1) carrier board
HSIBQ800-1	Heat Spreader for IBQ800
HSIBQ800-A	Heatsink for IBQ800

## Dimensions and Drawing

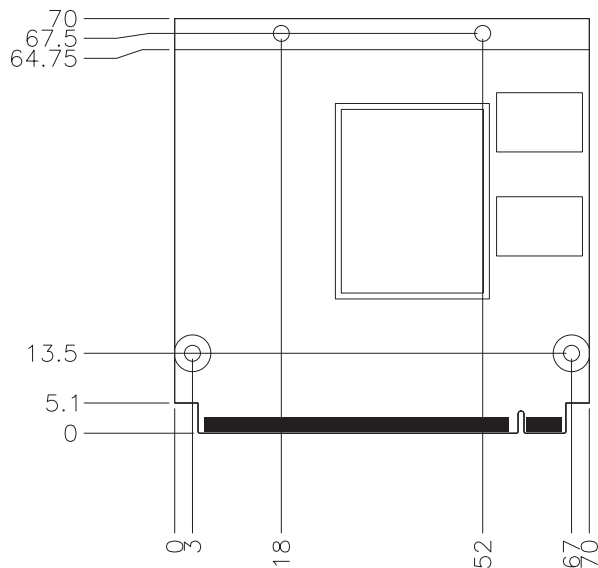



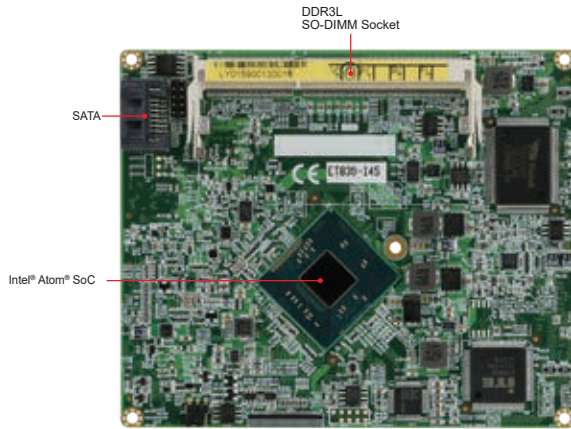

## Features

- Onboard Intel® Atom® Processor E3845, 1.91GHz
- 1x DDR3L SO-DIMM, Max. 8GB
- Supports CRT, LVDS and 1x DDI
- 1x 10/100Mbps LAN
- Watchdog timer, LPC to ISA
- 1x SATA II, 2x IDE, 4x USB 2.0, 2x COM
- Wide-range operating temperature



## Specifications

CPU	Intel® Atom® Processor E3845 SoC, 1.91GHz
PCH	Integrated in Intel® Atom® SoC
Memory	1x DDR3L SO-DIMM, Max. 8GB
BIOS	AMI
Watchdog Timer	256 levels
H/W Monitor	Yes
Storage Device Interface	N/A
Expansion Slots	4x ETX connectors for PCI bus, USB, audio, CRT, LVDS, LAN, COM ports, LPT, IDE, PS/2 keyboard/mouse and ISA bus
Graphics Controller	Intel® Atom® SoC integrated Gen. 7 4Eus graphics
Video Output	Supports CRT, 24-bit dual-channel LVDS & 1x DDI port
Ethernet	Realtek 8106E 10/100Mbps LAN
I/O Chipset	Nuvoton NCT6102D 1x keyboard, 1x mouse, 1x printer
Serial Port	2x RS232
USB 2.0	4x USB 2.0 via carrier board
USB 3.X	N/A
Serial ATA	1x SATA 2.0 port on board (3.0Gb/sec)
Audio	Intel® Atom® SoC built-in HD Audio w/ Realtek ALC888S codec
TPM	N/A
Others	Fintek F85226 (LPC to ISA)
Dimensions (L X W)	95mm x 114mm (3.74" x 4.49")
Power Consumption	Intel® Atom® E3845 1.91GHz w/ 2x 4GB DDR3L-1600 +5V : 1.92A
Operating Temperature	-20°C~70°C (-68°F~158°F)
Storage Temperature	-20°C~80°C (-68°F~176°F)
Relative Humidity	10%~90% (non-condensing)

## Ordering Information

ET839D1S-I45	ETX (3.0) CPU Module w/ Intel® Atom® processor E3845 SoC, CRT, LVDS and 10/100 LAN, heat spreader included
IP412	ETX(3.0) carrier board
HSET838-BGA-1	Heat spreader for ET839

\*(S) means with Realtek ALC888S codec

## Dimensions and Drawing

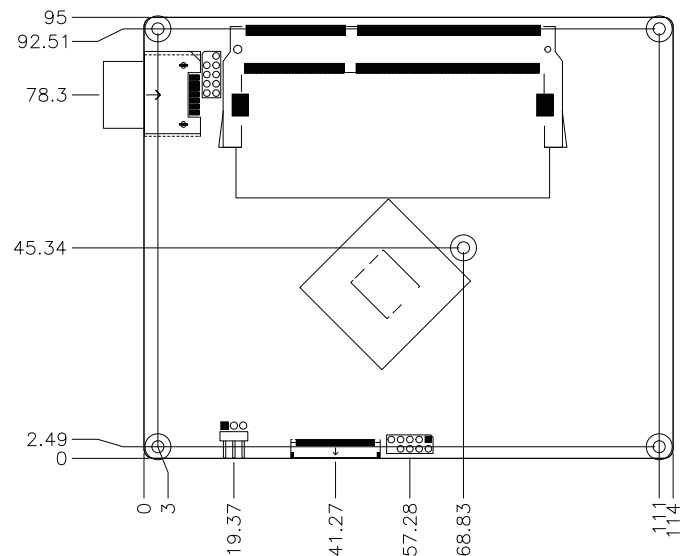

# Comparison Table

carrier board

Models	IP409	IP411	IP412	IP413	IP414
<b>Form Factor</b>	Flex ATX form factor	Mini-ITX form factor	Micro ATX form factor	ATX form factor	ATX form factor
<b>Module Interface</b>	COM Express Type-6	COM Express Type-6	ETX (3.0)	COM Express Type-6	COM Express Type-6
<b>Video Output</b>	18/24-bit dual-channel LVDS DVI-I / DVI-D / DisplayPort on board	18/24-bit dual-channel LVDS VGA/2x DVI-D	18/24-bit dual-channel LVDS Analog CRT	18/24-bit dual-channel LVDS DVI-D / HDMI / DisplayPort on board	18/24-bit dual-channel LVDS VGA / eDP / DisplayPort on board
<b>Ethernet</b>	1x RJ45 connector	2x RJ45 connector	1x RJ45 connector	1x RJ45 connector	1x RJ45 connector
<b>Audio</b>	Built-in ALC662 or ALC888S HD audio codec	Built-in ALC662 or ALC888S HD audio codec	N/A	Built-in ALC662 or ALC888S HD audio codec	Built-in ALC888S HD audio codec
<b>SATA</b>	2x SATA III + 2x SATA II	2x SATA III	N/A	4x SATA III	4x SATA III
<b>I/O Chipset</b>	Fintek F81846AD-I	Fintek F81846AD-I	N/A	Fintek F81846AD-I	Fintek F81946D-I
<b>Parallel Port</b>	1x Parallel port	1x Parallel port	1x Parallel port	1x Parallel port	N/A
<b>Serial Port</b>	4x COM ports (2 ports via rear I/O, 2-ports via pin header)	2x COM ports via rear I/O	2x COM ports (1 port via rear I/O, 1-port via pin header)	4x COM ports (2 ports on rear I/O, 2-ports via pin header)	COM ports x2 via onboard box-headers (RS232 only) 2x COM ports 2x COM ports (from CPU module, Tx/Rx only)
<b>USB 2.0</b>	4x USB 2.0 via pin header	8x USB 2.0 (2 ports on rear I/O, 6 ports via pin header)	2x USB 2.0 via rear I/O	4x USB 2.0 (2 ports via rear I/O, 2 ports via pin header)	3x USB2.0
<b>USB 3.X</b>	4x USB 3.0 on rear I/O	1x USB 3.0 via rear I/O	N/A	4x USB 3.0 via rear I/O	3x USB 3.2
<b>KB / MS</b>	1x KB/MS connector	N/A	1x PS/2 KB/MS connector	1x KB/MS connector	1x KB/MS connector
<b>Hardware Monitor</b>	Yes	Yes	Yes	Yes	Yes
<b>Watchdog Timer</b>	256 levels	256 levels	256 levels	256 levels	256 levels
<b>Expansion slots</b>	1x PCI-E(x16) slot 1x PCI-E(x4) slot 3x PCI-E(x1) slots 1x Mini PCI-E socket (full-size)	1x PCI-E(x1) slot	3x PCI slots 1x ISA slot	1x PCI-E(x16) slot 1x PCI-E(x4) slot 3x PCI-E(x1) slots 1x Mini PCI-E socket (full-size)	1x PCI-E(x16) slot [up to Gen.5] 2x PCI-E(x4) slot 2x PCI-E(x1) slot
<b>Digital I/O</b>	4-in/4-out	4-in/4-out	4-in/4-out	4-in/4-out	4-in/4-out
<b>Power Connector</b>	20+4-pin connector for ATX	20+4-pin connector for ATX	20+4-pin connector for ATX	20+4-pin connector for ATX or DC-in 12V only	20+4-pin connector for ATX (IP414) 2x 2-pin connector for DC power-in (IP414-DC only)
<b>Dimensions (L x W)</b>	190mm x 228mm (9"x 7.5")	170mm x 170mm (6.7"x 6.7")	244mm x 244mm (9.6"x 9.6")	305mm x 244mm (12"x 9.6")	305mm x 244mm (12" x 9.6")
<b>Extra Features</b>	Compatible with ET950/ET960	Compatible with ET860	Compatible with ET839	Compatible with ET970/ET975	TBD
<b>Page No.</b>	P1-27	P1-26	P1-25	P1-24	P1-23

1

CPU Modules

2

Single Board Computers

3

Motherboards

4

CPU Cards

# Comparison Table

carrier board

Models	IP416	IP417	IP418	IP419
<b>Form Factor</b>	Micro ATX form factor Qseven	Mini-ITX form factor	ATX form factor	Mini-ITX form factor
<b>Module Interface</b>	Qseven CPU Module (R2.1)	COM Express Type-10 (3.0)	COM Express Type-6 (3.0)	COM Express Type-6 (3.0)
<b>Video Output</b>	18/24-bit dual-channel LVDS DisplayPort on board	18/24-bit single-channel LVDS DisplayPort on board	18/24-bit single-channel LVDS eDP DVI-D / HDMI / DisplayPort on board	18/24-bit dual-channel LVDS DVI-D / DisplayPort on board
<b>Ethernet</b>	1x RJ45 connector	2x RJ45 connector	2x RJ-45 connector	2x RJ45 connector
<b>Audio</b>	Built-in ALC662 or ALC888S HD audio codec	Built-in ALC662 or ALC888S HD audio codec	Built-in ALC662 or ALC888S HD audio codec	Built-in ALC662 or ALC888S HD audio codec
<b>SATA</b>	2x SATA III	2x SATA III	2x SATA III	2x SATA III
<b>I/O Chipset</b>	Fintek F81846D-I	Fintek F81964D-I	Fintek F81964D-I	Fintek F81964D-I
<b>Parallel Port</b>	N/A	N/A	1x Parallel port	1x Parallel port
<b>Serial Port</b>	5x COM ports (4 ports via rear I/O, 1-port via pin header)	4x COM ports (4 ports via rear I/O, 2-ports via pin header)	2x COM ports	4x COM ports
<b>USB 2.0</b>	2x USB 3.0 via rear I/O 2x USB 2.0 (2 port via onboard vertical, 1 port share with micro USB)	4x USB 2.0 (4 ports via rear I/O)	4x USB 2.0	4x USB 2.0 (2 ports via rear I/O, 2 ports via onboard pin header, 1 port share with micro USB)
<b>USB 3.X</b>	2x USB 3.0 via rear I/O	2x USB 3.0 via rear I/O	4x USB 3.0 via rear I/O	2x USB 3.0 via rear I/O
<b>KB / MS</b>	N/A	1x KB/MS connector	N/A	N/A
<b>Hardware Monitor</b>	Yes	Yes	Yes	Yes
<b>Watchdog Timer</b>	256 levels	256 levels	256 levels	256 levels
<b>Expansion slots</b>	4x PCI-E(x1) slots 1x Mini PCI-E sockets (full-size)	1x PCI-E(x1) slot 2x Mini PCI-E sockets (full-size & half-size)	1x PCIx16 slot 5x PCI-Ex1 slots 2x Mini PCI-E sockets	1x PCI-E(x1) slot 1x M.2 (B Key) socket
<b>Digital I/O</b>	4-in/4-out	4-in/4-out	4-in/4-out	4-in/4-out
<b>Power Connector</b>	2x 2-pin connector for DC-in 12V only	2x 2-pin connector for DC-in 12V only	20+4-pin connector for ATX or DC-in 12V only	2x 2-pin connector for DC-in 12V only
<b>Dimensions (L x W)</b>	244mm x 244mm (9.6"x9.6")	170mm x 170mm (6.7"x6.7")	305mm x 244mm (12"x 9.6")	170mm x 170mm (6.7"x6.7")
<b>Extra Features</b>	Compatible with IBQ800	Compatible with ET875	Compatible with ET976 / ET977	Compatible with ET870
<b>Page No.</b>	P.1-22	P.1-21	P.1-20	P.1-19

1 CPU Modules

2 Single Board Computers

3 Motherboards

4 CPU Cards

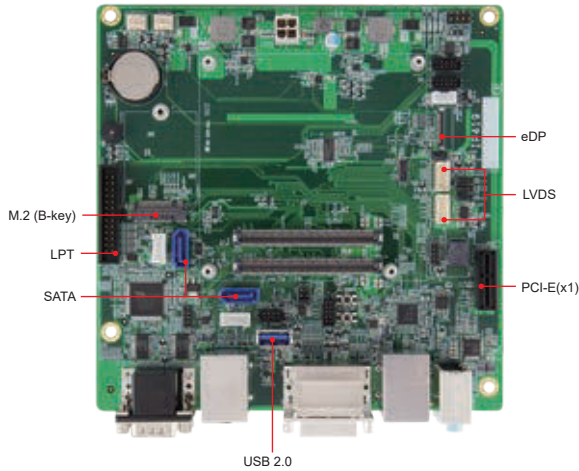

## Features

- Supports 4x USB 2.0, 3x USB 3.0, 2x SATA III
- 1x PCI-E(x1) slot, 1x M.2 socket
- 1x eDP or 1x LVDS, 1x DisplayPort, 1x DVI-D
- 2x LAN connectors

## I/O View

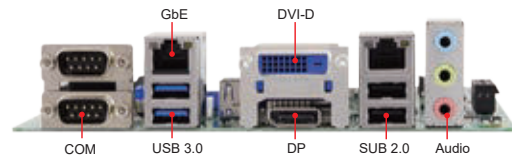

## Specifications

Form Factor	Mini-ITX
Module Interface	COM Express Type-6 (R3.0)
Expansions slots	1x PCI-E(x1) slot 1x M.2 socket
Mini Type Slots	N/A
Video Output	2x DDI (1x DisplayPort 1x DVI-D) 1x LVDS or 1x eDP (By option) 1x 18/24-bit dual-channel LVDS or 1x eDP (option)
Ethernet	LAN1: Derived from COM Express CPU module LAN2: 1x Intel® I210IT
I/O Chipset	Fintek F81964D-I
Serial Port	4x COM ports -2x COM ports (from Super I/O) -2x COM ports (from CPU module, TX/RX)
USB 2.0	Derived from COM Express module 4x USB 2.0, (one port for OTG)
USB 3.X	2x USB 3.0
Serial ATA	Deried from COM Express module 2x SATA III
Audio	Built-in ALC662 or ALC888S HD audio codec
Digital I/O	4-in/4-out
Watchdog	256 levels
KB/MS	N/A
Parallel	1x Parallel port via box header
Dimensions (L X W)	170 mm x 170 mm (6.7" x 6.7")
Power	DC-in (12V) 2x 2-pin connector for 12V DC power-in
Operating Temperature	-20°C~70°C (-4°F~-94°F)
Storage Temperature	-40°C~90°C (-40°F~194°F)
Relative Humidity	10% ~ 90% (non-condensing)

## Ordering Information

IP419	Mini-ITX COM Express Type-6 carrier board, Supports LVDS or eDP
-------	---

## Dimensions and Drawing

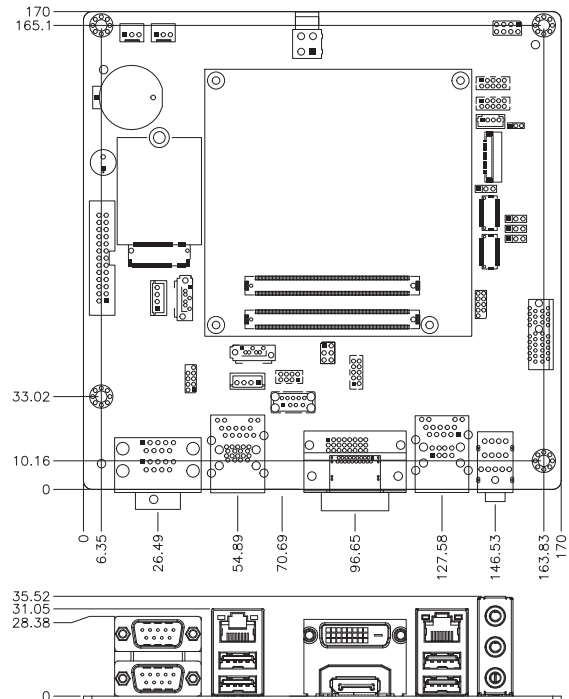

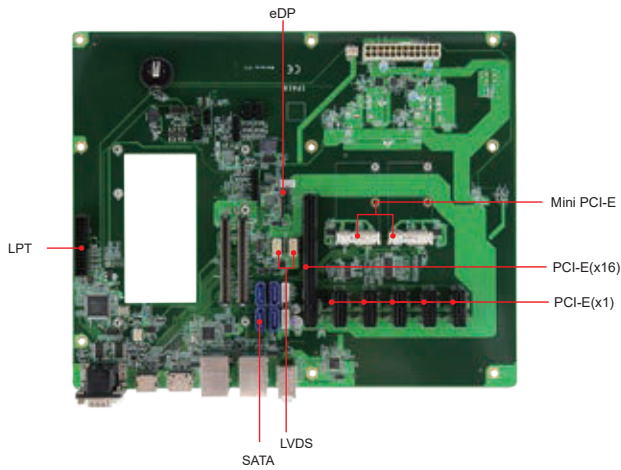

## Features

- ATX form factor with PICMG COM.0 R3.0 Type-6 pin-out
- Supports 1x VGA, 1x DisplayPort, 1x HDMI, 1x DVI-D
- Supports 1x eDP or 1x LVDS
- 1x PCI-E (x16), 5x Mini-PCI-E(x1), 2x Mini PCI-E sockets
- ATX power connector / DC-in (12V only)

## I/O View

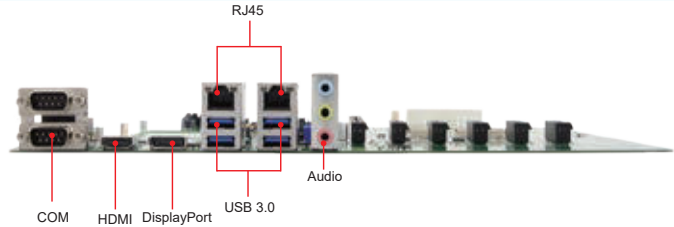

## Specifications

Form Factor	ATX
Module Interface	COM Express Type-6 (R3.0)
Expansions slots	1x PCI-E(16x) slot 5x PCI-E(1x) slot
Mini Type Slots	2x MiniPCI-E socket
Video Output	1x VGA 3x DDI (1xDisplayPort, 1x HDMI, 1x DVI-D) 1x dual channel LVDS or 1x eDP (Depends on CPU module)
Ethernet	LAN1: Derived from COM Express CPU module LAN2: 1x Intel® I210IT
I/O Chipset	Fintek F81964D-I
Serial Port	2x COM ports (RS232)
USB 2.0	4x USB 2.0
USB 3.X	4x USB 3.0
Serial ATA	Derived from COM Express CPU module 4x SATA III
Audio	Built-in ALC662 or ALC888S HD audio codec
Digital I/O	4-in/4-out
Watchdog	256 levels
KB/MS	N/A
Parallel	1x Parallel port via box header
Dimensions (L X W)	305mm x 244mm (12" x 9.6")
Power	ATX/ DC-IN 12V (only) 20+4-pin connector for ATX 2x 2-pin connector for 12V DC power-in (IP418-DC only)
Operating Temperature	-40°C~85°C (-40°F~185°F)
Storage Temperature	-40°C~90°C (-40°F~194°F)
Relative Humidity	10% ~ 90% (non-condensing)

## Ordering Information

IP418	COM Express Type-6 carrier board, supports ATX
IP418-DC	COM Express Type-6 carrier board, supports DC-in

## Dimensions and Drawing

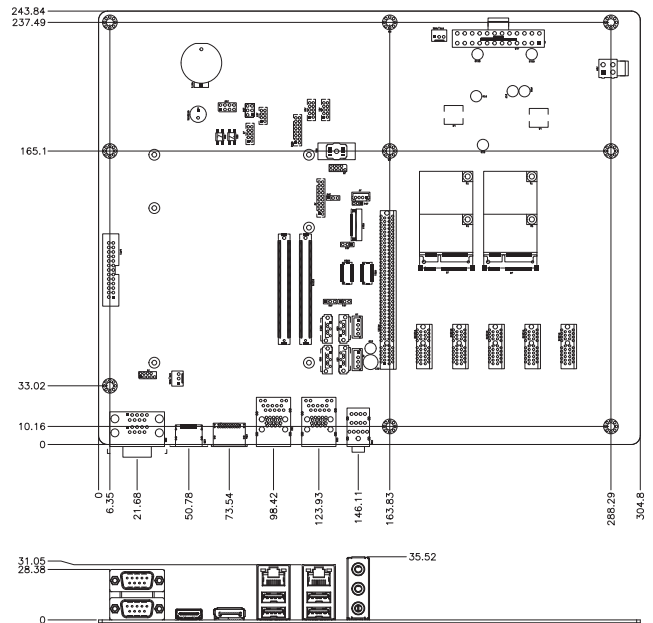

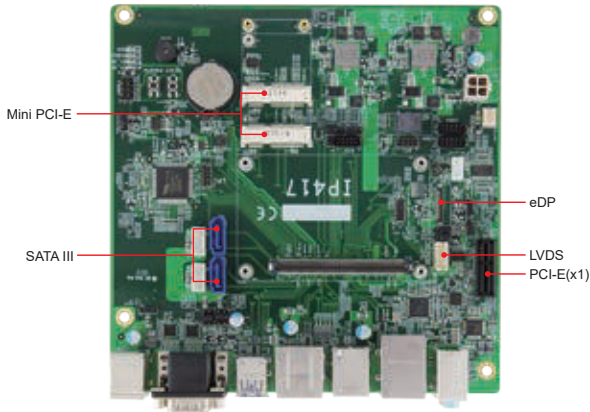

## Features

- 1x PCI-E (x1), 2x Mini PCI-E sockets (full-size & half-size)
- 8x USB 2.0, 2x USB 3.0
- Supports 1x eDP or 1x LVDS(based on COMe module), 1x DisplayPort
- 2x LAN connectors

## I/O View

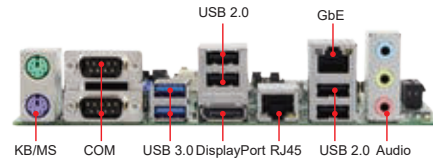

## Specifications

Form Factor	Mini ITX
Module Interface	COM Express Type-10 (R3.0)
Expansions slots	1x PCI-E(x1) slot
Mini Type Slots	1x MiniPCI-E socket (full-size) 1x MiniPCI-E socket (half-size)
Video Output	1x DisplayPort 1x LVDS or 1 x eDP (By option)
Ethernet	LAN1: Derived from COM Express CPU module LAN2: 1x Intel I210IT
I/O Chipset	Fintek F81846D-1
Serial Port	2x COM ports (RS232)
USB 2.0	8x USB 2.0
USB 3.X	2x USB 3.0
Serial ATA	2x SATA III
Audio	Built-in ALC662 or ALC888S HD audio codec
Digital I/O	4-in/4-out
Fan Connector	1x 3-pin
Watchdog	256 levels
KB/MS	Yes
Dimensions (L X W)	170mm x 170mm (9.6" x 9.6")
Power	DC-in 12V only
Operating Temperature	-40°C~85°C (-40°F~185°F)
Storage Temperature	-40°C~90°C (-40°F~194°F)
Relative Humidity	10%~90% (non-condensing)

## Ordering Information

IP417	COM Express Type-10 carrier board, supports eDP or LVDS
-------	---

## Dimensions and Drawing

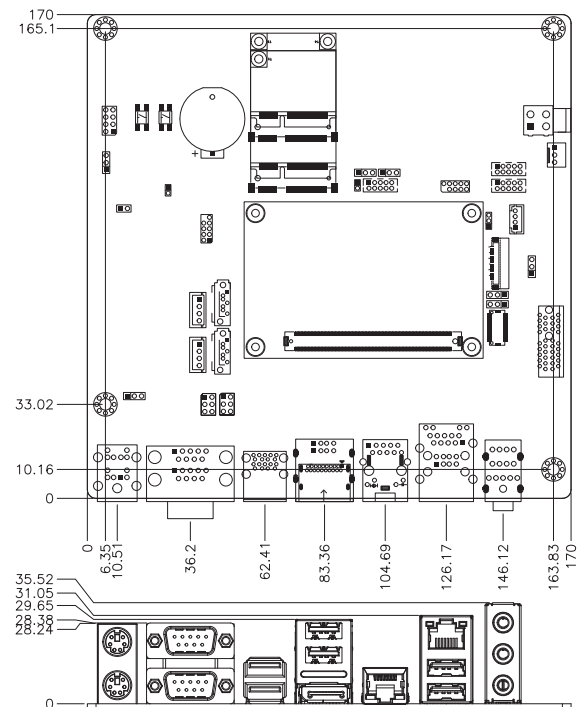



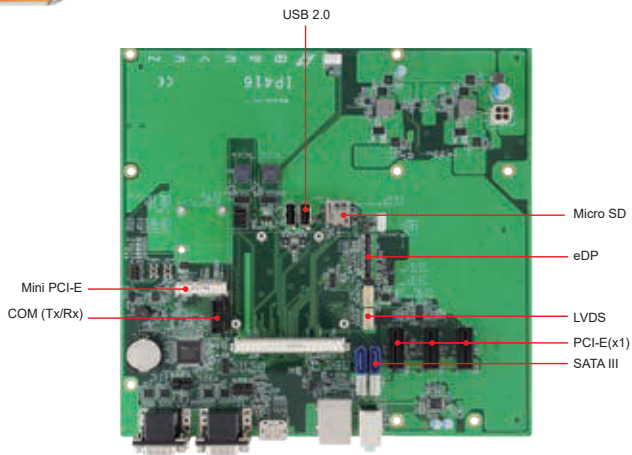

## Features

- 2x USB 2.0, 2x USB 3.0
- 3x PCI-E(x1) slots, 1x MiniPCI-E socket (full-size)
- Supports 1x eDP or 1x LVDS, 1x DisplayPort
- 1x LAN, 1x Micro SD

## I/O View

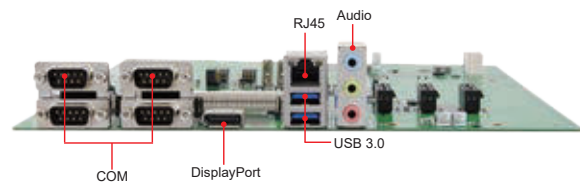

## Specifications

Form Factor	Micro ATX
Module Interface	Qseven CPU Module (R2.1)
Expansion Slots	3x PCI-E(x1) slot
Mini Type Slots	1x MiniPCI-E socket (full-size, reserved one hole for half-size)
Video Output	1x DisplayPort, 1x LVDS or 1x eDP (By option)
Ethernet	LAN: Derived from Qseven CPU module
I/O Chipset	Fintek F81846D-I
Serial Port	4x COM RS232 & 1x COM (Tx/Rx only) from Qseven module
USB 2.0	2x USB 2.0
USB 3.X	2x USB 3.0
Serial ATA	2x SATA III
Audio	Built-in ALC662 or ALC888S HD audio codec
Digital I/O	4-in/4-out
Watchdog	256 levels
KB/MS	Yes
Parallel	N/A
Dimensions (L X W)	244mm x 244mm (9.6" x 9.6")
Power	DC-in 12V
Operating Temperature	-40°C~85°C (-40°F~185°F)
Storage Temperature	-40°C~90°C (-40°F~194°F)
Relative Humidity	10% ~ 90% (non-condensing)

## Ordering Information

IP416	Micro ATX Qseven carrier board
-------	--------------------------------

## Dimensions and Drawing

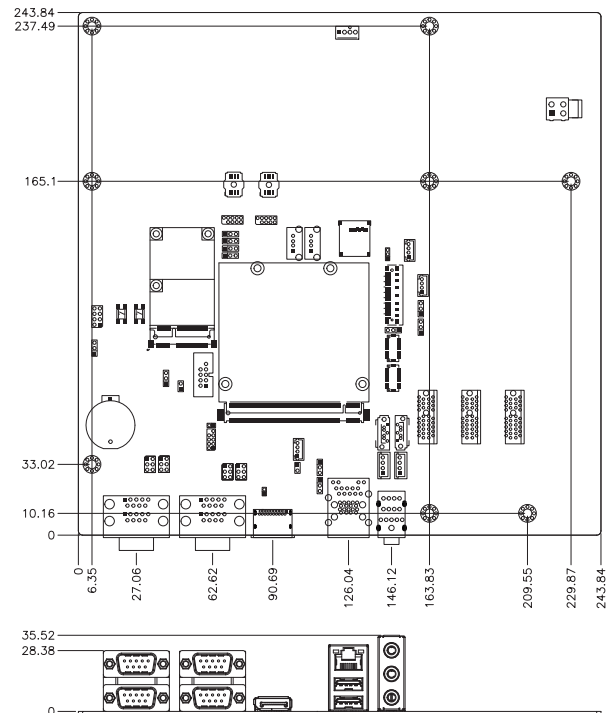

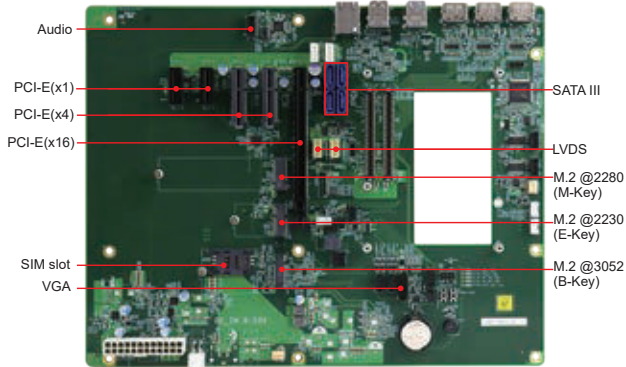

## Features

- 1x PCI-E(x16), 2x PCI-E(x4), 2x PCI-E(x1) expansion slots
- 1x RJ45, 3x DP, 3x dual USB 2.0 (1x M.2 E-key, 1x Type-A, 1x via box headers), 3x dual USB 3.2
- 2x COM via onboard box-headers (RS232 only)
- ATX power connector / DC-in (+8V ~ +20V)

## I/O View

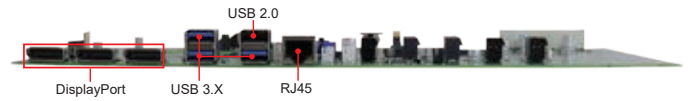

## Specifications

Form Factor	ATX
Module Interface	COM Express Type-6
Expansion Slots	1x PCI-E(x16) slot [up to Gen.5] 2x PCI-E(x4) slot 2x PCI-E(x1) slot
Mini Type Slots	1x M.2 (B3052) 1x M.2 (M2080) 1x M.2 (E2230)
Video Output	3x DisplayPort 1x VGA 1x 24-bit dual-channel LVDS 1x eDP
Ethernet	Derived from COM Express CPU module
I/O Chipset	Fintek F81946D-I
Serial Port	COM ports x2 via onboard box-headers (RS232 only) - 2x COM ports (from onboard Super I/O) - 2x COM ports (from CPU module, Tx/Rx only)
USB 2.0	Derived from COM Express module 3x USB2.0 (1 for Type-A, 2x via box headers)
USB 3.X	3x USB 3.2 Type-A connectors @edge I/O
Serial ATA	Derived from COM Express CPU module 4x SATA III
Audio	Built-in ALC888-S HD audio codec
Digital I/O	4-in/4-out
Watchdog	256 levels
KB/MS	Yes
Parallel	N/A
Dimensions (L X W)	305mm x 244mm (12" x 9.6")
Power	20+4-pin connector for ATX (IP414) 2x 2-pin connector for DC power-in (IP414-DC only)
Operating Temperature	0°C~60°C (32°F~140°F)
Storage Temperature	-20°C~80°C (-4°F~176°F)
Relative Humidity	10% ~ 90% (non-condensing)

## Ordering Information

IP414	ATX COM Express Type-6 carrier board, supports ATX
IP414-DC	ATX COM Express Type-6 carrier board, supports DC-in (+8V ~ +20V)

## Dimensions and Drawing

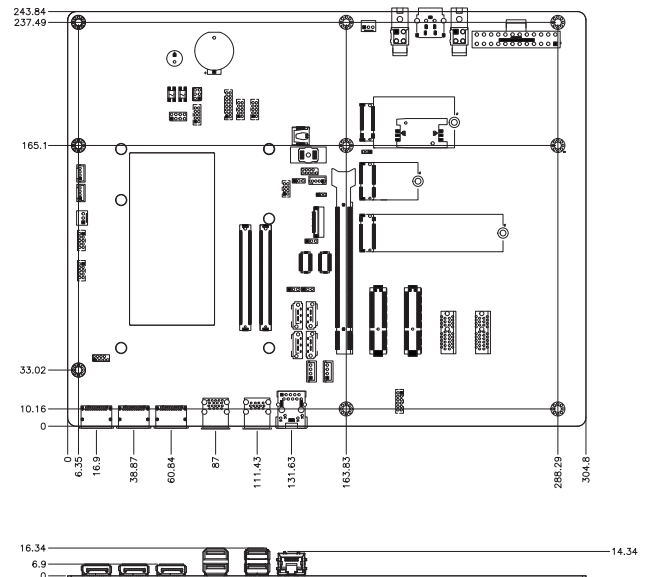

1 CPU Modules

2 Single Board Computers

3 Motherboards

4 CPU Cards

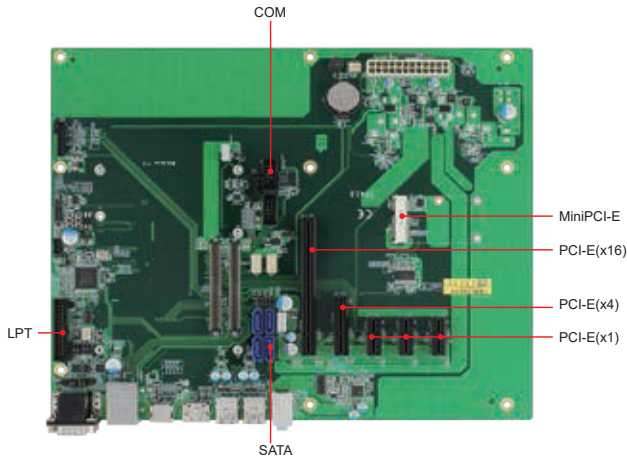

## Features

- 1x PCI-E(x16), 1x PCI-E(x4), 3x PCI-E(x1) expansion slots
- Edge connectors for dual COM, RJ45+ 1x dual USB (2.0), 1x DP, 1x HDMI, 2x dual USB 3.0, audio connector (Line-out, Line-in & Mic.)
- Onboard headers for 2x COM (from COMe module), 1x KB/MS, 2x USB (2.0), DVI-D, CRT, LVDS, 4x SATA III, 1x LPT, COM Express (Type-6) connectors
- ATX power connector / DC-in (12V only)

## I/O View

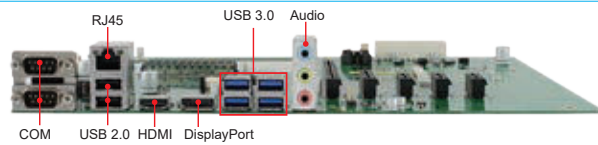

## Specifications

Form Factor	ATX
Module Interface	COM Express Type-6
Expansion Slots	1x PCI-E(x16) slot 1x PCI-E(x4) slot 3x PCI-E(x1) slots
Mini Type Slots	1x MiniPCI-E socket (full-size, reserved one hole for half-size)
Video Output	1x VGA 3x DDI (1x DisplayPort, 1x DVI-D, 1x HDMI) 1x 18/24-bit dual-channel LVDS
Ethernet	Derived from COM Express CPU module
I/O Chipset	Fintek F81846D-I
Serial Port	4x COM ports -2x COM ports (from Super I/O) -2x COM ports (from CPU module, TX/RX)
USB 2.0	Derived from COM Express module 4x USB 2.0
USB 3.X	4x USB 3.0
Serial ATA	Derived from COM Express CPU module 4x SATA III
Audio	Built-in ALC662 or ALC888S HD audio codec
Digital I/O	4-in/4-out
Watchdog	256 levels
KB/MS	Yes
Parallel	1x Parallel port via box header
Dimensions (L X W)	305mm x 244mm (12" x 9.6")
Power	ATX / DC-in 12V (only) 20+4-pin connector for ATX 2x 2-pin connector for 12V DC power-in (IP413-DC only)
Operating Temperature	0°C~60°C (32°F~140°F)
Storage Temperature	-20°C~80°C (-4°F~176°F)
Relative Humidity	10% ~ 90% (non-condensing)

## Ordering Information

IP413	ATX COM Express Type-6 carrier board, Supports ATX
IP413-DC	ATX COM Express Type-6 carrier board, Supports DC-in

## Dimensions and Drawing

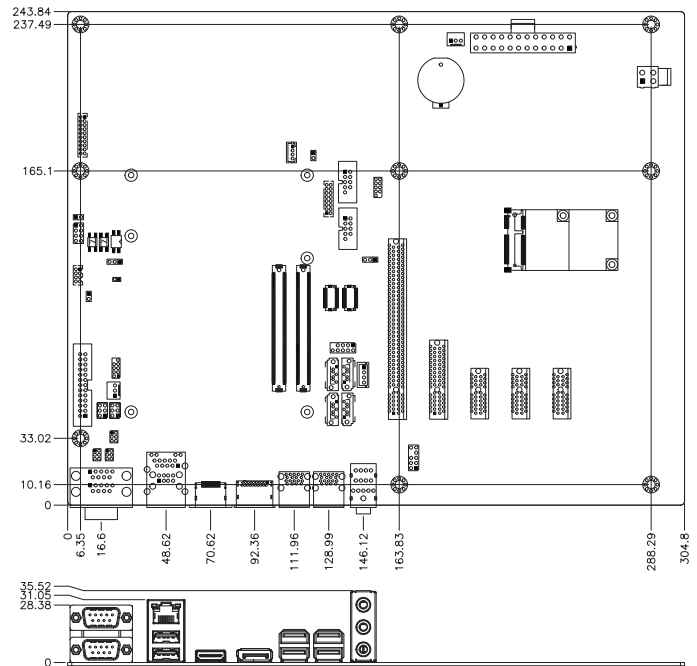

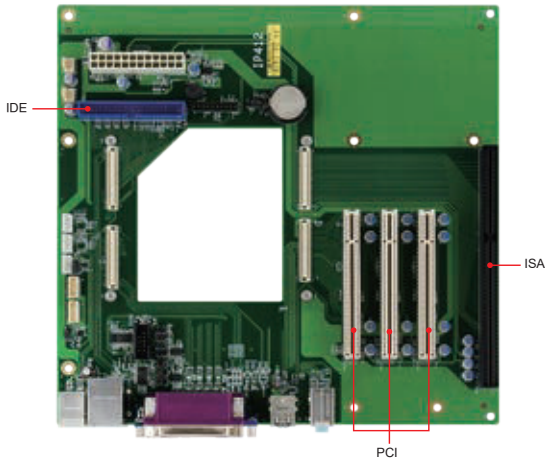

## Features

- Supports 1x ISA, 3x PCI expansion slots
- Edge connector for PS/2 keyboard & mouse, RJ45 + dual USB (2.0), COM, VGA, printer port, dual USB 2.0, audio connector (Line-out, Line-in & Mic.)
- Onboard header for COM, LVDS, IDE, ETX connectors

## I/O View

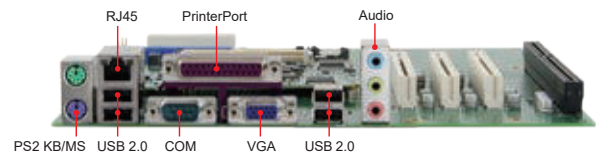

## Specifications

Form Factor	Micro ATX
Module Interface	ETX (3.0)
Expansion Slots	3x PCI slot 1x ISA slot
Mini Type Slots	N/A
Video Output	Derived from ETX module 1x CRT 1x 18/24-bit dual-channel LVDS
Ethernet	Derived from ETX module for 10/100 LAN
I/O Chipset	N/A
Serial Port	1x DB-9 connector for COM1 (RS232/422/485) 1x pin header for COM2 (RS232 only)
USB 2.0	Derived from ETX module 4x USB 2.0
USB 3.X	N/A
Serial ATA	N/A
Audio	Derived from ETX module Via audio jack for AC97 out
Digital I/O	4-in/4-out
Watchdog	256 levels
KB/MS	PS/2 KB/MS stack connector
Parallel	1x Parallel port connector
Dimensions (L X W)	244mm x 244mm (9.6" x 9.6")
Power	20+4-pin connector for ATX
Operating Temperature	0°C~60°C (32°F~140°F)
Storage Temperature	-20°C~80°C (-4°F~176°F)
Relative Humidity	10% ~ 90% (non-condensing)

## Ordering Information

IP412	Micro ATX ETX (3.0) carrier board
-------	-----------------------------------

## Dimensions and Drawing

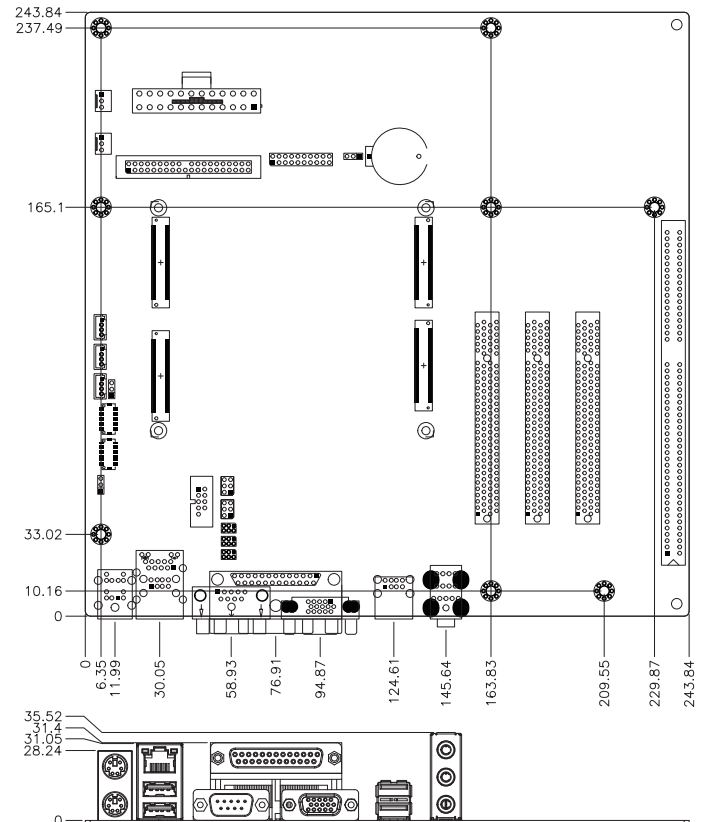

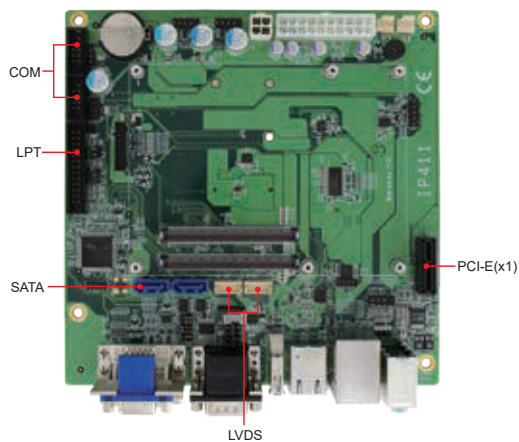

## Features

- Mini-ITX COM Express carrier board for compact-size COMe module
- Supports DVI-D, VGA, 24-bit dual-channel LVDS
- 4x COM, 1x printer port, 1x USB 3.0, 8x USB 2.0, 2x SATA III
- Onboard dual Gigabit LAN
- 1x PCI-E(x1)

## I/O View

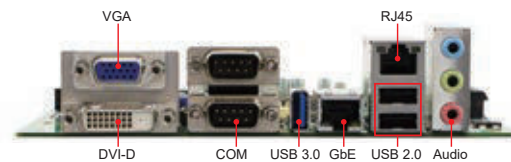

## Ordering Information

IP411	Mini-ITX COM Express Type-6 carrier board
-------	---

## Dimensions and Drawing

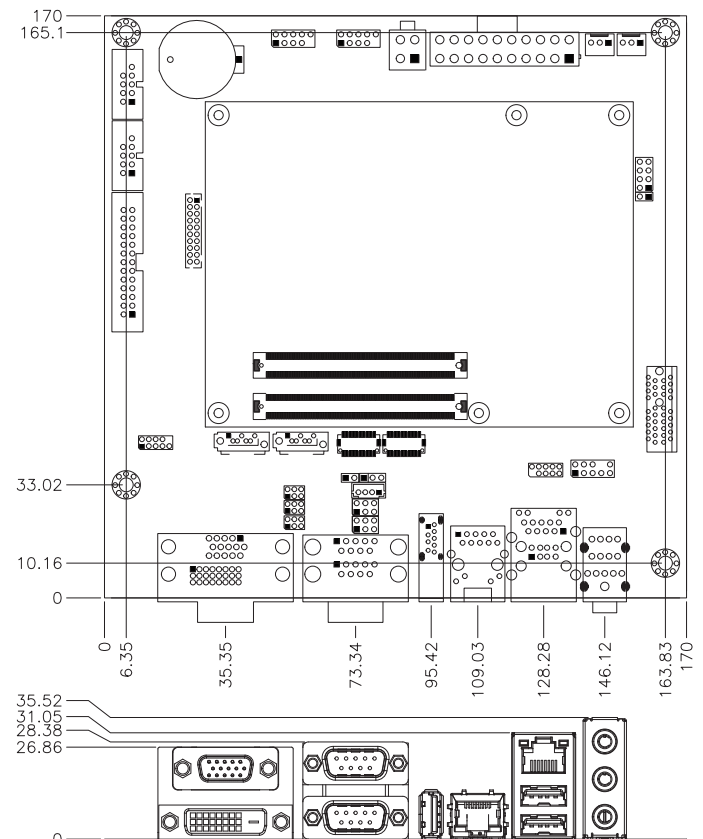

## Specifications

Form Factor	Mini-ITX
Module Interface	COM Express Type-6
Expansion Slots	1x PCI-E(x1) slot
Mini Type Slots	N/A
Video Output	1x VGA 2x DDI (1 x DVI-D, 1 x DVI-D shared with LVDS) 1x 18/24-bit dual-channel LVDS
Ethernet	Derived from COM Express CPU module as GbE #1 Intel® I210IT Gigabit LAN x 1 as GbE #2
I/O Chipset	Fintek F81846AD-I
Serial Port	4x COM ports 2x COM ports (from Super I/O) 2x COM ports (from CPU module, TX/RX)
USB 2.0	Derived from COM Express CPU module 8x USB 2.0
USB 3.X	1x USB 3.0
Serial ATA	Derived from COM Express CPU module 2x SATA III
Audio	Built-in ALC662 or ALC888S HD audio codec
Digital I/O	4-in/4-out
Watchdog	256 levels
KB/MS	Yes
Parallel	1x Parallel port via pin header
Dimensions (L X W)	170mm x 170mm (6.7" x 6.7")
Power	20+4pins connector for ATX
Operating Temperature	0°C~60°C (32°F~140°F)
Storage Temperature	-20°C~80°C (-4°F~176°F)
Relative Humidity	10% ~ 90% (non-condensing)



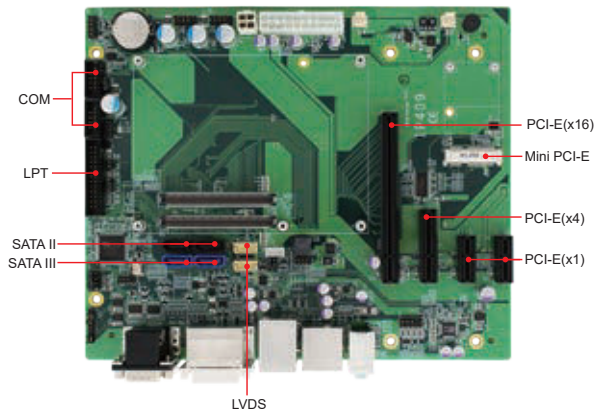

## Features

- Supports Fintek F81846AD-I Super I/O
- 1x PCI-E(x16), 1x PCI-E(x4), 2x PCI-E(x1), 1x MiniPCI-E socket (full-size)
- Edge connectors for 2x COM (from onboard Super I/O), DVI-I, DVI-D, RJ45+ dual USB 3.0, DisplayPort + dual USB 3.0, audio connector (Line-out, Lin-in & Mic.)
- Onboard headers for 2x COM (from COMe module), 1x KB/MS, 2x SATA III, 2x SATA II, 2x LVDS, 4x USB 2.0

## I/O View

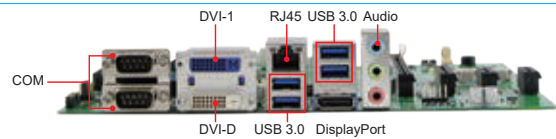

## Specifications

Form Factor	Flex ATX
Module Interface	COM Express Type-6
Expansion Slots	1x PCI-E(x16) slot 1x PCI-E(x4) slot 2x PCI-E(x1) slot
Mini Type Slots	1x MiniPCI-E socket (full-size, reserved one hole for half-size)
Video Output	1x VGA 3x DDI (1 x DVI-D, 1 x DVI-I, 1 x DisplayPort) 1x 18/24-bit dual-channel LVDS
Ethernet	Derived from COM Express CPU module
I/O Chipset	Fintek F81846D-I
Serial Port	4x COM ports 2x COM from super I/O (RS232) 2x COM from CPU module (TX/RX)
USB 2.0	4x USB 2.0
USB 3.X	4x USB 3.0
Serial ATA	Derived from COM Express module 2x SATA III 2x SATA II
Audio	Built-in ALC662 or ALC888S HD audio codec
Digital I/O	4-in/4-out
Watchdog	256 levels
KB/MS	N/A
Parallel	1x Parallel port via pin header
Dimensions (L X W)	190mm x 228mm (7.5"x 9.0")
Power	20+4pins connector for ATX
Operating Temperature	0°C~60°C (32°F~140°F)
Storage Temperature	-20°C~80°C (-4°F~176°F)
Relative Humidity	10% ~ 90% (non-condensing)

## Ordering Information

IP409

Flex ATX COM Express Type-6 carrier board

## Dimensions and Drawing

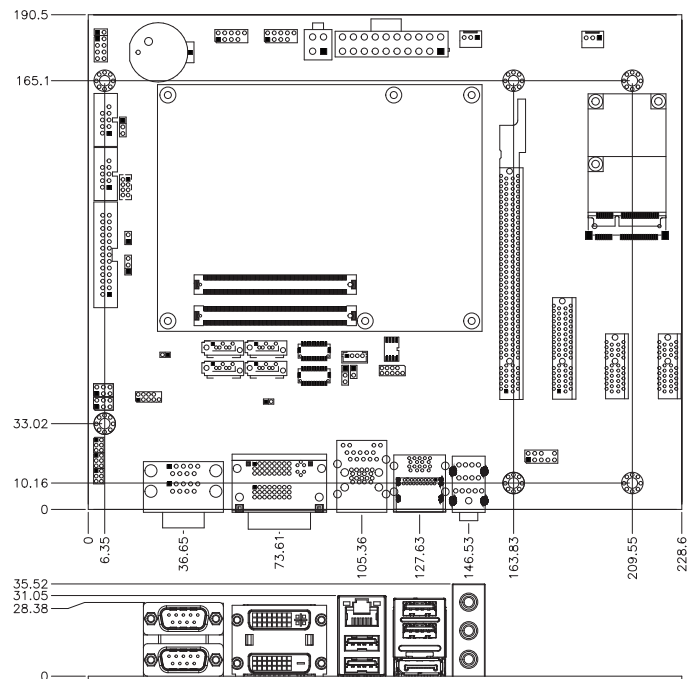

# Comparison Table

## 3.5" Single Board Computer

Models	IB811	IB818	IB822
<b>Form Factor</b>	3.5" SBC	3.5" SBC	3.5" SBC
<b>CPU Socket</b>	CPU on board	CPU on board	CPU on board
<b>CPU</b>	Intel® Atom® Processor E3950/E3930 Intel® Pentium® Processor N4200 Intel® Celeron® Processor N3350	Intel® Atom® Processor E3950/E3930 Intel® Pentium® Processor N4200 Intel® Celeron® Processor N3350	Intel® Pentium® Silver processor
<b>CPU Max. Frequency</b>	up to 2.0GHz/ 1.8GHz/ 2.5GHz/ 2.4GHz	up to 2.0GHz/ 1.8GHz/ 2.5GHz/ 2.4GHz	up to 2.8GHz
<b>PCH</b>	N/A	N/A	N/A
<b>Memory</b>	2x DDR3L SO-DIMM	1x DDR3L SO-DIMM	2x DDR4 SO-DIMM
<b>Max. Memory Size</b>	8GB	8GB	8GB
<b>BIOS</b>	AMI	AMI	AMI
<b>Graphics Controller</b>	Intel® Gen9-LP w/ 18 EUs graphics	Intel® Gen9-LP w/ 18 EUs graphics	Intel® UHD Graphics 605
<b>Video Output</b>	24-bit dual-channel LVDS or eDP HDMI & DisplayPort on board	18/24-bit dual-channel LVDS HDMI on board	18/24-bit dual-channel LVDS or eDP HDMI / DisplayPort on board
<b>Ethernet</b>	2x Intel® I210IT Gigabit LAN or 2x Intel® I211AT or I210AT Gigabit LAN	2x Intel® I210IT Gigabit LAN or 1x Intel® I210AT Gigabit LAN	2x Intel® I211AT or I210AT Gigabit LAN
<b>Audio</b>	Built-in ALC888S HD audio codec with 2W amplifier	Built-in ALC888S HD audio codec with 2W amplifier	Built-in ALC233-VB2-CG HD audio codec
<b>SATA</b>	2x SATA III ports	2x SATA III ports	2x SATA III ports
<b>I/O Chipset</b>	F81946D-I	F81946D-I	F81964D-I
<b>Serial Port</b>	3x RS232 1x RS232/422/485 (jumper-less selection)	3x RS232 1x RS232/422/485 (jumper-less selection)	3x RS232 1x RS232/422/485 (jumper-less selection)
<b>USB 2.0</b>	2x USB 2.0 via pin header	2x USB 2.0 ports via pin header	2x USB 2.0 via pin header
<b>USB 3.X</b>	4x USB 3.0 via rear I/O	4x USB 3.0 ports on board	4x USB 3.0 on board
<b>Hardware Monitor</b>	Yes	Yes	Yes
<b>TPM</b>	N/A	N/A	N/A
<b>Storage Device Interface</b>	mSATA via Mini PCI-E	mSATA via Mini PCI-E	N/A
<b>Watchdog Timer</b>	256 levels	256 levels	256 levels
<b>Digital I/O</b>	4-in / 4-OUT	4-in/4-out	4-in/4-out
<b>Mini Type Slots</b>	1x Mini PCI-E(x1), 1x M.2(B-key)	2x Mini PCI-E(x1)	1x PCI-E(x1) 1x M.2 (B-key), 1xM.2 (E-key)
<b>Power input</b>	DC-in 9V~36V	DC-in 12V~24V	DC-in 12V~24V
<b>Power Consumption</b>	Intel® Atom® E3900 1.3GHz w/ 2x Transcend DDR3L 1600 4GB +12V: 1.2A	Intel® Atom® E3950, 1.6GHz w/ 8GB DDR3L +12V: 1.09A, Intel® Pentium® N4200, 1.1GHz w/ 8GB DDR3L +12V: 1.09A	Intel® Celeron® J4005 2.0GHz w/ 2x 8GB DDR4-2133 +12V: 1.58A
<b>Dimensions (L x W)</b>	147mm x 102mm	147mm x 102mm	102mm x 147mm
<b>Extra Features</b>	LAN Wakeup, Eup / Erp	LAN Wakeup, Eup / Erp	iSMART 3.5
<b>Page No.</b>	P2-24	P2-23	P2-22

1 CPU Modules

2 Single Board Computers

3 Motherboards

4 CPU Cards

# Comparison Table

## 3.5" Single Board Computer

Models	IB836	IB837	IB838
<b>Form Factor</b>	3.5" SBC	3.5" SBC	3.5" SBC
<b>CPU Socket</b>	CPU on board	CPU on board	CPU on board
<b>CPU</b>	Intel® Atom® Processor x6211E Intel® Atom® Processor x6413E Intel® Atom® Processor x6425E	Intel® Celeron QC J6412 Intel® Celeron QC N6210	Intel® Core i3-N305 Intel® Processor N50
<b>CPU Max. Frequency</b>	Up to 3.0GHz	Up to 2.6GHz	Up to 3.8GHz
<b>PCH</b>	N/A	N/A	N/A
<b>Memory</b>	2x DDR4 SO-DIMM	1x DDR4 SO-DIMM	2x DDR5 SO-DIMM
<b>Max. Memory Size</b>	64GB	16GB	16GB
<b>BIOS</b>	AMI	AMI	AMI
<b>Graphics Controller</b>	Intel® Gen11-LP w/ 32 EUs graphics	Intel® Gen11 w/ 32 EUs graphics	Intel® Gen12-AL w/ 32 EUs graphics
<b>Video Output</b>	24-bit dual-channel LVDS or eDP 2x DisplayPort on board	2x 24-bit dual-channel LVDS 1x DisplayPort on board	24-bit dual-channel Type-C & DP++ and eDP or LVDS 1x DisplayPort on board
<b>Ethernet</b>	3x Intel® I225IT 2.5G LAN or 3x Intel® I225V 2.5G LAN (based on CPU SKU)	2x Intel® I226V Gigabit LAN	2x Intel® I226V Gigabit LAN
<b>Audio</b>	Built-in ALC888S HD audio codec with 2W amplifier	Built-in ALC888S HD audio codec with 2W amplifier	Built-in ALC888S HD audio codec with 2W amplifier
<b>SATA</b>	2x SATA III ports	1x SATA III ports	1x SATA III ports
<b>I/O Chipset</b>	F81946D-I	F81966D-I	F81964D-I
<b>Serial Port</b>	3x RS232 1x RS232/422/485 (jumper-less selection)	5x RS232 1x RS232/422/485	3x RS232 1x RS232/422/485
<b>USB 2.0</b>	2x USB 2.0 via pin header	2x USB 2.0 via pin header	2x USB 2.0 via pin header
<b>USB 3.X</b>	3x USB 3.1 via rear I/O 1x USB 3.1 via Type-C	4x USB3.1 Type-A	1x Type-C 3x Type-A
<b>Hardware Monitor</b>	Yes	Yes	Yes
<b>TPM</b>	2.0	fTPM	fTPM
<b>Storage Device Interface</b>	mSATA via Mini PCI-E	mSATA via Mini PCI-E	M.2 SSD via B-key
<b>Watchdog Timer</b>	256 levels	256 levels	256 levels
<b>Digital I/O</b>	4-in / 4-OUT	4-in / 4-OUT	4-in / 4-OUT
<b>Mini Type Slots</b>	1x Mini PCI-E(x1), 1x M.2(E-key)	1x Mini PCI-E(x1), 1x M.2(E-key), 1x M.2(B-key)	1x M.2(E-key), 1x M.2(B-key)
<b>Power input</b>	DC-in 9V~36V	DC-in 12V	DC-in 9V~36V
<b>Power Consumption</b>	Intel® Atom® x6425E Processor w/ 2x 16GB DDR4-3200 +12V:1.93A	Intel® Celeron® J6412 2.00GHz w/ 8GB DDR4-3200 +12V:1.57A	TBD
<b>Dimensions (L x W)</b>	147mm x 102mm	147mm x 102mm	147mm x 102mm
<b>Extra Features</b>	LAN Wakeup, Eup / Erp	LAN Wakeup, Eup / Erp	LAN Wakeup, Eup / Erp
<b>Page No.</b>	P2-21	P2-20	P2-19

1

CPU Modules

2

Single Board Computers

3

Motherboards

4

CPU Cards

# Comparison Table

## 3.5" Single Board Computer

Models	IB897	IB898	IB899
<b>Form Factor</b>	3.5" SBC	3.5" SBC	3.5" SBC
<b>CPU Socket</b>	CPU on board	CPU on board	CPU on board
<b>CPU</b>	Intel® Atom® Processor E3845/E3827/E3815	Intel® Atom® Processor E3825/E3815	Intel® Pentium® Processor N3710 / Intel® Celeron® Processor N3010
<b>CPU Max. Frequency</b>	1.91GHz / 1.75GHz / 1.46GHz	1.33GHz / 1.46GHz	Up to 2.56GHz/ 2.24GHz
<b>PCH</b>	N/A	N/A	N/A
<b>Memory</b>	2x DDR3L SO-DIMM	1x DDR3L SO-DIMM	2x DDR3L SO-DIMM
<b>Max. Memory Size</b>	8GB	4GB	8GB
<b>BIOS</b>	AMI	AMI	AMI
<b>Graphics Controller</b>	Intel® Gen7 w/4EUs graphics	Intel® Gen7 w/ 4EUs graphics	Intel® Gen8 graphics
<b>Video Output</b>	24-bit dual-channel LVDS DisplayPort on board	24-bit dual-channel LVDS DisplayPort & VGA on board	24-bit dual-channel LVDS DVI-D & VGA on board
<b>Ethernet</b>	2x Intel® I210IT Gigabit LAN	1x Intel® I210IT Gigabit LAN	2x Intel® I211AT or I210AT Gigabit LAN
<b>Audio</b>	Built-in ALC269 HD audio codec 2W amplifier	Built-in ALC269 HD audio codec with integrated 2 amplifier	Built-in ALC888S HD audio codec
<b>SATA</b>	2x SATA II ports	2x SATA II ports	2x SATA III ports
<b>I/O Chipset</b>	NCT5523D	NCT5523D	NCT5523D
<b>Serial Port</b>	1x RS232 1x RS232/422/485 (Jumper-less selection)	1x RS232 1x RS232/422/485 (Jumper-less selection)	1x RS232 1x RS232/422/485 (Jumper-less selection)
<b>USB 2.0</b>	3x USB 2.0 (1x rear I/O + 2x via pin header)	3x USB 2.0 (1x rear I/O + 2x via pin header)	2x USB 2.0 (via pin header)
<b>USB 3.X</b>	1x USB 3.0 via rear I/O	1x USB 3.0 via rear I/O	4x USB 3.0 via rear I/O
<b>Hardware Monitor</b>	Yes	Yes	Yes
<b>TPM</b>	N/A	N/A	N/A
<b>Storage Device Interface</b>	mSATA via Mini PCI-E, MicroSD slot	mSATA via Mini PCI-E	mSATA via Mini PCI-E
<b>Watchdog Timer</b>	256 levels	256 levels	256 levels
<b>Digital I/O</b>	4-in/4-out	4-in/4-out	4-in/4-out
<b>Mini Type Slots</b>	2x Mini PCI-E(x1)	3x Mini PCI-E(x1)	2x Mini PCI-E(x1)
<b>Power input</b>	DC-in 9V~30V	DC-in 12V	DC-in 12V~24V
<b>Power Consumption</b>	Intel® Atom® E3827 @1.75GHz w/ 2x 2GB DDR3L-1600 +12V: 1.29A Intel® Atom® E3845 @1.91GHz w/ 2x 2GB DDR3L-1600 +12V: 1.57A	Intel® Atom® E3825 1.33GHz w/ 4GB DDR3L-1600 +12V: 0.65A	Intel® Pentium® N3700 1.6GHz w/ 2x 4GB DDR3L-1600 +12V : 1.5A
<b>Dimensions (L x W)</b>	147mm x 102mm	147mm x 102mm	147mm x 102mm
<b>Extra Features</b>	LAN Wakeup, ISMART	LAN Wakeup, ISMART	LAN Wakeup, ISMART
<b>Page No.</b>	P2-18	P2-17	P2-16

1 CPU Modules

2 Single Board Computers

3 Motherboards

4 CPU Cards

# Comparison Table

## 3.5" Single Board Computer

Models	IB915	IB916	IB917
<b>Form Factor</b>	3.5" SBC	3.5" SBC	3.5" SBC
<b>CPU Socket</b>	CPU on board	CPU on board	CPU on board
<b>CPU</b>	6th Gen Intel® Core™ U-Series processor	7th Gen Intel® Core™ U-Series processor	7th Gen Intel® Core™ U-Series processor
<b>CPU Max. Frequency</b>	Up to 3.4GHz	Up to 3.9GHz	Up to 3.9GHz
<b>PCH</b>	N/A	N/A	N/A
<b>Memory</b>	2x DDR3L SO-DIMM	2x DDR4 SO-DIMM	2x DDR4 SO-DIMM
<b>Max. Memory Size</b>	16GB	32GB	32GB
<b>BIOS</b>	AMI	AMI	AMI
<b>Graphics Controller</b>	Intel® Core™ i integrated HD GT2-520	Intel® Core™ U-Series processor integrated graphics	Intel® Core™ U-Series processor integrated graphics
<b>Video Output</b>	24-bit dual-channel LVDS & eDP DisplayPort on board	eDP/ HDMI / DisplayPort on board	24-bit dual-channel LVDS HDMI / DisplayPort on board
<b>Ethernet</b>	Intel® I219LM/V Gigabit LAN PHY Intel® I211AT or I210AT Gigabit LAN	IB916AF: Intel® I219LM LAN PHY IB916F: Intel® I219V LAN PHY Intel® I211AT or I210AT Gigabit LAN (as 2nd LAN)	IB917AF: Intel® I219LM LAN PHY IB917F: Intel® I219V LAN PHY Intel® I211AT or I210AT Gigabit LAN (as 2nd LAN)
<b>Audio</b>	Built-in ALC888S HD audio codec	Built-in ALC888S HD audio codec	Built-in ALC888S HD audio codec
<b>SATA</b>	2x SATA III ports	2x SATA III ports	2x SATA III ports
<b>I/O Chipset</b>	F81846AD-I	F81846AD-I	F81846AD-I
<b>Serial Port</b>	3x RS232 1x RS232/422/485 (jumper-less selection)	3x RS232 1x RS232/422/485 (jumper-less selection)	3x RS232 1x RS232/422/485 (jumper-less selection)
<b>USB 2.0</b>	2x USB 2.0 via pin header	2x USB 2.0 via pin header	2x USB 2.0 via pin header
<b>USB 3.X</b>	1x USB 3.1 Type-C + 4x USB 3.0 via rear I/O	4x USB 3.0 via rear I/O	4x USB 3.0 via rear I/O
<b>Hardware Monitor</b>	Yes	Yes	Yes
<b>TPM</b>	N/A	2.0	2.0
<b>Storage Device Interface</b>	mSATA via Mini PCI-E	mSATA via Mini PCI-E	mSATA via Mini PCI-E
<b>Watchdog Timer</b>	256 levels	256 levels	256 levels
<b>Digital I/O</b>	4-in/4-out	4-in/4-out	4-in/4-out
<b>Mini Type Slots</b>	1x Mini PCI-E(x1)	1x Mini PCI-E(x1)	1x Mini PCI-E(x1)
<b>Power input</b>	DC-in 9V~24V	DC-in 9V~24V	DC-in 9V~24V
<b>Power Consumption</b>	Intel® Core™ i3-6100U 2.3GHz w/ 2x DDR3L-1600 4GB +12V: 2.36A Intel® Core™ i7-6600U 2.6GHz w/ 2x DDR3L-1600 4GB +12V: 2.27A	Intel® i7-7300U, 2.6GHz w/ 8GB DDR4-2133, +12V: 2.06A, Intel® i3-7100U, 2.4GHz w/ 8GB DDR4-2133, +12V: 2.24A	Intel® i7-7600U, 2.8GHz w/ 8GB DDR4-2133, +12V: 3.46A Intel® i3-7100U, 2.4GHz w/ 8GB DDR4-2133, +12V: 2.68A
<b>Dimensions (L x W)</b>	147mm x 102mm	147mm x 102mm	147mm x 102mm
<b>Extra Features</b>	Built-in iAMT (11.0), RAID LAN Wakeup, iSMART	Built-in iAMT (11.0), RAID LAN Wakeup, iSMART	Built-in iAMT (11.0), RAID LAN Wakeup, iSMART
<b>Page No.</b>	P2-15	P2-14	P2-13

1

CPU Modules

2

Single Board Computers

3

Motherboards

4

CPU Cards



# Comparison Table

## 3.5" Single Board Computer

Models	IB918	IB919	IB952
<b>Form Factor</b>	3.5" SBC	3.5" SBC	3.5" SBC
<b>CPU Socket</b>	CPU on board	CPU on board	CPU on board
<b>CPU</b>	AMD Ryzen™ embedded V1000/R1000 series	8th Gen Intel® Core™ U-Series processor	AMD Ryzen™ Embedded V2000 series
<b>CPU Max. Frequency</b>	3.6GHz/ 2.3GHz	Up to 4.7GHz	Up to 4.15GHz
<b>PCH</b>	N/A	N/A	N/A
<b>Memory</b>	2x DDR4 SO-DIMM	2x DDR4 SO-DIMM	2x DDR4 SO-DIMM
<b>Max. Memory Size</b>	32GB	32GB	64GB
<b>BIOS</b>	AMI	AMI	AMI
<b>Graphics Controller</b>	AMD Ryzen™ V-Series APU built-in GPU	8th Gen Intel® Core™ i / U-Series built-in Gen 9 graphics, Up to 24EU	AMD Ryzen™ V-Series APU built-in GPU
<b>Video Output</b>	2x HDMI2.0 24-bit LVDS dual-channel eDP	24-bit dual-channel LVDS or eDP 2x DisplayPort	2x DisplayPort 1.4 24-bit LVDS dual-channel eDP
<b>Ethernet</b>	Intel® I211AT or I210AT GbE	Intel® I219LM GbE PHY (IB919AF series) Intel® I219V GbE PHY (IB918EF series) Intel® I211AT or I210AT as 2nd GbE	2x Intel® I211AT or I210AT GbE
<b>Audio</b>	Built-in ALC269Q-VC3-GR HD audio codec with 2W amplifier	Built-in ALC269Q-VC3-GR HD audio codec with 2W amplifier	Built-in ALC888S HD audio codec
<b>SATA</b>	2x SATA III ports	2x SATA III ports	2x SATA III ports
<b>I/O Chipset</b>	F81964D-I	Fintek F81964D-I	Fintek F81804U-I
<b>Serial Port</b>	3x RS232 1x RS232/422/485 (jumper-less selection)	3x RS232 1x RS232/422/485 (jumper-less selection)	1x RS232 1x RS232/422/485 (jumper-less selection)
<b>USB 2.0</b>	1x USB 2.0 via pin header	2x USB 2.0 via pin header	2x USB 2.0 via rear I/O
<b>USB 3.X</b>	2x USB 3.1 via rear I/O 2x USB 3.0 via rear I/O from eDP Lanes	1x USB 3.1 Type-C 4x USB 3.1 via rear I/O	2x USB 3.1 (Gen.2) via rear I/O 1x USB 3.1 via Type-C
<b>Hardware Monitor</b>	Yes	Yes	Yes
<b>TPM</b>	2.0	2.0	2.0
<b>Storage Device Interface</b>	1x M.2 (M-Key)	1x M.2 (M-Key)	1x M.2 (M-Key)
<b>Watchdog Timer</b>	256 levels	256 levels	256 levels
<b>Digital I/O</b>	4-in/4-out	4-in/4-out	4-in/4-out
<b>Mini Type Slots</b>	1x M.2 (B-key), 1x M.2 (E-key)	1x M.2 (B-key), 1x M.2 (E-key)	1x M.2 (M-key), 1x M.2 (E-key)
<b>Power input</b>	DC-in 12V~24V	DC-in 9V~24V	DC-in 12V~24V
<b>Power Consumption</b>	AMD Ryzen™ Embedded V1605B 2.00GHz w/ 2x 16GB DDR4-2400 +12V: 2.55A AMD Ryzen™ Embedded R1606G 2.6GHz w/ 2x 16GB DDR4-2400 +12V: 2.34A	Intel® Core™ i7-8665UE 1.70GHz w/2x 16GB DDR4-2400 +12V: 2.25A Intel® Core™ i3-8145UE 2.20GHz w/2x 16GB DDR4-2400 +12V: 2.24A	AMD Ryzen™ Embedded V2748 2.90GHz w/2x 16GB DDR4-3200 +12V: 7.61A
<b>Dimensions (L x W)</b>	147mm x 102mm	147mm x 102mm	147mm x 102mm
<b>Extra Features</b>	EuP/ErP, LAN Wakeup	LAN Wakeup, EuP/ErP	EuP/ErP, LAN Wakeup
<b>Page No.</b>	P2-12	P2-11	P2-10

1 CPU Modules

2 Single Board Computers

3 Motherboards

4 CPU Cards

# Comparison Table

## 3.5" Single Board Computer

Models	IB953	IB956	IB961
<b>Form Factor</b>	3.5" SBC	3.5" SBC	3.5" SBC
<b>CPU Socket</b>	CPU on board	CPU on board	CPU on board
<b>CPU</b>	11th Gen Intel® Core™ U-Series processor	11th Gen Intel® Core™ H-Series processor	13th Gen Intel® Core™ i7/i5/i3 mobile processors
<b>CPU Max. Frequency</b>	Up to 4.7GHz	Up to 4.7GHz	Up to 4.8GHz
<b>PCH</b>	N/A	QM580E HM570E	N/A
<b>Memory</b>	2x DDR4 SO-DIMM	1x DDR4 SO-DIMM	1x DDR5 SO-DIMM
<b>Max. Memory Size</b>	64GB	32GB	32GB
<b>BIOS</b>	AMI	AMI	AMI
<b>Graphics Controller</b>	11th Gen Intel® Core™ i / U-Series built-in Gen. 12 graphics, Up to EU96	11th Gen Intel® Core™ i / H-Series built-in Gen12 graphics, Up to EU96	13th Gen Intel® Core™ i7/i5/i3 mobile processors, built-in Gen13 graphics, Up to EU96
<b>Video Output</b>	24-bit dual-channel LVDS eDP 2x DisplayPort	24-bit dual-channel LVDS 3x DisplayPort	24-bit dual-channel LVDS eDP 2x DisplayPort
<b>Ethernet</b>	Intel® I219LM GbE PHY (IB953AF series) Intel® I219V GbE PHY (IB953EF series) Intel® I211AT or I210AT as 2nd GbE	1x Intel® I225-LM 2.5GbE (IB956AF series) 1x Intel® I225-V 2.5GbE (IB956EF series) Intel® I2225-V as 2nd GbE	1x Intel® I226LM 2.5GbE 1x Intel® I226V 2.5GbE
<b>Audio</b>	Built-in ALC269Q-VC3-GR HD audio codec with 2W amplifier	Built-in ALC888S HD audio codec	Built-in ALC888S HD audio codec
<b>SATA</b>	2x SATA III ports	2x SATA III ports	2x SATA III ports
<b>I/O Chipset</b>	Fintek F81804U-I	Fintek F81804U-I	Fintek F81804U-I
<b>Serial</b>	2x RS232/422/485 (Jumper-less selection)	1x RS232 1x RS232/422/485 (Jumper-less selection)	2x RS232/422/485 (Jumper-less selection)
<b>USB 2.0</b>	2x USB 2.0 via pin header 1x USB 2.0 Type-A	2x USB 2.0 via pin header	3x USB 2.0 (1x Type-A; 2x via pin headers)
<b>USB 3.X</b>	3x USB 3.1 via rear I/O	5x USB 3.1 (Gen.2) via rear I/O 1x USB 3.1 (Gen2) via Type-C	3x USB 3.2 via rear I/O
<b>Hardware Monitor</b>	Yes	Yes	Yes
<b>TPM</b>	2.0	2.0	fTPM
<b>Storage Device Interface</b>	1x M.2 (M-Key)	1x M.2 (M-Key)	M.2 (M2280 for NVMe)
<b>Watchdog Timer</b>	256 levels	256 levels	256 levels
<b>Digital I/O</b>	4-in/4-out	4-in/4-out	4-in/4-out
<b>Mini Type Slots</b>	1x M.2 (B-key), 1x M.2 (E-key), 1x M.2 (M-Key)	1x M.2 (M-key), 1x M.2 (E-key)	3x M.2 slots (M-Key + E-key + B-key)
<b>Power input</b>	DC-in 9V~24V	DC-in 12V~24V	DC-in 12V~24V
<b>Power Consumption</b>	Intel® Atom® i7-1185G7E 2.80GHz w/2x 16GB DDR4-3200 +12V: 3.88A	Intel® Core™ i7-11850HE 2.6GHz w/ 8GB DDR4-2400 +12V: 5.82A	TBD
<b>Dimensions (L x W)</b>	147mm x 102mm	147mm x 102mm	147mm x 102mm
<b>Extra Features</b>	Built-in iAMT (15), EuP/ErP	Built-in iAMT (15)	Built-in iAMT (16.1)
<b>Page No.</b>	P2-9	P2-8	P2-7

1

CPU Modules

2

Single Board Computers

3

Motherboards

4

CPU Cards

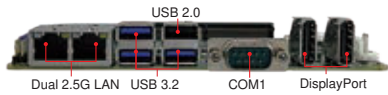
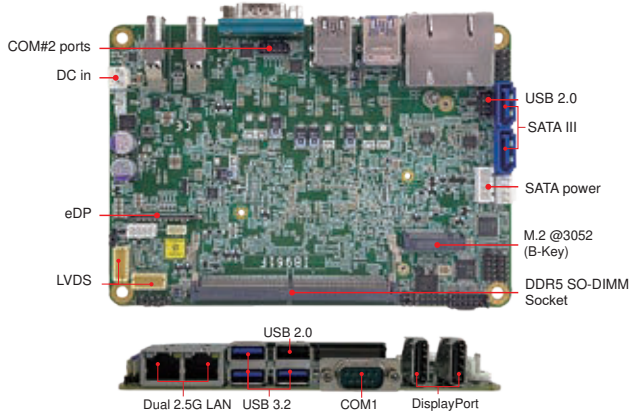

## Features

- Onboard 13th Gen Intel® Core™ i7/i5/i3 mobile processors
- 1x DDR5 SO-DIMM, Max. 32GB
- Supports 2x DP++, LVDS and eDP
- 2x Intel® PCI-E 2.5G LAN
- 3x USB 2.0, 3x USB 3.2, 2x COM, 2x SATA III
- 3x M.2 slots (M-Key + E-key + B-key)
- Supports digital I/O (4-in/4-out), fTPM & watchdog timer

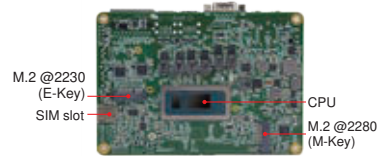

IB961 with heatsink

## Specifications

CPU	Onboard 13th Gen Intel® Core™ P-Series processors
PCH	N/A
Memorys	1x DDR5 SO-DIMM, Max. 32GB
BIOS	AMI
Watchdog Timer	256 levels
H/W Monitor	Yes
Storage Device Interface	M.2 (M2280 for NVMe)
Mini Type Slots	3x M.2 slots (M-Key + E-key + B-key)
Graphics Controller	13th Gen Intel® Core™ mobile processor integrated graphics
Video Output	2x DisplayPort, eDP & LVDS
Ethernet	Intel® I226LM as 1st LAN, I226V as 2nd LAN
I/O Chipset	Fintek F81804U-I on board
Serial Port	2x COM port
USB 2.0	3x USB 2.0 (1x Type-A ; 2 via pin headers)
USB 3.X	3x USB 3.2 (3x Type-A)
Serial ATA	2x SATA III
Audio	13th Gen Intel® Core™ P-Series processor built-in HD audio + ALC888S codec
TPM	fTPM
Others	Digital I/O (4-in/4-out) ; +12V~+24V DC-in
Dimensions (L x W)	102mm x 147mm (4" x 5.8")
Power Consumption	TBD
Operating Temperature	0°C~60°C (-4°F~140°F)
Storage Temperature	-20°C~80°C (-4°F~176°F)
Relative Humidity	10% ~ 90% (non-condensing)

## Ordering Information

IB961VF-I7P	Intel® Core™ i7-1370PE 3.5" SBC, w/ I226LM + I226V 2.5G LAN, VGA (2x DisplayPort + eDP + LVDS), 2x SATA III, 2x COM, 3x M.2 (M2280/ E2230& B3052), DC in (12V~24V), Supports iAMT, fTPM, Optional Heatsink, w/o cable kit, (RoHS 2)
IB961VF-I5P	Intel® Core™ i5-1340PE 3.5" SBC, w/ I226LM + I226V 2.5G LAN, VGA (2x DisplayPort + eDP + LVDS), 2x SATA III, 2x COM, 3x M.2 (M2280/ E2230& B3052), DC in (12V~24V), Supports iAMT, fTPM, Optional Heatsink, w/o cable kit, (RoHS 2)
IB961VF-I3P	Intel® Core™ i3-1320PE 3.5" SBC, w/ I226LM + I226V 2.5G LAN, VGA (2x DisplayPort + eDP + LVDS), 2x SATA III, 2x COM, 3x M.2 (M2280/ E2230& B3052), DC in (12V~24V), Supports iAMT, fTPM, Optional Heatsink, w/o cable kit, (RoHS 2)

## Dimensions and Drawing

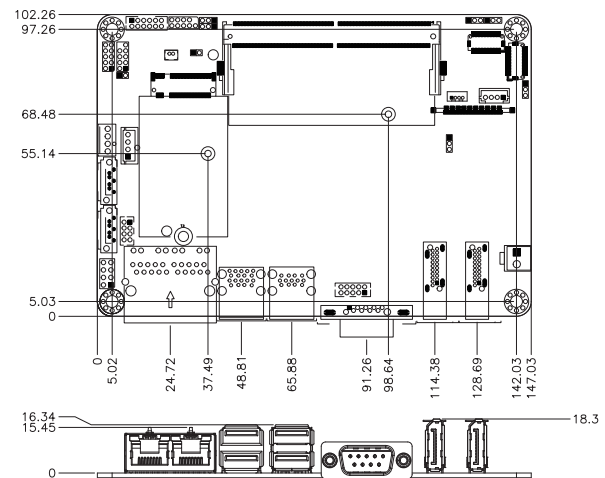

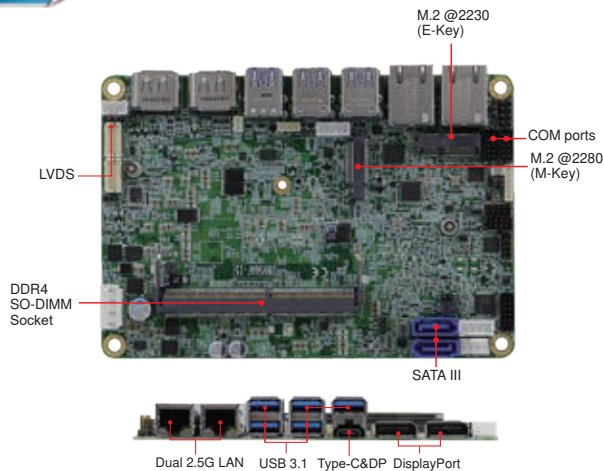

## Features

- Onboard 11th Gen Intel® Core™ / Celeron® processor (formerly Tiger Lake H)
- 1x DDR4 SO-DIMM, Max. 32GB
- Supports 3x DisplayPort (DP connectors + Type-C connector) and 24-bit Dual channel LVDS
- 2x Intel® 2.5 Gigabit LAN
- 6x USB 3.1, 2x USB 2.0, 2x SATA III, 2x COM, 2x M.2
- Watchdog timer, Digital I/O, iAMT (15), TPM (2.0)



CPU



IB956 with Heatsink

## Specifications

CPU	11th Gen Intel® Core™ i7-11850HE 11th Gen Intel® Core™ i5-11500HE 11th Gen Intel® Core™ i3-11100HE Intel® Celeron® -6600HE
PCH	IB956AF series: Intel® QM580E IB956EF series: Intel® HM570E
Memorys	1x DDR4 SO-DIMM, Max.32GB
BIOS	AMI
Watchdog Timer	256 Levels
H/W Monitor	Yes
Storage Device Interface	NVMe
Mini Type Slots	1x M.2 (M-Key, type:2280, Supports NVMe with PCI-E(4x)signal only) 1x M.2 (E-Key, type:2230, Supports CNVI)
Graphics Controller	11th Gen Intel® Core™ H-series processor integrated graphics
Video Output	3x DisplayPort (1.4) (DP connectors + Type-C connector), and 24-bit Dual channel LVDS
Ethernet	1st LAN: IB956AF series: Intel® I225-LM IB956EF series: Intel® I225-V 2nd LAN: Intel® I225-V
I/O Chipset	Fintek F81804U-I
Serial Port	1x RS232/422/485, 1x RS232
USB 2.0	2x USB 2.0 via pin header
USB 3.X	QM580E: 6x USB 3.1 (GEN2) HM570E: 4x USB 3.1 (GEN2), 2x USB 3.1(Gen1)
Serial ATA	2x SATA III
Audio	11th Gen Intel® Core™ H-series processor Built-in HD audio controller + Realtek ALC888S
TPM	TPM (2.0)
Others	Digital I/O, +12~ +24V DC-in
Dimensions (L x W)	102mm x 147mm (4" x 5.8")
Power Consumption	Intel® Core™ i7-11850HE 2.6GHz w/ 1x 8GB DDR4-2400 +12V: 5.82A
Operating Temperature	0°C~60°C
Storage Temperature	-20°C~80°C
Relative Humidity	95%@60 degree-C non-condensing

## Ordering Information

IB956AF-i7	Onboard Intel® QM580E / Core™ i7-11850HE, w/ I225-LM 2.5GbE LAN + I225V 2.5GbE LAN, 3x DisplayPort (DP+ Type-C) & LVDS (24bit Dual-channel), 2x SATA III, 2x COM, 2x M.2 (M2280/ E2230), DC-in (12V~24V), Support iAMT 15.0, TPM (2.0), Optional Heatsink, w/o cable kit, (RoHS 2)
IB956AF-i5	Onboard Intel® QM580E/ Core™ i5-11500HE, w/ I225-LM 2.5GbE LAN + I225V 2.5GbE LAN, 3x DisplayPort (DP+ Type-C) & LVDS (24bit Dual-channel), 2x SATA III, 2x COM, 2x M.2 (M2280/ E2230), DC-in (12V~24V), Support iAMT 15.0, TPM (2.0), Optional Heatsink, w/o cable kit, (RoHS 2)
IB956EF-i3	Onboard Intel® HM570E/ Core™ i3-11100HE, w/ 2x I225V 2.5GbE LAN, 3x DisplayPort (DP+ Type-C) & LVDS (24bit Dual-channel), 2x SATA III, 2x COM, 2x M.2 (M2280/ E2230), DC-in (12V~24V), TPM (2.0), Optional Heatsink, w/o cable kit, (RoHS 2)
HSIB956-A	Heatsink with Fan for IB956
HSIB956-1	Heat spreader for IB956
IB92	Cable kit w/ COM, Power, SATA + Power

## Dimensions and Drawing

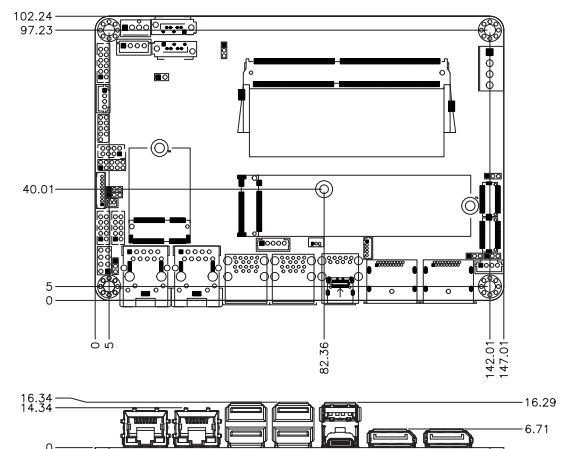

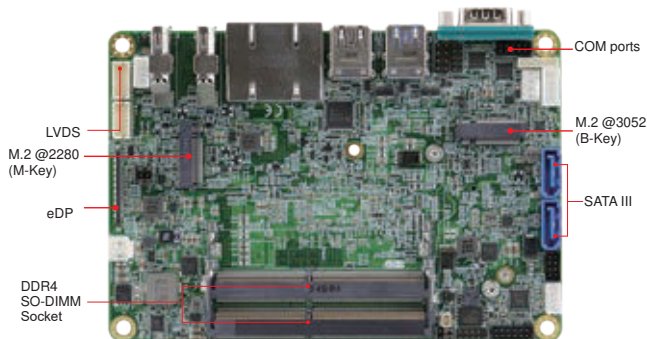

## Features

- Onboard 11th Gen Intel® Core™ i7/i5/i3 / Celeron® processor
- 2x DDR4-3200 SO-DIMM, Max. 64GB
- Supports 2x DisplayPort, eDP and 24-bit dual-channel LVDS
- 2x Intel® PCI-E GbE LAN
- 3x USB 2.0, 3x USB 3.1, 2x SATA III
- 3x M.2 sockets (B-Key/ E-Key and M-Key)
- Watchdog timer, Digital I/O, TPM (2.0), 5G compatible



## Specifications

CPU	11th Gen Intel® Core™ i7-1185G7E 11th Gen Intel® Core™ i5-1145G7E 11th Gen Intel® Core™ i3-1115G4E Intel® Celeron® 6305E
PCH	Integrated in 11th Gen Intel® Core™ / Celeron® processor
Memorys	DDR4-3200 SO-DIMM, Max. 64GB
BIOS	AMI
Watchdog Timer	256 levels
H/W Monitor	Yes
Storage Device Interface	1x M.2 (M-Key)
Mini Type Slots	1x M.2 (M-Key, Type:2280, Supports NVMe with PCI-E(4x) signal only) 1x M.2 (E-Key, Type:2230, Supports CNVi) 1x M.2 (B-Key, Type:3052, Supports 5G)
Graphics Controller	Intel® Gen 12 Graphics
Video Output	2x DisplayPort, eDP and 24-bit dual-channel LVDS
Ethernet	IB953AF series: Intel® I219LM Gigabit LAN PHY IB953EF series: Intel® I219V Gigabit LAN PHY Intel® I211AT or I210AT Gigabit LAN (as 2nd LAN)
I/O Chipset	Fintek F81804U-I
Serial Port	2x RS232/422/485 (Jumper-less selection)
USB 2.0	2x USB 2.0 (Pin-header), 1x USB 2.0 (Type-A)
USB 3.X	3x USB 3.1 (Type-A)
Serial ATA	2x SATA III
Audio	Built-in HD with Realtek ALC269 w/ class-D amplifier
TPM	TPM (2.0)
Others	Digital I/O (4-in/4-out), EuP/ErP, +12V~+24V DC-in (+/-10%), supports IBECC (depend on CPU SKU)
Dimensions (L x W)	102mm x 147mm (4" x 5.8")
Power Consumption	Intel® i7-1185G7E 2.8GHz/ w/ 2x16GB DDR4-3200 +12V: 3.71A Intel® i3-1115G4E 3.00GHz w/ 2x16GB DDR4-3200 +12V: 3.26A
Operating Temperature	0°C~60°C
Storage Temperature	-20°C~80°C
Relative Humidity	95% (non-condensing@60°C)

## Ordering Information

IB953AF-I7	Intel® Core™ i7-1185G7E 3.5" SBC, w/ I211AT or I210AT GbE LAN + I219LM GbE LAN, VGA (2x DisplayPort + eDP and LVDS), 2x SATA III, 2x COM, 3x M.2 (M2280/ E2230& B3052), DC-in (12V~24V), Supports iAMT 15.0, TPM (2.0), Optional Heatsink, w/o cable kit, (RoHS 2)
IB953AF-I5	Intel® Core™ i5-1145G7E 3.5" SBC, w/ I211AT or I210AT GbE LAN + I219LM GbE LAN, VGA (2x DisplayPort + eDP and LVDS), 2x SATA III, 2x COM, 3x M.2 (M2280/ E2230& B3052), DC-in (12V~24V), Supports iAMT 15.0, TPM (2.0), Optional Heatsink, w/o cable kit, (RoHS 2)
IB953EF-I3	Intel® Core™ i3-1115G4E 3.5" SBC, w/ I211AT or I210AT GbE LAN + I219V GbE LAN, VGA (2x DisplayPort + eDP and LVDS), 2x SATA III, 2x COM, 3x M.2 (M2280/ E2230& B3052), DC-in (12V~24V), TPM (2.0), supports EuP/ ErP, Optional Heatsink, w/o cable kit, (RoHS 2)
IB953EF-CEL	Intel® Celeron® 6305E 3.5" SBC, w/ I211AT or I210AT GbE LAN + I219V GbE LAN, VGA (2x DisplayPort + eDP and LVDS), 2x SATA III, 2x COM, 3x M.2 (M2280/ E2230& B3052), DC-in (12V~24V), TPM (2.0), supports EuP/ ErP, Optional Heatsink, w/o cable kit, (RoHS 2)
HSIB953-A	Heatsink for IB953
HSIB953-1	Heat spreader for IB953
IB76A-2	Cable kit w/ USB, COM, Power, SATA + Power

## Dimensions and Drawing

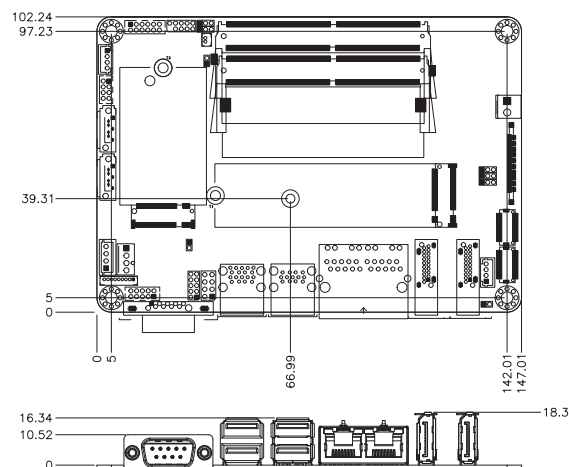



## Features

- AMD Ryzen™ Embedded V2000 on board
- 2x DDR4 SO-DIMM, Max. 64GB
- 2x Gigabit LAN
- Supports 2x DisplayPort (DP connector and Type-C), 1x eDP, 1x 24-bit LVDS dual-channel
- 2x USB 2.0, 3x USB 3.1, 2x SATA III, 2x COM
- 2x M.2 sockets (M-key/ E-key)

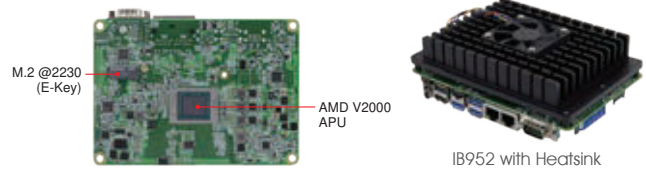
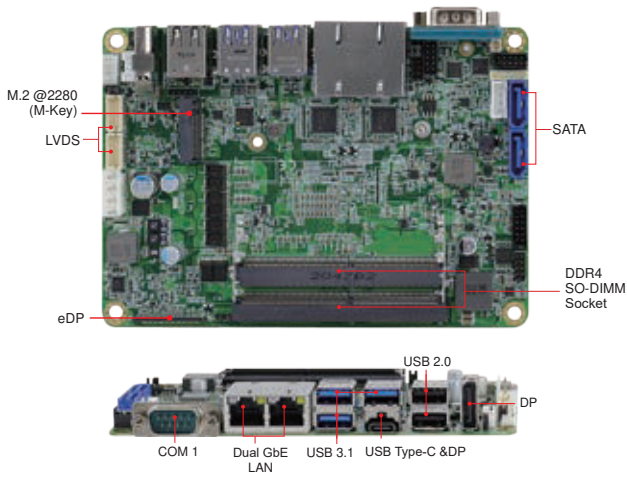

## Specifications

CPU	AMD Ryzen™ Embedded V2000 on board
PCH	N/A
Memory	DDR4-3200 SO-DIMM, Max. 64GB, supports ECC
BIOS	AMI
Watchdog Timer	256 levels
H/W Monitor	Yes
Storage Device Interface	1x M.2 (M-Key)
Mini Type Slots	1x M.2 (M-key, type:2280, NVMe) 1x M.2 (E-key, type:2230)
Graphics Controller	AMD Raden™ Vega integrated
Video Output	2x DisplayPort (DP connector & Type-C), 1x 24-bit Dual-channel LVDS, 1x eDP
Ethernet	2x Intel® I211AT or I210AT Gigabit LAN
I/O Chipset	Fintek F81964
Serial Port	1x RS232/422/485 (Jumper-less selection) 1x RS232
USB 2.0	2x USB 2.0 on board
USB 3.X	3x USB 3.1 on board
Serial ATA	2x SATA III
Audio	Built-in audio w/ Realtek ALC888S
TPM	TPM (2.0)
Others	Digital I/O(4-in/ 4-out), EuP/ErP, +12V~+24V DC-in (+/-10%)
Dimensions (L x W)	102mm x 147mm (4" x 5.8")
Power Consumption	AMD Ryzen™ Embedded V2748 2.9GHz w/ 2x 16GB DDR4-3200 +12V: 7.61A AMD Ryzen™ Embedded V2718 1.70GHz w/ 2x 16GB DDR4-3200 +12V: 3.92A
Operating Temperature	0°C~60°C (32°F~140°F)
Storage Temperature	-20°C~80°C (-4°F~176°F)
Relative Humidity	95% (non-condensing@60°C)

## Ordering Information

IB952F-2748	AMD Ryzen™ V2748 Octa APU (2.9GHz~4.15GHz) on board 3.5" SBC w/ dual LAN, 2x DisplayPort (DP+Type-C), eDP & LVDS (24-bit dual-channel), EuP/ErP, 12V~24V DC-in
IB952F-2718	AMD Ryzen™ V2718 Octa APU (1.7GHz~4.15GHz) on board 3.5" SBC w/ dual LAN, 2x DisplayPort (DP+Type-C), eDP & LVDS (24-bit dual-channel), EuP/ErP, 12V~24V DC-in
HSIB952-A	Heatsink with Fan for IB952F-2718
HSIB952-B	Heatsink with Fan for IB952F-2748
HSIB952-1	Heat spreader for IB952
IB92	Cable kit w/ COM, Power, SATA + Power

## Dimensions and Drawing

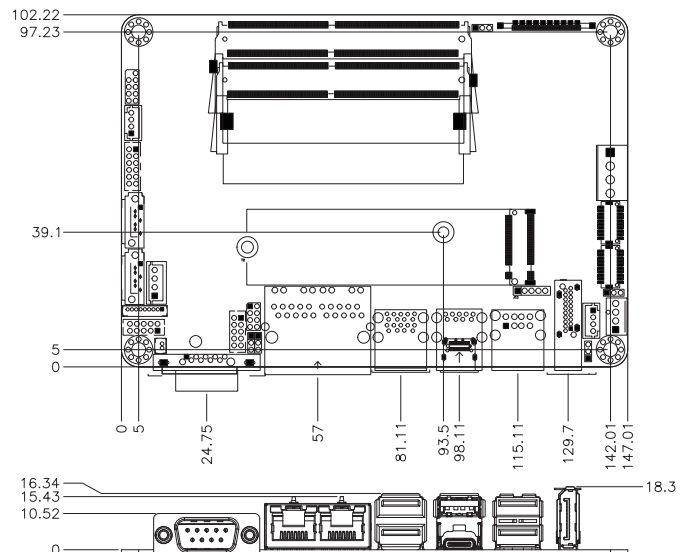

1 CPU Modules

2 Single Board Computers

3 Motherboards

4 CPU Cards

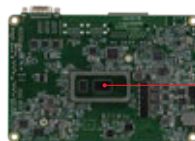
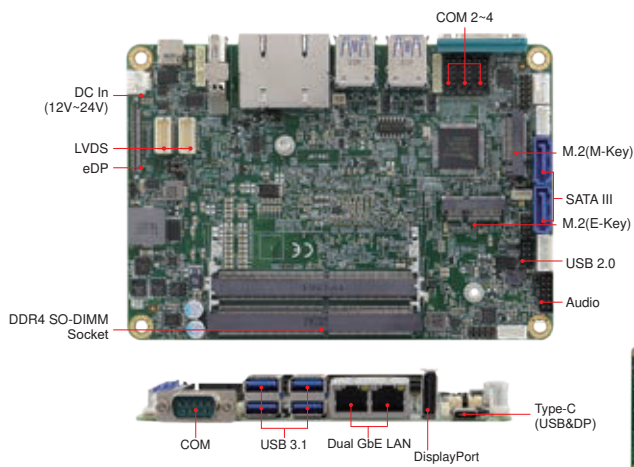

## Features

- Onboard 8th Gen Intel® Core™ i7/i5/i3 / Celeron® processor
- 2x DDR4-2400 SO-DIMM, Max.32GB, Non-ECC
- 2x DisplayPort (DP connector & Type-C), eDP or 24-bit dual-channel LVDS
- 2x Intel® PCI-E GbE LAN
- Watchdog timer, Digital I/O, TPM (2.0)
- 2x USB 2.0, 4x USB 3.1 (Type-A), 1x USB (Type-C), 2x SATA III
- 2x M.2 sockets (M/E-Key)

## Specifications

CPU	8th Gen Intel® Core™ i7-8665UE (1.7GHz/4.4GHz) 8th Gen Intel® Core™ i5-8365UE (1.6GHz/4.1GHz) 8th Gen Intel® Core™ i3-8145UE (2.2GHz/3.9GHz) Intel® Celeron® 4305UE (2.0GHz)
PCH	Integrated in 8th Gen Intel® Core™ / Celeron® processor
Memory	DDR4-2400 SO-DIMM, Max. 32GB (Non-ECC)
BIOS	AMI
Watchdog Timer	256 levels
H/W Monitor	Yes
Storage Device Interface	1x M.2 (M-Key)
Mini Type Slots	1x M.2 (M2280, Supports NVMe) 1x M.2 (E2230, Supports CNVI)
Graphics Controller	Intel® UHD Graphics 620
Video Output	2x DisplayPort (DP connector & Type-C) eDP or 24-bit dual-channel LVDS
Ethernet	IB919AF series : Intel® I219LM Gigabit LAN PHY IB919EF series: Intel® I219V Gigabit LAN PHY Intel® I211AT or I210AT Gigabit LAN (as 2nd LAN)
I/O Chipset	Fintek F81964D-I
Serial Port	1x RS232/422/485 (Jumper-less selection) 3x RS232
USB 2.0	2x USB 2.0 (Pin-header)
USB 3.X	4x USB 3.1 (Type-A) 1x USB (Type-C)
Serial ATA	2x SATA III
Audio	Built-in HD with Realtek ALC269 w/ class-D amplifier
TPM	TPM (2.0)
Others	Digital I/O (4-in/4-out), +9V ( Non-tolerance) ~+24V DC-in (+20%), EuP/ErP
Dimensions (L x W)	102mm x 147mm (4" x 5.8")
Power Consumption	Intel® Core™ i7-8665UE 1.70GHz w/ 2x DDR4-2400 16GB +12V: 2.25A Intel® Core™ i3-8145UE 2.20GHz w/2x DDR4-2400 16GB +12V: 2.24A
Operating Temperature	0°C~60°C
Storage Temperature	-20°C~80°C
Relative Humidity	90% (non-condensing@60°C)

## Ordering Information

IB919AF-8665	SBC with Intel® Core™ i7-8665UE (1.7GHz/4.4GHz) 3.5" SBC, I211AT or I210AT GbE LAN + I219LM GbE LAN, USB Type-C (USB 3.1+DP), VGA (DisplayPort + DP or LVDS), 2x SATA III, 4x COM, 2x M.2 (M2280 & E2230), DC-in (9V~24V), Supports iAMT 11.0, TPM (2.0), Optional Heatsink, w/o cable kit, (RoHS)
IB919AF-8365	Intel® Core™ i5-8365UE (1.6GHz/4.1GHz) 3.5" SBC, I211AT or I210AT GbE LAN + I219LM GbE LAN, USB Type-C (USB 3.1+DP), VGA (DisplayPort + DP or LVDS), 2x SATA III, 4x COM, 2x M.2 (M2280 & E2230), DC-in (9V~24V), Supports iAMT 11.0, TPM (2.0), Optional Heatsink, w/o cable kit, (RoHS)
IB919EF-8145	Intel® Core™ i3-8145UE (2.2GHz/3.9GHz) 3.5" SBC, I211AT or I210AT GbE LAN + I219V GbE LAN, USB Type-C (USB 3.1+DP), VGA (DisplayPort + DP or LVDS), 2x SATA III, 4x COM, 2x M.2 (M2280 & E2230), DC-in (9V~24V), EuP/ErP, TPM (2.0), Optional Heatsink, w/o cable kit, (RoHS)
IB919EF-4305	Intel® Celeron® 4305UE (2.0GHz) 3.5" SBC, I211AT GbE LAN + I219V GbE LAN, USB Type-C (USB 3.1+DP), VGA (DisplayPort + DP or LVDS), 2x SATA III, 4x COM, 2x M.2 (M2280 & E2230), DC-in (9V~24V), EuP/ErP, TPM (2.0), Optional Heatsink, w/o cable kit, (RoHS)
HSIB919-A	Heatsink for IB919
HSIB919-1	Heat spreader for IB919
IB76A-2	Cable Kit w/USB, COM, Power cable, SATA+Power cable for IB919 series

## Dimensions and Drawing

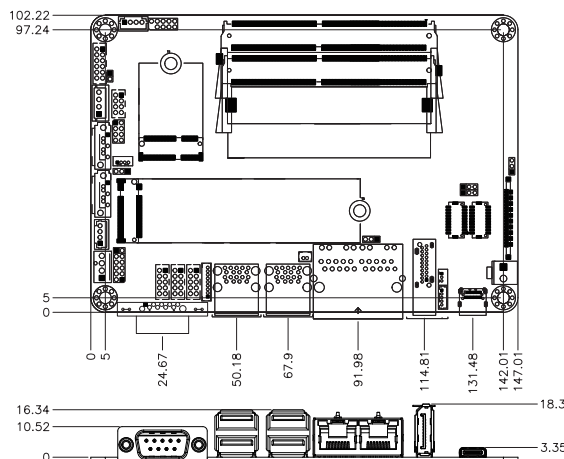

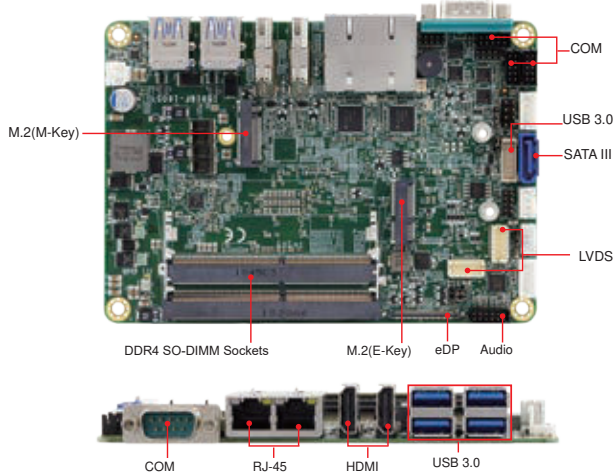

## Features

- AMD Ryzen™ Embedded V1000/R1000 Series on board
- 2x DDR4 SO-DIMM, Max. 32GB
- 2x Gigabit LAN
- 2x HDMI, 1x eDP, 1x 24-bit LVDS dual-channel
- 1x USB 2.0, 4x USB 3.1, 1x SATA III, 4x COM
- 2x M.2 sockets (M/ E key)

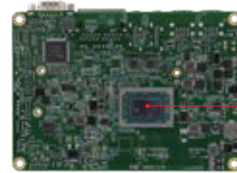

IB918 with heatsink

## Specifications

CPU	AMD Ryzen™ Embedded V1000/R1000 Series on board
PCH	N/A
Memory	DDR4-2400 SO-DIMM, Max. 32GB, supports ECC
BIOS	AMI
Watchdog Timer	256 levels
H/W Monitor	Yes
Storage Device Interface	1x M.2 (M-Key)
Mini Type Slots	1x M.2 (M-key, type:2280, NVMe) 1x M.2 (E-key, type:2230)
Graphics Controller	AMD Raden™ Vega integrated
Video Output	2x HDMI(2.0a), 1x 24-bit Dual-channel LVDS & eDP
Ethernet	2x Intel® I211AT or I210AT Gigabit LAN
I/O Chipset	Fintek F81964D-1
Serial Port	1x RS232/422/485 (Jumper-less selection) 3x RS232
USB 2.0	1x USB 2.0 on board
USB 3.X	4x USB 3.1 on board
Serial ATA	1x SATA III
Audio	Built-in audio w/ Realtek ALC269Q-VC3-GR w/ class-D amplifier
TPM	TPM (2.0)
Others	Digital I/O(4-in/ 4-out), EuP/ErP, +12V~+24V DC-in (+/-10%)
Dimensions (L x W)	102mm x 147mm (4" x 5.8")
Power Consumption	AMD Ryzen™ Embedded V1605B 2.00GHz w/ 2x 16GB DDR4-2400 +12V: 2.55A AMD Ryzen™ Embedded R1606G 2.6GHz w/ 2x 16GB DDR4-2400 +12V: 2.34A
Operating Temperature	0°C~60°C (32°F~140°F)
Storage Temperature	-20°C~80°C (-4°F~176°F)
Relative Humidity	90% (non-condensing@60°C)

## Ordering Information

IB918F-1605	AMD Ryzen™ V1605B QC APU (2.0GHz~3.6GHz) on board 3.5" SBC w/ dual LAN, 2x HDMI, eDP & LVDS (24-bit dual-channel), EuP/ErP, 12V~24V DC-in
IB918F-1202	AMD Ryzen™ V1202B DC APU (2.3GHz~3.3GHz) on board 3.5" SBC w/ dual LAN, 2x HDMI, eDP & LVDS (24-bit dual-channel), EuP/ErP, 12V~24V DC-in
IB918F-1606G	AMD Ryzen™ R1606G DC (2.6GHz~3.5GHz) on board 3.5" SBC w/ dual GbE LAN, 2x HDMI (2.0a), eDP, EuP/Erp, 12V~24V DC-in
IB918F-1505G	AMD Ryzen™ R1505G DC (2.4GHz~3.3GHz) on board 3.5" SBC w/ dual GbE LAN, 2x HDMI (2.0a), eDP, EuP/Erp, 12V~24V DC-in
HSIB918-A	Heat sink with fan for IB918
HSIB918-1	Heat spreader for IB918
IB90	Cable kit w/ PW87,PK1H,SATA-53A,USB-168 for V1000 series
IB91	Cable kit w/ PW87,PK1H,SATA-53A,USB-172 for R1000 series

## Dimensions and Drawing

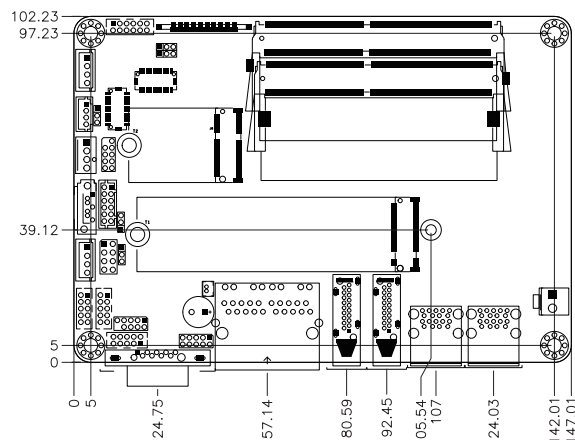



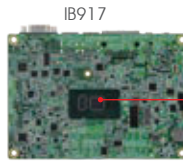
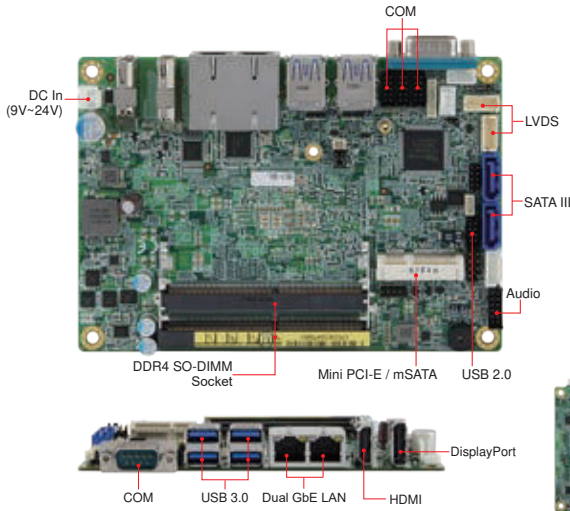

IB917 with Heat spreader

IB917 with Heatsink

## Features

- Onboard 7th Gen Intel® Core™ U-Series processor
- 2x DDR4-2133 SO-DIMM, Max 32GB, Non-ECC
- Supports DisplayPort, HDMI and 24-bit dual-channel LVDS (IB917)/eDP(IB916)
- 2x Intel® PCI-E GbE LAN
- Watchdog timer, Digital I/O, mSATA, iSMART, TPM (2.0)
- 2x USB 2.0, 4x USB 3.0, 4x COM, 2x SATA III
- 1x Mini PCI-E slot

## Specifications

CPU	BGA1356 for 7th Gen Intel® Core™ U-Series i7/i5/i3/ Celeron® DC processors, up to 3.4GHz
PCH	Integrated in 7th Gen Intel® Core™ U-Series processor
Memory	2x DDR4-2133 SO-DIMM, Max 32GB (Non-ECC)
BIOS	AMI
Watchdog Timer	256 levels
H/W Monitor	Yes
Storage Device Interface	1x mSATA
Mini Type Slots	1x Mini PCI-E (full-size)
Graphics Controller	7th Gen Intel® Core™ U-Series processor integrated graphics
Video Output	Supports DisplayPort, HDMI and 24-bit dual-channel LVDS
Ethernet	IB917AF series: Intel® I219LM LAN PHY IB917F series: Intel® I219V LAN PHY Intel® I211AT or I210AT Gigabit LAN (as 2nd LAN)
I/O Chipset	Fintek F81846AD-I
Serial Port	1x RS-232/422/485 (jumper-less selection), 3x RS232
USB 2.0	2x USB 2.0 via pin header
USB 3.X	4x USB 3.0 on board
Serial ATA	2x SATA III
Audio	7th Gen Intel® Core™ U-Series processor built-in HD audio controller + Realtek ALC888S codec
TPM	TPM (2.0)
Others	Digital I/O, +9V~ +24V DC-in, iSMART
Dimensions (L x W)	102mm x 147mm (4" x 5.8")
Power Consumption	Intel® i7-7600U, 2.8GHz w/ 8GB DDR4-2133+12V: 3.46A Intel® i3-7100U, 2.4GHz w/ 8GB DDR4-2133+12V: 2.68A
Operating Temperature	0°C~60°C ( 32°F~140°F)
Storage Temperature	-20°C~80°C ( -4°F~176°F)
Relative Humidity	90% (non-condensing @60°C)

## Ordering Information

IB917AF-7600	Intel® Core™ i7-7600U(2.8GHz/3.9GHz), 3.5" SBC w/ dual PCI-E GbE LAN, DP & HDMI, LVDS(24-bit LVDS dual-channel), TPM (2.0), iSMART, mSATA, iAMT(1.1.6)
IB917AF-7300	Intel® Core™ i5-7300U(2.6GHz/3.5GHz), 3.5" SBC w/ dual PCI-E GbE LAN, DP & HDMI, LVDS (24-bit LVDS dual-channel), TPM (2.0), mSATA, iSMART
IB917F-7100	Intel® Core™ i3-7100U(2.4GHz), 3.5" SBC w/ dual PCI-E GbE LAN, DP & HDMI, LVDS(24-bit LVDS dual-channel), TPM (2.0), mSATA, iSMART
IB917F-3965 (MOQ)	Intel® Celeron® 3965U(2.2GHz), 3.5" SBC, w/ dual PCI-E GbE LAN, DP & HDMI, LVDS(24-bit LVDS dual-channel), TPM (2.0), mSATA, iSMART
HSIB916-A	Heatsink for IB917/IB916
HSIB916-1	Heat spreader for IB917/IB916
IB76A-2	Cable kit w/ USB, COM, Power, SATA + Power cable

## Dimensions and Drawing

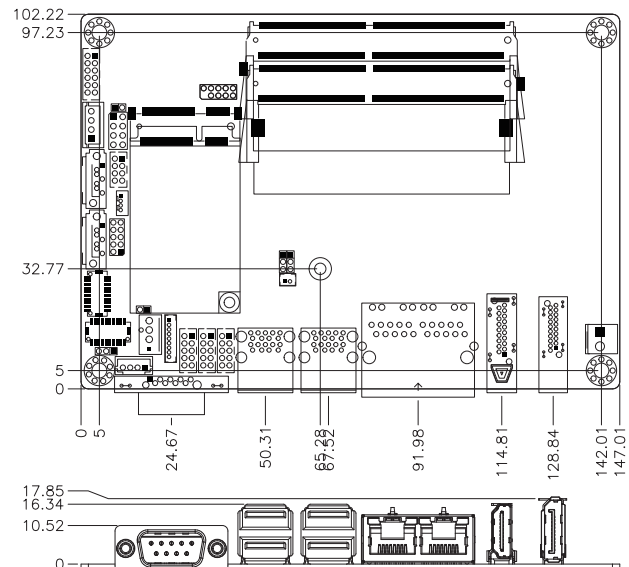

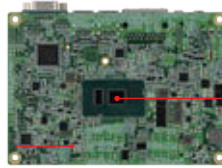
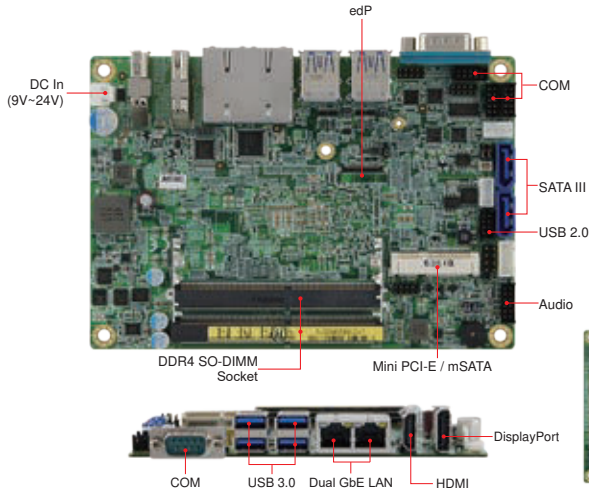

IB916 with Heat spreader



IB916 with Heatsink

## Features

- Onboard 7th Gen Intel® Core™ U-Series processor
- 2x DDR4-2133 SO-DIMM, Max 32GB, Non-ECC
- Supports eDP, DisplayPort and HDMI 1.4
- 2x Intel® PCI-E GbE LAN
- Watchdog timer, Digital I/O, mSATA, iSMART, TPM (2.0)
- 2x USB 2.0, 4x USB 3.0, 4x COM, 2x SATA III
- 1x Mini PCI-E slot

## Specifications

CPU	BGA1356 for 7th Gen Intel® Core™ U-Series i7/i5/i3/ Celeron® DC processors, up to 3.4GHz
PCH	Integrated in 7th Gen Intel® Core™ U-Series processor
Memory	2x DDR4-2133 SO-DIMM, Max 32GB (Non-ECC)
BIOS	AMI
Watchdog Timer	256 levels
H/W Monitor	Yes
Storage Device Interface	1x mSATA
Mini Type Slots	1x Mini PCI-E (full-size)
Graphics Controller	7th Gen Intel® Core™ U-Series processor integrated graphics
Video Output	Supports eDP, DisplayPort and HDMI
Ethernet	IB916AF series: Intel® I219LM LAN PHY IB916F series: Intel® I219V LAN PHY Intel® I211AT or I210AT Gigabit LAN (as 2nd LAN)
I/O Chipset	Fintek F81846AD-I
Serial Port	1x RS232/422/485 (jumper-less selection), 3x RS232
USB 2.0	2x USB 2.0 via pin header
USB 3.X	4x USB 3.0 on board
Serial ATA	2x SATA III
Audio	7th Gen Intel® Core™ U-Series processor built-in HD audio controller + Realtek ALC888S codec
TPM	TPM (2.0)
Others	Digital I/O, +9V~ +24V DC-in, iSMART
Dimensions (L x W)	102mm x 147mm (4" x 5.8")
Power Consumption	Intel® i5-7300U, 2.6GHz w/ 8GB DDR4-2133, +12V: 2.06A Intel® i3-7100U, 2.4GHz w/ 8GB DDR4-2133, +12V: 2.24A
Operating Temperature	0°C~60°C ( 32°F~140°F)
Storage Temperature	-20°C~80°C ( -4°F~176°F)
Relative Humidity	90% (non-condensing @60°C)

## Ordering Information

IB916AFS-7600	Intel® Core™ i7-7600U(2.8GHz/3.9GHz), 3.5" SBC w/ dual PCI-E GbE LAN, eDP, DP & HDMI, TPM (2.0), iSMART, mSATA, iAMT(1.1.6)
IB916AFS-7300	Intel® Core™ i5-7300U(2.6GHz/3.5GHz), 3.5" SBC w/ dual PCI-E GbE LAN, eDP, DP & HDMI, TPM (2.0), mSATA, iSMART
IB916FS-7100	Intel® Core™ i3-7100U(2.4GHz), 3.5" SBC w/ dual PCI-E GbE LAN, eDP, DP & HDMI, TPM (2.0), mSATA, iSMART
IB916F-3965 (MOQ)	Intel® Celeron® 3965U(2.2GHz), 3.5" SBC w/ dual PCI-E GbE LAN, eDP, DP & HDMI, TPM (2.0), mSATA, iSMART
HSIB916-A	Heatsink for IB917/IB916
HSIB916-1	Heat spreader for IB917/IB916
IB76A-2	Cable kit w/ USB, COM, Power, SATA + Power cable

\*[S] means with Realtek ALC888S codec

## Dimensions and Drawing

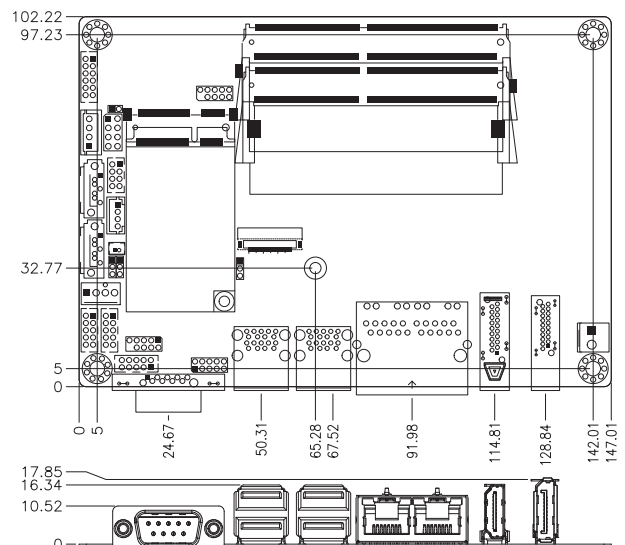



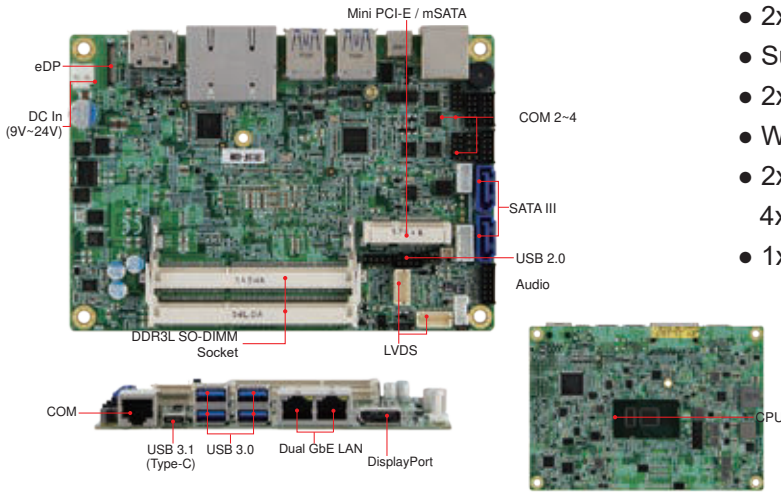

## Features

- Onboard 6th Gen Intel® Core™ U-Series processor
- 2x DDR3L-1600 SO-DIMM, Max. 16GB
- Supports eDP, DP and 24bit dual-channel LVDS
- 2x Intel® Gigabit LAN
- Watchdog timer, Digital I/O, mSATA, iSMART
- 2x USB 2.0, 4x USB 3.0, 1x USB 3.1(Type-C), 4x COM, 2x SATA III
- 1x Mini PCI-E slot

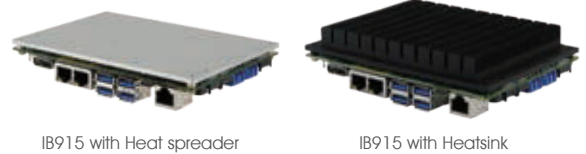

## Specifications

CPU	BGA1356 for 6th Gen Intel® Core™ U-Series i7/i5/i3/ Celeron® DC processors, up to 3.4GHz
PCH	Integrated in 6th Gen Intel® Core™ U-Series processor
Memory	2x DDR3L-1600 SO-DIMM, Max 16GB (Non-ECC)
BIOS	AMI
Watchdog Timer	256 levels
H/W Monitor	Yes
Storage Device Interface	1x mSATA
Mini Type Slots	1x Mini PCI-E (full-size)
Graphics Controller	6th Gen Intel® Core™ U-Series processor integrated graphics
Video Output	Supports eDP, DisplayPort and 24-bit dual-channel LVDS
Ethernet	IB915AF: Intel® I219LM LAN PHY IB915F: Intel® I219V LAN PHY Intel® I211AT or I210AT Gigabit LAN (as 2nd LAN)
I/O Chipset	Fintek F81846AD-1
Serial Port	1x RS232/422/485 (jumper-less selection), 3x RS232
USB 2.0	2x USB 2.0 via pin header
USB 3.X	1x USB 3.1(Type-C) 4x USB 3.0 on board
Serial ATA	2x SATA III
Audio	6th Gen Intel® Core™ U-Series processor built-in HD audio controller + Realtek ALC888S codec
TPM	N/A
Others	Digital I/O, +9V~ +24V DC-in, iSMART
Dimensions (L x W)	102mm x 147mm (4" x 5.8")
Max. Power Requirement	Intel® Core™ i3-6100U 2.3GHz w/ 2x DDR3L-1600 4GB, +12V: 2.36A Intel® Core™ i7-6600U 2.6GHz w/ 2x DDR3L-1600 4GB, +12V: 2.27A
Power Consumption	0°C~60°C (32°F~140°F)
Storage Temperature	-20°C~80°C (-4°F~176°F)
Relative Humidity	90% (non-condensing @60°C)

## Ordering Information

IB915AF-6600	Intel® Core™ i7-6600U(2.6GHz/3.4GHz) 3.5" SBC w/ dual PCI-E GbE LAN, eDP, DP & LVDS (24-bit LVDS dual-channel), mSATA, iSMART, iAMT(11.0)
IB915AF-6300	Intel® Core™ i5-6300U(2.4GHz/3GHz) 3.5" SBC w/ dual PCI-E GbE LAN, eDP, DP & LVDS (24-bit LVDS dual-channel), mSATA, iSMART, iAMT(11.0)
IB915F-6100	Intel® Core™ i3-6100U(2.3GHz) 3.5" SBC w/ dual PCI-E GbE LAN, eDP, DP & LVDS (24-bit LVDS dual-channel), mSATA, iSMART
IB915F-3955 (MOQ)	Intel® Celeron® 3955U (2GHz) 3.5" SBC w/ dual PCI-E GbE LAN, eDP, DP & LVDS (24-bit LVDS dual-channel), mSATA, iSMART
HSIB915-BGA-A	Heatsink for IB915
HSIB915-BGA-1	Heat spreader for IB915
IB76A-2	Cable kit w/ USB, COM, Power, SATA + Power cable

## Dimensions and Drawing

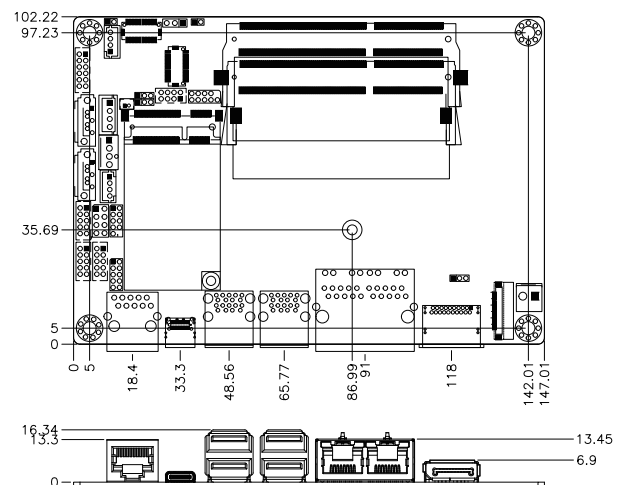

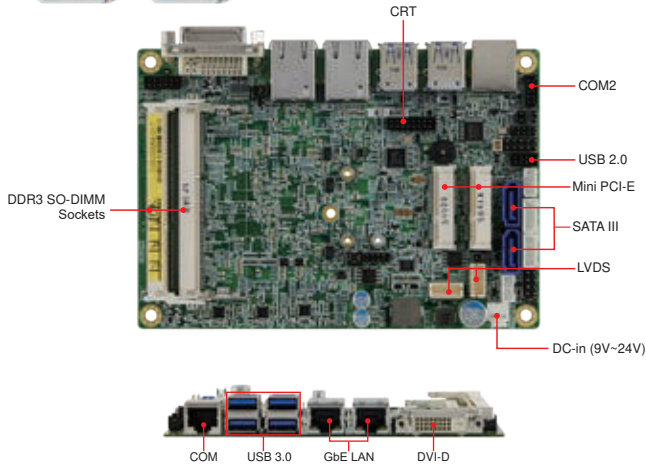

## Features

- Onboard Intel® Pentium® QC N3710, up to 2.56GHz or Celeron® DC N3010, up to 2.24GHz
- 2x DDR3L SO-DIMM sockets, Max. 8GB
- Supports VGA, DVI-D and 24-bit dual-channel LVDS
- 2x Intel® I211AT or I210AT Gigabit LAN
- Watchdog timer, Digital I/O, mSATA, iSMART
- 4x USB 3.0, 2x USB 2.0, 2x COM, 2x SATA III
- 2x Mini PCI-E slots (1x full-size, 1x half-size)

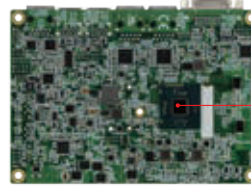

CPU



IB899 with Heatsink

## Specifications

CPU	Intel® Pentium® N3710, up to 2.56GHz or Celeron® N3010, up to 2.24GHz
PCH	N/A
Memory	2x DDR3L SO-DIMM sockets, Max. 8GB
BIOS	AMI
Watchdog Timer	256 levels
H/W Monitor	Yes
Storage Device Interface	1x mSATA
Mini Type Slots	2x Mini PCI-E (1x full-size, 1x half-size)
Graphics Controller	Intel® Pentium® SoC integrated Gen-8 graphics
Video Output	Supports DVI-D, CRT 24-bit dual-channel LVDS
Ethernet	2x Intel® I211AT or I210AT Gigabit LAN
I/O Chipset	Nuvoton NCT5523D
Serial Port	1x RS232/422/485 (jumper-less selection) 1x RS232
USB 2.0	2x USB 2.0 via pin header
USB 3.X	4x USB 3.0 on board
Serial ATA	2x SATA III
Audio	Intel® Pentium® SoC built-in HD audio controller + Realtek ALC888S codec
TPM	N/A
Others	Digital I/O, +9V~ +24V DC-in, iSMART
Dimensions (L x W)	102mm x 147mm (4" x 5.8")
Power Consumption	Intel® Pentium® N3700 1.6GHz w/ 2x 4GB DDR3L-1600, +12V: 1.5A
Operating Temperature	0°C~60°C ( 32°F~140°F)
Storage Temperature	-20°C~80°C (-4°F~176°F)
Relative Humidity	90% (non-condensing @60°C)

## Ordering Information

IB899FS-371	Intel® Pentium® N3710(2.56GHz) on board, 3.5" SBC w/ dual PCI-E GbE LAN, CRT, DVI-D & LVDS (24-bit LVDS dual-channel), mSATA, iSMART
IB899FS-301	Intel® Celeron® N3010(2.24GHz) on board, 3.5" SBC w/ dual PCI-E GbE LAN, CRT, DVI-D & LVDS (24-bit LVDS dual-channel), mSATA, iSMART
HSIB899-BGA-A	Heatsink for IB899
HSIB899-BGA-1	Heat Spreader for IB899
IB81	Cable kit w/ USB, COM, power, SATA + power, VGA, audio

\*(S) means with Realtek ALC888S codec

## Dimensions and Drawing

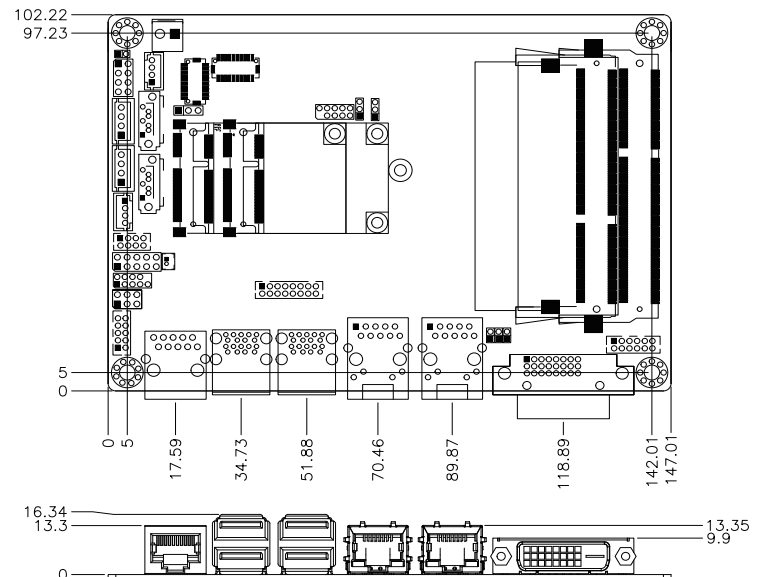

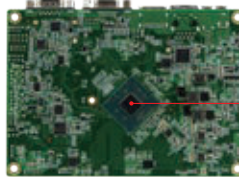
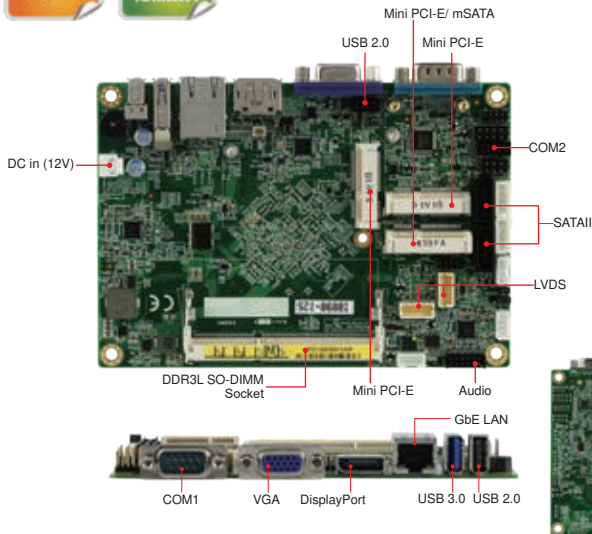

## Features

- Onboard Intel® Atom® E3825 DC/ E3815 SC SoC, 1.33GHz/1.46GHz
- 1x DDR3L-1066 SO-DIMM, Max. 8GB
- Supports VGA, DisplayPort and 24-bit dual-channel LVDS
- 1x Intel® I210IT Gigabit LAN
- Watchdog timer, Digital I/O, mSATA, iSMART
- 3x USB 2.0, 1x USB 3.0, 2x COM, 2x SATA II
- 3x Mini PCI-E slots (2x full-size, 1x half-size)
- Wide-range operating temperature

## Specifications

CPU	Intel® Atom® DC E3825 (1.33GHz, 1MB cache) Intel® Atom® SC E3815 (1.46GHz, 512KB cache)
PCH	Integratd in Intel® Atom® SoC
Memory	1x DDR3L-1066 SO-DIMM, Max 8GB (Non-ECC)
BIOS	AMI
Watchdog Timer	256 levels
H/W Monitor	Yes
Storage Device Interface	1x mSATA
Mini Type Slots	3x Mini PCI-E (2x full-size, 1x half-size)
Graphics Controller	Intel® Atom® SoC integrated Gen7 4EUs graphics
Video Output	Supports CRT, DisplayPort, and 24-bit dual-channel LVDS
Ethernet	1x Intel® I210IT Gigabit LAN
I/O Chipset	Nuvoton NCT5523D
Serial Port	1x RS232/422/485 (jumper-less selection) 1x RS232
USB 2.0	1x USB 2.0 on board 2x USB 2.0 via pin header
USB 3.X	1x USB 3.0 on board
Serial ATA	2x SATA II
Audio	Intel® Atom® SoC built-in HD Audio controller + Realtek ALC269QHD codec w/ class-D amplifier
TPM	N/A
Others	Digital I/O, +12V DC-In, iSMART Wide-range operating temperature
Dimensions (L x W)	102mm x 147mm (4" x 5.8")
Power Consumption	Intel® Atom® E3825 1.33GHz w/ 4GB DDR3L-1600 +12V: 0.65A
Operating Temperature	-40°C~85°C (-40°F~185°F)
Storage Temperature	-40°C~90°C (-40°F~194°F)
Relative Humidity	90% (non-condensing @60°C)

## Ordering Information

IB898-I25D1	Intel® Atom® E3825 (1.33GHz) 3.5" SBC w/ PCI-E GbE LAN, CRT, DisplayPort & LVDS (24-bit LVDS dual-channel), mSATA, iSMART, wide temp support
IB898-I15D1	Intel® Atom® E3815 (1.46GHz) 3.5" SBC w/ PCI-E GbE LAN, CRT, DisplayPort & LVDS (24-bit LVDS dual-channel), mSATA, iSMART 3.1, wide temp support
HSIB898-BGA-A	Heatsink for IB898
HSIB898-BGA-1	Heat spreader for IB898
IB76A-2	Cable kit w/ USB, COM, Power, SATA + Power cable

## Dimensions and Drawing

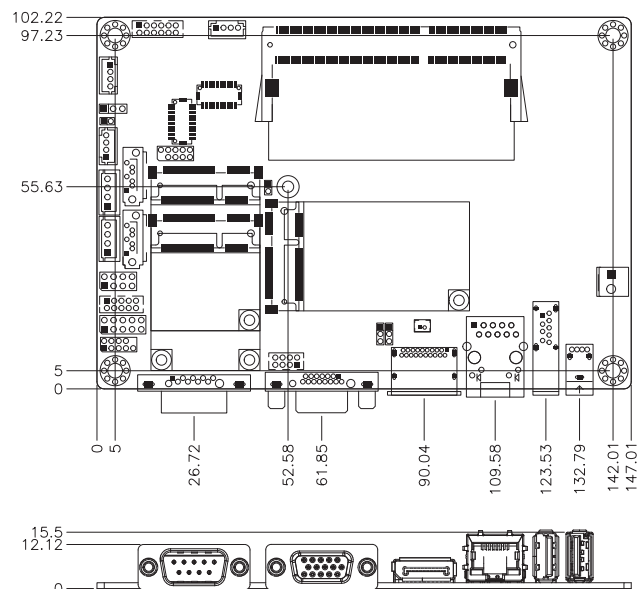



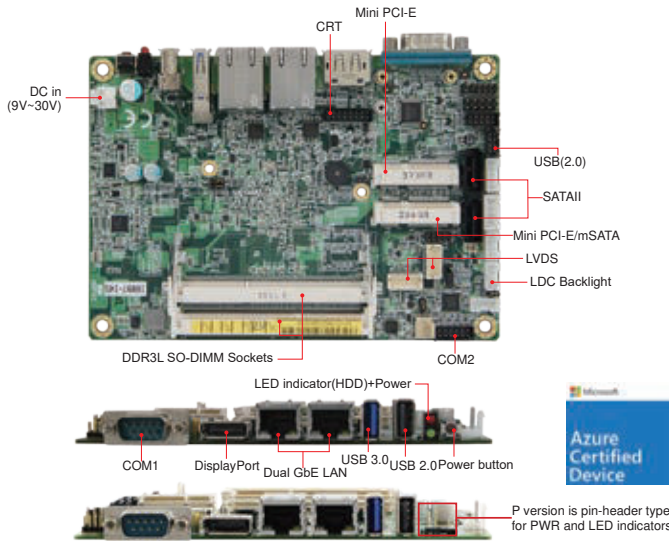

## Features

- Onboard Intel® Atom® E3845/E3827/E3815 SoC, 1.91GHz/1.75GHz/1.46GHz
- 2x DDR3L-1333 SO-DIMM, Max. 8GB
- Supports VGA, DisplayPort and 24-bit dual-channel LVDS
- 2x Intel® I210IT Gigabit LAN
- Watchdog timer, Digital I/O, mSATA, iSMART
- 3x USB 2.0, 1x USB 3.0, 2x COM, 2x SATA II, 1x MicroSD slot
- 2x Mini PCI-E slots (1x full-size, 1x half-size)
- Wide-range operating temperature



## Specifications

CPU	Intel® Atom® QC E3845 (1.91GHz, 2MB cache) Intel® Atom® DC E3827 (1.75GHz, 1MB cache) 2nd Atom® SC E3815 (1.46GHz, 512k cache)
PCH	Integrated in Intel® Atom® SoC
Memory	2x DDR3L-1333 SO-DIMM, Max 8GB (Non-ECC) 1x DDR3L-1333 SO-DIMM, (IB897-215 only)
BIOS	AMI
Watchdog Timer	256 levels
H/W Monitor	Yes
Storage Device Interface	1x mSATA, 1x MicroSD
Mini Type Slots	2x Mini PCI-E (1x full-size, 1x half-size)
Graphics Controller	Intel® Atom® SoC integrated Gen7 4EUs graphics
Video Output	Supports CRT, DisplayPort, and 24-bit dual-channel LVDS
Ethernet	2x Intel® I210IT Gigabit LAN
I/O Chipset	Nuvoton NCT5523D
Serial Port	1x RS232/422/485 (jumper-less selection) 1x RS232
USB 2.0	1x USB 2.0 on board 2x USB 2.0 via pin header
USB 3.X	1x USB 3.0 on board
Serial ATA	2x SATA III
Audio	Intel® Atom® SoC built-in HD Audio controller + Realtek ALC269Q HD codec w/ class-D amplifier
TPM	N/A
Others	Digital I/O, +9V~ +30V DC-In, iSMART
Dimensions (L x W)	102mm x 147mm (4" x 5.8")
Power Consumption	Intel® Atom® E3845 @ 1.91GHz w/ 2x Transcend 2GB DDR3L-1600 +12V: 1.57A
Operating Temperature	-40°C~85°C (-40°F~185°F)
Storage Temperature	-40°C~90°C (-40°F~194°F)
Relative Humidity	90% (non-condensing @60°C)

## Ordering Information

IB897-I45	Intel® Atom® E3845(1.91GHz) 3.5" SBC w/ dual PCI-E GbE LAN, CRT, DisplayPort & LVDS, mSATA, iSMART
IB897-I27	Intel® Atom® E3827(1.75GHz) 3.5" SBC w/ dual PCI-E GbE LAN, CRT, DisplayPort & LVDS, mSATA, iSMART
IB897-I15	Intel® Atom® E3815(1.46GHz) 3.5" SBC w/ dual PCI-E GbE LAN, CRT, DisplayPort & LVDS, mSATA, iSMART
IB897-I45P	Intel® Atom® E3845(1.91GHz) 3.5" SBC w/ dual PCI-E GbE LAN, CRT, DisplayPort & LVDS, mSATA, iSMART, pin-header type for power button and LED
IB897-I27P	Intel® Atom® E3827(1.75GHz) 3.5" SBC w/ dual PCI-E GbE LAN, CRT, DisplayPort & LVDS, mSATA, iSMART, pin-header type for power button and LED
HSIB897-BGA	Heatsink for IB897
HSIB897-BGA-1	Heat spreader for IB897
IB76-2	Cable kit w/ USB, COM, power, SATA + power, VGA

## Dimensions and Drawing

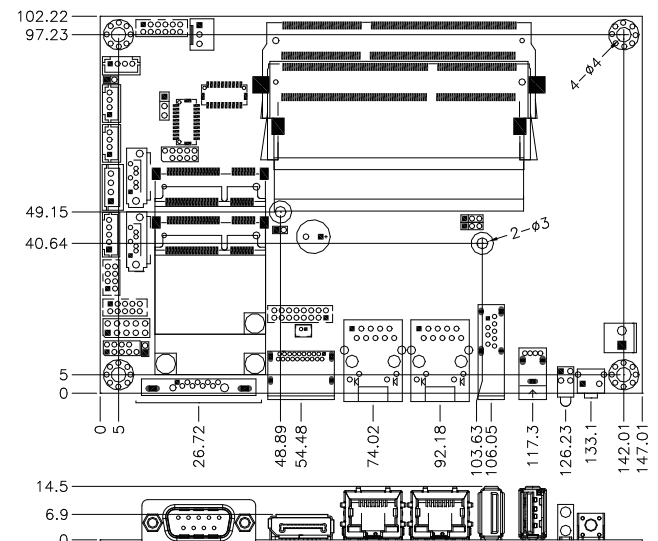

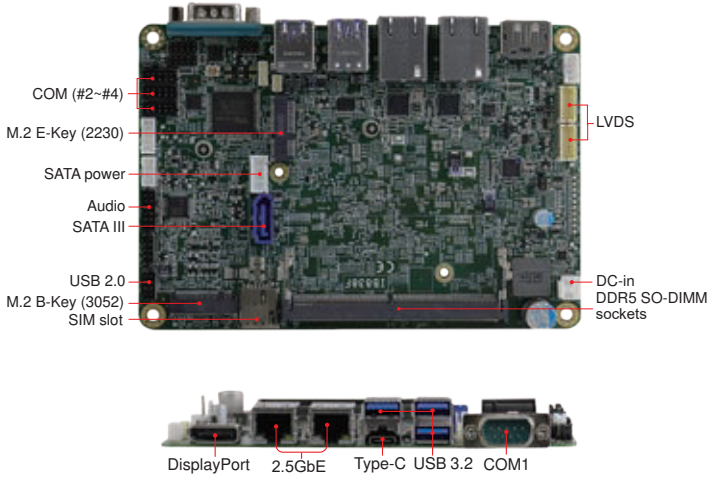

## Features

- Intel® Core™ i3 N-series Processor
- 1x DDR5 SO-DIMM, Max. 16GB , support IB ECC
- Supports Type-C & DP++ and eDP or LVDS
- 2x Intel® PCI-E 2.5G LAN
- 2x USB 2.0, 4x USB 3.2 (1x Type-C + 3x Type-A), 4x COM, 1x SATA III
- 2x M.2 socket (E-key + B-key)
- Supports fTPM, Watchdog timer, Digital I/O

## Specifications

CPU	Intel® Core™ i3 N-series Processor
PCH	N/A
Memory	1x DDR5 SO-DIMM, Max. 16GB
BIOS	AMI
Watchdog Timer	256 levels
H/W Monitor	Yes
Storage Device Interface	N/A
Mini Type Slots	2x M.2 socket (E-key+B-key)
Graphics Controller	Intel® SoC integrated Gen12 graphics
Video Output	3x Display [DP connector & Type-C & eDP or LVDS]
Ethernet	2x Intel® I226V LAN
I/O Chipset	Fintek F81964D-I on board
Serial Port	1x RS232/422/485 (Jumper-less selection) 3x RS232
USB 2.0	2x USB 2.0 via (pin header)
USB 3.X	1x Type-C + 3x Type-A
Serial ATA	1x SATA III
Audio	Intel® Core™ i3 Processor N-series & Intel® Processor N-series built-in HD audio + ALC888S codec
TPM	fTPM
Others	Digital I/O (4-in/4-out), EuP/ErP, +9V~ +36V DC-in
Dimensions (L x W)	102mm x 147mm (4" x 5.8")
Power Consumption	TBD
Operating Temperature	0°C~60°C (-4°F~140°F)
Storage Temperature	-20°C~80°C (-4°F~176°F)
Relative Humidity	10% ~ 90% (non-condensing)

## Ordering Information

IB838F-N305	3.5" Intel® Core i3-N305 SoC onboard, 2x 2.5GbE, DisplayPort + Type-C + LVDS, 4x COM, 2x M.2 (E-key+B-key), 1x SATA III, fTPM, DC-in (9V~36V)
IB838FE-N305	3.5" Intel® Core i3-N305 SoC onboard, 2x 2.5GbE, DisplayPort + Type-C + eDP, 4x COM, 2x M.2 (E-key+B-key), 1x SATA III, fTPM, DC-in (9V~36V)
IB838F-N50	3.5" Intel® N50 SoC onboard, 2x 2.5GbE, DisplayPort + Type-C + LVDS, 4x COM, 2x M.2 (E-key+B-key), 1x SATA III, fTPM, DC-in (9V~36V)
IB838FE-N50	3.5" Intel® N50 SoC onboard, 2x 2.5GbE, DisplayPort + Type-C + eDP, 4x COM, 2x M.2 (E-key+B-key), 1x SATA III, fTPM, DC-in (9V~36V)

## Dimensions and Drawing

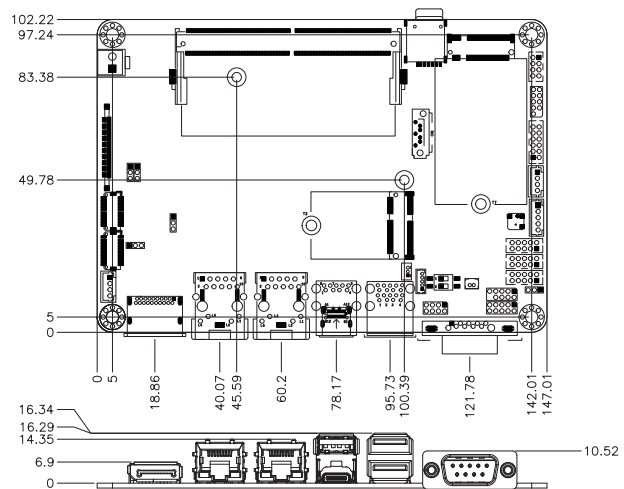



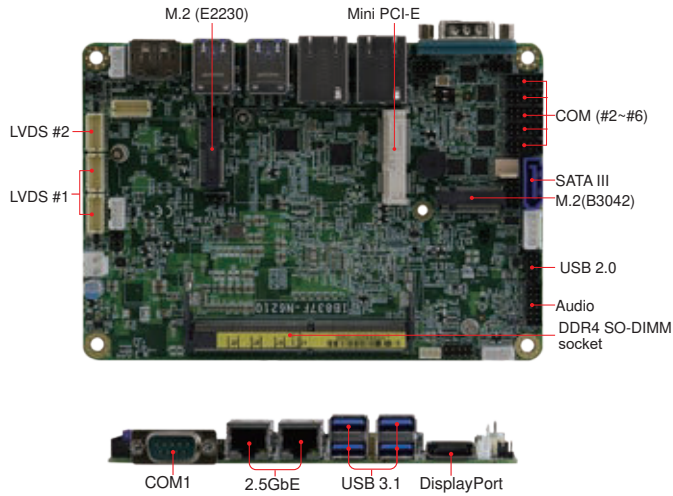

## Features

- Onboard Intel® Celeron® N & J series processor
- 1x DDR4-3200 SO-DIMM, Max. 16GB
- Supports 1x DisplayPort & 2x dual channel LVDS
- 2x I226V PCI-E 2.5G LAN, 6x COM ports
- 4x USB 3.1, 2x USB 2.0, 1x SATA III (shared with M/2 B-key)
- 2x M.2 sockets (E-key & B-key), 1x Mini PCI-E slot (full-size)
- Watchdog timer, Digital I/O, fTPM, mSATA, 12V only DC-in

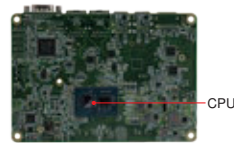

1 CPU Modules

2 Single Board Computers

3 Motherboards

4 CPU Cards

## Specifications

CPU	Intel® Celeron® QC J6412 (2.0GHz/2.6GHz) Intel® Celeron® DC N6210 (1.2GHz/2.6GHz)
PCH	N/A
Memory	1x DDR4 SO-DIMM, Max. 16GB
BIOS	AMI
Watchdog Timer	256 levels
H/W Monitor	Yes
Storage Device Interface	1x mSATA 1x M.2 B3042
Mini Type Slots	1x Mini PCI-E, 1x M.2 (E2230), 1x M.2 (B3042)
Graphics Controller	Intel® SoC integrated Gen11 Graphics
Video Output	1x DisplayPort, 2x 24-bit dual-channel LVDS
Ethernet	2x Intel® I226V PCI-E Gigabit LAN
I/O Chipset	Fintek F81966D-I
Serial Port	1x RS232/422/485 (Jumperless selection) & 5x RS232
USB 2.0	2x USB 2.0 (pin-header)
USB 3.X	4x USB 3.1 (Type A)
Serial ATA	1x SATA III (shared with M.2 B-key)
Audio	Built-in HD with Realtek ALC888S + amplifier
TPM	fTPM
Others	Digital I/O (4-in/4-out), +12V DC-in
Dimensions (L x W)	102mm x 147mm (4" x 5.8")
Power Consumption	Intel® Celeron® J6412 2.00GHz w/ 8GB DDR4-3200 +12V:1.57A
Operating Temperature	0°C~60°C (32°F ~140°F)
Storage Temperature	-20°C~80°C (-4°F ~176°F)
Relative Humidity	95% (non-condensing@60°C)

## Ordering Information

IB837F-J6412	Intel® Celeron® J6412 (2GHz~2.6GHz) onboard 3.5-inch SBC, w/ 2x 2.5GbE LAN, 1x DisplayPort, 2x LVDS (24-bit LVDS Dual channel), mSATA, M.2, 12V DC-in
IB837F-N6210	Intel® Celeron® N6210 (1.2GHz~2.6GHz) onboard 3.5-inch SBC, w/ 2x 2.5GbE LAN, 1x DisplayPort, 2x LVDS (24-bit LVDS Dual channel), mSATA, M.2, 12V DC-in
HSIB837-A	Heatsink for IB837
HSIB837-1	Heat spreader for IB837

## Dimensions and Drawing

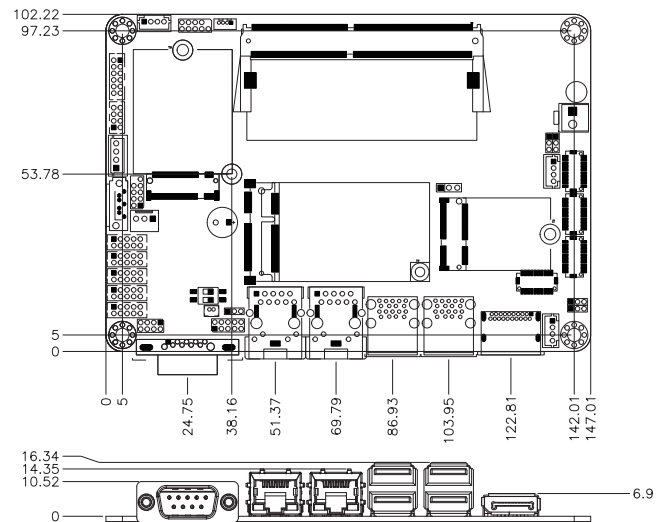

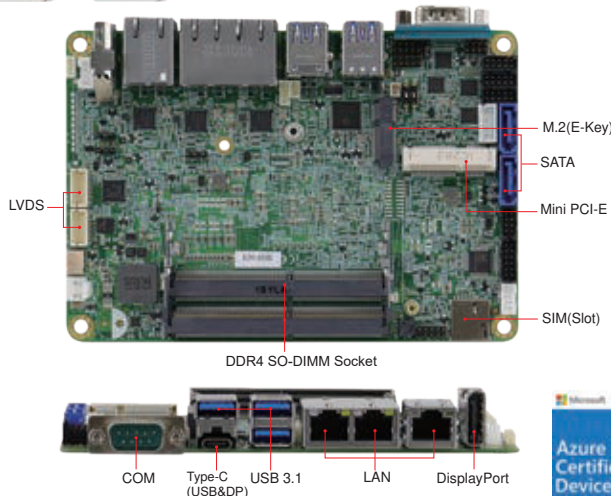

### Features

- Onboard Intel® Atom® x6000 Series processor
- 2x DDR4-3200 SO-DIMM, Max.32GB, supports IB ECC
- Supports 2x DisplayPort (DP and Type-C), eDP or 24-bit dual-channel LVDS
- 3x Intel® 2.5G LAN
- 2x USB 2.0, 4x USB 3.1, 2x SATA III
- 1x M.2 sockets (E-Key), 1x Mini PCI-E slot (full-size)
- Watchdog timer, Digital I/O, TPM (2.0), mSATA(Share with SATA port)
- Wide-range operating temperature from -20°C to 85°C

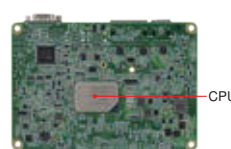

### Specifications

CPU	Intel® Atom® QC x6425E (1.8GHz/3.0GHz) Intel® Atom® QC x6413E (1.5GHz/3.0GHz) Intel® Atom® DC x6211E (1.2GHz/3.0GHz) Intel® Celeron® DC N6210 (1.2GHz/2.6GHz) Intel® Celeron® QC J6413 (1.8GHz/ 3.0GHz)
PCH	Integrated in Intel® SoC
Memory	DDR4-3200 SO-DIMM, Max. 32GB, (supports IB ECC based on CPU)
BIOS	AMI
Watchdog Timer	256 levels
H/W Monitor	Yes
Storage Device Interface	1x mSATA (Share with SATA port)
Mini Type Slots	1x M.2 (E-Key, type:2230) 1x Mini PCI-E (full-size)
Graphics Controller	Intel® SoC integrated Gen11 Graphics
Video Output	2x DisplayPort (DP connector & Type-C) eDP or 24-bit dual-channel LVDS
Ethernet	3x Intel® I225IT 2.5G LAN for Atom® (x6000) 3x Intel® I225V 2.5G LAN for Celeron®/ Pentium®
I/O Chipset	Fintek F81964D-I
Serial Port	1x RS232/422/485 (Jumper-less selection) 3x RS232
USB 2.0	2x USB 2.0 (Pin-header)
USB 3.X	3x USB 3.1 (Type-A) 1x USB (Type-C)
Serial ATA	2x SATA III
Audio	Built-in HD with Realtek ALC888S w/ class-D amplifier
TPM	TPM (2.0)
Others	Digital I/O (4-in/4-out), EuP/ErP, +9V~+36V DC-in
Dimensions (L x W)	102mm x 147mm (4" x 5.8")
Power Consumption	Intel® Atom® x6413E 1.5GHz w/ 2x DD4 3200 16GB +12V: 1.87A
Operating Temperature	Atom® x6000: -20°C~85°C(-4°F~185°F) Celeron®/ Pentium®: 0°C~60°C (0°F~140°F)
Storage Temperature	-40°C~85°C (-40°F ~185°F)
Relative Humidity	90% (non-condensing@60°C)

IB836F(E)-6413E	Intel® Atom® x6413E (1.5GHz~3.0GHz) 3.5" SBC w/ 3x 2.5G LAN, 2x DisplayPort (DP connector& Type-C), eDP or LVDS, mSATA, M.2, EuP/ErP, 9V~36V DC-in, wide temperature support
IB836F(E)-6211E	Intel® Atom® x6211E (1.2GHz~3.0GHz) 3.5" SBC w/ 3x 2.5G LAN, 2x DisplayPort (DP connector& Type-C), eDP or LVDS, mSATA, M.2, EuP/ErP, 9V~36V DC-in, wide temperature support
IB836F(E)-N6210	Intel® Celeron® N6210 (1.2GHz/2.6GHz) 3.5" SBC w/ 3x 2.5G LAN, 2x DisplayPort (DP connector& Type-C), eDP or LVDS (24-bit LVDS Dual channel), mSATA, M.2, EuP/ErP, 9V~36V DC-in
IB836F-J6413	Intel® Celeron® J6413 (1.8GHz/3.0GHz) 3.5" SBC w/ 3x 2.5G LAN, 2x DisplayPort (DP connector& Type-C), LVDS (24-bit LVDS Dual channel), mSATA, M.2, EuP/ErP, 9V~36V DC-in
HSIB836-X-2	Heat Spreader for IB836F/FE (Atom® x6000)
HSIB836-X-B	Heatsink for IB836 F/FE(Atom® x6000)
HSIB836-2	Heat Spreader for IB836F/FE (Celeron®/Pentium®)
HSIB836-B	Heatsink for IB836F/FE (Celeron®/Pentium®)

\*model name with "F" is LVDS, "FE" is eDP

### Dimensions and Drawing

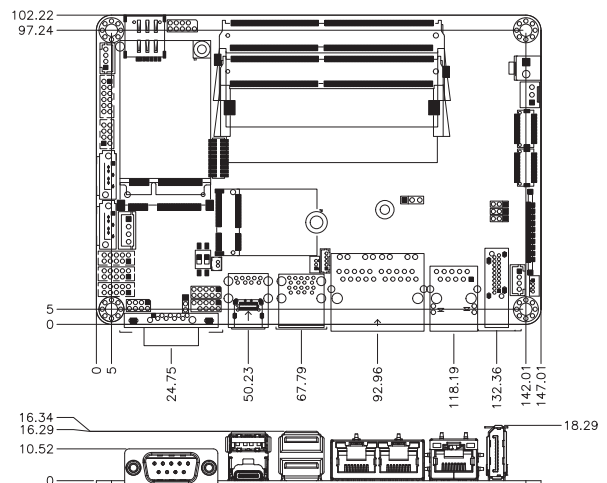

### Ordering Information

IB836F(E)-6425E	Intel® Atom® x6425E (1.8GHz~3.0GHz) 3.5" SBC w/ 3x 2.5G LAN, 2x DisplayPort (DP connector& Type-C), eDP or LVDS, mSATA, M.2, EuP/ErP, 9V~36V DC-in, wide temperature support
-----------------	--

Remarks: 1. Specifications are subject to change without prior notice. 2. ODM/OEM is available. 3. For user's manual & datasheet download, visit [www.ibase.com.tw](http://www.ibase.com.tw).

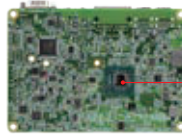
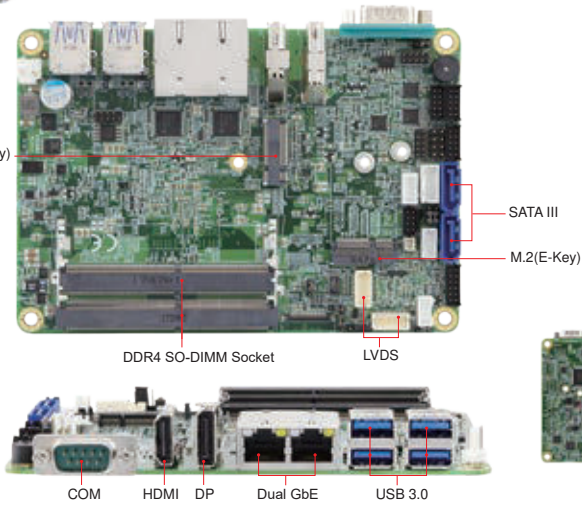

IB822 with Heat spreader

IB822 with Heatsink

COM, HDMI, DP, Dual GbE, USB 3.0

## Specifications

CPU	Intel® Pentium® Silver J5040 Processor
PCH	Integrated in Intel® SoC
Memory	2x DDR4-2400 SO-DIMM sockets, Max, 8GB
BIOS	AMI
Watchdog Timer	256 levels
H/W Monitor	Yes
Storage Device Interface	N/A
Mini Type Slots	1x M.2 (B-key, type: 2242) 1x M.2 (E-key, type: 2230)
Graphics Controller	Intel® UHD Graphics 605
Video Output	Supports HDMI(2.0a), DisplayPort and eDP or 18/24-bit dual-channel LVDS
Ethernet	2x Intel® I210AT Gigabit LAN
I/O Chipset	Fintek F81964D-I
Serial Port	3x RS232 1x RS232/422/485 (jumper-less selection)
USB 2.0	2x USB 2.0
USB 3.X	4x USB 3.0 (5Gb/s)
Serial ATA	2x SATA III
Audio	Intel® Pentium® SoC built-in HD Audio controller + Realtek ALC233-VB2-CG Codec w/ class-D speaker amplifier
TPM	N/A
Others	iSMART 3.5, Digital I/O, 12V~24V (DC-in)
Dimensions (L x W)	102mm x 147mm
Power Consumption	Intel® Celeron® J4005 2.0GHz w/ 2x 8GB DDR4-2133 + 12V: 1.58A
Operating Temperature	0°C~60°C (32°F~140°F)
Storage Temperature	-20°C~80°C (-4°F~176°F)
Relative Humidity	90% (non-condensing @60°C)

## Features

- Onboard Pentium® Silver SoC
- 2x DDR4-2400 SO-DIMM sockets, Max, 8GB
- Supports HDMI(2.0a), DisplayPort and eDP or 18/24-bit dual-channel LVDS
- Dual Intel® Gigabit LAN
- 2x M.2 sockets (B/ E key)
- Digital I/O, iSMART, Watchdog timer

## Ordering Information

IB822F-J5040	Intel® Pentium® Silver J5040 (2.0GHz~3.0GHz) 3.5" SBC w/ dual GbE LAN, HDMI(2.0a), DisplayPort, & eDP or 18/24-bit dual-channel LVDS), 2x M.2, 2V~24V DC-in
IB822-B	Heatsink for IB822 series
IB822-1	Heatsink spreader for IB822 series
IB76A-2	Cable kit w/ USB, COM, Power, SATA + Power

## Dimensions and Drawing

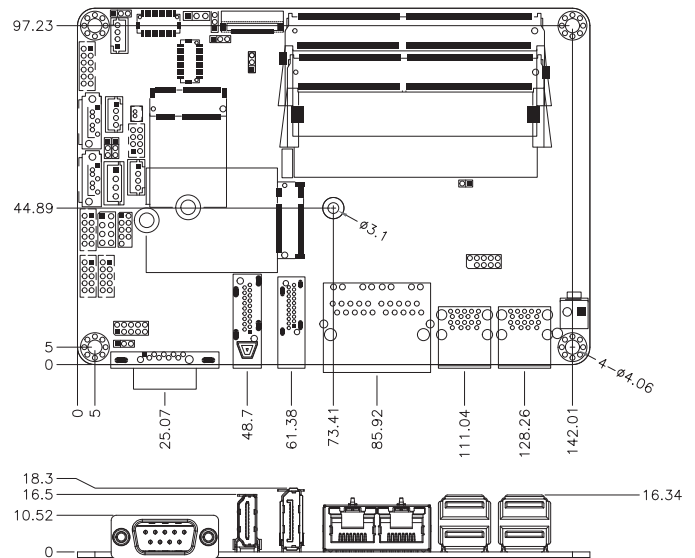



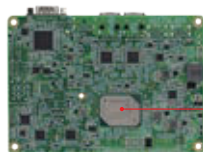
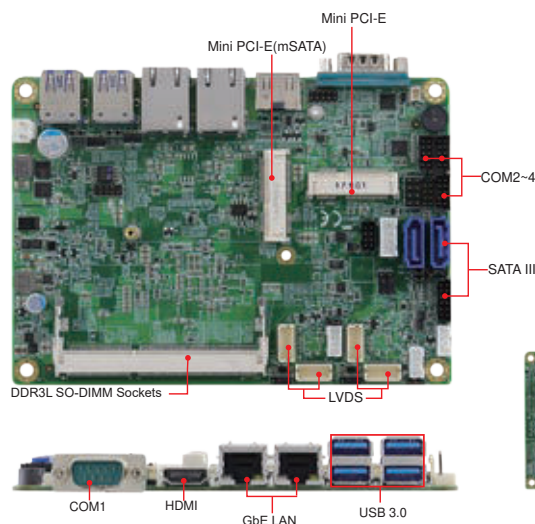

IB818 with Heat spreader



IB818 with Heatsink

## Specifications

CPU	Intel Atom® x7-E3950 Processor (1.6GHz~2.0GHz) Intel Atom® x5-E3940 Processor (1.6 GHz~1.8GHz) Intel Atom® x5-E3930 Processor (1.3 GHz~1.8GHz) Intel® Pentium® Processor N4200 (1.1GHz~ 2.5GHz) Intel® Celeron® Processor N3350 (1.1GHz~ 2.4GHz) Intel® Celeron® Processor J3455(1.5GHz~ 2.3GHz)
PCH	Integrated in Intel® SoC
Memory	1x DDR3L SO-DIMM, Max 8GB (Non-ECC)
BIOS	AMI
Watchdog Timer	256 levels
H/W Monitor	Yes
Storage Device Interface	1x mSATA (Via full-size Mini PCI-E)
Mini Type Slots	2x Mini PCI-E (1x full-size, 1x half-size)
Graphics Controller	Intel® SoC integrated Gen9 18EUs graphics
Video Output	Supports HDMI(1.4b), Dual LVDS (18/24bit)
Ethernet	IB818F-I50 2x Intel® I210IT Gigabit LAN IB818F-420/335: 2x Intel® I211AT or I210AT Gigabit LAN
I/O Chipset	Fintek F81964D-I
Serial Port	1x RS232/422/485 (jumper-less selection) 3x RS232
USB 2.0	2x USB 2.0 via pin-header
USB 3.X	4x USB 3.0 on board
Serial ATA	2x SATA III
Audio	Intel® Atom® SoC built-in HD audio controller + Realtek ALC888S Codec w/ class-D speaker amplifier
TPM	TPM2.0
Others	Digital I/O, +12V~+24V DC-in, EuP/ErP
Dimensions (L x W)	102 x 147 mm (4" x 5.8")
Power Consumption	Intel® Atom® E3950, 1.6GHz w/ 8GB DDR3L +12V: 1.09A Intel Pentium N4200, 1.1GHz w/ 8GB DDR3L +12V: 1.09A
Operating Temperature	E3950: -40°C ~ +85°C (-40°F ~ 185°F) N4200/N3350: 0°C ~ +60°C (32°F ~ 140°F)
Storage Temperature	-40°C ~ 90°C (-40°F ~ 194°F)
Relative Humidity	90% (non-condensing @60°C)

## Features

- Onboard Intel® Atom® x7-E3950/ x5-E3940/ x5-E3930 Processor [i-Temp support]
- Onboard Intel® Pentium® N4200/ Celeron® N3350/ J3455
- 1x DDR3L-1866 SO-DIMM, Max. 8GB
- Supports HDMI 1.4b, **Dual LVDS(18/24bit)**
- Dual Intel® Gigabit LAN
- Watchdog timer, Digital I/O, mSATA, EuP/ErP
- 4x USB 3.0, 2x USB 2.0, 4x COM, 2x SATA III
- 1x Mini PCI-E slot (full-size), 1x Mini PCI-E slot (half-size)
- Wide-range operating temperature in certain models

## Ordering Information

IB818F-I50	Intel® Atom®x7-E3950 (1.6GHz~2.0 GHz) 3.5" SBC w/ dual GbE LAN, HDMI, 2x LVDS (18/24-bit LVDS dual-channel), EuP/ErP, 12V~24V DC-in, wide temp support
IB818F-I40	Intel® Atom®x5-E3940 (1.6GHz~1.8 GHz) 3.5" SBC w/ dual GbE LAN, HDMI, 2x LVDS (18/24-bit LVDS dual-channel), EuP/ErP, 12V~24V DC-in, wide temp support
IB818F-I30	Intel® Atom®x5-E3930 (1.3GHz~1.8 GHz) 3.5" SBC w/ dual GbE LAN, HDMI, 2x LVDS (18/24-bit LVDS dual-channel), EuP/ErP, 12V~24V DC-in, wide temp support
IB818F-420	Intel® Pentium® N4200 (1.1GHz~2.5GHz) 3.5" SBC w/ dual GbE LAN, HDMI, 2x LVDS (18/24-bit LVDS dual-channel), EuP/ErP, 12V~24V DC-in
IB818F-335	Intel® Celeron® N3350 (1.1GHz~2.4GHz) 3.5" SBC w/ dual GbE LAN, HDMI, 2x LVDS (18/24-bit LVDS dual-channel), EuP/ErP, 12V~24V DC-in
IB818F-J3455	Intel® Celeron® J3455 (1.5GHz/2.3GHz) 3.5" SBC w/ dual GbE LAN, HDMI, 2x LVDS (18/24-bit LVDS Dual channel), EuP/ErP, 12V~24V DC-in
HSIB818-I	Heatsink for IB818-I50/I40/I30
HSIB818	Heatsink for IB818-420/335/J3455
HSIB818-I-1	Heat Spreader for IB818-I50/I40/I30
HSIB818-1	Heat Spreader for IB818-420/335/J3455
IB76A-1	Cable kit w/ USB, COM, Power, SATA+Power

## Dimensions and Drawing

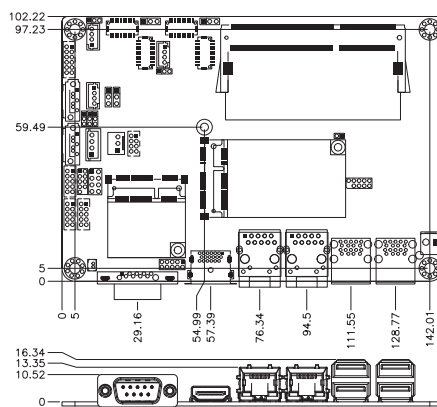

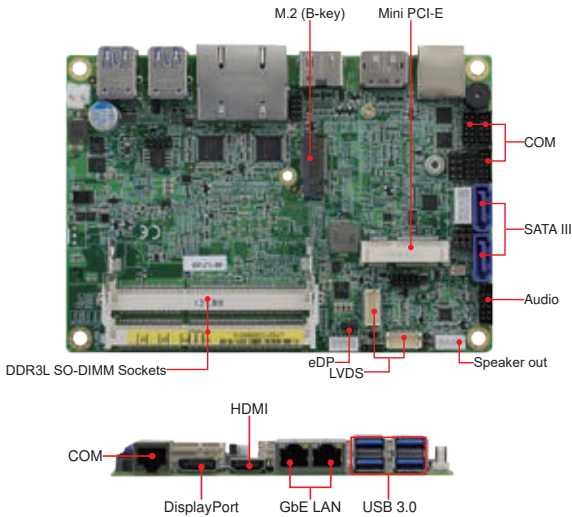

### Features

- Onboard Intel® Atom® x7-E3950/ x5-E3940/ x5-E3930 Processor [i-Temp support]
- Onboard Intel® Pentium® N4200/ Celeron® N3350
- 2x DDR3L-1866/1600 SO-DIMM, Max. 8GB
- Supports HDMI(1.4b), DisplayPort 24 bit dual-channel LVDS
- Dual Intel® Gigabit LAN
- Watchdog timer, Digital I/O, mSATA, EuP/ErP
- 4x USB 3.0, 2x USB 2.0, 4x COM, 2x SATA III
- 1x Mini PCI-E slot (full-size), 1x M.2 (B-key)
- Wide-range operating temperature in certain models

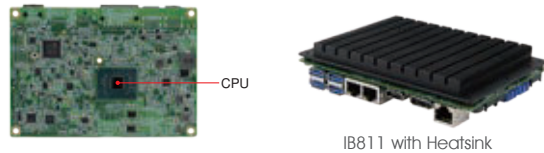

1 CPU Modules

2 Single Board Computers

3 Motherboards

4 CPU Cards

### Specifications

CPU	Intel Atom® x7-E3950 Processor (1.6GHz~2.0GHz) Intel Atom® x5-E3940 Processor (1.6 GHz~1.8GHz) Intel Atom® x5-E3930 Processor (1.3 GHz~1.8GHz) Intel® Pentium® Processor N4200 (1.1GHz~ 2.5GHz) Intel® Celeron® Processor N3350 (1.1GHz~ 2.4GHz)
PCH	Integrated in Intel® SoC
Memory	2x DDR3L SO-DIMM, Max 8GB (Non-ECC)
BIOS	AMI
Watchdog Timer	256 levels
H/W Monitor	Yes
Storage Device Interface	1x mSATA
Mini Type Slots	1x Mini PCI-E (full-size), 1x M.2 (B-key, type:3042)
Graphics Controller	Intel® SoC integrated Gen9 18EUs graphics
Video Output	Supports HDMI(1.4b), DP(1.2), 24-bit dual-channel LVDS
Ethernet	IB811F-150/140/130: 2x Intel® I210IT Gigabit LAN IB811F-420/335: 2x Intel® I211AT or I210AT Gigabit LAN
I/O Chipset	Fintek F81964D-I
Serial Port	1x RS232/422/485 (jumper-less selection) 3x RS232
USB 2.0	2x USB 2.0 via pin-header
USB 3.X	4x USB 3.0 on board
Serial ATA	2x SATA III
Audio	Intel® Atom® SoC built-in HD audio controller + Realtek ALC888SHD Codec w/ class-D speaker amplifier
TPM	TPM 2.0
Others	Digital I/O, +9V~ +36V DC-In, EuP/ErP
Dimensions (L x W)	102mm x 147mm (4" x 5.8")
Power Consumption	Intel® Atom® E3900 1.3GHz w/ 2x DDR3L 1600 4GB +12V: 1.2A
Operating Temperature	E3950/E3940/E3930: -40°C~85°C ( -40°F~185°F ) N4200/N3350: 0°C~60°C ( 32°F~140°F )
Storage Temperature	-40°C~90°C ( -40°F~194°F)
Relative Humidity	90% (non-condensing @60°C)

### Ordering Information

IB811LF-150	Intel® Atom® x7-E3950 (1.6GHz~2.0GHz) 3.5" SBC w/ dual GbE LAN, HDMI, DisplayPort & LVDS (24-bit LVDS dual-channel), mSATA, M.2, EuP/ErP, 9V~36V DC-in, wide temp. support
IB811LF-140	Intel® Atom® x5-E3940 (1.6GHz~1.8GHz) 3.5" SBC w/ dual GbE LAN, HDMI, DisplayPort & LVDS (24-bit LVDS dual-channel), mSATA, M.2, EuP/ErP, 9V~36V DC-in, wide temp. support
IB811LF-130	Intel® Atom® x5-E3930 (1.3~1.8GHz) 3.5" SBC w/ dual GbE LAN, HDMI, DisplayPort & LVDS (24-bit LVDS dual-channel), mSATA, M.2, EuP/ErP, 9V~36V DC-in, wide temp. support
IB811LF-420	Intel® Pentium® N4200 (1.1~2.5GHz) 3.5" SBC w/ dual GbE LAN, HDMI, DisplayPort & LVDS (24-bit LVDS dual-channel), mSATA, M.2, EuP/ErP, 9V~36V DC-in
IB811LF-335	Intel® Celeron® N3350 (1.1~2.4GHz) 3.5" SBC w/ dual GbE LAN, HDMI, DisplayPort & LVDS (24-bit LVDS dual-channel), mSATA, M.2, EuP/ErP, 9V~36V DC-in
HSIB811-B	Heatsink for IB811F-420/ 335
HSIB811-I-A	Heatsink for IB811F-150/ I40/ I30
HSIB811-1	Heat spreader for IB811F-420/ 335
HSIB811-I-1A	Heat spreader for IB811F-150/ I40/ I30
IB76A-2	Cable kit w/ USB, COM, Power, SATA + Power

### Dimensions and Drawing

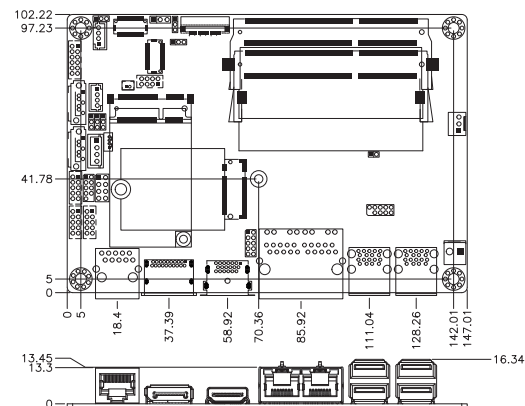



# Recommended 13th/12th Gen Intel® Desktop Processors List

Processor	Number of Core	Base ~ Turbo (Max.)	TDP	L3 Cache	Compatible IBASE M/B, Mini-ITX, CPU Card Models	Use Condition Embedded
i7-12800HL	14	P-core:4.8GHz; E-core:3.7GHz	45 W	24MB	MI997	Yes (10 years)
i7-12700HL	14	P-core:4.7GHz; E-core:3.5 GHz	45 W	24MB	MI997	Yes (10 years)
i5-12600HL	12	P-core:4.5GHz; E-core:3.3 GHz	45 W	18MB	MI997	Yes (10 years)
i5-12500HL	12	P-core:4.5GHz; E-core:3.3 GHz	45 W	18MB	MI997	Yes (10 years)
i3-12300HL	8	P-core:4.4GHz; E-core:3.3 GHz	45 W	12MB	MI997	Yes (10 years)
i7-1265UL	10	P-core:4.8GHz; E-core:3.6 GHz	15 W	12MB	MI997	Yes (10 years)
i7-1255UL	10	P-core:4.7GHz; E-core:3.5 GHz	15 W	12MB	MI997	Yes (10 years)
i5-1245UL	10	P-core:4.3GHz; E-core:3.3 GHz	15 W	12MB	MI997	Yes (10 years)
i5-1235UL	10	P-core:4.4GHz; E-core:3.3 GHz	15 W	12MB	MI997	Yes (10 years)
i3-1215UL	6	P-core:4.4GHz; E-core:3.3 GHz	15 W	10MB	MI997	Yes (10 years)
Celeron® Processor 7305L	5	N/A	15 W	8MB	MI997	Yes (10 years)
Processor	Number of Core	Base ~ Turbo (Max.)	TDP	L3 Cache	Compatible IBASE M/B, Mini-ITX, CPU Card Models	Use Condition Embedded
i9-13900TE	24	5.0GHz	35W	36MB	MBB-1000/MB998	Yes (5 years)
i9-13900E	24	5.2GHz	65W	36MB	MBB-1000/MB998	Yes (10 years)
i7-13700TE	16	4.8GHz	35W	30MB	MBB-1000/MB998	Yes (10 years)
i7-13700E	16	5.1GHz	65W	30MB	MBB-1000/MB998	Yes (10 years)
i5-13500TE	14	4.5GHz	35W	24MB	MBB-1000/MB998	Yes (10 years)
i5-13500E	14	4.6GHz	65W	24MB	MBB-1000/MB998	Yes (10 years)
i3-13100TE	4	4.1GHz	35W	12MB	MBB-1000/MB998	Yes (10 years)
i3-13100E	4	4.4GHz	65W	12MB	MBB-1000/MB998	Yes (10 years)
Pentium® Gold G7400TE	4	3.0GHz	35W	6MB	MBB-1000/MB998	Yes (10 years)
Pentium® Gold G7400E	2	3.6GHz	46W	6MB	MBB-1000/MB998	Yes (10 years)
Celeron® Processor G6900TE	2	2.4GHz	35W	4MB	MBB-1000/MB998	Yes (10 years)
Celeron® Processor G6900E	2	3.0GHz	46W	4MB	MBB-1000/MB998	Yes (10 years)

1 CPU Modules

2 Single Board Computers

3 Motherboards

4 CPU Cards

# Recommended 12th/10th Gen Intel® Desktop Processors List

Processor	Number of Core	Base ~ Turbo	TDP	Smart Cache	Compatible IBASE M/B, Mini-ITX, CPU Card Models	Use Condition Embedded
Xeon® W-1250E	6	3.50 GHz ~ 4.70 GHz	80W	12 MB	MI999	Yes (15 years)
Xeon® W-1250TE	6	2.40 GHz ~ 3.80 GHz	35W	12 MB	MI999	Yes (15 years)
Xeon® W1270TE	8	2.00 GHz ~ 4.40 GHz	35W	16 MB	MI999	Yes (15 years)
i9-10900E	10	1.80 GHz ~ 4.40 GHz	65W	20MB	MI999	Yes (15 years)
i9-10900TE	10	2.80 GHz ~ 4.70 GHz	35W	20 MB	MI999	Yes (15 years)
i7-10700E	8	1.80 GHz ~ 4.50 GHz	65W	20 MB	MI999	Yes (15 years)
i7-10700TE	8	2.90 GHz ~ 4.50 GHz	35W	16 MB	MI999	Yes (15 years)
i5-10500E	6	2.00 GHz ~ 4.40 GHz	65W	16 MB	MI999	Yes (15 years)
i5-10500TE	6	3.10 GHz ~ 4.20 GHz	35W	12 MB	MI999	Yes (15 years)
i3-10100E	4	2.30 GHz ~ 3.70 GHz	65W	12 MB	MI999	Yes (15 years)
i3-10100TE	4	3.20 GHz ~ 3.80 GHz	35W	6 MB	MI999	Yes (15 years)
Pentium Gold G6400E	2	2.30 GHz ~ 3.60 GHz	58W	6 MB	MI999	Yes (15 years)
Pentium Gold G6400TE	2	3.80GHz	35W	4MB	MI999	Yes (15 years)
Celeron G5900E	2	3.20GHz	58W	4MB	MI999	Yes (15 years)
Celeron G5900TE	2	3.20GHz	35W	2MB	MI999	Yes (15 years)
Processor	Number of Core	Base ~ Turbo (Max.)	TDP	L2 Cache	Compatible IBASE M/B, Mini-ITX, CPU Card Models	Use Condition Embedded
i9-12900TE	16	5.0GHz	35W	14MB	MBB-1000/MB998	Yes (10 years)
i9-12900E	16	4.8GHz	65W	14MB	MBB-1000/MB998	Yes (5 years)
i7-12700TE	12	4.6GHz	35W	12MB	MBB-1000/MB998	Yes (10 years)
i7-12700E	12	4.8GHz	65W	12MB	MBB-1000/MB998	Yes (10 years)
i5-12500TE	6	4.3GHz	35W	7.5MB	MBB-1000/MB998	Yes (10 years)
i5-12500E	6	4.5GHz	65W	7.5MB	MBB-1000/MB998	Yes (10 years)
i3-12100TE	4	4.0GHz	35W	5MB	MBB-1000/MB998	Yes (10 years)
i3-12100E	4	4.2GHz	65W	5MB	MBB-1000/MB998	Yes (10 years)
Pentium® Gold G7400TE	2	3.0GHz	35W	2.5MB	MBB-1000/MB998	Yes (10 years)
Pentium® Gold G7400E	2	3.6GHz	65W	2.5MB	MBB-1000/MB998	Yes (10 years)
Celeron® Processor G6900TE	2	2.40GHz	35W	4MB	MBB-1000/MB998	Yes (10 years)
Celeron® Processor G6900E	2	3.00GHz	46W	4MB	MBB-1000/MB998	Yes (10 years)

1

CPU Modules

2

Single Board Computers

3

Motherboards

4

CPU Cards

# Comparison Table

## ATX Motherboard

Models	MB990	MB991	MB995	MB997	MB998	MBB-1000
<b>Form Factor</b>	ATX	Micro ATX	ATX	ATX	Micro ATX	ATX
<b>CPU Socket</b>	LGA1151	LGA1151	LGA1151	LGA1151	LGA1700	LGA1700
<b>CPU</b>	7th/6th Gen Intel® Core™ i7/i5/i3 / Pentium® / Celeron® DT CPU	7th/6th Gen Intel® Xeon® / Core™ i7/i5/i3 / Pentium® / Celeron® DT CPU	8th Gen Intel® Xeon® E / Core™ i7/i5/i3 DT processors	9th Gen Intel® Core™ i7/i5/i3 / Pentium® / Celeron® DT CPU	13th/12th Gen Intel® Core i9/i7/i5/i3™ and Pentium® / Celeron® Processors	12th Gen Intel® Core™ i9 / i7/i5/i3 / Pentium® Gold / Celeron® DT CPU
<b>CPU Max. Frequency</b>	Up to 4.0GHz	Up to 4.0GHz	Up to 4.7GHz	Up to 4.7GHz	Up to 2.5GHz	Up to 5.0GHz
<b>PCH</b>	Intel® Q170 PCH	Intel® C236 / Q170 PCH	Intel® C246 / Q370 PCH	Intel® C246 / Q370 / H310 PCH	Intel® R680E / Q670E / W680 PCH	Intel® R680E / Q670E PCH
<b>Memory</b>	4x DDR4 DIMM	2x DDR4 DIMM	4x DDR4 DIMM	4x DDR4 DIMM	2x DDR5 DIMM	4x DDR4 DIMM
<b>Max. Memory Size</b>	64GB	64GB	64GB	64GB	64GB	128GB
<b>BIOS</b>	AMI	AMI	AMI	AMI	AMI	AMI
<b>Graphics Controller</b>	Intel® Core™ i integrated graphics	Intel® Core™ i integrated graphics	8th Gen Intel® Xeon® E / Core™ i7/i5/i3 processors integrated	9th Gen Intel® Xeon® E / Core™ i7/i5/i3 processors integrated	13th Gen Intel® Core™ i7 / i5/i3 processor integrated	12th Gen Intel® Core™ i9 / i7/i5/i3 processors integrated
<b>Video Output</b>	HDMI(2.0) / DVI-D / DisplayPort on board	2x HDMI	HDMI(2.0a) / DisplayPort / DVI-D on board	HDMI (2.0a) / DisplayPort / DVI-D on board	1x HDMI (2.0b) + 2x DisplayPort (1.4b) (DP++ ) + DVI-D	HDMI (2.0b) / DisplayPort (1.4a) / DVI-D on board
<b>Ethernet</b>	Intel® I219LM Gigabit LAN PHY, Intel® I211AT or I210AT Gigabit LAN	Intel® I219LM Gigabit LAN PHY, Intel® I211AT or I210AT Gigabit LAN	Intel I219LM GbE PHY MB995VF-C246; Intel® I210AT GbE MB995VF; Intel® I211AT or I210AT GbE	LAN 1: Intel® I219V GbE PHY for MB997EF; Intel® I219LM GbE PHY for MB997AF / MB997AF-10G LAN 2: Intel® I210AT GbE (MB997-10G), Intel® I211AT or I210AT GbE (MB997VF / EF)	Intel® I226LM, supports 2.5G and iAMT Intel® I226V, supports 2.5G only	Intel® I225LM 2.5G LAN Intel® I225V 2.5G LAN
<b>Audio</b>	Built-in ALC888S HD audio codec	Built-in ALC888S HD audio codec	Built-in ALC888S HD audio codec	Built-in ALC888S HD audio codec	Built-in ALC888S HD audio codec	Built-in ALC888S HD audio codec
<b>SATA</b>	6x SATA III ports	6x SATA III ports	6x SATA III ports (MB995VF-C246) 4x SATA III ports (MB995VF)	4x SATA III ports	4x SATA III ports	4x SATA III ports
<b>I/O Chipset</b>	F81866AD-I	F81846AD-1	F81966D-I	NC T6686D-T	F81964D-I	F81966D-I
<b>Parallel Port</b>	N/A	N/A	N/A	N/A	N/A	N/A
<b>Serial Port</b>	5x RS232 1x RS232/422/485 (Jumper-less selection)	6x RS232 2x RS232/422/485 (Jumper-less selection)	4x RS232 2x RS232/422/485 (Jumper-less selection)	4x RS232 2x RS232/422/485 (Jumper-less selection)	2x RS232/422/485 2x RS232	2x RS232 2x RS232/422/485 (Jumper-less selection)
<b>USB 2.0</b>	4x USB 2.0	4x USB 2.0	N/A	N/A	2x USB 2.0	2x USB 2.0
<b>USB 3.X</b>	6x USB 3.0	6x USB 3.0	4x USB 3.1 5x USB 3.0	4x USB 3.1 Gen2 (10Gbps) 5x USB 3.1 Gen1 (5Gbps)	4x USB 3.2(10Gbps) 2x USB 3.1(5Gbps)	4x USB 3.1 Gen2 (10Gbps) 4x USB 3.1 Gen1 (5Gbps)
<b>TPM</b>	1.2	2.0	2.0	2.0	2.0	2.0
<b>KB / MS</b>	N/A	N/A	box header	N/A	N/A	N/A
<b>Hardware Monitor</b>	Yes	Yes	Yes	Yes	Yes	Yes
<b>Storage Device Interface</b>	N/A	NVMe	NVMe	NVMe	NVMe	NVMe
<b>Watchdog Timer</b>	256 levels	256 levels	256 levels	256 levels	256 levels	256 levels
<b>Digital I/O</b>	4-in/4-out	4-in/4-out	4-in/4-out	4-in/4-out	4-in/4-out	4-in/4-out
<b>Expansion Slots</b>	1x PCI-E (x16), 1x PCI-E (x8) 1x PCI-E (x4), 1x PCI-E (x1) 3x PCI	1x PCI-E (x16) 1x PCI-E (x8) 2x PCI-E (x4)	1x PCI-E (x16), 1x PCI-E (x4), 1x PCI-E (x1), 3x PCI	1x PCI-E (x16), 1x PCI-E (x4), 1x PCI-E (x1), 2x PCI	1x PCI-E (x16) [Gen.5.0], 1x PCI-E (x4) [Gen.4.0], 1x PCI-E (x4) [Gen.3.0]	1x PCI-E (x16)[Gen5.0], 2x PCI-E (x4), 1x PCI-E(x1) (Gen3.0), 2x PCI
<b>Mini Type Slots</b>	1x Mini PCI-E	1x Mini PCI-E 1x M.2 (M-key,2280)	1x MiniPCI-E, 2x M.2 (E / M-key)	1x MiniPCI-E, 2x M.2 (E / M-key)	2x M.2 (M-key,2280) 1x M.2 (E-Key, 2230) 1x M.2 (B-Key, 3052)	4x M.2 (B-Key, E-Key / 2x M-Key)
<b>Power input</b>	ATX type	ATX type	ATX type	ATX type	ATX type	ATX type
<b>Power Consumption</b>	Intel® Core™ i7-6700 3.4GHz w/ 4x 4GB DDR4-2133 +12V: 7.12A; +5V: 1.99A +3.3V: 0.43A; +5VSB: 0.15A	Intel® Core™ i7-6700, 3.4GHz, w/ 4x 8GB DDR4-2133 12V: 7.1A +5V: 1.81A +5VSB: 0.11A +3.3V, 0.70A	Intel® Core™ i7-8700 3.4GHz w/ 4x 4GB DDR4-2400 +12V: 5.56A +5V: 1.65A +5VSB: 0.25A +3.3V: 0.65A	Intel® Core™ i7-9700K, 3.6GHz w/ 4x 4GB DDR4-2400 +12V: 12.64A +5V: 1.19A +5VSB: 0.132A +3.3V: 0.88A	Intel® Core™ i7-13700 2.10GHzw/ w/2x 32GB DDR5 5600 +12V:20.09A +5V:8.76A +3.3V:4.73A +5VSB:0.78A	TBD
<b>Dimensions (L x W)</b>	305mm x 244mm	244mm x 244mm	305mm x 244mm	305mm x 244mm	244mm x 244mm	305mm x 244mm
<b>Extra Features</b>	Built-in iAMT (11.0), LAN Wakeup, iSMART, vPro, RAID	Built-in iAMT (11.6), LAN Wakeup, TPM (2.0), iSMART, RAID	Built-in iAMT (11.6), LAN Wakeup, iSMART, TPM (2.0), vPro, RAID	Built-in iAMT (11.6), LAN Wakeup, iSMART, TPM (2.0), RAID	Built-in iAMT (16.1), LAN Wakeup, RAID	Built-in iAMT (16.0), LAN Wakeup, RAID
<b>Page No.</b>	P.3-7	P.3-9	P.3-6	P.3-5	P.3-8	P.3-4

1 CPU Modules

2 Single Board Computers

3 Motherboards

4 CPU Cards

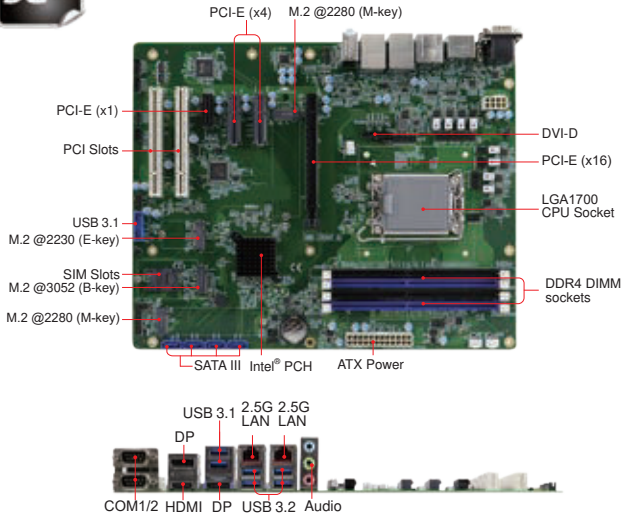

### Features

- 13th/12th Gen Intel® Core™ i9/i7/i5/i3 / Pentium® / Celeron® processors
- 4x DDR4 DIMM, Max.128GB
- Intel® processor integrated graphics supports HDMI (2.0b), DVI-D, and DisplayPort (1.4) (DP++)
- Dual Intel® 2.5G LAN
- 8x USB 3.1, 2x USB 2.0, 4x SATA 3.0, 4x COM
- 1x PCI-E(x16) (Gen5.0), 2x PCI-E(x4) (Gen4.0), 1x PCI-E(x1) (Gen3.0), 2x PCI
- 4x M.2 (B-Key, E-Key/ 2x M-Key)
- Watchdog timer, Digital I/O, iAMT (16.1), TPM (2.0)

### Specifications

CPU Socket	LGA1700
CPU	13th/12th Gen Intel® Core™ i9/i7/i5/i3 and Pentium®/ Celeron® processors
PCH	MBB-1000AF-R: Intel® R680E PCH MBB-1000AF-Q: Intel® Q670E PCH
Memory	4x DDR4-3200 MHz, Max. 128GB (Supports ECC by CPU SKUs + PCH R680E)
BIOS	AMI
Watchdog Timer	256 levels
H/W Monitor	Yes
Storage Device Interface	NVMe
Expansion Slots	1x PCI-E(x16) (Gen5.0), 2x PCI-E(x4) (Gen4.0), 1x PCI-E(x1) (Gen3.0), 2x PCI
Mini Type Slots	1x M.2 (M-Key, type:2280, supports NVMe with PCI-E(x4) signal only) 1x M.2 (M-Key, type:2280) 1x M.2 (E-Key, type: 2230, supports CNVj) 1x M.2 (B-Key, type:3052, supports 4G/5G/LTE)
Graphics Controller	12th Gen Intel® Core™ i9/i7/i5/i3 processors integrated
Video Output	1x HDMI (2.0b), 1x DVI-D, 2x DisplayPort (1.4a) (DP++)
Ethernet	Intel® I225LM 2.5GbE Intel® I225V 2.5GbE
I/O Chipset	Fintek F81964D-I
Serial Port	2x RS232, 2x RS232/422/485
USB 2.0	2x USB 2.0 via pin header
USB 3.0	4x USB 3.1 Gen2 (10Gbps), 2x USB 3.1 Gen1 (5Gbps), 2x USB 3.1 Gen1(via box-header)
Serial ATA	4x SATA 3.0
Audio	Intel® R680E/ Q670E PCH-H built-in HD audio + Realtek ALC888S codec
TPM	TPM (2.0)
Others	Digital I/O (4-in/4-out), iAMT (16.1), RAID
Dimensions (L x W)	305mm x 244mm (12" x 9.6")
Power Consumption	TBD
Operating Temperature	0°C~60°C ( 32°F~140°F)

Storage Temperature	-20°C~80°C (-4°F~176°F)
Relative Humidity	95% (non-condensing @60°C)

### Ordering Information

MBB-1000AF-R	LGA1700 R680E ATX Motherboard w/ HDMI, DisplayPort, DVI-D, Dual 2.5G LAN, RAID, iAMT (16.0), TPM (2.0), supports ECC
MBB-1000AF-Q	LGA1700 Q670E ATX Motherboard w/ HDMI, DisplayPort, DVI-D, Dual 2.5G LAN, RAID, iAMT (16.0), TPM (2.0)

### Dimensions and Drawing

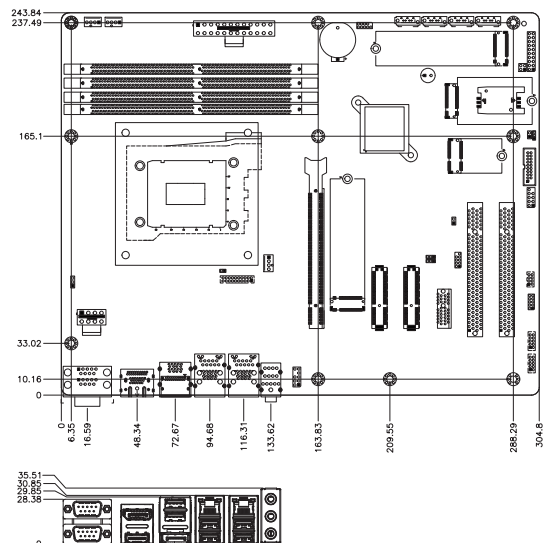

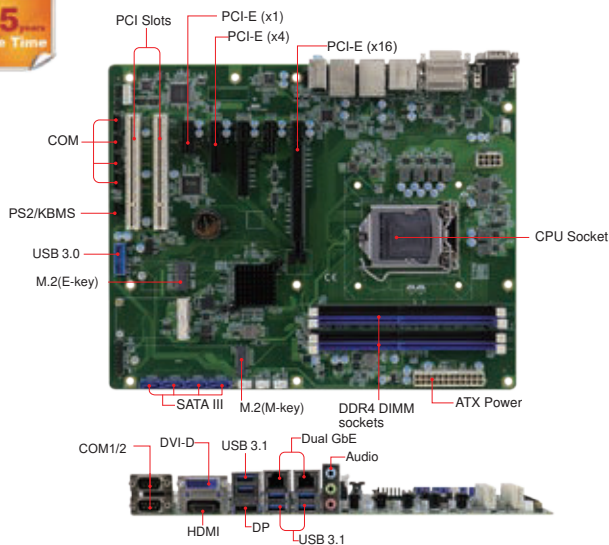

## Features

- 9th Gen Intel® Xeon® E/ Core™ i7/i5/i3 processors
- 4x DDR4 DIMM, Max.128GB
- Intel® processor integrated graphics supports HDMI(2.0a), DVI-D, and DisplayPort
- Dual Intel® Gigabit LAN
- 6x USB 3.1, 2x USB 2.0, 4x SATA 3.0, 6x COM
- 1x PCI-E(x16), 1x PCI-E(x8)(Gen3.0), 1x PCI-E(x4), 2x PCI-E(x1), 2x PCI
- Watchdog timer, Digital I/O, iAMT (11.6), TPM(2.0), iSMART (4.0)

## Specifications

CPU Socket	LGA1151
CPU	9th Gen Intel® Xeon® E/ Core™ i7/i5/i3 HC/QC/DC processors, up to 5.0GHz
PCH	MB997AF-C246: Intel® C246 PCH MB997AF: Intel® Q370 PCH MB997EF: Intel® H310 PCH
Memory	4x DDR4-2666 / 2400 MHz, Max. 128GB (Supports ECC by CPU SKUs)
BIOS	AMI
Watchdog Timer	256 levels
H/W Monitor	Yes
Storage Device Interface	NVMe
Expansion Slots	MB997AFS-C246/ MB997AFS: 1x PCI-E (x16), 1x PCI-E(x8), 1x PCI-E(x4), 2x PCI-E (x1), 2x PCI MB997EFS: 1x PCI-E (x16), 2x PCI-E (x1), 2x PCI
Mini Type Slots	1x MiniPCI-E, 1x M.2 (M-Key, type:M2280), 1x M.2 (E-Key, type: E2230)
Graphics Controller	9th Gen Intel® Core™ i7/i5/i3 processors integrated
Video Output	1x HDMI2.0a, 1x DVI-D, 1x DisplayPort (1.2)(DP++)
Ethernet	LAN 1: MB997AF-C246/MB997AF: Intel® I219LM GbE PHY MB997EF: Intel® I219V GbE PHY LAN 2: MB997AF-C246: Intel® I210AT GbE MB997AF/ EF: Intel® I211AT or I210AT GbE
I/O Chipset	Nuvoton NC T6686D-T
Serial Port	4x RS232, 2x RS232/422/485
USB 2.0	2x USB 2.0 via pin header
USB 3.X	MB997AF-C246/MB997AF: 4x USB 3.1 Gen2 (10Gpbs), 2x USB 3.1 Gen1 (5Gpbs), 2x USB 3.1 Gen1 (5Gpbs) via box-header MB997EF: 4x USB 3.1 Gen2 (10Gpbs)
Serial ATA	4x SATA 3.0
Audio	Intel® CNL PCH-H built-in HD audio + Realtek ALC888S codec
TPM	TPM (2.0)
Others	Digital I/O(4-in/4-out), iAMT (11.6), RAID, iSMART (4.0), EuP/ErP

Dimensions (L x W)	305mm x 244mm (12" x 9.6")
Power Consumption	Intel® Core™ i7-9700K, 3.6GHz w/ 4x 4GB DDR4-2400 +12V: 12.64A +5V: 1.19A +5VSB: 0.132A +3.3V: 0.88A
Operating Temperature	0°C~60°C ( 32°F~140°F)
Storage Temperature	-20°C~80°C (-4°F~176°F)
Relative Humidity	95% (non-condensing @60°C)

## Ordering Information

MB997AFS-C246	LGA1151 C246 ATX Motherboard w/ HDMI, DisplayPort, DVI-D, dual Gigabit LAN, RAID, iAMT (11.6), TPM (2.0), iSMART (4.0)
MB997AFS	LGA1151 Q370 ATX Motherboard w/ HDMI, DisplayPort, DVI-D, dual Gigabit LAN, RAID, iAMT (11.6), TPM (2.0), iSMART (4.0)
MB997EFS	LGA1151 H310 ATX Motherboard w/ HDMI, DisplayPort, DVI-D, dual Gigabit LAN, TPM (2.0), EuP/ErP

## Dimensions and Drawing

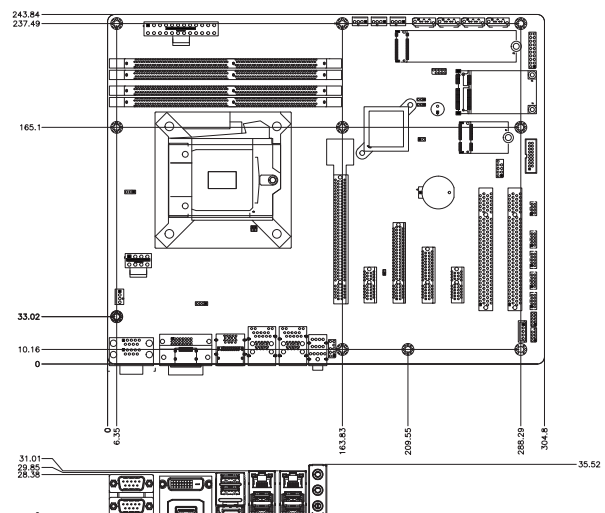



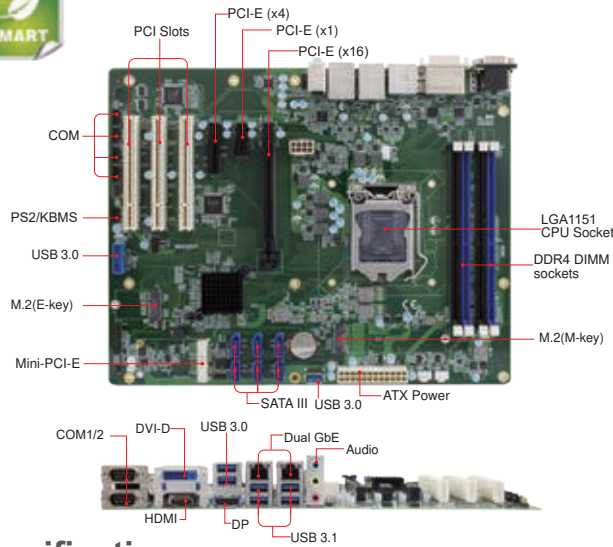

## Specifications

CPU Socket	LGA1151
CPU	8th Gen Intel® Xeon® E / Core™ i7/i5/i3 HC/QC/DC processors, up to 4.7GHz
PCH	MB995VF-C246: Intel® C246 PCH MB995VF: Intel® Q370 PCH
Memory	4x DDR4-2666/ 2400 DIMM, Max. 64GB (supports ECC by CPU SKUs)
BIOS	AMI
Watchdog Timer	256 levels
H/W Monitor	Yes
Storage Device Interface	mSATA , NVMe
Expansion Slots	1x PCI-E (x16), 1x PCI-E (x4), 1x PCI-E (x1)
Mini Type Slots	3x PCI, 1x MiniPCI-E, 1x M.2 (M-key, type:2280) 1x M.2 (E-key, type:2230)
Graphics Controller	8th Gen Intel® Core™ i7/i5/i3 processors integrated
Video Output	1x HDMI (2.0a), 1x DisplayPort (1.2)(DP++), 1x DVI-D
Ethernet	LAN 1: Intel® I219LM GbE PHY LAN 2: MB995VF-C246: Intel® I210AT GbE MB995VF: Intel® I211AT or I210AT GbE
I/O Chipset	Fintek F81966D-I
Serial Port	4x RS232, 2x RS232/422/485 (jumper-less selection)
USB 2.0	2x USB 2.0 via pin-header
USB 3.X	4x USB 3.1 on board 5x USB 3.0: -2 ports on board, 2 ports via box-headers -1 port via on board vertical type connector
Serial ATA	MB995VF-C246: 6x SATA III MB995VF: 4x SATA III
Audio	Intel® C246/Q370 PCH built-in HD audio + Realtek ALC888S codec
TPM	TPM (2.0)

## Features

- 8th Gen Intel® Xeon® E / Core™ i7/i5/i3 HC/QC/DC processors, up to 4.7GHz
- 4x DDR4 DIMM, Max. 64GB
- Intel® processor integrated graphics supports DVI-D, HDMI (2.0a) and DisplayPort
- Dual Intel® Gigabit LAN
- 4x USB 3.1, 5x USB 3.0, 6x COM, 6x SATA III
- 1x PCI-E (x16), 1x PCI-E (x4), 1x PCI-E (x1), 3x PCI, 1x Mini PCI-E, 2x M.2 (E/ M-key)
- Watchdog timer, Digital I/O, iAMT (11.6), TPM(2.0), vPro, iSMART

Others	Digital I/O (4-in/4-out), iAMT (11.6), RAID, iSMART (3.5), EuP/ErP
Dimensions (L x W)	305mm x 244mm (12" x 9.6")
Power Consumption	Intel® Core™ i7-8700 3.4GHz w/ 4x 4GB DDR4-2400 +12V: 5.56A +5V: 1.65A +5VSB: 0.25A +3.3V: 0.65A
Operating Temperature	0°C~60°C (32°F~140°F)
Storage Temperature	-20°C~80°C (-4°F~176°F)
Relative Humidity	90% (non-condensing @60°C)

## Ordering Information

MB995VF-C246	LGA1151 C246 ATX motherboard w/ HDMI, DVI-D, DisplayPort (1.2), dual Gigabit LAN, RAID, iAMT (11.6), TPM (2.0), iSMART (3.5)
MB995VF	LGA1151 Q370 ATX motherboard w/ HDMI, DVI-D, DisplayPort (1.2), dual Gigabit LAN, RAID, iAMT (11.6), TPM (2.0), iSMART (3.5)

## Dimensions and Drawing

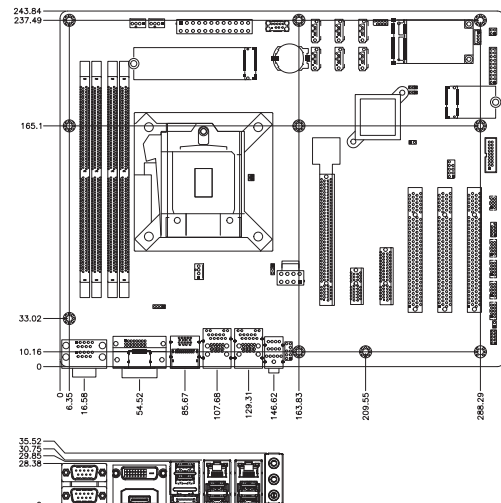

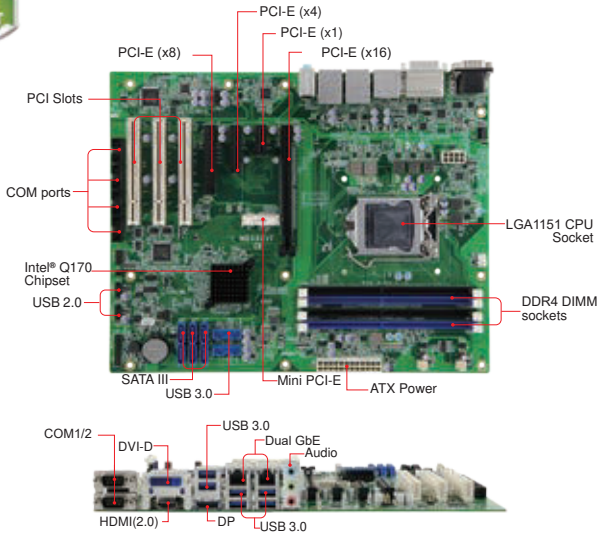

## Features

- 7th/6th Gen Intel® Core™ i7/i5/i3 / Pentium® / Celeron® QC/DC processors, up to 4.0GHz
- 4x DDR4 DIMM, Max. 64GB, ECC compatible
- Intel® processor integrated graphics supports DVI-D, HDMI and DisplayPort
- Dual Intel® Gigabit LAN
- 4x USB 2.0, 10x USB 3.0, 6x COM, 6x SATA III
- 1x PCI-E (x16), 1x PCI-E (x8) [(x4) Link], 1x PCI-E (x4) [(x1) Link], 1x PCI-E (x1), 3x PCI
- 1x Mini PCI-E
- Watchdog timer, Digital I/O, iAMT (11.0), TPM(1.2), vPro, iSMART

## Specifications

CPU Socket	LGA1151
CPU	7th/6th Gen Intel® Core™ i7/i5/i3/ Pentium® / Celeron® QC/ DC processors, up to 4.0GHz
PCH	Intel® Q170 PCH
Memory	4x DDR4 DIMM, Max. 64GB (supports ECC by CPU SKUs)
BIOS	AMI
Watchdog Timer	256 levels
H/W Monitor	Yes
Storage Device Interface	N/A
Expansion Slots	1x PCI-E (x16), 1x PCI-E (x8), 1x PCI-E (x4), 1x PCI-E (x1), 3x PCI
Mini Type Slots	1x Mini PCI-E
Graphics Controller	7th/6th Gen Intel® Core™ i7/i5/i3/ Pentium®/ Celeron® QC/ DC processors integrated
Video Output	Supports DVI-D, HDMI and DisplayPort
Ethernet	MB990VF: Intel® I219LM Gigabit LAN PHY Intel® I211AT or I210AT Gigabit LAN (as 2nd LAN)
I/O Chipset	Fintek F81866AD-I
Serial Port	5x RS232, 1x RS232/422/485 (jumper-less selection)
USB 2.0	4x USB 2.0 via pin-header
USB 3.X	10x USB 3.0 6 ports on board 4 ports via pin-header
Serial ATA	6x SATA III
Audio	Intel® Q170 PCH built-in HD audio + Realtek ALC888S codec
TPM	TPM (1.2)
Others	Digital I/O (4-in/4-out), RAID, iAMT (11.0), iSMART
Dimensions (L x W)	305mm x 244mm (12" x 9.6")
Power Consumption	Intel® Core™ i7-6700 3.4GHz w/ 4x 4GB DDR4-2133 +12V: 7.12A ; +5V: 1.99A; +5VSB: 0.15A; +3.3V: 0.43A
Operating Temperature	0°C~60°C (32°F~140°F)
Storage Temperature	-20°C~80°C (-4°F~176°F)
Relative Humidity	10% ~ 90% (non-condensing)

## Ordering Information

MB990VFS-A	LGA1151 Q170 ATX motherboard w/ DVI-D, HDMI, DisplayPort, dual Gigabit LAN, RAID, iAMT (11.0), TPM (1.2), vPro, iSMART
------------	--

## Dimensions and Drawing

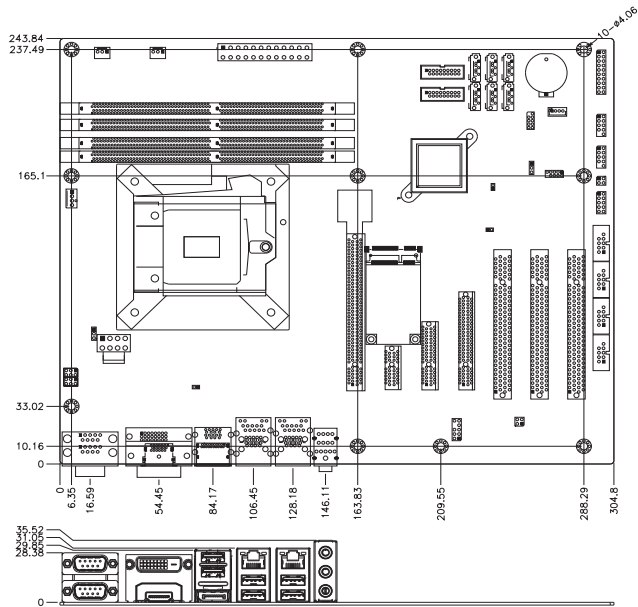

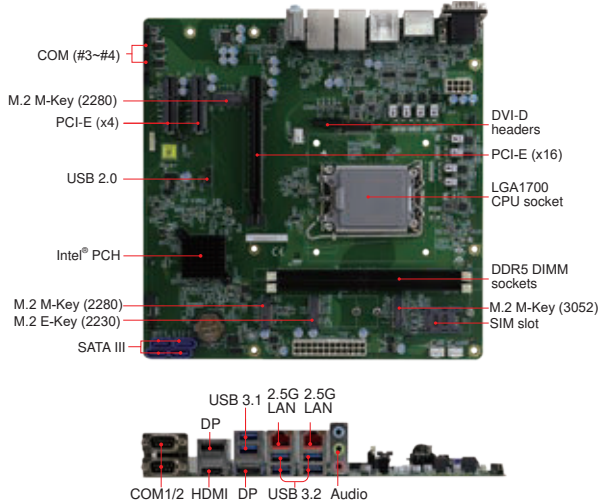

## Features

- 13th/12th Gen Intel® Core i9/i7/i5/i3™ and Pentium® / Celeron® Processors
- 2x **DDR5** DIMM sockets, Max. 64GB
- Intel® processor integrated graphics supports HDMI (2.0b), DVI-D and 2x DisplayPort(1.4) (DP++)
- Dual Intel 2.5G LAN
- 4x USB 3.2, 2x USB 3.1, 2x USB 2.0, 4x COM, 4x SATA III
- 1x PCI-E (x16) [Gen.5.0], 1x PCI-E (x4) [Gen.4.0], 1x PCI-E (x4) [Gen.3.0]
- 4x M.2 (B-key, E-key and 2x M-Key)
- Watchdog timer, Digital I/O, iAMT(16.1) , fTPM

## Specifications

CPU Socket	LGA 1700
CPU	13th/12th Gen Intel® Core™ i9/i7/i5/i3 and Pentium® / Celeron® Processors
PCH	MB998AF-R : Intel® R680E PCH MB998AF-Q : Intel® Q670E PCH MB998AF-W : Intel® W680 PCH (Not IoTG sku)
Memory	2x <b>DDR5</b> DIMM sockets, supports DDR5-4800/5600 memory module , Max. 64GB
BIOS	AMI
Watchdog Timer	256 levels
H/W Monitor	Yes
Storage Device Interface	SATA III & NVMe
Expansion Slots	1x PCI-E (x16) [Gen.5.0], 1x PCI-E (x4) [Gen.4.0], 1x PCI-E (x4) [Gen.3.0]
Mini Type Slots	2x M.2 (M-key, type:2280, PCI-E) 1x M.2 (E-Key, type:2230, USB 2.0 + PCI-E) 1x M.2 (B-Key, type:3052, USB 3.1 + PCI-E)
Graphics Controller	13th Gen Intel® Core™ i7/i5/i3 processor integrated
Video Output	1x HDMI (2.0b) + 2x DisplayPort (1.4b) (DP++) + DVI-D
Ethernet	LAN 1: Intel® I226LM, supports 2.5G and iAMT LAN 2: Intel® I226V, supports 2.5G only
I/O Chipset	Fintek F81964D-I
Serial Post	4x COM port : 2x RS232/422/485 + 2x RS232
USB 2.0	2x USB 2.0 via pin-header
USB 3.X	4x USB 3.2(10Gbps), 2x USB 3.1(5Gbps) @edge connector
Serial ATA	4x SATA III
Audio	Built-in HD Audio controller + Realtek ALC888S with 7.1 channels
TPM	Supports fTPM
Others	Digital I/O (4-in/4-out) , Watchdog timer, SIM
Dimensions (L x W)	244mm x 244mm (9.6" x 9.6")
Power Consumption	Intel® Core™ i7-13700 2.10GHzw/ w/2x 32GB DDR5 5600 +12V:20.09A +5V:8.76A +3.3V:4.73A +5VSB:0.78A

Operating Temperature	0°C~60°C ( 32°F~140°F)
Storage Temperature	-20°C~80°C (-4°F~176°F)
Relative Humidity	90% (non-condensing @60°C)

## Ordering Information

MB998AF-R	LGA 1700 R680E MicroATX Motherboard with 1x HDMI, 2x DisplayPort, 1x DVI-D, dual 2.5GbE, 4x SATA, RAID, iAMT (16.1), fTPM
MB998AF-Q	LGA 1700 Q670E MicroATX Motherboard with 1x HDMI, 2x DisplayPort, 1x DVI-D, dual 2.5GbE, 4x SATA, RAID, iAMT (16.1), fTPM
MB998AF-W (Not IoTG sku)	LGA 1700 W680 MicroATX Motherboard with 1x HDMI, 2x DisplayPort, 1x DVI-D, dual 2.5GbE, 4x SATA, RAID, iAMT (16.1), fTPM

## Dimensions and Drawing

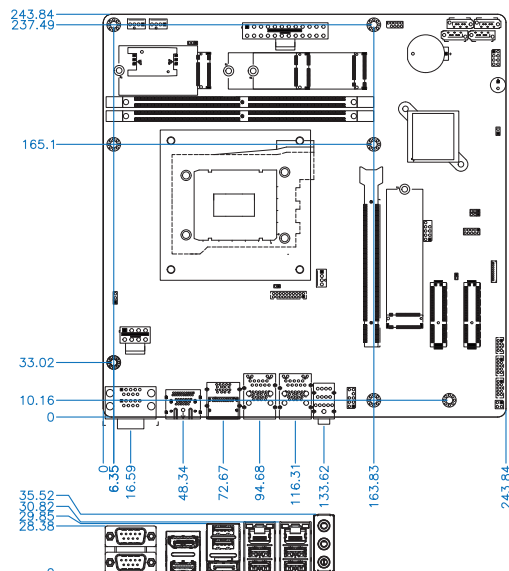

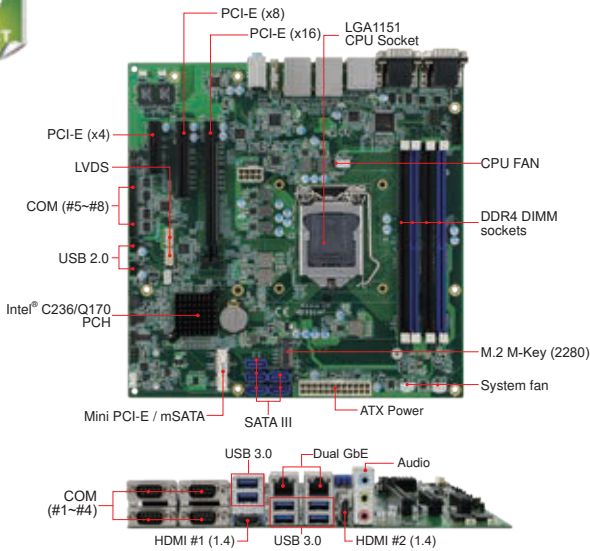

## Features

- 7th/ 6th Gen Intel® Xeon E3/Core™ i7/i5/i3 / Pentium® / Celeron® QC/DC processors, up to 4.2GHz
- 4x DDR4 DIMM, Max. 64GB
- Intel® processor integrated graphics, supports HDMI, LVDS
- Dual Intel® Gigabit LAN
- 4x USB 2.0, 6x USB 3.0, 8x COM, 5x SATA III
- 1x PCI-E (x16) [(x8) Link], 1x PCI-E (x8), 1x PCI-E (x4)
- 1x Mini PCI-E, 1x M.2 M-key (2280)
- Watchdog timer, Digital I/O, iAMT (11.6), TPM (2.0), iSMART

## Specifications

CPU Socket	LGA1151
CPU	7th/6th Gen Intel® Xeon E3/Core™ i7/i5/i3/ Pentium® / Celeron® QC/ DC processors, up to 4.2GHz
PCH	MB991AF-C236: Intel® C236 PCH MB991AF: Intel® Q170 PCH
Memory	4x DDR4 DIMM, Max. 64GB (supports ECC by CPU SKUs)
BIOS	AMI
Watchdog Timer	256 levels
H/W Monitor	Yes
Storage Device Interface	1x mSATA via Mini PCI-E (Thru SATA III) 1x M.2 slot [Thru PCI-E (x1) x4](NVMe)
Expansion Slots	1x PCI-E (x16), 1x PCI-E (x8), 1x PCI-E (x4) 1x M.2 (2280)
Mini Type Slots	1x Mini PCI-E
Graphics Controller	7th/6th Gen Intel® Core™ i7/i5/i3/ Pentium®/ Celeron® processor Integrated
Video Output	2x HDMI (1.4) and LVDS
Ethernet	Intel® I219LM Gigabit LAN PHY Intel® I211AT or I210AT Gigabit LAN
I/O Chipset	Fintek F81846AD-I + F81504D
Serial Post	6x RS232, 2x RS232/422/485 (jumper-less selection)
USB 2.0	4x USB 2.0 via pin-header
USB 3.X	6x USB 3.0 on board
Serial ATA	5x SATA III
Audio	Intel® C236 / Q170 PCH built-in HD audio + Realtek ALC888S codec
TPM	TPM (2.0)
Others	Digital I/O (4-in/4-out), RAID, iAMT (11.6), iSMART
Dimensions (L x W)	244mm x 244mm (9.6" x 9.6")
Power Consumption	Intel® Core i7-6700, 3.4GHz, w/ 4x 8GB DDR4-2133 12V: 7.1A +5V: 1.81A +5VSB: 0.11A +3.3V: 0.70A
Operating Temperature	0°C~60°C ( 32°F~140°F )
Storage Temperature	-20°C~-80°C ( -4°F~-176°F)
Relative Humidity	90% (non-condensing @60°C)

## Ordering Information

MB991AFS-236	LGA1151 C236 Micro ATX motherboard w/ 2x HDMI (1.4) and LVDS, dual Gigabit LAN, RAID, iAMT (11.6), TPM (2.0), iSMART
MB991AFS	LGA1151 Q170 Micro ATX motherboard w/ 2x HDMI (1.4) and LVDS, dual Gigabit LAN, RAID, iAMT (11.6), TPM (2.0), iSMART

## Dimensions and Drawing

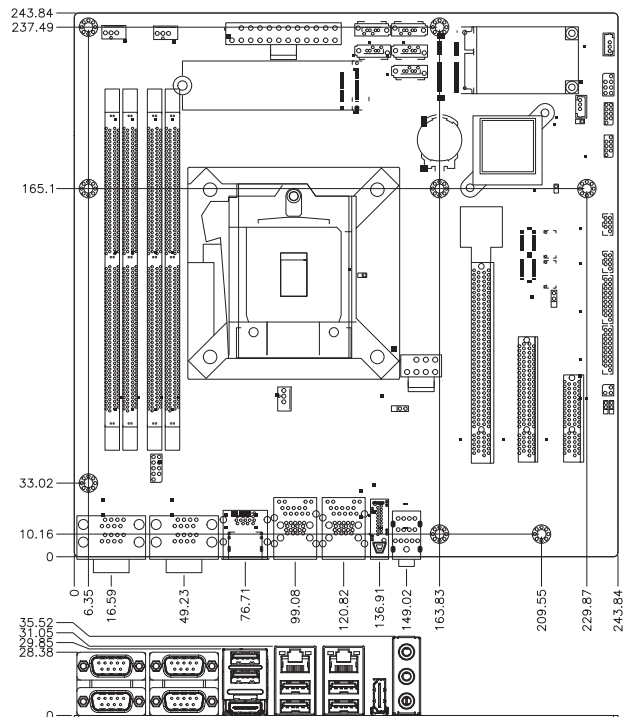



# Comparison Table

## Mini-ITX Motherboard

Models	MI805	MI808	MI811
<b>Form Factor</b>	Mini-ITX	Mini-ITX	Mini-ITX
<b>CPU Socket</b>	CPU on board	FCBGA1170	FCBGA1296
<b>CPU</b>	Intel® Celeron® QC J1900 SoC	Intel® Pentium® N3710 / Celeron® N3010 SoC	Intel® Pentium® N4200 / Celeron® N3350 SoC
<b>CPU Max. Frequency</b>	2.00GHz	Up to 2.56GHz/ 2.24GHz	Up to 2.5GHz/ 2.4Ghz
<b>PCH</b>	N/A	N/A	N/A
<b>Memory</b>	2x DDR3L SO-DIMM	2x DDR3L SO-DIMM	2x DDR3L SO-DIMM
<b>Max. Memory Size</b>	8GB	8GB	8GB
<b>BIOS</b>	AMI	AMI	AMI
<b>Graphics Controller</b>	Intel® Gen7 w/ 4EUs graphics	Intel® Gen8 w/ 16 EUs graphics	Intel® Gen9-LP w/ 18 EUs graphics
<b>Video Output</b>	DVI-D on board	VGA, DVI-D on board	HDMI, DVI-D on board
<b>Ethernet</b>	2x Intel® I211AT or I210AT Gigabit LAN	Intel® I211AT or I210AT Gigabit LAN	Intel® I211AT or I210AT Gigabit LAN
<b>Audio</b>	Built-in ALC269 audio codec w/ 2.3W amplifier	Built-in ALC269 audio codec w/ 2W amplifier	Built-in ALC283 audio codec w/ 2W amplifier
<b>SATA</b>	2x SATA II ports	2x SATA III ports	2x SATA III ports
<b>I/O Chipset</b>	NCT6106D	F81866AD-I	F81846AD-I
<b>Parallel Port</b>	N/A	N/A	N/A
<b>Serial Port</b>	5x RS232 1x RS232/422/485 (jumper-less selection)	3x RS232 1x RS232/422/485 (jumper-less selection)	3x RS232 1x RS232/422/485 (jumper-less selection)
<b>USB 2.0</b>	2x USB 2.0 on rear I/O 2x USB 2.0 via pin header	2x USB 2.0 via pin header	2x USB 2.0 ( 2 ports via rear/I/O + 2 ports via pin header)
<b>USB 3.0/3.1</b>	1x USB 3.0 on rear I/O	4x USB 3.0 on rear I/O	4x USB 3.0 on rear I/O
<b>TPM</b>	N/A	2.0 (optional)	N/A
<b>KB / MS</b>	N/A	PS/2	N/A
<b>Hardware Monitor</b>	Yes	Yes	Yes
<b>Storage Device Interface</b>	mSATA	mSATA or CFast	mSATA
<b>Watchdog Timer</b>	256 levels	256 levels	256 levels
<b>Digital I/O</b>	4-in/4-out	4-in/4-out	4-in/4-out
<b>Expansion Slots</b>	1x PCI-E (x1)	1x PCI-E (x1)	1x PCI-E (x1)
<b>Mini Type Slots</b>	1x Mini PCI-E (x1)	1x Mini PCI-E (x1)	1x Mini PCI-E (x1)
<b>Power input</b>	DC In 12V ~ 24V	DC In 12V or DC in 18V~ 24V	ATX or DC in 12V~ 24V
<b>Power Consumption</b>	Intel® Celeron® J1900 2GHz 8GB DDR3L-1600 +12V: 1.28A	Intel® Pentium® N3700 1.6GHz w/ 2x 4GB DDR3L-1600 +19V: 1.01A	Intel® Pentium® N4200 2.5GHz w/ 2x DDR3L-1600 4GB +12V: 1.27A
<b>Dimensions (L x W)</b>	170mm x 170mm	170mm x 170mm	170mm x 170mm
<b>Extra Features</b>	iSMART(3.0), LAN Wakeup	LAN Wakeup, SIM card slot iSMART(3.1)	LAN Wakeup
<b>Page No.</b>	P. 3-28	P. 3-27	P. 3-26

1

CPU Modules

2

Single Board Computers

3

Motherboards

4

CPU Cards



# Comparison Table

## Mini-ITX Motherboard

Models	MI988	MI989	MI990	MI991
<b>Form Factor</b>	Mini-ITX	Mini-ITX	Mini-ITX	Mini-ITX
<b>CPU Socket</b>	BGA 1140 APU on board	BGA 1140 APU on board	BGA 1440 CPU on board	LGA
<b>CPU</b>	AMD Embedded Zen Core CPU	AMD Embedded Zen Core CPU	6th Gen Intel® Xeon® / Core™ i7/i5/i3/ Celeron®	7th/6th Gen Intel® Xeon® / Core™ i7/i5/i3/ Pentium® / Celeron® DT CPU
<b>CPU Max. Frequency</b>	Up to 3.8GHz	Up to 4.15GHz	Up to 3.70GHz	Up to 4.0GHz
<b>PCH</b>	N/A	N/A	Intel® CM236 (MI990VF) Intel® HM170 (MI990EF)	Intel® C236(MI991AF-C236) Intel® Q170(MI991AF) Intel® H110(MI991EF)
<b>Memory</b>	2x DDR4 SO-DIMM	2x DDR4 SO-DIMM	2x DDR4 SO-DIMM	2x DDR4 SO-DIMM
<b>Max. Memory Size</b>	32GB	64GB	32GB	32GB
<b>BIOS</b>	AMI	AMI	AMI	AMI
<b>Graphics Controller</b>	AMD V-series APU built-in GPU	AMD V-series APU built-in GPU	Intel® Core™ i integrated graphics	Intel® Core™ i integrated graphics
<b>Video Output</b>	HDMI(2.0)/ DP on board	4x DisplayPort	HDMI(2.0), DVI-D and DP on board	HDMI/ DVI-D/ DP on board
<b>Ethernet</b>	Intel® I211AT or I210AT Gigabit LAN PHY	Intel® I211AT or I210AT Gigabit LAN PHY	Intel® I219LM/V Gigabit LAN PHY Intel® I211AT or I210AT Gigabit LAN	Intel® I219LM/V Gigabit LAN PHY Intel® I211AT or I210AT Gigabit LAN
<b>Audio</b>	Built-in ALC888S HD audio codec	Built-in ALC888S HD audio codec	Built-in ALC888S HD audio codec	Built-in ALC888S HD audio codec
<b>SATA</b>	1x SATA III port	1x SATA III port	MI990VF: 4x SATA III ports MI990EF: 2x SATA III ports	MI991VF: 4x SATA III ports MI991EF: 3x SATA III ports
<b>I/O Chipset</b>	NCT6116D	F81966D-I	F81866AD-I	F81846AD-I
<b>Parallel Port</b>	N/A	N/A	N/A	N/A
<b>Serial Port</b>	2x RS232/422/485 (Jumper-less selection) 4x RS232	2x RS232/422/485 (Jumper-less selection) 2x RS232	5x RS232 1x RS232/422/485 (Jumper-less selection)	3x RS232 1x RS232/422/485 (Jumper-less selection)
<b>USB 2.0</b>	N/A	2x USB 2.0 via rear I/O	4x USB 2.0 (4x via pin header)	MI991AF: 2x USB 2.0 via pin header MI991EF: 2x USB 2.0 on board 2x USB 2.0 via pin header
<b>USB 3.X</b>	4x USB 3.1 real I/O	2x USB 3.1 (Gen.2) via real I/O	6x USB 3.0 (6x rear I/O)	MI991AF: 6x USB 3.0 on board MI991EF: 4x USB 3.0
<b>TPM</b>	N/A	N/A	2.0	1.2
<b>KB / MS</b>	N/A	N/A	N/A	N/A
<b>Hardware Monitor</b>	Yes	Yes	Yes	Yes
<b>Storage Device Interface</b>	mSATA, M.2	mSATA, M.2	mSATA, M.2	mSATA
<b>Watchdog Timer</b>	256 levels	256 levels	256 levels	256 levels
<b>Digital I/O</b>	4-in/4-out	4-in/4-out	4-in/4-out	4-in/4-out
<b>Expansion Slots</b>	1x PCI-E (x8)	1x PCI-E (x16)	1x PCI-E (x16)	1x PCI-E (x16)
<b>Mini Type Slots</b>	1x Mini PCI-E 1x M.2	3x M.2	2x Mini PCI-E (x1) 1x M.2	2x Mini PCI-E (x1)
<b>Power input</b>	ATX type/ DC-IN (12V~24V)	ATX type	ATX type	ATX type
<b>Power Consumption</b>	AMD Ryzen™ Embedded V1807B 3.35GHz w/ 2x 8GB DDR4-2133 +24V: 2.55A	TBD	Intel® Core™ i5-6400EQ 2.4GHz w/ 2x 8GB DDR4-2133 +12V: 2.84A; +5V: 1.45A +5VSB: 0.058A; +3.3V: 0.52A	Intel® Core™ i5-6500TE 2.3GHz w/ 2x DDR4-2133 4GB +12V: 3.56A; +5V: 1.28A +5VSB: 0.08A; +3.3V: 0.32A
<b>Dimensions (L x W)</b>	170mm x 170mm	170mm x 170mm	170mm x 170mm	170mm x 170mm
<b>Extra Features</b>	LAN wakeup iSMART	LAN wakeup, EuP/ErP	iAMT (1.1.0) / vPro [MI990VF], LAN Wakeup, iSMART	iAMT (1.1.0), LAN Wakeup, iSMART
<b>Page No.</b>	P.3-24	P.3-23	P.3-22	P.3-21



# Comparison Table

## Mini-ITX Motherboard

Models	MI992	MI993	MI995	MI996
<b>Form Factor</b>	Mini-ITX	Mini-ITX	Mini-ITX	Mini-ITX
<b>CPU Socket</b>	BGA 1440 CPU on board	BGA 1440 CPU on board	BGA 1440 CPU on board	FCBGA1440
<b>CPU</b>	7th Gen Intel® Xeon® / Core™ i7/i5/i3 processors	AMD Embedded Zen Core CPU	8th Gen Intel® Xeon® / Core™ i7/i5/i3 processors	9th Gen Intel® Xeon® E / Core™ i7/i5/i3, Celeron® processors
<b>CPU Max. Frequency</b>	Up to 3.7GHz	Up to 2.7GHz	Up to 4.2GHz	Up to 4.2GHz
<b>PCH</b>	Intel® CM238 / HM175	N/A	Intel® CM246 PCH Intel® QM370 PCH	Intel® CM246 PCH: MI996VF-X28/26 Intel® QM370 PCH: MI996VF-9850/9400 Intel® HM370 PCH: MI996EF-9100/4930
<b>Memory</b>	2x DDR4 SO-DIMM	2x DDR4 SO-DIMM	2x DDR4 SO-DIMM	2x DDR4 SO-DIMM
<b>Max. Memory Size</b>	32GB	32GB	32GB	32GB
<b>BIOS</b>	AMI	AMI	AMI	AMI
<b>Graphics Controller</b>	Intel® Core™ i integrated graphics	AMD R-series APU built-in GPU	Intel® Core™ i integrated graphics	9th Gen Intel® Xeon® / Core™ i7/i5/i3 integrated graphics
<b>Video Output</b>	DVI-D/ HDMI(1.4) / DP on board	HDMI(2.0b) / DP on board	HDMI(2.0a) / DVI-D/ DP/ eDP on board	eDP, HDMI(2.0a), DisplayPort (1.2) and DVI-D
<b>Ethernet</b>	Intel® I219LM/V Gigabit LAN PHY Intel® I211AT or I210AT Gigabit LAN	Intel® I225V 2.5 Gigabit LAN Intel® I225V 2.5 Gigabit LAN	Intel® I219LM/V Gigabit LAN PHY Intel® I210AT Gigabit LAN Intel® I211AT or I210AT Gigabit LAN	Intel® I219LM Gigabit LAN PHY Intel® I219V Gigabit LAN PHY Intel® I210AT Gigabit LAN Intel® I211AT or I210AT Gigabit LAN
<b>Audio</b>	Built-in ALC888S HD audio codec	Built-in ALC888S HD audio codec	Built-in ALC888S HD audio codec	Built-in ALC888S HD audio codec
<b>SATA</b>	MI992VF: 4 x SATA III ports MI992EF: 2 x SATA III ports	1x SATA III port	MI995VF-X27: 4x SATA III MI995VF-8850/8400, MI995EF-8100: 2x SATA III	MI996VF-X26/28: 4x SATA III MI996VF-9850 MI996EF-9100: 2x SATA III
<b>I/O Chipset</b>	F81866AD-I	NCT6116D	F81964D-I	F81964D-I
<b>Parallel Port</b>	N/A	N/A	N/A	N/A
<b>Serial Port</b>	4x RS232 2x RS232/422/485 (jumper-less selection)	2x RS232 2x RS232/422/485 (jumper-less selection)	2x RS232 2x RS232/422/485 (jumper-less selection)	2x RS232/422/485 (jumper-less selection) 2x RS232
<b>USB 2.0</b>	4x USB 2.0 via rear I/O	2x USB 2.0 (via pin header)	4x USB 2.0 (via pin header)	4x USB 2.0 (via pin header)
<b>USB 3.X</b>	6x USB 3.0 via rear I/O	2x USB 3.1 via rear I/O	6x USB 3.1 (on board)	6x USB 3.1 (via rear I/O)
<b>TPM</b>	2.0	2.0	2.0	2.0
<b>KB / MS</b>	N/A	N/A	N/A	N/A
<b>Hardware Monitor</b>	Yes	Yes	Yes	Yes
<b>Storage Device Interface</b>	mSATA, M.2	M.2 (M-Key)	mSATA, M.2	mSATA 1x M.2 (E-Key) 1x M.2 (M-Key)
<b>Watchdog Timer</b>	256 levels	256 levels	256 levels	256 levels
<b>Digital I/O</b>	4-in/4-out	4-in/4-out	4-in/4-out	4-in/4-out
<b>Expansion Slots</b>	1x PCI-E (x16)	1x PCI-E (x8)	1x PCI-E (x16)	1x PCI-E (x16)
<b>Mini Type Slots</b>	1x Mini PCI-E 1x M.2	1x M.2 (B-key, type:3052) 1x M.2 (M-key, type:2280) 1x M.2 (E-Key, type:2230)	1x Mini PCI-E 2x M.2	1x Mini PCI-E 1x M.2 (M-key, type:2280, NVMe) 1x M.2 (E-Key, type:2230, CNVI)
<b>Power input</b>	ATX type	DC-IN	ATX type	ATX type
<b>Power Consumption</b>	Intel® Xeon E3-1505M v6, 3.00GHz, w/ 2x 4GB DDR4-2133 +12V: 3.95A +5V: 1.50A +5VSB: 0.06A +3.3V: 0.35A	TBD	Intel® Core™ i5-8400H, 2.50GHz, w/ 2x 16GB DDR4-2133 +12V: 3.01A +5V: 1.43A +5VSB: 0.15A +3.3V: 0.32A	Intel® Xeon E-2176G, 3.7GHz w/ 8GB DDR4-2400 +12V: 7.73A +5V: 1.59A +5VSB: 0.17A +3.3V: 0.32A
<b>Dimensions (L x W)</b>	170mm x 170mm	170mm x 170mm	170mm x 170mm	170mm x 170mm
<b>Extra Features</b>	iAMT (11.6), LAN Wakeup, iSMART, RAID	LAN wakeup	iAMT (11.6)/ vPro(MI995VF), LAN Wakeup, iSMART, RAID, EuP/ErP (MI995EF)	iAMT (11.6), LAN Wakeup, iSMART, EuP/ ErP, RAID, vPro(MI996VF)
<b>Page No.</b>	P.3-20	P.3-19	P.3-18	P.3-17

1

CPU Modules

2

Single Board Computers

3

Motherboards

4

CPU Cards

# Comparison Table

## Mini-ITX Motherboard

Models	MI998	MI999	MBD301
<b>Form Factor</b>	Mini-ITX	Mini-ITX	Mini-ITX
<b>CPU Socket</b>	LGA1151	LGA1200	AMD AM4
<b>CPU</b>	9th/8th Gen Intel® Xeon®-E / Core™ / Pentium® / Celeron® processors	10th Gen Intel® Xeon®-E / Core™ / Pentium® / Celeron® processors	AMD AM4 socket
<b>CPU Max. Frequency</b>	Up to 4.9GHz	Up to 4.7GHz	N/A
<b>PCH</b>	Intel® C246, Q370/ H310	Intel® W480E, Q470E, H470E	AMD X470
<b>Memory</b>	2x DDR4 SO-DIMM	2x DDR4 SO-DIMM	2x DDR4 SO-DIMM
<b>Max. Memory Size</b>	32GB	64GB	64GB
<b>BIOS</b>	AMI	AMI	AMI
<b>Graphics Controller</b>	9th/8th Gen Intel® Core™ DT processor integrated HD Gfx	10th Gen Intel® Core™ DT processor integrated HD Gfx	AMD Radeon™ Vega GPU integrated
<b>Video Output</b>	eDP or 24-bit dual-channel LVDS DVI-D, HDMI1.4, DisplayPort	eDP or 24-bit dual-channel LVDS DVI-D, HDMI1.4, DisplayPort	1x DisplayPort (1.2) for AM4 APU series
<b>Ethernet</b>	Intel® I219LM GbE PHY Intel® I219V GbE PHY Intel® I210AT Intel® I211AT or I210AT	Intel® I219LM GbE PHY Intel® I219V GbE PHY Intel® I210AT Intel® I211AT or I210AT	1x Realtek RTL8111H
<b>Audio</b>	Built-in ALC888S HD audio codec	Built-in ALC888S HD audio codec	Built-in HD audio w/ ALC662 codec
<b>SATA</b>	4x SATA III ports	4x SATA III ports	3x SATA III
<b>I/O Chipset</b>	F81964D-I	F81964D-I	Fintek F81439
<b>Parallel Port</b>	N/A	N/A	N/A
<b>Serial Port</b>	2x RS232/422/485 (jumper-less selection) 2x RS232	2x RS232/422/485 (jumper-less selection) 2x RS232	COM #1 (RS232/422/485) (jumper-less selection) COM #2~COM #4 (RS232 only)
<b>USB 2.0</b>	2x USB 2.0 (via pin header)	4x USB 2.0 (via pin header)	N/A
<b>USB 3.X</b>	6x USB 3.0 via rear I/O (MI998AF) 4x USB 3.0 via rear I/O (MI998EF)	6x USB 3.2 (Gen1) via rear I/O	6x USB 3.1 (Gen1)
<b>TPM</b>	2.0	2.0	N/A
<b>KB / MS</b>	N/A	N/A	N/A
<b>Hardware Monitor</b>	Yes	Yes	Yes
<b>Storage Device Interface</b>	1x M.2 (E-Key) 1x M.2 (M-Key)	1x M.2 (M-Key)	N/A
<b>Watchdog Timer</b>	256 levels	256 levels	256 levels
<b>Digital I/O</b>	4-in/4-out	4-in/4-out	N/A
<b>Expansion Slots</b>	1x PCI-E (x16)	1x PCI-E (x16)	1x PCI-E (x16) slot supports single at x16 (PCI-E2) for AM4 Pure CPU series 1x PCI-E (x16) slot supports single at x8 (PCI-E2) for AM4 APU series 1x Mini PCI-E (full-sized) 1x M.2 socket (E-Key) 1x SIM card slot
<b>Mini Type Slots</b>	2x M.2	2x M.2	
<b>Power input</b>	ATX type	ATX type	ATX type
<b>Power Consumption</b>	Intel® i7-8700, w/ DDR4-2400 8GB +12V: 6.36A; +5V: 1.46A; +5VSB: 0.07A; +3.3V: 0.37A	Intel® Core™ i5-10500E 3.0GHz w/ 2x DDR4 2133 4GB +12V: 6.08A, +5Vsb: 0.11A, +5V: 1.19A, +3.3V: 0.90A	AMD Ryzen™ Embedded AM4 CPU/APU 3.0GHz w/ 2x 8GB DDR4-2400 +12V: 2.55A
<b>Dimensions (L x W)</b>	170mm x 170mm	170mm x 170mm	170mm x 170mm
<b>Extra Features</b>	iAMT (11.6), LAN Wakeup, EuP/ErP	iAMT (14.0), LAN Wakeup, EuP/ErP	N/A
<b>Page No.</b>	P.3-15	P.3-14	P.3-29



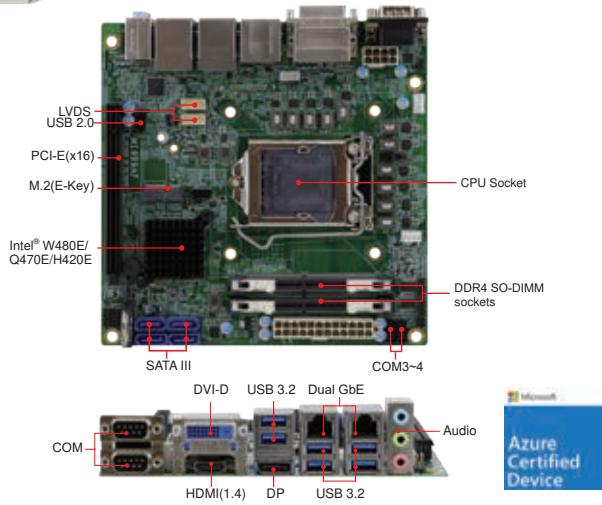

## Features

- 10th Gen Intel® Xeon® W / Core™ / Pentium® / Celeron® processors, up to 4.8GHz
- 2x DDR4 SO-DIMM, Max. 64GB, ECC compatible
- Intel® Processor integrated graphics, supports DVI-D, HDMI, DisplayPort and 24-bit dual channel LVDS or eDP
- Dual Intel® Gigabit LAN
- 6x USB 3.2, 4x USB 2.0, 4x COM, 4x SATA III
- 1x PCI-E (x16), 2x M.2 (E-key, M-Key)
- Watchdog timer, Digital I/O, iAMT (14), TPM (2.0)

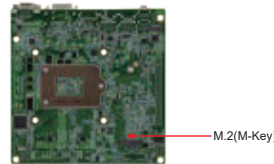

## Specifications

CPU Socket	LGA1200
CPU	10th Gen Intel® Xeon® W / Core™ / Pentium® / Celeron® processors, up to 4.8GHz
PCH	MI999AF-W: W480E MI999AF-Q: Q470E MI999EF-H: H420E
Memory	2x DDR4 SO-DIMM socket, Max 64GB (supports ECC by CPU SKU)
BIOS	AMI
Watchdog Timer	256 levels
H/W Monitor	Yes
Storage Device Interface	1x M.2 (M2280) NVMe
Expansion Slots	1x PCI-E (X16)
Mini Type Slots	1x M.2(E-key@2230), supports CNVi 1x M.2(M-key@2280), supports NVMe (for MI999AF-W/MI999AF-Q Series only)
Graphics Controller	Intel® UHD Graphics 630
Video Output	Supports, DVI-D, HDMI (1.4b), DisplayPort (1.2), and eDP or 24-bit Dual channel LVDS
Ethernet	1st LAN MI999AF-W/ MI999AF-Q: Intel® I219LM MI999EF-H: Intel® I219V 2nd LAN MI999AF-W: Intel® I210AT MI999AF-Q/ MI999EF-H: Intel® I211AT or I210AT
I/O Chipset	Fintek F81964D-I
Serial Port	MI999AF-W/ MI999AF-Q: COM1 ~ COM2 (RS232/422/485) MI999EF-H: COM1 ~ COM2 (RS232) COM3 ~ COM4: RS232
USB 2.0	4x USB 2.0 onboard
USB 3.X	6x USB 3.2 (Gen1, 5Gbps)
Serial ATA	4x SATA III
Audio	Built-in HD audio + Realtek ALC888S codec
TPM	2.0
Others	Digital I/O (4-in/4-out), RAID, iAMT (14) or Eup/ErP
Dimensions (L x W)	170mm x 170mm
Power Consumption	Intel® Core™ i5-10500E, 3.00GHz, with 2x 4GB DDR4 2133 +12V: 6.08A +5V: 1.19A +5Vsb: 0.11A +3.3V: 0.90A

Operating Temperature	0°C ~ 60°C (32°F~140°F)
Storage Temperature	-20°C ~ 80°C (-4°F ~ 176°F)
Relative Humidity	95% (non-condensing @60°C)

## Ordering Information

MI999AF-W	LGA1200 W480E Mini-ITX motherboard w/ DVI-D, HDMI, DisplayPort, LVDS, Dual Gigabit LAN, RAID, iAMT(14), TPM(2.0)
MI999AFE-W	LGA1200 W480E Mini-ITX motherboard w/ DVI-D, HDMI, DisplayPort, eDP, Dual Gigabit LAN, RAID, iAMT(14), TPM(2.0)
MI999AF-Q	LGA1200 Q470E Mini-ITX motherboard w/ DVI-D, HDMI, DisplayPort, LVDS, Dual Gigabit LAN, RAID, iAMT(14), TPM(2.0)
MI999AFE-Q	LGA1200 Q470E Mini-ITX motherboard w/ DVI-D, HDMI, DisplayPort, eDP, Dual Gigabit LAN, RAID, iAMT(14), TPM(2.0)
MI999EF-H	LGA1200 H420E Mini-ITX motherboard w/ DVI-D, HDMI, DisplayPort, LVDS, Dual Gigabit LAN, EuP/ErP, TPM(2.0)
MI999EFE-H	LGA1200 H420E Mini-ITX motherboard w/ DVI-D, HDMI, DisplayPort, eDP, Dual Gigabit LAN, EuP/ErP, TPM(2.0)

## Dimensions and Drawing

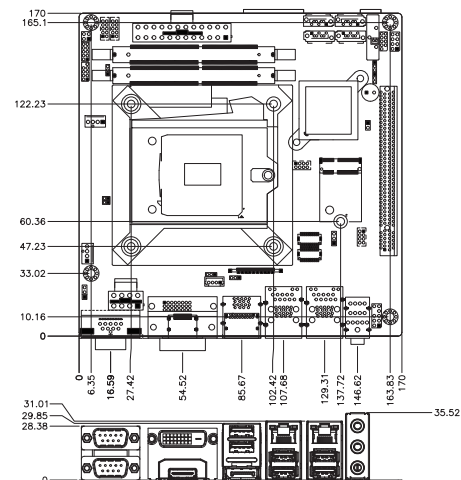

1 CPU Modules

2 Single Board Computers

3 Motherboards

4 CPU Cards

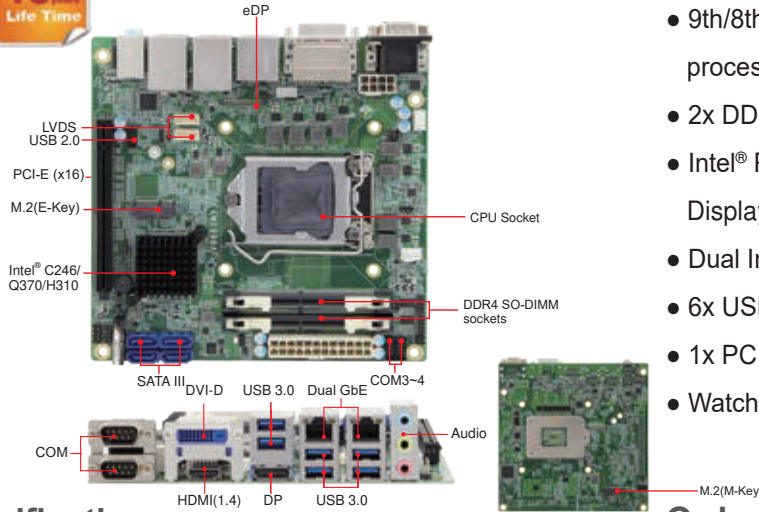

## Features

- 9th/8th Gen Intel® Xeon® E / Core™ / Pentium® / Celeron® processors, up to 4.7GHz
- 2x DDR4 SO-DIMM, Max. 32GB, ECC compatible
- Intel® Processor integrated graphics, supports DVI-D, HDMI, DisplayPort and 24-bit dual channel LVDS or eDP
- Dual Intel® Gigabit LAN
- 6x USB 3.0, 2x USB 2.0, 4x COM, 4x SATA III
- 1x PCI-E (x16), 2x M.2
- Watchdog timer, Digital I/O, iAMT (11.6), TPM (2.0)

## Specifications

CPU Socket	LGA1151
CPU	9th/8th Gen Intel® Xeon® E / Core™ / Pentium® / Celeron® processors, up to 4.7GHz
PCH	MI998AF(E)-C246: Intel® C246 PCH MI998AF(E): Intel® Q370 PCH MI998EF(E): Intel® H310 PCH
Memory	2x DDR4 SO-DIMM, Max. 32GB (supports ECC by CPU SKU)
BIOS	AMI
Watchdog Timer	256 levels
H/W Monitor	Yes
Storage Device Interface	NVMe
Expansion Slots	1x PCI-E (x16)
Mini Type Slots	1x M.2 (E-key, type:2230) 1x M.2 (M-key, type:2280)
Graphics Controller	Intel® UHD Graphics P630
Video Output	Supports, DVI-D, HDMI (1.4), DisplayPort(1.2), and eDP or 24-bit Dual channel LVDS
Ethernet	1st LAN MI998AF-C246 & MI998AF: Intel® I219LM MI998EF: Intel® I219V 2nd LAN MI998AF-C246: Intel® I210AT MI998AF & MI998EF: Intel® I211AT or I210AT
I/O Chipset	Fintek F81964D-I
Serial Port	MI998AF(E)-C246: COM1 ~ COM2 (RS232/422/485) MI998AF(E): COM1 ~ COM2 (RS232/422/485) (Jumper-less selection) MI998EF(E): COM1 ~ COM2 (RS232) COM3 ~ COM4: RS232
USB 2.0	MI998AF-C246 / MI998AF: 2x USB 2.0 MI998EF: 2x USB 2.0
USB 3.X	MI998AF-C246 / MI998AF: 6x USB 3.0 MI998EF: 4x USB 3.0
SATA	4x SATA III
Audio	Intel® C246/ Q370/ H310 PCH-H built-in HD audio + Realtek ALC888S codec
TPM	TPM (2.0)
Others	Digital I/O (4-in/4-out); RAID, iAMT (11.6) or Eup/ErP
Dimensions (L x W)	170mm x 170mm
Power Consumption	Intel® i7-8700, w/ DDR4-2400 8GB +12V: 6.36A; +5V:1.46A; +5VSB: 0.07A; +3.3V: 0.37A
Operating Temperature	0°C ~ 60°C (32°F~140°F)
Storage Temperature	-20°C ~ 80°C (-4°F ~ 176°F)
Relative Humidity	90% (non-condensing @60°C)

## Ordering Information

MI998AF-C246	LGA1151 C246 Mini-ITX motherboard w/ DVI-D, HDMI, DisplayPort, LVDS, Dual Gigabit LAN, RAID, iAMT(11.6), TPM(2.0)
MI998AFE-C246	LGA1151 C246 Mini-ITX motherboard w/ DVI-D, HDMI, DisplayPort, eDP, Dual Gigabit LAN, RAID, iAMT(11.6), TPM(2.0)
MI998AF	LGA1151 Q370 Mini-ITX motherboard w/ DVI-D, HDMI, DisplayPort, LVDS, Dual Gigabit LAN, RAID, iAMT(11.6), TPM(2.0)
MI998AFE	LGA1151 Q370 Mini-ITX motherboard w/ DVI-D, HDMI, DisplayPort, eDP, Dual Gigabit LAN, RAID, iAMT(11.6), TPM(2.0)
MI998EF	LGA1151 H310 Mini-ITX motherboard w/ DVI-D, HDMI, DisplayPort, LVDS, Dual Gigabit LAN, TPM(2.0)
MI998EFE	LGA1151 H310 Mini-ITX motherboard w/ DVI-D, HDMI, DisplayPort, eDP, Dual Gigabit LAN, TPM(2.0)

## Dimensions and Drawing

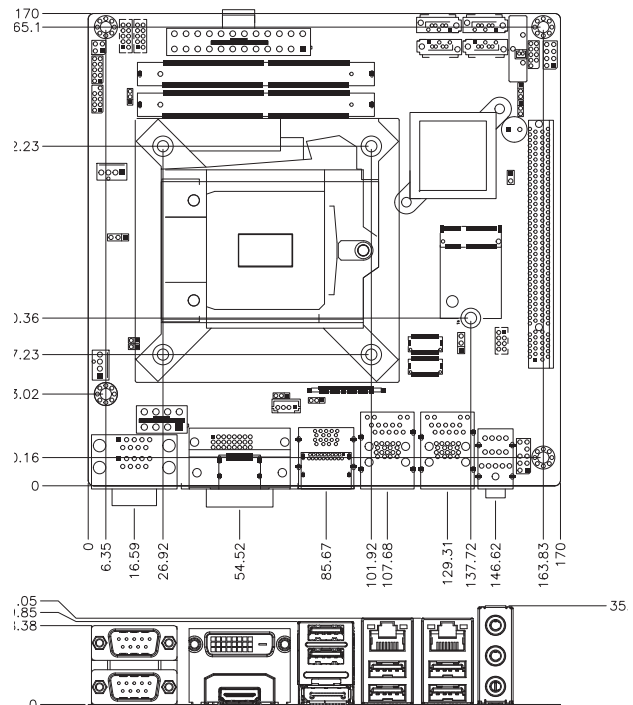



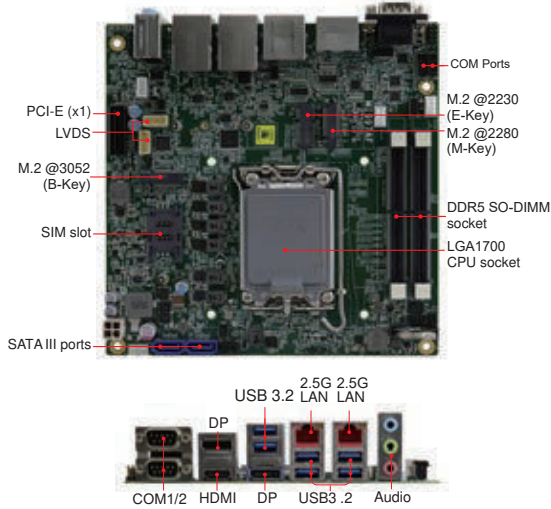

## Features

- 12th Gen Intel® Core i7/i5/i3 and Celeron® Processors
- 2x **DDR5** SO-DIMM sockets, Max. 64GB
- Intel® processor integrated graphics supports HDMI (2.0a), LVDS and 2x DisplayPort (1.4a) (DP++)
- Dual Intel® 2.5G LAN
- 4x USB 3.2, 2x USB 3.1, 2x USB 2.0, 4x COM, 2x SATA III
- 1x PCI-E (x1) [Gen.3.0]; 4x M.2 (B-key, E-key and 2x M-Key)
- Watchdog timer, Digital I/O, iAMT(16.0) , fTPM
- 12V~24V DC input

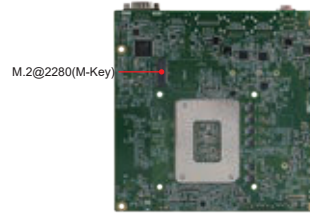

## Specifications

CPU Socket	LGA1700
CPU	12th Gen Intel® Core™ i7/i5/i3 and Celeron® socket SoC Processors
PCH	N/A
Memory	2x <b>DDR5</b> SO-DIMM sockets, supports DDR5-4800 memory module, Max. 64GB
BIOS	AMI
Watchdog Timer	256 levels
H/W Monitor	Yes
Storage Device Interface	SATA III & NVMe
Expansion Slots	1x PCI-E (x1) [Gen.3.0]
Mini Type Slots	2x M.2 (M-key, type:2280, PCI-E(4x) Gen.4) 1x M.2 (E-Key, type:2230, USB 2.0 + PCI-E(1x)) 1x M.2 (B-Key, type:3052, USB 3.2 + PCI-E(1x))
Graphics Controller	12th Gen Intel® Core™ i7/i5/i3 and Celeron® Processors
Video Output	1x HDMI (2.0a) + 2x DisplayPort (1.4a) (DP++) + LVDS
Ethernet	LAN 1: Intel® I226LM, supports 2.5G and iAMT LAN 2: Intel® I226V, supports 2.5G only
I/O Chipset	Fintek F81964D-I
Serial Port	4 COM ports : 2x RS232/422/485 + 2x RS232
USB 2.0	2x USB 2.0 via pin-headers
USB 3.X	6x USB 3.2 (10 bps) @ edge connector
Serial ATA	2x SATA III
Audio	Built-in HD Audio controller + Realtek ALC888S w/ 7.1 channels
TPM	Supports fTPM
Others	12V~24V DC-in, Digital I/O (4-in/4-out), Watchdog timer, SIM socket
Dimensions (L x W)	170mm x 170mm (6.7" x 6.7")
Power Consumption	Intel® Core™ i7-12700HL w/ 2x 32GB DDR5-4800 +12V:13.21A
Operating Temperature	0°C~60°C ( 32°F~140°F)
Storage Temperature	-20°C~80°C (-4°F~176°F)
Relative Humidity	90% (non-condensing @60°C)

## Ordering Information

MI997AF	LGA1700 Mini-ITX Motherboard w /HDMI, LVDS, 2x DisplayPort, Dual 2.5GbE, 2x SATA, RAID, iAMT (16.0), TPM (2.0)
---------	--

## Dimensions and Drawing

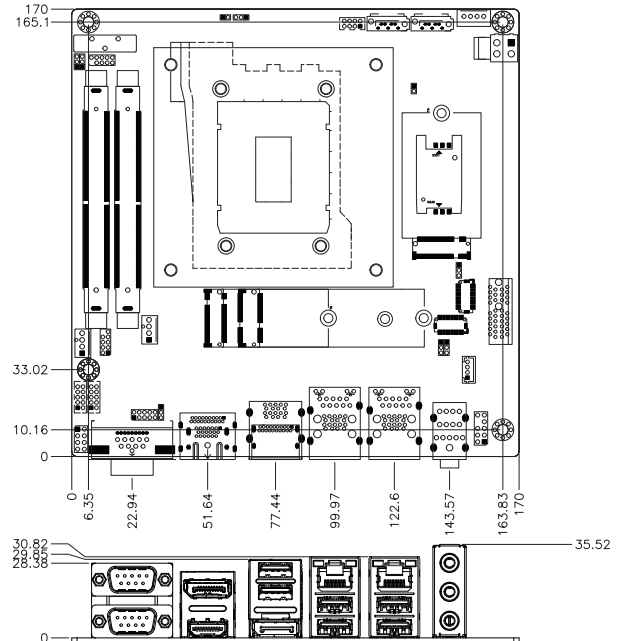

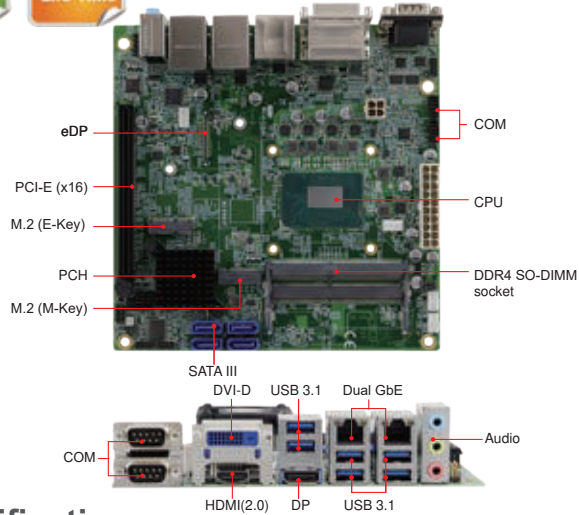

## Features

- Onboard 9th Gen Intel® Xeon® E / Core™ i7/i5/i3/ Celeron® processors
- 2x DDR4 SO-DIMM sockets, Max. 32GB
- Supports eDP, HDMI(2.0a) / DVI-D and DisplayPort
- 2x Intel® Gigabit LAN
- 6x USB 3.1, 4x USB 2.0, 4x COM, 4x SATA III
- 1x PCI-E (x16), 1x Mini PCI-E, 2x M.2
- Watchdog timer, Digital I/O, iAMT (11.6), TPM(2.0), iSMART, vPRO (MI996VF series)



## Specifications

CPU Socket	FCBGA1440
CPU	9th Gen Intel® Xeon® E / Core™ i7/i5/i3 / Celeron® processors
PCH	MI996VF-X28/26: Intel® CM246 PCH MI996VF-9850: Intel® QM370 PCH MI996EF-9100/ 4930: Intel® HM370 PCH
Memory	2x DDR4-2666 SO-DIMM socket, Max. 32GB (supports ECC by CPU SKUs)
BIOS	AMI
Watchdog Timer	256 levels
H/W Monitor	Yes
Storage Device Interface	mSATA, M.2
Expansion Slots	1x PCI-E (x16)
Mini Type Slots	1x Mini PCI-E 1x M.2 (M-key, type:2280, NVMe) 1x M.2 (E-Key, type:2230, CNVi)
Graphics Controller	9th Gen Intel® Xeon® / Core™ i7/i5/i3 processor integrated
Video Output	Supports eDP, HDMI(2.0a), DisplayPort and DVI-D
Ethernet	LAN 1: MI996VF-Series: Intel® I219LM Gigabit LAN PHY MI996EF: Intel® I219V Gigabit LAN PHY LAN 2: MI996VF-X26/28: Intel® I210AT Gigabit LAN MI996VF-9100/MI996EF-9100: Intel® I211AT or I210AT Gigabit LAN
I/O Chipset	Fintek F81964D-I
Serial Port	2x RS232/422/485, 2x RS232
USB 2.0	4x USB 2.0 via pin header
USB 3.X	6x USB 3.1 on board
Serial ATA	MI996VF-X26/28: 4x SATA III MI996VF-9850, MI996EF-9100: 2x SATA III
Audio	Intel® [CNL PCH-H integrated] built-in HD audio + Realtek ALC888S codec
TPM	TPM (2.0)
Others	Digital I/O (4-in/4-out); TPM 2.0, iSMART, EuP/ErP, RAID, iAMT (11.6), ATX
Dimensions (L x W)	170mm x 170mm (6.7" x 6.7")
Power Consumption	Intel® Xeon E-2176G, 3.7GHz w/ 8GB DDR4-2400 +12V: 7.73A, +5V: 1.59A, +5VBS: 0.17A, +3.3V: 0.32A
Operating Temperature	0°C~60°C ( 32°F~140°F)
Storage Temperature	-20°C~80°C (-4°F~176°F)
Relative Humidity	90% (non-condensing @60°C)

## Ordering Information

MI996VF-X28	FCBGA1440 Intel® CM246/ Xeon® E-2276ME Mini-ITX motherboard, w/ HDMI (2.0a), DisplayPort, DVI-D and eDP, dual Gigabit LAN, TPM (2.0), RAID, vPro, iAMT (11.6), iSMART (3.8), CPU cooler on board
MI996VF-9850	FCBGA1440 Intel® QM370/ Core™ i7-9850HE Mini-ITX motherboard, w/ HDMI (2.0a), DisplayPort, DVI-D and eDP, dual Gigabit LAN, TPM (2.0), RAID, vPro, iAMT (11.6), iSMART (3.8), CPU cooler on board
MI996EF-9100	FCBAG1440 Intel® HM370/ Core™ i3-9100HL Mini-ITX motherboard, w/ HDMI (2.0a), DisplayPort, DVI-D and eDP, dual Gigabit LAN, TPM (2.0), EuP/ErP, CPU cooler on board
MI996EF-4930	FCBAG1440 Intel® HM370/ Celeron® G4930E Mini-ITX motherboard, w/ HDMI (2.0a), DisplayPort, DVI-D and eDP, dual Gigabit LAN, TPM (2.0), EuP/ErP, CPU cooler on board

## Dimensions and Drawing

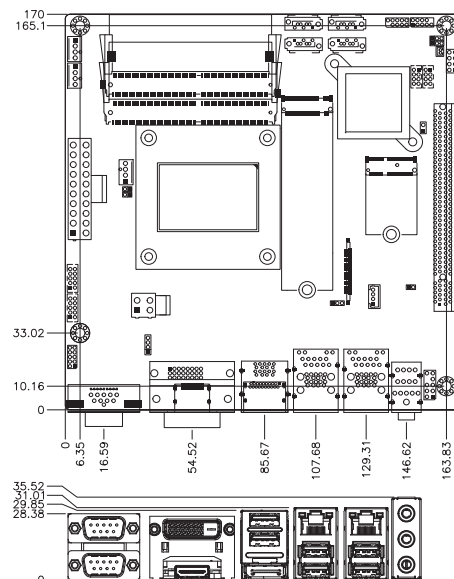

# MI995

## Mini-ITX Motherboard

8th Gen Intel® Xeon® E / Core™ i7/i5/i3  
with Intel® CM246/QM370/HM370 PCH

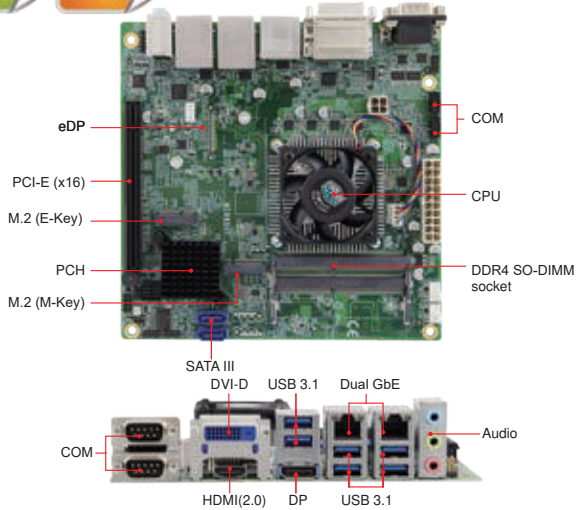

### Features

- 8th Gen Intel® Xeon® E / Core™ i7/i5/i3
- 2x DDR4 SO-DIMM sockets, Max. 32GB
- Supports eDP, HDMI(2.0a) / DVI-D and DisplayPort
- 2x Intel® Gigabit LAN
- 6x USB 3.1, 4x USB 2.0, 4x COM, 4x SATA III
- 1x PCI-E (x16), 1x Mini PCI-E, 2x M.2
- Watchdog timer, Digital I/O, iAMT (11.6), TPM(2.0), iSMART, vPRO (MI995VF series)

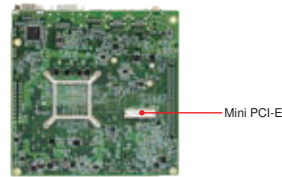

### Specifications

CPU Socket	FCBGA1440
CPU	8th Gen Intel® Xeon® E / Core™ i7/i5/i3 processors
PCH	MI995VF-X27: Intel® CM246 PCH MI995VF-8850/8400: Intel® QM370 PCH MI995EF-8100: Intel® HM370 PCH
Memory	2x DDR4-2666 SO-DIMM socket, Max. 32GB (supports ECC by CPU SKUs)
BIOS	AMI
Watchdog Timer	256 levels
H/W Monitor	Yes
Storage Device Interface	mSATA, M.2
Expansion Slots	1x PCI-E (x16)
Mini Type Slots	1x Mini PCI-E 1x M.2 (M-key, type:2280, NVMe) 1x M.2 (E-Key, type:2230, CNVI)
Graphics Controller	8th Gen Intel® Xeon® / Core™ i7/i5/i3 processor integrated
Video Output	Supports eDP, HDMI(2.0a), DisplayPort and DVI-D
Ethernet	LAN 1: MI995VF-Series: Intel® I219LM Gigabit LAN PHY MI995EF: Intel® I219V Gigabit LAN PHY LAN 2: MI995VF-X27: Intel® I210AT Gigabit LAN MI995VF-8850/8400/MI995EF-8100: Intel® I211AT or I210AT Gigabit LAN
I/O Chipset	Fintek F81964D-I
Serial Port	2x RS232/422/485, 2x RS232
USB 2.0	4x USB 2.0 via pin header
USB 3.X	6x USB 3.1 on board
Serial ATA	MI995VF-X27: 4x SATA III MI995VF-8850/8400, MI995EF-8100: 2x SATA III
Audio	Intel® [CNL PCH-H integrated] built-in HD audio + Realtek ALC888S codec
TPM	TPM (2.0)
Others	Digital I/O (4-in/4-out); TPM 2.0, iSMART, EuP/ErP, RAID, iAMT (11.6), ATX
Dimensions (L x W)	170mm x 170mm (6.7" x 6.7")
Power Consumption	Intel® Core™ i5-8400H, 2.50GHz, w/ 2 x 16GB DDR4-2133 +12V: 3.01A +5V: 1.43A +5VSB: 0.15A +3.3V: 0.32A

Operating Temperature	0°C~60°C ( 32°F~140°F)
Storage Temperature	-20°C~80°C (-4°F~176°F)
Relative Humidity	90% (non-condensing @60°C)

### Ordering Information

MI995VF-X27	FCBGA1440 Intel® CM246/ Xeon® E-2176M Mini-ITX motherboard, w/ HDMI (2.0a), DisplayPort, DVI-D and eDP, dual Gigabit LAN, TPM (2.0), RAID, vPro, iAMT (11.6), iSMART (3.5), CPU cooler on board
MI995VF-8850	FCBGA1440 Intel® QM370/ Core™ i7-8850H Mini-ITX motherboard, w/ HDMI (2.0a), DisplayPort, DVI-D and eDP, dual Gigabit LAN, TPM (2.0), RAID, vPro, iAMT (11.6), iSMART (3.5), CPU cooler on board
MI995VF-8400	FCBGA1440 Intel® QM370/ Core™ i5-8400H Mini-ITX motherboard, w/ HDMI (2.0a), DisplayPort, DVI-D and eDP, dual Gigabit LAN, TPM (2.0), RAID, vPro, iAMT (11.6), iSMART (3.5), CPU cooler on board
MI995EF-8100	FCBGA1440 Intel® HM370/ Core™ i3-8100H Mini-ITX motherboard, w/ HDMI (2.0a), DisplayPort, DVI-D and eDP, dual Gigabit LAN, TPM (2.0), EuP/ErP, CPU cooler on board

### Dimensions and Drawing

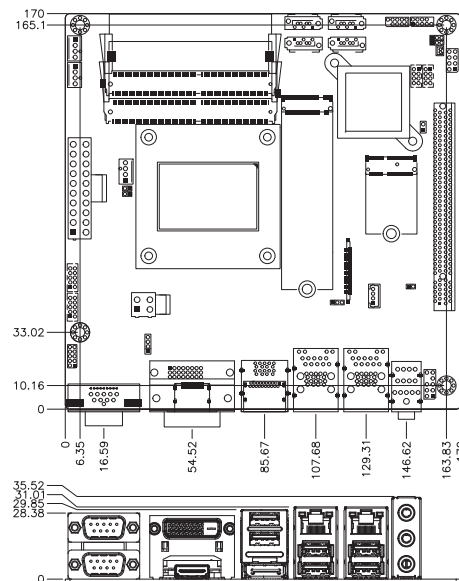

1 CPU Modules

2 Single Board Computers

3 Motherboards

4 CPU Cards



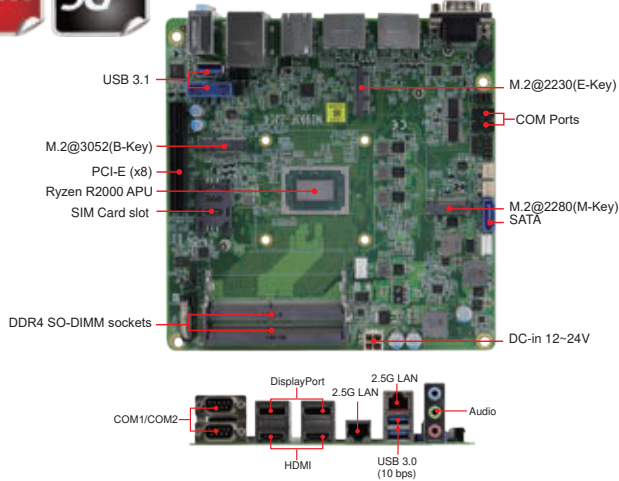

### Features

- AMD Ryzen™ Embedded R2000 series APU on board
- 2x DDR4 SO-DIMM sockets, Max. 32GB
- Dual Intel® 2.5G LAN
- 2x HDMI + 2x DisplayPort
- 5x USB 3.1, 2x USB 2.0, 4x COM, 1x SATA III
- 1x PCI-E (x8), 3x M.2 (B-key, E-key and M-Key)
- Watchdog timer, Digital I/O, TPM (2.0)

### Specifications

CPU Socket	BGA1440
CPU	AMD Ryzen™ Embedded R2000 series APU onboard
PCH	N/A
Memory	2x DDR4-2666/2400 SO-DIMM socket, Max. 32GB, ECC compatible
BIOS	AMI
Watchdog Timer	256 levels
H/W Monitor	Yes
Storage Device Interface	M.2 (M-key)
Expansion Slots	1x PCI-E (x8) [R2514 & R2314] or 1x PCI-E(x4) [R2312]
Mini Type Slots	1x M.2 (M-key, type:2280, SATA + PCI-E) 1x M.2 (E-Key, type:2230, USB 2.0 + PCI-E) 1x M.2 (B-Key, type:3052, USB 3.1 + PCI-E + SMBus) [R2514 & R2314]
Graphics Controller	AMD Radeon Graphics
Video Output	2x HDMI + 2x DP (R2514 & R2314) 2x HDMI + DP (R2312)
Ethernet	LAN 1: Intel® I226V LAN 2: Intel® I226V (R2514 & R2314)
I/O Chipset	Nuvoton NCT6116D
Serial Port	4x COM ports: 2x RS232/422/485, 2x RS232
USB 2.0	2x USB 2.0 via pin header
USB 3.X	2x USB 3.2 (10bps)@ edge connector; 2x USB 3.1 (5bps) via onboard box-header 1x USB 3.1 (5bps) thru onboard connector (R2514 & R2314)
Serial ATA	1x SATA III
Audio	Built-in HD Audio controller + Realtek ALC888S w/ 5.1 channels
TPM	2.0
Others	Digital I/O (4-in/4-out) , Watchdog timer, SIM
Dimensions (L x W)	170mm x 170mm (6.7" x 6.7")
Power Consumption	TBD
Operating Temperature	0°C~60°C ( 32°F~140°F)
Storage Temperature	-20°C~80°C (-4°F~176°F)
Relative Humidity	90% (non-condensing @60°C)

### Ordering Information

MI993F-2514	AMD Ryzen™ R2514 (2.1GHz~3.7GHz) APU onboard, 2x HDMI, 2x DisplayPort, 1x SATA, 2x 2.5G LAN, TPM (2.0), CPU cooler on board
MI993F-2314	AMD Ryzen™ R2314 (2.1GHz~3.5GHz) APU onboard, 2x HDMI, 2x DisplayPort, 1x SATA, 2x 2.5G LAN, TPM (2.0), CPU cooler on board
MI993F-2312	AMD Ryzen™ R2312 (2.7GHz~3.5GHz) APU onboard, 2x HDMI, 1x DisplayPort, 1x SATA, 1x 2.5G LAN, TPM (2.0), CPU cooler on board

### Dimensions and Drawing

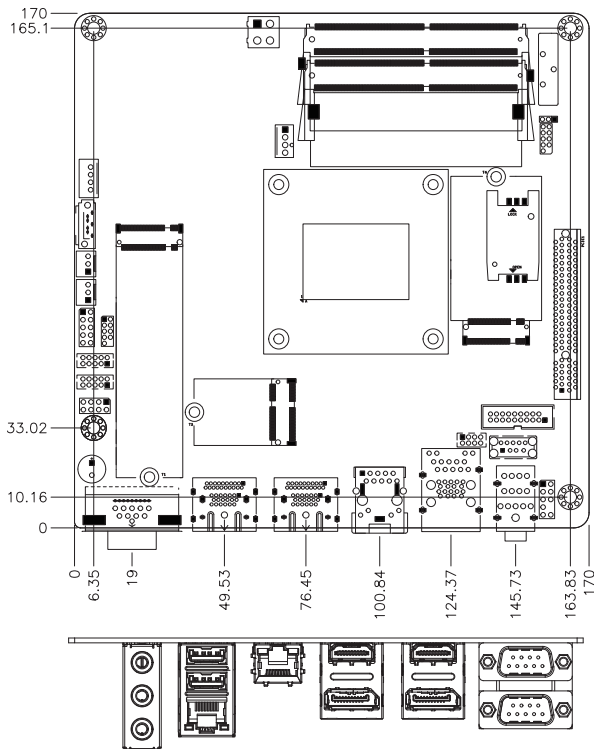

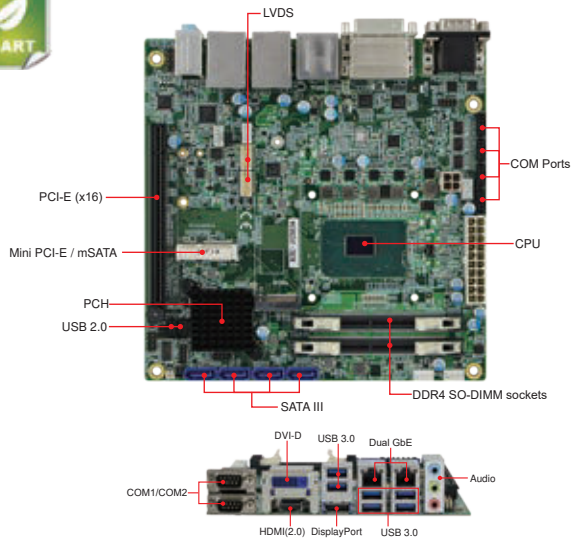

## Features

- Onboard 7th Gen Intel® Xeon® E3 / Core™ i7/i5/i3
- 2x DDR4 SO-DIMM, Max.32GB, ECC
- Intel® processor integrated graphics, supports DVI-D, HDMI 1.4, DisplayPort and 24-bit dual-channel LVDS
- 2x Intel® Gigabit LAN
- 6x USB 3.0, 4x USB 2.0, 4x SATA III, 4x COM
- 1x PCI-E (x16), 2x Mini PCI-E, 1x mSATA, 1x M.2
- Watchdog timer, Digital I/O, iAMT 11.6, TPM 2.0, vPro, iSMART

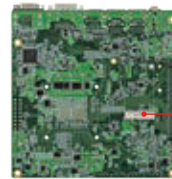

Mini PCI-E

## Specifications

CPU Socket	BGA1440
CPU	7th Gen Intel® Xeon® E3 / Core™ i7/i5/i3 processors, up to 3.7GHz
PCH	MI992VF series: Intel® CM238 PCH MI992EF series: HM175 PCH
Memory	2x DDR4 SO-DIMM, Max.32GB (supports ECC by CPU SKUs)
BIOS	AMI
Watchdog Timer	256 levels
H/W Monitor	Yes
Storage Device Interface	1x mSATA via Mini PCI-E (via SATA III and PCI-E) 1x M.2 slot (Thru SATA III and PCI-E)
Expansion Slots	1x PCI-E (x16)
Mini Type Slots	2x Mini PCI-E 1x M.2
Graphics Controller	7th Gen Intel® Xeon® / Core™ i7/i5/i3 processor integrated
Video Output	Supports DVI-D, HDMI (1.4), DisplayPort and 24-bit dual-channel LVDS
Ethernet	MI992VF series: Intel® I219LM Gigabit LAN PHY MI992EF series: Intel® I219V Gigabit LAN PHY Intel® I211AT or I210AT Gigabit LAN (as 2nd LAN)
I/O Chipset	Fintek F81846AD-I
USB 2.0	4x USB 2.0 via pin-header
USB 3.X	6x USB 3.0 on board
Serial ATA	MI992VF series: 4x SATA III MI992EF series: 2x SATA III
Audio	Intel® CM238 / HM175 PCH built-in HD audio + Realtek ALC888S codec
TPM	TPM (2.0)
Others	Digital I/O (4-in/4-out), RAID, iAMT (11.6), iSMART
Dimensions (L x W)	170mm x 170mm (6.7" x 6.7")
Power Consumption	Intel® Core i7-7820EQ, 3.00GHz, w / 2x 4GB DDR4-2133 +12V: 4.67A +5V: 1.39A +5VSB: 0.05A +3.3V: 0.35A
Operating Temperature	0°C ~ 60°C (32°F ~ 140°F)
Storage Temperature	-20°C ~ 80°C (-4°F ~ 176°F)
Relative Humidity	90% (non-condensing @60°C)

## Ordering Information

MI992VFS-X3G	BGA1440 Intel® CM238/ Xeon® E3-1505M v6(3.0GHz) Mini-ITX Motherboard w/ DVI-D, HDMI (1.4), DisplayPort, LVDS, dual Gigabit LAN, RAID, iAMT (11.6), TPM (2.0), vPro, iSMART, CPU cooler on board
MI992VFS-7820	BGA1440 Intel® CM238/ Core™ i7-7820EQ(3.0GHz) Mini-ITX Motherboard w/ DVI-D, HDMI (1.4), DisplayPort, LVDS, dual Gigabit LAN, RAID, iAMT (11.6), TPM (2.0), vPro, iSMART, CPU cooler on board
MI992VFS-7440	BGA1440 Intel® CM238/ Core™ i5-7440EQ(2.9GHz) Mini-ITX Motherboard w/ DVI-D, HDMI (1.4), DisplayPort, LVDS, dual Gigabit LAN, RAID, iAMT (11.6), TPM (2.0), vPro, iSMART, CPU cooler on board
MI992EFS-7100	BGA1440 Intel® HM175/ Core™ i3-7100E(2.9GHz) Mini-ITX Motherboard w/ DVI-D, HDMI (1.4), DisplayPort, LVDS, dual Gigabit LAN, RAID, EuP/ErP compliant, iSMART, CPU cooler on board

## Dimensions and Drawing

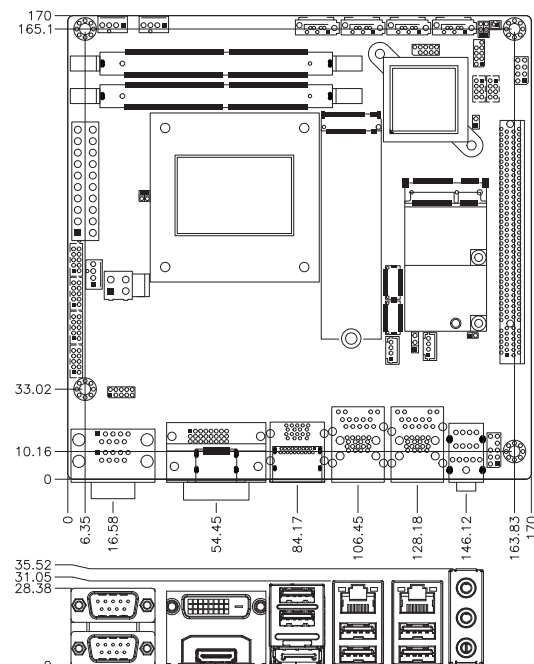



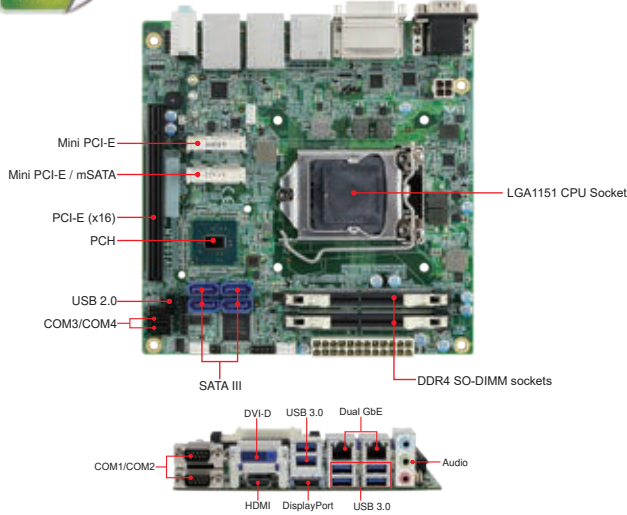

## Features

- 7th/6th Gen Intel® Xeon® E3 / Core™ i7/i5/i3 / Pentium® / Celeron® QC/DC processors, up to 4.0GHz
- 2x DDR4 SO-DIMM, Max. 32GB, ECC compatible
- Intel® Processor integrated graphics, supports DVI-D, HDMI and DisplayPort
- Dual Intel® Gigabit LAN
- 2x USB 2.0, 6x USB 3.0, 4x COM, 4x SATA III
- 2x Mini PCI-E slots, 1x mSATA, 1x PCI-E (x16)
- Watchdog timer, Digital I/O, iAMT (11.0), TPM (1.2), iSMART

## Specifications

CPU Socket	LGA1151
CPU	7th/6th Gen Intel® Xeon® E3/ Core™ i7/i5/i3/ Pentium®/ Celeron® QC/ DC processors, up to 4.0GHz
PCH	MI991AF-C236: Intel® C236 PCH MI991AF: Intel® Q170 PCH MI991EF: Intel® H110 PCH
Memory	2x DDR4 SO-DIMM, Max. 32GB (supports ECC by CPU SKUs)
BIOS	AMI
Watchdog Timer	256 levels
H/W Monitor	Yes
Storage Device Interface	1x mSATA
Expansion Slots	1x PCI-E (x16)
Mini Type Slots	2x Mini PCI-E
Graphics Controller	7th/6th Gen Intel® Xeon®/ Core™ i7/i5/i3/ Pentium® processor Integrated
Video Output	Supports DVI-D, HDMI and DisplayPort
Ethernet	MI991AF: Intel® I219LM Gigabit LAN PHY MI991EF: Intel® I219V Gigabit LAN PHY Intel® I211AT or I210AT Gigabit LAN (as 2nd LAN)
I/O Chipset	Fintek F81846D-I
Serial Port	3x RS232, 1x RS232/422/485 (jumper-less selection)
USB 2.0	MI991EF: 2x USB 2.0 on board 2x USB 2.0 via pin-header
USB 3.X	MI991AF series: 6x USB 3.0 on board MI991EF: 4x USB 3.0
Serial ATA	MI991AF series: 4x SATA III MI991EF: 3x SATA III
Audio	Intel® C236/ Q170/ H110 PCH built-in HD audio + Realtek ALC888S codec
TPM	TPM (1.2)
Others	Digital I/O(4-in/4-out), EuP/ErP, RAID, iAMT (11.0), iSMART
Dimensions (L x W)	170mm x 170mm (6.7" x 6.7")
Power Consumption	Intel® Core™ I5-6500TE 2.3GHz w/ 2x DDR4-2133 4GB +12V: 3.56A; +5V: 1.28A; +5VSB: 0.08A; +3.3V: 0.32A
Operating Temperature	0°C~60°C (32°F~140°F)
Storage Temperature	-20°C~80°C (-4°F~176°F)
Relative Humidity	90% (non-condensing @60°C)

## Ordering Information

MI991AFS-C236	LGA1151 C236 Mini-ITX motherboard w/ DVI-D, HDMI, DisplayPort, dual Gigabit LAN, RAID, iAMT (11.0), TPM (1.2), iSMART (3.0)
MI991AFS	LGA1151 Q170 Mini-ITX motherboard w/ DVI-D, HDMI, DisplayPort, dual Gigabit LAN, RAID, iAMT (11.0), TPM (1.2), iSMART (3.0)
MI991EFS	LGA1151 H110 Mini-ITX motherboard w/ DVI-D, HDMI, DisplayPort, dual Gigabit LAN, EuP/ErP, iSMART (3.0)

## Dimensions and Drawing

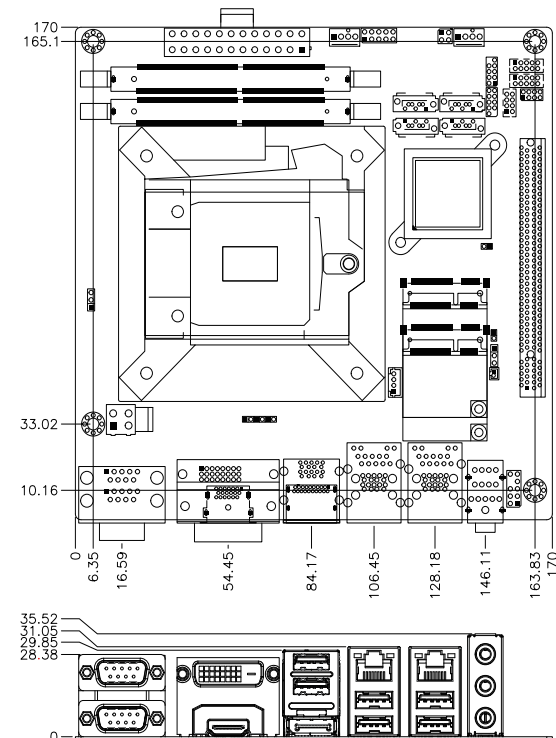

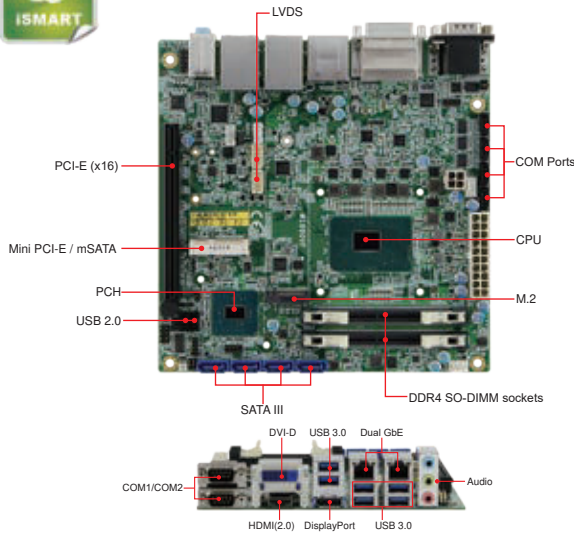

## Features

- Onboard 6th Gen Intel® Xeon® E3 / Core™ i7/i5/i3 / Celeron® QC/DC processors, up to 3.7GHz
- 2x DDR4 SO-DIMM, Max. 32GB, ECC compatible
- Intel® Processor integrated graphics device, supports DVI-D, HDMI (2.0), DisplayPort and 24-bit dual-channel LVDS
- 2x Intel® Gigabit LAN
- 4x USB 2.0, 6x USB 3.0, 6x COM, 4x SATA III
- 1x PCI-E (x16), 2x Mini PCI-E, 1x mSATA, 1x M.2
- Watchdog timer, Digital I/O, iAMT (11.0), TPM (2.0), vPro, iSMART 3.0

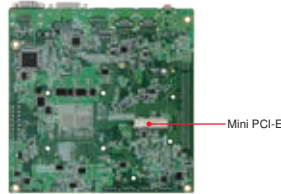

## Specifications

CPU Socket	BGA1440
CPU Socket	6th Gen Intel® Xeon® E3 / Core™ i7/i5/i3 / Celeron® QC/ DC processors, up to 3.7GHz
PCH	MI990VF series: Intel® CM236 PCH MI990EF series: Intel® HM170 PCH
Memory	2x DDR4 SO-DIMM, Max. 32GB (supports ECC by CPU SKUs)
BIOS	AMI
Watchdog Timer	256 levels
H/W Monitor	Yes
Storage Device Interface	1x mSATA via Mini PCI-E (Thru SATA III) 1x M.2 slot (Thru SATA III & PCI-E)
Expansion Slots	1x PCI-E (x16)
Mini Type Slots	2x Mini PCI-E 1x M.2
Graphics Controller	6th Gen Intel® Xeon® / Core™ i7/ i5/ i3 / Celeron® processor integrated
Video Output	Supports DVI-D, HDMI (2.0), DisplayPort and 24-bit dual-channel LVDS
Ethernet	MI990VF series: Intel® I219LM Gigabit LAN PHY MI990EF series: Intel® I219V Gigabit LAN PHY Intel® I211AT or I210AT Gigabit LAN (as 2nd LAN)
I/O Chipset	Fintek F81866AD-I
Serial Port	5x RS232 1x RS232/422/485 (jumper-less selection)
USB 2.0	4x USB 2.0 via pin-header
USB 3.X	6x USB 3.0 on board
Serial ATA	MI990VF series: 4x SATA III MI990EF series: 2x SATA III
Audio	Intel® CM236 / HM170 PCH built-in HD audio + Realtek ALC888S codec
TPM	TPM (2.0)
Others	Digital I/O(4-in/4-out), RAID, iAMT (11.0), iSMART
Dimensions (L x W)	170mm x 170mm (6.7" x 6.7")
Power Consumption	Intel® Core™ i5-6400EQ 2.4GHz w/ 2x 8GB DDR4-2133 +12V: 2.84A; +5V: 1.45A; +5VSB: 0.058A; +3.3V: 0.52A
Operating Temperature	0°C~60°C (32°F~140°F)
Storage Temperature	-20°C~80°C (-4°F~176°F)
Relative Humidity	90% (non-condensing @60°C)

## Ordering Information

MI990VF-X28E	BGA1440 Intel® CM236/ Xeon® E3-1505M v5(2.8GHz) Mini-ITX motherboard w/ DVI-D, HDMI (2.0), DisplayPort, LVDS, dual Gigabit LAN, RAID, iAMT (11.0), TPM (2.0), vPro, iSMART (3.0), CPU cooler on board
MI990VF-6820E	BGA1440 Intel® CM236/ Core™ i7-6820EQ(2.8GHz) Mini-ITX motherboard w/ DVI-D, HDMI (2.0), DisplayPort, LVDS, dual Gigabit LAN, RAID, iAMT (11.0), TPM (2.0), vPro, iSMART (3.0), CPU cooler on board
MI990VF-6440E	BGA1440 Intel® CM236/ Core™ i5-6440EQ(2.7GHz) Mini-ITX motherboard w/ DVI-D, HDMI (2.0), DisplayPort, LVDS, dual Gigabit LAN, RAID, iAMT (11.0), TPM (2.0), vPro, iSMART (3.0), CPU cooler on board
MI990EF-6100E	BGA1440 Intel® HM170/ Core™ i3-6100E(2.7GHz) Mini-ITX motherboard w/ DVI-D, HDMI (2.0), DisplayPort, LVDS, dual Gigabit LAN, RAID, EuP/ErP compliant, iSMART (3.0), CPU cooler on board

## Dimensions and Drawing

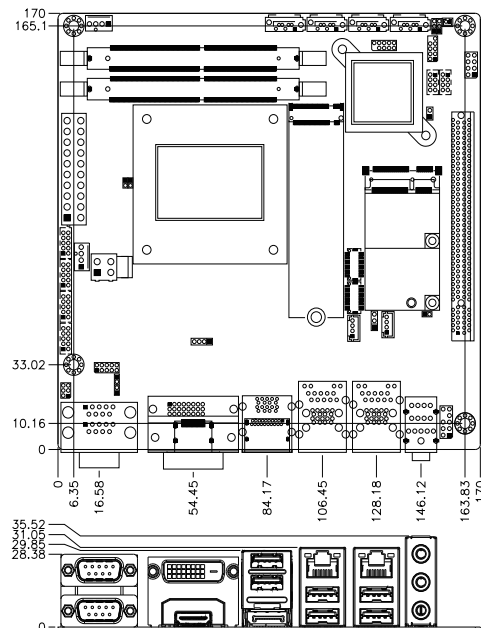

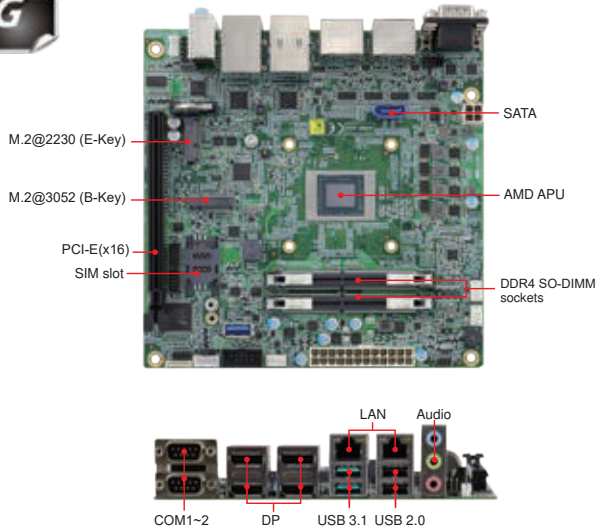

## Features

- AMD Ryzen™ Embedded V2000 Series on board
- 2x DDR4 SO-DIMM, Max. 64GB, ECC compatible
- Dual Intel® Gigabit LAN
- 4x DisplayPort 1.4
- 3x USB 3.1, 2x USB 2.0, 4x COM, 1x SATA III
- 1x PCI-E(x16), 3x M.2 (B-Key, E-Key and M-Key)
- Watchdog timer, Digital I/O, TPM (2.0)

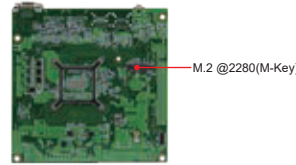

## Specifications

CPU Socket	BGA1140
CPU	AMD V2000 series APU on board
PCH	N/A
Memory	2x DDR4-3200 SO-DIMM socket, Max 64GB, ECC compatible
BIOS	AMI
Watchdog Timer	256 levels
H/W Monitor	Yes
Storage Device Interface	2x M.2 (B-Key/ M-key)
Expansion Slots	1x PCI-E (x16)
Mini Type Slots	1x M.2 (E-Key, type:2230) 1x M.2 (B-Key, type:3052) 1x M.2 (M-key, type:2280, NVMe)
Graphics Controller	AMD Radeon Graphics
Video Output	4x DisplayPort 1.4
Ethernet	2x Intel® I211AT or I210AT Gigabit LAN
I/O Chipset	F81966D-I
Serial Port	4x COM Port
USB 2.0	2x USB 2.0
USB 3.X	3x USB 3.1 (10Gbps)
Serial ATA	1x SATA3.0
Audio	built-in HD audio + Realtek ALC888S codec
TPM	2.0
Others	Digital I/O, SIM socket
Dimensions (L x W)	170mm x 170mm (6.7" x 6.7")
Power Consumption	TBD
Operating Temperature	0°C ~ 60°C (32°F ~ 140°F)
Storage Temperature	-20°C ~ 80°C (-4°F ~ 176°F)
Relative Humidity	95% (non-condensing @60°C)

## Ordering Information

MI989F-2718	AMD Ryzen™ V2718 APU (1.7GHz~4.15GHz) on board Mini-ITX motherboard, with 4x DisplayPort, dual Gigabit LAN, TPM (2.0), EuP/ErP, CPU cooler on board
MI989F-2748	AMD Ryzen™ V2748 APU (2.9GHz~4.15GHz) on board Mini-ITX motherboard, with 4x DisplayPort, dual Gigabit LAN, TPM(2.0), EuP/ErP, CPU cooler on board

## Dimensions and Drawing

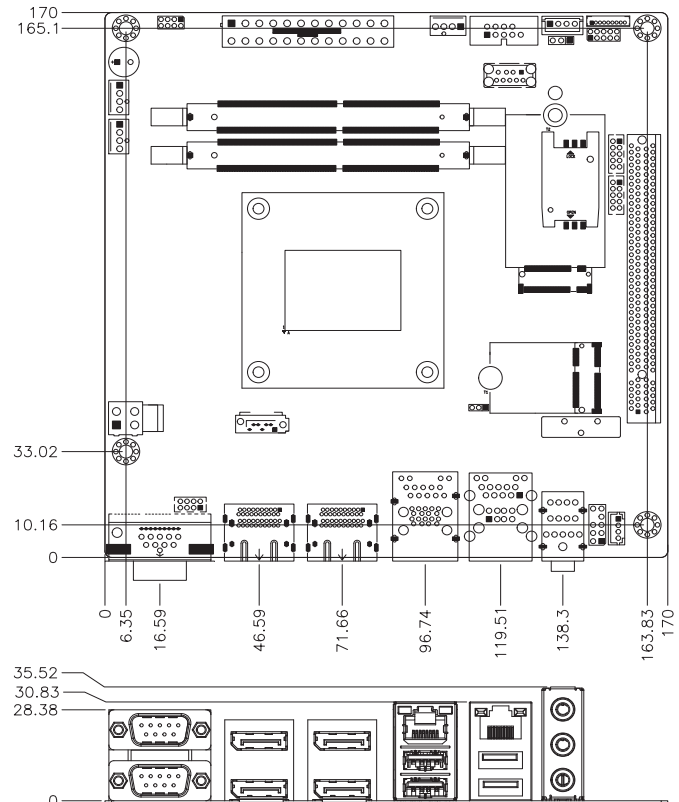

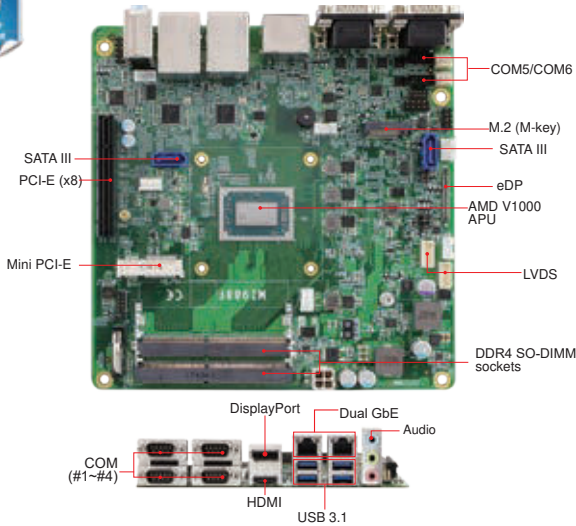

## Features

- AMD Ryzen™ Embedded V1000 Series on board
- 2x DDR4 SO-DIMM, Max. 32GB
- 2x Gigabit LAN
- 1x HDMI(2.0a), 1x DisplayPort (1.2), 1x eDP or 1x 24-bit dual-channel LVDS
- 4x USB 3.1, 2x SATA III, 6x COM
- 1x PCI-E (x8), 1x Mini PCI-E socket, 1x M.2 (M-key)

## Specifications

CPU Socket	BGA 1140 APU on board
CPU	AMD Ryzen™ Embedded V1000 Series on board
PCH	N/A
Memory	DDR4 SO-DIMM, supports ECC 2x DDR4-2666, Max. 32GB
BIOS	AMI
Watchdog Timer	256 levels
H/W Monitor	Yes
Storage Device Interface	1x M.2 (supports NVMe)
Expansion Slots	1x PCI-E (x8), 1x M.2 (M-key, type: 2280)
Mini Type Slots	1x Mini PCI-E
Graphics Controller	AMD Radeon™ Vega GPU integrated
Video Output	1x HDMI (2.0a), 1x DisplayPort (1.2) 1x eDP or 1x 24-bit dual-channel LVDS
Ethernet	2x Intel® I211AT or I210AT Gigabit LAN
I/O Chipset	Nuvoton NCT6116D
Serial Port	2x RS232/422/485 (jumper-less selection) 4x RS232
USB 2.0	N/A
USB 3.X	4x USB 3.1 on board
Serial ATA	2x SATA III
Audio	built-in HD audio + Realtek ALC888S codec
TPM	N/A
Others	Digital I/O (4-in/4-out), iSMART, +12V~+24V DC-in
Dimensions (L x W)	170mm x 170mm (6.7" x 6.7")
Power Consumption	AMD Ryzen™ Embedded V1807B 3.35GHz w/ 2x 8GB DDR4-2133 +24V: 2.55A
Operating Temperature	0°C~60°C (32°F~140°F)
Storage Temperature	-20°C~80°C (-4°F~176°F)
Relative Humidity	90% (non-condensing @60°C)

## Ordering Information

MI988FS-1807	AMD Ryzen™ V1807B QC APU (3.35GHz/3.8GHz) on board Mini-ITX motherboard, with HDMI (2.0), DP, eDP or LVDS, dual Gigabit LAN, iSMART, +12V~+24V DC-in
MI988FS-1756	AMD Ryzen™ V1756B QC APU (3.25GHz/3.6GHz) on board Mini-ITX motherboard, with HDMI (2.0), DP, eDP or LVDS, dual Gigabit LAN, iSMART, +12V~+24V DC-in
MI988FS-1605	AMD Ryzen™ V1605B QC APU (2.0GHz~3.6GHz) on board Mini-ITX, with HDMI(2.0), DP, eDP or LVDS, dual Gigabit LAN, iSMART, +12V~+24V DC-in
MI988FS-1202	AMD Ryzen™ V1202B DC APU (2.3GHz/3.3GHz) on board Mini-ITX motherboard, with HDMI (2.0), DP, eDP or LVDS, dual Gigabit LAN, iSMART, +12V~+24V DC-in

## Dimensions and Drawing

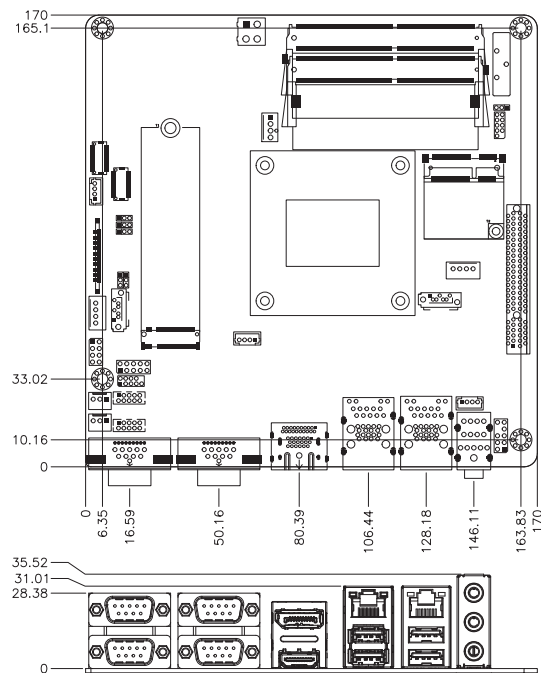



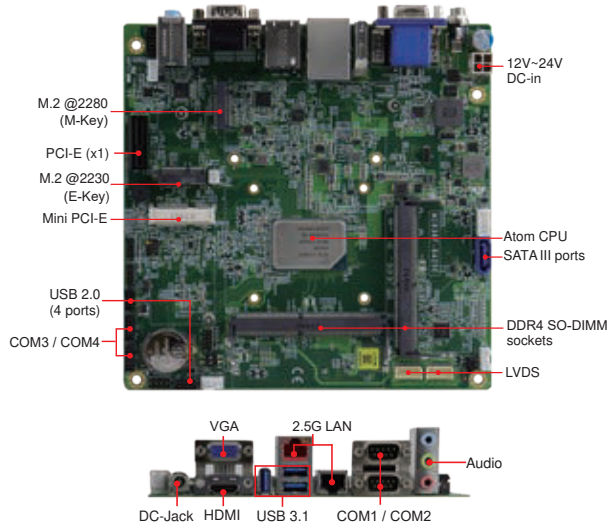

## Features

- Onboard Intel® Atom® x6000 series processors
- 2x DDR4-3200 SO-DIMM sockets, Max. 32GB, supports IBEC
- Intel® Atom® processor integrated graphics HDMI (2.0b), VGA and LVDS or eDP
- Dual Intel® 2.5G LAN (I226IT)
- 3x USB 3.1, 4x USB 2.0, 4x COM, 1x SATA III
- 1x PCI-E (x1) [Gen. 3.0], 1x mPCIe, 2x M.2 sockets (M-key & E-key)
- Watchdog timer, Digital I/O, fTPM
- Wide-range operating temperature from -40°C to +70°C



## Specifications

CPU	Intel® Atom® QC x6425E (2.0GHz / 3.0 GHz) Intel® Atom® QC x6413E (1.5GHz / 3.0 GHz) Intel® Atom® DC x6211E (1.3GHz / 3.0 GHz)
PCH	Integrated in Intel® Atom® SoC
Memory	2x DDR4 SO-DIMM sockets, Supports DDR4-3200 memory module, Max. 32GB
BIOS	AMI
Watchdog Timer	256 levels
Storage Device Interface	1x SATA III (shared with M.2)
H/W Monitor	Yes
Mini Type Slots	1x M.2 (M-key, type:2280, SATA III) 1x M.2 (E-Key, type:2230, USB 2.0 + PCI-E) 1x MiniPCI-E (full-size, USB 2.0 + PCI-E)
Expansion Slots	1x PCI-E (x1) [Gen.3.0]
Graphics Controller	Intel® Atom® SoC integrated
Video Output	1x HDMI (2.0b) + 1x VGA + LVDS or eDP
Ethernet	LAN 1: Intel® I226IT LAN 2: Intel® I226IT
I/O Chipset	Fintek F81964D-I
Serial Port	4 COM ports: 2x RS232/422/485 + 2x RS232
USB 2.0	4x USB 2.0 via pin-headers
USB 3.X	3x USB 3.1 (5bps) @ edge connector
Serial ATA	1x SATA III
Audio	Built-in HD Audio controller + Realtek ALC888S with class-D amplifier
TPM	Supports fTPM
Others	Digital I/O (4-in/4-out), Watchdog timer, +12V ~+24V DC-in, with fanless heatsink
Dimensions (L x W)	170mm x 170mm (6.7" x 6.7")
Power Consumption	TBD
Operating Temperature	-40°C ~ +70°C (-40°F ~ 158°F)
Storage Temperature	-40°C ~ +80°C (-40°F ~ 176°F)
Relative Humidity	90% (non-condensing @60°C)

## Ordering Information

MI836F-6425E	Intel Atom® x6425E (2.0GHz~3.0GHz) + fanless heatsink onboard MiniITX, w/ Intel I226IT LAN x2, HDMI, VGA, LVDS, 12~24V DC-in, wide temperature support
MI836FE-6425E	Intel Atom® x6425E (2.0GHz~3.0GHz) + fanless heatsink onboard MiniITX, w/ Intel I226IT LAN x2, HDMI, VGA, eDP, 12~24V DC-in, wide temperature support
MI836F-6413E	Intel Atom® x6413E (1.5GHz~3.0GHz) + fanless heatsink onboard MiniITX, w/ Intel I226IT LAN x2, HDMI, VGA, LVDS, 12~24V DC-in, wide temperature support
MI836FE-6211E	Intel Atom® x6211E (1.3GHz~3.0GHz) + fanless heatsink onboard MiniITX, w/ Intel I226IT LAN x2, HDMI, VGA, eDP, 12~24V DC-in, wide temperature support

## Dimensions and Drawing

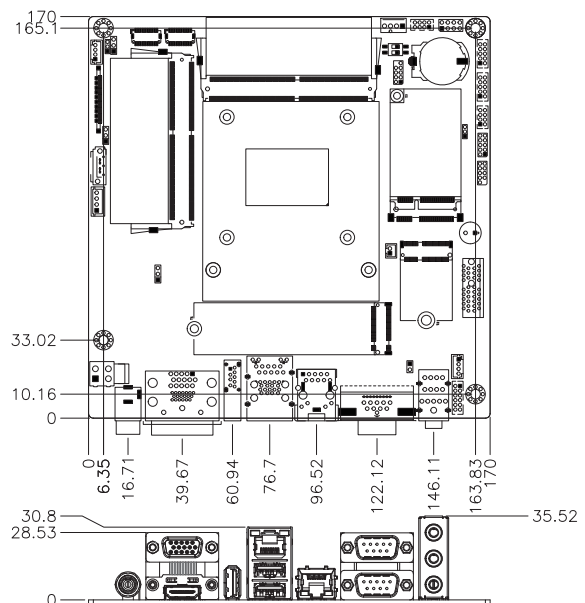



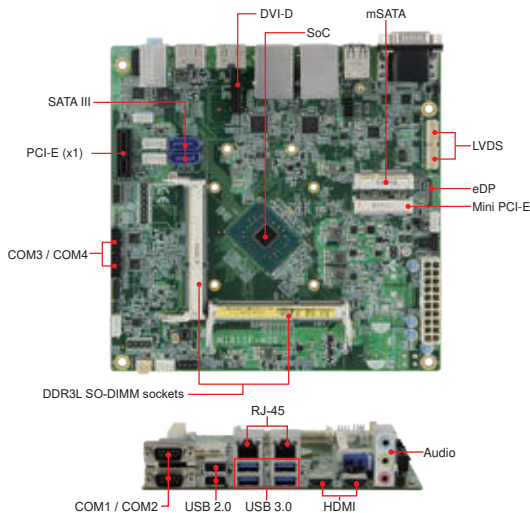

## Features

- Onboard Intel® Pentium® QC N4200 2.5GHz or Celeron® DC N3350 2.4GHz on board
- 2x DDR3L SO-DIMM sockets, Max. 8GB
- Supports HDMI, HDMI / DVI-D and eDP / 24-bit dual channel LVDS
- Dual Intel® Gigabit LAN
- Watchdog timer, Digital I/O
- 4x USB 3.0, 4x USB 2.0, 4x COM, 2x SATA III
- 1x PCI-E (x1), 1x Mini PCI-E, 1x mSATA



## Specifications

CPU Socket	FCBGA1296
CPU	Intel® Pentium® QC N4200 @ 1.1GHz ~ 2.5GHz Intel® Celeron® DC N3350 @ 1.1GHz ~ 2.4GHz
PCH	N/A
Memory	2x DDR3L-1866 SO-DIMM socket, Max. 8GB
BIOS	AMI
Watchdog Timer	256 levels
Storage Device Interface	1x mSATA
H/W Monitor	Yes
Mini Type Slots	1x Mini PCI-E
Expansion Slots	1x PCI-E (x1)
Graphics Controller	Intel® Pentium® SoC integrated Intel® Gen-9 graphics
Video Output	Supports HDMI, 2nd HDMI or DVI-D, eDP or 24-bit dual-channel LVDS
Ethernet	Intel® I211AT or I210AT Gigabit LAN
I/O Chipset	Fintek F81846AD-I
Serial Port	1x RS232/422/485 (jumper-less selection), 3x RS232
USB 2.0	2x USB 2.0 ports on board 2x USB via pin header
USB 3.X	4x USB 3.0 on board
Serial ATA	2x SATA III
Audio	Intel® Pentium® SoC built-in HD audio controller + Realtek ALC283 codec
TPM	N/A
Others	Digital I/O (4-in/4-out); ATX or 12V~24V DC-in; EuP/ErP
Dimensions (L x W)	170mm x 170mm (6.7" x 6.7")
Power Consumption	Intel® Pentium® N4200 2.5GHz w/ 2x DDR3L 1600 4GB +12V: 1.27A
Operating Temperature	0°C~60°C ( 32°F~140°F)
Storage Temperature	-20°C~80°C (-4°F~176°F)
Relative Humidity	90% (non-condensing @60°C)

## Ordering Information

MI811F-420	Intel® Pentium® N4200(1.1~2.5GHz) on board Mini-ITX motherboard with heatsink, w/ HDMI#1, HDMI#2 or DVI-D, eDP or LVDS, 2x Gigabit LAN, ATX-in
MI811F-420D	Intel® Pentium® N4200(1.1~2.5GHz) on board Mini-ITX motherboard with heatsink, w/ HDMI#1, HDMI#2 or DVI-D, eDP or LVDS, 2x Gigabit LAN, <b>12V~24V DC-in</b>
MI811F-335	Intel® Celeron® N3350(1.1~2.4GHz) on board Mini-ITX motherboard with heatsink, w/ HDMI#1, HDMI#2 or DVI-D, eDP or LVDS, 2x Gigabit LAN, ATX-in
MI811F-335D	Intel® Celeron® N3350(1.1~2.4GHz) on board Mini-ITX motherboard with heatsink, w/ HDMI#1, HDMI#2 or DVI-D, eDP or LVDS, 2x Gigabit LAN, <b>12V~24V DC-in</b>

## Dimensions and Drawing

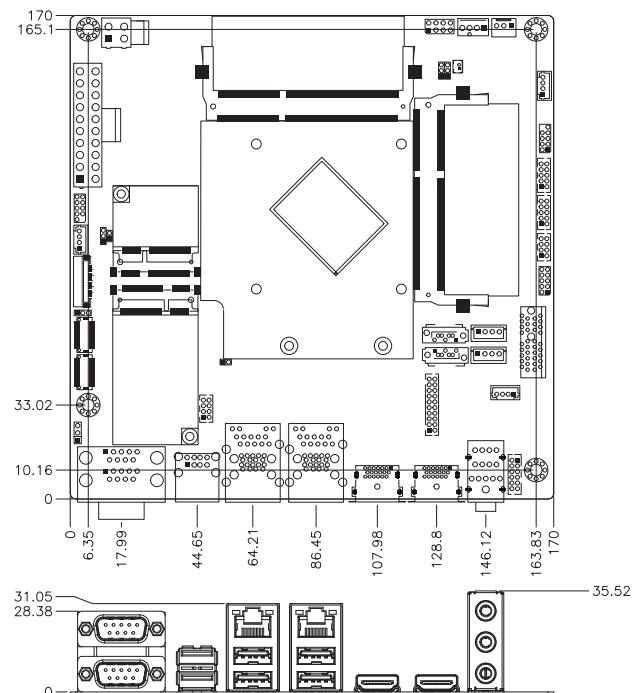

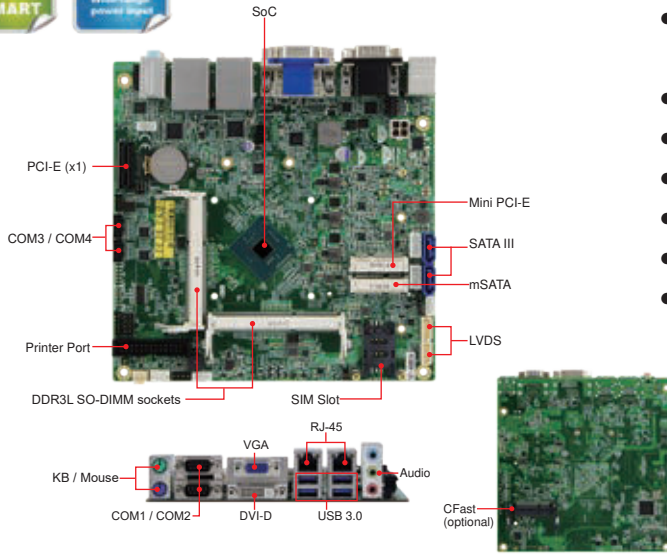

### Features

- Onboard Intel® Pentium® QC N3710, up to 2.56GHz or Celeron® DC N3010, up to 2.24GHz
- 2x DDR3L SO-DIMM sockets, Max. 8GB
- Supports VGA, DVI-D and 24-bit dual-channel LVDS
- Dual Intel® Gigabit LAN
- Watchdog timer, Digital I/O, iSMART, TPM (2.0)
- 4x USB 3.0, 2x USB 2.0, 4x COM, 2x SATA III
- 1x PCI-E (x1), 1x Mini PCI-E, 1x mSATA, 1x CFast

### Specifications

CPU Socket	FCBGA1170
CPU	Intel® Pentium® N3710, up to 2.4GHz or Celeron® N3010, up to 2.24GHz
PCH	N/A
Memory	2x DDR3L-1600 SO-DIMM socket, Max. 8GB
BIOS	AMI
Watchdog Timer	256 levels
Storage Device Interface	1x mSATA, 1x CFast (optional)
H/W Monitor	Yes
Expansion Slots	1x PCI-E (x1)
Mini Type Slots	1x Mini PCI-E
Graphics Controller	Intel® Pentium® SoC integrated Intel® Gen-8 graphics
Video Output	Supports DVI-D, CRT 24-bit dual-channel LVDS
Ethernet	Intel® I211AT or I210AT Gigabit LAN
I/O Chipset	Fintek F81846AD-I
Serial Port	1x RS232/422/485 (jumper-less selection) 3x RS232, PS/2 keyboard/mouse 1x printer port
USB 2.0	2x USB 2.0 via pin-header
USB 3.X	4x USB 3.0 on board
Serial ATA	2x SATA III
Audio	Intel® Pentium SoC built-in HD audio + Realtek ALC269 codec
TPM	TPM(2.0)
Others	Digital I/O (4-in/4-out); 12V DC-in or 18V~24V; iSMART; TPM(2.0); SIM card slot, CFast (optional)
Dimensions (L x W)	170mm x 170mm (6.7" x 6.7")
Power Consumption	Intel® Pentium® Processor N3710 1.6GHz w/ 2x 4GB DDR3L-1600 +19V: 1.01A
Operating Temperature	0°C~60°C ( 32°F~140°F)
Storage Temperature	-20°C~80°C (-4°F~176°F)
Relative Humidity	90% (non-condensing @60°C)

### Ordering Information

MI808F-371	Intel® Pentium® N3710 (2.56GHz) on board Mini-ITX motherboard with heatsink, DVI-D, VGA & LVDS, 2x Gigabit LAN, iSMART 3.2, TPM(2.0), DC-in 12V only
MI808FW-371	Intel® Pentium® N3710 (2.56GHz) on board Mini-ITX motherboard with heatsink, DVI-D, VGA & LVDS, 2x Gigabit LAN, iSMART 3.2, TPM(2.0), <b>18V~24V DC-in</b>
MI808F-301 (w/ MOQ)	Intel® Celeron® N3010 (2.24GHz) on board Mini-ITX motherboard with heatsink, DVI-D, VGA & LVDS, 2x Gigabit LAN, iSMART 3.2, TPM(2.0), DC-in 12V only
MI808FW-301 (w/ MOQ)	Intel® Celeron® N3010 (2.24GHz) on board Mini-ITX motherboard with heatsink, DVI-D, VGA & LVDS, 2x Gigabit LAN, iSMART 3.2, TPM(2.0), <b>18V~24V DC-in</b>

### Dimensions and Drawing

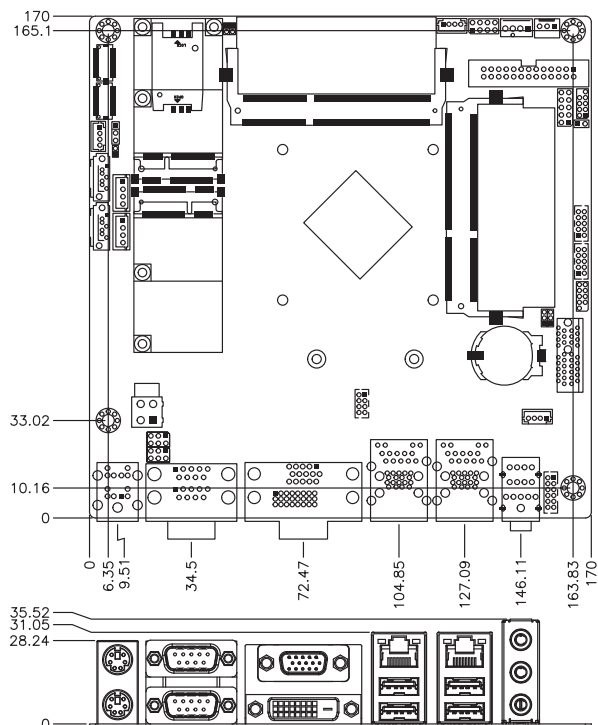

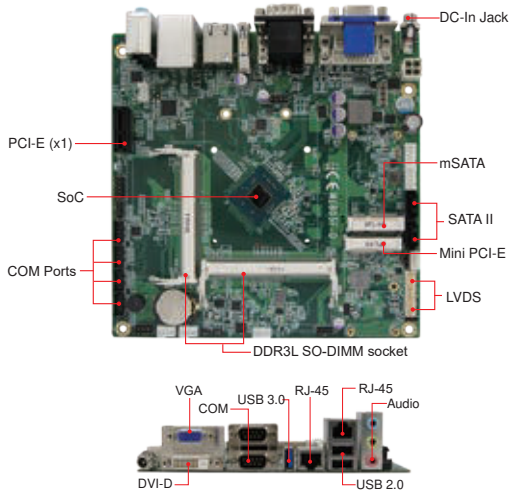

## Features

- Onboard Intel® Celeron® J1900(2.0GHz) SoC
- 2x DDR3L SO-DIMM, Max. 8GB
- Supports VGA, DVI-D and 24-bit dual-channel LVDS
- Onboard dual Gigabit LAN
- Watchdog timer, Digital I/O, iSMART
- 1x USB 3.0, 4x USB 2.0, 6x COM, 2x SATA II
- 1x PCI-E (x1), 1x Mini PCI-E, 1x mSATA



## Specifications

CPU Socket	FCBGA1170
CPU	Intel® Celeron® J1900 SoC (2.0GHz, 2MB cache)
PCH	N/A
Memory	2x DDR3L-1333 SO-DIMM, Max. 8GB (Non-ECC)
BIOS	AMI
Watchdog Timer	256 levels
H/W Monitor	Yes
Storage Device Interface	mSATA
Expansion Slots	1x PCI-E (x1)
Mini Type Slots	1x Mini PCI-E
Graphics Controller	Intel® Celeron® J1900 integrated Gen7 graphics
Video Output	Supports DVI-D, CRT 24-bit dual-channel LVDS
Ethernet	Intel® I211AT or I210AT Gigabit LAN
I/O Chipset	Nuvoton NCT6106D
Serial Port	1x RS232/422/485, 5x RS232
USB 2.0	2x USB 2.0 on board 2x USB 2.0 via pin header
USB 3.X	1x USB 3.0 on board
Serial ATA	2x SATA III
Audio	Intel® Celeron® J1900 built-in audio + Realtek ALC269 codec
TPM	N/A
Others	12V~24V DC-In, iSMART, Digital I/O (4-in/4-out)
Dimensions (L x W)	170mm x 170mm (6.7" x 6.7")
Power Consumption	Intel® Celeron® J1900 2GHz w/ 8GB DDR3L-1600 +12V: 1.28A
Operating Temperature	0°C~60°C (32°F~140°F)
Storage Temperature	-20°C~80°C (-4°F~176°F)
Relative Humidity	90% (non-condensing @60°C)

## Ordering Information

MI805F-D	Intel® Celeron® J1900 2.0GHz SoC Mini-ITX motherboard w/ DVI-D, VGA & LVDS, 2x Gigabit LAN, iSMART, with heatsink
----------	---

## Dimensions and Drawing

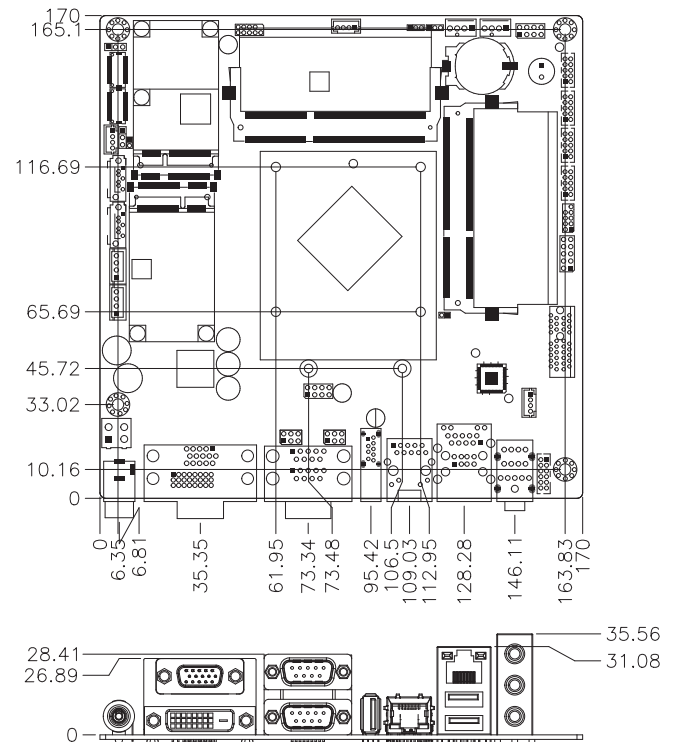

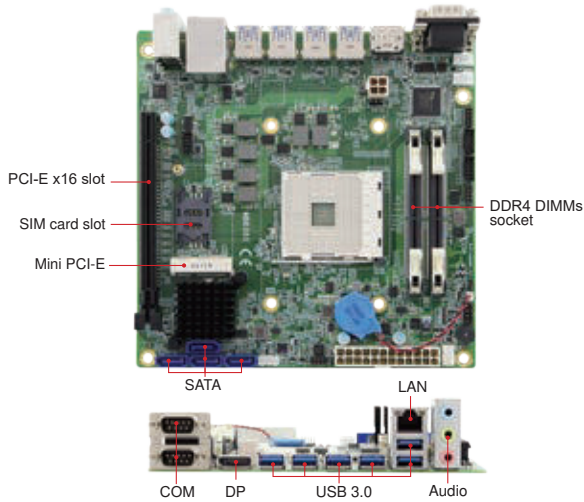

## Features

- IBASE iCONTROL intelligent energy-saving & Observer Hardware remote monitoring technologies
- AMD Ryzen™ 3000 Series Processor with Vega Graphics Processors
- 2x DDR4 2400MHz SO-DIMM, Max. 64GB
- 1x DisplayPort for 2nd Gen AMD APU
- 1x PCI-E x16 (default) or 2x PCI-E x8 (optional with riser card)
- 6x USB 3.1, 2x COM, 1x Gigabit LAN
- 1x M.2 (E-key), 1x Mini PCI-E socket (full-size), 1x SIM slot

## Specifications

CPU Socket	AMD AM4
CPU	AMD Ryzen™ Embedded 3000 Series on board
PCH	AMD X470
Memory	2x DDR4 SO-DIMM memory slots; Max. 64GB
BIOS	AMI
Watchdog Timer	256 levels
H/W Monitor	YES
Storage Device Interface	N/A
Expansion Slots	1x PCI-E (x16) slot supports single at x16 (PCI-E2) for AM4 Pure CPU series 1x PCI-E (x16) slot supports single at x8 (PCI-E2) for AM4 APU series
Mini Type Slots	1x Mini PCI-E (full-sized) 1x M.2 socket (Key-E) 1x SIM card slot
Graphics Controller	AMD Radeon™ Vega GPU integrated
Video Output	1x DisplayPort (1.2) for AM4 APU series
Ethernet	1x Realtek RTL8111H
I/O Chipset	Fintek F81439
Serial Port	COM #1 (RS232/422/485) (jumper-less selection) COM #2~COM #4 (RS232 only)
USB 2.0	N/A
USB 3.0	6x USB 3.1 Gen1
Serial ATA	3x SATA III
Audio	built-in HD audio + Realtek ALC662 codec
TPM	N/A
Others	2x 5 pin-header x1 for Digital I/O(5-in/5-out), 1x COM port header / DF-11 2x5 box header x2 for COM3/4 (RS232 only) 1x CPU Fan Connector (4-pin) 2x Chassis fan connectors (4-pin) (Smart fan Speed Control) 1x ATX standard 24-pin type & 4-pin type (+12V only) 1x USB 2.0 Headers (Support 2x USB 2.0 ports) 2-pin connector for RTC battery iSMART
Dimensions (L x W)	170mm x 170mm (6.7" x 6.7")

Power Consumption	AMD Ryzen™ Embedded AM4 CPU/APU 3.0GHz w/ 2x 8GB DDR4-2400 +12V: 2.55A
Operating Temperature	0°C~60°C (32°F~140°F)
Storage Temperature	-20°C~80°C (-4°F~176°F)
Relative Humidity	90% (non-condensing @60°C)

## Ordering Information

MBD301	AMD Ryzen™ Desktop (X470) Mini-ITX motherboard, with 6x USB 3.1, 2x COMs, 1x Gigabit LAN, iSMART, +12V DC-in
--------	--

## Dimensions and Drawing

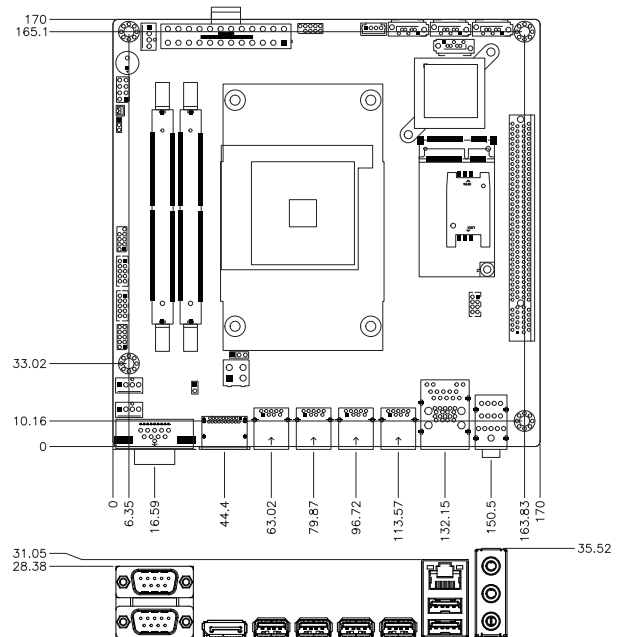



# Comparison Table

## Full-Size CPU Card

Models	IB990	IB995
<b>Form Factor</b>	Full-Size CPU Card(PICMG®1.3)	Full-Size CPU Card (PICMG®1.3)
<b>CPU Socket</b>	LGA1151	LGA1151
<b>CPU</b>	6th Gen Intel® Xeon® / Core™ i7/i5/i3 / Pentium® / Celeron® DT CPU	9th/8th Gen Intel® Xeon® E / Core™ i7/i5/i3 / Pentium® / Celeron® DT CPU
<b>CPU Max. Frequency</b>	Up to 4.0GHz	Up to 4.7GHz
<b>PCH</b>	IB990AF-C236: Intel® C236 IB990AF: Intel® Q170	IB995AF-C246: Intel® C246 IB995AF: Intel® Q370 IB995EF: Intel® H310
<b>Memory</b>	2x DDR4 DIMM	2x DDR4 DIMM
<b>Max. Memory Size</b>	32GB	32GB
<b>BIOS</b>	AMI	AMI
<b>Graphics Controller</b>	Intel® Core™ i integrated graphics	Intel UHD Graphics P630
<b>Video Output</b>	N/A DVI-D, VGA and DVI-I on board	24-bit dual-channel LVDS DVI-D and DVI-I on board
<b>Ethernet</b>	Intel® I219LM Gigabit LAN PHY Intel® I211AT or I210AT Gigabit LAN	LAN 1: Intel® I219LM Gigabit LAN PHY (IB995AF-C246/IB995AF) Intel® I219V Gigabit LAN PHY (IB995EF) LAN2: Intel® I210AT Gigabit LAN PHY (IB995AF-C246) Intel® I211AT or I210AT Gigabit LAN (IB995AF/IB995EF)
<b>Audio</b>	Built-in ALC888S HD audio codec	Built-in ALC888S HD audio codec
<b>SATA</b>	6x SATA III ports (IB990AF-C236) 4x SATA III port (IB990AF)	5x SATA III ports (IB995AF-C246) 3x SATA III ports (IB995AF) 2x SATA III ports (IB995EF)
<b>I/O Chipset</b>	F81846AD-I	F81964D-I
<b>Parallel Port</b>	1x SPP/EPP/ECP port	1x SPP/EPP/ECP port
<b>Serial Port</b>	3x RS232 1x RS232/422/485	3x RS232 1x RS232/422/485
<b>USB 2.0</b>	2x USB 2.0 via pin header Optional 4x ports through IP314 backplane	6x USB 2.0 (via pin header for IB995AF-C246/IB995AF, 1x via M.2, 1x via onboard Vertical type-A)
<b>USB 3.0/3.1</b>	3x USB 3.0 (1x rear I/O + 2x via pin header)	5x USB 3.0 (1x via rear panel, 4x via box header for IB995AF-C246/IB995AF, 2x via box header for IB995EF)
<b>KB / MS</b>	Combo PS/2	Combo PS/2
<b>Hardware Monitor</b>	Yes	Yes
<b>Storage Device Interface</b>	N/A	2x M.2
<b>Watchdog Timer</b>	256 levels	256 levels
<b>Digital I/O</b>	4-in/4-out	4-in/4-out
<b>Expansion Slots</b>	4x PCI, 4x PCI-E (x1) or 1x PCI-E (x4), 1x PCI-E (x16) from backplane	4x PCI, 4x PCI-E (x1) or 1x PCI-E (x4), 1x PCI-E (x16) from backplane
<b>Mini Type Slots</b>	1x Mini PCI-E socket on board	1x M.2 (M-Key, type:2280, supports CNVI) 1x M.2 (E-Key, type:2230, supports NVMe)
<b>TPM</b>	1.2 (IB990VF)	2.0
<b>Power Input</b>	ATX type	ATX type
<b>Power Consumption</b>	Intel® Xeon® Processor E3-1225 v5 w/ 2x DDR4-2133 4GB +12V: 5.67A; +5V: 1.88A +5VSB: 0.09A; +3.3V: 0.08A	TBD
<b>Dimensions (L x W)</b>	338mm x 126mm	338mm x 126mm
<b>Extra Features</b>	iAMT (11.0), RAID(0&1, 5), LAN Wakeup	iAMT (11.6), RAID(0&1, 5), LAN Wakeup
<b>Page No.</b>	P. 4-3	P. 4-2



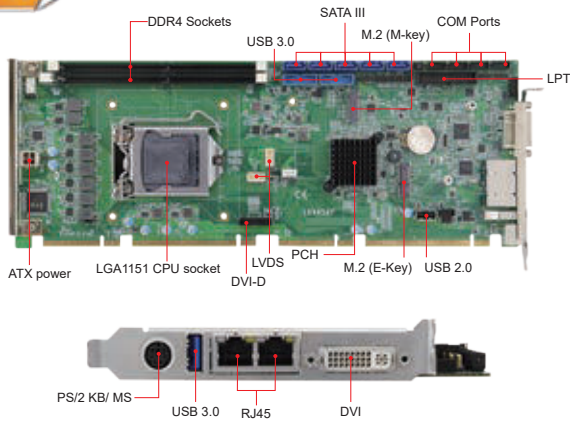

### Features

- 9th/8th Gen Intel® Xeon® E / Core™ i7/i5/i3 Pentium® QC/DC Processor, up to 4.7GHz
- 2x DDR4 DIMM, Max. 32GB
- 2x Gigabit LAN
- Intel® processor integrated graphics, supports DVI-I/ DVI-D/ LVDS
- 3x USB 2.0, 5x USB 3.0, 5x SATA III, 4x COM
- 2x M.2 socket (M/E-Key)

### Specifications

CPU Socket	LGA1151
CPU	9th/8th Gen Intel® Xeon® E / Core™ i7/i5/i3 DT processors
PCH	IB995AF-C246: Intel® C246 PCH IB995AF: Intel® Q370 PCH IB995EF: Intel® H310 PCH
Memorys	2x DDR4-2166/2400MHz DIMM, Max. 32GB (ECC compatible)
BIOS	AMI
Watchdog Timer	256 levels
H/W Monitor	Yes
Storage Device Interface	1x M.2 (supports NVMe)
Expansion Slots	4x PCI, 4x PCI-E (x1) or 1x PCI-E (x4) 1x PCI-E (x16) from backplane
Mini Type Slots	1x M.2 (M-Key, type:2280, supports NVMe) 1x M.2 (E-Key, type:2230, supports CNVI)
Graphics Controller	Intel® UHD Graphics P630
Video Output	Supports DVI-D, DVI-I, 24-bit dual channel LVDS
Ethernet	IB995AF-C246& IB995AF: Intel® I219LM Gigabit LAN PHY IB995EF: Intel® I219V Gigabit LAN PHY Intel® I211AT or I210AT Gigabit LAN (as 2nd LAN) IB995AF-C246: Intel® I210AT Gigabit LAN (as 2nd LAN)
I/O Chipset	Fintek F81964D-I
Serial Port	1x RS232/422/485 (jumperless selection) 3x RS232
USB 2.0	2x USB 2.0 on board 1x USB 2.0 via on board USB vertical connector 1x USB 2.0 via M.2 (E-Key)
USB 3.X	5x USB 3.0 on board for IB995AF series 3x USB 3.0 on board for IB995EF
Serial ATA	5x SATA III for IB995AF-C246 3x SATA III for IB995AF 2x SATA III for IB995EF
Audio	Intel® PCH built-in HD audio controller + Realtek ALC888S codec
TPM	TPM (2.0)
Others	Digital I/O (4-in/ 4-out), RAID, iAMT (11.6)
Dimensions (L x W)	338mm x 126mm (13.3" x 4.96")

Power Consumption	Intel® Xeon processor i7-9700K w/ 2x DDR4 2133 16GB +12V: 8.21A +5VSB: 0.26A +5V: 1.16A +3.3V: 0.6A
Operating Temperature	0°C ~ 60°C(32°F ~ 140°F)
Storage Temperature	-20°C ~ 80°C(-4°F ~ 140°F)
Relative Humidity	90%(non-condensing @60°C)

### Ordering Information

IB995AFS-C246	LGA1151 C246 PICMG1.3 Full-Size CPU Card w/ DVI-I, DVI-D, LVDS, Dual Gigabit LAN, iAMT (11.6), 5x SATA III
IB995AFS	LGA1151 Q370 PICMG1.3 Full-Size CPU Card w/ DVI-I, DVI-D, LVDS, Dual Gigabit LAN, iAMT (11.6), 3x SATA III
IB995EFS	LGA1151 H310 PICMG1.3 Full-Size CPU Card w/ DVI-I, DVI-D, LVDS, Dual Gigabit LAN, 2x SATA III

\*[S] means with Realtek ALC888S codec

### Dimensions and Drawing

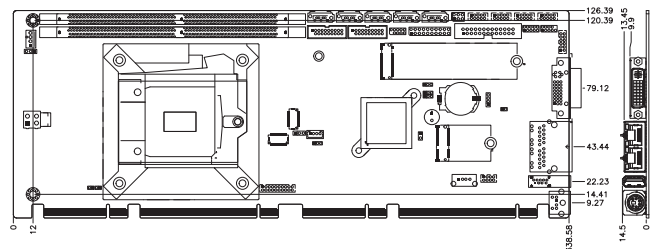

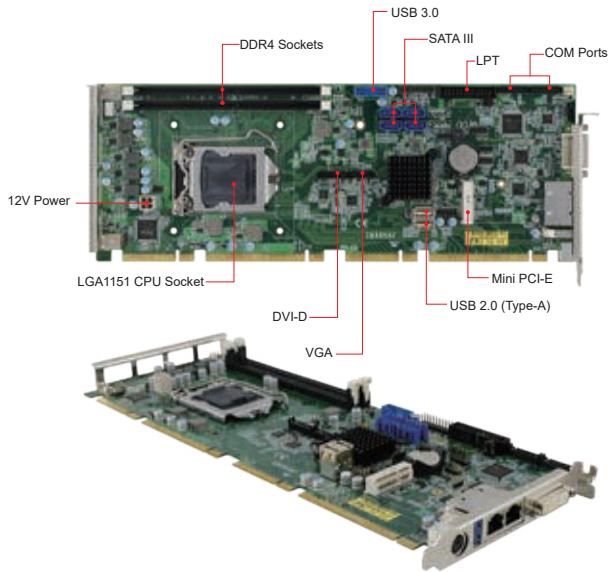

### Features

- 7th/6th Gen Intel® Xeon® E3 /Core™ i7/i5/i3 / Pentium® QC/DC Processor, up to 4.0 GHz
- 2x DDR4- 2133 DIMM, Max. 32GB, ECC compatible
- Intel® processor integrated graphics, supports DVI-I, CRT, DVI-D
- 2x Intel® Gigabit LAN
- 3x USB 3.0, 2x USB 2.0, 4x COM, 6x SATA III
- 1x Mini PCI-E slot
- Watchdog timer, Digital I/O, iAMT (11.0)

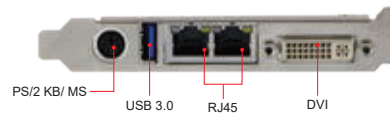

### Specifications

CPU Socket	LGA1151
CPU	7th/6th Gen Intel® DT Xeon® E3 & Core™ i7/i5/i3 / Pentium®/ Celeron® QC/DC processors
PCH	IB990AF-C236: Intel® C236 PCH IB990AF: Intel® Q170 PCH
Memorys	2x DDR4-2133 DIMM, Max 32GB (ECC compatible)
BIOS	AMI
Watchdog Timer	256 levels
H/W Monitor	Yes
Storage Device Interface	N/A
Expansion Slots	4x PCI, 4x PCI-E (x1) or 1x PCI-E (x4) 1x PCI-E (x16) from backplane
Mini Type Slots	1x Mini PCI-E
Graphics Controller	7th/6th Gen Intel® Core™ DT Xeon® E3 & Core™ i7/i5/i3/ Pentium®/ Celeron® integrated graphics
Video Output	Supports DVI-I, VGA, DVI-D
Ethernet	Intel® I219LM Gigabit LAN PHY Intel® I211AT or I210AT Gigabit LAN( as 2nd LAN)
I/O Chipset	Fintek F81846AD-I 1x RS232/422/485 (jumperless selection) 3x RS232, 1x LPT
USB 2.0	2x USB 2.0 (Type-A) 1x USB 2.0 via Mini PCI-E
USB 3.X	3x USB 3.0 on board
Serial ATA	6x SATA III
Audio	Intel® C236 PCH built-in HD audio controller + Realtek ALC888S codec
TPM	TPM (1.2) (IB990VF)
Others	Digital I/O(4-in/4-out), RAID, iAMT (11.0), TPM (1.2) (IB990AF only)
Dimensions (L x W)	338mm x 126mm (13.31" x 4.96")
Max. Power Requirement	Intel® Xeon® processor E3-1225 v5 w/ 2x DDR4-2133 4GB +12V: 5.67A; +5V: 1.88A; +5VSB: 0.09A; +3.3V: 0.08A
Operating Temperature	0°C ~ 60°C (32°F ~ 140°F)
Storage Temperature	-20°C ~ 80°C (-4°F ~ 140°F)
Relative Humidity	90%(non-condensing @60°C)

### Ordering Information

IB990AFS-C236	LGA1151 C236 PICMG 1.3 Full-Size CPU Card w/ DVI-I, VGA, DVI-D, dual Gigabit LAN, iAMT (11.0), 6x SATA III
IB990AFS	LGA1151 Q170 PICMG 1.3 Full-Size CPU Card w/ DVI-I, VGA, DVI-D, dual Gigabit LAN, iAMT (11.0), 4x SATA III

\*(S) means with Realtek ALC888S codec

### Dimensions and Drawing

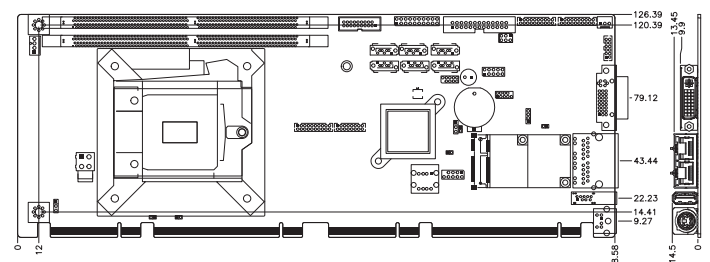

# Backplane

## IP315

### PICMG 1.3 12-Slot Backplane

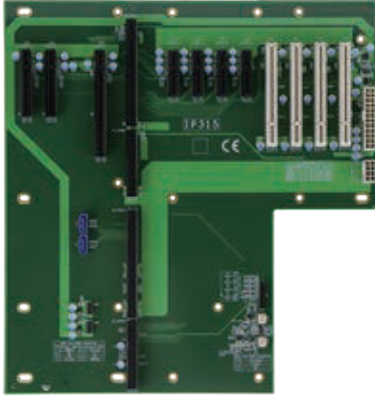

#### Features

- 4-layer PCB
- AT / ATX power connector, ATX power outlet
- 4x CPI, 1x PCI-E(x16), 2x PCI-E(x8), 4x PCI-E(x4)
- Size: 310mm x 327 mm (12.2" x 12.9")

#### Ordering Information

IP315	PICMG 1.3 12-slot Backplane W/ 1x PCI-E(16x), 2x (PCI-Ex8), 4x PCI-E(x4), 4x PCI slot
-------	---

## IP380L

### PICMG 1.3 8-Slot Backplane

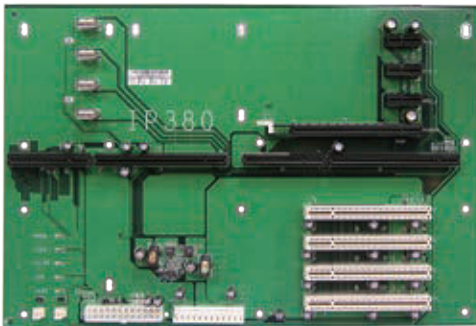

#### Features

- 4-layer PCB
- AT / ATX power connector
- 1x PCI-E 16-lane slot, 3x PCI-E 1-lane slots
- PICMG 1.3 connector(A: PCI-E x16, B: PCI-E x8, C: PCI-E x16, D: PCI-E x8), 4x PCI(32-bit) slots
- Size: 221mm x 328mm (8.7" x 12.9")

#### Ordering Information

IP380L	PICMG 1.3 8-slot Backplane with 1x PCI-E 16-lane and 3x PCI-E 1-lane, 4x PCI
--------	--

## IP470

### PICMG 1.0 14-Slot Backplane

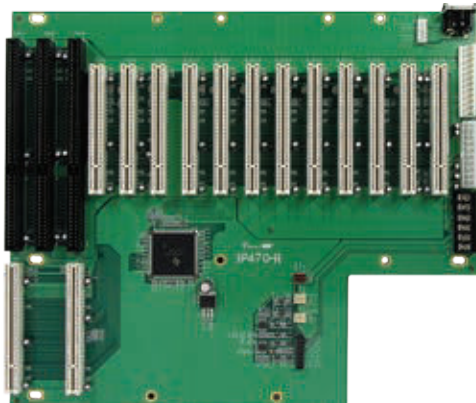

#### Features

- 4-layer PCB
- AT / ATX power connector, DC power outlet terminal
- 12x PCI, 2x ISA
- LED power indicators for +5V, -5V, +12V, -12V, 3.3V, +5VSB
- Size: 264.2mm x 311.2mm (10.4"x 12.3")

#### Ordering Information

IP470	PICMG 1.0 14-Slot Backplane w/ 12 PCI, 2 ISA lane slots
-------	---

- 1  
CPU Modules
- 2  
Single Board Computers
- 3  
Motherboards
- 4  
CPU Cards



**IBD182**

**Features:**

- PCI-E to 2x RS232
- XR17V352 chipset
- 50.95mm x 30mm



**IBD183**

**Features:**

- USB to UART,  
1x RS232+ 1x RS422/485
- XR21V1412 chipset
- 50.95mm x 30mm



**IBD184**

**Features:**

- PCI-E to 4x RS232
- XR17V354 chipset
- 50.95mm x 30mm



**IBD185**

**Features:**

- USB to GPIO
- 16-in /16-out
- STM32F103V8 chipset
- 50.95mm x 30mm



**IBD186**

**Features:**

- PCI-E to 2x RS232  
w/ isolation
- XR17V352 &  
2x LTM2882CY-3  
chipset
- 50.95mm x 30mm



**IBD188**

**Features:**

- PCI-E to 8x RS232
- XR17V358 chipset
- 50.95mm x 30mm



**IBD190**

**Features:**

- PCI-E to 1x GbE LAN
- 1x Intel® I211-AT chipset
- 50.95mm x 30mm



**IBD192**

**Features:**

- PCI-E to 2x GbE LAN
- 2x Intel® I211-AT or  
2x Intel® I210-AT chipset
- 50.95mm x 30mm



**IBD193**

**Features:**

- PCI-E to MRAM storage
- 1x MR2A16ACYS35 chipset
- 50.95mm x 30mm



**IBD194**

**Features:**

- USB to 2nd VGA Display
- Resolution up to 1920x  
1080 (Max.)
- DisplayLink DL-165  
chipset
- 50.95 mm x 30 mm



**IBD195**

**Features:**

- PCI-E to 2x CAN Bus
- Dual channel isolation
- 50.95mm x 30mm



**IBD196**

**Features:**

- Mini-PCI-E to M.2 E key
- 54.5mm x 30mm



# Embedded Function Cards

## Daughter Boards and Function Cards



### ID107

#### Features

- 55mm x 47mm
- Amplifier board
- TPA3110D2 on board



### ID600

#### Features

- 90 mm x 60mm
- +19V ~ +24V DC to DC converter
- 300W ATX power board

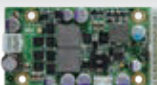

### ID452

#### Features

- 90 mm x 60mm
- +12V ~ +24V DC to DC converter
- 120W ATX power board



### ID450-R

#### Features

- 90 mm x 60mm
- +12V only DC to DC converter
- 120W ATX power board



### IB-CFAST

#### Features

- 72.4mm x 57.5mm
- SATA + power connector (Cfast socket)

## Riser Cards

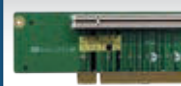

### IP115

#### Features

- 139.7mm x 51.38mm
- 1x PCI interface to PCI



### IP116-R

#### Features

- 139.7mm x 55.34mm
- 1x PCI-E (x16) interface to PCI-E (x16) slot



### IP118

#### Features

- 119.63mm x 64.5mm
- 1x PCI-E (x16) interface to PCI-E (x16) slot



### IP119

#### Features

- 123.96mm x 55.50mm
- 1x PCI-E (x16) interface to PCI-E (x16) slot



### IP155

#### Features

- 139.7mm x 75.74mm
- ASM1083 chipset
- 1x PCI interface to 2x PCI slot

1

CPU Modules

2

Single Board Computers

3

Motherboards

4

CPU Cards

# Embedded Function Cards

## Riser Cards

1

CPU Modules



### IP245

#### Features

- 130mm x 60mm
- IT8893E chipset
- PCI-E (x1) interface to 2x PCI slot



### IP246

#### Features

- 30mm x 60mm
- IT8893E & PEX8603 chipset
- 1x PCI-E (x1) to PCI + 1x PCI-E (x1) slot

2

Single Board Computers



### IP271

#### Features

- 129.97mm x 51.25mm
- 1x PCI interface to PCI slot



### IP340

#### Features

- 110mm x 62.5mm
- PCI interface to 2x PCI slot

3

Motherboards



### IP403

#### Features

- 144.6 mm x 68.3mm
- PCI-E (x16) interface to 2x Mini PCI-E



### IP404

#### Features

- 139.7mm x 75.74mm
- PCI-E (x16) interface to 2x PCI-E (x8)

4

CPU Cards



### IP405

#### Features

- 139.25mm x 62.78mm
- PCI-E (x16) interface to 2x PCI-E (x8)



### IP406

#### Features

- 123mm x 50.77mm
- 1x PCI-E (x1) interface to Mini PCI-E + 1x SIM card slot

# Product Index

E	
ET839	1-16
ET860	1-14
ET870	1-13
ET875	1-12
ET876	1-11
ET880	1-10
ET970	1-9
ET975	1-8
ET976	1-7
ET977	1-6
ET980	1-5
ET981	1-4
I	
IB811 (i-Temp)	2-24
IB818 (i-Temp)	2-23
IB822	2-22
IB836 (i-Temp)	2-21
IB837	2-20
IB838	2-19
IB897 (i-Temp)	2-18
IB898 (i-Temp)	2-17
IB899	2-16
IB915	2-15
IB916	2-14
IB917	2-13
IB918	2-12
IB919	2-11
IB952	2-10
IB953	2-9
IB956	2-8
IB961 (i-Temp)	2-7
IB990	4-3
IB995	4-2

IBQ800	1-15
IP409	1-27
IP411	1-26
IP412	1-25
IP413	1-24
IP414	1-23
IP416	1-22
IP417	1-21
IP418	1-20
IP419	1-19
M	
MB990	3-7
MB991	3-9
MB995	3-6
MB997	3-5
MB998	3-8
MBB-1000	3-4
MBD301	3-29
MI805	3-28
MI808	3-27
MI811	3-26
MI836 (i-Temp)	3-25
MI988	3-24
MI989	3-23
MI990	3-22
MI991	3-21
MI992	3-20
MI993	3-19
MI995	3-18
MI996	3-17
MI997	3-16
MI998	3-15
MI999	3-14

