



# ARCHMI-9XX Series

12.1", 15", 15.6", 17", 18.5", 19", and 21.5" Intel 4<sup>th</sup> Gen. Core i3/i5,  
Fanless Industrial Compact Size Panel PC

## User Manual

**Release Date**

**Revision**

Oct.2018

V1.6

©2018 Aplex Technology, Inc.

All Rights Reserved.

Published in Taiwan

Aplex Technology, Inc.

15F-1, No.186, Jian Yi Road, Zhonghe District, New Taipei City 235, Taiwan

Tel: 886-2-82262881 Fax: 886-2-82262883 URL: [www.aplextec.com](http://www.aplextec.com)

# Revision History

Reversion	Date	Description
0.1	2015/04/22	For Preliminary Release
0.2	2015/05/27	Modify Motherboard Description
1.0	2015/07/21	Official Version, add 12.1" and Mount Description
1.1	2016/02/02	Modify CPU Spec. to i3/i5, 15" and 17" LCD Spec., AMT driver to MEI driver, Dimension, and OS Support Spec.; Add Power Consumption and Net Weight Specification, and add UPS battery for option
1.2	2016/02/26	Modify OS Support Spec.
1.3	2016/03/30	Modify the pin number of S_232/S_422 at page 32
1.4	2016/10/04	Add 19" HMI, Modify 15.6" back cover image
1.5	2017/05/23	Remove SD card slot
1.6	2018/10/09	IP Rating change from 65 to 66

# Warning!

---

This equipment generates, uses and can radiate radio frequency energy and if not installed and used in accordance with the instructions manual, it may cause interference to radio communications. It has been tested and found to comply with the limits for a Class A computing device pursuant to FCC Rules, which are designed to provide reasonable protection against such interference when operated in a commercial environment. Operation of this equipment in a residential area is likely to cause interference in which case the user at his own expense will be required to take whatever measures may be required to correct the interference.

Electric Shock Hazard – Do not operate the machine with its back cover removed. There are dangerous high voltages inside.

## Caution

**Risk of explosion if the battery is replaced with an incorrect type.**

**Batteries should be recycled where possible. Disposal of used batteries must be in accordance with local environmental regulations.**

## Disclaimer

**This information in this document is subject to change without notice. In no event shall Apex Technology Inc. be liable for damages of any kind, whether incidental or consequential, arising from either the use or misuse of information in this document or in any related materials.**

## Packing List

Accessories (as ticked) included in this package are:
<input type="checkbox"/> Adaptor
<input type="checkbox"/> Driver & manual CD disc
<input type="checkbox"/> Other. _____ (please specify)

## Safety Precautions

Follow the messages below to prevent your systems from damage:

- ◆ Avoid your system from static electricity on all occasions.
- ◆ Prevent electric shock. Don't touch any components of this card when the card is power-on. Always disconnect power when the system is not in use.
- ◆ Disconnect power when you change any hardware devices. For instance, when you connect a jumper or install any cards, a surge of power may damage the electronic components or the whole system.

# Table of Contents

Revision History.....	1
Warning!/Caution/Disclaimer.....	2
Packing List.....	3
Safety Precautions.....	4

## Chapter 1 Getting Started

1.1 Features.....	7
1.2 Specifications.....	7
1.3 Dimensions.....	10
1.4 Brief Description of ARCHMI-9XX.....	14
1.5 Installation of HDD.....	18
1.6 VESA Mounting.....	20
1.7 Panel Mounting.....	20

## Chapter 2 Hardware

2.1 Mainboard Introduction.....	20
2.2 Specifications.....	20
2.3 Jumpers and Connectors Location.....	24
2.4 Jumpers Setting and Connectors.....	25

## Chapter 3 BIOS Setup

3.1 Operations after POST Screen.....	56
3.2 BIOS Setup Utility.....	56
3.3 Main Settings.....	57
3.4 Advanced Settings.....	58
3.5 Chipset Settings.....	62
3.6 Boot Settings.....	64
3.7 Security Settings.....	65
3.8 Save & Exit Settings.....	66

## Chapter 4 Installation of Drivers

4.1 Intel (R) CORE TM SoC Chipset.....	69
4.2 Intel (R) VGA Chipset.....	71
4.3 Intel (R) LAN Driver.....	74
4.4 Realtek ALC662 HD Audio Driver.....	77
4.5 USB 3.0 Driver.....	79
4.6 Intel (R) MEI Driver.....	82

## Chapter 5

## Touch Screen Installation

5.1 Windows 7/8/8.1 Universal Driver Installation for PenMount 6000 Series.....	85
5.2 Software Functions.....	95

### Figures

Figure 1.1: Dimensions of ARCHMI-912(P).....	10
Figure 1.2: Dimensions of ARCHMI-915(P).....	10
Figure 1.3: Dimensions of ARCHMI-916(P).....	11
Figure 1.4: Dimensions of ARCHMI-917(P).....	11
Figure 1.5: Dimensions of ARCHMI-918(P).....	12
Figure 1.6: Dimensions of ARCHMI-919(P).....	12
Figure 1.7: Dimensions of ARCHMI-921(P).....	13
Figure 1.8: Front View of ARCHMI-9XX Series.....	14
Figure 1.9: Rear View of ARCHMI-912(P).....	15
Figure 1.10: Rear View of ARCHMI-915(P).....	15
Figure 1.11: Rear View of ARCHMI-916(P).....	16
Figure 1.12: Rear View of ARCHMI-917(P).....	16
Figure 1.13: Rear View of ARCHMI-918(P).....	17
Figure 1.14: Rear View of ARCHMI-919(P).....	17
Figure 1.15: Rear View of ARCHMI-921(P).....	17
Figure 1.16: ARCHMI Series VESA Mounting.....	19
Figure 1.17: ARCHMI Series Panel Mounting.....	19
Figure 2.1: Motherboard Dimensions.....	23
Figure 2.2: Jumpers and Connectors Location-Board Top.....	24
Figure 2.3: Jumpers and Connectors Location-Board Bottom.....	24

# Chapter 1

# Getting Started

## 1.1 Features

- 12.1" 15"/15.6"/17"/18.5"/19"/21.5" Industrial Compact Size Panel PC
- Flat front panel touch screen and fanless design
- Aluminum die-casting chassis for ARCHMI-916(P)
- Intel 4th Gen. Core i3 CPU built-in/i5(option)
- Onboard 4GB DDR 3L 1600 MHz/8GB(option)
- 9~36VDC wide-ranging power input
- IP66 compliant front panel
- Optional projected capacitive touchscreen support 7H anti-scratch surface

## 1.2 Specifications

	ARCHMI-9XX
<b>System</b>	
CPU	Onboard Intel 4 <sup>th</sup> Gen. Core i3 CPU Processors/i5(option)
Chipset	SoC
Memory	Onboard DDR3L 1600 MHz/8GB(option)
<b>IO Port</b>	
USB	2 x USB 3.0 type A
Serial/Parallel	1 x RS-232 DB-9, COM2 1 x RS-232/422/485 DB-9, COM1, Default RS-232
Audio	1 x Audio Line Out
LAN	2 x GbE LAN RJ-45
Power	1 x 3-pin DC Power Input terminal 1 x 2-pin connector for power on/off button
Option	2 x RS-232 DB-9 + 1 x Mini-PCIe slot via TB-528C2ME1 2 x CAN bus via TB-528CAN2 2 x USB 2.0 type A + 1 x Mini-PCIe slot + 1 x RS-232 DB-9 + 1 x Power button via TB-528C1U2P1 2 x USB 2.0 type A via TB-528U2 UPS Battery 21W/10.8V/1.95Ah(3S1P) <b>UPS Battery and TB-528 expansion board can't be used in the same time for ARCHMI-912(P)</b>



<b>Storage Space</b>	
Storage	1 x 2.5" SATA HDD bay for SATA HDD (Easy Accessible)
<b>Expansion</b>	
Expansion Slot	1 x Internal Mini-PCIe slot full size
<b>Touch Screen – Resistive Touch Window Type</b>	
TS Control	PenMount 6000 on Board
Interface	USB
Light Transmission	Over 80%
<b>Touch Screen – Projected Capacitive Type</b>	
TS Control	Chip on tail
Interface	USB
Light Transmission	Over 90%
<b>Power</b>	
Power Input	9~36V DC
<b>Mechanical</b>	
Front Bezel	Flat Bezel Design
Front Bezel Metal	Aluminum / Panel Mounting
Rear Panel Metal	Aluminum / VESA Mount 100 x 100
Chassis Color	RAL 9007
IP Rating	Front Panel IP66
<b>Operating System Support</b>	
OS Support	Windows Embedded Compact 7, Windows Embedded Standard 7, Windows 7 Pro(FES), Windows 7 Ultimate(FES), Windows Embedded 8 Standard, Windows Embedded 8.1 Industry Pro, Windows 10 IoT
<b>Environmental</b>	
Operating Temperature	0~50°C
Storage Temperature	-20~60°C
Storage Humidity	10 to 90% @ 40°C, non-condensing
Certification	CE / FCC Class A, UL

	<b>ARCHMI-912(P)</b>	<b>ARCHMI-915(P)</b>	<b>ARCHMI-916(P)</b>	<b>ARCHMI-917(P)</b>
<b>Display</b>				
Display Type	12.1" TFT LCD	15" TFT LCD	15.6" TFT LCD	17" TFT LCD
Max. Resolution	800 x 600	1024 x 768	1366 x 768	1280 x 1024
Max. Color	16.2M	16.7M	16.7M	16.2M
Luminance(cd/m <sup>2</sup> )	450	460	300	350
Contrast Ratio	800 : 1	800 : 1	500 : 1	1000 : 1
Viewing angle	160(H)/140(V)	160(H)/140(V)	160(H)/160(V)	170(H)/160(V)
Backlight Lifetime	50,000 hrs	60,000 hrs	50,000 hrs	30,000 hrs
<b>Power Consumption</b>				
Power Consumption	MAX: 19.6W(912) MAX: 22.3W(912P)	MAX: 29.4W(915) MAX: 28W(915P)	MAX: 31W(916) MAX: 30W(916P)	MAX: 29.8W(917) MAX: 30.2W(917P)
<b>Mechanical</b>				
Dimensions(mm)	319 x 245 x 51.7	410 x 310 x 54.7	412 x 277.5 x 58.9	439 x 348 x 64.8
Net Weight	2.7 Kg	4.4 Kg	5.0 Kg	6.1 Kg

	<b>ARCHMI-918(P)</b>	<b>ARCHMI-919(P)</b>	<b>ARCHMI-921(P)</b>
<b>Display</b>			
Display Type	18.5" TFT LCD	19" TFT LCD	21.5" TFT LCD
Max. Resolution	1366 x 768	1280 x 1024	1920 x 1080
Max. Color	16.7M	16.7M	16.7M
Luminance(cd/m <sup>2</sup> )	300	350	250
Contrast Ratio	1000 : 1	1000: 1	3000 : 1
Viewing angle	170(H)/160(V)	170(H) / 165(V)	178(H)/178(V)
Backlight Lifetime	50,000 hrs	50,000 hrs	30,000 hrs
<b>Power Consumption</b>			
Power Consumption	MAX: 41.6W(918) MAX: 42.9W(918P)	MAX: 36.4W(919) MAX: 36.4W(919P)	MAX: 33.3W(921) MAX: 33.3W(921P)
<b>Mechanical</b>			
Dimensions(mm)	499.6 x 314. 6 x72	468 x 380 x 64.8	557 x 362 x 64.8
Net Weight	6.6 Kg	5.9 Kg	7.5 Kg

### 1.3 Dimensions

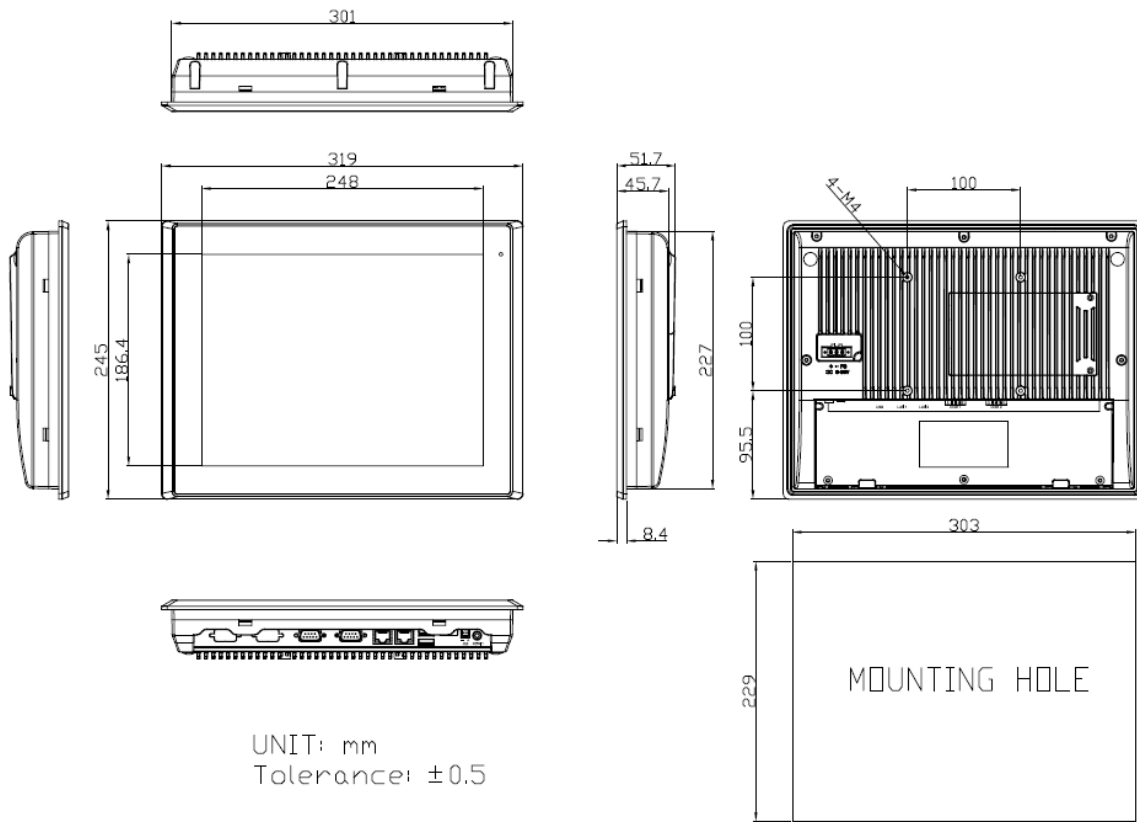

**Figure 1.1: Dimensions of ARCHMI-912(P)**

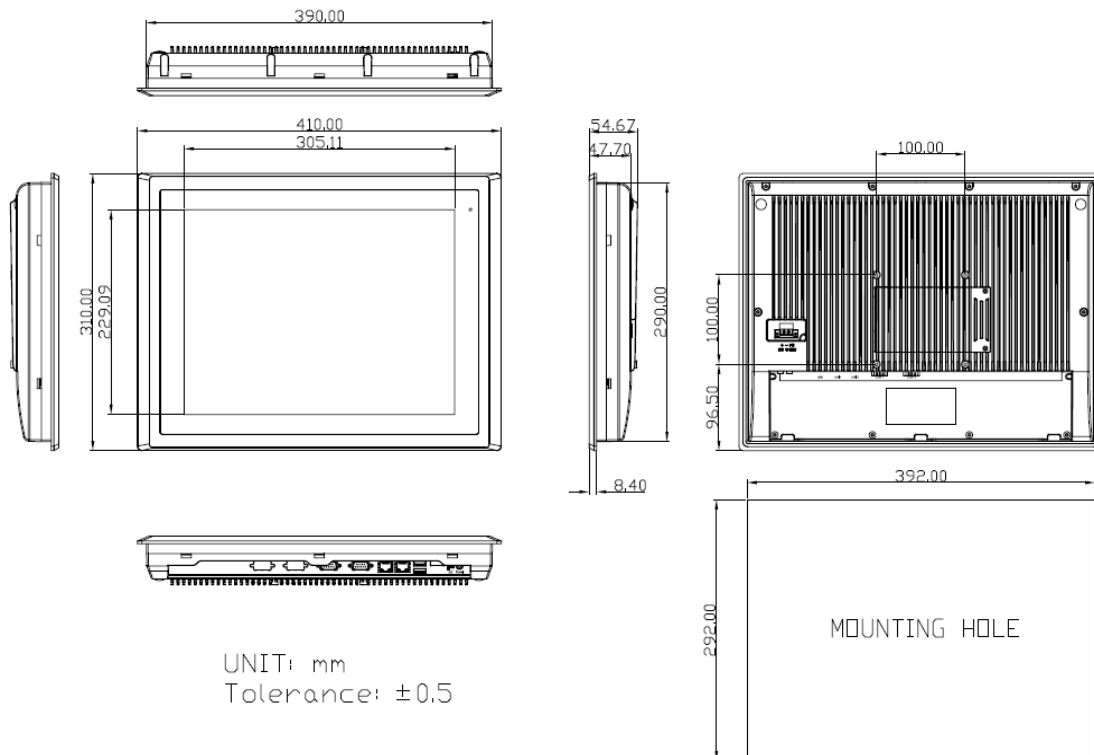

**Figure 1.2: Dimensions of ARCHMI-915(P)**

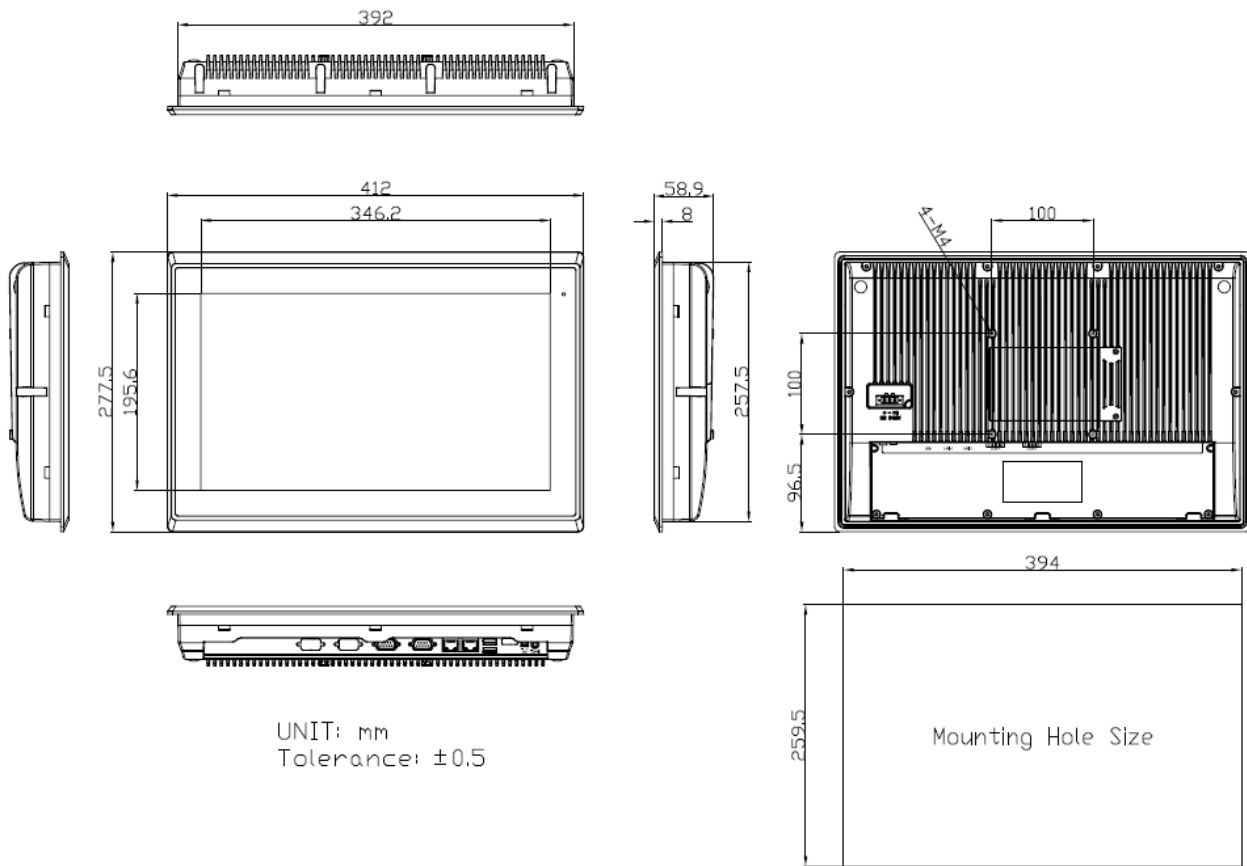

**Figure 1.3: Dimensions of ARCHMI-916(P)**

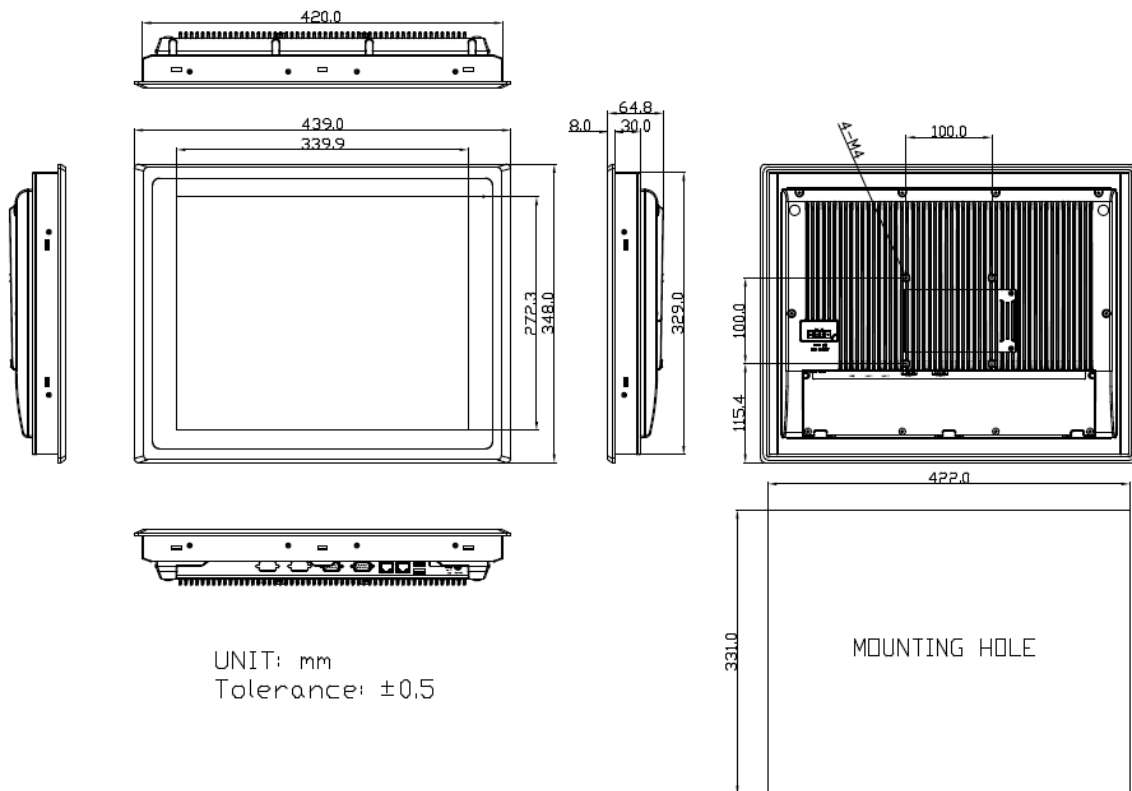

**Figure 1.4: Dimensions of ARCHMI-917(P)**

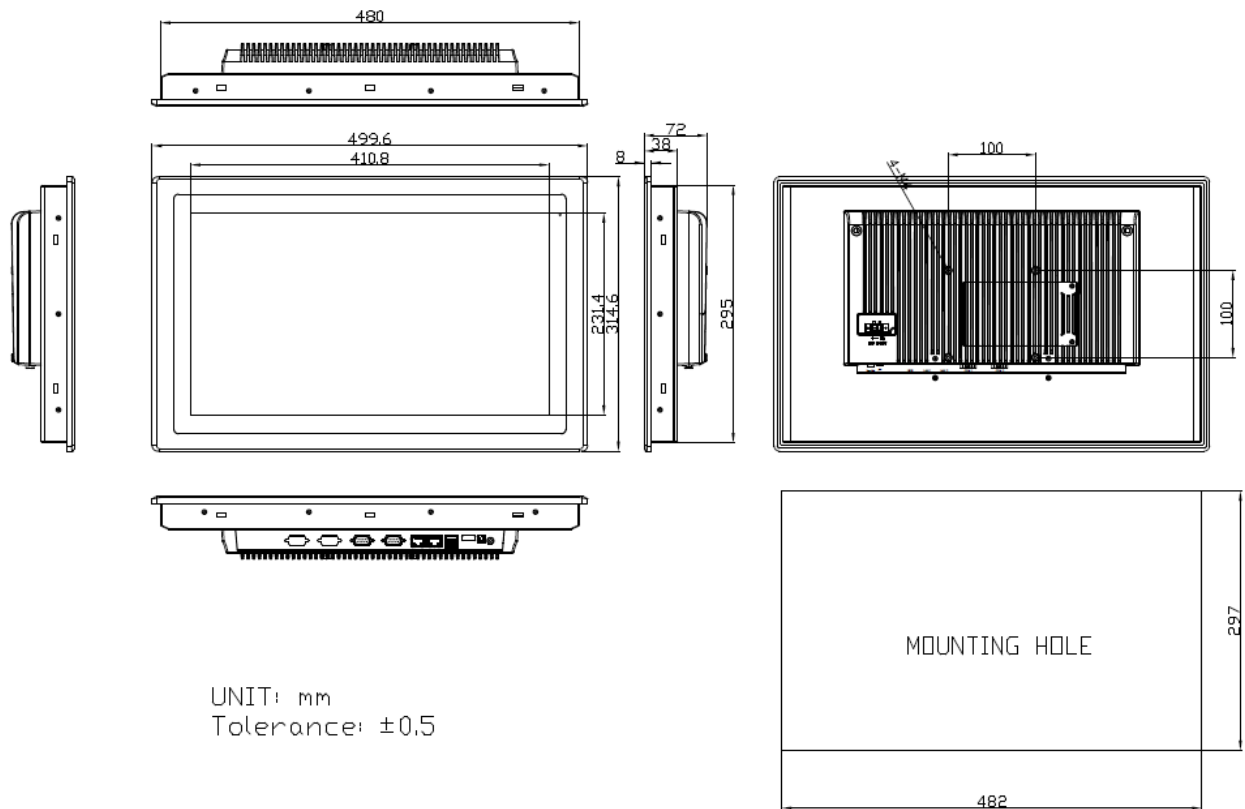

**Figure 1.5: Dimensions of ARCHMI-918(P)**

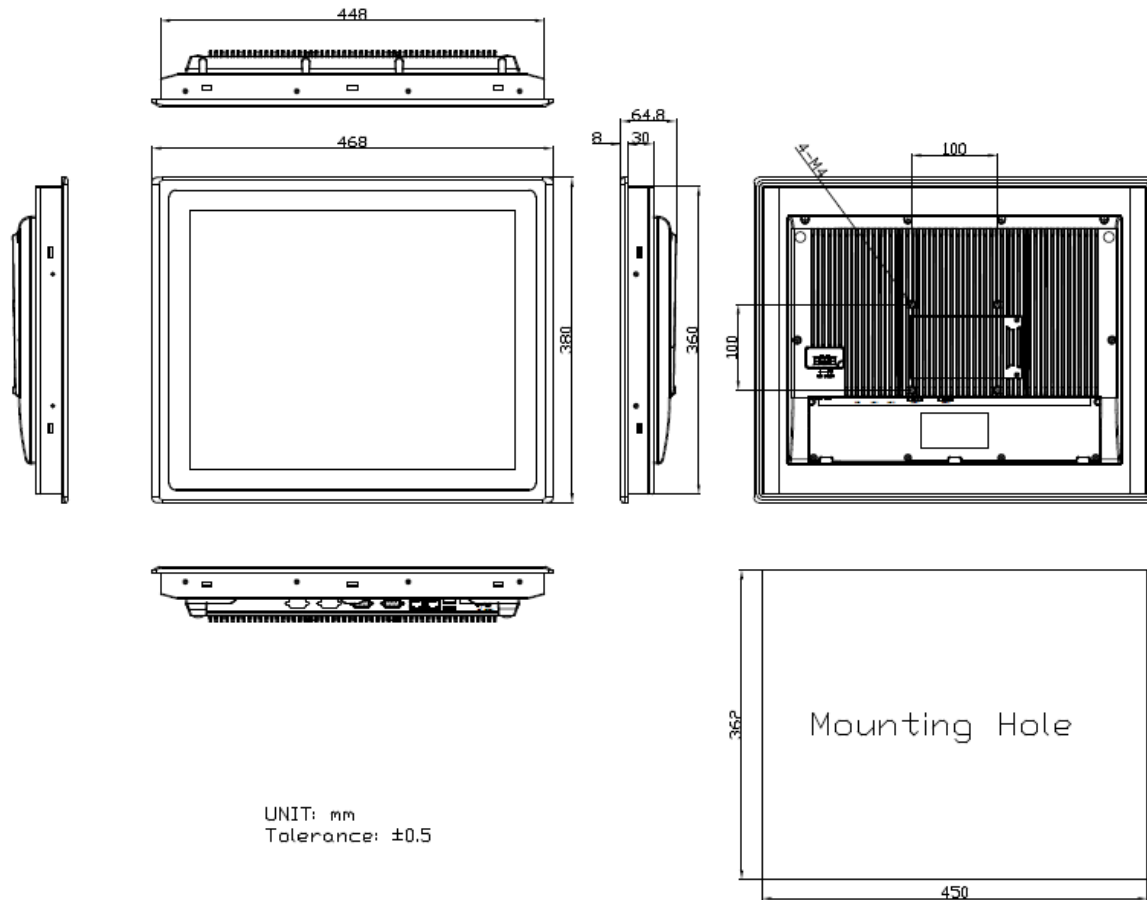

**Figure 1.6: Dimensions of ARCHMI-919(P)**

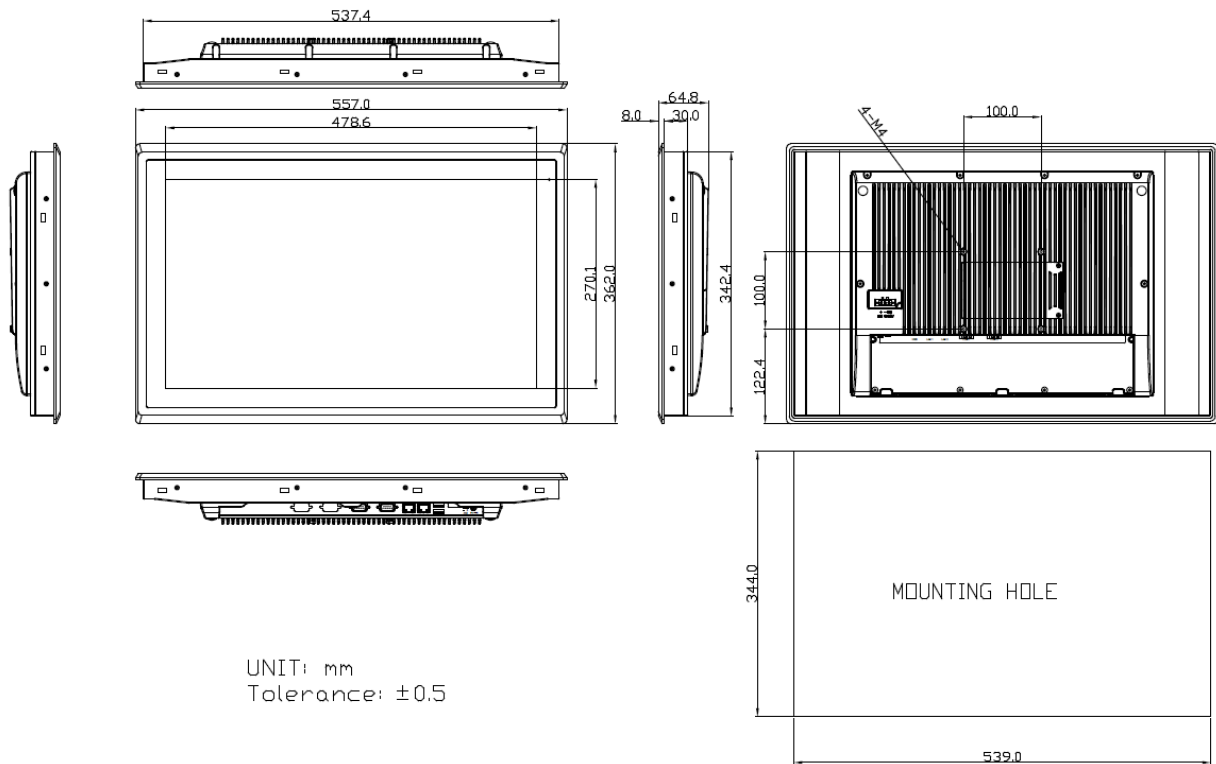

**Figure 1.7: Dimensions of ARCHMI-921(P)**

## 1.4 Brief Description of ARCHMI-9XX

There are 12.1", 15", 15.6", 17", 18.5", 19" and 21.5" Industrial Compact Size Panel PC in ARCHMI-9XX series, which comes with flat front panel touch screen and fanless design. It is powered by Intel 4<sup>th</sup> Gen. Core i3/i5(option) CPU Processors, 4GB DDR3L 1600 MHz (8GB is for option). ARCHMI series is 9~36V DC wide-ranging power input and IP66 compliant front panel. Optional projected capacitive touch support 7H anti-scratch surface is ideal for use as PC-based controller for Industrial Automation & Factory Automation.



**Figure 1.8: Front View of ARCHMI-9XX Series**



**Figure 1.9: Rear View of ARCHMI-912(P)**



**Figure 1.10: Rear View of ARCHMI-915(P)**







## 1.5 Installation of HDD

### Step 1

There are 2 screws to deal with when enclosing or removing the chassis. Gently remove 2 screws.



### Step 2

You can put or remove HDD into the machine by pulling the HDD bracket.



### Step 3

You can remove HDD by unscrewing 4 screws in the HDD bracket. Note: 4 screws are packed in the packing package.



## 1.6 VESA Mounting

The ARCHMI series is designed to be VESA mounted as shown in Picture. Just carefully place the unit through the hole and tighten the given screws from the rear to secure the mounting.

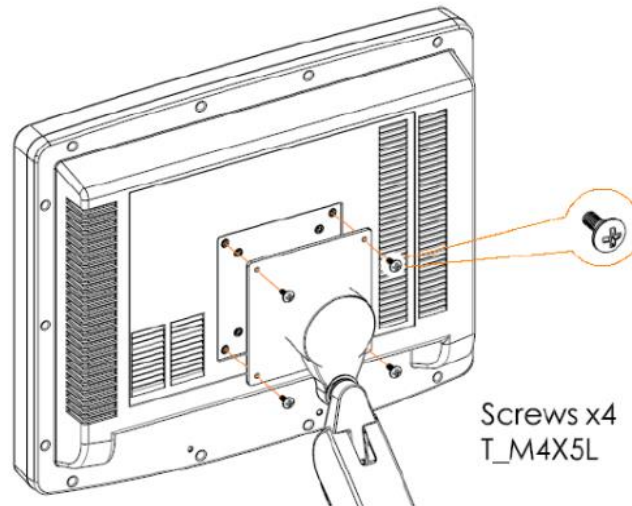

**Figure 1.16: ARCHMI Series VESA Mounting**

## 1.7 Panel Mounting

There are four holes located along the four sides of the HMI. Insert the clamp from the four sides and tighten them with the nuts provided.

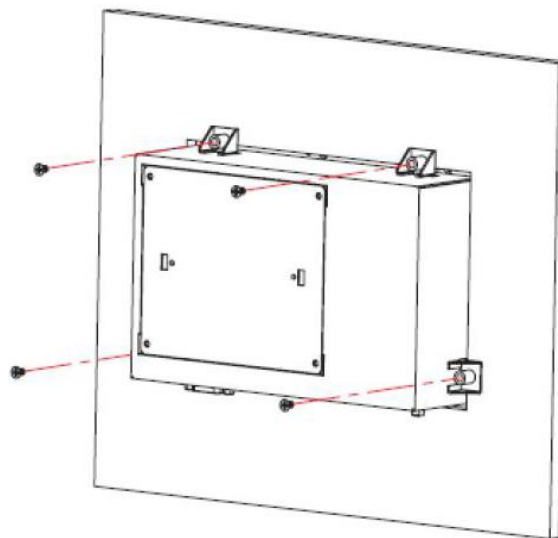

**Figure 1.17: ARCHMI Series Panel Mounting**

## 2.1 Motherboard Introduction

SBC-7110 is a 4" industrial motherboard developed on the basis of Intel Haswell-U Processors, which provides abundant peripheral interfaces to meet the needs of different customers. Also, it features dual GbE ports, 5-COM ports and one Mini PCIE configuration, one eDP port, one HDMI port, one LVDS interface. To satisfy the special needs of high-end customers, CN1 and CN2 and CN3 richer extension functions. The product is widely used in various sectors of industrial control.

## 2.2 Specifications

Specifications	
Board Size	170mm x 113mm
CPU Support	Intel® Core™ i3-4010U /1.7GHz (onboard) Intel® Core™ /i5-4310U /2.0 up to 3.00GHz (option ) <i>Intel® Core™ /i7-4510U /2.0 up to 3.10GHz (option )</i>
Chipset	SoC
Memory Support	Onboard 4GB DDR3L SDRAM
Graphics	Intel® HD Graphics 4400
Display Mode	1 x HDMI Port 1 x LVDS (18/24-bit dual LVDS) <i>1 x eDP Port (EDP1, option)</i>
Support Resolution	Up to 1920 x 1200 for HDMI Up to 1920 x 1200 for LVDS (PS8625) <i>Up to 1920 x 1200 for eDP</i>
Dual Display	HDMI + LVDS
Super I/O	ITE IT8518E Fintek F81216AD
BIOS	AMI/UEFI
Storage	1 x SATAIII Connector (7P) 1 x SATAIII Connector (7P+15P)

<b>Ethernet</b>	2 x PCIe Gbe LAN by Intel 82574L
<b>USB</b>	2 x USB 3.0 (type A)stack ports (USB3) (USB 3.0: USB3-1/USB3-2, USB 2.0: USB1/USB2) 2 x USB 2.0 Pin header for CN3 (USB3/USB4) 1 x USB 2.0 Pin header for CN2 (USB5) 1 x USB 2.0 Pin header for CN1 (USB7 or Touch, option) 1 x USB 2.0 for MPCIE1 (USB8)
<b>Serial</b>	1 x RS232/RS422/RS485 port, DB9 connector for external (COM1) Pin 9 w/5V/12V/Ring select 1 x RS232 port, DB9 connector for external (COM2) Pin 9 w/5V/12V/Ring select 2 x UART for CN3 (COM3,COM4) 1 x RS422/485 header for CN2 (IT8518E/COM5) 1 x RS422/485 header for CN2 (IT8518E/COM6,option)
<b>Digital I/O</b>	8-bit digital I/O by Pin header (CN2) 4-bit digital Input 4-bit digital Output 4-bit digital I/O by Pin header (CN3) 2-bit digital Input 2-bit digital Output
<b>Battery</b>	Support CR2477 Li battery by 2-pin header (BAT1/CMOS)
<b>Smart Battery</b>	1 x Smart battery Support 3 Serial Li battery by 10-pin header (BAT2)
<b>Audio</b>	Support Audio via Realtek ALC662-VD HD audio codec Support Line-in, Line-out, MIC by 2x6-pin header
<b>Keyboard /Mouse</b>	1 x PS2 keyboard/mouse by box pin header (CN3)
<b>Expansion Bus</b>	1 x mini-PCI-express slot 1 x PCI-express (CN3)
<b>Touch Ctrl</b>	1 x Touch ctrl header for TCH1 (ITE8518E/COM6) (JP4 setting: RS232 or USB 2.0)
<b>Power Management</b>	Wide Range DC9V~36V input 1 x 3-pin power input connector
<b>Switches and LED Indicators</b>	1 x Power on/off switch (BT1/BT2/CN2/CN3) 1 x Reset (CN2)

	<ul style="list-style-type: none"> <li>1 x HDD LED status (CN2)</li> <li>1 x Power LED status (CN1)</li> <li>1 x Buzzer</li> </ul>
<b>External I/O port</b>	<ul style="list-style-type: none"> <li>2 x COM Ports (COM1/COM2)</li> <li>2 x USB 3.0 Ports (stack)</li> <li>2 x RJ45 GbE LAN Ports</li> <li>1 x HDMI Port</li> <li>1 x Stack audio Jack (Line out)</li> </ul>
<b>Watchdog Timer</b>	<i>Software programmable 1–255 level by Super I/O (Reserve)</i>
<b>Temperature</b>	<ul style="list-style-type: none"> <li>Operating: -20°C to 70°C</li> <li>Storage: -40°C to 85°C</li> </ul>
<b>Humidity</b>	10% - 90%, non-condensing, operating
<b>Power Consumption</b>	<ul style="list-style-type: none"> <li>12V /1.33A (Intel I3-4010U processor with 4GB DDR3L DRAM)</li> <li>12V /1.33A (Intel I5-4310U processor with 4GB DDR3L DRAM)</li> <li>12V /1.33A (Intel I7-4510U processor with 4GB DDR3L DRAM)</li> </ul>
<b>EMI/EMS</b>	Meet CE/FCC class A
<b>TB-528CAN2</b>	2 x CAN bus
	1 x SIM Card Socket
	1 x mini-PCI-express slot

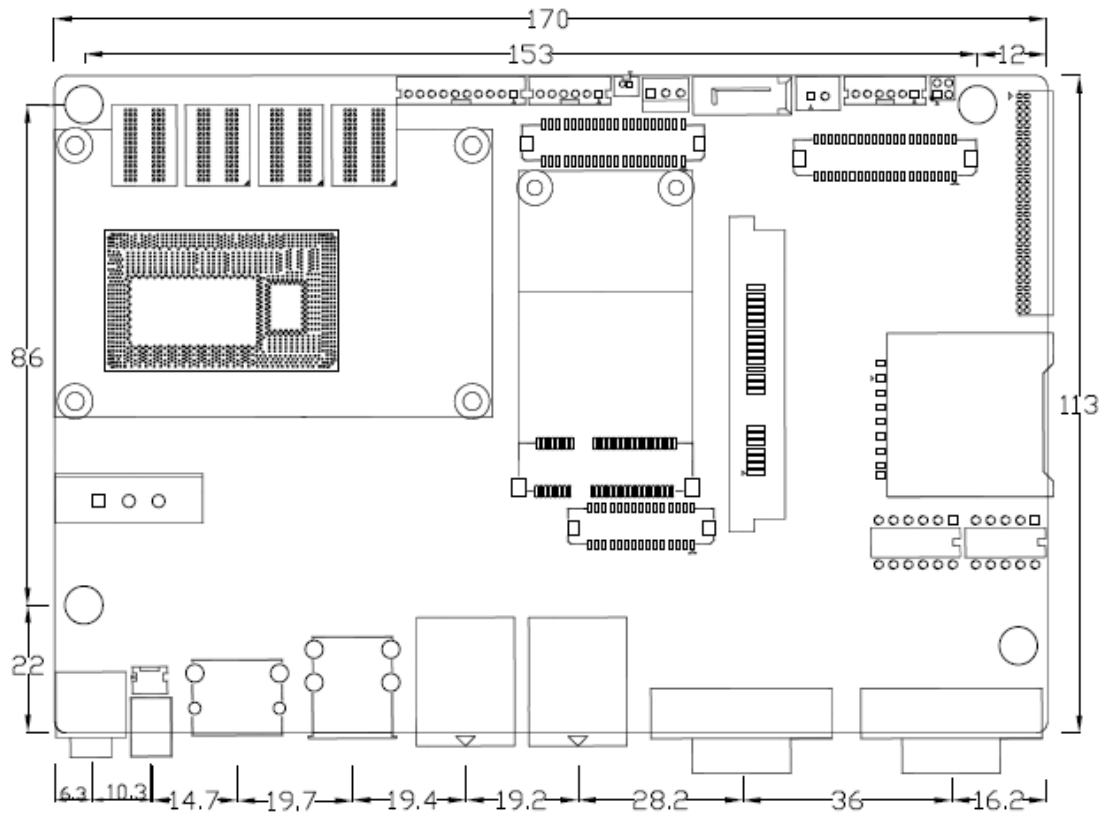

(units :mm)

**Figure 2.1: Motherboard Dimensions**



## 2.3 Jumpers and Connectors Location

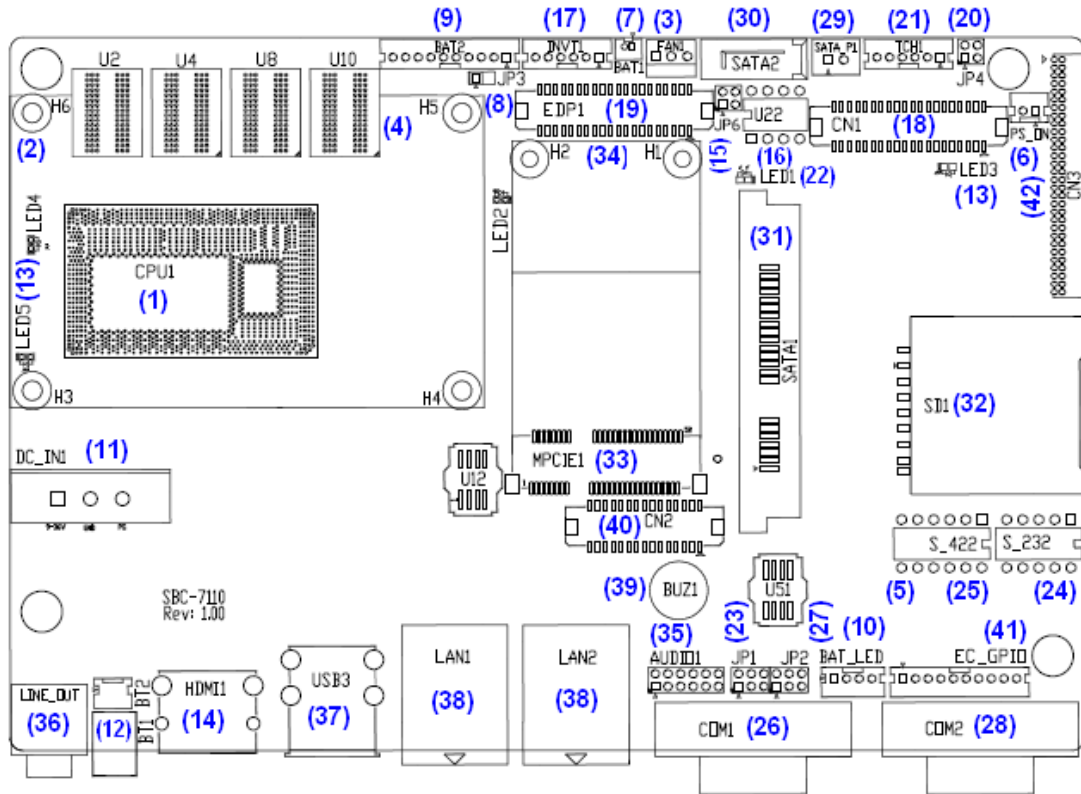

Figure 2.2: Jumpers and Connectors Location- Board Top

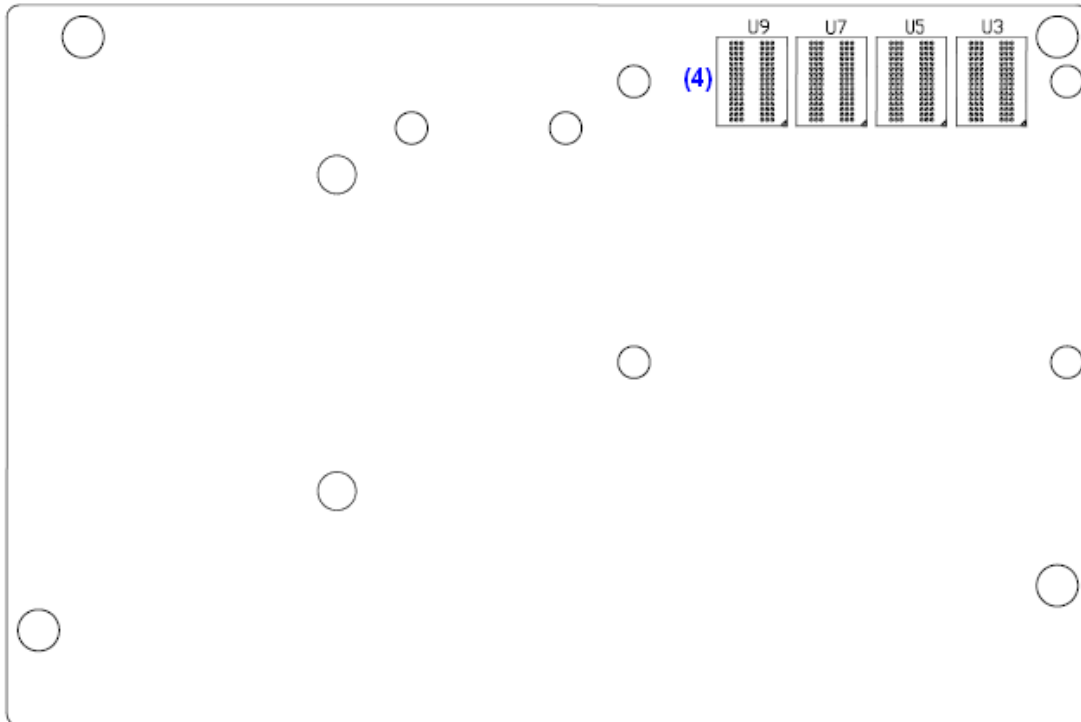

Figure 2.3: Jumpers and Connectors Location- Board Bottom

## 2.4 Jumpers Setting and Connectors

### 1. CPU1:

(FCBGA1168) onboard Intel Haswell-U Processors.

Model	Processor				
	Number	PBF	Cores/Threads	TDP	Remarks
SBC-7110-i34010-4G	i3-4010U	1.7GHz	2 / 4	15W	
SBC-7110-i34010P-4G	i3-4010U	1.7GHz	2 / 4	15W	Option
SBC-7110-i54310-4G	i5-4310U	2.0 up to 3.0GHz	2 / 4	15W	Option
SBC-7110-i54310P-4G	i5-4310U	2.0 up to 3.0GHz	2 / 4	15W	Option
SBC-7110-i74510-4G	i7-4510U	2.0 up to 3.1GHz	2 / 4	15W	Option
SBC-7110-i74510P-4G	i7-4510U	2.0 up to 3.1GHz	2 / 4	15W	option

### 2. H3/H4/H5/H6 (option):

CPU1 Heat Sink Screw holes, four screw holes for intel Haswell-U Processors Heat Sink assemble.

### 3. FAN1 (option):

(2.54mm Pitch 1x3 Pin Header), Fan connector, cooling fans can be connected directly for use. You may set the rotation condition of cooling fan in menu of BIOS CMOS Setup.



Pin#	Signal Name
1	Ground
2	VCC
3	Rotation detection



Note:

Output power of cooling fan must be limited under 5W.

### 4. U2/U3/U4/U5/U7/U8/U9/U10:

(FBGA96) onboard DDR3L Memory.

Model	Memory
SBC-7110-i34010-4G	4GB
SBC-7110-i34010P-4G	4GB (option)
SBC-7110-i54310-4G	4GB (option)
SBC-7110-i54310P-4G	4GB (option)
SBC-7110-i74510-4G	4GB (option)
SBC-7110-i74510P-4G	4GB (option)

**5. S-422 (PIN6):**

(Switch), ATX Power and Auto Power on jumper setting.

S-422(Switch)	Mode
Pin6 (Off)	ATX Power
Pin6 (On)	<b>Auto Power on (Default)</b>

**6. PS\_ON (option):**

(2.0mm Pitch 1x2 Pin wafer Header), ATX Power and Auto Power on jumper setting.

Pin#	Mode
Open	ATX Power
Close 1-2	<b>Auto Power on (Default)</b>

**7. BAT1:**

(1.25mm Pitch 1x2 Wafer Pin Header) 3.0V Li battery is embedded to provide power for CMOS.

Pin#	Signal Name
Pin1	VBAT
Pin2	Ground

**8. JP3:**

(2.0mm Pitch 1x2 Pin Header) CMOS clear jumper, CMOS clear operation will permanently reset old BIOS settings to factory defaults.

JP3	CMOS
Open	NORMAL (Default)
Close 1-2	Clear CMOS



#### Procedures of CMOS clear:

- a) Turn off the system and unplug the power cord from the power outlet.
- b) To clear the CMOS settings, use the jumper cap to close pins 1 and 2 for about 3 seconds then reinstall the jumper clip back to pins open.
- c) Power on the system again.
- d) When entering the POST screen, press the <ESC> or <DEL> key to enter CMOS Setup Utility to load optimal defaults.
- e) After the above operations, save changes and exit BIOS Setup.

#### 9. BAT2:

(2.0mm Pitch 1x10 Wafer Pin Header), Smart battery Interface.

Pin#	Signal Name
Pin1	VCC_BAT1
Pin2	VCC_BAT1
Pin3	VCC_BAT1
Pin4	SMB_DAT_SW
Pin5	SMB_SCL_SW
Pin6	BAT1_TEMP
Pin7	Ground
Pin8	Ground
Pin9	Ground
Pin10	SET_BAT1_ON

Function	Specifications
Nominal voltage (3S1P)	11.1~12.6V
Charge voltage	12.6V
Charge current	0.5C

#### 10. BAT\_LED:

(2.0mm Pitch 1x4 Wafer Pin Header), The Charge status indicator for BAT2.

Pin1-Pin3: Charge LED status.

Pin2-Pin3: Discharge LED status.

Pin4-Pin3: EC LED status.

Pin#	Signal Name
Pin1	BAT2_LED+

Pin2	BAT2_LED-
Pin3	Ground
Pin4	RST_EC

**11. DC\_IN1:**

(5.08mm Pitch 1x3 Pin Connector), DC9V~36V System power input connector.

Pin#	Signal Name
Pin1	DC+9V~36V
Pin2	Ground
Pin3	FG

Model	DC_IN1
SBC-7110-i34010U-4G	180°Connector
SBC-7110-i54310U-4G	180°Connector
SBC-7110-i74510U-4G	180°Connector
SBC-7110-i34010UP-4G	45°Connector
SBC-7110-i54310UP-4G	45°Connector
SBC-7110-i74510UP-4G	45°Connector

**12. BT1/BT2:**

**Power on/off button,** They are used to connect power switch button. The two pins are disconnected under normal condition. You may short them temporarily to realize system startup & shutdown or awaken the system from sleep state.

**13. LED2/LED3/LED4/LED5:**

LED2: LED STATUS. Green LED for Motherboard EC status.

LED3: LED STATUS. Green LED for Power status.

LED4: LED STATUS. Green LED for Motherboard Standby Power Good status.

LED5: LED STATUS. Green LED for CPU1 status

**14. HDMI1:**

(HDMI 19P Connector), High Definition Multimedia Interface connector.

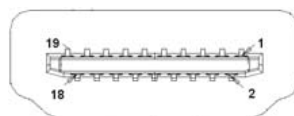

**15. JP6:**

(2.0mm Pitch 2x2 Pin Header), LVDS jumper setting.

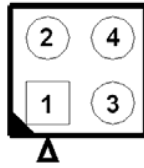

JP6	Function (CN1)
Pin1-Pin2 (Close)	Signal channel LVDS
<b>Pin1-Pin2 (Open)</b>	<b>Dual channel LVDS (Default)</b>
<b>Pin3-Pin4 (Close)</b>	<b>8/24 bit (Default)</b>
Pin3-Pin4 (Open)	6/18 bit

**16. U22:**

AT24C02-DIP8, The EEPROM IC (U22) is the set of LVDS resolution. If you need other resolution settings, please upgrade U22 data.

Model	LVDS resolution
SBC-7110-i34010U-XX SBC-7110-i54310U-XX SBC-7110-i74510U-XX	1280 x 1024 (Default)
	800 x 480 (option)
	800 x 600 (option)
	1024 x 768 (option)
	1920 x 1080 (option)
	.....

**17. INVT1:**

(2.0mm Pitch 1x6 wafer Pin Header), Backlight control connector for LVDS.

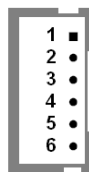

Pin#	Signal Name
1	+DC12V_S0
2	+DC12V_S0
3	Ground
4	Ground
5	BKLT_EN_OUT
6	BKLT_CTRL

**18. CN1:**

(1.25mm Pitch 2x20 Connector, DF13-40P), For 18/24-bit LVDS output connector, Fully supported by Parad PS8625(DP to LVDS), the interface features dual channel 24-bit output. Low Voltage Differential Signaling, A high speed, low power data transmission standard used for display connections to LCD panels.

Function	Signal Name	Pin#	Pin#	Signal Name	Function
LVDS	12V_S0	2	1	12V_S0	LVDS
	BKLT_EN_OUT	4	3	BKLT_CTRL	
	Ground	6	5	Ground	
	LVDS_VDD5	8	7	LVDS_VDD5	
	LVDS_VDD3	10	9	LVDS_VDD3	
	Ground	12	11	Ground	
	LA_D0_P	14	13	LA_D0_N	
	LA_D1_P	16	15	LA_D1_N	
	LA_D2_P	18	17	LA_D2_N	
	LA_D3_P	20	19	LA_D3_N	
	LA_CLKP	22	21	LA_CLKN	
	LB_D0_P	24	23	LB_D0_N	
	LB_D1_P	26	25	LB_D1_N	
	LB_D2_P	28	27	LB_D2_N	
	LB_D3_P	30	29	LB_D3_N	
LB_CLKP	32	31	LB_CLKN		
Ground	34	33	Ground	USB7 (JP4 open)	
USB7 (JP4 open)	USB7_P	36	35		USB7_N
	5V_S5_USB	38	37	5V_S5_USB	
Power LED	PWR_LED+	40	39	Ground	Power LED

**19. EDP1 (option)**

Function	Signal Name	Pin#	Pin#	Signal Name	Function
	12V_S0_EDP	2	1	12V_S0_EDP	
	12V_S0_EDP	4	3	12V_S0_EDP	
	Ground	6	5	Ground	
	EDP_VDD5	8	7	EDP_VDD5	
	EDP_VDD3	10	9	EDP_VDD3	

EDP	Ground	12	11	Ground	EDP	
	EDP_BKLT_EN	14	13	EDP_TXN_1		
	EDP_BKLT_CTRL	16	15	EDP_TXP_1		
	EDP_VDD_EN	18	17	Ground		
	EDP_TXN_2	20	19	EDP_TXN_0		
	EDP_TXP_2	22	21	EDP_TXP_0		
	Ground	24	23	Ground		
	EDP_TXN_3	26	25	EDP_AUX_N		
	EDP_TXP_3	28	27	EDP_AUX_P		
	EDP_DISP_UTIL	30	29	12C1_SCL		12C
	EDP_HP_CN	32	31	12C1_SDA		
	Ground	34	33	Ground		USB7 (option)
USB7_P	36	35	USB7_N			
5V_S5_USB	38	37	5V_S5_USB			
Power LED	PWR_LED+	40	39	Ground	Power LED	

**20. JP4:**

(2.0mm Pitch 2x2 wafer Pin Header), USB3(CN1) or Touch jumper setting.

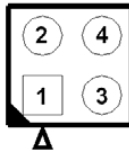

JP4	Function	
	USB7 (CN1)	Touch (TCH1)
Close 3-4 ( <b>default</b> )	-	Yes
Open 3-4 (option)	Yes	-
Open 1-2 ( <b>default</b> )	-	

**21. TCH1:**

(2.0mm Pitch 1x6 wafer Pin Header), internal Touch controller connector.

Pin#	Signal Name
1	SENSE
2	X+
3	X-
4	Y+
5	Y-
6	GND_EARCH



**22. LED1:**

LED1: LED STATUS. Green LED for Touch Power status.

**23. JP1:**

(2.0mm Pitch 2x3 Pin Header), COM1 jumper setting, pin 1~6 are used to select signal out of pin 9 of COM1 port.

JP1 Pin#	Function
<b>Close 1-2</b>	<b>COM1 RI (Ring Indicator) (default)</b>
Close 3-4	COM1 Pin9: DC+5V (option)
Close 5-6	COM1 Pin9: DC+12V (option)

**24. S\_232**

(Switch), COM1 jumper setting, it provides selectable RS232 or RS422 or RS485 serial signal output.

Function	S_232 Pin#
<b>RS232 (Default)</b>	<b>ON: Pin1, Pin2, Pin3, Pin4, Pin5</b>
RS422 (option)	OFF: Pin1, Pin2, Pin3, Pin4, Pin5
RS485 (option)	OFF: Pin1, Pin2, Pin3, Pin4, Pin5

**25. S\_422:**

(Switch), COM1 setting, it provides selectable RS232 or RS422 or RS485 serial signal output.

Function	S_422 Pin#
<b>RS232 (Default)</b>	<b>OFF: Pin1, Pin2, Pin3, Pin4, Pin5</b>
RS422 (option)	ON: Pin1, Pin2, Pin3, Pin4, Pin5
RS485 (option)	ON: Pin1, Pin2, Pin3, Pin4, Pin5

S-422	Mode
Pin6 (Off)	ATX Power
Pin6 (On)	<b>Auto Power on (Default)</b>

**26. COM1**

**(Type DB9M)**, Rear serial port, standard DB9 Male serial port is provided to make a direct connection to serial devices. COM1 port is controlled by pins No. 1~6 of JP1, select output Signal RI or 5V or 12V, For details, please refer to description of JP1 and S\_232 and S\_422 setting.

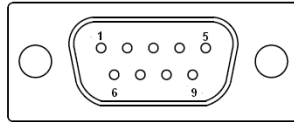

<b>RS232 (Default)</b>	
Pin#	Signal Name
1	DCD# (Data Carrier Detect)
2	RXD (Received Data)
3	TXD (Transmit Data)
4	DTR (Data Terminal Ready)
5	Ground
6	DSR (Data Set Ready)
7	RTS (Request To Send)
8	CTS (Clear To Send)
9	<b>JP1 select Setting (RI/5V/12V)</b>
BIOS Setup: Advanced/F81216 Super IO Configuration/Serial Port 0 Configuration <b>【RS-232】</b>	

<b>RS422 (option)</b>	
Pin#	Signal Name
1	422_RX+
2	422_RX-
3	422_TX-
4	422_TX+
5	Ground
6	NC
7	NC
8	NC
9	NC
BIOS Setup: Advanced/F81216 Super IO Configuration/Serial Port 0 Configuration <b>【RS-422】</b>	

<b>RS485 (option)</b>	
Pin#	Signal Name
1	NC
2	NC

3	485-
4	485+
5	Ground
6	NC
7	NC
8	NC
9	NC
BIOS Setup: Advanced/F81216 Super IO Configuration/Serial Port 0 Configuration <b>【RS-485】</b>	

**27. JP2:**

(2.0mm Pitch 2x3 Pin Header), COM2 jumper setting, pin 1~6 are used to select signal out of pin 9 of COM2 port.

JP2 Pin#	Function
<b>Close 1-2</b>	<b>COM2 RI (Ring Indicator) (default)</b>
Close 3-4	COM2 Pin9: DC+5V (option)
Close 5-6	COM2 Pin9: DC+12V (option)

**28. COM2:**

(Type DB9M), Rear serial port, standard DB9 Male serial port is provided to make a direct connection to serial devices.

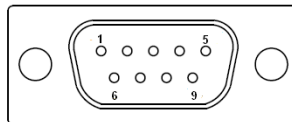

Pin#	Signal Name
1	DCD# (Data Carrier Detect)
2	RXD (Received Data)
3	TXD (Transmit Data)
4	DTR (Data Terminal Ready)
5	Ground
6	DSR (Data Set Ready)
7	RTS (Request To Send)
8	CTS (Clear To Send)
9	<b>JP2 select Setting (RI/5V/12V)</b>

**29. SATA\_P:**

(2.5mm Pitch 1x2 box Pin Header), One onboard 5V output connector are reserved to provide power for SATA devices.

Pin#	Signal Name
1	+DC5V
2	Ground



**Note:**

**Output current of the connector must not be above 1A.**

**30. SATA2:**

(SATA 7Pin), SATA Connectors, one SATA connector are provided, with transfer speed up to 6.0Gb/s.

**31. SATA1:**

(SATA 7Pin+15Pin), SATA Connectors, one SATA connector are provided, with transfer speed up to 6.0Gb/s.

**32. MPCIE1:**

(Socket 52Pin), mini PCIe socket, it is located at the top, it supports mini PCIe devices with USB2.0 and LPC and SMBUS and PCIe signal. MPCIE card size is 30 x 50.95mm.

**33. H1/H2:**

MPCIE1 SCREW HOLES, H1 and H2 for mini PCIE card (30mm x 50.95mm) assemble.

**34. AUDIO1:**

(2.0mm Pitch 2x6 Pin Header), Front Audio, An onboard Realtek ALC662-VD codec is used to provide high-quality audio I/O ports. Line Out can be connected to headphone or amplifier. Line In is used for the connection of external audio source via a Line in cable. MIC is the port for microphone input audio.

Signal Name	Pin#	Pin#	Signal Name
+5V	1	2	GND_AUD
LINE-OUT-L	3	4	LINE-OUT-R

FRONT_JD	5	6	LINE1_JD
LINE-IN-L	7	8	LINE-IN-R
MIC-IN-L	9	10	MIC-IN-R
GND_AUD	11	12	MIC1_JD

**35. LINE\_OUT:**

(Diameter 3.5mm Jack), HD Audio port, An onboard Realtek ALC662-VD codec is used to provide high quality audio I/O ports. Line Out can be connected to a headphone or amplifier.



Line out

**36. USB3:**

**USB3-1/USB3-2:** (Double stack USB type A), Rear USB connector, it provides up to two USB3.0 ports, High-speed USB 2.0 allows data transfers up to 480 Mb/s, USB3.0 allows data transfers up to 5.0Gb/s, support USB full-speed and low-speed signaling.

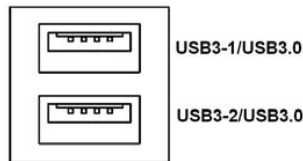

**Each USB Type A Receptacle (2 Ports) Current limited value is 1.5A.**

**If the external USB device current exceeds 1.5A, please separate connectors into different Receptable.**

**37. LAN1/LAN2:**

**LAN1/LAN2:** (RJ45 Connector), Rear LAN port, Two standard 10/100/1000M RJ-45 Ethernet ports are provided. Used intel 82574L chipset, LINK LED (green) and ACTIVE LED (yellow) respectively located at the left-hand and right-hand side of the Ethernet port indicate the activity and transmission state of LAN.

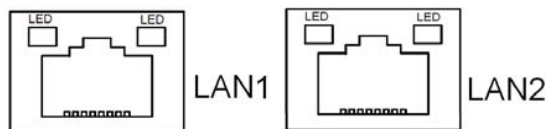

**38. BUZ1:**

Onboard buzzer.

### 39. CN2:

(DF13-30P Connector), For expand output connector, It provides eight GPIO, one RS422 or RS485, one USB2.0, one Power on/off, one Reset.

Function	Signal Name	Pin#	Pin#	Signal Name	Function
5V	5V_S5	2	1	5V_S5	5V
PCH_GPIO49	GPIO_IN2	4	3	GPIO_IN1	PCH_GPIO48
PCH_GPIO51	GPIO_IN4	6	5	GPIO_IN3	PCH_GPIO50
PCH_GPIO53	GPIO_OUT2	8	7	GPIO_OUT1	PCH_GPIO52
PCH_GPIO55	GPIO_OUT4	10	9	GPIO_OUT3	PCH_GPIO54
	Ground	12	11	Ground	
485 or 422 (COM5)	485+_422TX5+	14	13	485-_422TX5-	485 or 422 (COM5)
	422_RX5+	16	15	422_RX5-	
485 or 422 (COM6)	485+_422TX6+	18	17	485-_422TX6-	485 or 422 (COM6)
	422_RX6+	20	19	422_RX6-	
5V	5V_S0	22	21	HDD_LED+	HDD LED
USB2.0	5V_USB5	24	23	5V_USB5	USB2.0
	USB5_P	26	25	USB5_N	
	Ground	28	27	FP_RST-	RESET
Power auto on	PWRBTN_ON	30	29	Ground	

COM5 BIOS Setup:  
Advanced/Super IO Configuration/Serial Port0 Configuration 【RS-422】  
Advanced/Super IO Configuration/Serial Port 0 Configuration 【RS-485】

COM6 BIOS Setup:  
Advanced/Super IO Configuration/Serial Port 1 Configuration 【RS-422】  
Advanced/Super IO Configuration/Serial Port 1 Configuration 【RS-485】

### 40. EC\_GPIO:

(2.0mm Pitch 1x10 Pin Header), For expand connector, It provides eight GPIO.

Pin#	Signal Name
1	Ground
2	EC_GPIO1
3	EC_GPIO2
4	EC_GPIO3
5	EC_GPIO4
6	EC_GPIO5
7	EC_GPIO6
8	EC_GPIO7

9	EC_GPIO8
10	3.3V_ALLS_EC

#### 41. CN3:

(1.27mm Pitch 2X30 Female Header), For expand output connector, It provides four GPIO, two USB 2.0, one PS/2 mouse, one PS/2 keyboard, two uart, one PCIe1, one SMBus. It's connected to the TB-528 riser Card

Function	Signal Name	Pin#	Pin#	Signal Name	Function
	5V_S5_USB	1	2	5V_S5_USB	
	5V_S5_USB	3	4	5V_S5_SB	
	USB34_OC	5	6	PSON_ATX-	
USB3	USB3_N	7	8	USB3_P	USB3
USB4	USB4_N	9	10	USB4_P	USB4
	Ground	11	12	Ground	
PS/2 MS	PS2_MSCLK	13	14	PS2_MSDATA	PS/2 MS
PS/2 KB	PS2_KBCLK	15	16	PS2_KBDATA	PS/2 KB
COM4 (UART)	COM4_RI	17	18	COM4_DCD-	COM4 (UART)
	COM4_TXD	19	20	COM4_RXD	
	COM4_DTR	21	22	COM4_RTS-	
	COM4_DSR	23	24	COM4_CTS-	
	Ground	25	26	Ground	
COM3 (UART)	COM3_RI	27	28	COM3_DCD-	COM3 (UART)
	COM3_TXD	29	30	COM3_RXD	
	COM3_DTR	31	32	COM3_RTS-	
	COM3_DSR	33	34	COM3_CTS-	
GPIO56	PCH_GPIO56	35	36	PCH_GPIO58	GPIO58
GPIO57	PCH_GPIO57	37	38	PCH_GPIO59	GPIO59
	Ground	39	40	Ground	
PCIe	PCIe1_TX_N0	41	42	PE1_TX_P0	PCIe
	PCIe1_RX_N0	43	44	PE1_RX_P0	
	Ground	45	46	Ground	
	CLK_100M_PE1_N	47	48	CLK_100M_PE1_P	
	PCIe1_WAKE_N	49	50	PLT_RST_BUF2-	
SMBUS	SMB_CLK_S5	51	52	SMB_DATA_S5	SMBUS
PCIe	CLKREQ_PE1-	53	54	Ground	
	3P3V_S5	55	56	PWRBTN_ON-	Power Auto on

	3P3V_S5	57	58	3P3V_S5	
12V	12V_S0	59	60	12V_S0	12V

**42. TB-528C2ME1 (option):**

SBC-7110 Riser Card, TB-528C2ME1 CN3 connect to SBC-7110 CN3 pin Header.

TB-528C2ME1 Top:

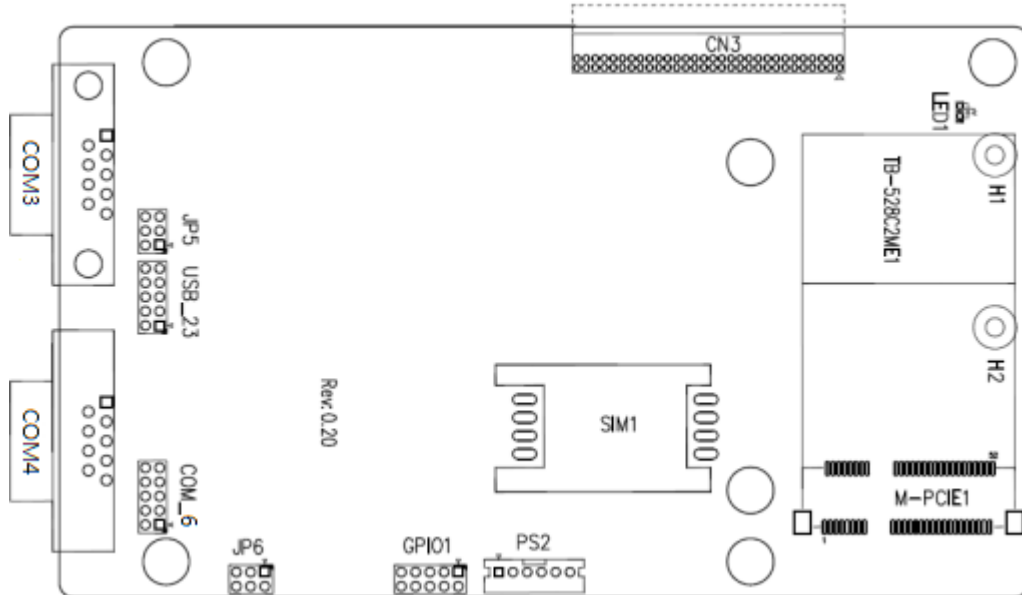

**CN3:**

(1.27mm Pitch 2x30 Pin Header), connect to SBC-7110 CN3 pin Header.

**M-PCIE1:**

(Socket 52Pin), mini PCIe socket, it is located at the top, it supports mini PCIe devices with **USB2.0 (USB3)**, Smbus, SIM and PCIe signal. MPCIE card size is 30 x 30mm or 30 x 50.95mm.

Signal Name	Function support
PCIe 1X	Yes
USB2.0 (USB2)	Yes
SMBus	Yes
SIM	Yes

**H1/H2:**

MPCIE1 SCREW HOLES, H2 for mini PCIE card (30mm x 30mm) assemble. H1 for mini PCIE card (30mm x 50.95mm) assemble.



**LED1:**

Mini PCIe devices LED Status.

**SIM1:**

(SIM Socket 6 Pin), Support SIM Card devices.

**PS2:**

(2.0mm Pitch 1x6 Pin Wafer), PS/2 keyboard and mouse port, the port can be connected to PS/2 keyboard or mouse via a dedicated cable for direct used.

Pin#	Signal Name
1	KBDATA
2	MSDATA
3	Ground
4	+5V
5	KBCLK
6	MSCLK

**GPIO1:**

(2.0mm Pitch 2x5 Pin Header), General-purpose input/output port, it provides a group of self-programming interfaces to customers for flexible use.

Signal Name	Pin#	Pin#	Signal Name
Ground	1	2	NC
NC	3	4	SMB_DATA_R
SMB_CLK_R	5	6	PCH-GPIO56
PCH-GPIO57	7	8	PCH-GPIO59
PCH-GPIO58	9	10	+5V

**USB\_23:**

(2.0mm Pitch 2x5 Pin Header), Front USB connector, it provides one USB port via a dedicated USB cable, speed up to 480Mb/s.

Signal Name	Pin#	Pin#	Signal Name
5V_USB23	1	2	5V_USB23
USB4_N	3	4	<b>USB3_N (option, NC)</b>

USB4_P	5	6	<b>USB3_P (option, NC)</b>
Ground	7	8	Ground
NC	9	10	Ground



**Note:**

Before connection, make sure that pinout of the USB Cable is in accordance with that of the said tables. Any inconformity may cause system down and even hardware damages.

**JP5:**

(2.0mm Pitch 2x3 Pin Header), COM3 setting jumper, pin 1~6 are used to select signal out of pin 9 of COM3 port.

JP5 Pin#	Function
<b>Close 1-2</b>	<b>RI (Ring Indicator) (default)</b>
Close 3-4	COM3 Pin9=+5V (option)
Close 5-6	COM3 Pin9=+12V (option)

**COM5(SBC-7110/COM3):**

(Type DB9), serial port, standard DB9 serial port is provided to make a direct connection to serial devices. COM5 port is controlled by pins No. 1~6 of **JP5**, select output Signal RI or 5V or 12V, for details, please refer to description of JP5.

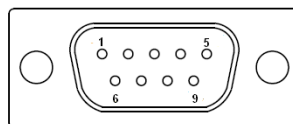

Pin#	Signal Name
1	DCD# (Data Carrier Detect)
2	RXD (Received Data)
3	TXD (Transmit Data)
4	DTR (Data Terminal Ready)
5	Ground
6	DSR (Data Set Ready)
7	RTS (Request To Send)
8	CTS (Clear To Send)
9	JP5 Setting: <b>Pin1-2: RI (Ring Indicator) (default)</b>

	Pin3-4: 5V Standby power (option) Pin5-6: 12V Standby power (option)
--	---

**JP6:**

(2.0mm Pitch 2x3 Pin Header), COM4 setting jumper, pin 1~6 are used to select signal out of pin 9 of COM4 port.

JP6 Pin#	Function
<b>Close 1-2</b>	<b>RI (Ring Indicator) (default)</b>
Close 3-4	COM4 Pin9=+5V (option)
Close 5-6	COM4 Pin9=+12V (option)

**COM6(SBC-7110/COM4):**

(Type DB9), serial port, standard DB9 serial port is provided to make a direct connection to serial devices. COM6 port is controlled by pins No.1~6 of **JP6**, select output Signal RI or 5V or 12V, for details, please refer to description of JP6.

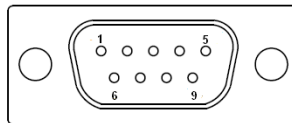

Pin#	Signal Name
1	DCD# (Data Carrier Detect)
2	RXD (Received Data)
3	TXD (Transmit Data)
4	DTR (Data Terminal Ready)
5	Ground
6	DSR (Data Set Ready)
7	RTS (Request To Send)
8	CTS (Clear To Send)
9	JP6 Setting: <b>Pin1-2: RI (Ring Indicator) (default)</b> Pin3-4: 5V Standby power (option) Pin5-6: 12V Standby power (option)

**COM\_6 (option, SBC-7110/COM4):**

(2.0mm Pitch 2x5 Pin Header), COM6 Port, up to one standard RS232 port are provided. They can be used directly via COM cable connection.

Signal Name	Pin#	Pin#	Signal Name
DCD	1	2	RXD
TXD	3	4	DTR
Ground	5	6	DSR
RTS	7	8	CTS
JP6 Setting: RI/5V/12V	9	10	NC

**43. TB-528C2 (option):**

SBC-7110 Riser Card, TB-528C2 CN3 connect to SBC-7110 CN3 pin Header.

TB-528C2 Top:

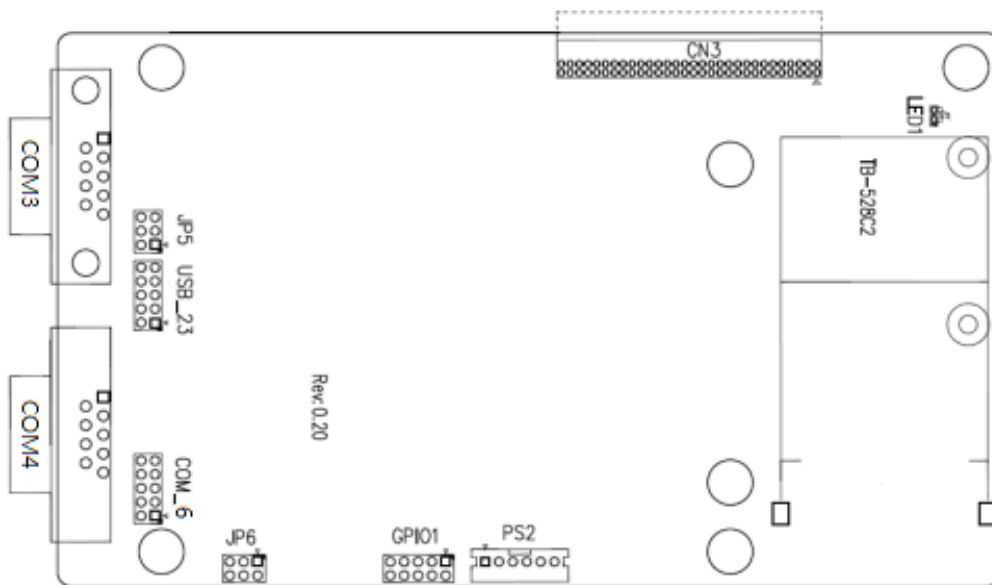

**CN3:**

(1.27mm Pitch 2 x 30 Pin Header), connect to SBC-7110 CN3 pin Header.

**LED1:**

Mini PCIe devices LED Status.

**PS2:**

(2.0mm Pitch 1x6 Pin Wafer), PS/2 keyboard and mouse port, the port can be connected to PS/2 keyboard or mouse via a dedicated cable for direct used.

Pin#	Signal Name
1	KBDATA
2	MSDATA
3	Ground
4	+5V
5	KBCLK

6	MSCLK
---	-------

**GPIO1:**

(2.0mm Pitch 2x5 Pin Header), General-purpose input/output port, it provides a group of self-programming interfaces to customers for flexible use.

Signal Name	Pin#	Pin#	Signal Name
Ground	1	2	NC
NC	3	4	SMB_DATA_R
SMB_CLK_R	5	6	PCH-GPIO56
PCH-GPIO57	7	8	PCH-GPIO59
PCH-GPIO58	9	10	+5V

**USB\_23:**

(2.0mm Pitch 2x5 Pin Header), Front USB connector, it provides one USB port via a dedicated USB cable, speed up to 480Mb/s.

Signal Name	Pin#	Pin#	Signal Name
5V_USB23	1	2	5V_USB23
USB4_N	3	4	USB3_N
USB4_P	5	6	USB3_P
Ground	7	8	Ground
NC	9	10	Ground



**Note:**

Before connection, make sure that pinout of the USB Cable is in accordance with that of the said tables. Any inconformity may cause system down and even hardware damages.

**JP5:**

(2.0mm Pitch 2x3 Pin Header), COM3 setting jumper, pin 1~6 are used to select signal out of pin 9 of COM3 port.

JP5 Pin#	Function
<b>Close 1-2</b>	<b>RI (Ring Indicator) (default)</b>
Close 3-4	COM3 Pin9=+5V (option)
Close 5-6	COM3 Pin9=+12V (option)

**COM5(SBC-7110/COM3):**

(Type DB9), serial port, standard DB9 serial port is provided to make a direct connection to serial devices. COM5 port is controlled by pins No.1~6 of **JP5**, select output Signal RI or 5V or 12v, for details, please refer to description of

JP5.

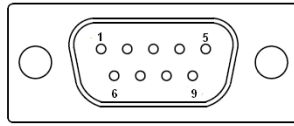

Pin#	Signal Name
1	DCD# (Data Carrier Detect)
2	RXD (Received Data)
3	TXD (Transmit Data)
4	DTR (Data Terminal Ready)
5	Ground
6	DSR (Data Set Ready)
7	RTS (Request To Send)
8	CTS (Clear To Send)
9	JP5 Setting: <b>Pin1-2: RI (Ring Indicator) (default)</b> Pin3-4: 5V Standby power (option) Pin5-6: 12V Standby power (option)

**COM6(SBC-7110/COM3):**

(Type DB9), serial port, standard DB9 serial port is provided to make a direct connection to serial devices. COM6 port is controlled by pins No.1~6 of **JP6**, select output Signal RI or 5V or 12v, for details, please refer to description of JP6.

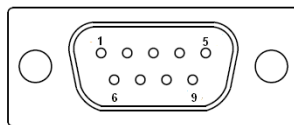

Pin#	Signal Name
1	DCD# (Data Carrier Detect)
2	RXD (Received Data)
3	TXD (Transmit Data)
4	DTR (Data Terminal Ready)
5	Ground
6	DSR (Data Set Ready)
7	RTS (Request To Send)
8	CTS (Clear To Send)
9	JP6 Setting: <b>Pin1-2: RI (Ring Indicator) (default)</b>

	Pin3-4: 5V Standby power (option)
	Pin5-6: 12V Standby power (option)

**COM\_6 (option, SBC-7110/COM3) :**

(2.0mm Pitch 2X5 Pin Header), COM6 Port, up to one standard RS232 port are provided. They can be used directly via COM cable connection.

Signal Name	Pin#	Pin#	Signal Name
DCD	1	2	RXD
TXD	3	4	DTR
Ground	5	6	DSR
RTS	7	8	CTS
JP6 Setting: RI/5V/12V	9	10	NC

**44. TB-528C1U2P1/TB-528C1U2 (option):**

SBC-7110 Riser Card, TB-528C1U2P1 CN3 connect to SBC-7110 CN3 pin Header.

TB-528C1U2P1 Top:

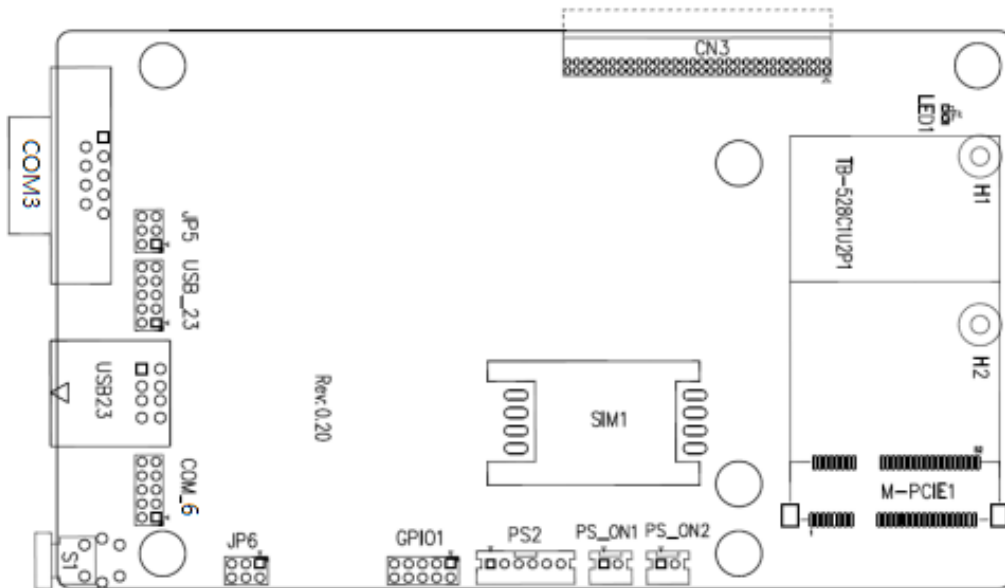

**CN3:**

(1.27mm Pitch 2X30 Pin Header), connect to SBC-7110 CN3 pin Header.

**M-PCIE1:**

(Socket 52Pin), mini PCIe socket, it is located at the top, it supports mini PCIe devices with Smbus, SIM and PCIe signal. MPCle card size is 30x30mm or

30x50.95mm.

Signal Name	Function support
PCIe 1X	Yes
USB2.0 (USB3)	<b>NC (option)</b>
SMBus	Yes
SIM	Yes

**H1/H2:**

MPCIE1 SCREW HOLES, H2 for mini PCIE card (30mmx30mm) assemble. H1 for mini PCIE card (30mmx50.95mm) assemble.

**LED1:**

Mini PCIe devices LED Status.

**SIM1 (option) :**

(SIM Socket 6 Pin), Support SIM Card devices.

**PS\_ON1:**

(2.0mm Pitch 1X2 Pin Wafer), ATX Power and Auto Power on jumper setting.

PS_ON	Mode
<b>Close 1-2</b>	<b>Auto Power on (Default)</b>
Open 1-2	ATX Power

**PS\_ON2 (option) :**

(2.0mm Pitch 1X2 Pin Wafer).

**PS2:**

(2.0mm Pitch 1X6 Pin Wafer), PS/2 keyboard and mouse port, the port can be connected to PS/2 keyboard or mouse via a dedicated cable for direct used.

Pin#	Signal Name
1	KBDATA
2	MSDATA
3	Ground
4	+5V
5	KBCLK
6	MSCLK

**GPIO1 :**

(2.0mm Pitch 2x5 Pin Header), General-purpose input/output port, it provides a group of self-programming interfaces to customers for flexible use.



Signal Name	Pin#	Pin#	Signal Name
Ground	1	2	NC
NC	3	4	SMB_DATA_R
SMB_CLK_R	5	6	PCH-GPIO56
PCH-GPIO57	7	8	PCH-GPIO59
PCH-GPIO58	9	10	+5V

**USB23(SBC-7110 USB3/USB4):**

(Double stack USB type A), Rear USB connector, it provides up to 2 USB2.0 ports, speed up to 480Mb/s.

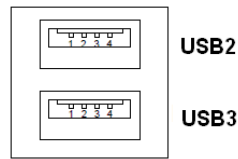

**USB\_23 (option) :**

(2.0mm Pitch 2x5 Pin Header), Front USB connector, it provides one USB port via a dedicated USB cable, speed up to 480Mb/s.

Signal Name	Pin#	Pin#	Signal Name
5V_USB23	1	2	5V_USB23
USB4_N	3	4	USB3_N
USB4_P	5	6	USB3_P
Ground	7	8	Ground
NC	9	10	Ground



**Note:**

Before connection, make sure that pinout of the USB Cable is in accordance with that of the said tables. Any inconformity may cause system down and even hardware damages.

**JP5:**

(2.0mm Pitch 2x3 Pin Header), COM3 setting jumper, pin 1~6 are used to select signal out of pin 9 of COM3 port.

JP5 Pin#	Function
<b>Close 1-2</b>	<b>RI (Ring Indicator) (default)</b>
Close 3-4	COM3 Pin9: +5V (option)

Close 5-6	COM3 Pin9: +12V (option)
-----------	--------------------------

**COM5(SBC-7110/COM3):**

(Type DB9), serial port, standard DB9 serial port is provided to make a direct connection to serial devices. COM5 port is controlled by pins No.1~6 of **JP5**, select output Signal RI or 5V or 12v, for details, please refer to description of JP5.

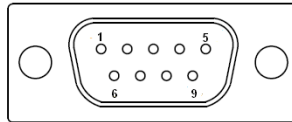

Pin#	Signal Name
1	DCD# (Data Carrier Detect)
2	RXD (Received Data)
3	TXD (Transmit Data)
4	DTR (Data Terminal Ready)
5	Ground
6	DSR (Data Set Ready)
7	RTS (Request To Send)
8	CTS (Clear To Send)
9	JP5 Setting: <b>Pin1-2: RI (Ring Indicator) (default)</b> Pin3-4: 5V Standby power (option) Pin5-6: 12V Standby power (option)

**JP6:**

(2.0mm Pitch 2x3 Pin Header), COM\_6 setting jumper, pin 1~6 are used to select signal out of pin 9 of COM\_6 port.

JP6 Pin#	Function
<b>Close 1-2</b>	<b>RI (Ring Indicator) (default)</b>
Close 3-4	COM_6 Pin9: +5V (option)
Close 5-6	COM_6 Pin9: +12V (option)

**COM6(SBC-7110/COM4):**

(Type DB9), serial port, standard DB9 serial port is provided to make a direct connection to serial devices. COM6 port is controlled by pins No. 1~6 of **JP6**, select output Signal RI or 5V or 12V, for details, please refer to description of JP6

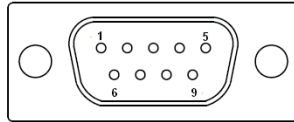

Pin#	Signal Name
1	DCD# (Data Carrier Detect)
2	RXD (Received Data)
3	TXD (Transmit Data)
4	DTR (Data Terminal Ready)
5	Ground
6	DSR (Data Set Ready)
7	RTS (Request To Send)
8	CTS (Clear To Send)
9	JP6 Setting: <b>Pin1-2: RI (Ring Indicator) (default)</b> Pin3-4: 5V Standby power (option) Pin5-6: 12V Standby power (option)

**S1:**

**PWR BT: POWER on/off Button**, They are used to connect power switch button. The two pins are disconnected under normal condition. You may short them temporarily to realize system startup & shutdown or awaken the system from sleep state.

**PWR LED: POWER LED status.**

S1	Model
Yes	TB-528C1U2P1
No	TB-528C1U2

**45. TB -528CAN2 R0.10 (option)**

SBC-7110 Riser Card, TB-528CAN2 CN3 connect to SBC-7110 CN3 pin Header.

It provides two CAN-bus Interface. TB-528CAN2 Top:

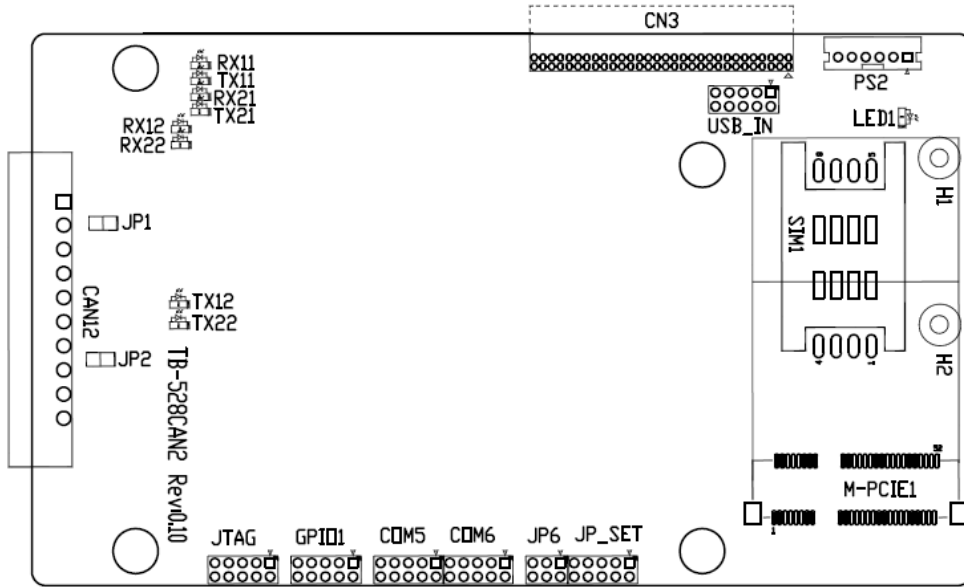

**CN3:**

(1.27mm Pitch 2X30 Pin Header), connect to SBC-7110 CN3 pin Header.

**M-PCIE1:**

(Socket 52Pin), mini PCIe socket, it is located at the top, it supports mini PCIe devices with Smbus, USB2.0,SIM and PCIe signal. MPCie card size is 30x30mm or 30x50.95mm.

Signal Name	Function support
PCIe 1X	Yes
USB2.0 (USB2)	Yes
SMBus	Yes
SIM	Yes

**H1/H2:**

MPCIE1 SCREW HOLES, H2 for mini PCIE card (30mmx30mm) assemble. H1 for mini PCIE card (30mmx50.95mm) assemble.

**LED1 :**

Mini PCIe devices LED Status.

**SIM1 (option) :**

(SIM Socket 6 Pin), Support SIM Card devices.

**PS2 :**

(2.0mm Pitch 1X6 Pin Wafer), PS/2 keyboard and mouse port, the port can be connected to PS/2 keyboard or mouse via a dedicated cable for direct used.

Pin#	Signal Name
1	KBDATA
2	MSDATA
3	Ground
4	+5V
5	KBCLK
6	MSCLK

**USB\_IN (option) :**

(2.0mm Pitch 2x5 Pin Header) ,Front USB connector, it provides two USB port via a dedicated USB cable, speed up to 480Mb/s.

Signal Name	Pin#	Pin#	Signal Name
5V_USB34	1	2	5V_USB34
NC (USB4_N)	3	4	NC (USB3_N)
NC (USB4_P)	5	6	NC (USB3_P)
Ground	7	8	Ground
NC	9	10	Ground



**Note:**

Before connection, make sure that pinout of the USB Cable is in accordance with that of the said tables. Any inconformity may cause system down and even hardware damages.

**JP\_SET (option) :**

(2.0mm Pitch 2x5 Pin Header).

Signal Name	Pin#	Pin#	Signal Name
3P3V_S5_USB	1	2	3P3V_S5
3P3V_S5_USB	3	4	3P3V_S5
3P3V_S5_USB	5	6	3P3V_S5
PSON_ATX	7	8	Ground
PSON_ATX	9	10	Ground

**JP6:**

(2.0mm Pitch 2x3 Pin Header), COM6 setting jumper, pin 1~6 are used to select signal out of pin 9 of COM4 port.

JP6 Pin#	Function
Close 1-2	RI (Ring Indicator) (default)

Close 3-4	COM4 Pin9: +5V (option)
Close 5-6	COM4 Pin9: +12V (option)

**COM6(SBC-7110/COM4):**

(2.0mm Pitch 2X5 Pin Header), COM6 Port, up to one standard RS232 port are provided. They can be used directly via COM cable connection.

Signal Name	Pin#	Pin#	Signal Name
DCD	1	2	RXD
TXD	3	4	DTR
Ground	5	6	DSR
RTS	7	8	CTS
JP6 Setting: RI/5V/12V	9	10	NC

**COM5(SBC-7110/COM3):**

(2.0mm Pitch 2X5 Pin Header), COM5 Port, up to one standard RS232 port are provided. They can be used directly via COM cable connection.

Signal Name	Pin#	Pin#	Signal Name
DCD	1	2	RXD
TXD	3	4	DTR
Ground	5	6	DSR
RTS	7	8	CTS
RI	9	10	NC

**GPIO1:**

(2.0mm Pitch 2x5 Pin Header), General-purpose input/output port, it provides a group of self-programming interfaces to customers for flexible use.

Signal Name	Pin#	Pin#	Signal Name
Ground	1	2	NC
NC	3	4	SMB_DATA_R
SMB_CLK_R	5	6	PCH-GPIO56
PCH-GPIO57	7	8	PCH-GPIO59
PCH-GPIO58	9	10	+5V

**JTAG:**

(2.0mm Pitch 2x5 Pin Header), Reserve.

**JP1:**

(2.0mm Pitch 1x2 Pin Header), Reserve.

**JP2:**

(2.0mm Pitch 1x2 Pin Header), Reserve.

**CAN1/CAN2:**

(3.5mm Pitch 1x10 Pin connector), it provides two CAN-bus Interface.

Pin#	Channel	Signal Name	Function
1	CAN2	CANL2	CAN bus Signal L
2		R2-	Terminal resistor R-(internally connected to CANL2)
3		FG	Shield cable (FG)
4		R2+	Terminal resistor R+(internally connected to CANH2)
5		CANH2	CAN bus Signal H
6	CAN1	CANL1	CAN bus Signal L
7		R1-	Terminal resistor R-(internally connected to CANL1)
8		FG	Shield cable (FG)
9		R1+	Terminal resistor R+(internally connected to CANH1)
10		CANH1	CAN bus Signal H

【See TB-528AN2 Manual】

**46. TB-528U2 (option)**

SBC-7110 Riser Card, TB-528U2 CN3 connect to SBC-7110 CN3 pin Header.

TB-528U2 Top:

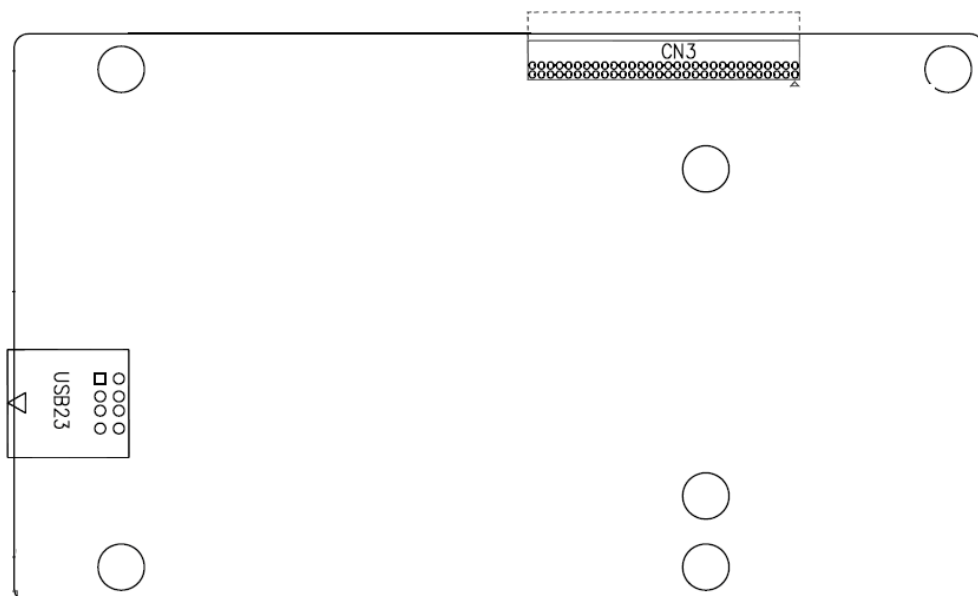

**CN3:**

(1.27mm Pitch 2X30 Pin Header), connect to SBC-7110 CN3 pin Header.

**USB23(SBC-7110 USB3/USB4):**

(Double stack USB type A), Rear USB connector, it provides up to 2 USB2.0 ports, speed up to 480Mb/s.

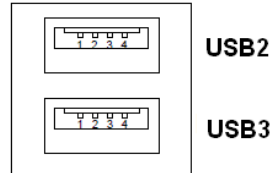



## 3.1 Operations after POST Screen

After CMOS discharge or BIOS flashing operation, press [Delete] key to enter CMOS Setup.

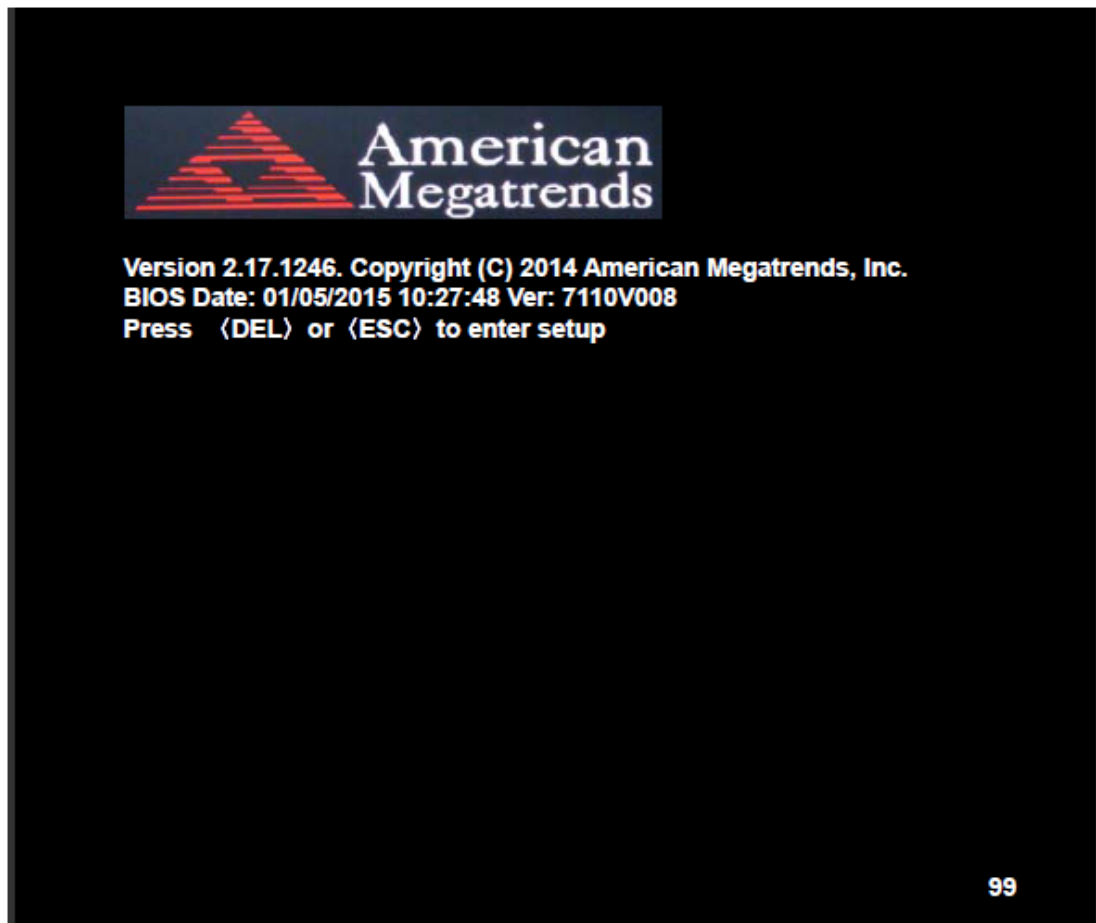

After optimizing and exiting CMOS Setup, the POST screen displayed for the first time is as follows and includes basic information on BIOS, CPU, memory, and storage devices.

## 3.2 BIOS Setup Utility

Press [Delete] key to enter BIOS Setup utility during POST, and then a main menu containing system summary information will appear.

### 3.3 Main Settings

Aptio Setup Utility – Copyright (C) 2015 American Megatrends, Inc.					
Main	Advanced	Chipset	Security	Boot	Save & Exit
BIOS Information					Choose the system default
BIOS Vendor	American Megatrends				Language
Core Version	4.6.5.4				
Compliancy	UEFI 2.3.1; PI 1.2				
Project Version	7110V 0.08 x64				
Build Date and Time	01/05/2015 10:27:48				
System Language	[English]				
System Date	[Thu 01/01/2009]				
System Time	[00:00:18]				
Access Level	Administrator				
					→←: Select Screen ↑↓ : Select Item Enter: Select +/- : Change Opt. F1 : General Help F2: Previous Values F3:Optimized Defaults F4:Save and Exit ESC Exit
Version 2.17.1246. Copyright (C) 2015 American Megatrends , Inc.					

#### System Time:

Set the system time, the time format is:

Hour : 0 to 23

Minute : 0 to 59

Second : 0 to 59

#### System Date:

Set the system date, the date format is:

**Day:** Note that the 'Day' automatically changes when you set the date.

**Month:** 01 to 12

**Date:** 01 to 31

**Year:** 1998 to 2099

## 3.4 Advanced Settings

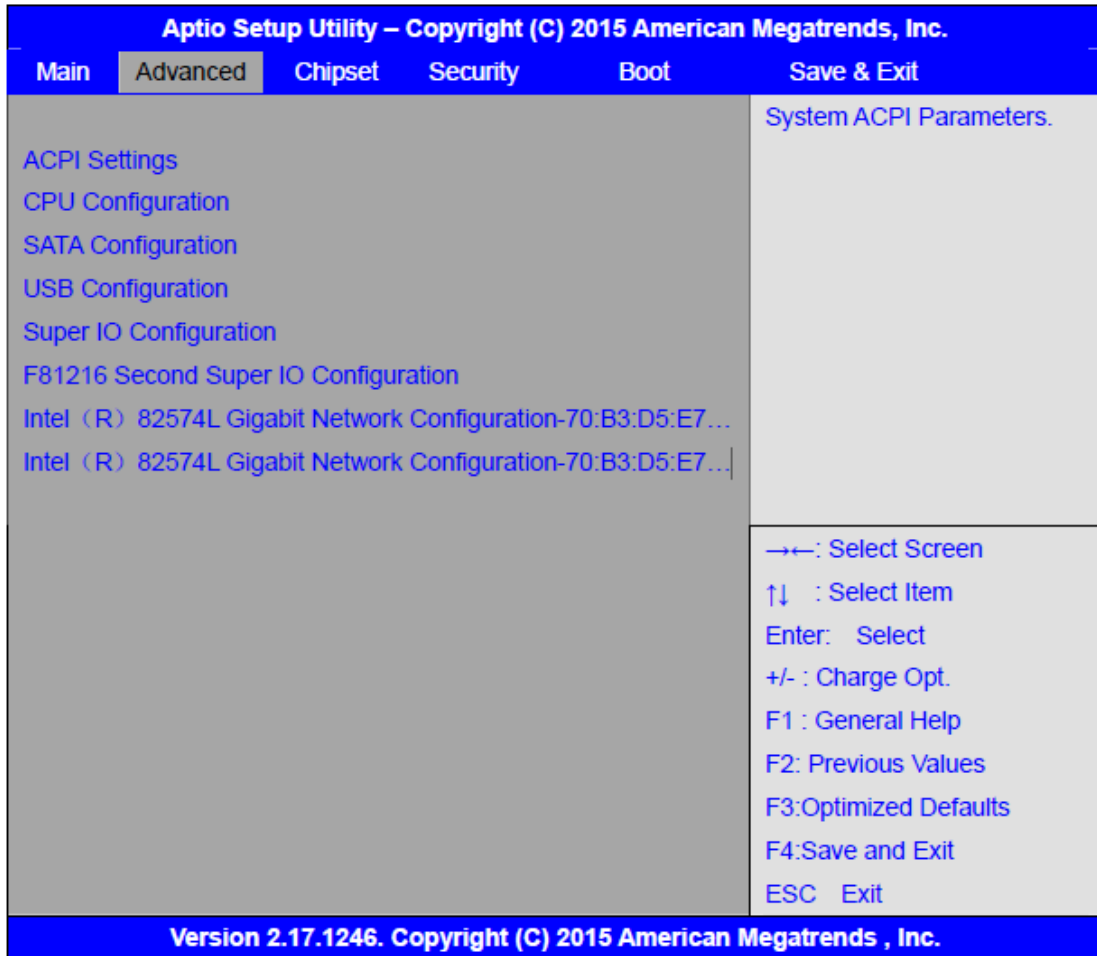

### 3.4.1 ACPI Settings

**Enable ACPI Auto Conf:**

**[Disabled]**

[Enabled]

**Enable Hibernation:**

**[Enabled]**

[Disabled]

**ACPI Sleep State:**

**[S1 only (CPU Stop Clock) ]**

[S3 (Suspend to RAM)]

[Suspend Disabled]

[Both S1 and S3 available for OS to choose from]

**Lock Legacy Resources:**

**[Disabled]**

[Enabled]

### S3 Video Repost:

[Disabled]

[Enabled]

### ACPI Low Power SO Idle:

[Disabled]

[Enabled]

### 3.4.2 CPU Configuration

Intel(R) Core(TM) i5-4310U @ 2.00GHz

CPU Signature 40651

Processor Family 6

Microcode Patch 17

FSB Speed 100 MHz

Max CPU Speed 2000 MHz

Mix CPU Speed 800 MHz

CPU Speed 2400 MHz

Processor Cores 2

Intel HT Technology Supported

Intel HT-X Technology Supported

Intel SMX Technology Supported

64-bit Supported

EIST Technology Supported

CPU C3 State Supported

CPU C6 State Supported

CPU C7 State Supported

L1 Data Cache 32KB x 2

L1 Code Cache 32KB x 2

L2 Cache 256KB x 2

L3 Cache 3072KB

Hyper-threading [Enabled]

Active Processor Cores [Enabled]

Overclocking lock [All]

Limit CPUID Maximum [Disabled]

Execute Disabled Bit [Enabled]

Intel Virtualization Technology [Enabled]

Hardware Prefetcher [Enabled]

Asjacent Cache Line Prefetch [Enabled]

CPU AES [Enabled]

Boot Performance mode [Turbo Performance]

EIST	[Enabled]
Turbo Mode	[Enabled]
.....	

### 3.4.3 SATA Configuration

SATA Configuration(S)	<b>[Enabled]</b>
	[Disabled]
SATA Mode Selection	[AHCI]
	[RAID]
SATA Test Mode	<b>[Disabled]</b>
	[Enabled]
Aggressive LPM Support	[Enabled]
	<b>[Disabled]</b>
SATA Controller Speed	[Default]
	[Gen1]
	[Gen2]
	[Gen3]
Software Feature Mask Configuration	
Serial ATA Port 0	Empty
Software Preserve	Unknown
Serial ATA Port 1	Empty
Software Preserve	Unknown
.....	

### 3.4.4 USB Configuration

USB Configuration	
USB Module Version	8.10.31
USB Devices:	
1 Keyboard, 1 Mouse, 1 Hubs	
Legacy USB Support:	

	[Enabled]
	[Disabled]
XHCI Hand-off:	
	[Enabled]
	[Disabled]
EHCI Hand-off:	
	[Disabled]
	[Enabled]
USB Mass Storage Driver Support	
	[Enabled]
	[Disabled]
USB hardware delays and time-outs:	
USB transfer time-out:	
	[20 sec]
	[10 sec]
	[5 sec]
	[1 sec]
Device reset time-out:	
	[20 sec]
	[10 sec]
	[30 sec]
	[40 sec]
Device power-up delay	
	[Auto]
	[Manual]

### 3.4.5 Super IO Configuration

Super IO chip	IT8518/IT8519
Serial Port 0 Configuration	(COM5)
Device Mode Selection:	
	[RS-485]
	[RS-422]
Serial Port 1 Configuration	(COM6)
Device Mode Selection:	
	[RS-485]
	[RS-422]

### 3.4.6 F81216 Second Super IO Configuration

Super IO chip F81216 Second IO

Serial Port 0 Configuration

UART1 Mode Selection:

[RS-232]

[RS-485]

[RS-422]

Serial Port 1 Configuration

Change Settings [Auto]

Serial Port 2 Configuration

Change Settings [Auto]

Serial Port 3 Configuration

Change Settings [Auto]

### 3.4.7 Intel (R) 82574L Gigabit Network Configuration-70:B3:D5:E7

### 3.4.8 Intel (R) 82574L Gigabit Network Configuration-70:B3:D5:E7

## 3.5 Chipset Settings

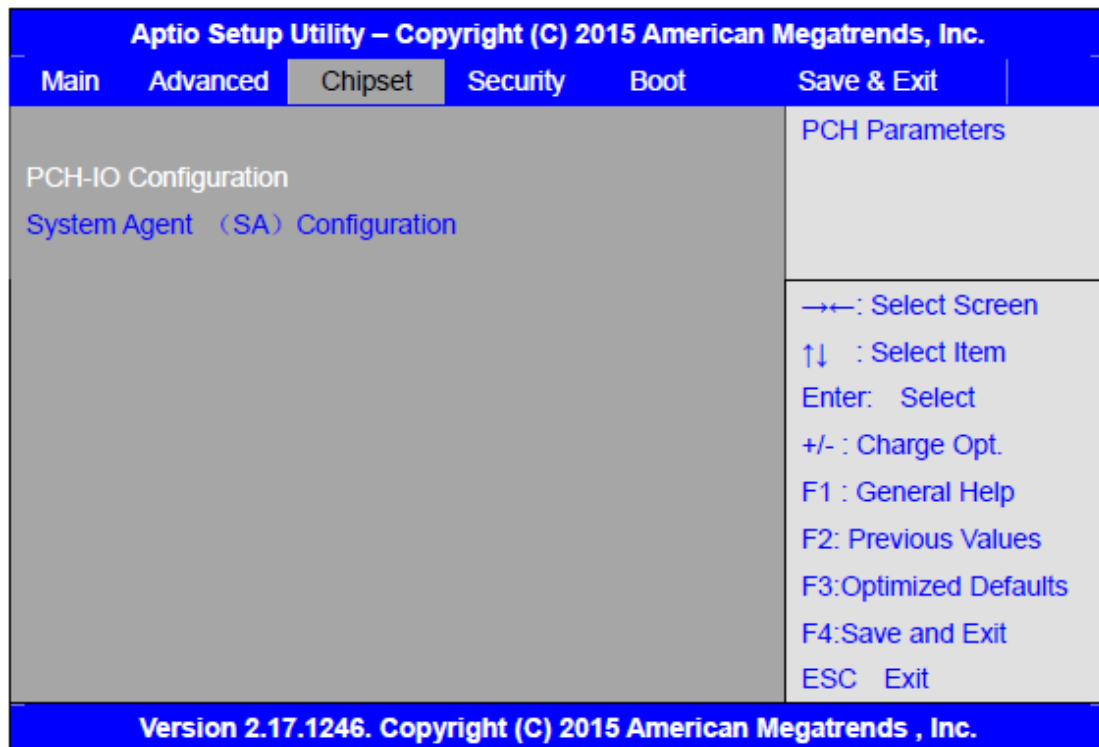

### 3.5.1 PCH-IO Configuration

Intel PCH RC Version	1.8.0.0
Intel PCH SKU Name	Premium SKU
Intel PCH Rev ID	04/B2

#### PCH Express Configuration

PCI Express Clock Gating	[Enabled]
DMI Link ASPM Control	[Enabled]
DMI Link Extended Synch Control	[Disabled]
PCIe-USB Glitch W/A	[Disabled]
PCIe Root Port Function Swapping	[Disabled]
Subtractive Decode	[Disabled]
PCI Express Root Port 1	
PCI Express Root Port 2	
PCI Express Root Port 3	
PCI Express Root Port 4	
PCI Express Root Port 5	
PCI Express Root Port 6	

#### USB Configuration

USB Precondition	[Disabled]
XHCI Mode	
XHCI Idle L1	
BTCG	
USB Ports Per-Port Disabled Control	[Disabled]
Restore AC Power Loss	[Power off]



## 3.6 Boot Settings

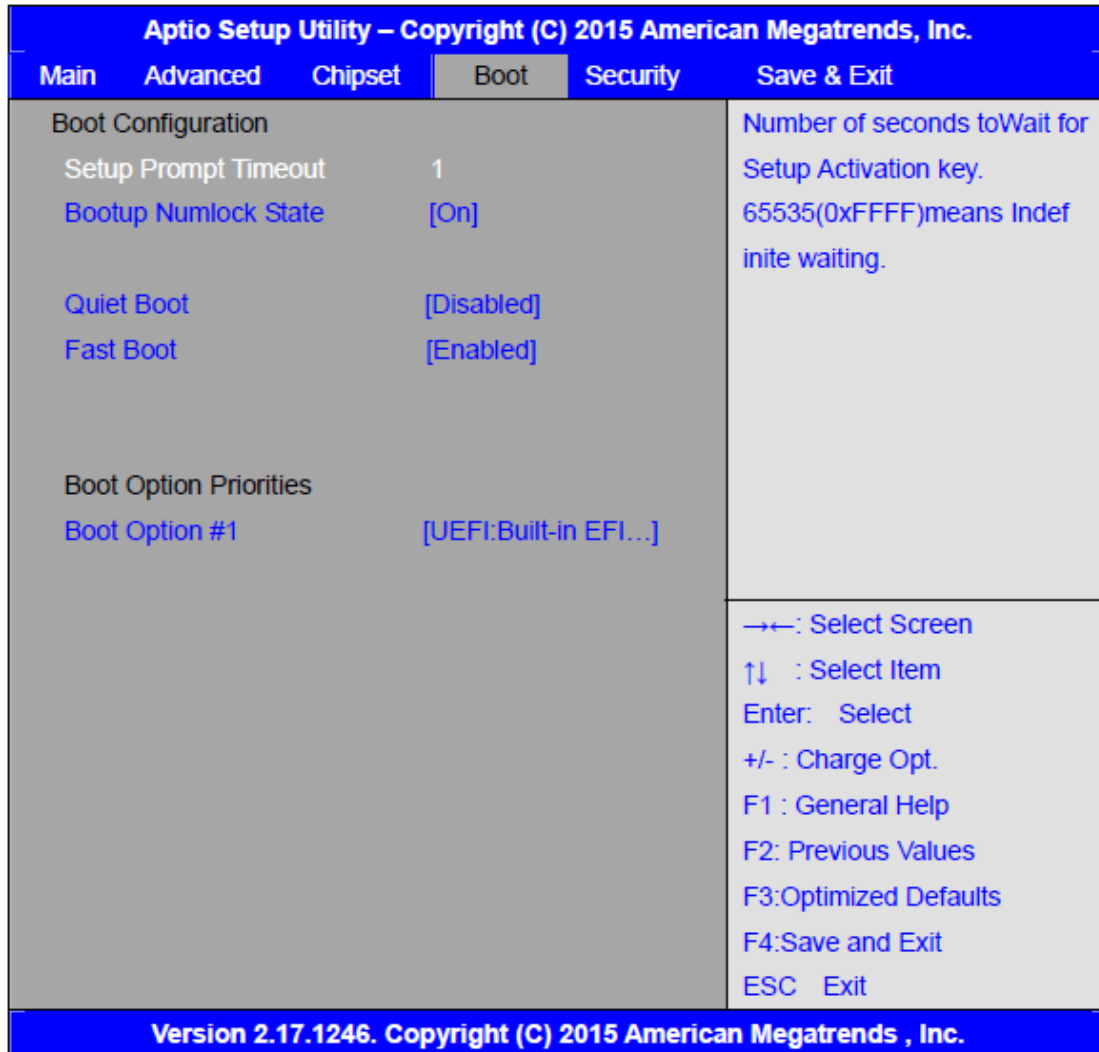

### 3.6.1 Administrator Password



### 3.6.2 User Password



Type the password with up to 20 characters and then press **<Enter>** key. This will clear all previously typed CMOS passwords. You will be requested to confirm the password. Type the password again and press **<Enter>** key. You may press **<Esc>** key to abandon password entry operation.

To clear the password, just press **<Enter>** key when password input window pops

up. A confirmation message will be shown on the screen as to whether the password will be disabled. You will have direct access to BIOS setup without typing any password after system reboot once the password is disabled.

Once the password feature is used, you will be requested to type the password each time you enter BIOS setup. This will prevent unauthorized persons from changing your system configurations.

Also, the feature is capable of requesting users to enter the password prior to system boot to control unauthorized access to your computer. Users may enable the feature in Security Option of Advanced BIOS Features. If Security Option is set to System, you will be requested to enter the password before system boot and when entering BIOS setup; if Security Option is set to Setup, you will be requested for password for entering BIOS setup.

### 3.7 Security Settings

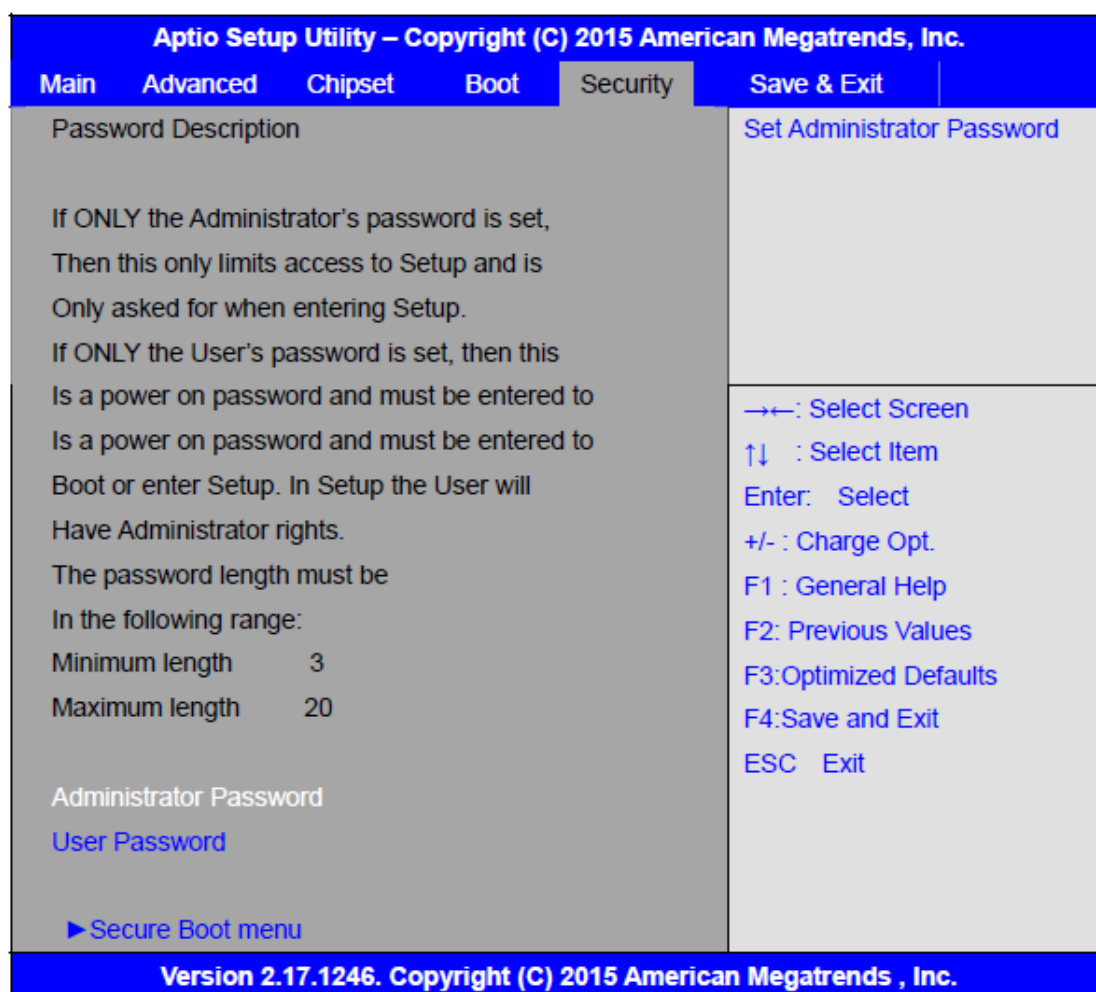

Setup Prompt Timeout [1]  
 Bootup Numlock State

	[On]
	[off]
Quiet Boot	[Disabled]
	[Enabled]
Fast Boot	[Disabled]
	[Enabled]
Boot Option Priorities	
Boot Option #1	Sets the system boot order
Hard Drive BBS Priorities	[SATA PM:*** ... ]
	Boot Option #1
	SATA PM:***...
	*****
	Disabled

### 3.8 Save & Exit Settings

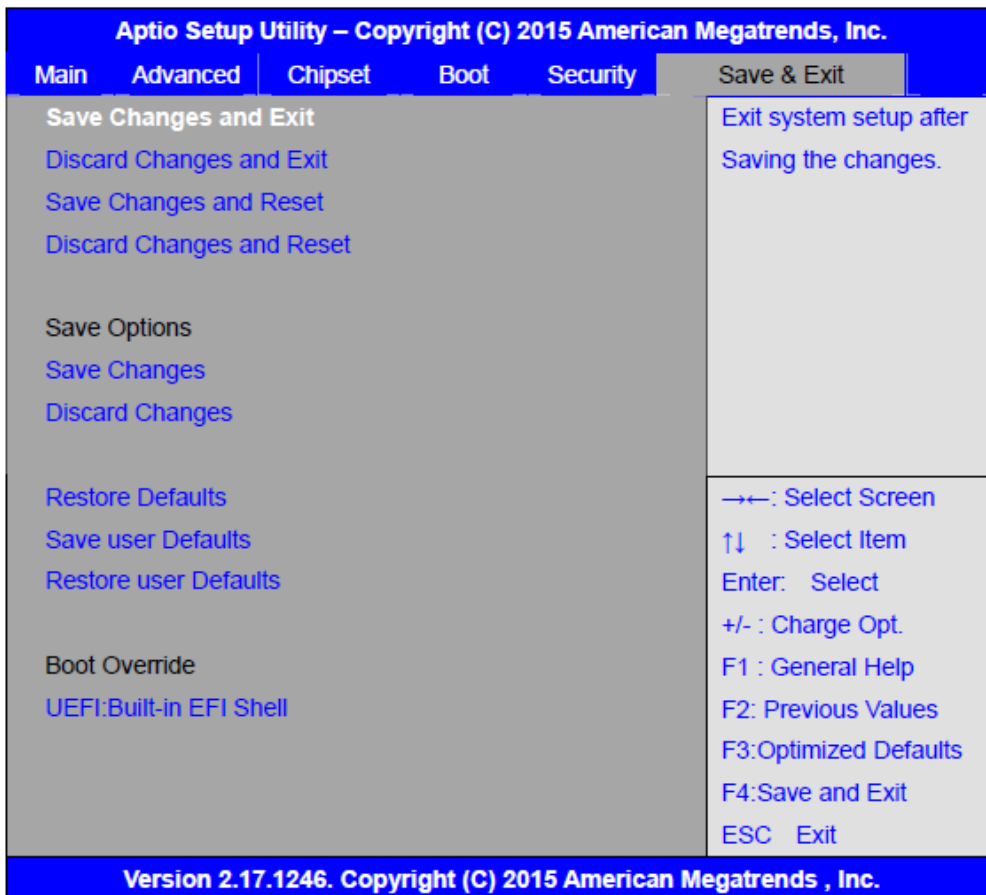

Save Changes and Exit	
Save & Exit Setup save Configuration and exit ?	[Yes]
	[No]
Discard Changes and Ext	
Exit Without Saving Quit without saving?	[Yes]
	[No]
Save Changes and Reset	
Save & reset Save Configuration and reset?	[Yes]
	[No]
Discard Changes and Reset	
Reset Without Saving Reset without saving?	[Yes]
	[No]
Save Changes	
Save Setup Values Save configuration?	[Yes]
	[No]
Discard Changes	
Load Previous Values Load Previous Values?	[Yes]
	[No]
Restore Defaults	
Load Optimized Defaults Load optimized Defaults?	[Yes]
	[No]
Save user Defaults	
Save Values as User Defaults Save configuration?	[Yes]
	[No]
Restore user Defaults	
Restore User Defaults Restore User Defaults?	[Yes]
	[No]

# Chapter 4 Installation of Drivers

This chapter describes the installation procedures for software and drivers under the windows 7. The software and drivers are included with the motherboard. The contents include **Intel CORE TM SoC chipset driver, VGA driver, LAN drivers, Audio driver, USB 3.0 Driver, Intel® MEI Driver** Installation instructions are given below.

**Important Note:**

After installing your Windows operating system, you must install first the Intel Chipset Software Installation Utility before proceeding with the installation of drivers.



## 4.1 Intel(R) CORE TM SoC Chipset

To install the Intel chipset driver, please follow the steps below.

**Step 1.** Select Intel (R) CORE TM SoC Chipset from the list



**Step 2.** Click **Next** to setup program.

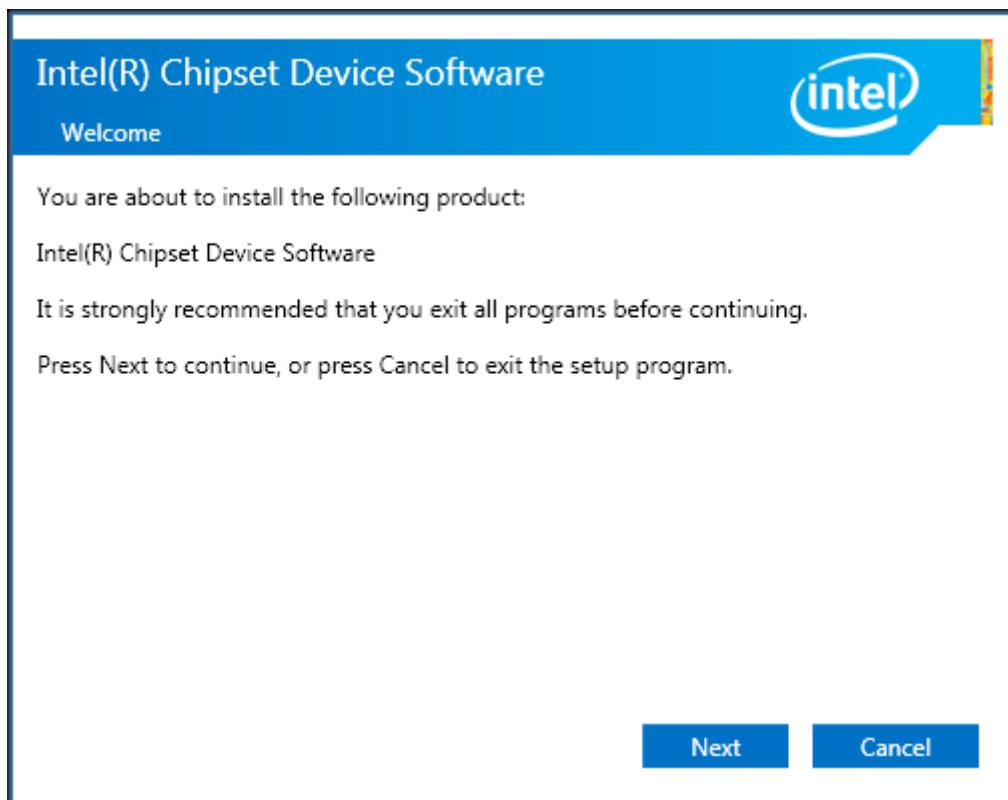

**Step 3.** Read the license agreement. Click **Accept** to accept all of the terms of the license agreement.

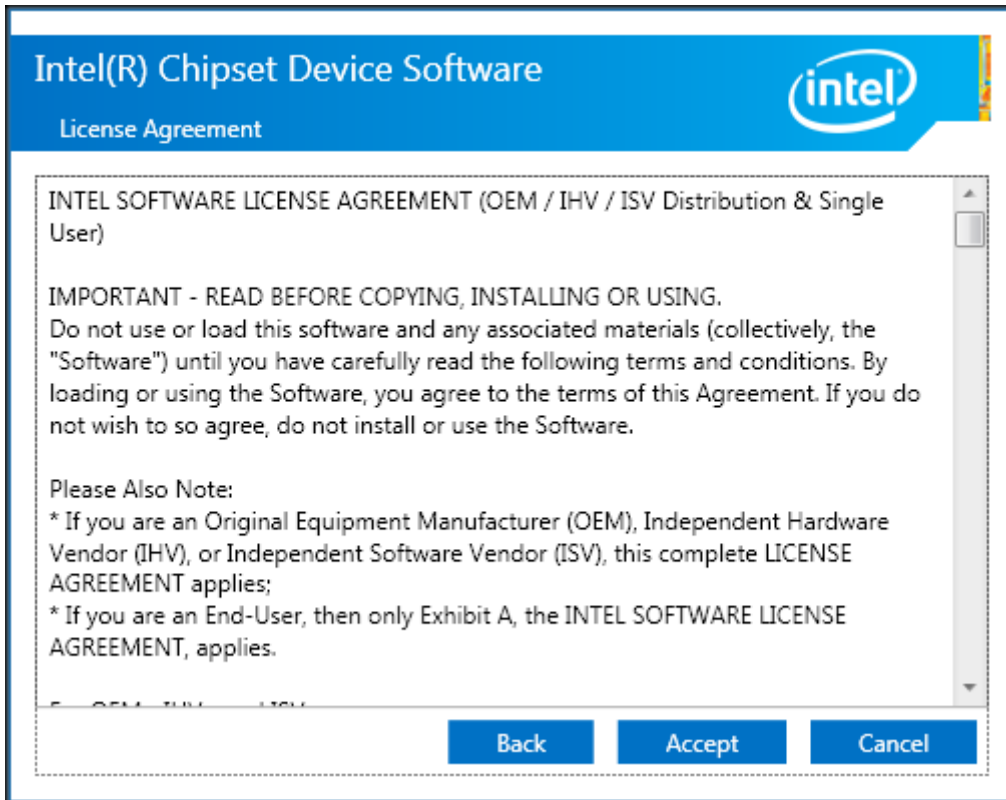

**Step 4.** Click **Install** to begin the installation.

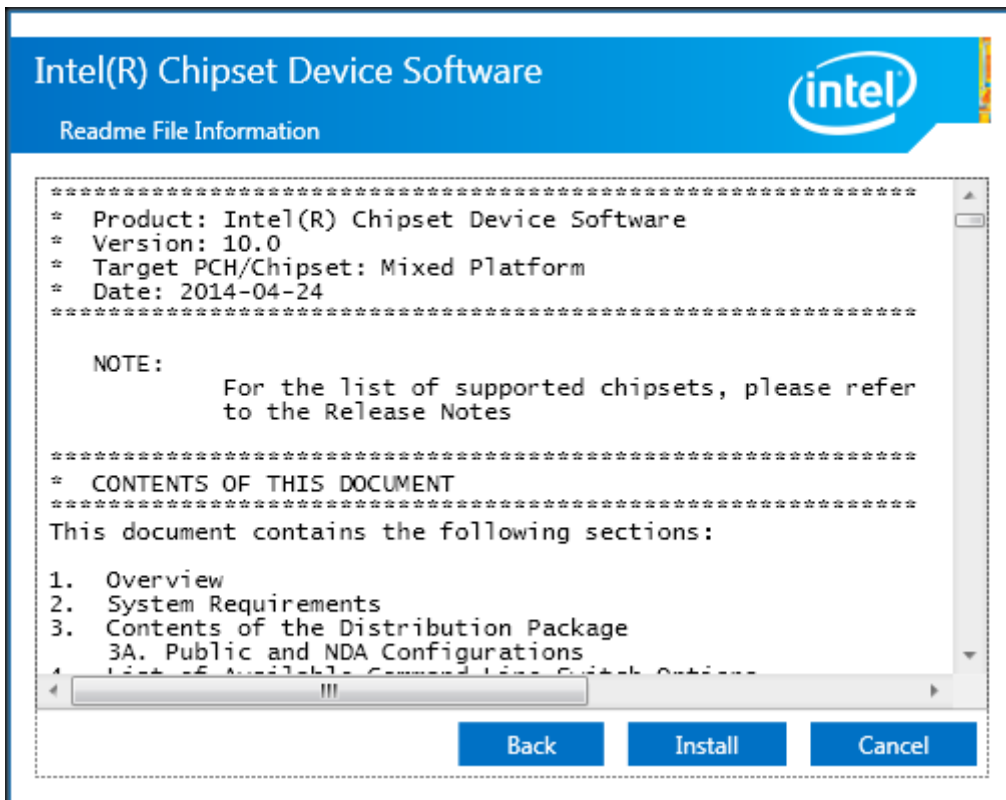

**Step 5.** Click **Finish** to complete the setup process.

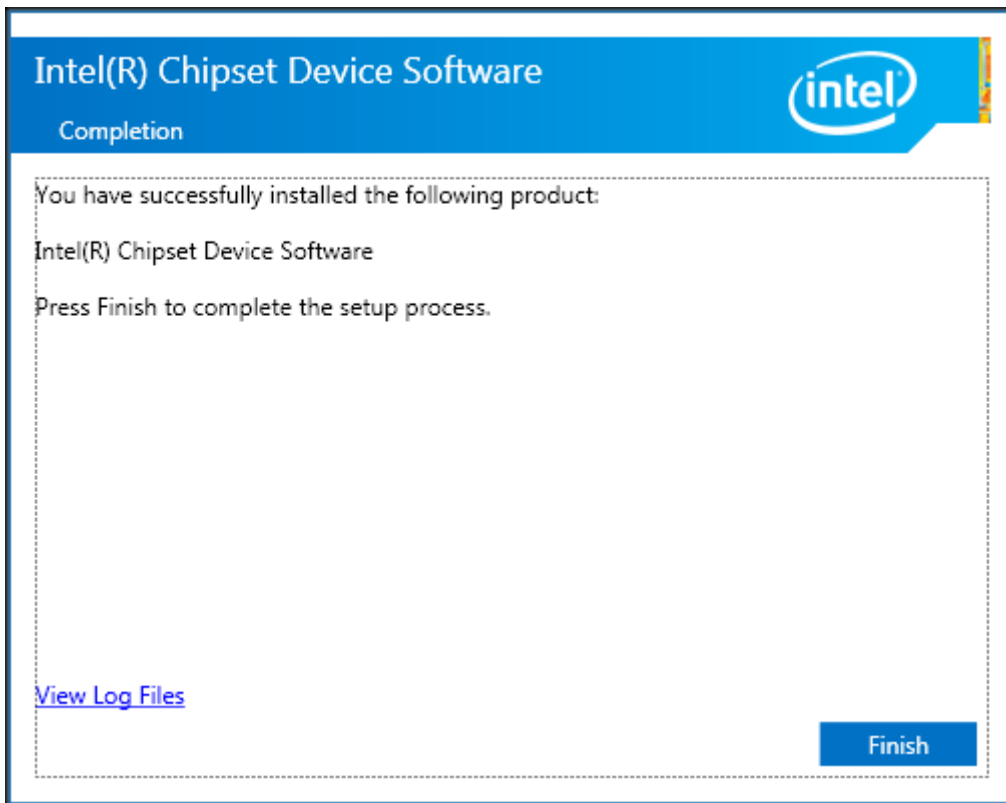

## 4.2 Intel(R) VGA Chipset

To install the VGA drivers, follow the steps below to proceed with the installation.

**Step 1.** Select **Intel(R) VGA Chipset** from the list.





**Step 2.** Click **Automatically run WinSAT and enable the Windows Aero desktop theme(if supported).** Click **Next.**

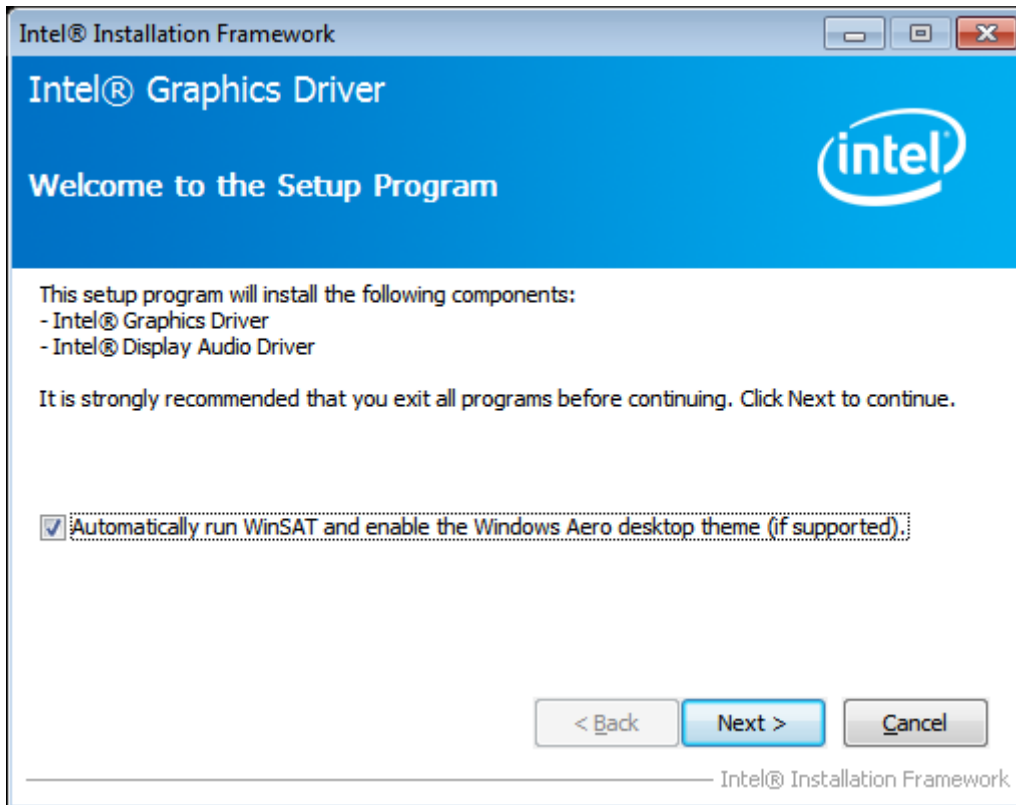

**Step 3.** Read license agreement. Click **Yes.**

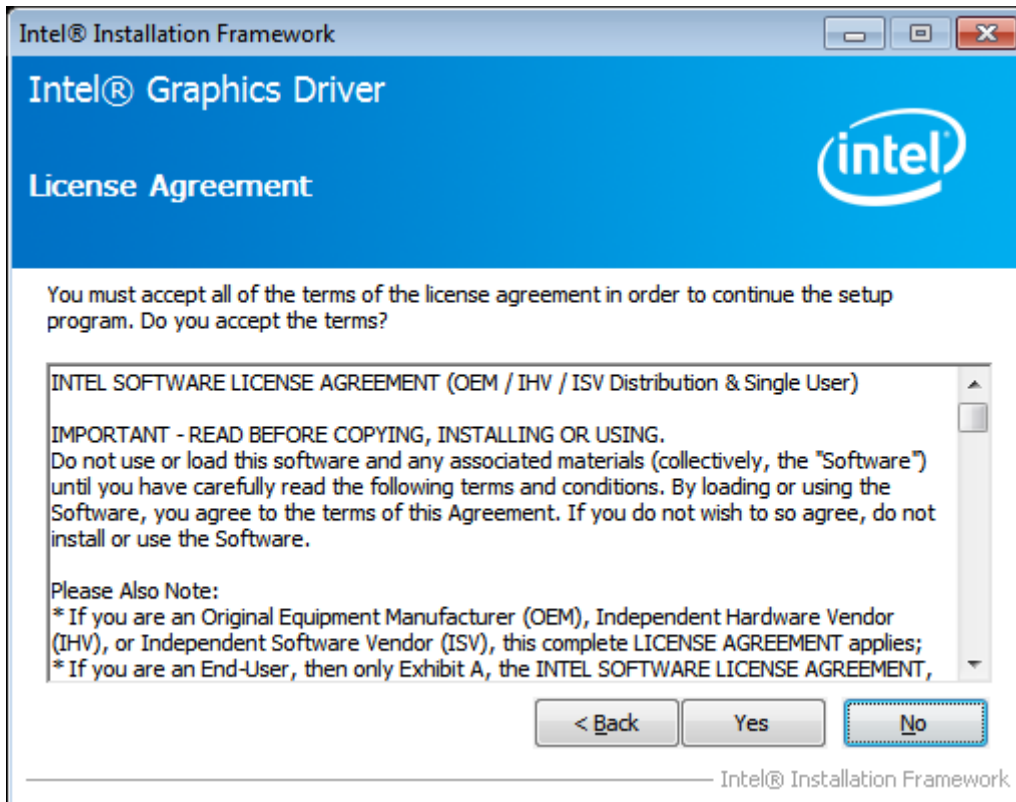

**Step 4.** Click **Next** to continue.

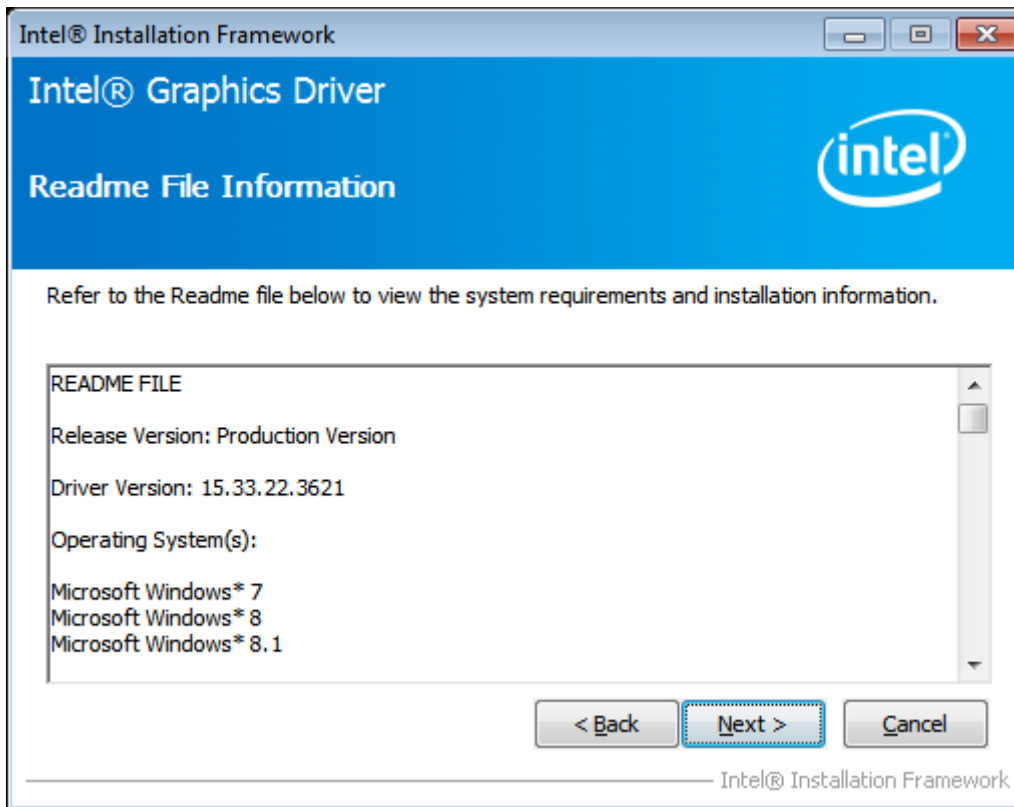

**Step 5.** Click **Next** to continue.

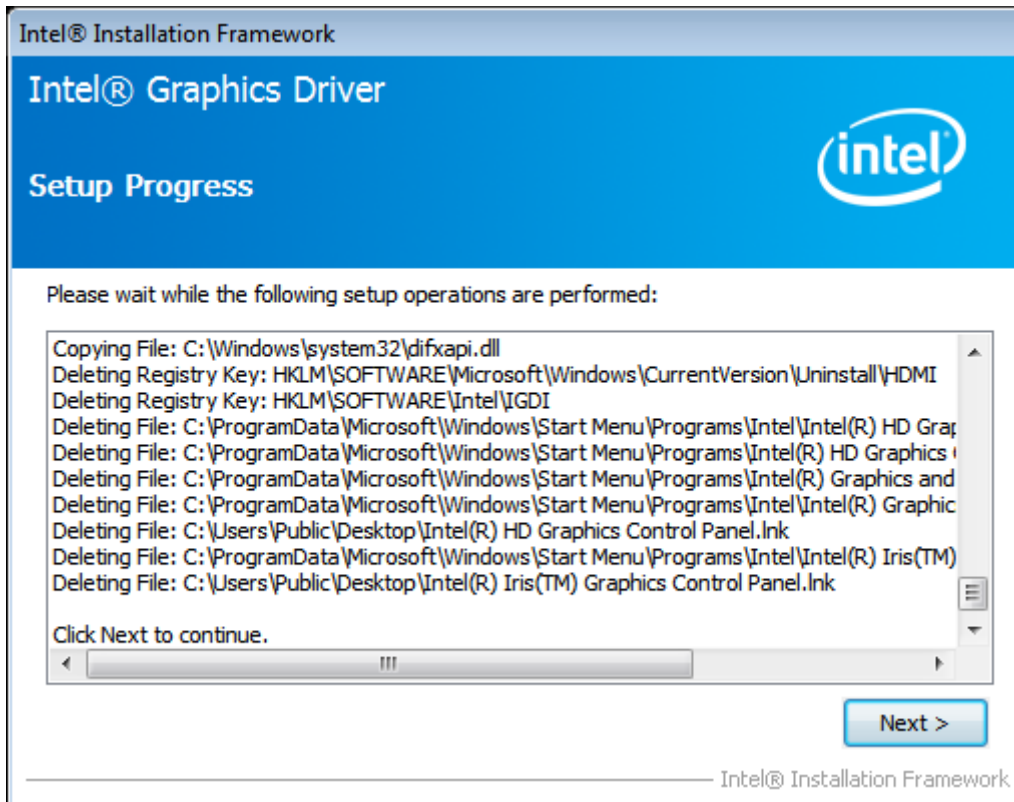

**Step 6.** Select **Yes, I want to restart this computer now.** Then click **Finish** to complete the installation.

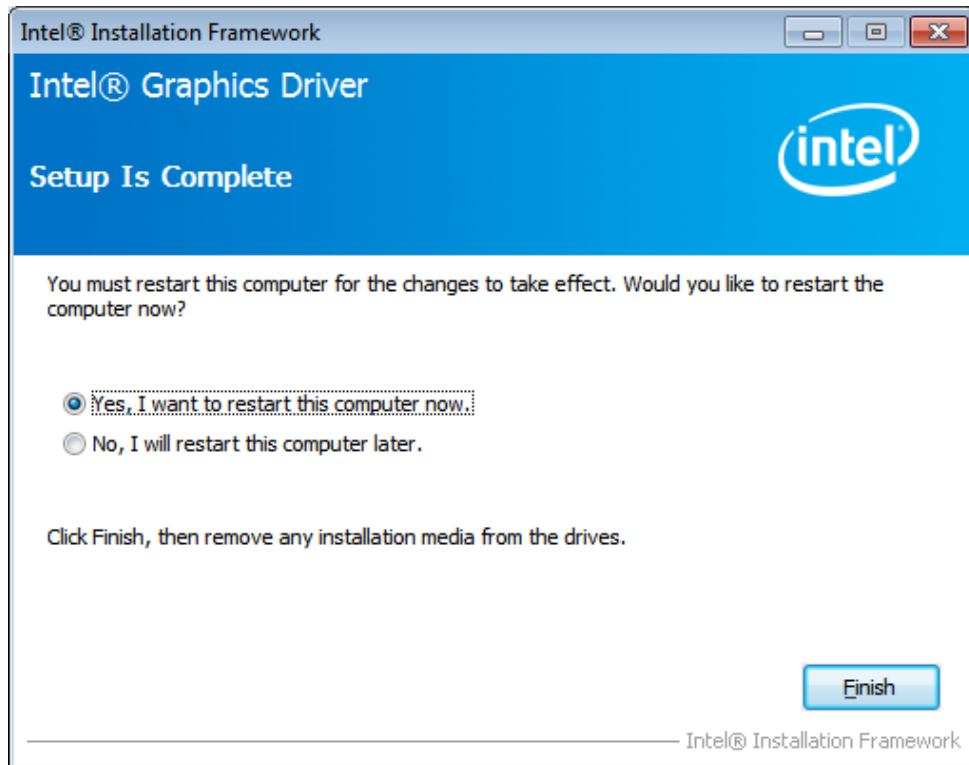

### 4.3 Intel(R) LAN Driver

To install the Intel (R) LAN driver, please follow the steps below.

**Step 1.** Select **Intel(R) 82574L LAN Driver** from the list.



**Step 2.** . Click **Next**.

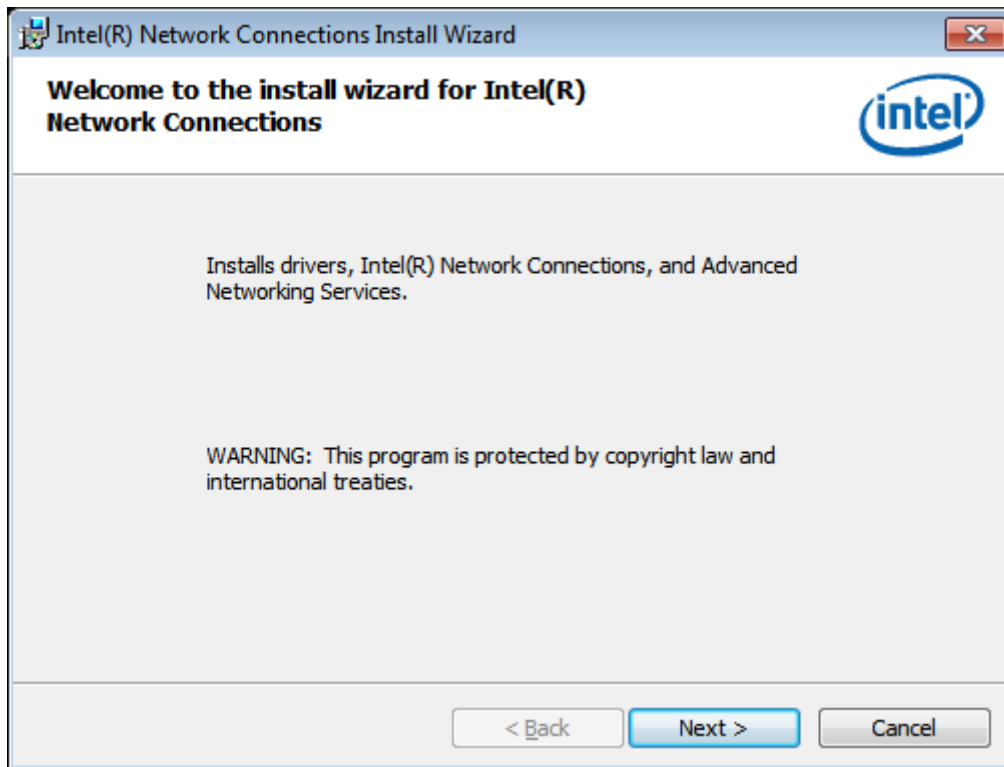

**Step 3.** Read license agreement. Click **I accept the terms in the license agreement**.  
Click **Next**.

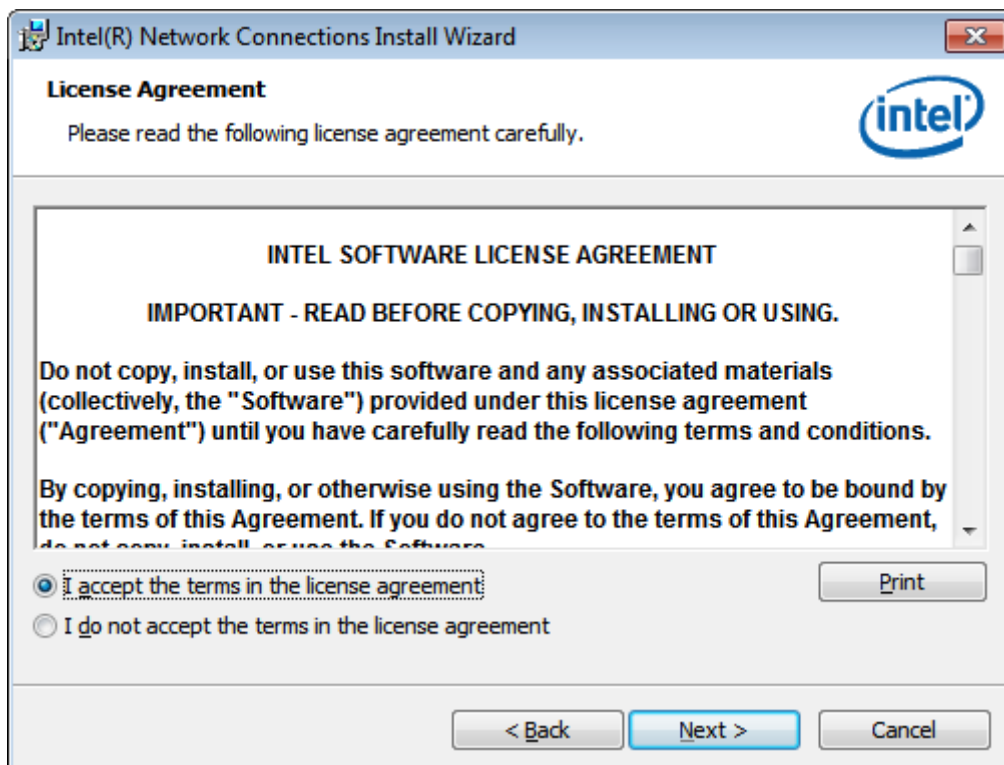

**Step 4.** Click **Next** to continue.

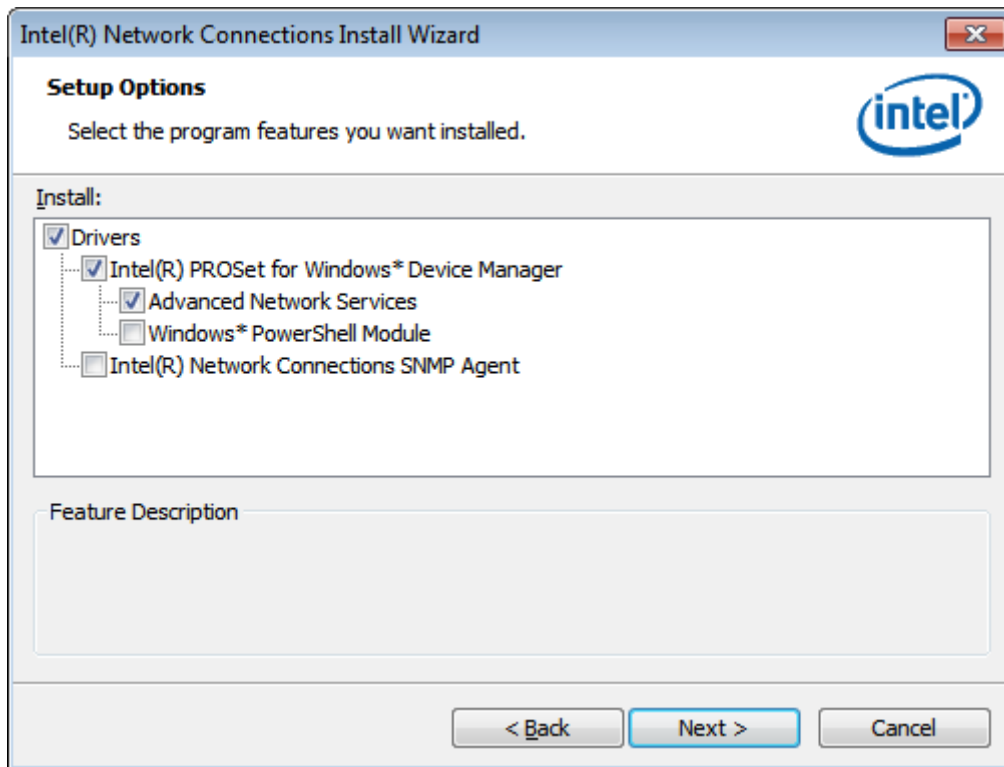

**Step 5.** Click **Install** to begin the installation.

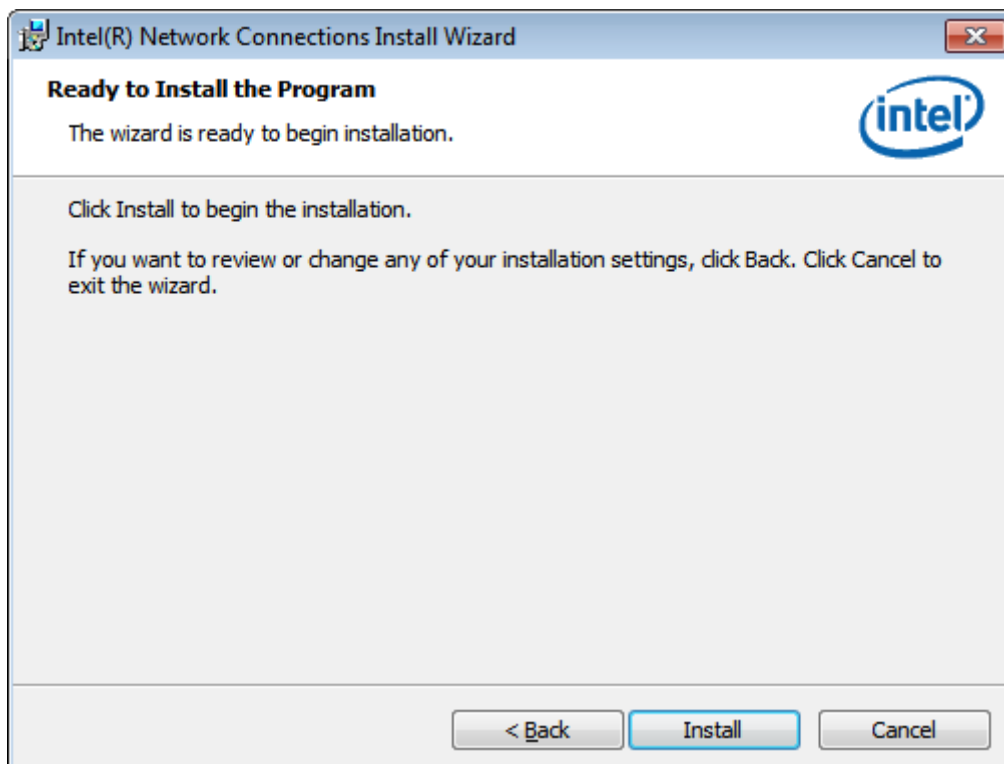

**Step 6.** Click **Finish** to exit the wizard.

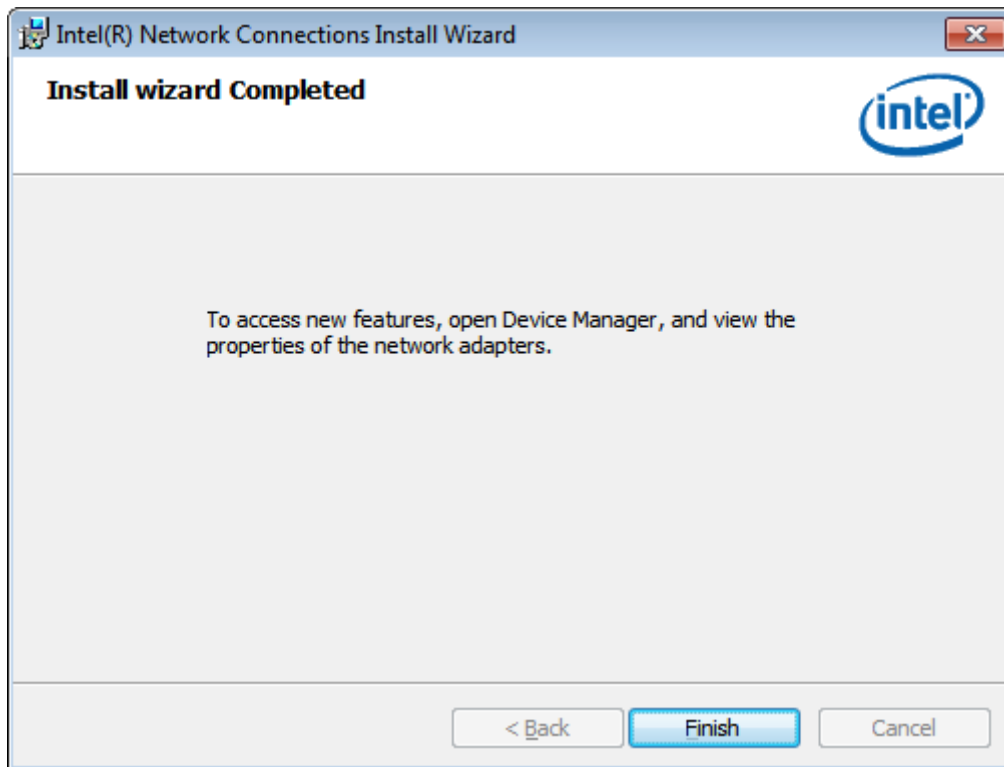

## 4.4 Realtek ALC662 HD Audio Driver

To install the Realtek ALC662 HD Audio Driver, please follow the steps below.

**Step 1.** Select **Realtek AL662 HD Audio Driver** from the list



**Step 2.** Click **Next** to continue.

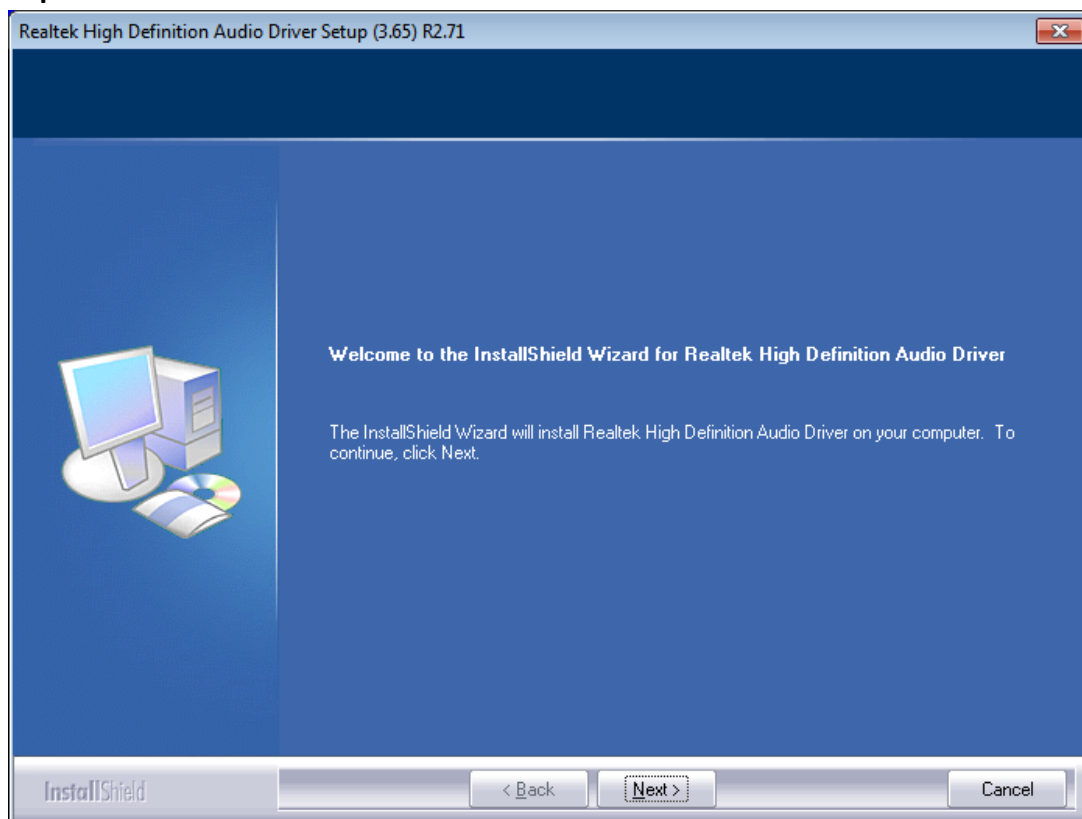

**Step 3.** Click **Yes, I want to restart my computer now.** Click **Finish** to complete the installation.

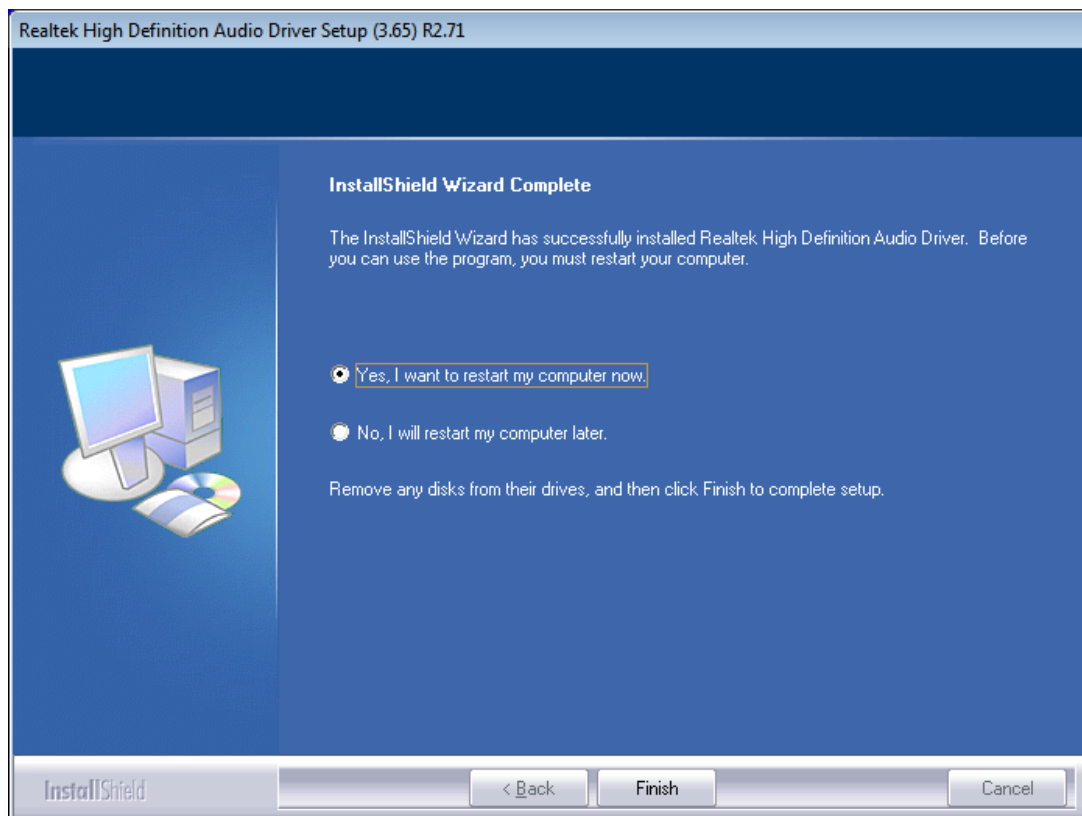

## 4.5 USB 3.0 Driver

To install the USB 3.0 Driver, please follow the steps below.

**Step 1.** Select **USB 3.0 Driver** from the list



**Step 2.** Click **Next** to continue.

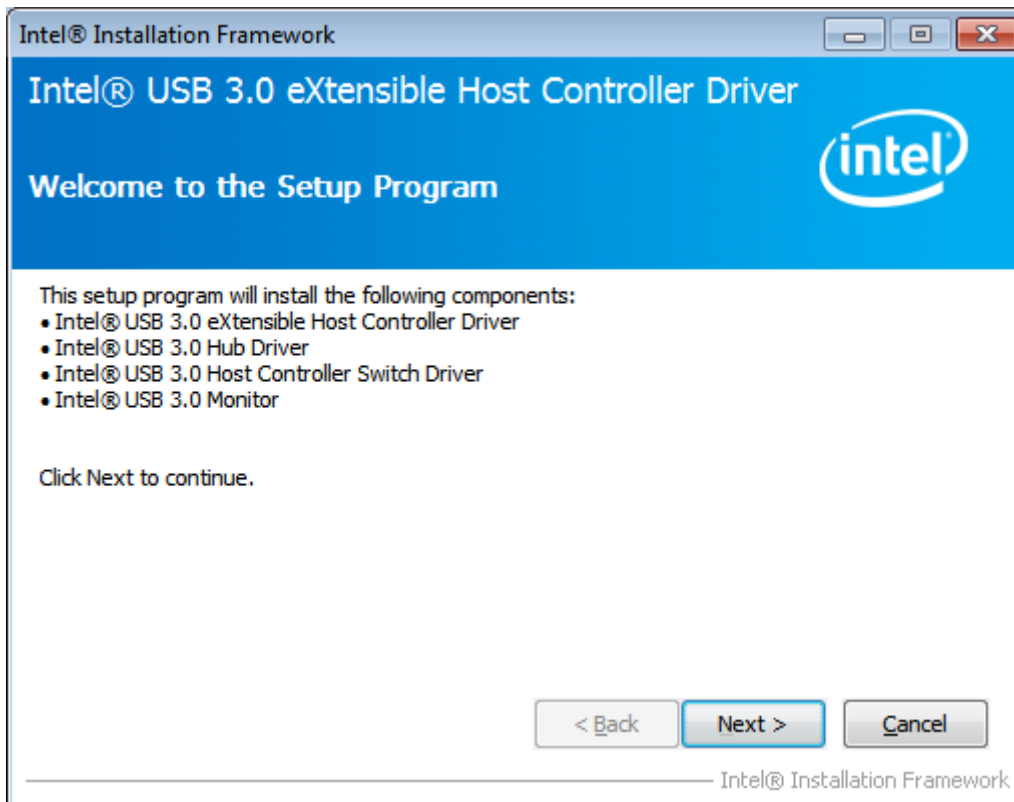



**Step 3.** Read the license agreement. Then click **Yes** to continue.

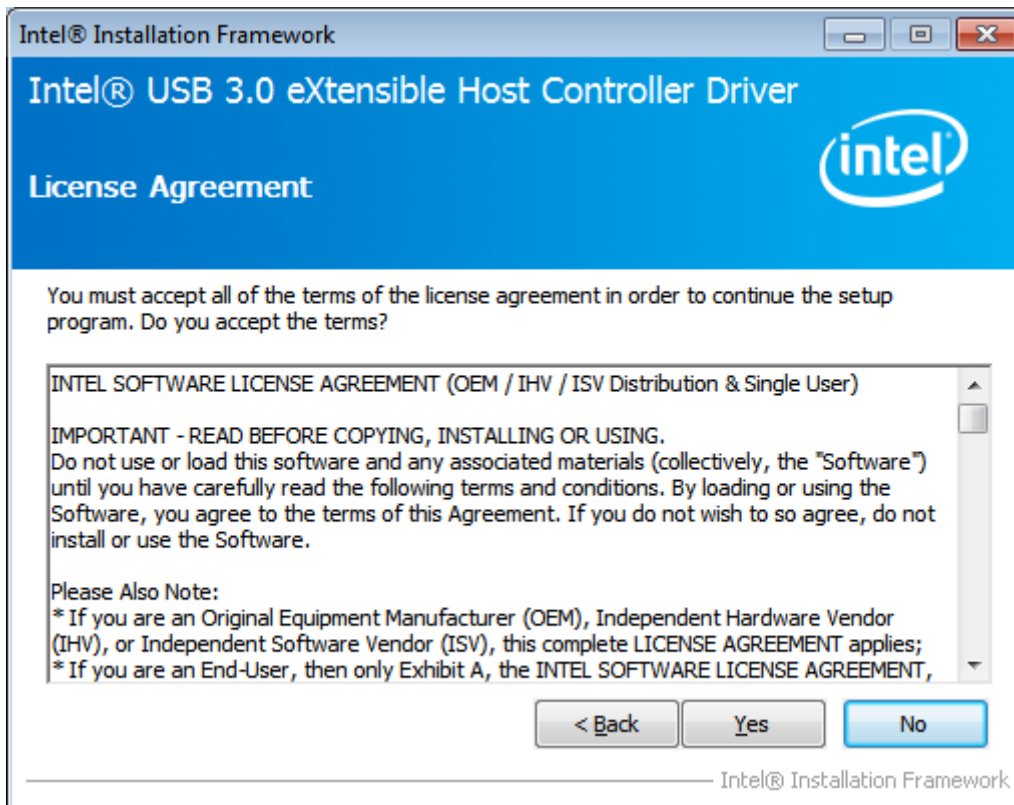

**Step 4.** Click **Next** to continue.

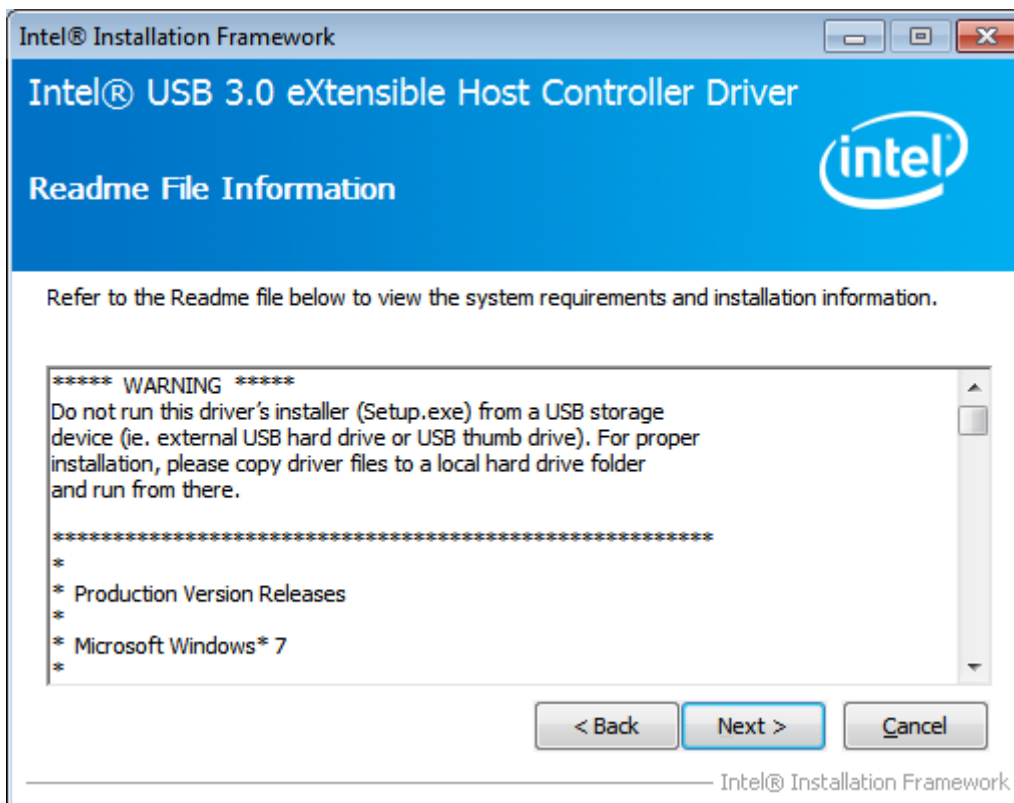

**Step 5.** Click **Next** to continue.

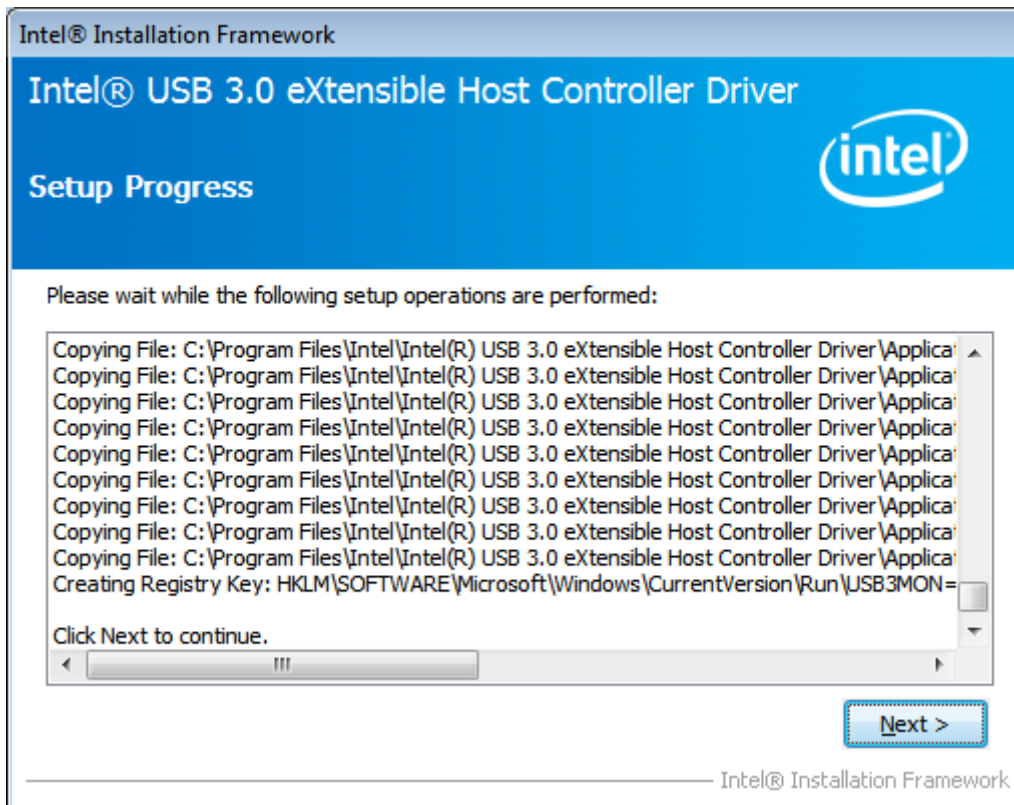

**Step 6.** Select **Yes, I want to restart this computer now.** Then click **Finish** to complete the installation.

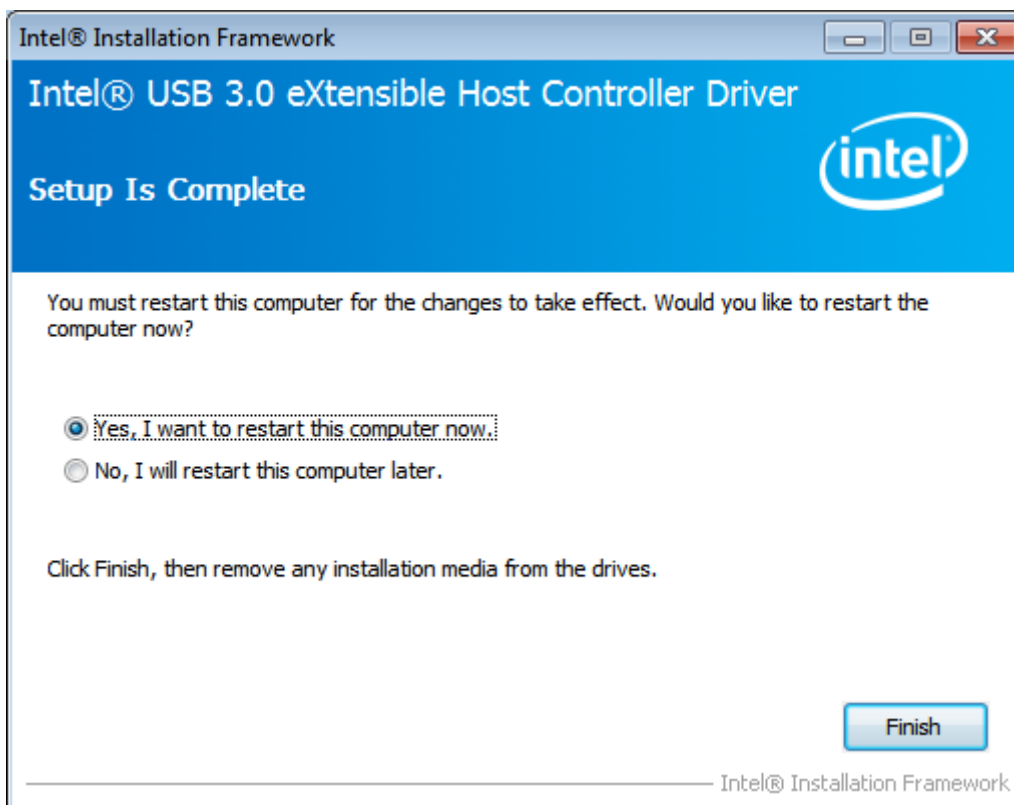

## 4.6 Intel(R) MEI Driver

To install the Intel(R) MEI Driver, please follow the steps below.

**Step 1.** Select **Intel(R) MEI Driver** from the list.



**Step 2.** Click **Next** to continue.

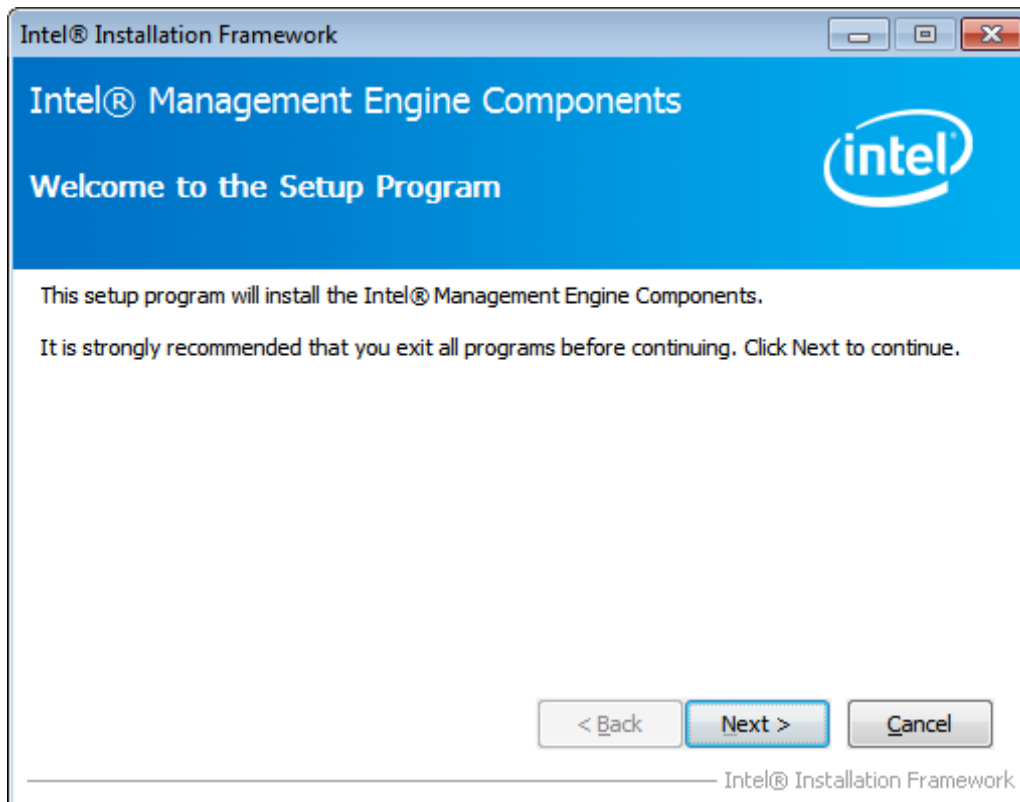

**Step 3.** Read the License Agreement and then click **Yes** to continue.

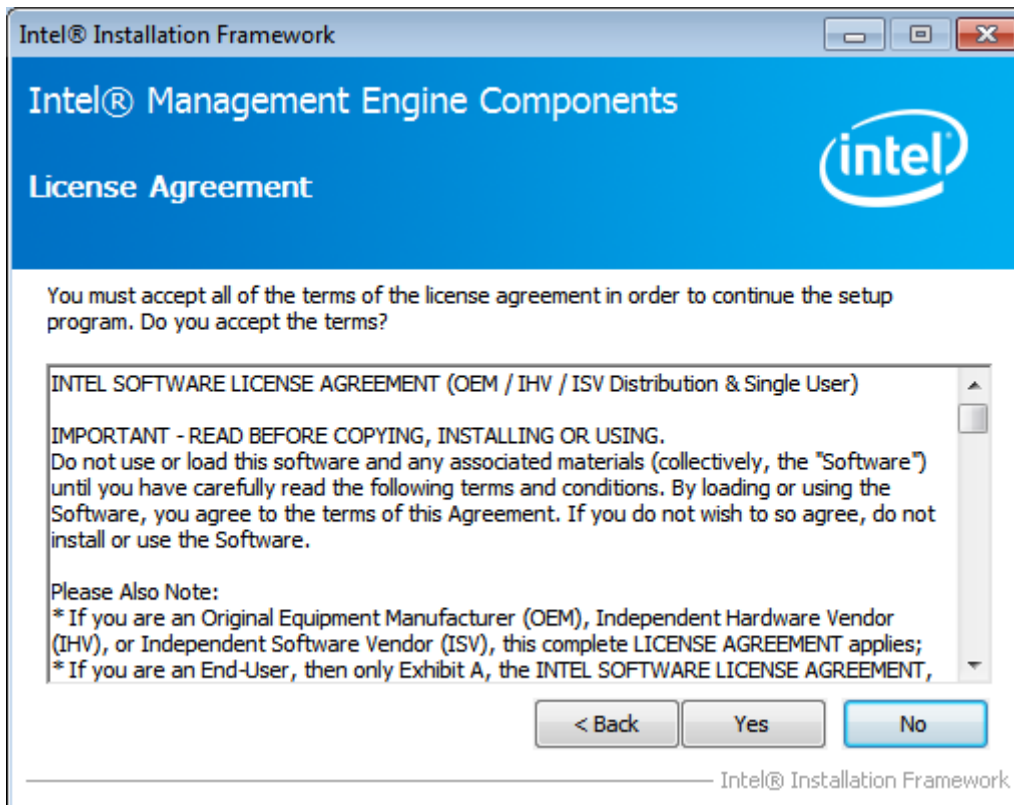

**Step 4.** Click **Next** to continue.

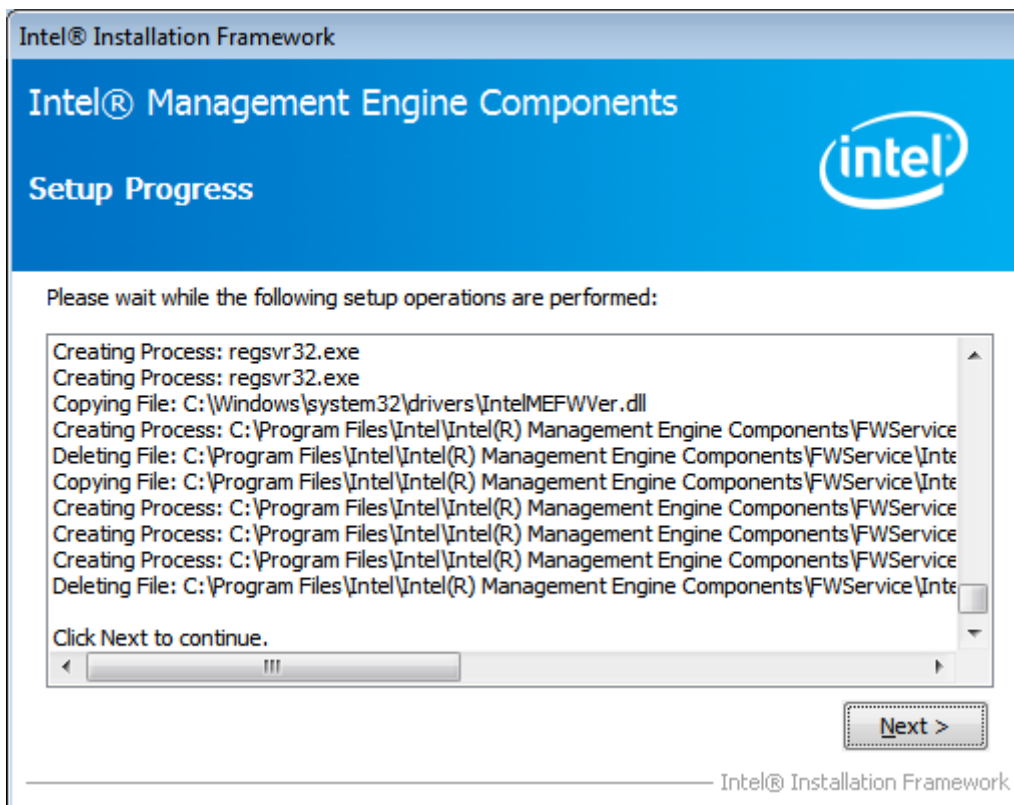

**Step 5.** Select **Yes, I want to restart this computer now.** Then click **Finish** to complete the installation.

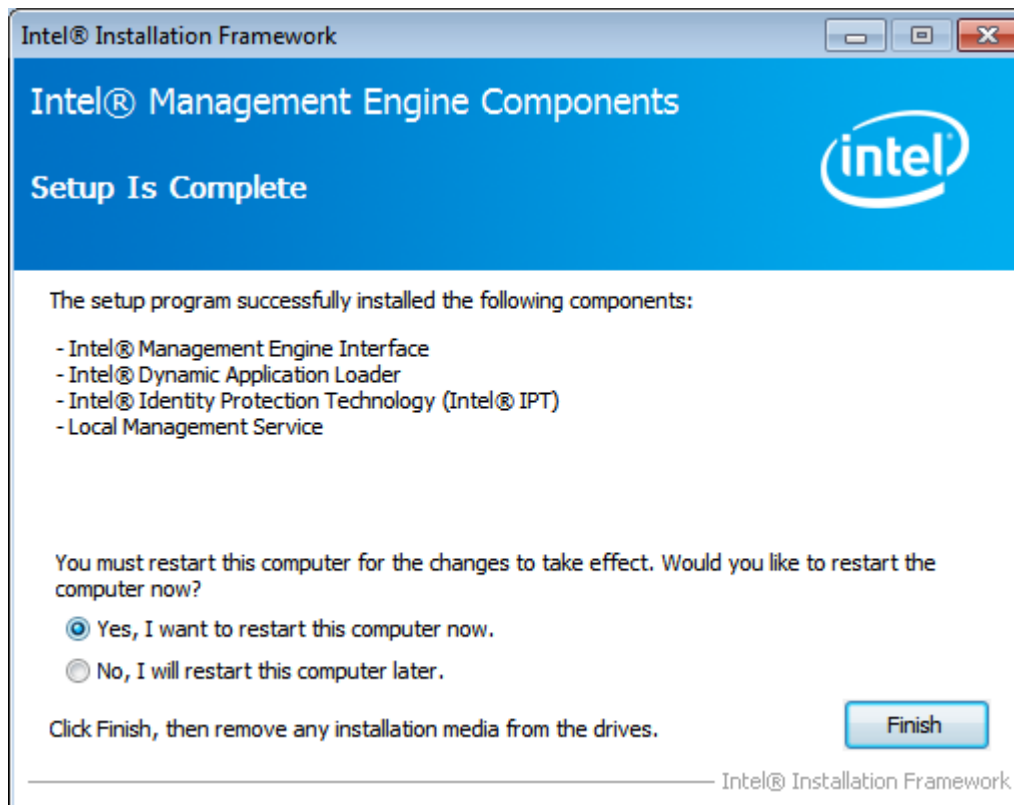

# Chapter 5 Touch Screen Installation

This chapter describes how to install drivers and other software that will allow your touch screen work with different operating systems.

## 5.1 Windows 7/8/8.1 Universal Driver Installation for PenMount 6000 Series

Before installing the Windows 7/8/8.1 driver software, you must have the Windows 7/8/8.1 system installed and running on your computer. You must also have one of the following PenMount 6000 series controller or control boards installed: PM6500, PM6300.

### 5.1.1 Installing Software(Resistive Touch)

If you have an older version of the PenMount Windows 7 driver installed in your system, please remove it first. Follow the steps below to install the PenMount DMC6000 Windows 7 driver.

**Step 1.** Insert the product CD, the screen below would appear. Click **Touch Panel Driver** from the list.



**Step 2. Select Resistive Touch.**



**Step 3. Click Next to continue.**

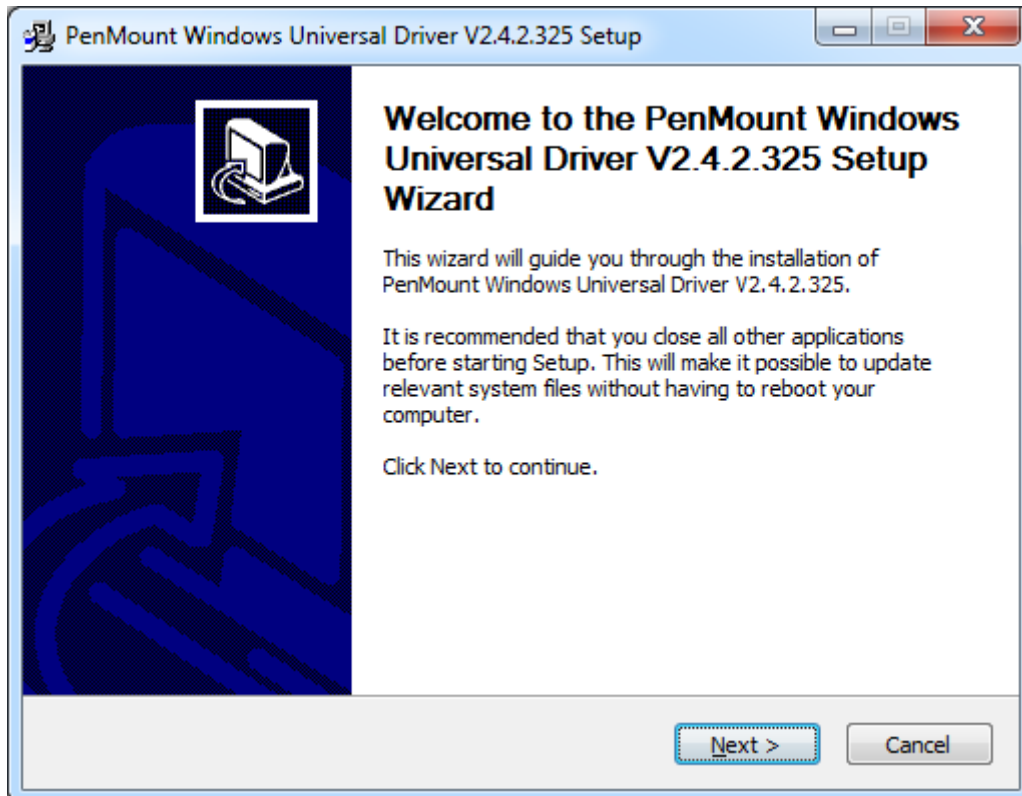

**Step 4.** Read the license agreement. Click **I Agree** to agree the license agreement.

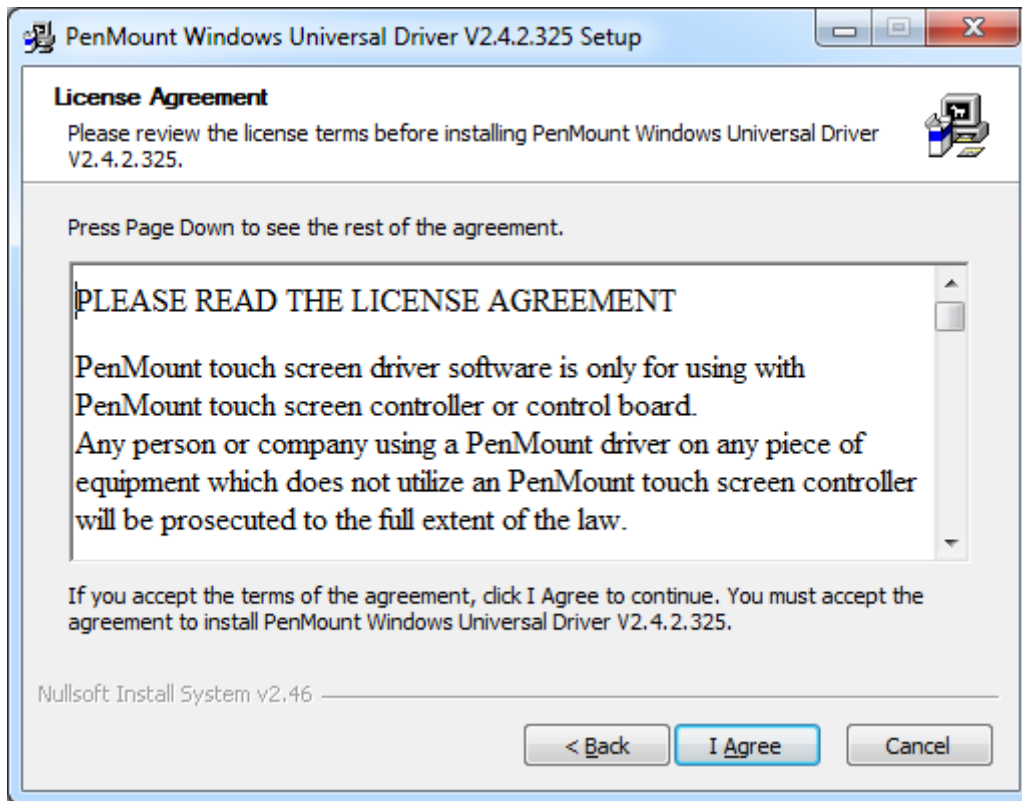

**Step 5.** Choose the folder in which to install PenMount Windows Universal Driver. Click **Install** to start the installation.

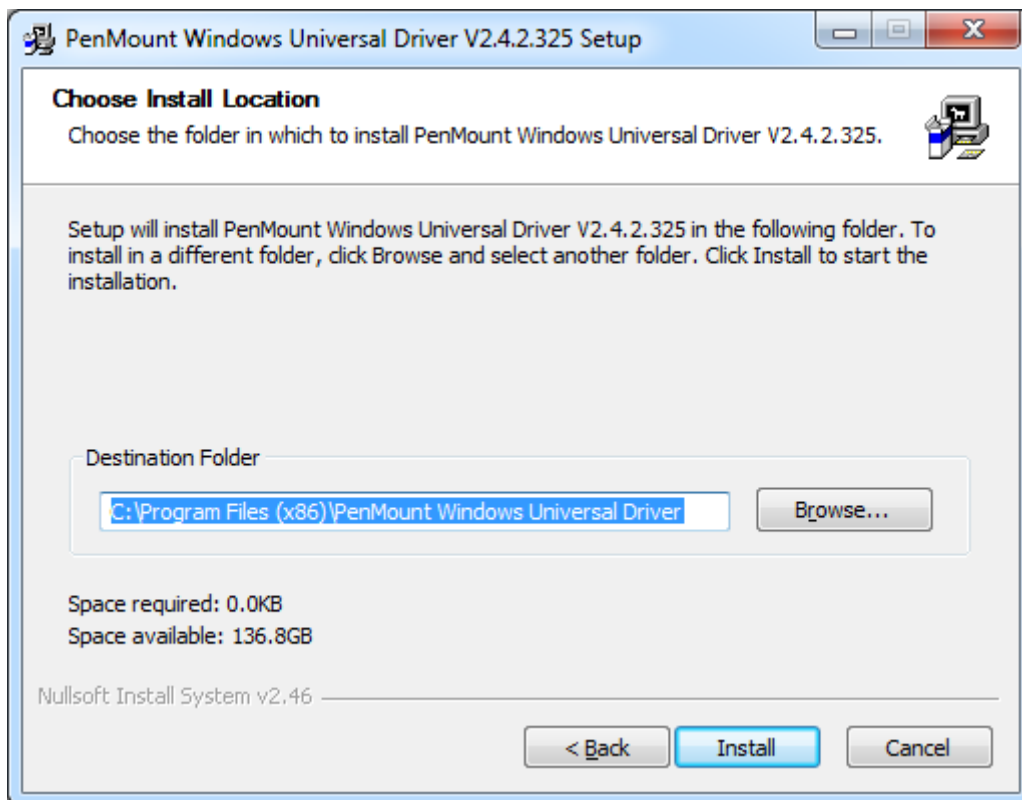



**Step 6.** Click **Yes** to continue.

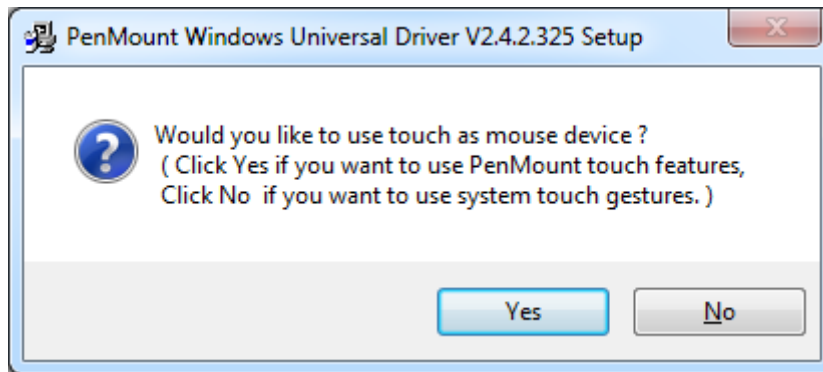

**Step 7.** Click **Finish** to complete installation.

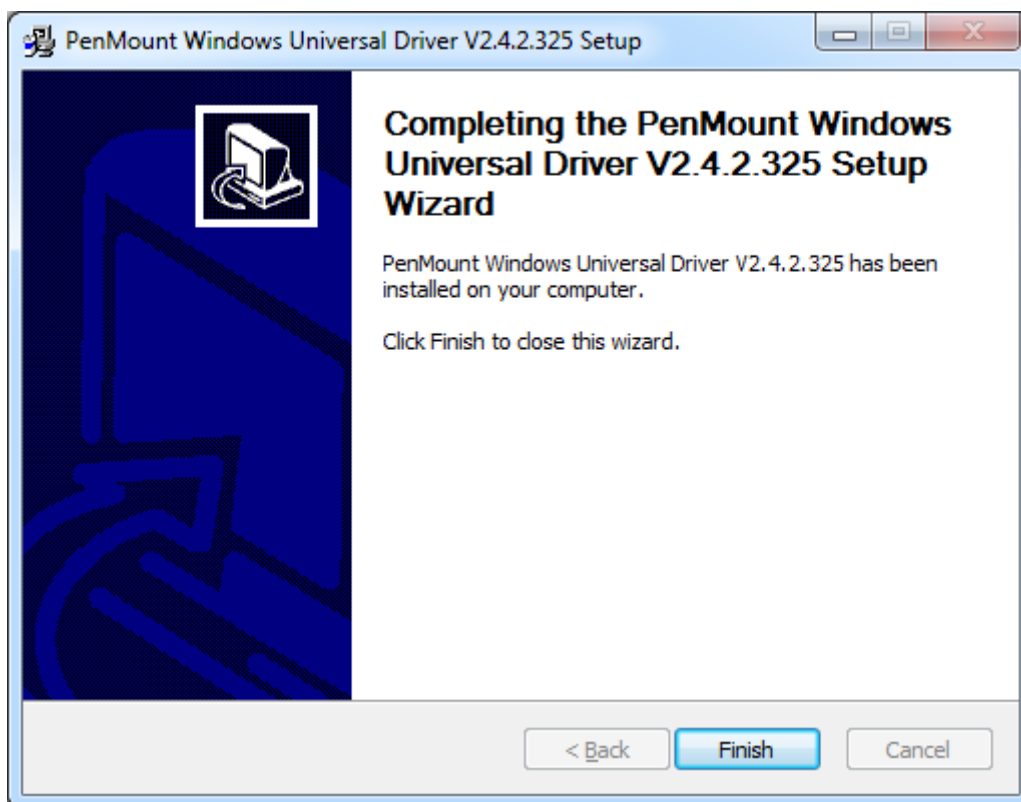

## 5.1.2 Installing Software (Projected Capacitive)

**Step 1.** Insert the product CD, the screen below would appear. Click **touch panel driver** from the list.



**Step 2.** Select Projected Capacitive.



**Step 3.** Click **Next** to continue.

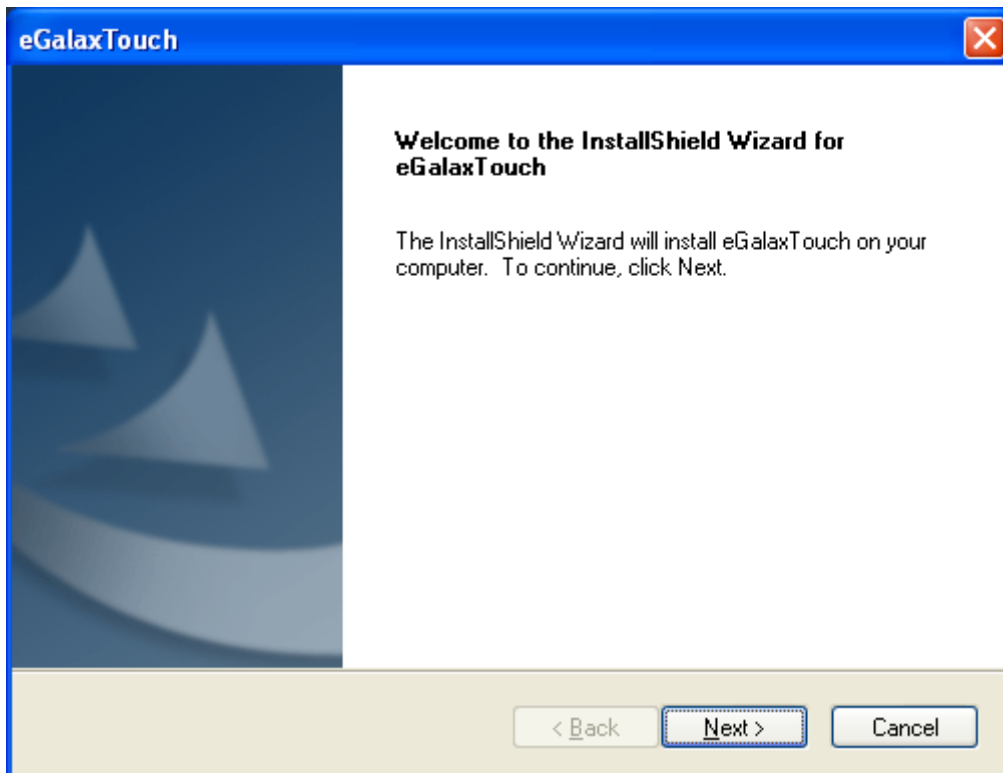

**Step 4.** Select **I accept the terms of the license agreement.** Click **Next.**

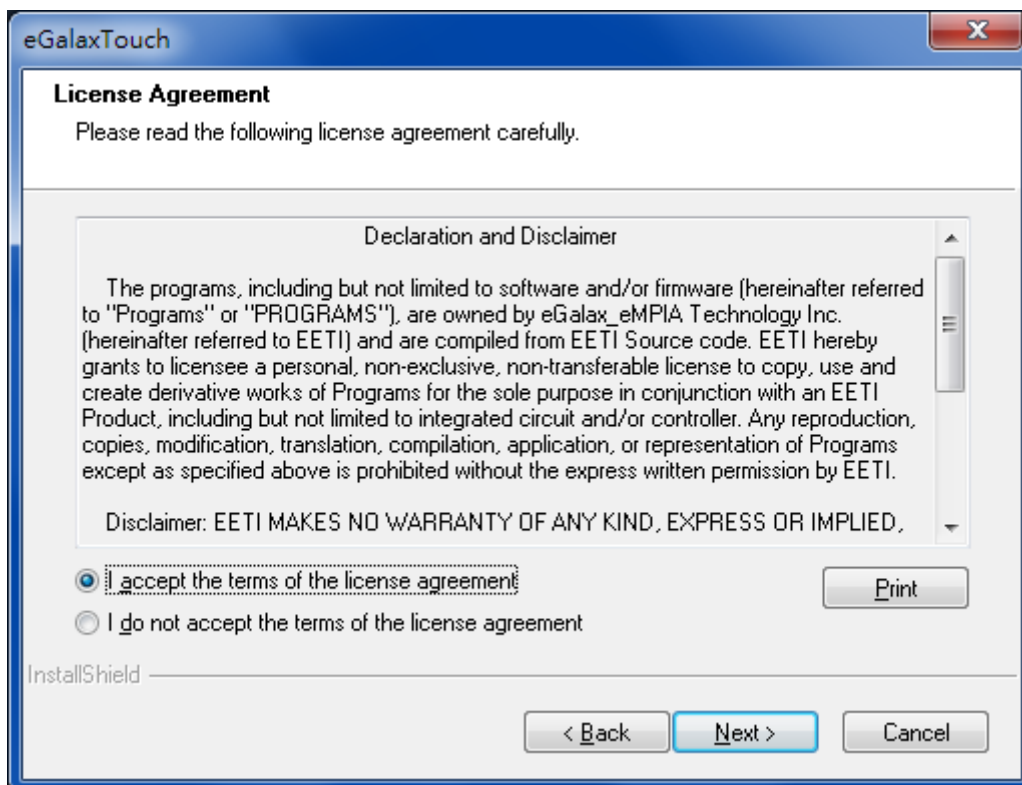

**Step.5.** Click **Next** to continue.

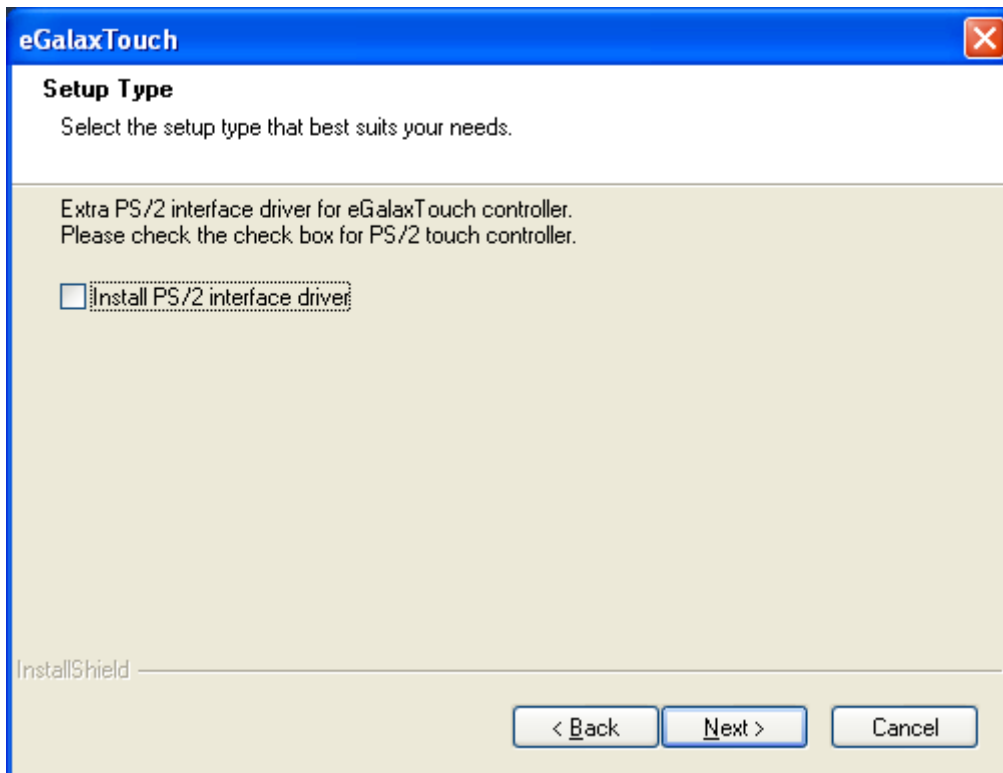

**Step 6.** Click **Install RS232 interface driver**. Then click **Next** to continue.

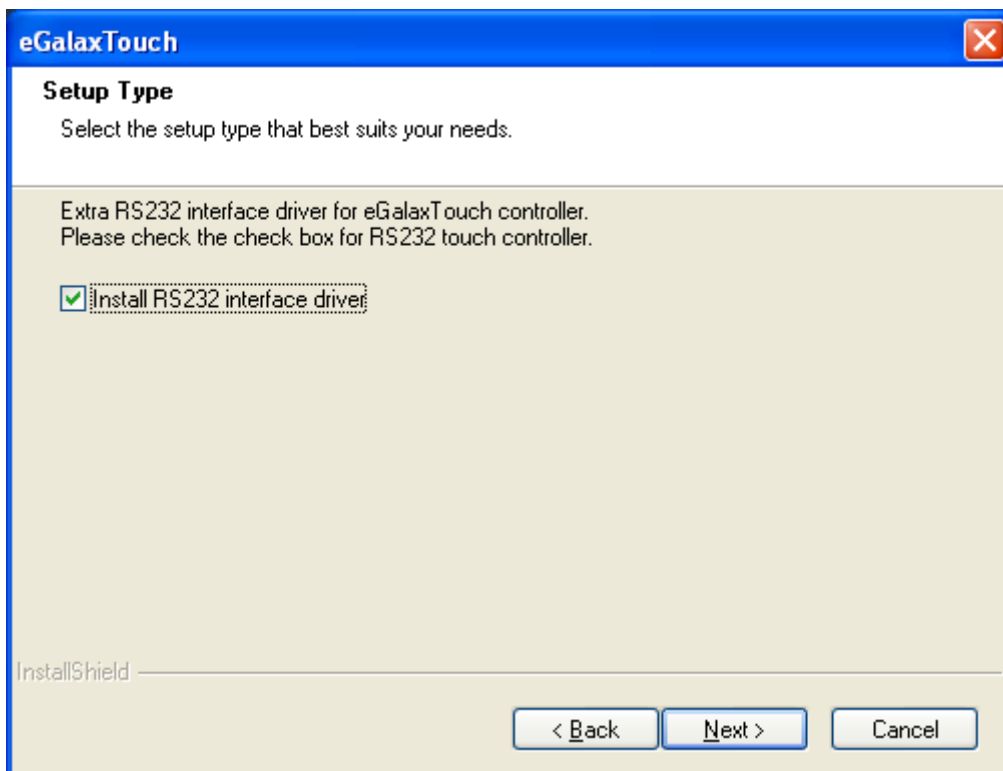

**Step 7. Select None. Click Next.**

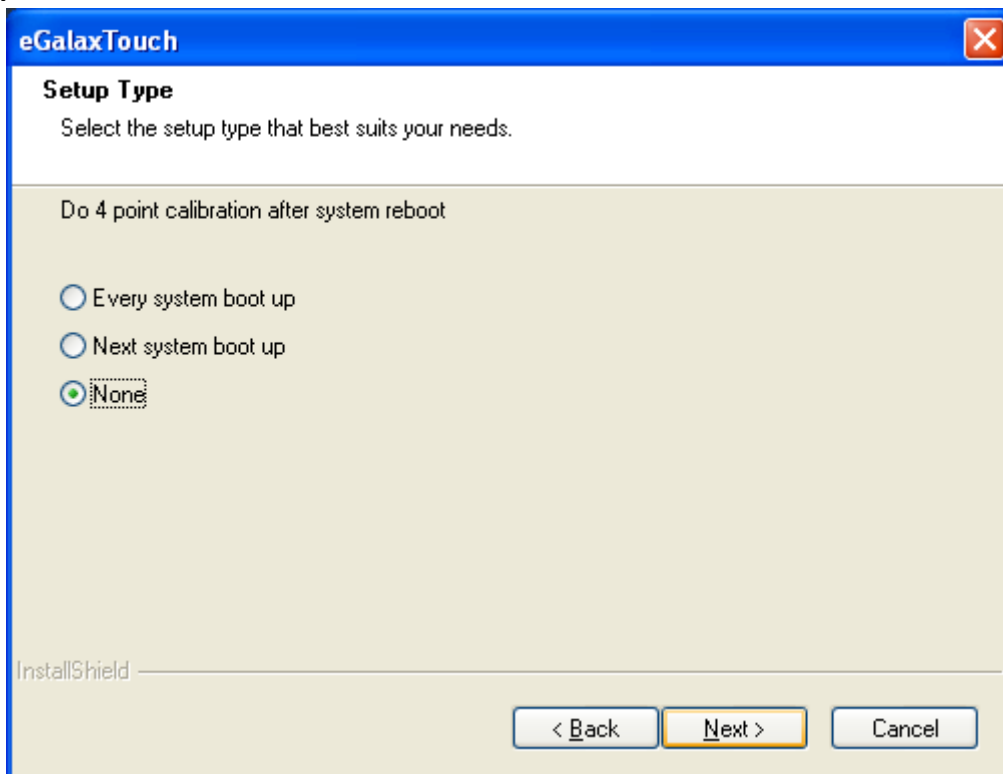

**Step 8. Click OK to continue.**

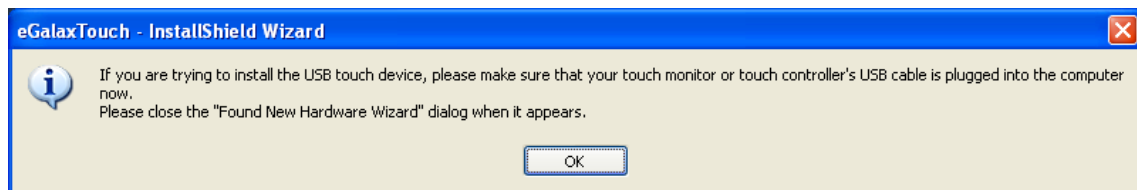

**Step 9. Click Support Multi-Monitor System. Click Next.**

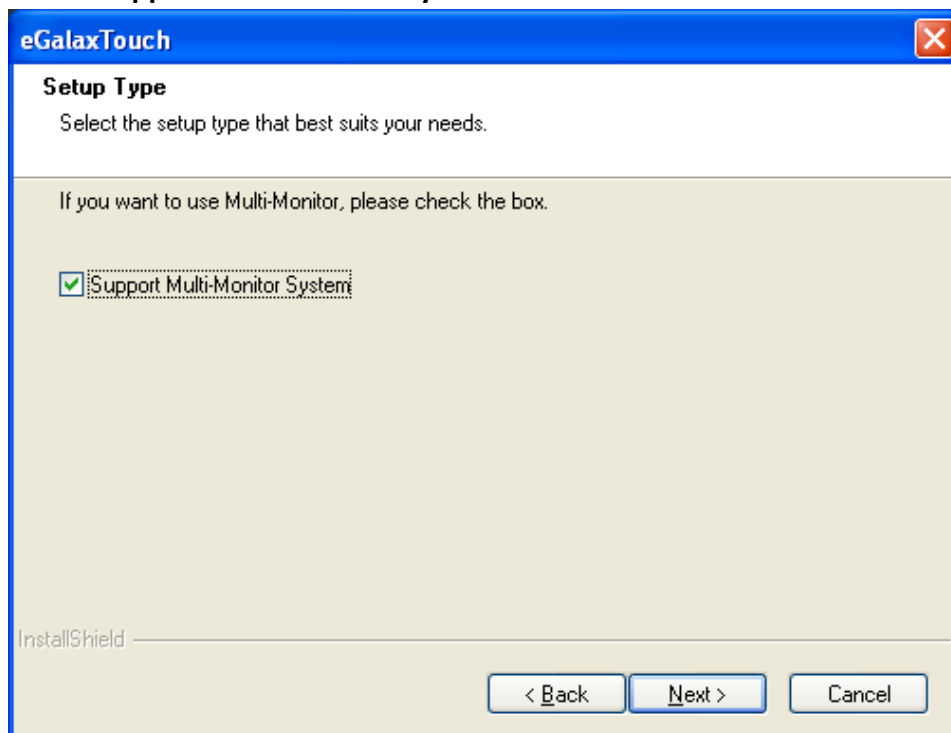

**Step 10.** Go to **C:\Program Files\eGalaxTouch**. Click **Next**.

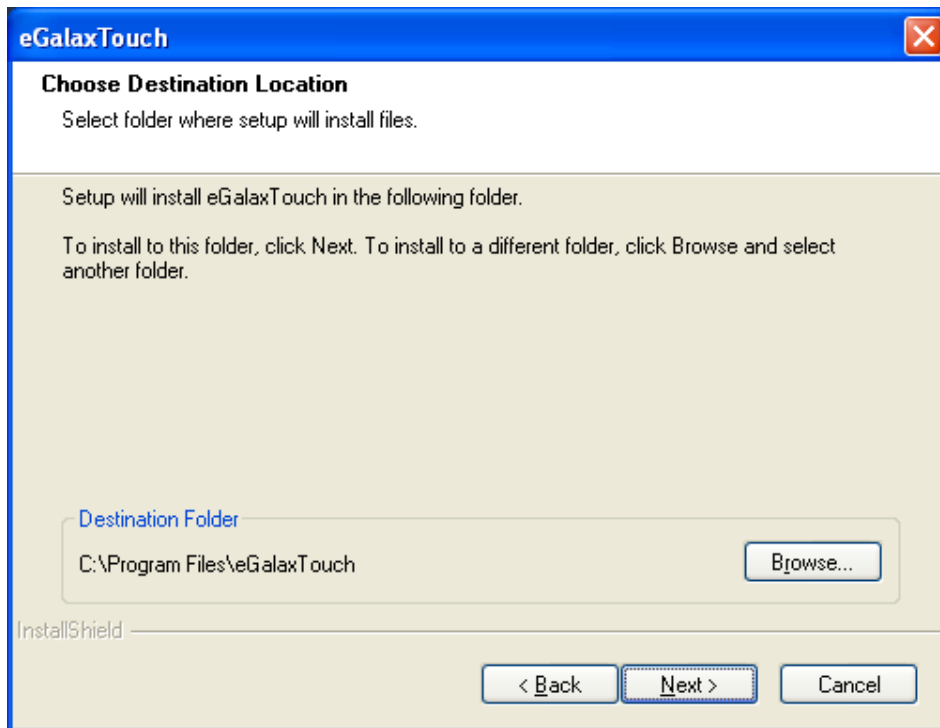

**Step 11.** Click **Next**.

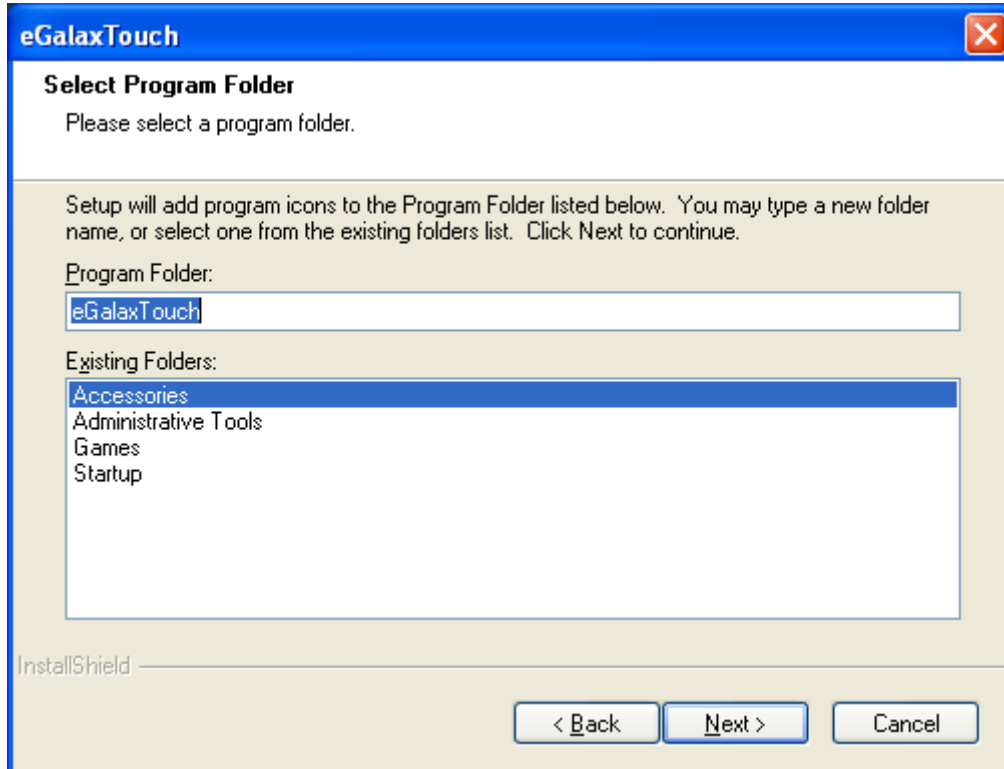

**Step 12.** Click **Create a eGalaxTouch Utility shortcut on desktop.** Click **Next.**

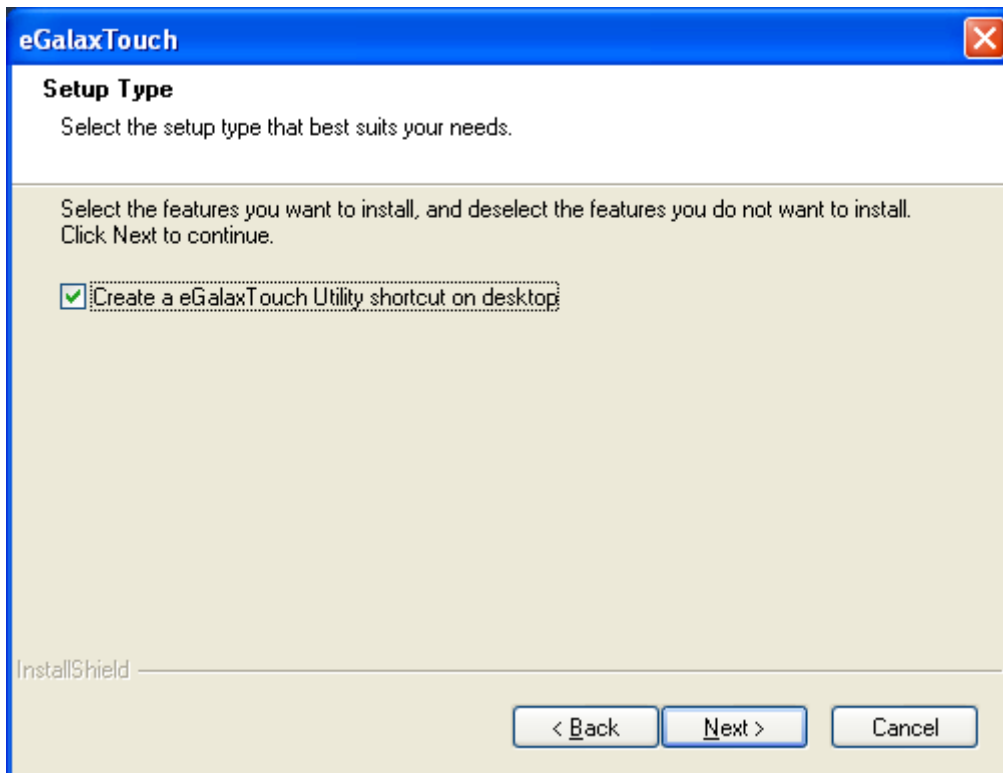

**Step 13.** Wait for installation.

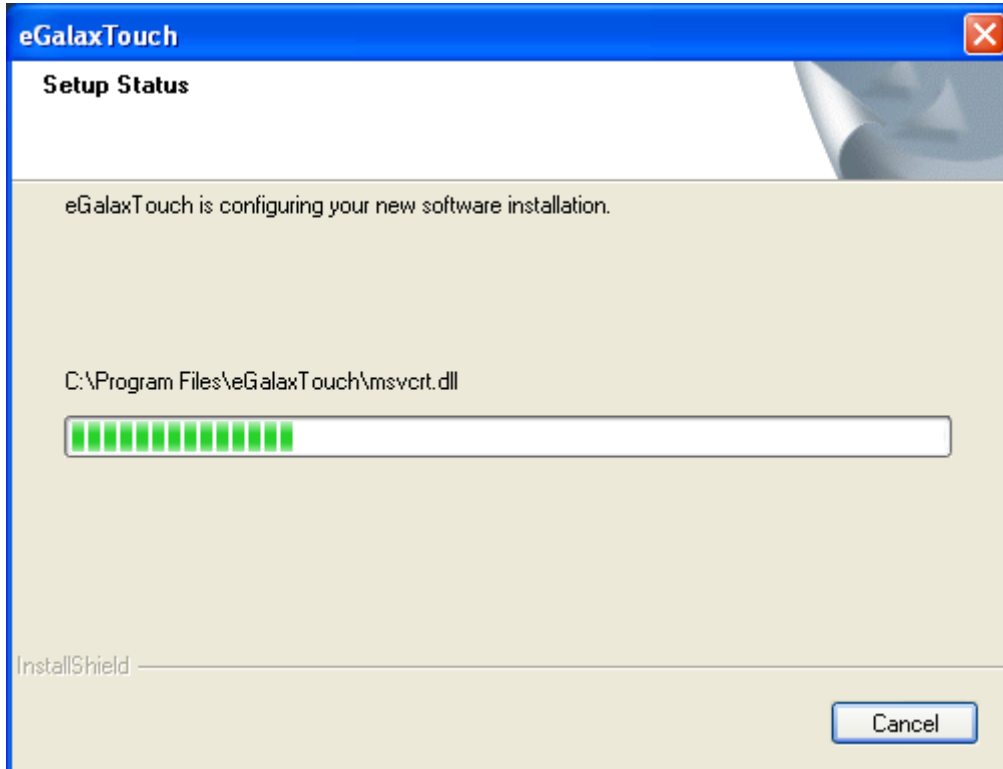

**Step 14.** Click **Yes** to do 4 point calibration.

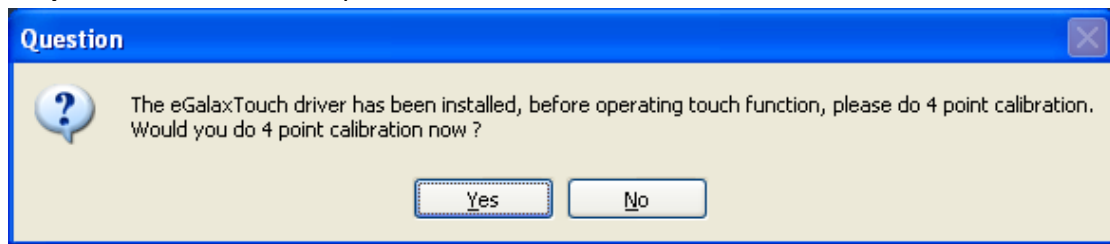

## 5.2 Software Functions

### 5.2.1 Software Functions(Resistive Touch)

Upon rebooting, the computer automatically finds the new 6000 controller board. The touch screen is connected but not calibrated. Follow the procedures below to carry out calibration.

1. After installation, click the PenMount Monitor icon "PM" in the menu bar.
2. When the PenMount Control Panel appears, select a device to "Calibrate."

#### PenMount Control Panel(Resistive Touch)

The functions of the PenMount Control Panel are **Device**, **Multiple Monitors**, **Tools** and **About**, which are explained in the following sections.

#### Device

In this window, you can find out that how many devices be detected on your system.

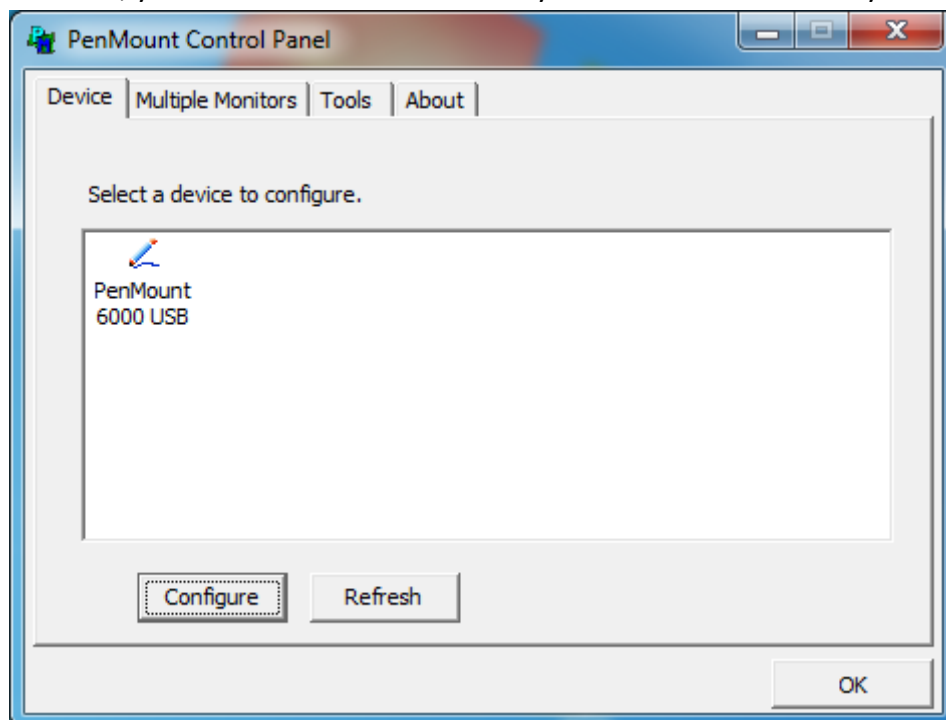



## Calibrate

This function offers two ways to calibrate your touch screen. 'Standard Calibration' adjusts most touch screens. 'Advanced Calibration' adjusts aging touch screens.

Standard Calibration	<b>Click this button and arrows appear pointing to red squares. Use your finger or stylus to touch the red squares in sequence. After the fifth red point calibration is complete. To skip, press 'ESC'.</b>
Advanced Calibration	<b>Advanced Calibration uses 4, 9, 16 or 25 points to effectively calibrate touch panel linearity of aged touch screens. Click this button and touch the red squares in sequence with a stylus. To skip, press ESC'.</b>

**Step 1.** Please select a device then click "Configure". You can also double click the device too.

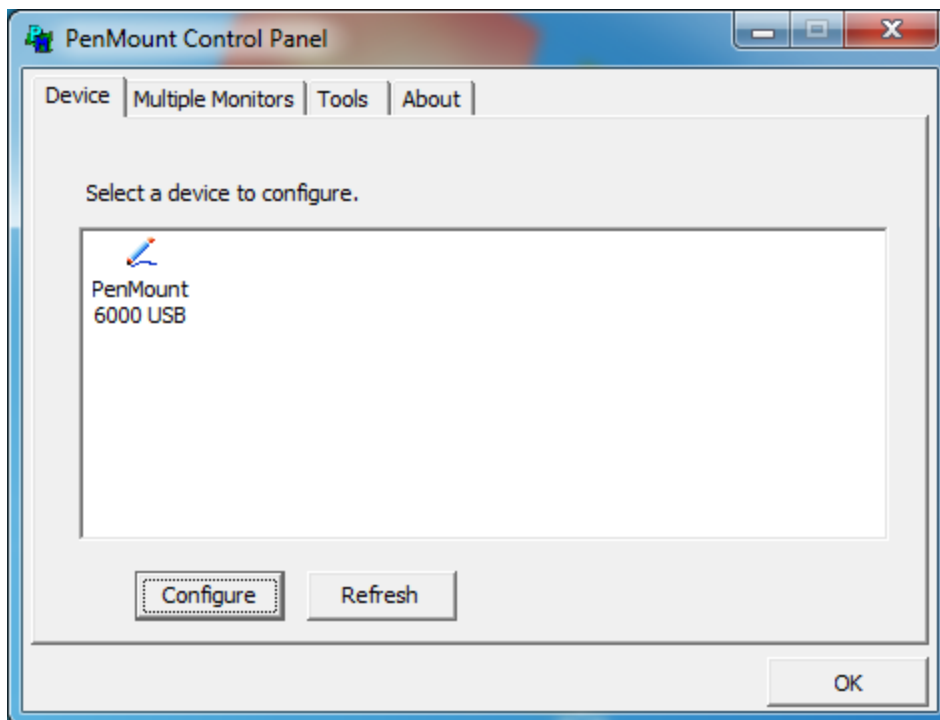

**Step 2.** Click “Standard Calibration” to start calibration procedure

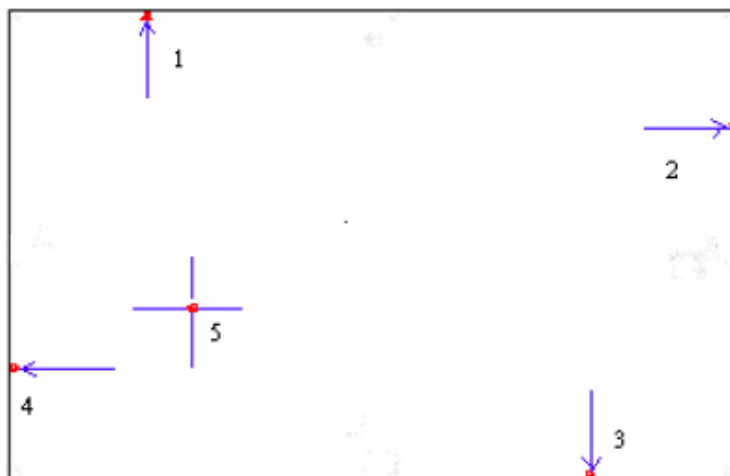
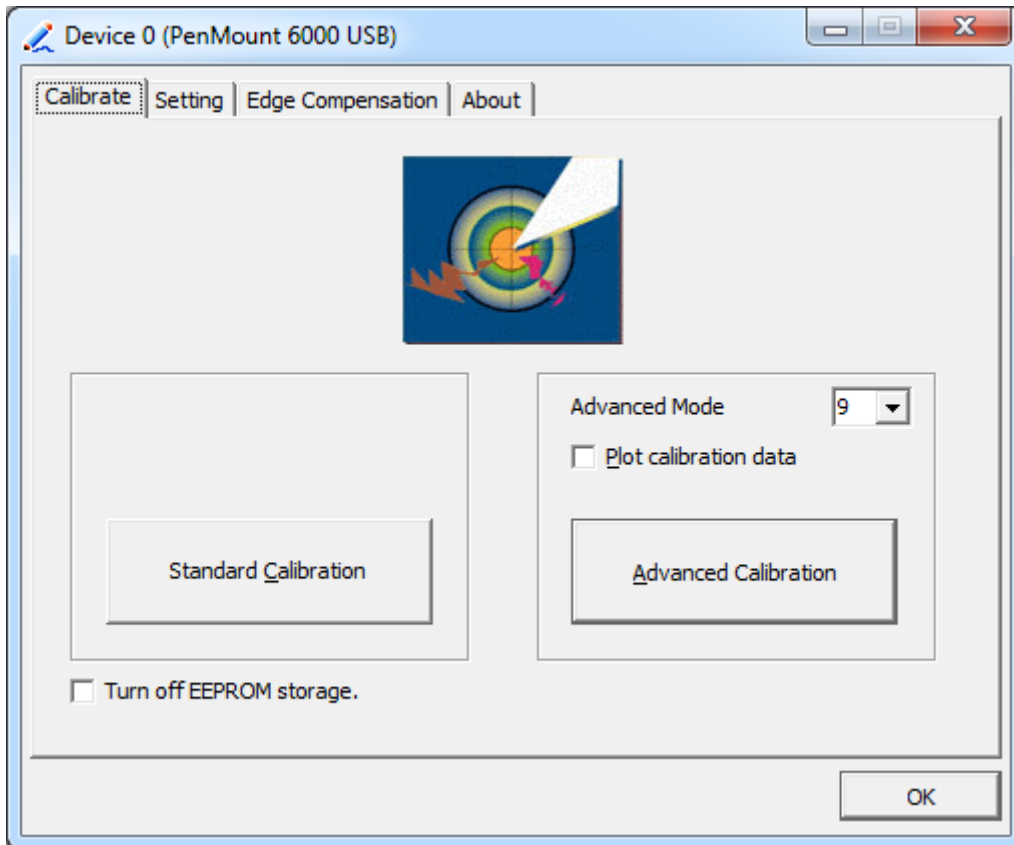

**NOTE:** The older the touch screen, the more Advanced Mode calibration points you need for an accurate calibration. Use a stylus during Advanced Calibration for greater accuracy. Please follow the step as below:

**Step 3.** Select **Device** to calibrate, then you can start to do **Advanced Calibration**.

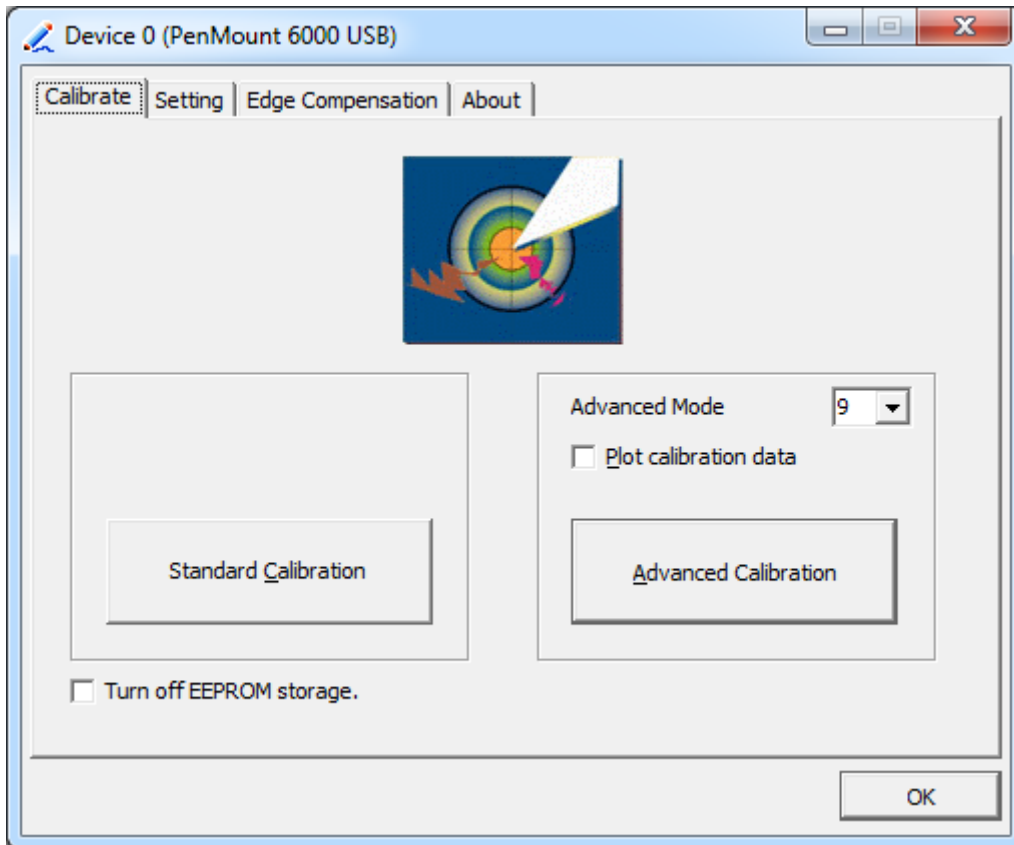

**NOTE:** Recommend to use a stylus during Advanced Calibration for greater accuracy.



Plot Calibration Data	<b>Check this function and a touch panel linearity comparison graph appears when you have finished Advanced Calibration. The blue lines show linearity before calibration and black lines show linearity after calibration.</b>
Turn off EEPROM storage	<b>The function disable for calibration data to write in Controller. The default setting is Enable.</b>

## Setting

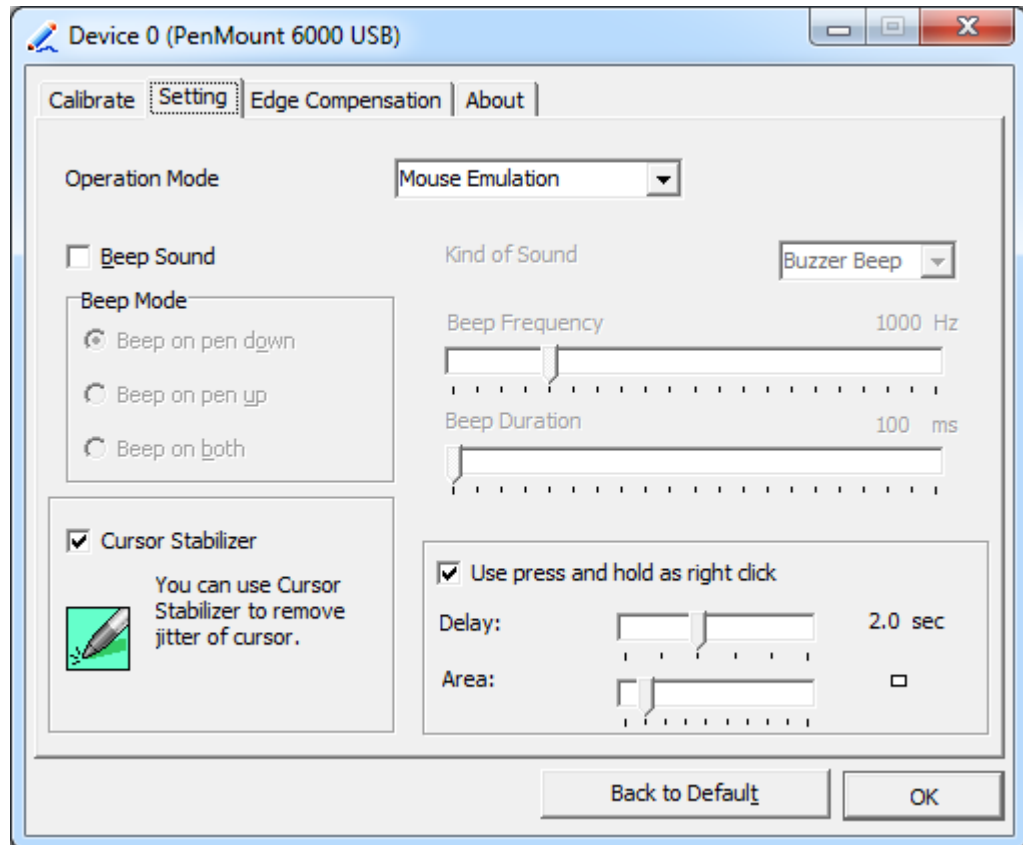

Touch Mode	<p><b>This mode enables and disables the mouse’s ability to drag on-screen icons – useful for configuring POS terminals.</b></p> <p><b>Mouse Emulation – Select this mode and the mouse functions as normal and allows dragging of icons.</b></p> <p><b>Click on Touch – Select this mode and mouse only provides a click function, and dragging is disables.</b></p>
Beep Sound	<p><b>Enable Beep Sound – turns beep function on and off</b></p> <p><b>Beep on Pen Down – beep occurs when pen comes down</b></p> <p><b>Beep on Pen Up – beep occurs when pen is lifted up</b></p> <p><b>Beep on both – beep occurs when comes down and lifted up</b></p> <p><b>Beep Frequency – modifies sound frequency</b></p> <p><b>Beep Duration – modifies sound duration</b></p>
Cursor Stabilizer	<p><b>Enable the function support to prevent cursor shake.</b></p>
Use press and hold as right click	<p><b>You can set the time out and area for you need.</b></p>

## Edge Compensation

You can use Edge Compensation to calibrate more subtly.

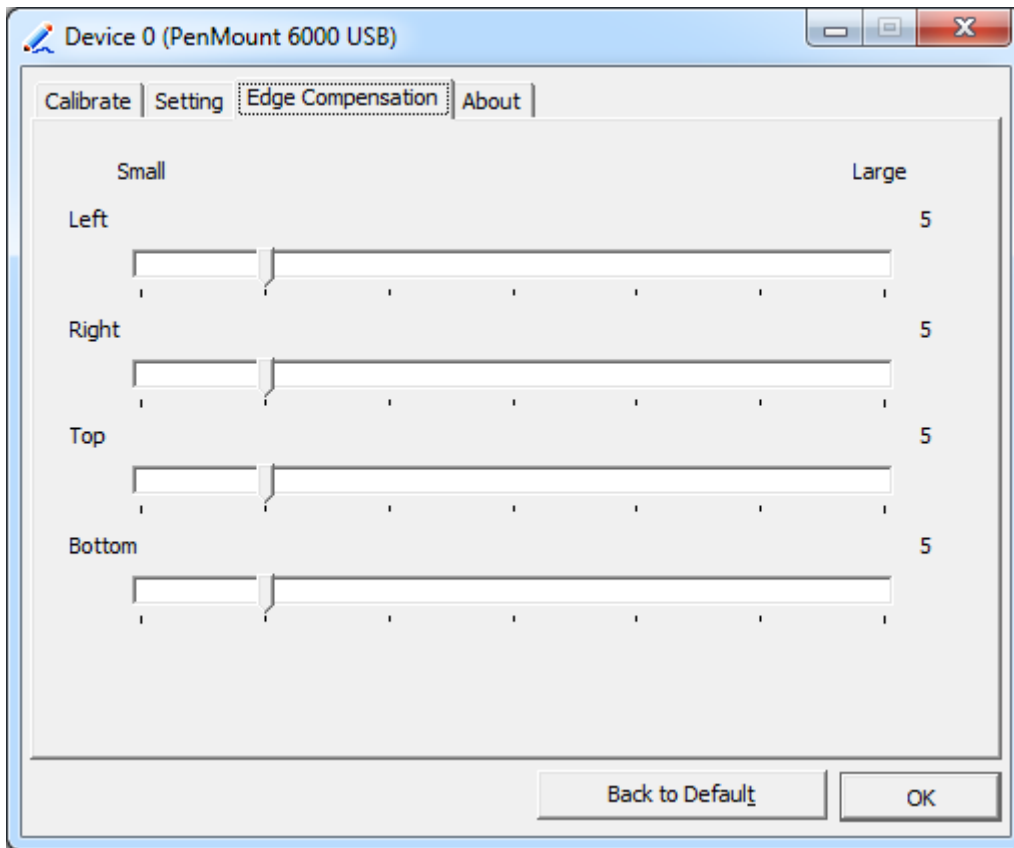

## About

This panel displays information about the PenMount controller and driver version.

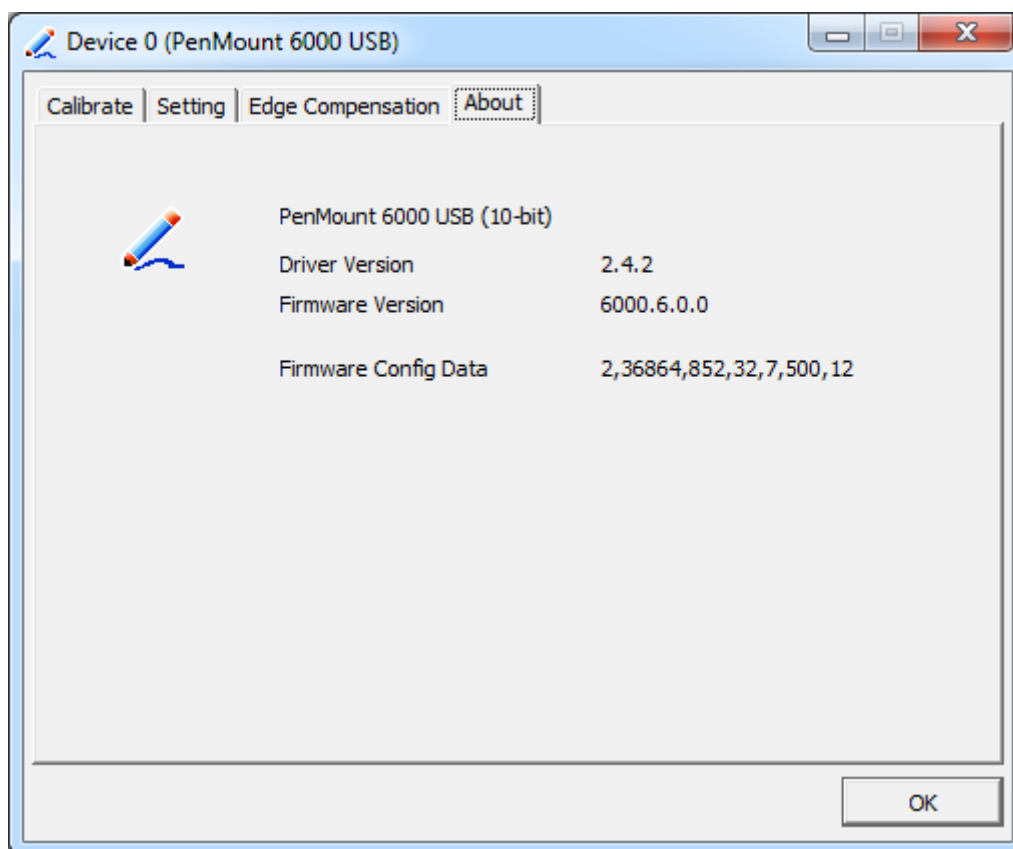

## Multiple Monitors

Multiple Monitors support from two to six touch screen displays for one system. The PenMount drivers for Windows 7/8/8.1 support Multiple Monitors. This function supports from two to six touch screen displays for one system. Each monitor requires its own PenMount touch screen control board, either installed inside the display or in a central unit. The PenMount control boards must be connected to the computer COM ports via the USB interface. Driver installation procedures are the same as for a single monitor. Multiple Monitors support the following modes:

- Windows Extends Monitor Function
- Matrox DualHead Multi-Screen Function
- nVidia nView Function

**NOTE:** The Multiple Monitor function is for use with multiple displays only. Do not use this function if you have only one touch screen display. Please note once you turn on this function the rotating function is disabled.

Enable the multiple display function as follows:

1. Check the **Enable Multiple Monitor Support** box; then click **Map Touch Screens** to assign touch controllers to displays.

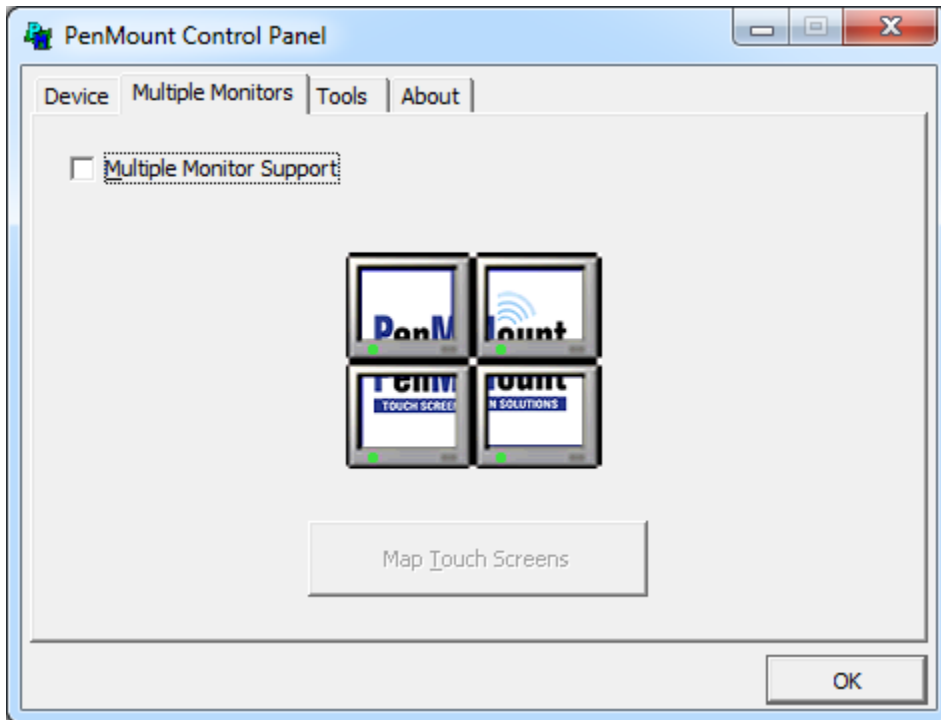

2. When the mapping screen message appears, click **OK**.
3. Touch each screen as it displays “Please touch this monitor”. Following this sequence and touching each screen is called **mapping the touch screens**.

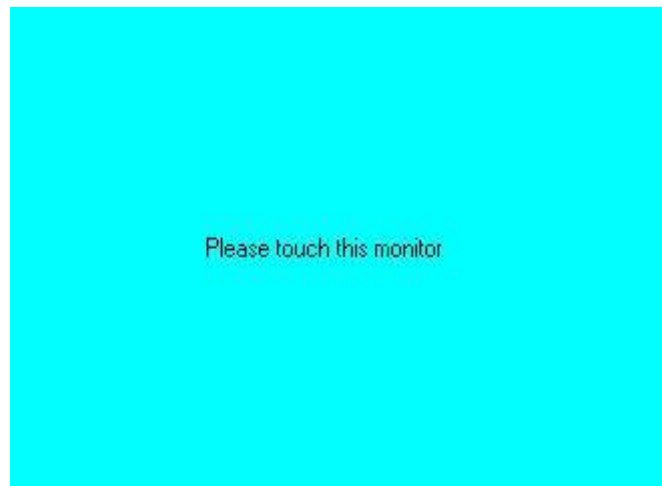

4. Touching all screens completes the mapping and the desktop reappears on the monitors.
5. Select a display and execute the “Calibration” function. A message to start calibration appears. Click **OK**.

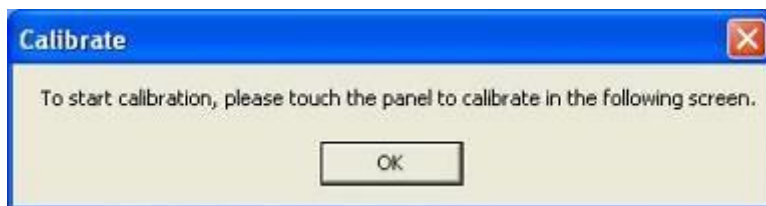

6. "Touch this screen to start its calibration" appears on one of the screens. Touch the screen.
7. "Touch the red square" messages appear. Touch the red squares in sequence.
8. Continue calibration for each monitor by clicking **Standard Calibration** and touching the red squares.

**NOTES:**

1. If you use a single VGA output for multiple monitors, please do not use the **Multiple Monitor** function. Just follow the regular procedure for calibration on each of your desktop monitors.
2. The Rotating function is disabled if you use the Multiple Monitor function.
3. If you change the resolution of display or screen address, you have to redo **Map Touch Screens**, so the system understands where the displays are.

**About**

This panel displays information about the PenMount controller and this driver version.

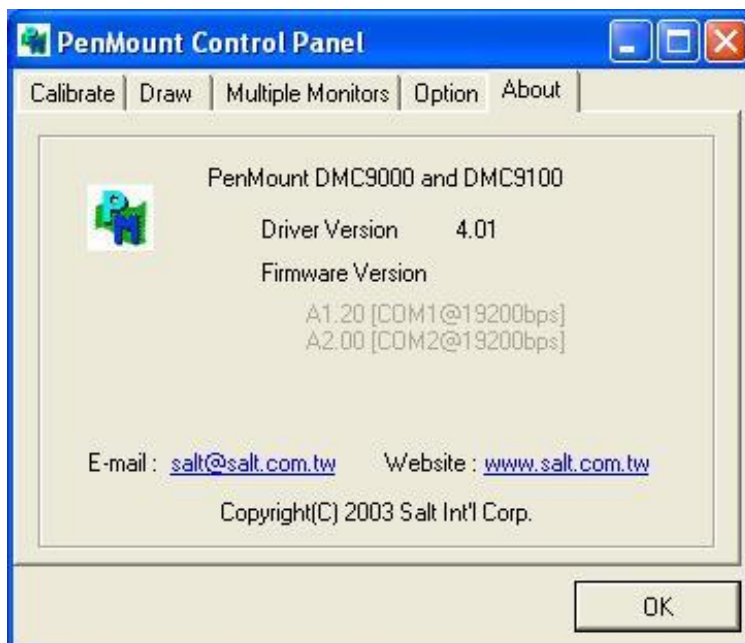

**PenMount Monitor Menu Icon**

The PenMount monitor icon (PM) appears in the menu bar of Windows 7/8/8.1 system when you turn on PenMount Monitor in PenMount Utilities.





PenMount Monitor has the following function



Control Panel	<b>Open Control Panel Windows</b>
Beep	<b>Setting Beep function for each device</b>
Right Button	<b>When you select this function, a mouse icon appears in the right-bottom of the screen.</b> <b>Click this icon to switch between Right and Left Button functions.</b> 
Exit	<b>Exits the PenMount Monitor function.</b>

### Configuring the Rotate Function

1. Install the rotation software package.
2. Choose the rotate function (0°, 90°, 180°, 270°) in the 3rd party software. The calibration screen appears automatically. Touch this point and rotation is mapped.

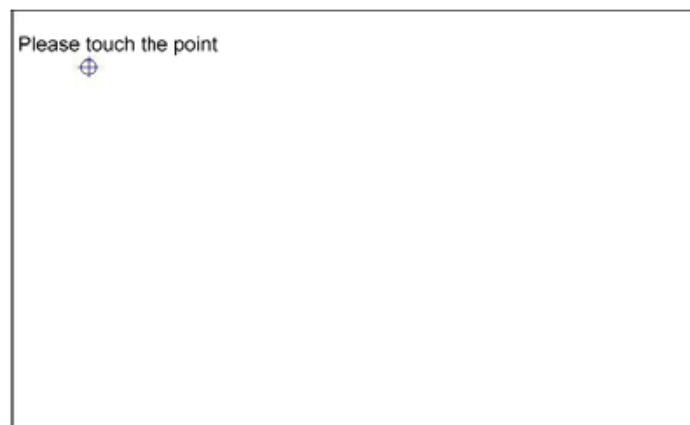

**NOTE:** The Rotate function is disabled if you use Monitor Mapping

## 5.2.2 Software Functions(Projected Capacitive)

### General

In this window, you can see there is USB Controller. Click **OK** to continue.

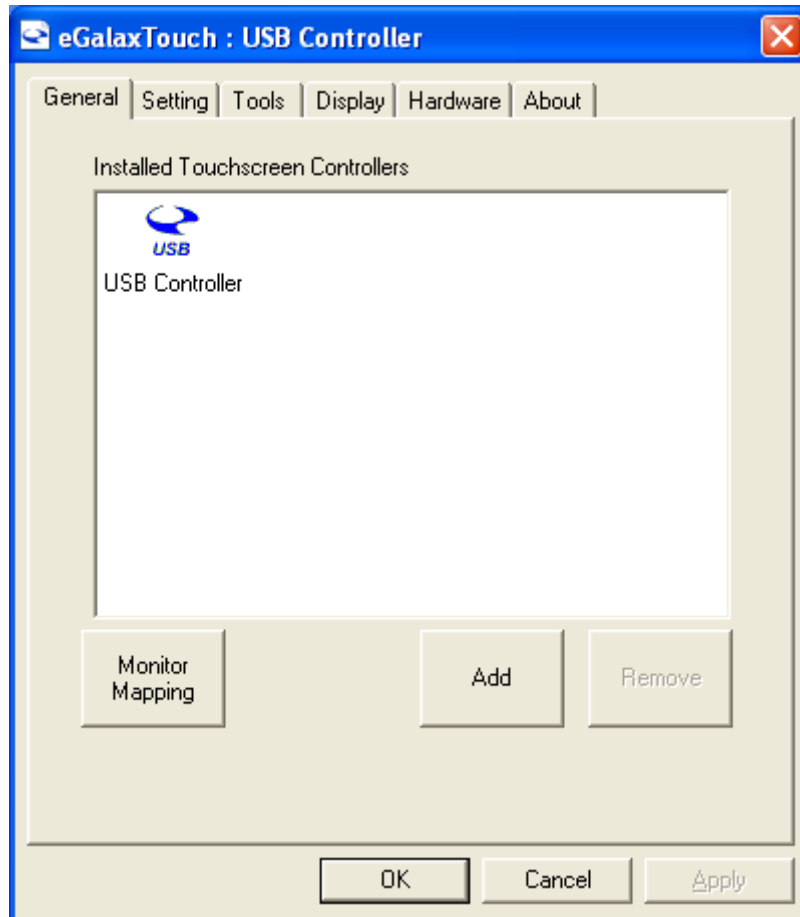

#### **Monitor Mapping**

to adjust touch panel

#### **Add**

to search for device

## Setting

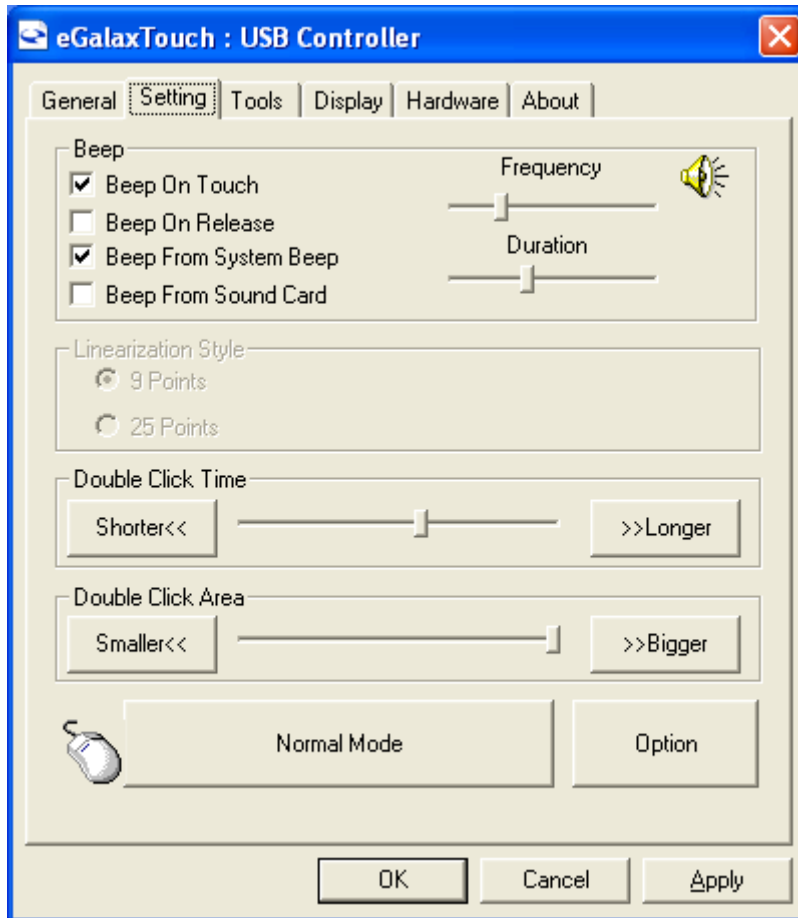

### Beep

- Beep On Touch
- Beep On Release
- Beep From System Beep
- Beep From Sound Card

### Linearization Style

- 9 points
- 25 points

### Double Click Time

- Shorter
- Longer

### Double Click Area

- Smaller
- Bigger

### Normal mode

- Simulate the mouse mode

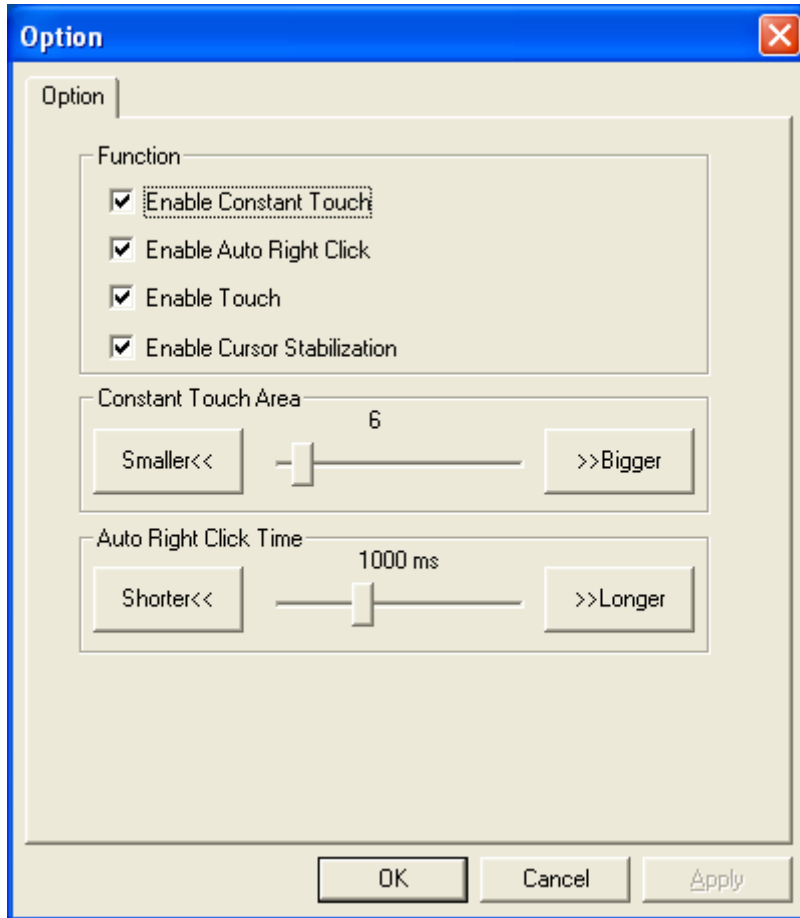

### Option

Function

Enable Constant Touch

Enable Auto Right Click

Enable Touch

Enable Cursor Stabilization

Constant Touch Area

Auto Right Click Time

## Tools

Click **OK** to continue the settings.

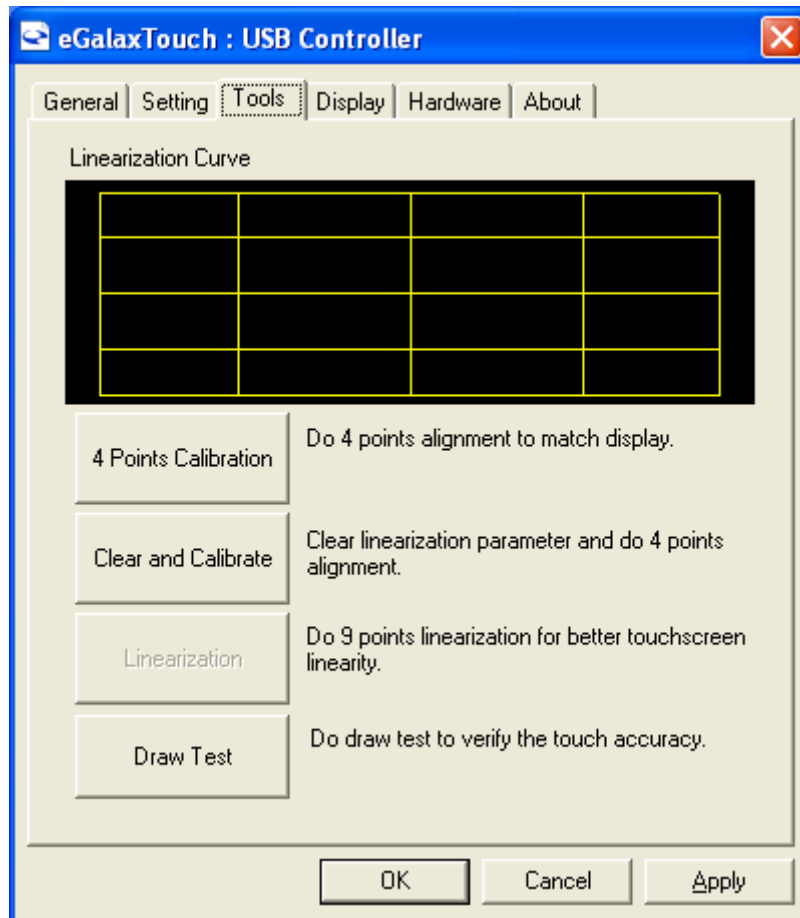

### **4 Points Calibration**

Do 4 points alignment to match display.

### **Clear and Calibrate**

Clear linearization parameter and do 4 points alignment.

### **Linearization**

Do 9 points linearization for better touchscreen linearity.

### **Draw Test**

Do draw test to verify the touch accuracy.

## Display

In this window, it shows the mode of display.

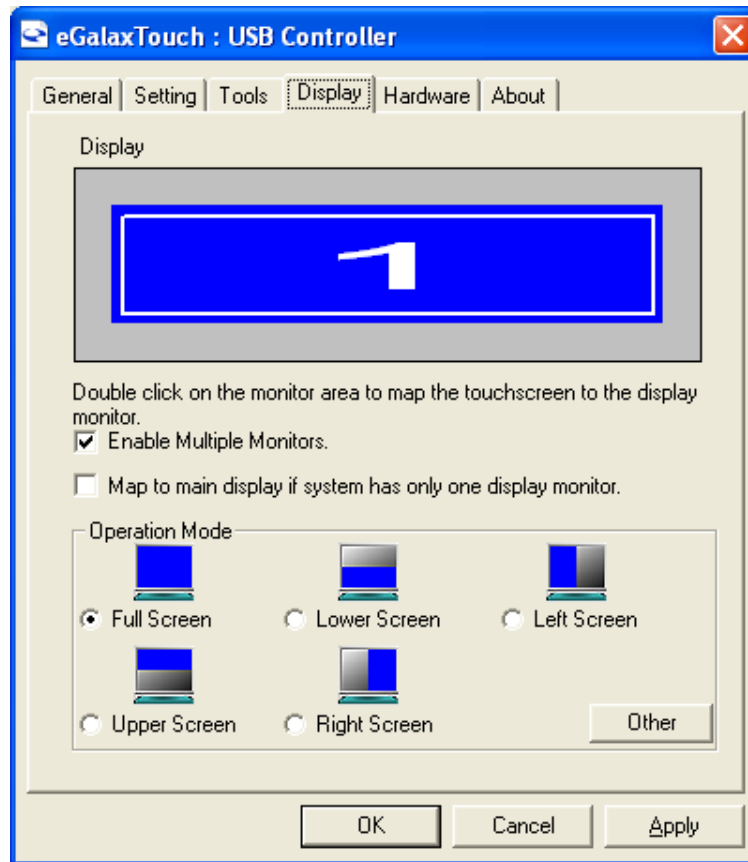

**Enable Multiple Monitors.**

**Map to main display if system has only one display monitor**

Full Screen

Lower Screen

Left Screen

Upper Screen

Right Screen

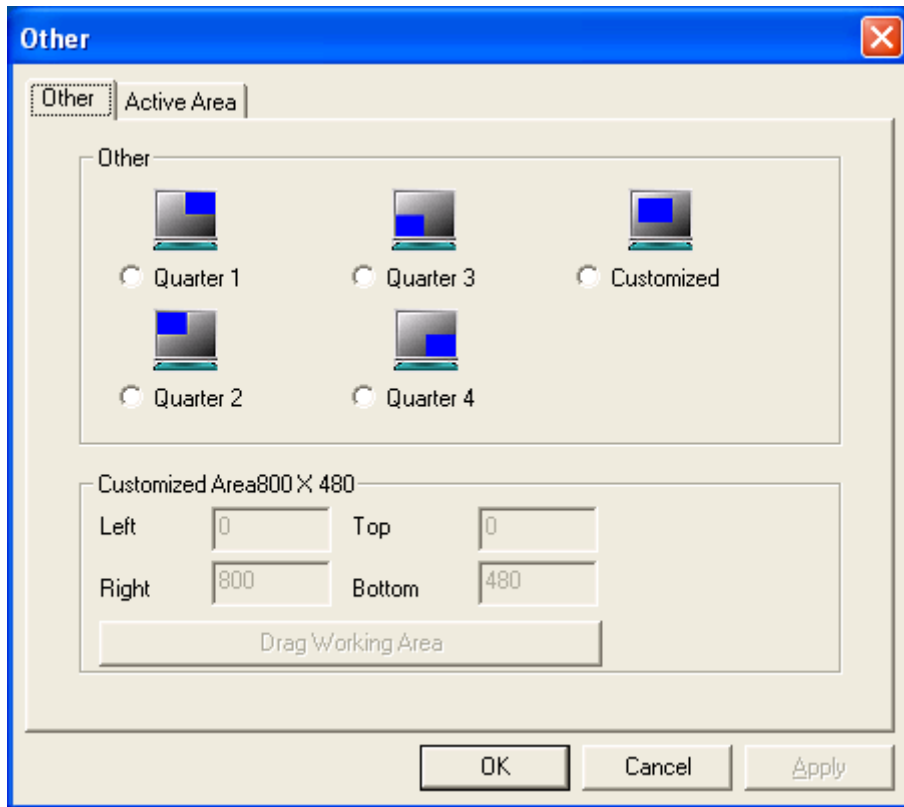

**Other**

Other mode of display. Quarter1~4 and Customized area.

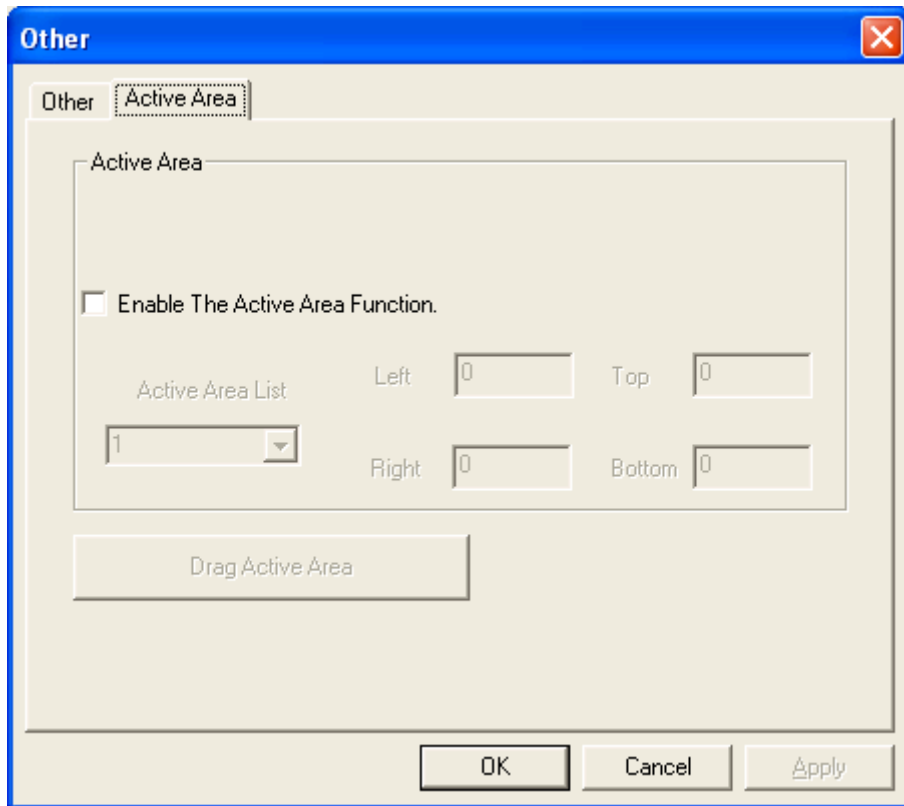

**Active Area**

Drag active area to enable Active Area Function.

## Hardware

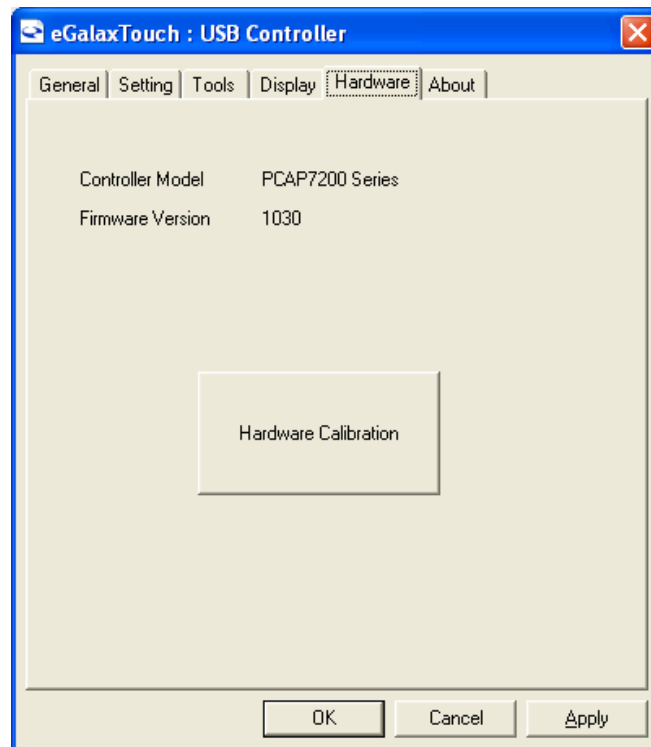

## Saturn Hardware Configuration

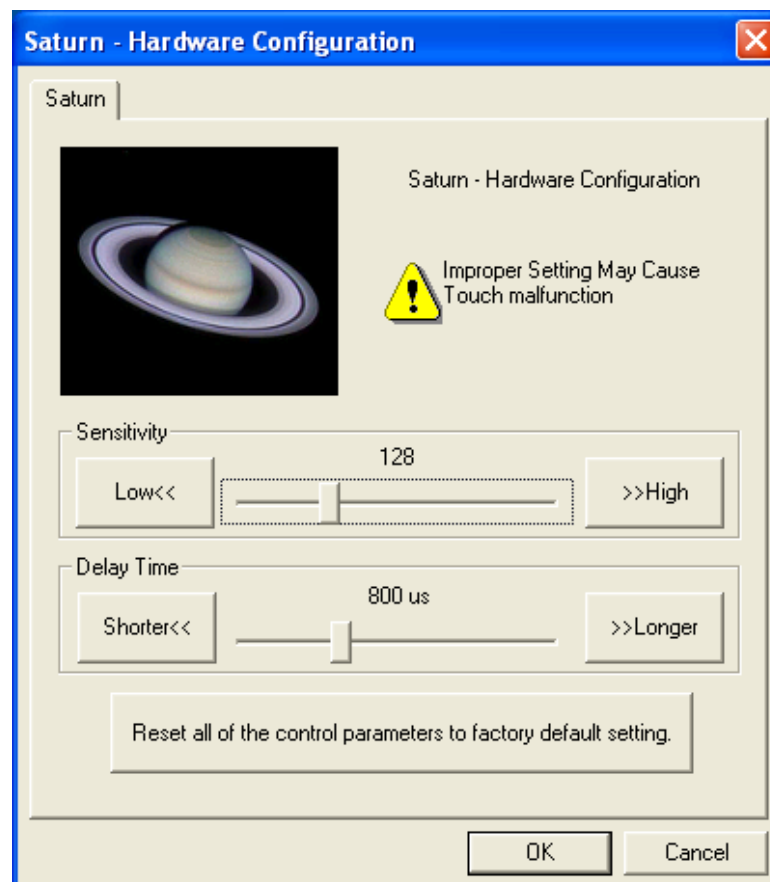



## About

To display information about eGalaxTouch and its version.

