

APC-2132

21.5" 6th Gen Intel® Core™ i7/i5/i3/Celeron Expantable Ultra
light Multi-Touch Fanless Panel PC

Quick Reference Guide

2nd Ed – 31 October 2017

Copyright Notice

Copyright © 2017 ALL RIGHTS RESERVED.

FCC Statement



THIS DEVICE COMPLIES WITH PART 15 FCC RULES. OPERATION IS SUBJECT TO THE FOLLOWING TWO CONDITIONS:

(1) THIS DEVICE MAY NOT CAUSE HARMFUL INTERFERENCE.

(2) THIS DEVICE MUST ACCEPT ANY INTERFERENCE RECEIVED INCLUDING INTERFERENCE THAT MAY CAUSE UNDESIRE OPERATION.

THIS EQUIPMENT HAS BEEN TESTED AND FOUND TO COMPLY WITH THE LIMITS FOR A CLASS "A" DIGITAL DEVICE, PURSUANT TO PART 15 OF THE FCC RULES.

THESE LIMITS ARE DESIGNED TO PROVIDE REASONABLE PROTECTION AGAINST HARMFUL INTERFERENCE WHEN THE EQUIPMENT IS OPERATED IN A COMMERCIAL ENVIRONMENT. THIS EQUIPMENT GENERATES, USES, AND CAN RADIATE RADIO FREQUENCY ENERGY AND, IF NOT INSTALLED AND USED IN ACCORDANCE WITH THE INSTRUCTION MANUAL, MAY CAUSE HARMFUL INTERFERENCE TO RADIO COMMUNICATIONS.

OPERATION OF THIS EQUIPMENT IN A RESIDENTIAL AREA IS LIKELY TO CAUSE HARMFUL INTERFERENCE IN WHICH CASE THE USER WILL BE REQUIRED TO CORRECT THE INTERFERENCE AT HIS OWN EXPENSE.

A Message to the Customer

Customer Services

Each and every product is built to the most exacting specifications to ensure reliable performance in the harsh and demanding conditions typical of industrial environments. Whether your new device is destined for the laboratory or the factory floor, you can be assured that your product will provide the reliability and ease of operation.

Your satisfaction is our primary concern. Here is a guide to our customer services. To ensure you get the full benefit of our services, please follow the instructions below carefully.

Technical Support

We want you to get the maximum performance from your products. So if you run into technical difficulties, we are here to help. For the most frequently asked questions, you can easily find answers in your product documentation. These answers are normally a lot more detailed than the ones we can give over the phone. So please consult the user's manual first.

Content

1.	Getting Started	5
1.1	Safety Precautions	5
1.2	Packing List.....	5
1.3	System Specifications	6
1.4	System Overview	9
1.4.1	Front View.....	9
1.4.2	Rear View	10
1.5	System Dimensions	11
2.	Hardware Configuration	12
2.1	APC-2132 connector mapping	13
2.1.1	Serial port 1 connector (COM1).....	13
2.1.2	Serial port 2 connector (COM2).....	13
2.2	Storage Installation	14
2.3	ARC-SKLU Overviews	15
2.4	ARC-SKLU Jumper and Connector list	16
2.5	ARC-SKLU Jumpers & Connectors settings	18
2.5.1	Clear CMOS (JCOMS1)	18
2.5.2	Serial port 1/2 pin9 signal select (JRI1/JRI2)	18
2.5.3	LCD backlight brightness adjustment (JBKLSEL1)	19
2.5.4	AT/ATX auto power on select (JAT1).....	19
2.5.5	Serial port 1 in RS-232/422/485 mode (JCOM1_SEL1).....	20
2.5.6	LCD Inverter connector (JBKL1)	20
2.5.7	On-board header for USB2.0 (JUSB1).....	21
2.5.8	On-board header for USB2.0 (JUSB2).....	21
2.5.9	On-board header for USB2.0 (JUSB3).....	22
2.5.10	Battery connector (JBAT1)	22
2.5.11	LVDS connector (JLVDS1)	23
2.5.12	Speaker_R (JSPR1)	24
2.5.13	Speaker_L (JSPL1)	24
2.5.14	SPI connector (JSPI1)	25
2.5.15	EC Debug connector (JEC1)	25
2.5.16	LCD backlight brightness adjustment (JBLK_CTRL1)	26
2.5.17	UPS-GPIO connector (JUUPS1).....	26
2.5.18	B2B connector (JB2B1)	27

APC-2132

2.5.19	SATA Power connector (SATAPW1).....	28
2.5.20	General purpose I/O connector (JGPIO1).....	28
2.5.21	Miscellaneous setting connector (JFP2)	29
2.5.22	LED connector (JLED1).....	29
2.5.23	Serial port 1 connector (COM1).....	30
2.6	ARC-SKLU DB-B Overviews.....	31
2.7	ARC-SKLU DB-B Jumper and Connector list.....	32
2.8	ARC-SKLU DB-B Jumpers & Connectors settings.....	33
2.8.1	Serial port 1 in RS-232/422/485 mode (JCOMSEL1).....	33
2.8.2	Audio connector (JMIC1).....	33
2.8.2.1	Signal Description – Audio connector (JMIC1).....	33
2.8.3	Serial port 1 connector (JCOM1).....	34
2.8.4	RS-422/RS-485 Termination Resistance connector (JCOMS1)	34
2.8.5	B2B connector (B2B1).....	35
2.8.6	USB connector 2 (JUSB2).....	36

1. Getting Started

1.1 Safety Precautions

Warning!



Always completely disconnect the power cord from your chassis whenever you work with the hardware. Do not make connections while the power is on. Sensitive electronic components can be damaged by sudden power surges. Only experienced electronics personnel should open the PC chassis.

Caution!



Always ground yourself to remove any static charge before touching the CPU card. Modern electronic devices are very sensitive to static electric charges. As a safety precaution, use a grounding wrist strap at all times. Place all electronic components in a static-dissipative surface or static-shielded bag when they are not in the chassis.

1.2 Packing List

- 1 x APC-2132 21.5" 6th Gen Intel® Core™ i7/i5/i3/Celeron Expantable Ultra light Multi-Touch Fanless Panel PC
- 1 x 19V/3.78A 72W power adapter
- 1 x power cord



If any of the above items is damaged or missing, contact your retailer.

1.3 System Specifications

Component	
Mother Board	SBC Share with ARC-SKLU (P/N: E9697ASKL05R i7-6600U/ 09R i5-6300U/ 10R i3-6100U, 11R Celeron 3955U)
CPU	Intel Core i/ Celeron BGA CPU (15W) 6th Gen Intel® Core™ i7-6600U, 2-Core, 2.6GHz processor 6th Gen Intel® Core™ i5-6300U, 2-Core, 2.4GHz processor 6th Gen Intel® Core™ i3-6100U, 2-Core, 2.3GHz processor 6th Gen Intel® Celeron® 3955U, 2-Core Processor
CPU Cooler (Type)	Heatsink
Memory	One 260-pin SODIMM Socket Up to 16GB DDR4 2133 SDRAM
Power Supply	DC in
Adapter	AC/DC adapter 19V/3.78A BCC-ADP-072N-01R
Speaker	0.5W *2
Camera	By optional
Wireless LAN	By optional (mini PCIe module)
Bluetooth	By optional (mini PCIe module)
Operating System	Support Win 7/8/10, Linux
Expansion Card	1* full size mini PCIe slot 1* half size mini PCIe slot (by IET module)
Storage	
Hard Disk Drive	By SATA port
Solid State Drive	By SATA port
Panel	
LCD Panel	21.5" AUO T215HVN01 (E96892X5022R):15.2W Or AUO G215HVN01.0 (E9689421500R): 23W
LCD Control Board	LED driving board: E968X000104R (only for T215HVN01)
Touch Screen	21.5" PCAP multi touch
Touch Controller	EETI EXC3188 (come with touch)
Others	Front power button & program buttons (daughter board: E9697173ME1R)
External I/O	
Serial Port	2 x DB-9 COM (COM1 RS-232/422/485, selectable by Jumper, RS-485)

	supports Auto Flow, Pin-9 selected by Ring/+5V/+12V, COM2 RS-232 only)
USB Port	4 x USB3.0 (2 x Double deck) 2 x USB2.0 (by IET module)
Video Port	HDMI (by IET module)
Audio Port	1 x Line out (by IET module) 1 x Mic in (by IET module)
LAN Port	1 x I219LM PHY, 1 x Intel I211AT GbE controller
Wireless LAN Antenna	Optional Internal antenna*2
Indicator Light	HDD LED, Power LED
Others	NA
Mechanical	
Power Type	DC in +12V ~ 26V
Power Connector Type	Lockable DC jack
Dimension	539.6 x 342.6 x 45.5mm
Weight	6.2kg
Color	Black plastic
Fanless	Yes
OS Support	Windows 7/8/10, Linux
Reliability	
EMI Test	CE/ FCC class B
Dust and Rain Test	Front Panel IP65
Vibration Test	<p>Random Vibration Operation</p> <p>Reference IEC60068-2-64 Testing procedures</p> <p>Test Fh : Vibration broadband random Test</p> <p>1 Test PSD : 0.00454G²/Hz , 1.5 Grms</p> <p>2 Test frequency : 5~500 Hz</p> <p>3 Test axis : X,Y and Z axis</p> <p>4 Test time : 30 minutes each axis</p> <p>5 System condition : operation mode</p> <p>6 Test curve</p> <p>Sine Vibration Test</p> <p>Reference IEC60068-2-6 Testing procedures</p> <p>Test Fc : Vibration sinusoidal</p> <p>1 Test Acceleration : 2G</p> <p>2 Test frequency : 5~500 Hz</p> <p>3 Sweep : 1 Oct/ per one minute. (logarithmic)</p> <p>4 Test axis : X,Y and Z axis</p> <p>5 Test time :10 min. each axis</p>

	<p>6 System condition : Non-Operating mode</p> <p>7 Test curve</p> <p>Package Vibration Test:</p> <p>Reference IEC60068-2-64 Testing procedures</p> <p>Test Fh : Vibration boardband random Test</p> <p>1 Test PSD : 0.026G²/Hz , 2.16 Grms</p> <p>2 Test frequency : 5~500 Hz</p> <p>3 Test axis : X,Y and Z axis</p> <p>4 Test time : 30 minutes each axis</p> <p>5 Test curve</p>
Mechanical Shock Test	With CF/SSD: 10Grms, IEC 60068-2-27, Half Sine, 11ms
Drop Test	<p>Package drop test</p> <p>Reference ISTA 2A, Method : IEC-60068-2-32 Test:Ed</p> <p>Test Ea : Drop Test</p> <p>1 Test phase : One corner, three edges, six faces</p> <p>2 Test high :</p> <p>3 Package weight :</p> <p>4 Test drawing</p>
Operating Temperature	0 ~ 40 degree
Operating Humidity	0 ~ 90% Relative Humidity, Non-condensing
Storage Temperature	-20 ~ 60 degree



Note: Specifications are subject to change without notice.

1.4 System Overview

1.4.1 Front View

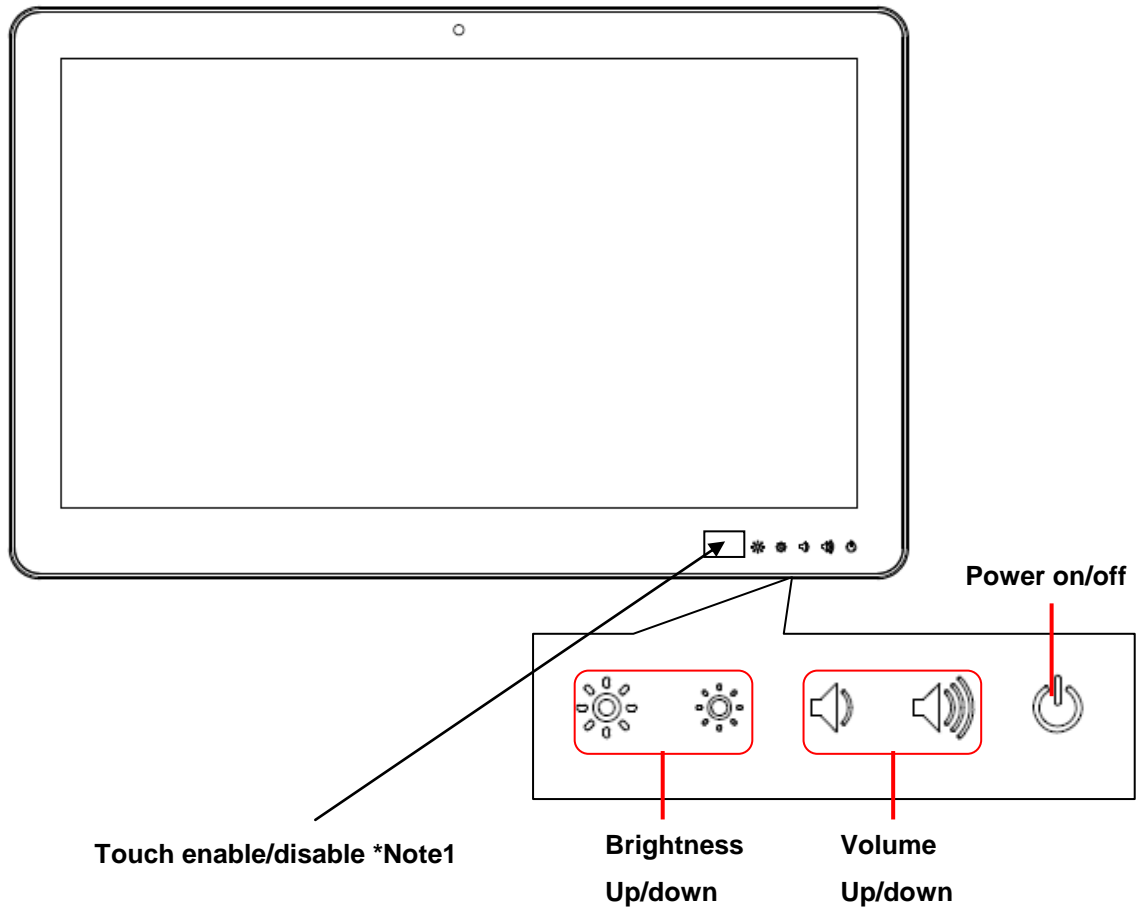

Note1:

Continue press 4 sec to disable and enable touch function.

1.4.2 Rear View

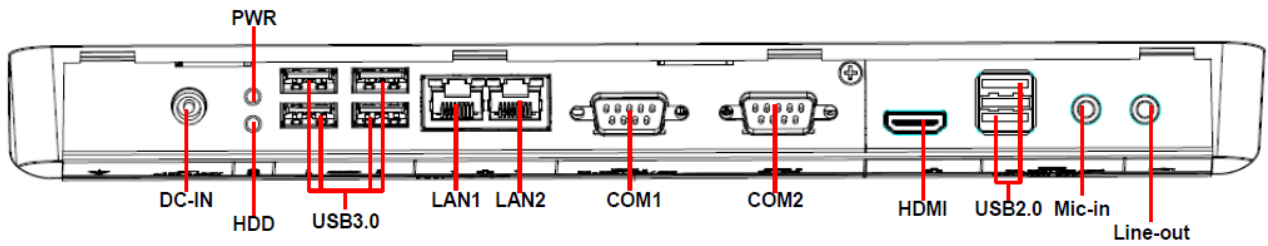

Connectors

Label	Function	Note
COM1/2	Serial port 1/2 connector	DB-9 male connector
DC in	DC-in power connector	
HDD	HDD LED	
PWR	Power LED	
LAN1/2	RJ-45 Ethernet 1/2	
Mic-in	Mic-in audio jack	
Line-out	Line-out audio jack	
Reset	Rest button	
USB	2 x USB 2.0 connector 4 x USB 3.0 connector	
HDMI	HDMI connector	

1.5 System Dimensions

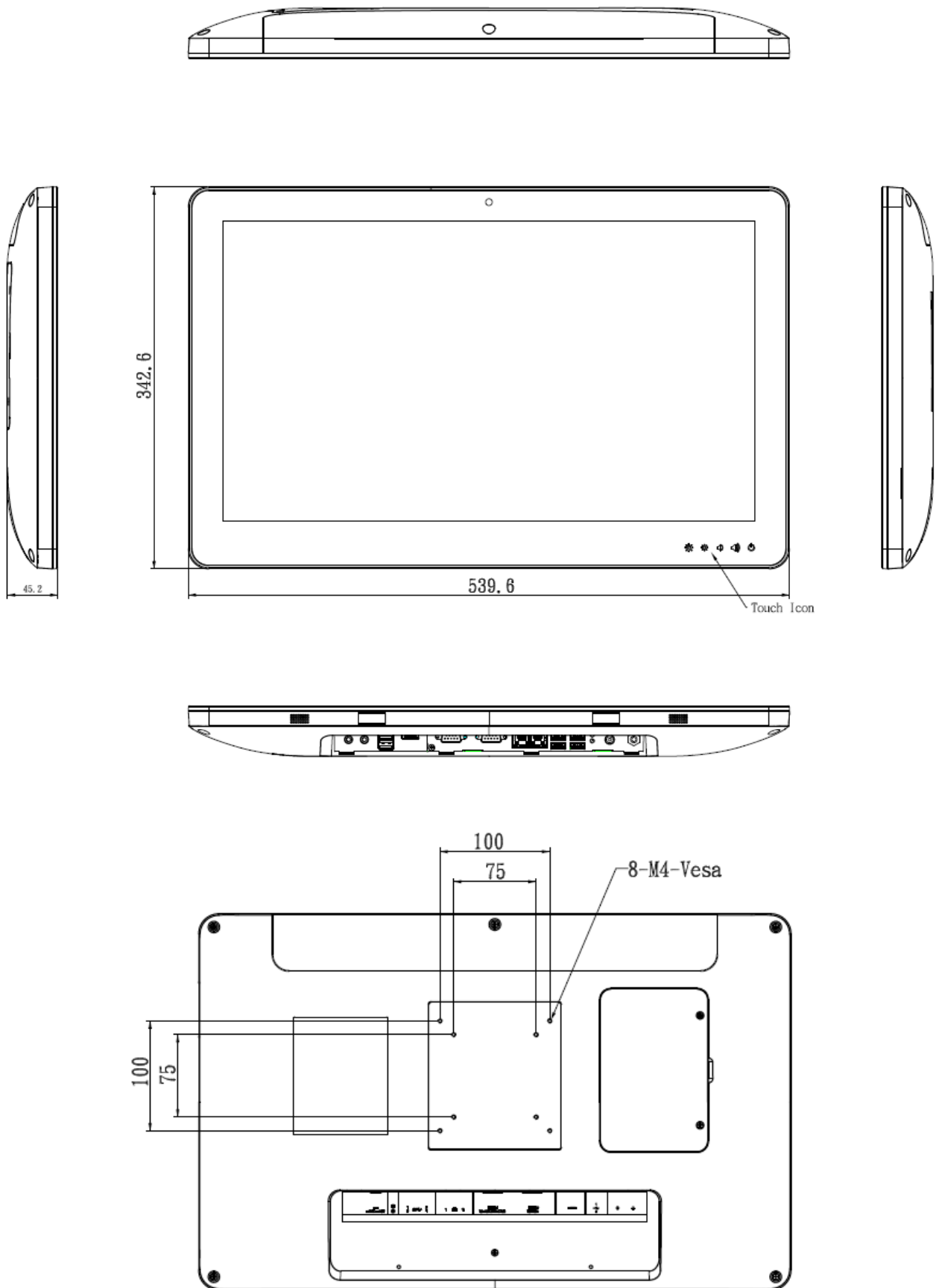

(Unit: mm)

2. Hardware Configuration

For advanced information, please refer to:

- 1- ARC-SKLU and ARC-SKLU DB-B included in this manual.

2.1 APC-2132 connector mapping

2.1.1 Serial port 1 connector (COM1)

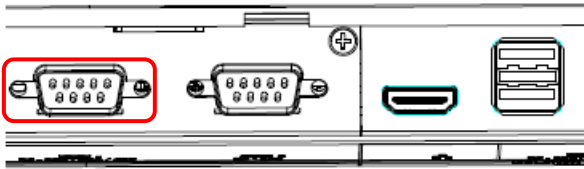

RS-485

Signal	PIN	PIN	Signal
DATA-	1	6	NC
DATA+	2	7	NC
NC	3	8	NC
NC	4	9	NC
GND	5		

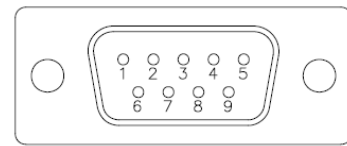

RS-232

Signal	PIN	PIN	Signal
DCD	1	6	DSR
RXD	2	7	RTS
TXD	3	8	CTS
DTR	4	9	RI
GND	5		

RS-422

Signal	PIN	PIN	Signal
TxD-	1	6	NC
TxD+	2	7	NC
RxD+	3	8	NC
RxD-	4	9	NC
GND	5		

2.1.2 Serial port 2 connector (COM2)

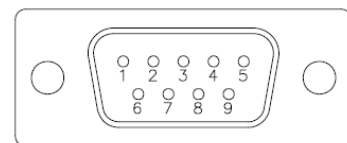
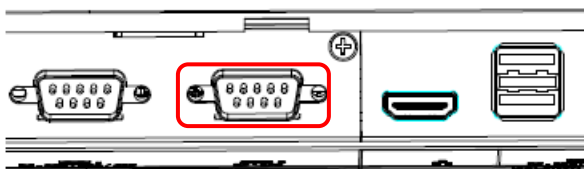

RS-232

Signal	PIN	PIN	Signal
DCD	1	6	DSR
RXD	2	7	RTS
TXD	3	8	CTS
DTR	4	9	RI
GND	5		

2.2 Storage Installation

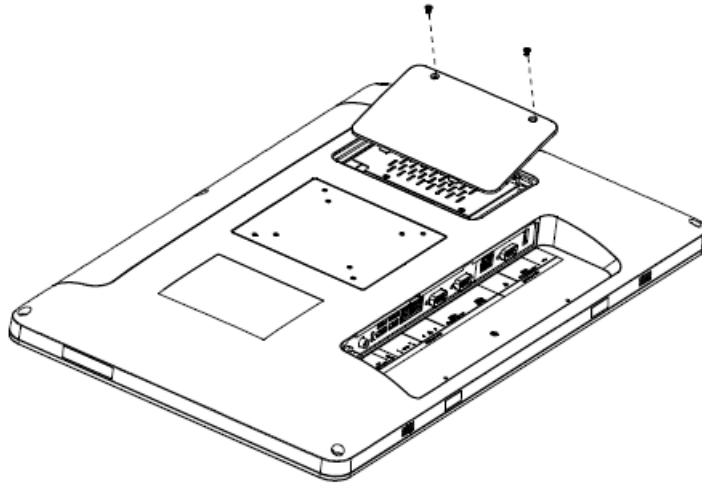

Step 1. Remove 2 screws to release the chassis cover, and remove it.

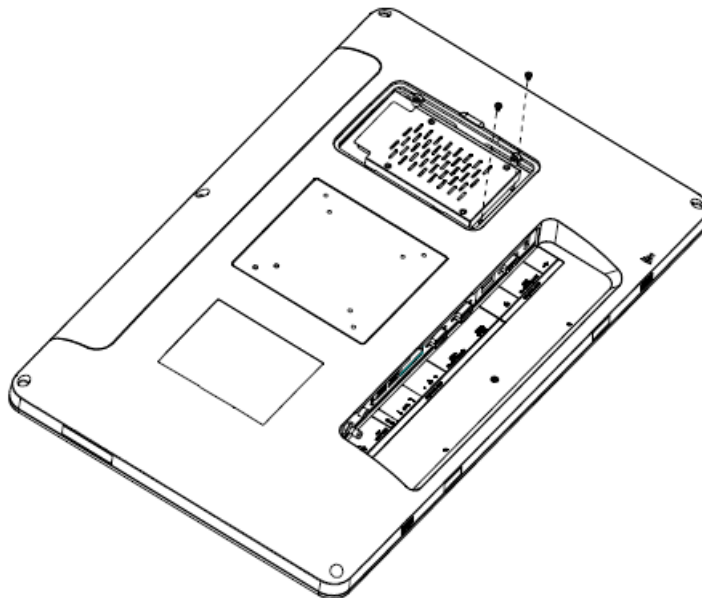

Step 2. Insert the HDD back and fasten 2 screws.

2.3 ARC-SKLU Overviews

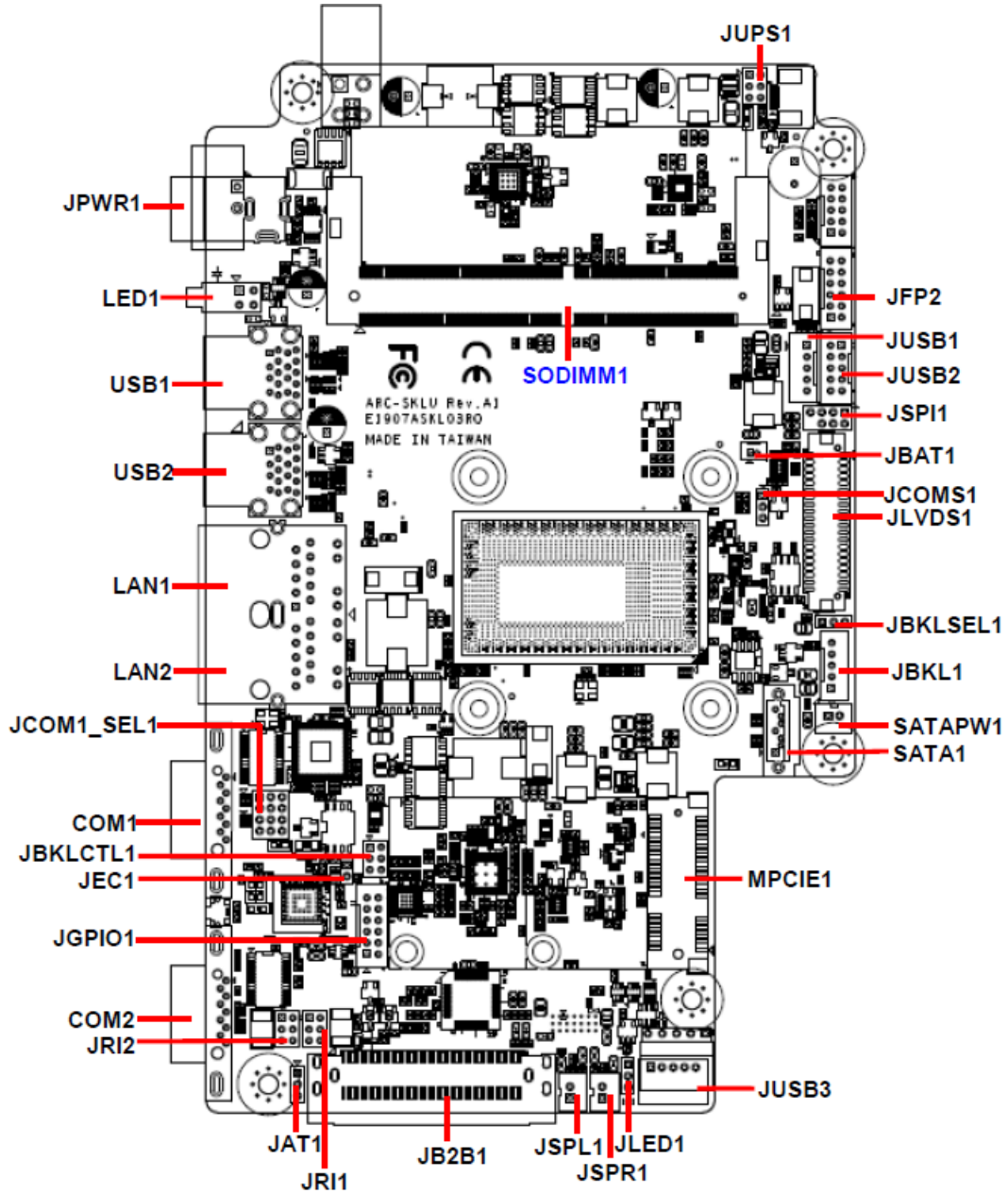

2.4 ARC-SKLU Jumper and Connector list

Jumpers

Label	Function	Note
JCOMS1	Clear CMOS	3 x 1 header, pitch 2.00mm
JRI1/2	Serial port 1/2 pin9 signal select	3 x 2 header, pitch 2.00mm
JCOM1_SEL1	Serial port 1 in RS-232/422/485 mode	4 x 3 header, pitch 2.00mm
JBKLSEL1	LCD backlight brightness adjustment	3 x 1 header, pitch 2.00mm
JAT1	AT/ATX auto power on select	3 x 1 header, pitch 2.00mm

Connectors

Label	Function	Note
SODIMM1	1 x 260-Pin DDR4 2133MHz SO-DIMM	
JBKL1	LCD Inverter connector	5 x 1 wafer, pitch 2.00mm
COM1/2	Serial port 1/2 connector	D-sub 9 pin, male
JSPR1	Speaker_R	2 x 1 wafer, pitch 2.00mm
JSPL1	Speaker_L	2 x 1 wafer, pitch 2.00mm
JB2B1	B2B connector	40 x 2 wafer, pitch 0.80mm
JBKLCTL1	LCD backlight brightness adjustment	3 x 2 header, pitch 2.00mm
LED1	HDD/Power LED indicator	
JLED1	LED connector	3 x 1 header, pitch 2.00mm
JFP2	Miscellaneous setting connector	5 x 2 wafer, pitch 2.00 mm
JLVDS1	LVDS connector	DIN 40-pin wafer, pitch 1.25mm
USB1/2	USB connector 1/2	
JUSB1	On-board header for USB2.0	5 x 1 wafer, pitch 2.00mm
JUSB2	On-board header for USB2.0	5 x 2 wafer, pitch 2.00mm
JUSB3	On-board header for USB2.0	5 x 1 wafer, pitch 2.00mm
LAN1/2	RJ-45 Ethernet 1/2	
MPCIE1	Mini-PCle connector	
JBAT1	Battery connector	2 x 1 wafer, pitch 1.25mm
JGPIO1	General purpose I/O connector	6 x 2 wafer, pitch 2.00mm
JUPS1	UPS-GPIO connector	3 x 2 header, pitch 2.00mm
JPWR1	Power connector	
JSPI1	SPI connector	4 x 2 header, pitch 2.00mm
JEC1	EC Debug connector	2 x 1 header, pitch 2.00 mm

SATA1	Serial ATA connector	
SATAPW1	SATA Power connector	2 x 1 wafer, pitch 2.00mm

2.5 ARC-SKLU Jumpers & Connectors settings

2.5.1 Clear CMOS (JCOMS1)

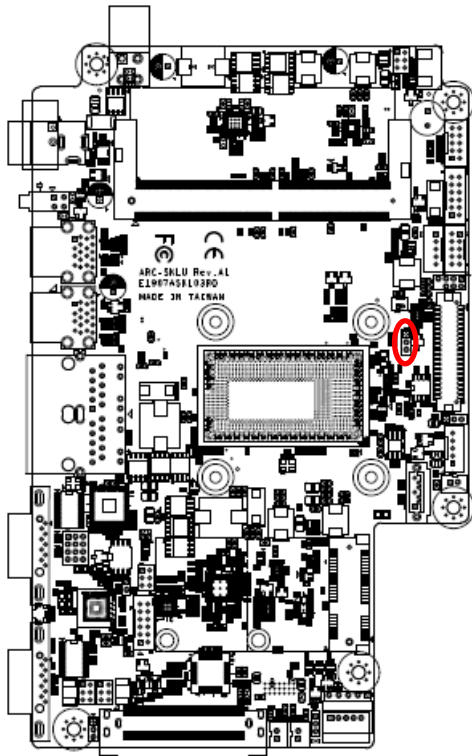

Protect*

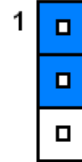

Clear CMOS

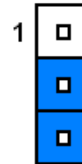

*Default

2.5.2 Serial port 1/2 pin9 signal select (JRI1/JRI2)

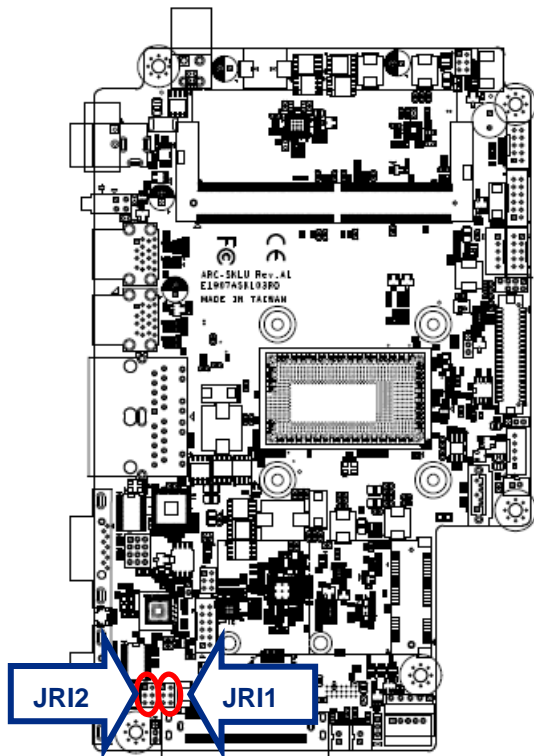

Ring*

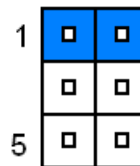

+5V

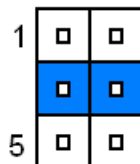

+12V

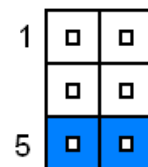

* Default

2.5.3 LCD backlight brightness adjustment (JBKLSEL1)

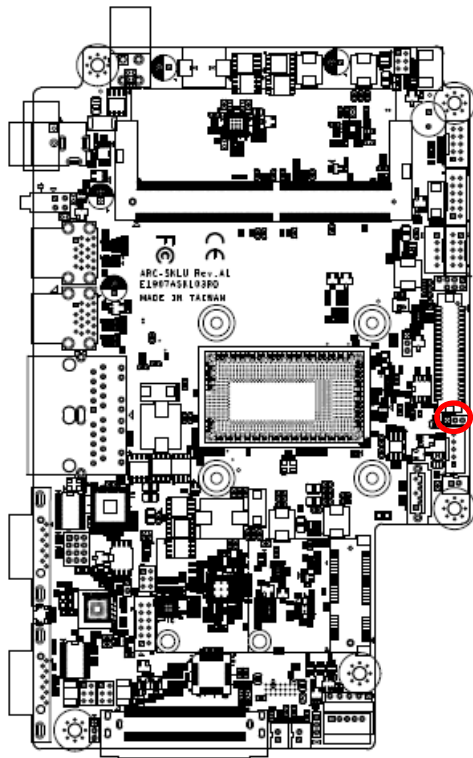

PWM Mode*

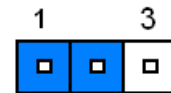

DC Mode

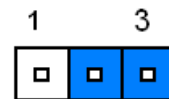

* Default

2.5.4 AT/ATX auto power on select (JAT1)

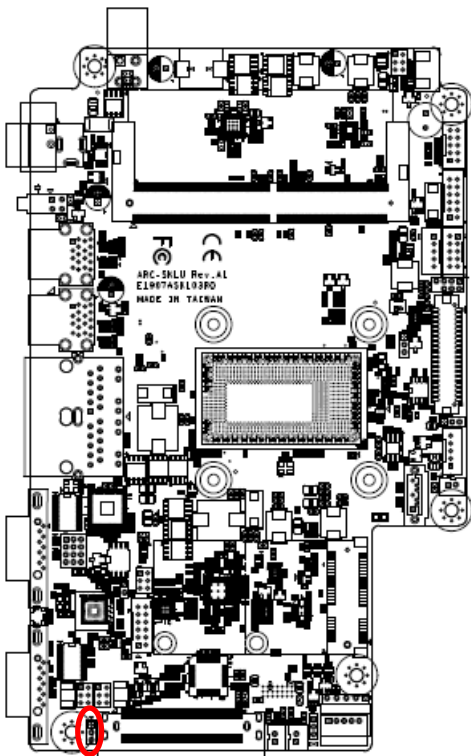

Power on by power button*

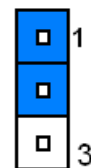

Auto power on

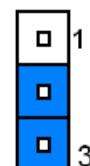

* Default

2.5.5 Serial port 1 in RS-232/422/485 mode (JCOM1_SEL1)

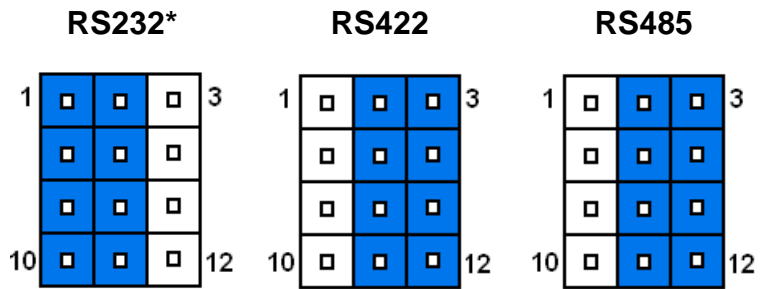
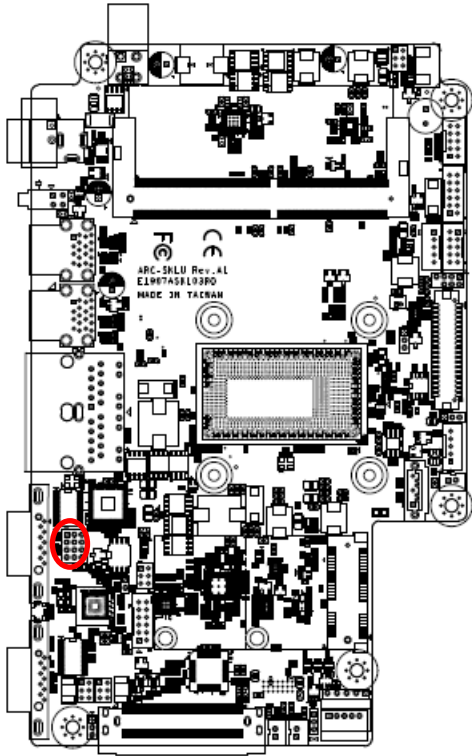

PIN	Signal	PIN	Signal	PIN	Signal
12	422RX1-	11	COM1-4	10	NDTRA#
9	485_422TX1+	8	COM1-2	7	NRXDA
6	422RX1+	5	COM1-3	4	NTXDA
3	485_422TX1-	2	COM1-1	1	NDCDA#

Note:

This connector is available after modify the mode of COM1 in BIOS setting.

* Default

2.5.6 LCD Inverter connector (JBKL1)

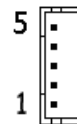
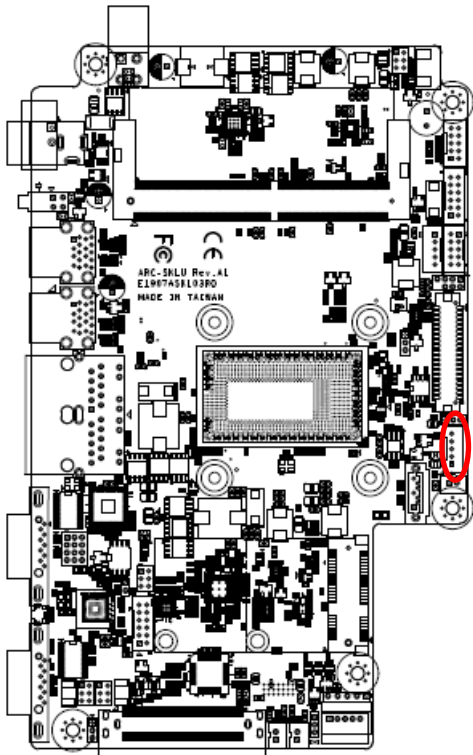

Signal	PIN
+5V	5
LVDS_BKLT_CTL	4
LVDS_BKLT_EN	3
GND	2
+12V	1

2.5.7 On-board header for USB2.0 (JUSB1)

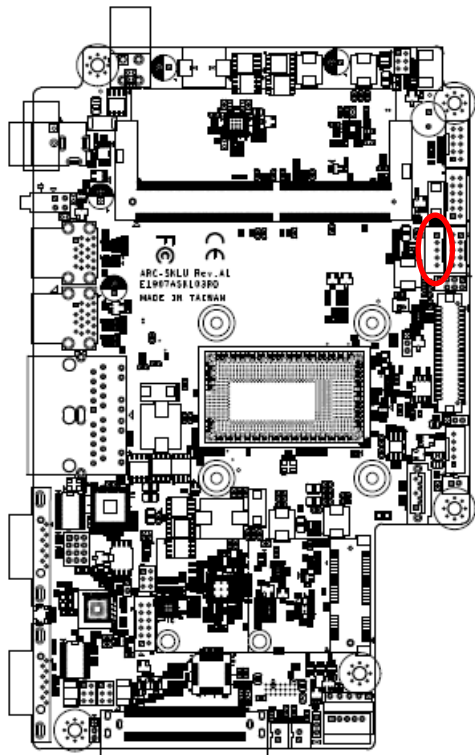

Signal	PIN
+5VSB	1
USB-	2
USB+	3
GND	4
GND	5

2.5.8 On-board header for USB2.0 (JUSB2)

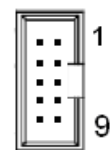
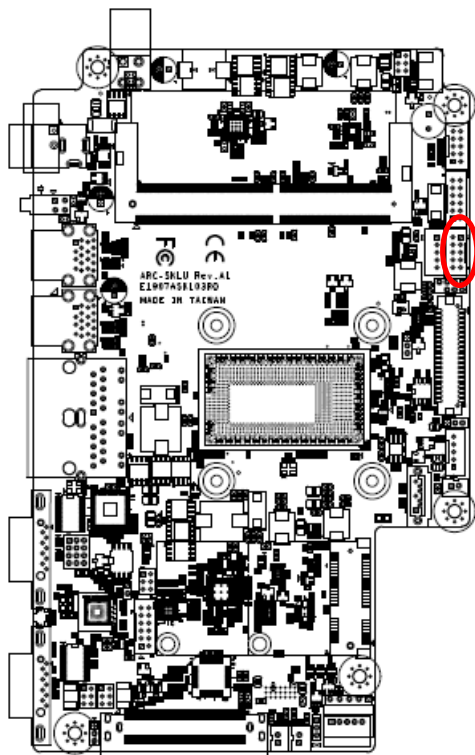

Signal	PIN	PIN	Signal
+5VSB	2	1	+5VSB
USB-	4	3	USB-
USB+	6	5	USB+
GND	8	7	GND
GND	10	9	GND

2.5.9 On-board header for USB2.0 (JUSB3)

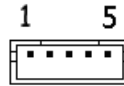
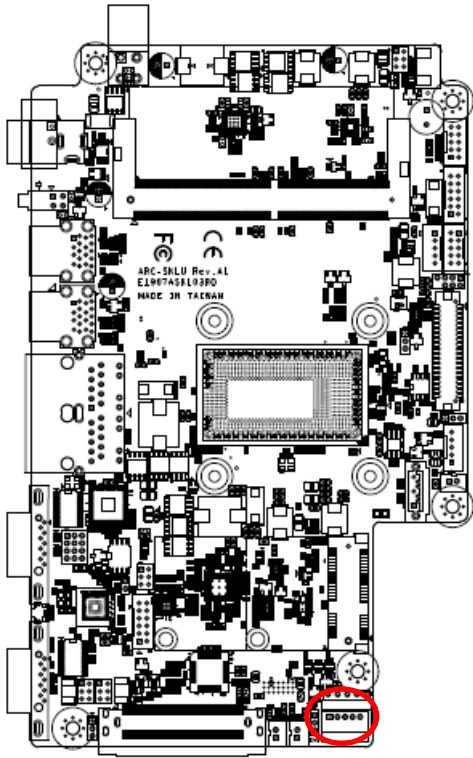

Signal	PIN
+5VSB	1
USB-	2
USB+	3
GND	4
GND	5

2.5.10 Battery connector (JBAT1)

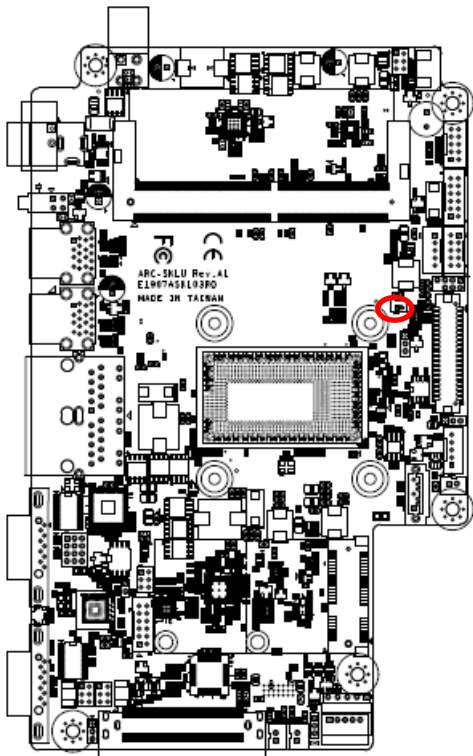

Signal	PIN
+RTCBAT	1
GND	2

2.5.11 LVDS connector (JLVDS1)

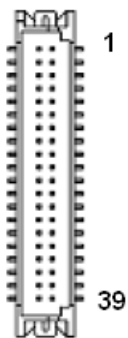
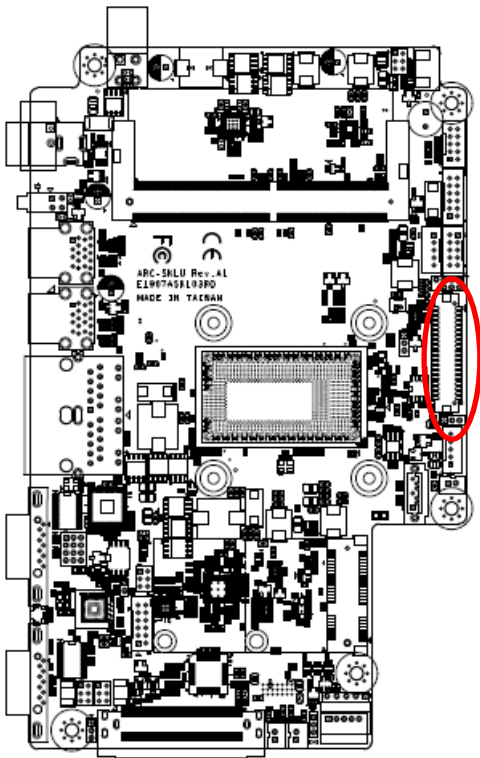

Signal	PIN	PIN	Signal
+5V	2	1	+3.3V
+5V	4	3	+3.3V
NC	6	5	NC
GND	8	7	GND
LVDS_DATA0_P	10	9	LVDS_DATA1_P
LVDS_DATA0_N	12	11	LVDS_DATA1_N
GND	14	13	GND
LVDS_DATA2_P	16	15	LVDS_DATA3_P
LVDS_DATA2_N	18	17	LVDS_DATA3_N
GND	20	19	GND
LVDS_DATA4_P	22	21	LVDS_DATA5_P
LVDS_DATA4_N	24	23	LVDS_DATA5_N
GND	26	25	GND
LVDS_DATA6_P	28	27	LVDS_DATA7_P
LVDS_DATA6_N	30	29	LVDS_DATA7_N
GND	32	31	GND
LVDS_CLK1_P	34	33	LVDS_CLK2_P
LVDS_CLK1_N	36	35	LVDS_CLK2_N
GND	38	37	GND
+12V	40	39	+12V

2.5.12 Speaker_R (JSPR1)

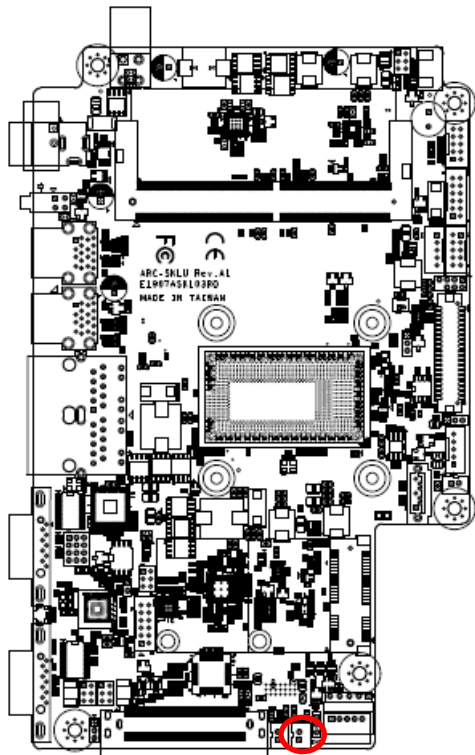

Signal	PIN
SPK_R-	2
SPK_R+	1

2.5.13 Speaker_L (JSPL1)

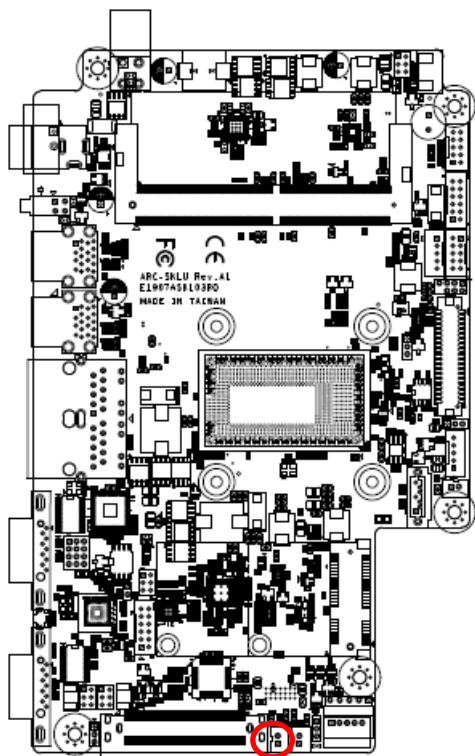

Signal	PIN
SPK_L-	2
SPK_L+	1

2.5.14 SPI connector (JSPI1)

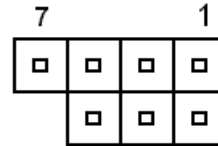
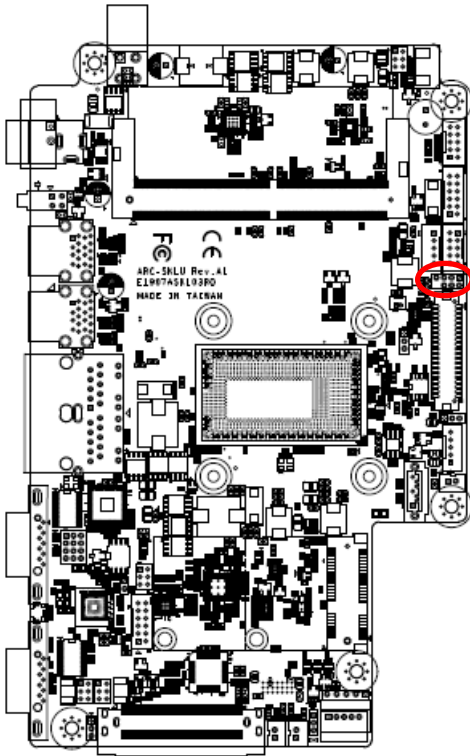

Signal	PIN	PIN	Signal
+3.3VSB	1	2	GND
SPI0_CS0#	3	4	SPI_CLK
SPI_SO	5	6	SPI_SI
HOLD#	7		

2.5.15 EC Debug connector (JEC1)

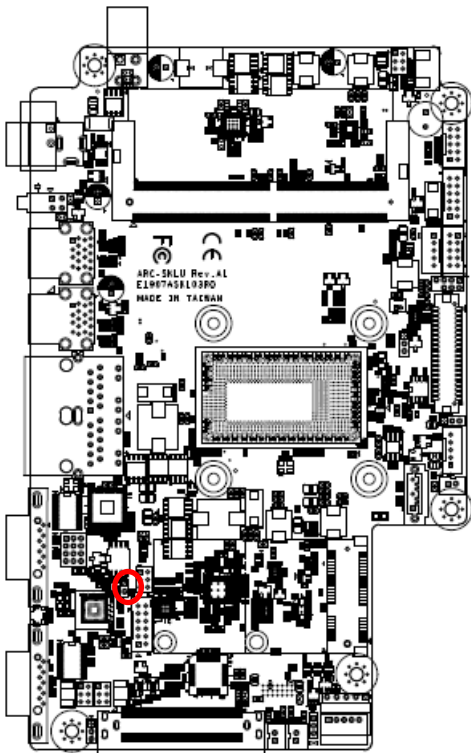

Signal	PIN
EC_SMCLK_DEBUG	1
EC_SMDAT_DEBUG	2

2.5.16 LCD backlight brightness adjustment (JBLK_CTRL1)

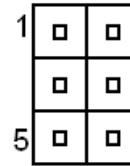
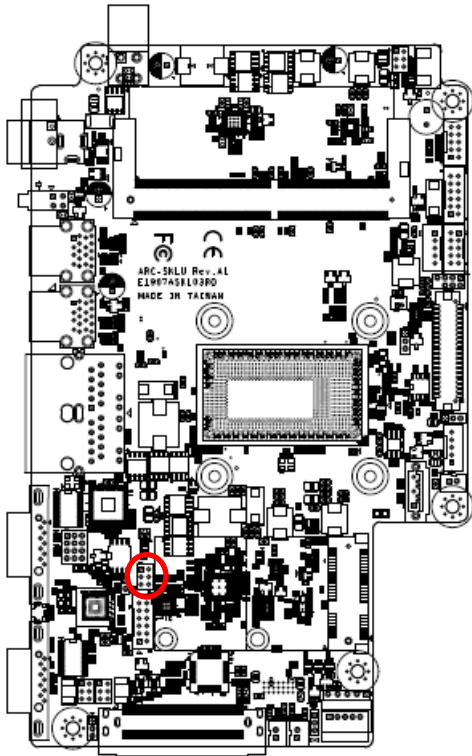

PIN	Signal	Note
1-2	BLK_VR_MOD	VR must select 10K/1%
3-4	BLK_BRI_UP	Low pulse button for backlight brighter
5-6	BLK_BRI_DN	Low pulse button for backlight dim

2.5.17 UPS-GPIO connector (JUPS1)

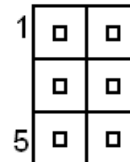
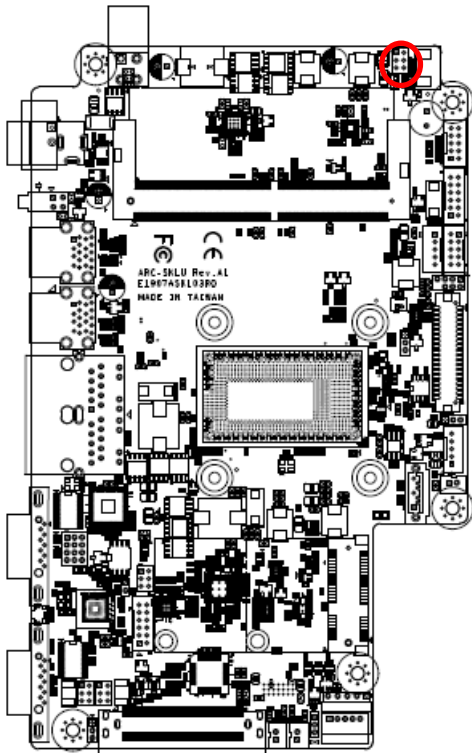

Signal	PIN	PIN	Signal
OFF_PC#	1	2	SMB_CLK
GND	3	4	SMB_DATA
GND	5	6	GND

2.5.18 B2B connector (JB2B1)

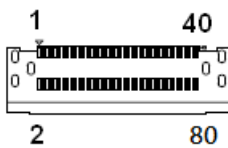
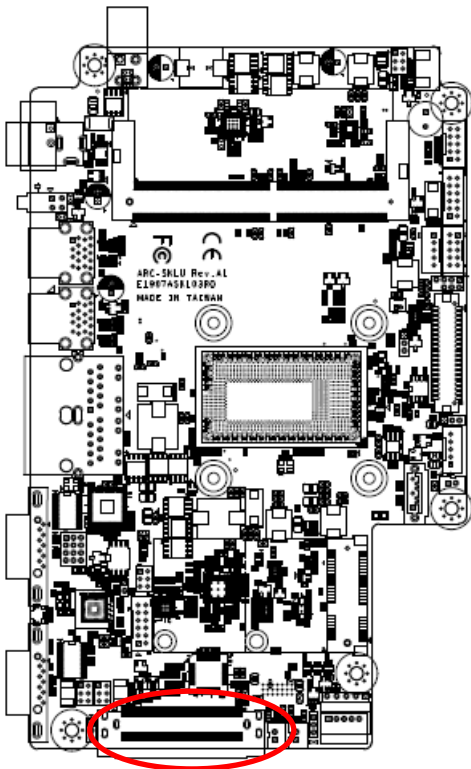

Signal	PIN	PIN	Signal
GND	1	41	GND
GND	2	42	GND
+12V	3	43	GND
+12V	4	44	GND
GND	5	45	GND
LPC_SERIRQ	6	46	+5VSB
LPC_LFRAME#	7	47	+5VSB
CLK3_LPC_B2B	8	48	+5VSB
LPC_AD0	9	49	+5VSB
LPC_AD1	10	50	+5VSB

Signal	PIN	PIN	Signal
LPC_AD2	11	51	GND
LPC_AD3	12	52	USB_PP8
PS_ON_B2B	13	53	USB_PN8
PLT_RST#	14	54	GND
PCH_SLP_S3#	15	55	SMBCLK
HDMI_HPD	16	56	SMBDATA
GND	17	57	GND
HDMI1_CTRL_CLK	18	58	BOARD_ID
HDMI1_CTRL_DAT	19	59	PCIEUSB3_PONRSTB
GND	20	60	PCIEUSB3_SMIB_INT#
HDMI1_TXN_2	21	61	B2BPCIE_WAKE#
HDMI1_TXP_2	22	62	RST_B2BPCIE#
GND	23	63	B2BPCIE_CLK_REQ#
HDMI1_TXN_1	24	64	GND
HDMI1_TXP_1	25	65	PCIE_TXN8
GND	26	66	PCIE_TXP8
HDMI1_TXN_0	27	67	GND
HDMI1_TXP_0	28	68	PCIE_RXN8
GND	29	69	PCIE_RXP8
HDMI1_CLKN	30	70	GND
HDMI1_CLKP	31	71	CLK_B2BPCIE_N2
GND	32	72	CLK_B2BPCIE_P2
GND	33	73	GND
MIC_RIN	34	74	GND
MIC_LIN	35	75	MIC1_JD
GND	36	76	GND
LINEOUT1_JD	37	77	LINE1_JD
LINEOUT_R	38	78	LINE1_RIN
LINEOUT_L	39	79	LNE1_LIN
GND	40	80	GND

2.5.19 SATA Power connector (SATAPW1)

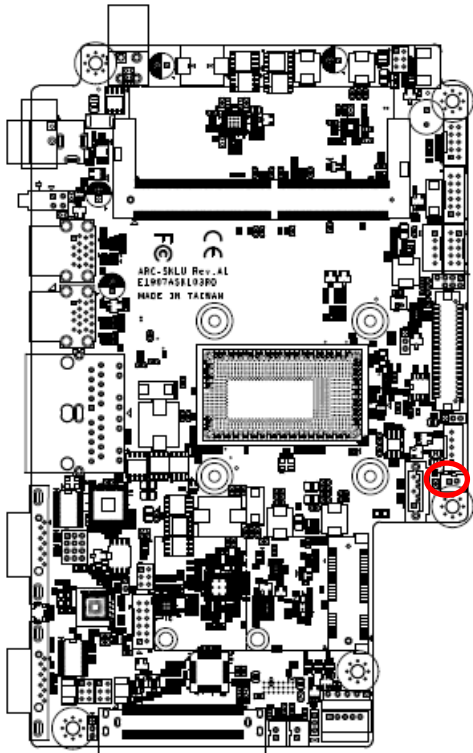

Signal	PIN
GND	1
+5V	2

2.5.20 General purpose I/O connector (JGPIO1)

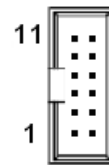
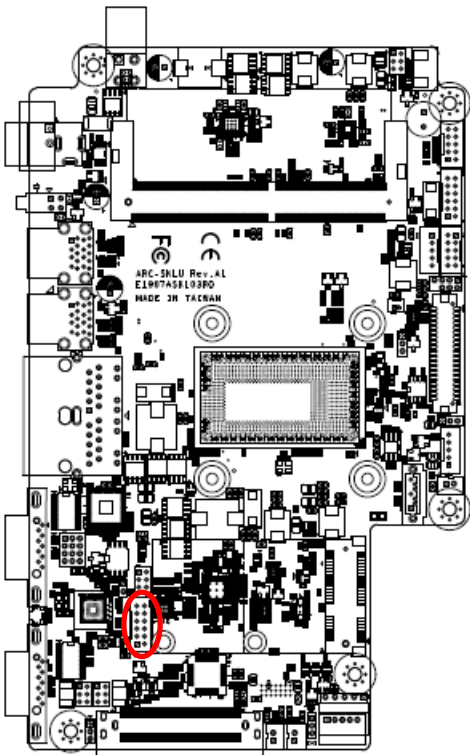

Signal	PIN	PIN	Signal
+3.3V	11	12	GND
SMB_DATA	9	10	SMB_CLK
DIO_GP23	7	8	DIO_GP13
DIO_GP22	5	6	DIO_GP12
DIO_GP21	3	4	DIO_GP11
DIO_GP20	1	2	DIO_GP10

2.5.21 Miscellaneous setting connector (JFP2)

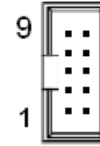
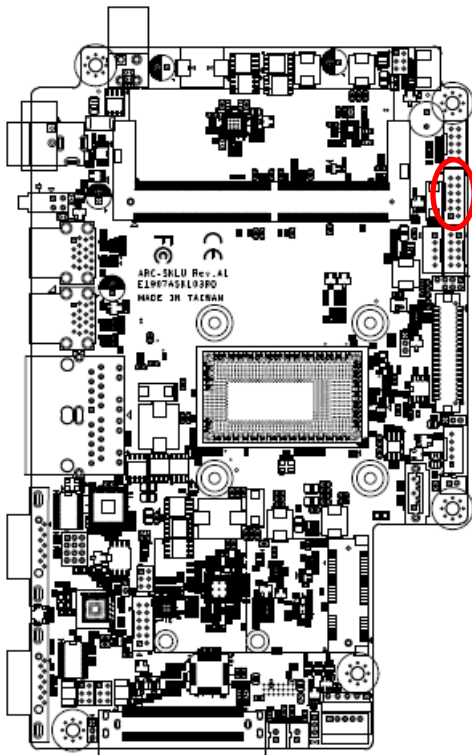

Signal	PIN	PIN	Signal
FP_LED1	9	10	FP_LED2
PWRBTN	7	8	LED_ONOFF#
BRI_DN#	5	6	BRI_UP#
VOL_DN#	3	4	VOL_UP#
GND	1	2	+3V

2.5.22 LED connector (JLED1)

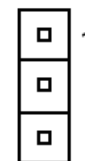
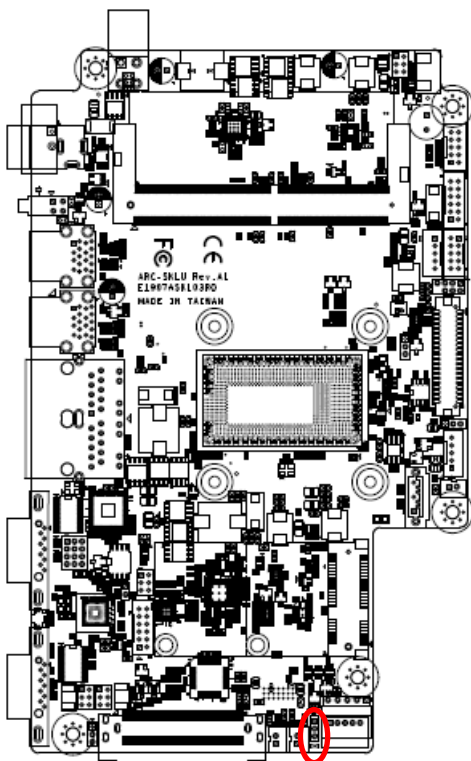

Signal	PIN
+5VSB	1
LED_BOARD_EN	2
GND	3

2.5.23 Serial port 1 connector (COM1)

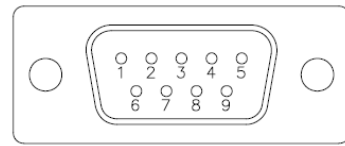
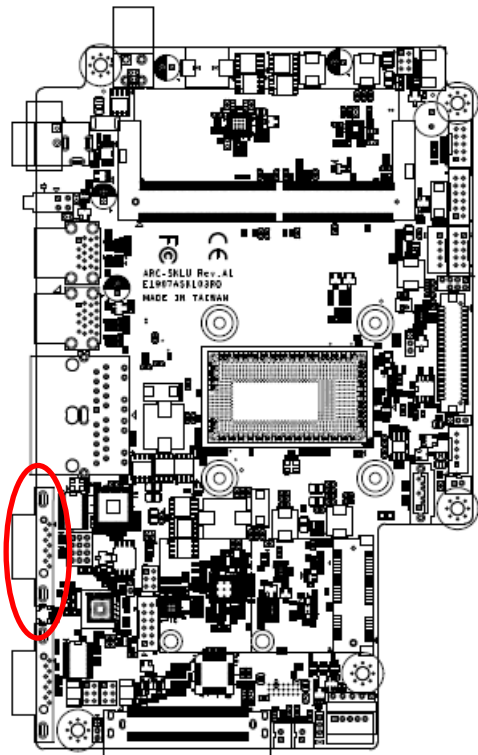

RS-232

Signal	PIN	PIN	Signal
DCD#	1	6	DSR#
RXD	2	7	RTS#
TXD	3	8	CTS#
DTR#	4	9	RI#
GND	5		

RS-422

Signal	PIN	PIN	Signal
422_Tx-	1	6	NC
422_Tx+	2	7	NC
422_Rx+	3	8	NC
422_Rx-	4	9	NC
GND	5		

RS-485

Signal	PIN	PIN	Signal
485_Tx-	1	6	NC
485_Tx+	2	7	NC
NC	3	8	NC
NC	4	9	NC
GND	5		

Note:

RS-232 mode is default, RS-422 and RS-485 changed setting by jumper(JCOM_SEL1).

2.6 ARC-SKLU DB-B Overviews

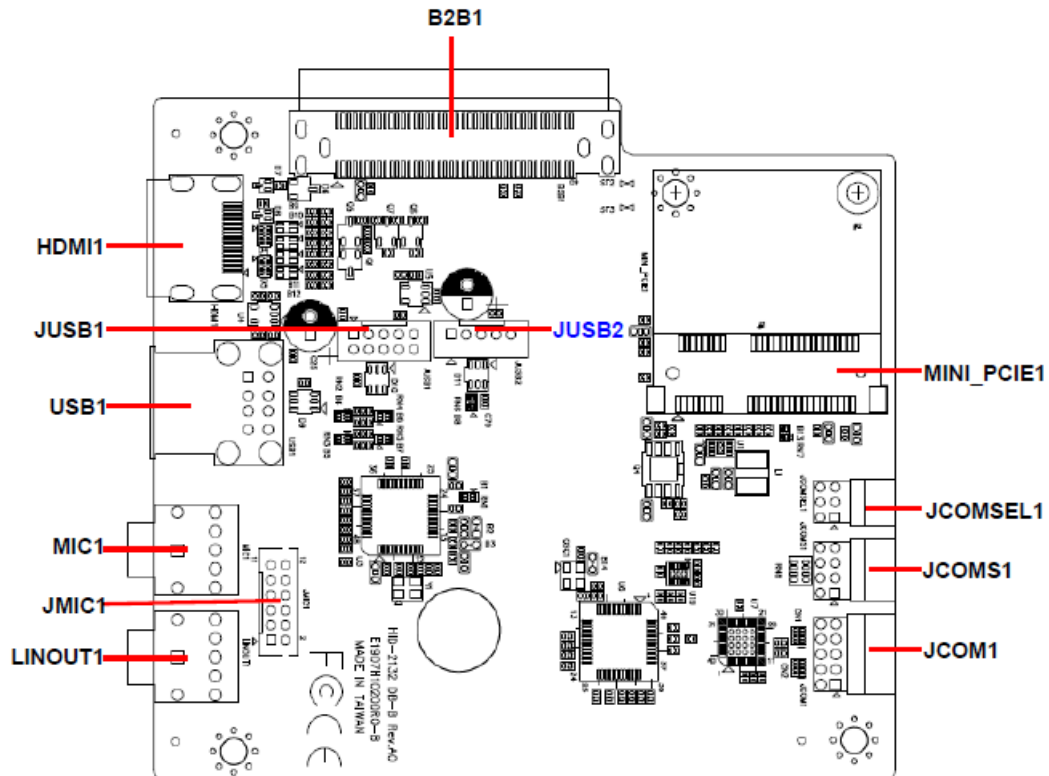

2.7 ARC-SKLU DB-B Jumper and Connector list

Jumpers

Label	Function	Note
JCOMSEL1	Serial port 1 in RS-232/422/485 mode	3 x 2 header, pitch 2.00mm

Connectors

Label	Function	Note
JCOM1	Serial port 1 connector	5 x 2 header, pitch 2.00mm
JCOMS1	RS-422/RS-485 Termination Resistance connector	4 x 2 header, pitch 2.00mm
B2B1	B2B connector	40 x 2 wafer, pitch 0.80mm
HDMI1	HDMI connector	
MIC1	Mic-in audio jack	
JMIC1	Audio connector (Reserved)	6 x 2 wafer, pitch 2.00mm
LINOUT1	Line-out audio jack	
MINI_PCIE1	Mini-PCIe connector	
USB1	USB connector x 2	
JUSB1	USB connector 1 (Reserved)	5 x 2 wafer, pitch 2.00mm
JUSB2	USB connector 2	5 x 1 wafer, pitch 2.00mm

2.8 ARC-SKLU DB-B Jumpers & Connectors settings

2.8.1 Serial port 1 in RS-232/422/485 mode (JCOMSEL1)

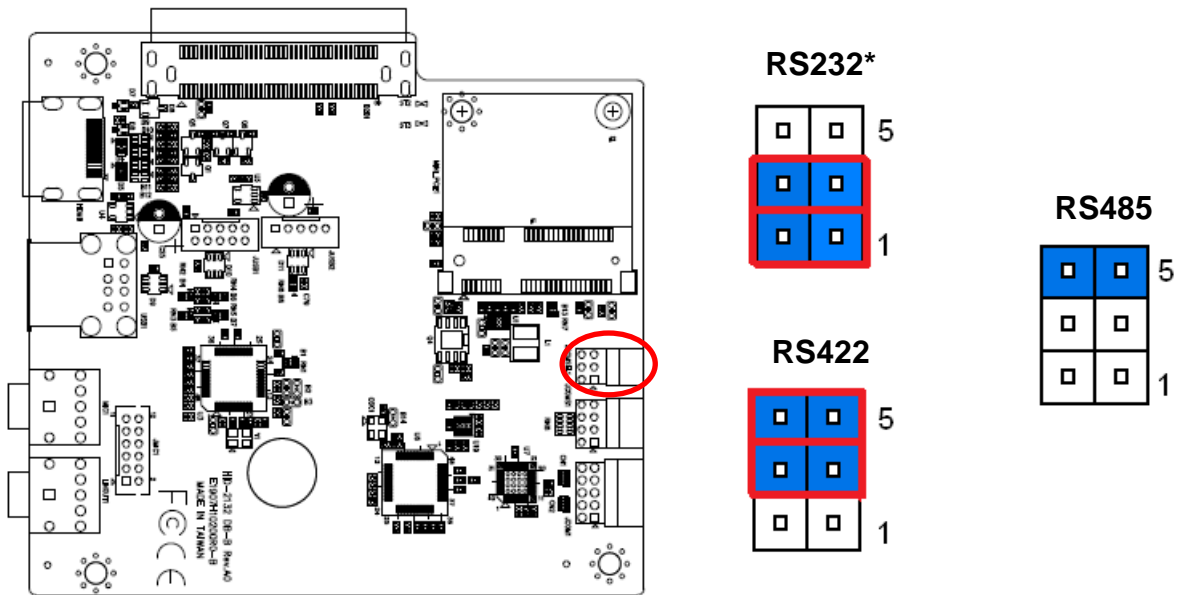

*Default

2.8.2 Audio connector (JM1C1)

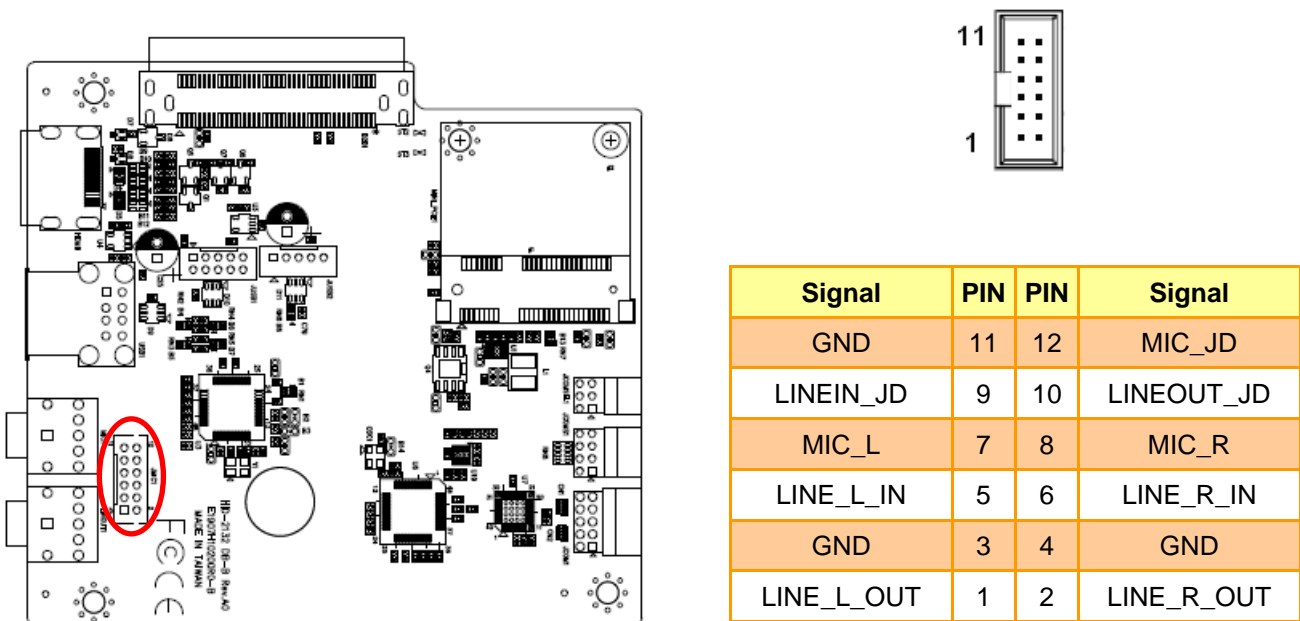

2.8.2.1 Signal Description – Audio connector (JM1C1)

Signal	Signal Description
LINEOUT_JD	AUDIO Out(ROUT/LOUT) sense pin
MIC_JD	MIC IN (MIC_RIN/LIN) sense pin

Note:

Line in function unavailable.

2.8.3 Serial port 1 connector (JCOM1)

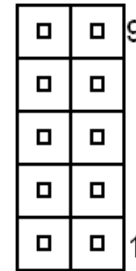
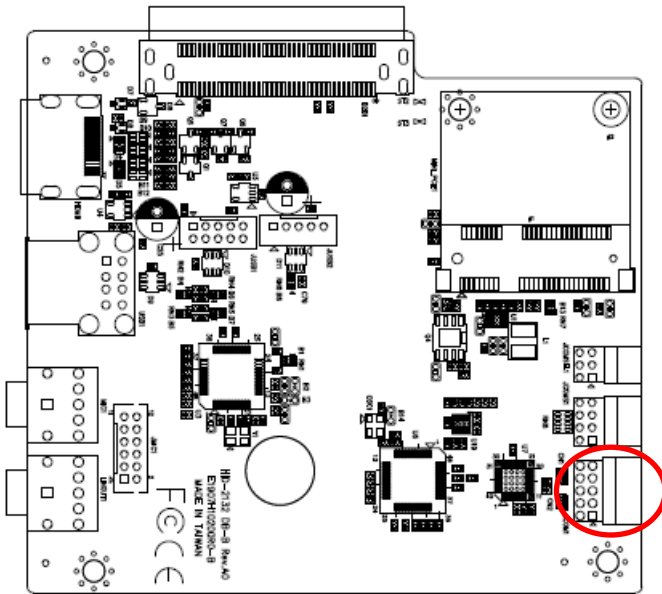

Signal	PIN	PIN	Signal
NC	10	9	NR11#
NCTS1#	8	7	NRTS1#
NDSR1#	6	5	GND
NDTR1#	4	3	NTXD1
NRXD1	2	1	NDCD1#

2.8.4 RS-422/RS-485 Termination Resistance connector (JCOMS1)

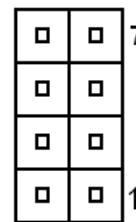
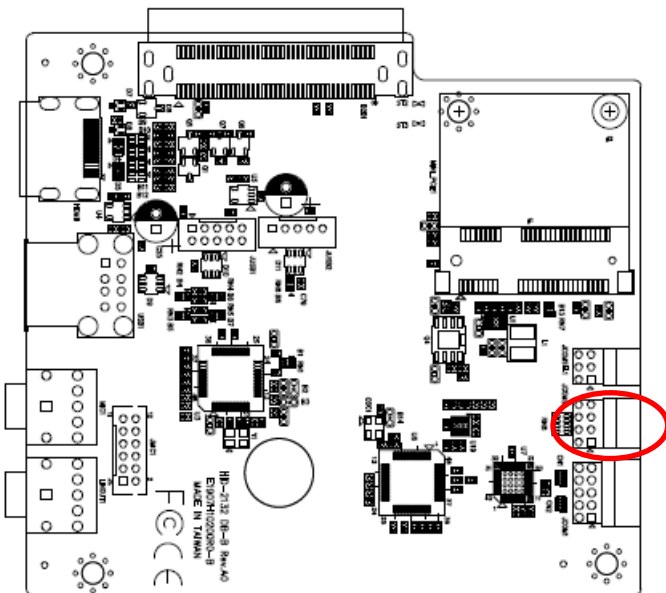

Signal	PIN	PIN	Signal
GND	8	7	NDTR1#
GND	6	5	NDCD1#
+5V	4	3	NRXD1
+5V	2	1	NTXD1

2.8.5 B2B connector (B2B1)

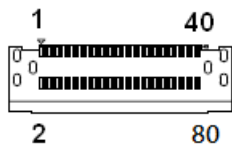
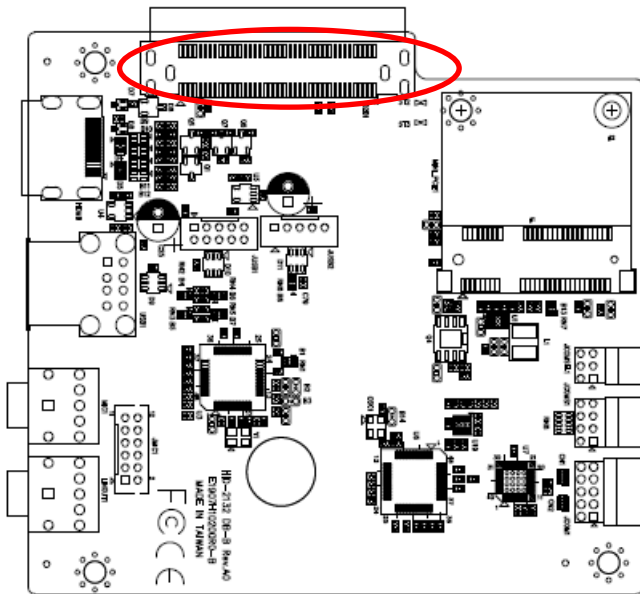

Signal	PIN	PIN	Signal
GND	1	41	GND
GND	2	42	GND
NC	3	43	GND
NC	4	44	GND
GND	5	45	GND
LPC_SERIRQ	6	46	+5VSB
LPC_FRAME#	7	47	+5VSB
LPC_CLK	8	48	+5VSB
LPC_AD0	9	49	+5VSB
LPC_AD1	10	50	+5VSB

Signal	PIN	PIN	Signal
LPC_AD2	11	51	GND
LPC_AD3	12	52	USB_DP_A
PS_ON	13	53	USB_DN_A
PLT_RST#	14	54	GND
NC	15	55	SMBDATA
HDMI_HPD0	16	56	SMBCLK
GND	17	57	GND
HDMI1_CTRLCLK	18	58	BOARD_ID
HDMI1_CTRLDATA	19	59	PONRSTB
GND	20	60	NC
HDMI1_TXN2	21	61	MPCIE_WAKE#
HDMI1_TXP2	22	62	MPCIE_RESET#
GND	23	63	MPCIE_CLKREQ#
HDMI1_TXN1	24	64	GND
HDMI1_TXP1	25	65	MPCIE1_TX-
GND	26	66	MPCIE1_TX+
HDMI1_TXN0	27	67	GND
HDMI1_TXP0	28	68	MPCIE1_RX-
GND	29	69	MPCIE1_RX+
HDMI1_CLK_N	30	70	GND
HDMI1_CLK_P	31	71	MPCIE_CLK-
GND	32	72	MPCIE_CLK+
GND	33	73	GND
MIC_R	34	74	GND
MIC_L	35	75	MIC_JD
GND	36	76	GND
LINEOUT_JD	37	77	LINEIN_JD
LINE_R_OUT	38	78	LINE_R_IN
LINE_L_OUT	39	79	LINE_L_IN
GND	40	80	GND

2.8.6 USB connector 2 (JUSB2)

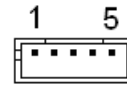
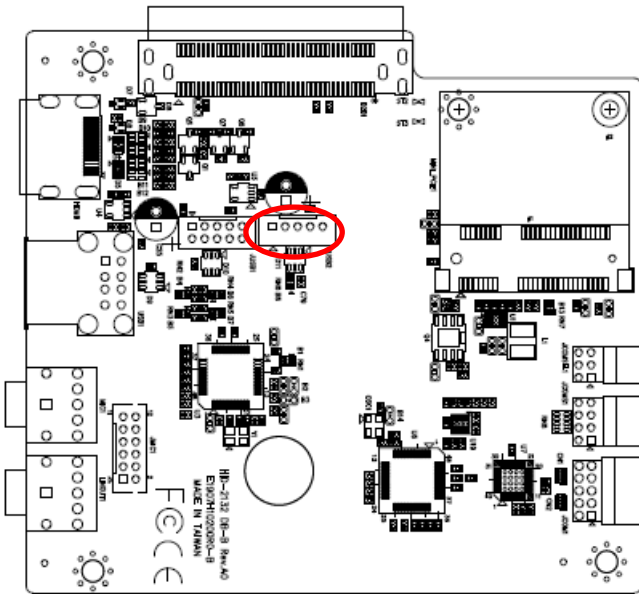

Signal	PIN
USBVCC2	1
USB_DN_R_3	2
USB_DP_R_3	3
GND	4
GND	5