

AMI210

User Manual

2016 May Ver. A1

Copyright © 2014 IBASE Technology Inc. All Rights Reserved.

No part of this manual, including the products and software described in it, may be reproduced, transmitted, transcribed, stored in a retrieval system, or translated into any language in any form or by any means, except documentation kept by the purchaser for backup purposes, without the express written permission of IBASE Technology INC. ("IBASE").

Products and corporate names mentioned in this manual may or may not be registered trademarks or copyrights of their respective companies, and are used for identification purposes only. All trademarks are the property of their respective owners.

Every effort has been made to ensure that the contents of this manual are correct and up to date. However, the manufacturer makes no guarantee regarding the accuracy of its contents, and reserves the right to make changes without prior notice.

Table of Contents

Setting up your system.....	3
Care during use.....	4
Acknowledgments	4
CHAPTER 1 INTRODUCTION.....	6
1.1 General Description.....	6
1.2 System Specifications	7
1.2.1 Hardware Specifications	7
1.2.2 Dimensions	10
1.2.3 I/O View	12
1.3 Exploded View of the AMI210/AMI210-PE Assembly.....	14
1.3.1 Parts Description	15
1.4 Packing List	18
1.4.1 Optional Items	18
CHAPTER 2 MOTHERBOARD INTRODUCTION	19
2.1 Introduction.....	19
2.2 Board Dimensions	23
2.3 Setting the Jumpers.....	24
2.4 Jumper Locations on MB210.....	24
CHAPTER 3 BIOS SETUP	35
CHAPTER 4 DRIVERS INSTALLATION	58
4.1 Intel Chipset Software Installation Utility.....	59
4.2 VGA Drivers Installation.....	62
4.3 Realtek HD Audio Driver Installation	65
4.4 LAN Drivers Installation	66
4.5 Intel Management Engine Interface	69
4.6 USB 3.0 Drivers.....	71
Appendix	73
Mounting AMI210 to the wall	73
Mounting AMI210-PE to the wall.....	74
Wall Mounting Requirements.....	75
Selecting the Location	75
Watchdog Timer Configuration.....	76

Safety Information

Your AMI210 is designed and tested to meet the latest standards of safety for information technology equipment. However, to ensure your safety, it is important that you read the following safety instructions

Setting up your system

- Read and follow all instructions in the documentation before you operate your system.
- Do not use this product near water.
- Set up the system on a stable surface. Do not secure the system on any unstable plane.
- Do not place this product on an unstable cart, stand, or table. The product may fall, causing serious damage to the product.
- Slots and openings on the chassis are for ventilation. Do not block or cover these openings. Make sure you leave plenty of space around the system for ventilation. ***Never insert objects of any kind into the ventilation openings.***
- This system should be operated from the type of power indicated on the marking label. If you are not sure of the type of power available, consult your dealer or local power company.
- Use this product in environments with ambient temperatures between 0°C and 40°C.
- If you use an extension cord, make sure that the total ampere rating of the devices plugged into the extension cord does not exceed its ampere rating.
- DO NOT LEAVE THIS EQUIPMENT IN AN ENVIRONMENT WHERE THE STORAGE TEMPERATURE MAY GO BELOW -20° C (-4° F) OR ABOVE 80° C (176° F). THIS COULD DAMAGE THE EQUIPMENT. THE EQUIPMENT SHOULD BE IN A CONTROLLED ENVIRONMENT.

Care during use

- Do not walk on the power cord or allow anything to rest on it.
- Do not spill water or any other liquids on your system.
- When the system is turned off, a small amount of electrical current still flows. Always unplug all power, and network cables from the power outlets before cleaning the system.
- If you encounter the following technical problems with the product, unplug the power cord and contact a qualified service technician or your retailer.
 - The power cord or plug is damaged.
 - Liquid has been spilled into the system.
 - The system does not function properly even if you follow the operating instructions.
 - The system was dropped or the cabinet is damaged.

Lithium-Ion Battery Warning

CAUTION: Danger of explosion if battery is incorrectly replaced. Replace only with the same or equivalent type recommended by the manufacturer. Dispose of used batteries according to the manufacturer's instructions.

NO DISASSEMBLY

The warranty does not apply to the products that have been disassembled by users

WARNING

HAZARDOUS MOVING PARTS

KEEP FINGERS AND OTHER BODY PARTS AWAY

Acknowledgments

- AMI is a registered trademark of AMI Software International, Inc.
- Microsoft Windows is a registered trademark of Microsoft Corporation.
- FINTEK is a registered trademark of FINTEK Electronics Corporation.
- REALTEK is a registered trademark of REALTEK Electronics Corporation.
- All other product names or trademarks are properties of their respective owners.

CHAPTER 1 INTRODUCTION

1.1 General Description

The fanless AMI210 system comes with the ibase customized board MB210 and integrates the 4th Intel® Core™ i7/i5/i3 pentium™ and celeron™ processor that featuring 14nm microarchitecture and 3-D Tri-Gate transistors. With unparalleled reliability, the 2.7GHz processor allows the AMI210 to operate in wide temperatures at -10°C to +50°C in harsh industrial environments for 24/7 operation. The AMI210 is ideal for IOT (Internet of Things), factory automation, In-vehicle and other rugged applications that could utilize its 12V to 24V DC wide-range power input.

AMI210 supports up to 16GB DDR3L-1600 SO-DIMM memory and provides SATAIII/ CFast interfaces for storage expansions. For network connectivity, AMI210 supports 2x Intel® I218LM/V and I211AT LAN ports onboard for dual network teaming functions. For power input range, AMI210 supports 12~24V DC Input and this is significant design improvement for allowing more voltage fluctuation of DC power source.

Measuring 210mm(W) by 265mm(D) by 71.6mm(H) for non-expansion slot version and 210mm(W) by 265mm(D) by 134mm(H) for expansion slot version, the AMI210 unit comes with a wall mount kit. We also provide the DC power adaptor for optional item if necessary . The model is currently available with either a 2.5-inch 64GB industrial grade SSD or CFAST slot installation. Expansion is provided by two Mini PCI-E slots. All units feature IBASE's iSMART green technology for power on/off scheduling and power resume functions.



1.2 System Specifications

1.2.1 Hardware Specifications

Engineer Specifications

Motherboard	iBASE Customized motherboard of MB210
CPU type	Intel® 4 th Generation Desktop Core™ i5/i3/Celeron DT Processor - Intel® Core™ i7-4770TE (2.3Ghz) TDP=45W - Intel® Core™ i5-4570TE (2.7Ghz) TDP=35W - Intel® Core™ i5-4590T (2.0Ghz) TDP=35W - Intel® Core™ i3-4350T (3.1Ghz) TDP=35W - Intel® Core™ i3-4330TE (2.4Ghz) TDP=35W

	- Intel® Celeron® G1820TE (2.2Ghz) TDP=35W **Yellow = Haswell Refresh**
Chipset	Intel® Q87/H81Platform Controller Hub - 23 x 22 mm package size, 0.65mm ball pitch
Graphics	Core I processor Integrated Intel® HD Graphics 4000 Controller
Memory	2 x DDR3-1600 SO-DIMM 2 GB, Max. 16GB (Non-ECC) - TRANSCEND TS7W9SDSQ-I with Samsung chip RoHS - P/N: C0373900200081520P
I/O Interface	
Rear Panel I/O	1 x RS422/485 port with isolation protection for COM#1 1 x RS232 port for COM#2 2 x RS232 port for COM#3/COM#4 1 x DisplayPort + HDMI connector 1 x RJ45 Gigabit Ethernet port + 2 x USB3.0 ports 1 x RJ45 Gigabit Ethernet port + 2 x USB2.0 ports 1 x 3 pins DC-in terminal block type for 12~24V *** Resistance current to 15A per pin *
Front Panel I/O	1 x DVI-D + 1 x VGA for video output 1 x Audio jack for MIC-in / Line-out 2 x USB2.0 ports ** co-lay with USB3.0 connector ** 2 x Antenna hole [Reserved] 1 x red HDD LED 1 x power button with green PWR LED 1 x CFAST socket [push-push type] P/N: C1236220024110200P 1 x 2 pins terminal block [co-lay with power on] For external power button
Storage Interface	
SATA	1 x SATAIII port for 2.5" SATA HDD or SSD
mSATA	1 x internal mSATA socket
CFAST	1 x CFAST socket
Expansion slots & I/O for optional combination	
IP212	- 1 x PCI-E(x16) slot
IP211 [default] thruPCI-E(x16) + PCI-E(x4)	- 1 x PCI-E(x8) slot - 1 x PCI-E(x1) slot - 1 x SATAII connector - 4-pins power connector x 1 (JST type, For SATA device) - 2 x DF-11 10-pin box-header for 2 ports COM [for TX/RX signal only]

	<ul style="list-style-type: none"> - 1 x DF-11 8-pin box-header for 2 ports USB - 1 x FAN for 3 pins - 1 x SMBus for 2 pins [TBD]
Power Supply	
DC-input	1x 3-pins pluggable terminal block for 12~24V DC input (for bare wire)
Mechanical	
Dimension	210mm(W) x 265mm(D) x 71.6mm(H) (AMI210) 210mm(W) x 265mm(D) x 134mm(H) (AMI210-PE)
Weight	3.6kg (AMI210), 4.3kg (AMI210-PE)
Construction	Aluminum
Chassis color	Silver + Gray
Mounting type	Wall mount kit
Environmental	
Operating Temperature	-10°C~50°C (-4°F~122°F) **for 35W CPU ** -10°C~45°C (-4°F~113°F) **for 45W CPU **
Storage Temperature	-20°C~80°C (-4°F~176°F)
Humidity	5%~90%@45°C (non-condensing)
Vibration	Operating : 0.25Grms / 5~500Hz Non-operating : 1Grms / 5~500Hz
Shock	Operating : 20G / 11ms Non-operating : 40G / 11ms
Certification	CE **follow EN55032** FCC ClassB / LVD
Regulation	RoHS 2.0

·This specification is subject to change without prior notice.

1.2.2 Dimensions

AMI210 Drawing

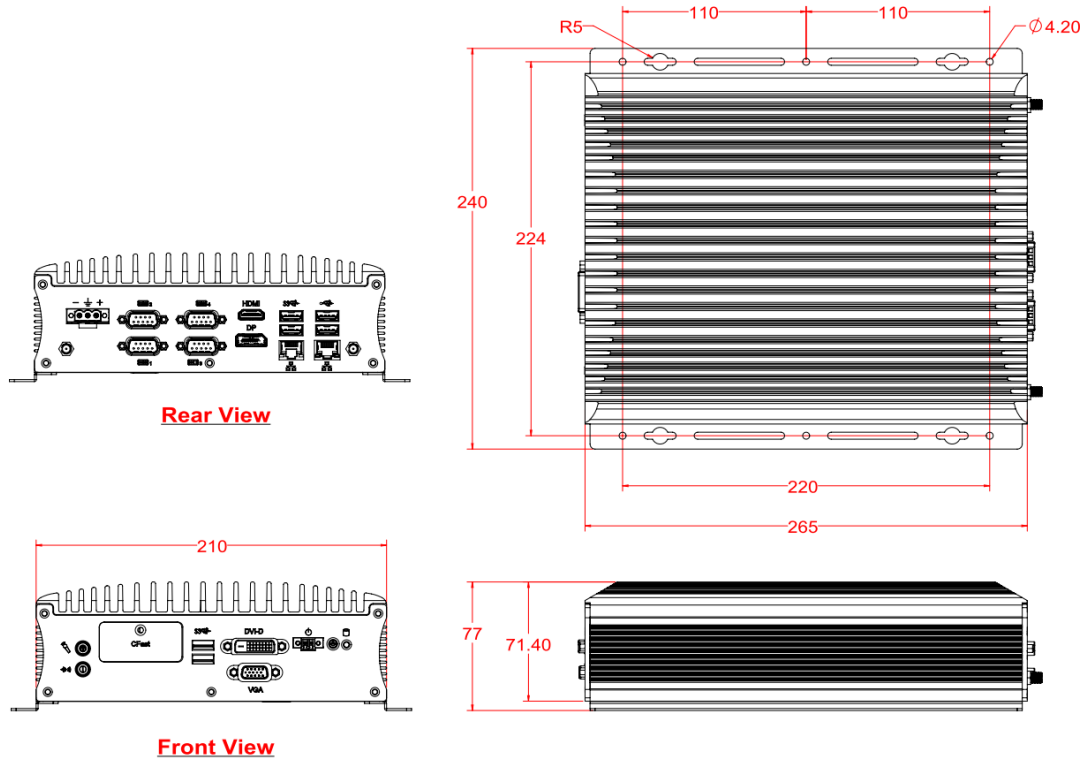

AMI210-PE Drawing

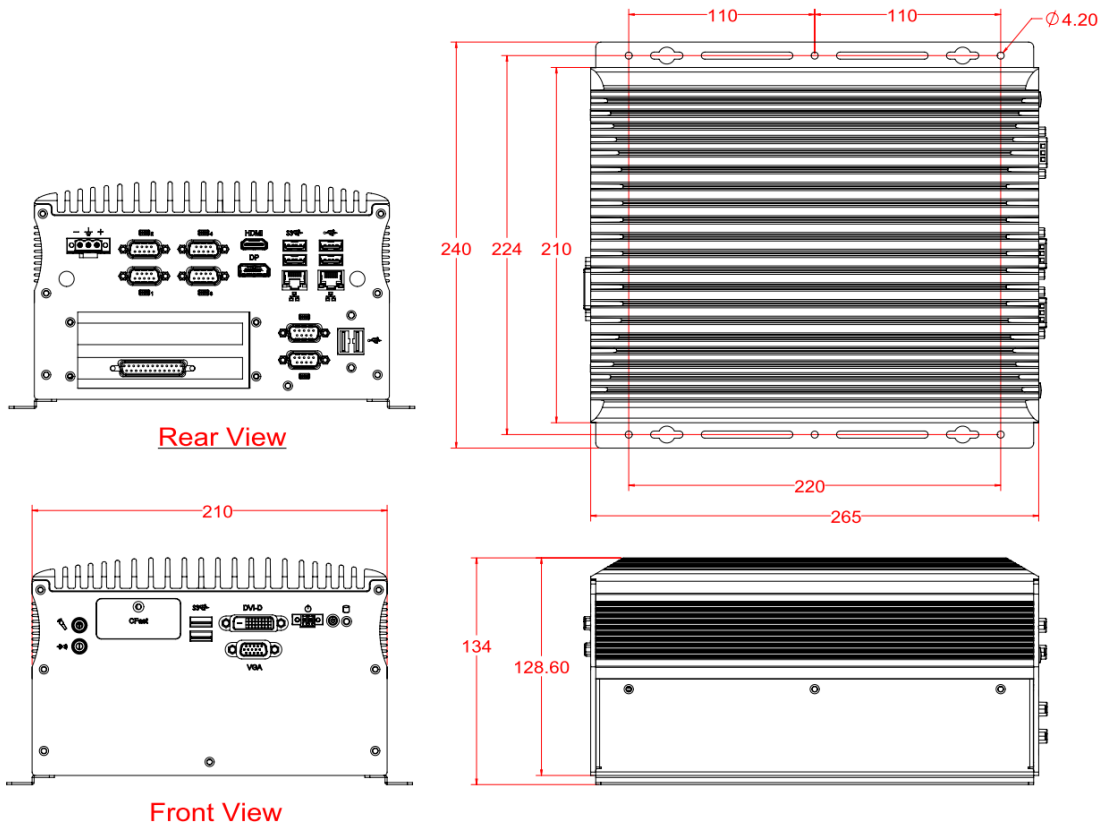

1.2.3 I/O View



Line-out Mic-in	CFAST	USB3.0/Q87 USB2.0/H81	DVI-D VGA	Power on	Power switch HDD LED
--------------------	-------	--------------------------	--------------	----------	-------------------------



DC-in put 12~24V	1 x RS422/485 with isolation	3 x RS232	HDMI DP Port	2 x RJ45	2 x USB3.0 2 x USB2.0
---------------------	---------------------------------	-----------	-----------------	----------	--------------------------



Line-out Mic-in	CAFAST	USB3.0/Q87 USB2.0/H81	DVI-D VGA	Power on	Power switch HDD LED
--------------------	--------	--------------------------	--------------	----------	-------------------------



DC-in put 12~24V	1 x RS422/485 with isolation	3 x RS232	HDMI DP Port	2 x RJ45	2 x USB3.0 2 x USB2.0
---------------------	---------------------------------	-----------	-----------------	----------	--------------------------

2x expansion slots	2 x RS232 (TX RX only)	2 x USB2.0
-----------------------	---------------------------	------------

1.3 Exploded View of the AMI210/AMI210-PE Assembly

AMI210

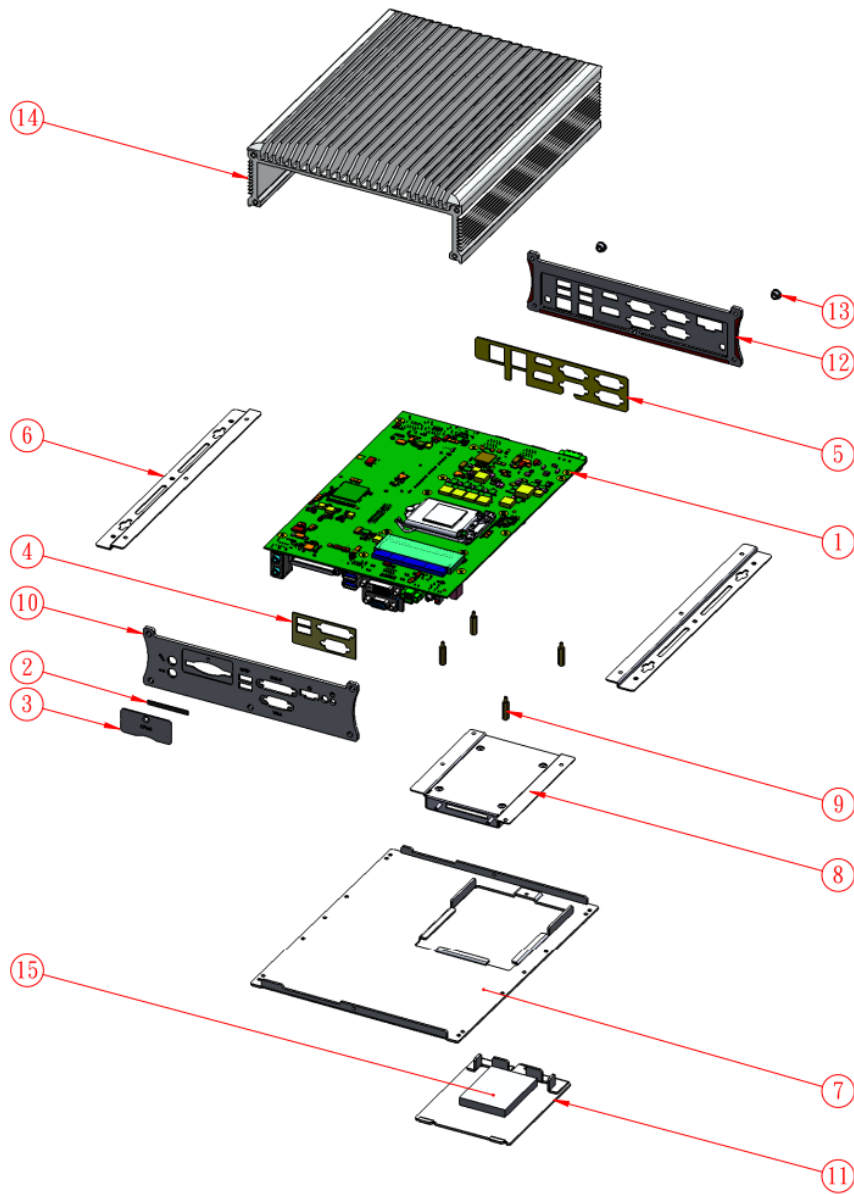

AMI210-PE

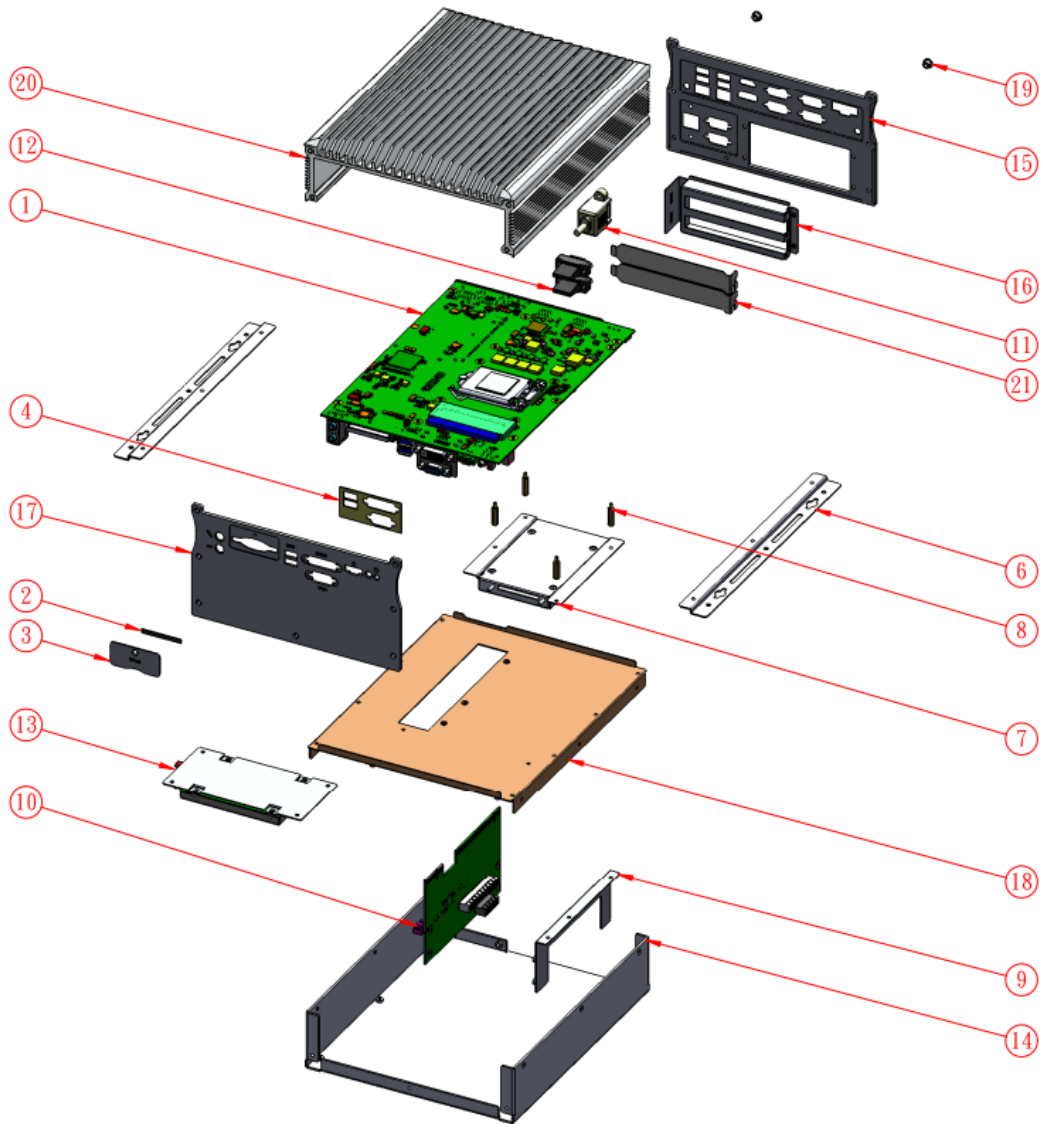

1.3.1 Parts Description

AMI210

1	MB210_B1 board asm	1
2	AMI210-Cfast rubber	1
3	AMI210_Cfast-brk	1
4	AMI210_IO gasket-1	1
5	AMI210-IO gasket-2	1
6	AMI210_bracket	2
7	AMI210_base bracket asm	1
8	AMI210-hdd brk_asm	1
9	SC-47 H0323173342200000P	4
10	AMI210_front plate_1	1
11	AMI210_base hdd-1	1
12	AMI210_rear_plate_1	1
13	MHD-10I	2
14	ami210-hs-1_b2_asm-2016-01-11	1
15	AMI210-hdd rubber	1
16	EC350VM-02P	1
17	5esdvm-03p	1





AMI210-PE

1	MB210_B1 board asm	1
2	AMI210-Cfast rubber	1
3	AMI210_Cfast-brk	1
4	AMI210_IO gasket-1	1
5	AMI210-IO gasket-2	1
6	AMI210_bracket	2
7	AMI210-hdd brk_asm	1
8	SC-47 H0323173342200000P	4
9	AMI210-PE_IP211 brk	1
10	IP211_pci_e_riser card_asm	1
11	CC-08	1
12	CC-01	2
13	AMI210-1 hdd module	1
14	AMI210-PE_base	1
15	AMI210_rear_plate_2	1
16	AMI210-PE_pci brk_2	1
17	AMI210_front plate_2	1
18	AMI210-PE_base bracket	1
19	MHD-10I	2
20	ami210-hs-1_b2_asm-2016-01-11	1
21	P26_H06P0260000000000	2

1.4 Packing List

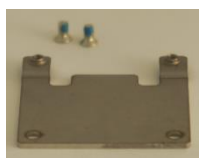
Item No.	Description	Qty
1	Driver DVD	1
3	Wall mount kit	2

1.4.1 Optional Items

WiFi Solution	Description	
WiFi module	WIRELESS;PCI-E MINI CARD 802.11B/G/N [AW-NE238H] (A008WLAWNE238H000P)	
External Antenna	WiFi Antenna (A055RFA02C2M20800P)	
Internal cable-1/2	From Wifi module to Rear/Front panel (A055RFA0000021000P/A055RFA0000032000P)	
Bracket	MPCI-E-EXT V-B1 Bracket, RoHS; Extend Half to Full size. (SC2MPCIEEXT0B1100P)	
3G Solution	Description	
ZU 202	Wireless; 3.75G UMTS/HSPA [ZU202] RoHS (A008WIRELESS00520P)	
ZU 200	Wireless; 3.75G UMTS/HSPA & GPS Module [ZU200] RoHS (A008WIRELESS00510P)	
Cable	Cable; Antenna-2 30CM P 2pcs (C501ANT0200300000P)	
Antenna	Antenna; 3G, P, 2pcs (A055ANT0921Q2P000P)	
Power kit	Description	
Power Adaptor	P/S; ADAPTER 120W 12V 2 PIN bare wire type, FSP120-AHAN2] (A005PS120WF030100P) (For AMI210)	
	P/S; ADAPTER 150W 12V 2 PIN bare wire type, FSP150-AHAN2] (A005PS150W0314000P) (For AMI210-PE)	
Power Cord	PW CORD; Chinese/American/Japan 3PIN 10A (A030PCAM040100000P)	

CHAPTER 2 MOTHERBOARD INTRODUCTION

2.1 Introduction

The MB210 motherboard is based on the latest Intel® Q87/H81 chipset. The platform supports onboard 4th generation Intel® Core processor family features an integrated dual-channel DDR3 memory controller as well as a graphics core.

The latest Intel® processors provide advanced performance in both computing and graphics quality. This meets the requirement of customers in the gaming, POS, digital signage and server market segment.

The Q87/H81 platform is made with 22-nanometer technology that supports Intel's first processor architecture to unite the CPU and the graphics core on the transistor level. The MB210 board utilizes the dramatic increase in performance provided this Intel's latest cutting-edge technology. The MB210 offers fast 6Gbps SATA support, USB2.0/3.0 and interfaces for RGB, DVI-D, HDMI and DP displays.

MB210 Specification:

Form Factor	Customized motherboard
CPU type	<ul style="list-style-type: none"> - Intel® 4th Generation Desktop Core™ i7/i5/i3/Celeron DT Processor on solder side - Intel® Core™ i7-4770TE (2.3Ghz) TDP=45W - Intel® Core™ i5-4570TE (2.7Ghz) TDP=35W - Intel® Core™ i5-4590T (2.0Ghz) TDP=35W - Intel® Core™ i3-4350T (3.1Ghz) TDP=35W - Intel® Core™ i3-4330TE (2.4Ghz) TDP=35W - Intel® Celeron® G1820TE (2.2Ghz) TDP=35W - **Yellow = Haswell Refresh**
Chipset	Intel® Q87 PCH (MB210AF) Intel® H81 PCH (MB210EF) <ul style="list-style-type: none"> - 23 x 22 mm package size, 0.65mm ball pitch
Memory	<ul style="list-style-type: none"> - 2 x DDR3-1600 SO-DIMM 8 GB, Max. 16GB (Non-ECC) - 1x DIMM on solder side - Dual channel DDR3-1600 MHz with 1.5V

	<ul style="list-style-type: none"> - SO-DIMM x 2, Max.=16GB (Non-ECC) [Horizontal type]
VGA	<p>Intel® 4th Generation Core™ DT processor integrated HD Gfx, Direct X 11.1, OpenGL 3.2, Open CL 1.2</p> <ul style="list-style-type: none"> - DVI-D x 1 (Thru port B, with level shifter ASM1442K) - DisplayPort x 1 (Thru port C) - HDMI (Thru port D) - VGA x 1 (Thru PCH)
LAN	<p>1 x Intel® I218LM GbE PHY (for MB210AF only) 1 x Intel® I218V GbE PHY (for MB210EF only) 1 x Intel® I211AT Gigabit LAN</p>
USB	<p>For MB210AF Configuration</p> <ul style="list-style-type: none"> - 2 x USB3.0 ports via the front panel I/O ** co-lay USB2.0 connector <p style="padding-left: 40px;">** UB1112C-8HS6-4F</p> <ul style="list-style-type: none"> - 2 x USB3.0 ports via the rear panel I/O - 2 x USB2.0 ports via the rear panel I/O - 2 x USB2.0 ports via MiniPCle socket - 2 x USB2.0 ports via PCI-E(x4) expansion slot <p>For MB210EF Configuration</p> <ul style="list-style-type: none"> - 2 x USB3.0 ports via the rear panel I/O - 2 x USB2.0 ports via the rear panel I/O - 2 x USB2.0 ports via the front panel I/O ** co-lay USB3.0 connector ** - 2 x USB2.0 ports via MiniPCle socket - 2 x USB2.0 ports via PCI-E(x4) expansion slot
Serial ATA	<p>Intel® PCH built-in SATA controller, support 4 ports</p> <ul style="list-style-type: none"> - 1 x SATAII (3Gbps) thru CFAST and 1 x SATAIII (6Gbps) thru mSATA - 1 x SATAII (3Gbps) port thru PCI-E (4x) slot - 1 x SATAIII (6Gbps) connector on board - RAID is supported [MB210AF only]
Audio	<p>Intel® PCH built-in High Definition Audio controller + Realtek ALC662-CG w/ 5.1 channels</p>
LPC I/O	<p>Fintek F81866AD-I (128-pin LQFP[14mm x 14 mm])</p> <ul style="list-style-type: none"> - COM#1 (RS422/RS485) supporting isolation [ACPL-M60L-500E OPTOCOUPLER] (pin9 with isolation 5V @ 150mA [TBD]) [C01Z601L000000000P]

	<p>1 x DC to DC power converter @5V/2W [C0711020050053100P] 2 x RS422/485 transceiver SP485EEN-L [C014485EEN0002000P]</p> <ul style="list-style-type: none"> - COM #2 (RS232 only) support ring-in with power @500 mA (selectable for 5V or 12V) - COM #3~COM #6 (RS232 only) <p>Hardware Monitor (2 thermal inputs,4 voltage monitor inputs & 2 Fan headers)</p> <ul style="list-style-type: none"> - CPU FAN x1 (PWM Fan type, 4-pins connector) - SYS FAN x1 (DC FAN type, 3-pins signal via PCI-E(x4) slot)
Digital IO	4 in & 4 out
Edge Connector [Rear Panel I/O]	<p>1 x RS422/485 port with isolation protection for COM#1+ 1 x RS232 port for COM#2 1 x DisplayPort + HDMI for video output [refer to MI987] 2 x RS232 port for COM#3/COM#4 1 x RJ45 Gigabit Ethernet port + 2 x USB3.0 ports [C1217110307200100P] 1 x RJ45 Gigabit Ethernet port + 2 x USB2.0 ports [C1217110307200100P] 1 x 3 pins terminal block for DC-input [5EHDRM-03P 90D 3 pins] [P/N: C12165EHD03105100P]</p>
Edge Connectors [Front Panel I/O]	<p>1 x DVI-D + 1 x VGA for video output [refer to MI981] 1 x Audio jack for MIC-in / Line-out [refer to MI987] 2 x USB3.0 ports ** co-lay USB2.0 connector ** 1 x red HDD LED 1 x power button with green PWR LED 1 x 2 pins terminal block [co-lay with power on] For external power button [EC350RM-02P 90D 2 pins] [P/N: C1216ECH310203000P] 1 x CFAST socket **push-push type** P/N: C1236220024110200P</p>
Expansion Slots	<ul style="list-style-type: none"> - PCI-Express (16x PEG3.0) x1 + PCI-Express (4x) x1 - PCI-Express (4x) x1 [the customized pin definition] total 64 pins - 1 x PCI-E (1x) signal for 36 pins - 1 x SATA for 4 pins - 2 x DB9 for 4 pins [for TX/RX only] - 2 x USB for 8 pins - 1 x FAN for 3 pins - 1 x SMBus for 2 pins

	<ul style="list-style-type: none"> - 2x Mini PCI-E sockets [Full-sized] , [both support USB 2.0] [refer to MI808] - Support mSATA thru either one Mini-PCI-E socket
Onboard Header/Connector	<ul style="list-style-type: none"> 2 x 5 pins DF11 box header x1 for Digital IO 1 x 4 pins [2 x 2]ATX power connector for DC-input 1 x 2 pins header for power reset button 1 x SATA III connector for SATA device (BLUE color) 1 x 4-pins power connector (JST type, For SATA device)
Watchdog Timer	Yes (256 segments, 0, 1, 2...255 sec/min)
DC Input	+12V~24V power input
Power protection	<ul style="list-style-type: none"> - OVP power protection (Overvoltage Protection to 60V) - UVP power protection - Reverse voltage protection (Reverse Supply Protection to -40V) - Linear LTC4365HDDDB Power Supply Protection Controller - Extra power schematic **refer to IDP100**
iSMART 3.2	<ol style="list-style-type: none"> 1. EuP / ErP (thru Super I/O) 2. Auto-scheduler 3. Power fail detector 4. Low temperature Guardian
Environment	<ul style="list-style-type: none"> Operation Temperature : -10~70 degree C Storage Temperature : -20~80 degree C Relative humidity : 90%, non-condensing @ 60 degree C
Certification	<ul style="list-style-type: none"> CE **follow EN55032** FCC Class B
Operation System	Windows 7, Windows 8/8.1, Linux
Board Size	170 x 170 mm (TBD)
RoHS 2.0	YES

2.2 Board Dimensions

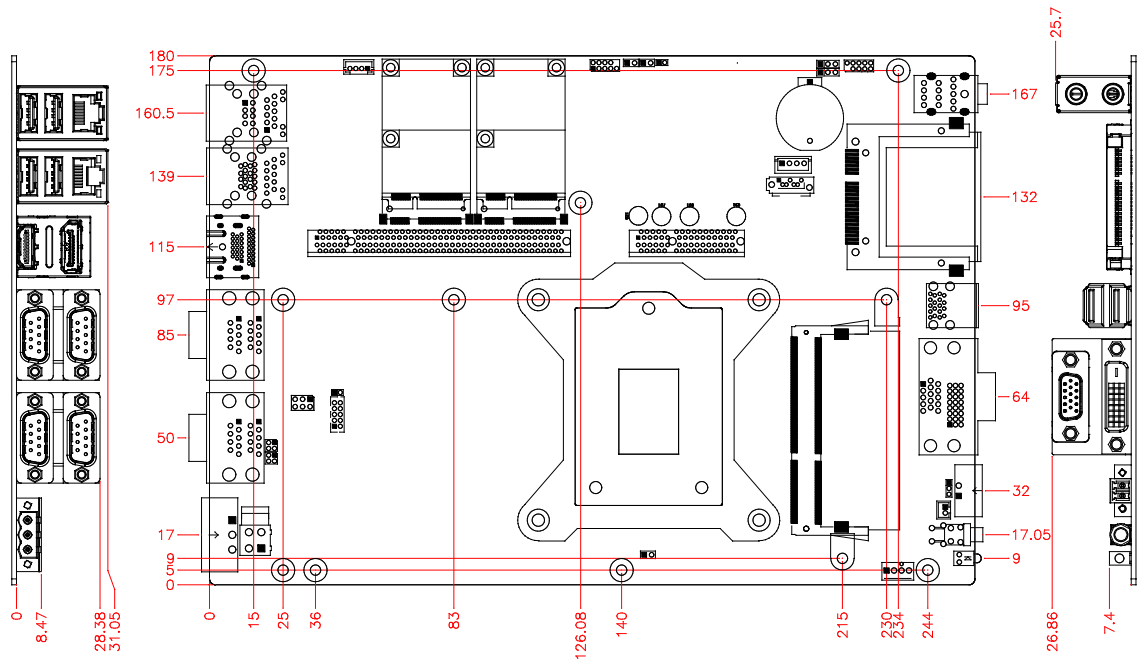



2.3 Setting the Jumpers

Jumpers are used on MB210 to select various settings and features according to your needs and applications. Contact your supplier if you have doubts about the best configuration for your needs. The following lists the connectors on MB210 and their respective functions.

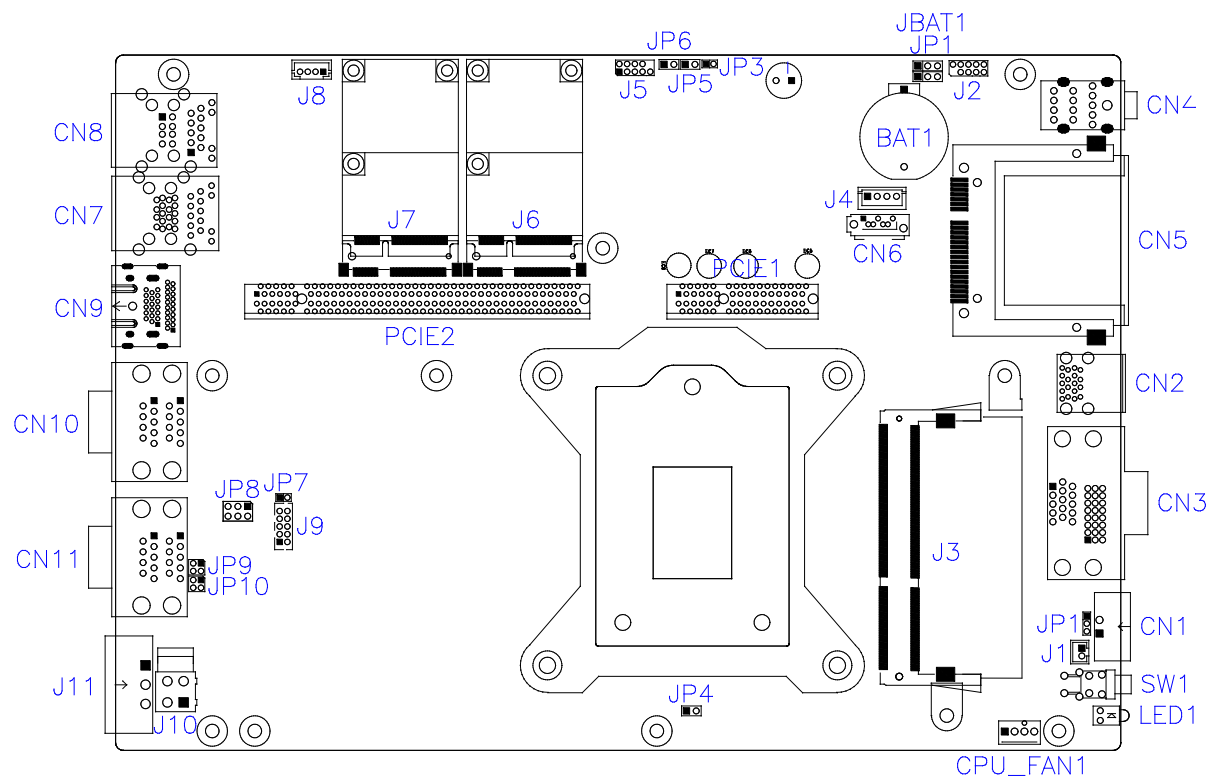

2.4 Jumper Locations on MB210



JBAT1: Clear CMOS Contents

JBAT1	Setting	Function
	Pin 1-2 Short/Closed	Normal (Default)
	Pin 2-3 Short/Closed	Clear CMOS

JP1: Clear ME Contents

JP1	Setting	Function
	Pin 1-2 Short/Closed	Normal (Default)
	Pin 2-3 Short/Closed	Clear CMOS

JP6: Flash Descriptor Security Override (Factory use only)

JP6	Flash Descriptor Security Override
Open	Disabled (Default)
Close	Enabled

JP8: COM2 RS232 RI/+5V/+12V Power Setting

JP8	Setting	Function
	Pin 1-3, Short/Closed	+12V
	Pin 3-4, Short/Closed	RI (Default)
	Pin 3-5, Short/Closed	+5V



JP9: COM1 Terminal Selection

JP9	Flash Descriptor Security Override
Terminal Disable	Open (Default)
Terminal Enable	Pin 1-2, Short/Closed Pin 3-4, Short/Closed

JP10: RS-422/RS-485 Selection

JP10	Flash Descriptor Security Override
RS-422	Pin 1-2, Short/Closed
RS-485	Pin 3-4, Short/Closed

JP11: AT/ATX Mode Selection

JP11	Setting	Function
	Pin 1-2 Short/Closed	ATX Mode (Default)
	Pin 2-3 Short/Closed	AT Mode

Connector Locations on MB210

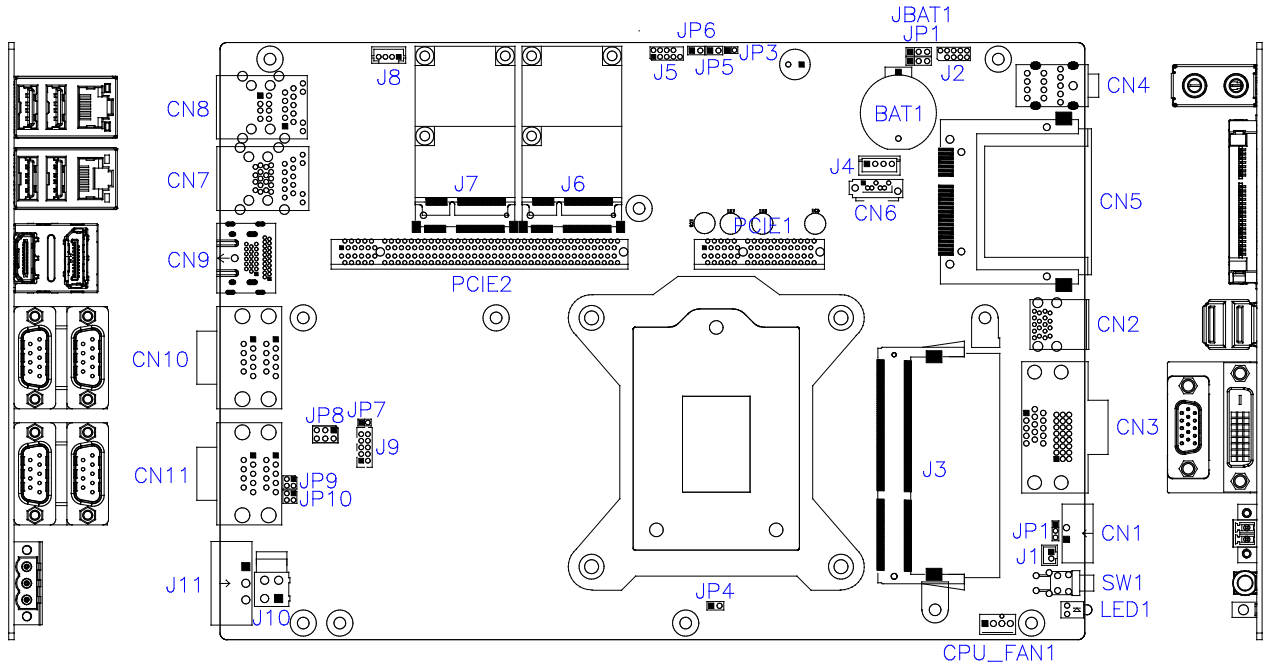

CN2: USB2.0 (UB1112C-8HS6-4F)

/USB3.0 Connector (UEA1112C-8HS6-4F)

CN3: CRT + DVI-D Connector (QH11121-DBGH-4F, BX4)

CN4: Audio Connector (JA23331-HA6Q-4F (E))

CN5: CFAST Connector (CY101-1100191 v1.2)

CN6: SATA Connector (WATM-07DBN4B2B8UW4)

CN7: RJ45 + USB3.0 Connector (JFM38U1B-B313-4F)

CN8: RJ45 + USB2.0 Connector (JFM38U1B-21U5-4F)

CN9: DP + HDMI Connector (3VD11203-HHJ0-4H)

CN10: COM3/4 Connector (40909AANSNAR)

Note: COM3 and COM4 support RS232 only.

CN1: Power Button and Power on LED Connector (DINKLE_ECH350RM-02P)

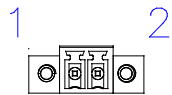

Pin #	Signal Name
1	Power BTN
2	Ground

CN11: COM1/2 Connector (40909AANSNAR)

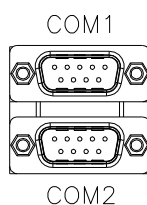

Pin #	Signal Name		
	RS-232	R2-422	RS-485
1	DCD	TX-	DATA-
2	RX	TX+	DATA+
3	TX	RX+	NC
4	DTR	RX-	NC
5	Ground	Ground	Ground
6	DSR	NC	NC
7	RTS	NC	NC
8	CTS	NC	NC
9	RI	NC	NC
10	NC	NC	NC

Note: COM1 supports Isolated RS422/RS485 only.

COM2 supports RS232 only.

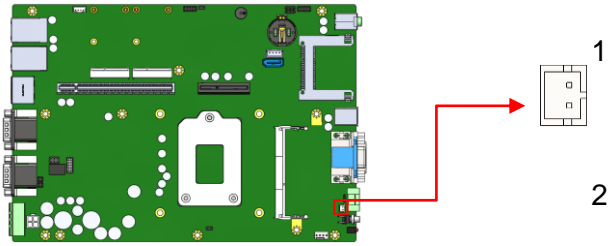
J1: Reset Button Connector (Techbest 2001-WS-02-LF)

Pin #	Signal Name
1	Reset BTN
2	Ground

J2: SPI Flash Connector (Factory use only) (2mm)

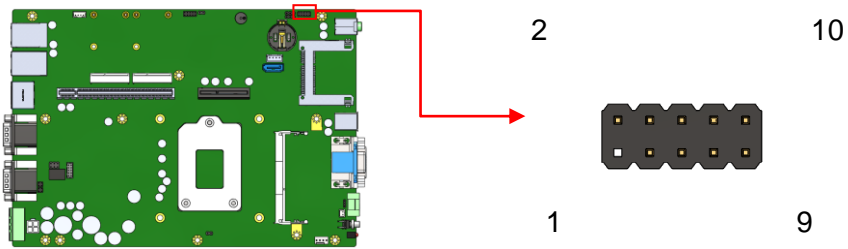

Signal Name	Pin #	Pin #	Signal Name
Protect Pin	X	2	NC
SPI_CS#	3	4	+3.3V
SPI_SO	5	6	SPI_HOLD#
SPI_WP#	7	8	SPI_CLK
Ground	9	10	SPI_SI

J3, J12: DDR3 SO-DIMM Socket

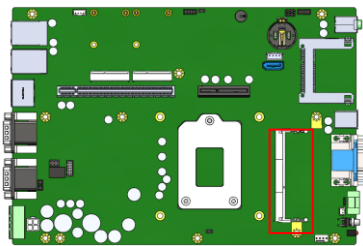

J4: SATA Power Connector (1600-4SD)

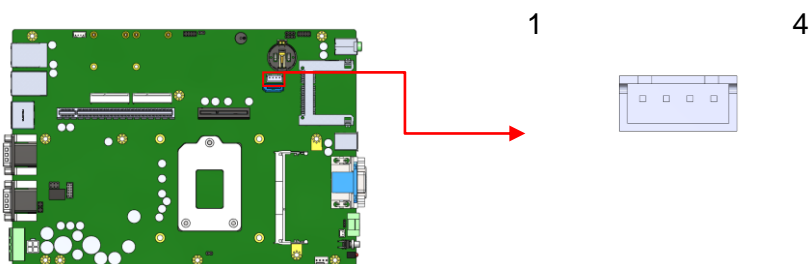

Pin #	Signal Name
1	+5V
2	Ground
3	Ground
4	+12V

J5: LPC Debug Connector (Factory use only) (2mm)

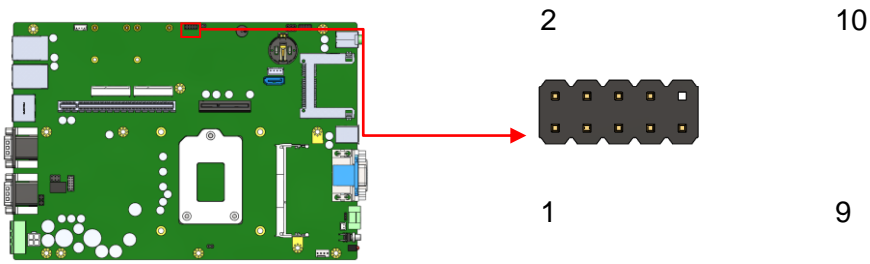

Signal Name	Pin #	Pin #	Signal Name
LPC_AD0	1	2	Reset#
LPC_AD1	3	4	LPC_FRAME#
LPC_AD2	5	6	+3.3V
LPC_AD3	7	8	Ground
CLK_33MHz	9	X	Protect Pin

J6, J7: Mini PCIE Connector (Foxconn AS0B226-S99Q-7H)

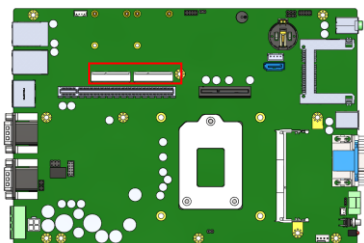

J8: iSMART Debug Connector (Factory use only) (E-CALL 0110-161-040)

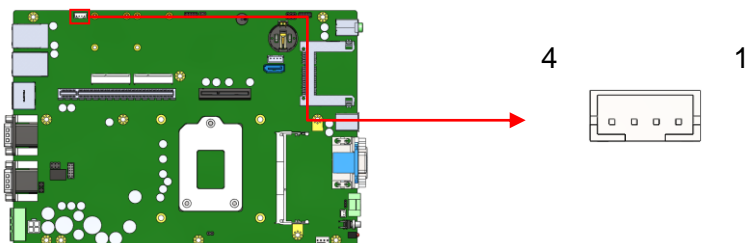

J9: Digital I/O Connector (豪國DF11-10S-PA66H)

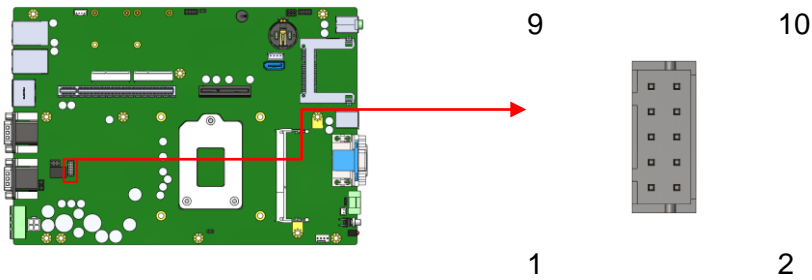

Signal Name	Pin #	Pin #	Signal Name
Ground	1	2	VCC5
OUT3	3	4	OUT1
OUT2	5	6	OUT0
IN3	7	8	IN1
IN2	9	10	IN0

J10: DC-in Connector (4M-ATX-S)

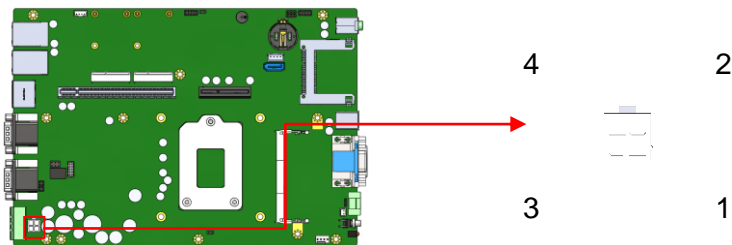

Pin #	Signal Name
1	Power Ground
2	Case Ground
3	+12V to +24V
4	+12V to +24V

J11: DC-inN Connector (DINKLE_5EHDRM-03P)

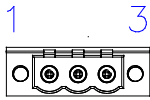

Pin #	Signal Name
1	+12V to +24V
2	Case Ground
3	Power Ground

CPU_FAN1: CPU Fan Power Connector (HF27040-M1)

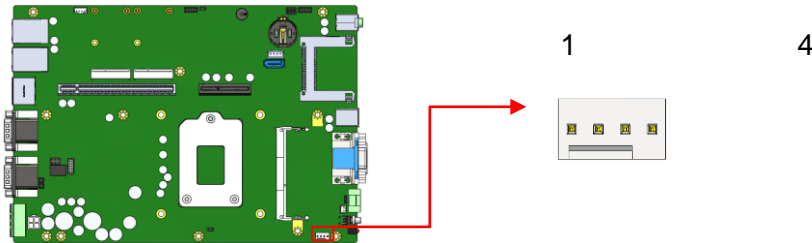

Pin #	Signal Name
1	Ground
2	+12V
3	Rotation detection
4	Control

LED1: HDD Active LED

PCIE1: Include PCI-E x1, USB2.0, SYS_FAN, SATA, COM TX/RX Signal Connector

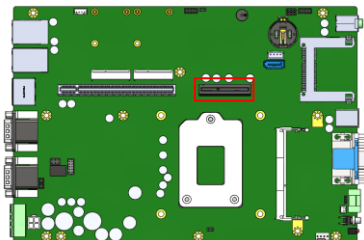

PCIE2: PCI-E x16 Connector

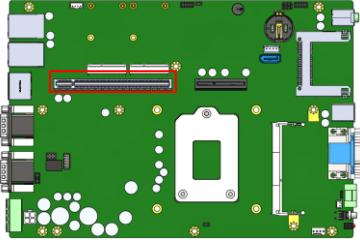

CHAPTER 3 BIOS SETUP

This chapter describes the different settings available in the AMI BIOS that comes with the board. The topics covered in this chapter are as follows:

BIOS Introduction

The BIOS (Basic Input/Output System) installed in your computer system's ROM supports Intel processors. The BIOS provides critical low-level support for a standard device such as disk drives, serial ports and parallel ports. It also provides password protection as well as special support for detailed fine-tuning of the chipset controlling the entire system.

BIOS Setup

The BIOS provides a Setup utility program for specifying the system configurations and settings. The BIOS ROM of the system stores the Setup utility. When you turn on the computer, the BIOS is immediately activated. Pressing the key immediately allows you to enter the Setup utility. If you are a little bit late pressing the key, POST (Power On Self Test) will continue with its test routines, thus preventing you from invoking the Setup. If you still wish to enter Setup, restart the system by pressing the "Reset" button or simultaneously pressing the <Ctrl>, <Alt> and <Delete> keys. You can also restart by turning the system Off and back On again. The following message will appear on the screen:

```
Press <DEL> or <F2> to Enter Setup
```

In general, you press the arrow keys to highlight items, <Enter> to select, the <PgUp> and <PgDn> keys to change entries, <F1> for help and <Esc> to quit.

When you enter the Setup utility, the Main Menu screen will appear on the screen. The Main Menu allows you to select from various setup functions and exit choices.

Warning: *It is strongly recommended that you avoid making any changes to the chipset defaults. These defaults have been carefully chosen by both AMI and your system manufacturer to provide the absolute maximum performance and reliability. Changing the defaults could cause the system to become unstable and crash in some cases.*

Main Settings

Aptio Setup Utility – Copyright © 2012 American Megatrends, Inc.

Main	Advanced	Chipset	Boot	Security	Save & Exit
Total memory			8192 MB (DDR3)		Choose the system default language
Memory Frequency			1600 Mhz		
System Language			[English]		
System Date			[Mon 12/07/2015]		
System Time			[15:27:20]		→ ← Select Screen ↑ ↓ Select Item
Access Level			Administrator		Enter: Select +- Change Field F1: General Help F2: Previous Values F3: Optimized Default F4: Save ESC: Exit

System Language

Choose the system default language.

System Date

Set the Date. Use Tab to switch between Data elements.

System Time

Set the Time. Use Tab to switch between Time elements.

Advanced Settings

This section allows you to configure and improve your system and allows you to set up some system features according to your preference.

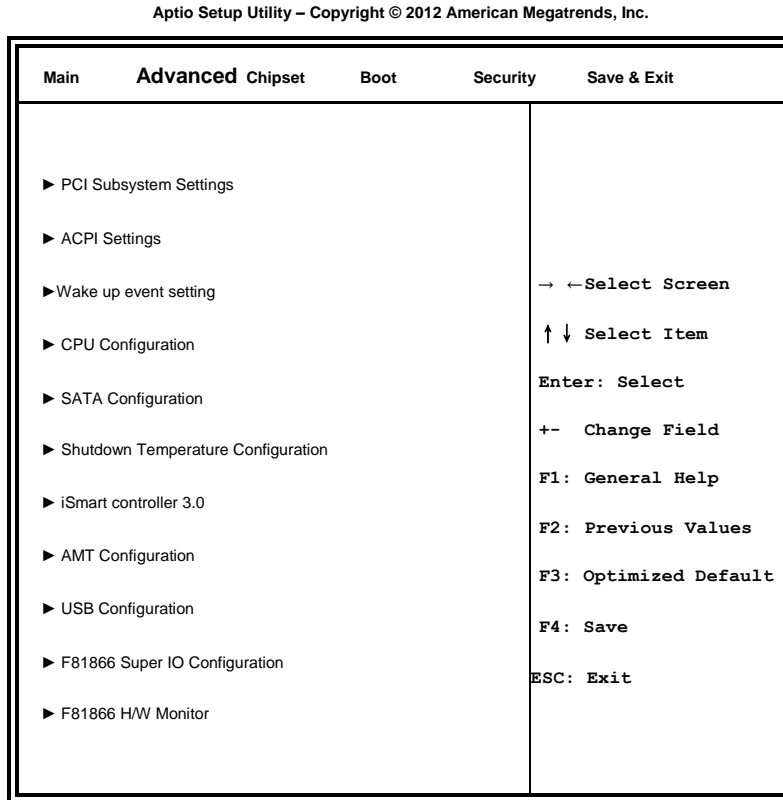

PCI Subsystem Settings

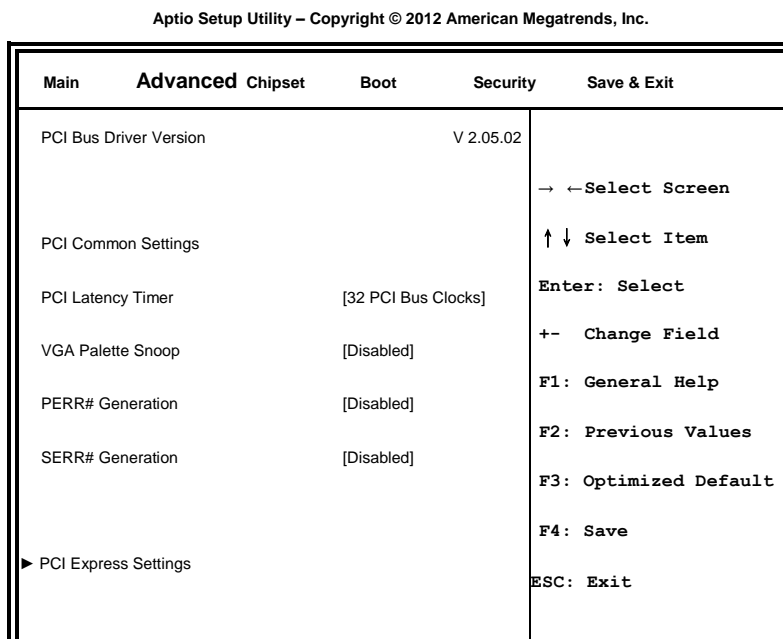



PCI Latency Timer

Value to be programmed into PCI Latency Timer Register

VGA Palette Snoop

Enables or Disables VGA Palette Register Snooping.

PERR# Generation

Enables or Disables PCI Device to Generate PERR#.

SERR# Generation

Enables or Disables PCI Device to Generate SERR#.

PCI Express Settings

Change PCI Express Devices Settings.

ACPI Settings

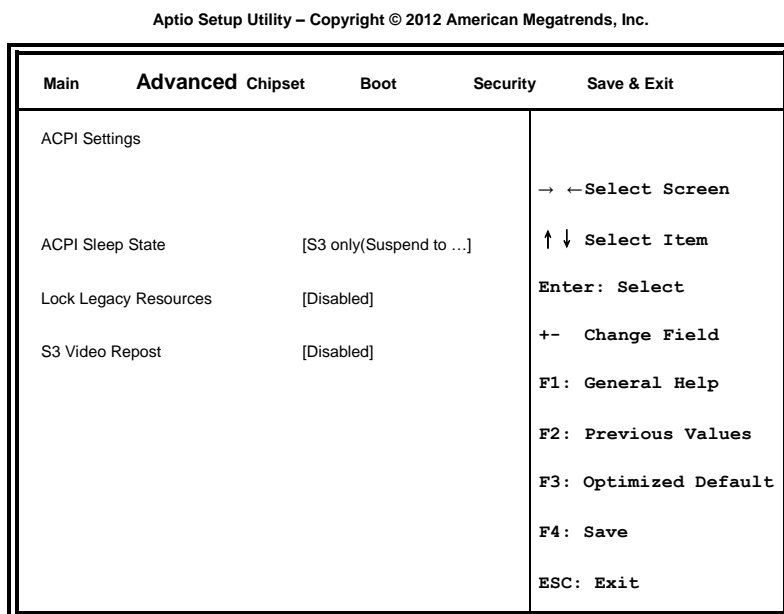

ACPI Sleep State

Select ACPI sleep state the system will enter, when the SUSPEND button is pressed.

Lock Legacy Resources

Enables or Disables Lock of Legacy Resources.

S3 Video Repost

Enables or Disables S3 Video Repost.

Wake up event Settings

Aptio Setup Utility – Copyright © 2012 American Megatrends, Inc.

Main	Advanced	Chipset	Boot	Security	Save & Exit
Wake on PCI PME				[Enabled]	→ ← Select Screen ↑ ↓ Select Item Enter: Select +- Change Field F1: General Help F2: Previous Values F3: Optimized Default F4: Save ESC: Exit

Wake on PCI PME

Enables or Disables Wake on PCI PME.

CPU Configuration

This section shows the CPU configuration parameters.

Aptio Setup Utility – Copyright © 2012 American Megatrends, Inc.

Main	Advanced	Chipset	Boot	Security	Save & Exit
CPU Configuration					
Intel(R) Core(TM) i5-4590T CPU @ 2.00GHz					
CPU Signature			306c3		
Processor Family			6		
Microcode Patch			17		
FSB Speed			100 MHz		
MAX CPU Speed			2000 MHz		
Min CPU Speed			800 MHz		
Processor Cores			4		
Intel HT Technology			Not Supported		
Intel VT-X Technology			Supported		
Intel SMX Technology			Supported		
64-bit			Supported		
EIST Technology			Supported		
L1 Data Cache			32 KB x 4		
L1 Code Cache			32 KB x 4		
L2 Cache			256 KB x 4		
L3 Cache			6144 KB		
Active Processor Cores			[All]	→ ← Select Screen	
Overclocking lock			[Disabled]	↑ ↓ Select Item	
Limit CPUID Maximum			[Disabled]	Enter: Select	
Execute Disable Bit			[Enabled]	+- Change Field	
Intel Virtualization Technology			[Enabled]	F1: General Help	
CPU AES			[Enabled]	F2: Previous Values	
Boot performance mode			[Turbo Performance]	F3: Optimized Default	
EIST			[Enabled]	F4: Save	
Turbo Mode			[Enabled]	ESC: Exit	

Active Processor Cores

Number of cores to enable in each processor package.

Overclocking lock

FLEX_RATIO(194) MSR.

Limit CPUID Maximum

Disabled for Windows XP.

Execute Disable Bit

XD can prevent certain classes of malicious buffer overflow attacks
When combined with a supporting OS(Windows Server 2003 SP1,
Windows XP SP2, SuSE Linux 9.2, RedHat Enterprise 3 update3.)

Intel Virtualization Technology

When enabled, a VMM can utilize the additional hardware capabilities
Provided by Vanderpool Technology.

CPU AES

Enable/Disable CPU Advanced Encryption Standard instructions.

Boot performance mode

Select the performance state that the BIOS will set before OS handoff.

EIST

Enable/Disable Intel SpeedStep

Turbo Mode

Enable/Disable Turbo Mode.

SATA Configuration

Aptio Setup Utility – Copyright © 2012 American Megatrends, Inc.

Main	Advanced	Chipset	Boot	Security	Save & Exit
SATA Controller(S)			[Enabled]		
SATA Mode Selection			[AHCI]		
▶ Software Feature Mask Configuration					
Serial ATA Port 0			Empty		
Software Preserve			Unknown		
Serial ATA Port 1			Empty		→ ← Select Screen
Software Preserve			Unknown		↑ ↓ Select Item
Serial ATA Port 2			Empty		Enter: Select
Software Preserve			Unknown		+ - Change Field
Serial ATA Port 3			Empty		F1: General Help
Software Preserve			Unknown		F2: Previous Values
Serial ATA Port 4			Empty		F3: Optimized Default
Software Preserve			Unknown		F4: Save
Serial ATA Port 5			Empty		ESC: Exit
Software Preserve			Unknown		

SATA Controller(S)

Enable or disable SATA Device.

SATA Mode Selection

Determines how SATA controller(s) operate.

Software Feature Mask Configuration

RAID OROM/RST driver will refer to the SWFM configuration to enable or disable the storage features.

Shutdown Temperature Configuration

Aptio Setup Utility – Copyright © 2012 American Megatrends, Inc.

Main	Advanced	Chipset	Boot	Security	Save & Exit
ACPI Shutdown Temperature				[Disabled]	
					→ ← Select Screen ↑ ↓ Select Item Enter: Select +- Change Field F1: General Help F2: Previous Values F3: Optimized Default F4: Save ESC: Exit

iSmart Controller 3.0

Aptio Setup Utility – Copyright © 2012 American Megatrends, Inc.

Main	Advanced	Chipset	Boot	Security	Save & Exit
iSmart Controller 3.0					
Power-on after Power failure			[Disable]		→ ← Select Screen
Temperature Guardian			[Disable]		↑ ↓ Select Item
Schedule Slot 1			[None]		Enter: Select
Schedule Slot 2			[None]		+ - Change Field
					F1: General Help
					F2: Previous Values
					F3: Optimized Default
					F4: Save
					ESC: Exit

Power-on after Power Failure

Enable or Disable Power-on after Power failure.

Temperature Guardian

Enable or Disable Temperature Guardian.

Schedule Slot

Setup the hour/minute for system power on.

AMT Configuration

Aptio Setup Utility – Copyright © 2012 American Megatrends, Inc.

Main	Advanced	Chipset	Boot	Security	Save & Exit
			Intel AMT	[Enabled]	
			BIOS Hotkey Pressed	[Disabled]	
			MEBx Selection Screen	[Disabled]	
			Hide Un-Configure ME Confirmation	[Disabled]	
			Un-Configure ME	[Disabled]	→ ← Select Screen
			Amt Wait Timer	0	↑ ↓ Select Item
			Activate Remote Assistance Process	[Disabled]	Enter: Select
			USB configure	[Enabled]	+ - Change Field
			PET Progress	[Enabled]	F1: General Help
			AMT CIRA Timeout	0	F2: Previous Values
			Watchdog	[Disabled]	F3: Optimized Default
			OS Timer	0	F4: Save
			BIOS Timer	0	ESC: Exit

AMT Configuration

This configuration is supported only with MB210AF(with iAMT function).

Intel AMT

Enable/Disable Intel (R) Active Management Technology BIOS Extension.

Note: iAMT H/W is always Enabled.

This option just controls the BIOS extension execution.

If enabled, this requires additional firmware in the SPI device.

BIOS Hotkey Pressed

OEMFLag Bit 1: Enable/Disable BIOS hotkey press.

MEBx Selection Screen

OEMFLag Bit 2: Enable/Disable MEBx Selection Screen.

Hide Un-Configure ME Confirmation

OEMFLag Bit 6: Hide Un-Configure ME without password Confirmation Prompt.

Un-Configure ME

OEMFLag Bit 15: Un-Configure ME without password.

Amt Wait Timer

Set timer to wait before sending ASF_GET_BOOT_OPTIONS.

Activate Remote Assistance Process

Trigger CIRA boot.

USB configure

Enable/Disable USB Configure function.

PET Progress

User can Enable/Disable PET Events progress to receive PET events or not.

Watchdog

Enable/Disable Watchdog Timer

USB Configuration

Aptio Setup Utility – Copyright © 2012 American Megatrends, Inc.

Main	Advanced	Chipset	Boot	Security	Save & Exit
USB Configuration					
USB module Version		8.10.28			
USB Devices:					
1 Keyboard, 2Hubs					
Legacy USB Support		[Enabled]			
USB3.0 Support		[Enabled]			
XHCI Hand-off		[Enabled]			
EHCI Hand-off		[Enabled]			
USB Mass Storage Driver Support		[Enabled]			
USB hardware delays and time-outs:					
USB transfer time-out		[20 sec]			
Device reset time-out		[20 sec]			
Device power-up delay		[Auto]			
					→ ← Select Screen
					↑ ↓ Select Item
					Enter: Select
					+ - Change Field
					F1: General Help
					F2: Previous Values
					F3: Optimized Default
					F4: Save
					ESC: Exit

Legacy USB Support

Enables Legacy USB support.

AUTO option disables legacy support if no USB devices are connected.

DISABLE option will keep USB devices available only for EFI applications.

USB3.0 Support

Enable/Disable USB 3.0 (XHCI) Controller support.

XHCI Hand-off

This is a workaround for Oses without XHCI hand-off support. The XHCI ownership change should be claimed by XHCI driver.

EHCI Hand-off

This is a workaround for OSes without EHCI hand-off support. The EHCI ownership change should be claimed by EHCI driver.

USB MASS Storage Driver Support

Enable/Disable USB Mass Storage Driver Support.

USB Transfer time-out

The time-out value for Control, Bulk, and Interrupt transfers.

Device reset time-out

USB mass storage device start unit command time-out.

Device power-up delays

Maximum time the device will take before it properly

Reports itself to the host controller.

'Auto' uses default value: for a Root port it is 100 ms,

For a Hub port the delay is taken from Hub descriptor.

F81866 Super IO Configuration

Aptio Setup Utility – Copyright © 2012 American Megatrends, Inc.

Main	Advanced	Chipset	Boot	Security	Save & Exit
F81866 Super IO Configuration					
F81866 Super IO Chip			F81866		→ ← Select Screen
Standby Power on S5			[All Enable]		↑ ↓ Select Item
▶ Serial Port 1 Configuration					Enter: Select
▶ Serial Port 2 Configuration					+ - Change Field
▶ Serial Port 3 Configuration					F1: General Help
▶ Serial Port 4 Configuration					F2: Previous Values
▶ Serial Port 5 Configuration					F3: Optimized Default
▶ Serial Port 6 Configuration					F4: Save
					ESC: Exit

Standby Power on S5

This function is supported only with MB210EF(with EuP/ErP function).

Serial Port 1 Configuration

Set parameters of Serial Port 0 (COMA)

Serial Port 2 Configuration

Set parameters of Serial Port 1 (COMB)

Serial Port 3 Configuration

Set parameters of Serial Port 1 (COMC)

Serial Port 4 Configuration

Set parameters of Serial Port 1 (COMD)

Serial Port 5 Configuration

Set parameters of Serial Port 1 (COME)

Serial Port 6 Configuration

Set parameters of Serial Port 1 (COMF)

F81866 H/W Monitor

Aptio Setup Utility – Copyright © 2012 American Megatrends, Inc.

Main	Advanced	Chipset	Boot	Security	Save & Exit
PC Health Status					
Smart Fan 1 Function			[Disabled]		
Smart Fan 2 Function			[Disabled]		
CPU temperature			:+30 C		
System temperature			:+35 C		
Fan1 Speed			:N/A		
Fan2 Speed			:N/A		→ ← Select Screen
VCORE			:+1.752 V		↑ ↓ Select Item
Vcc5V			:+5.045V		Enter: Select
Vcc12V			:+12.056 V		+ - Change Field

+1.5V	:+1.504V	F1: General Help
VSB5V	:+4.992V	F2: Previous Values
VCC3V	:+3.312V	F3: Optimized Default
VSB3V	:+3.360V	F4: Save
VBAT	:+3.184V	ESC: Exit

Smart Fan Function

Smart Fan Mode Select.

Chipset Settings

This section allows you to configure and improve your system and allows you to set up some system features according to your preference.

Aptio Setup Utility – Copyright © 2012 American Megatrends, Inc.

Main	Advanced	Chipset	Boot	Security	Save &
Exit					
▶ PCH-IO Configuration					
▶ System Agent (SA) Configuration					

PCH-IO Configuration

Aptio Setup Utility – Copyright © 2012 American Megatrends, Inc.

Main	Advanced	Chipset	Boot	Security	Save &
Exit					
Intel PCH RC	Version		1.8.0.0	Options for SATA Configuration	
Intel PCH SKU Name		Q87			
Intel PCH Rev ID		05/C2			
▶ PCI Express Configuration					
▶ USB Configuration					
				→ ←	
				Select Screen	

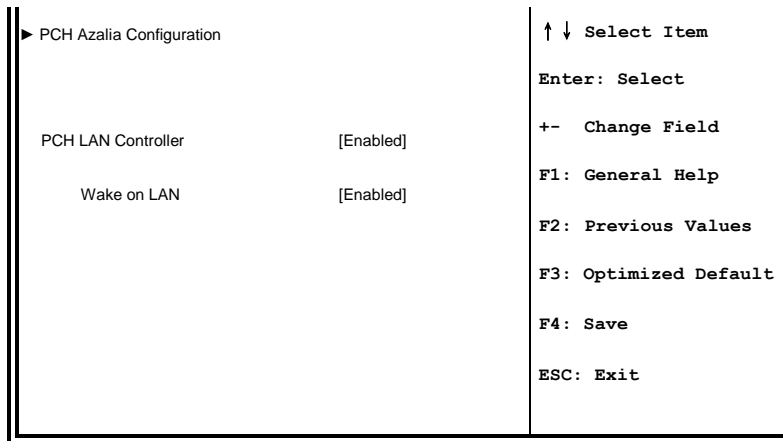

PCI Express Configuration

PCI Express Configuration settings.

USB Configuration

USB Configuration settings.

PCH Azalia Configuration

PCH Azalia Configuration settings.

PCH LAN Controller

Enable of disable onboard NIC.

Wake on LAN

Enable of disable integrated LAN to wake the system.(The Wake on LAN cannot be disabled if ME is on at Sx state.)

System Agent (SA) Configuration

Aptio Setup Utility – Copyright © 2012 American Megatrends, Inc.

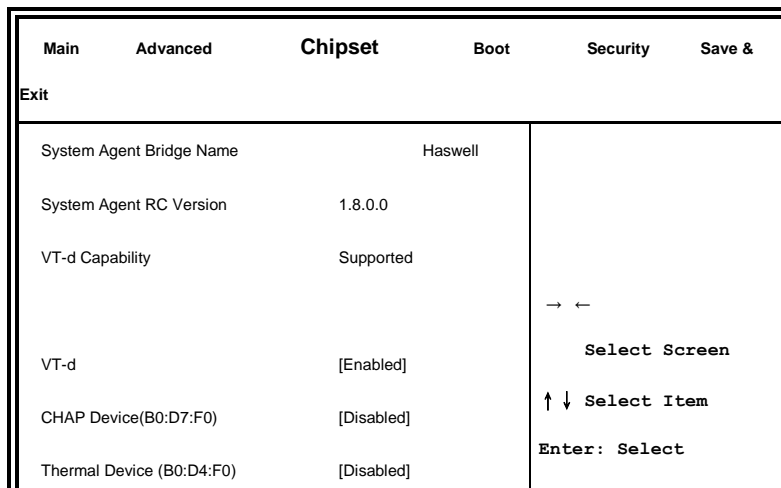

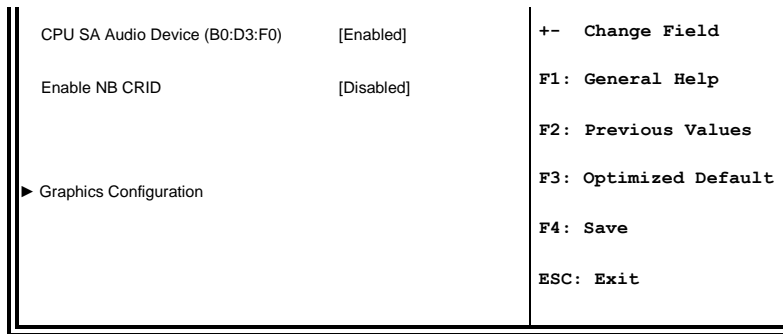

VT-d

Check to enable VT-d function on MCH.

CHAP Device (B0:D7:F0)

Enable or disable SA CHAP Device.

Thermal Device (B0:D4:F0)

Enable or disable SA Thermal Device.

CPU SA Audio Device (B0:D3:F0)

Enable or disable CPU SA Audio Device

Enable NB CRID

Enable or disable NB CRID WorkAround.

Graphics Configuration

Config Graphics Settings.

Boot Settings

This section allows you to configure the boot settings.

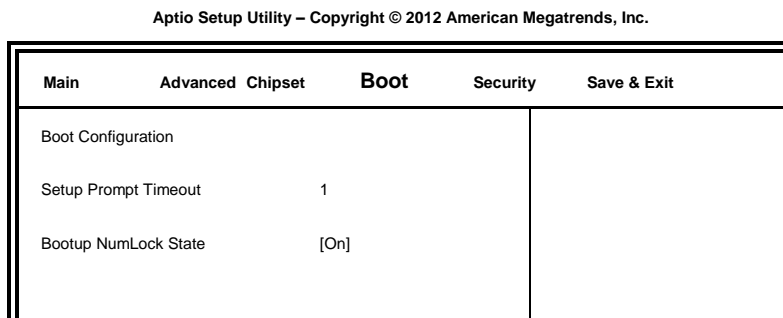

Quiet Boot	[Disabled]	
Fast Boot	[Disabled]	
Boot mode select	[LEGACY]	
FIXED BOOT ORDER Priorities		
Boot option #1	[Hard Disk]	→ ← Select Screen
Boot option #2	[CD/DVD]	↑ ↓ Select Item
Boot option #3	[USB Hard Disk]	Enter: Select
Boot option #4	[USB CD/DVD]	+ - Change Field
Boot option #5	[USB KEY]	F1: General Help
Boot option #6	[USB Floppy]	F2: Previous Values
Boot option #7	[Network]	F3: Optimized Default
		F4: Save
		ESC: Exit
► CSM16 parameters		
CSM parameters		

Setup Prompt Timeout

Number of seconds to wait for setup activation key.

65535(0xFFFF) means indefinite waiting.

Bootup NumLock State

Select the keyboard NumLock state.

Quiet Boot

Enables or Disables Quiet Boot option.

Fast Boot

Enables or Disables boot with initialization of a minimal set of devices required to launch active boot option. Has no effect for BBS boot options.

Boot mode select

Select boot mode LEGACY/UEFI

Boot Option Priorities

Sets the system boot order.

CSM16 parameters

CSM16 configuration Enable/Disable, Option ROM execution settings, etc.

Aptio Setup Utility – Copyright © 2012 American Megatrends, Inc.

Main	Advanced	Chipset	Boot	Security	Save & Exit
CSM16 configuration					→ ← Select Screen
CSM16 Module Version			07.71		↑ ↓ Select Item
GateA20 Active			[Upon Request]		Enter: Select
Option ROM Messages			[Force BIOS]		+ - Change Field
INT19 Trap Response			[Immediate]		F1: General Help
					F2: Previous Values
					F3: Optimized Default
					F4: Save
					ESC: Exit

GateA20 Active

UPON REQUEST – GA20 can be disabled using BIOS services.

ALWAYS – do not allow disabling GA20; this option is useful when any RT code is executed above 1MB

Option ROM Messages

Set display mode for Option ROM

INT19 Trap Response

BIOS reaction on INT19 trapping by Option ROM: IMMEDIATE – execute the trap right away ;

POSTPONED – execute the trap during legacy boot.

CSM parameters

OpROM execution, boot options filter, etc.

Aptio Setup Utility – Copyright © 2015 American Megatrends, Inc.

Main	Advanced	Chipset	Boot	Security	Save & Exit
Launch CSM			[Enabled]		→ ← Select Screen
Boot option filter			[UEFI and Legacy]		↑ ↓ Select Item
Launch PXE OpROM policy			[Do not launch]		Enter: Select
Launch Storage OpROM policy			[Legacy only]		+ - Change Field
Launch Video OpROM policy			[Legacy only]		F1: General Help
					F2: Previous Values
					F3: Optimized Default
Other PCI device ROM priority			[Legacy OpROM]		F4: Save
					ESC: Exit

Launch CSM

This option controls if CSM will be launched.

Boot option filter

This option controls what devices system can boot to.

Launch PXE OpROM policy

Controls the execution of UEFI and Legacy PXE OpROM.

Launch Storage OpROM policy

Controls the execution of UEFI and Legacy Storage OpROM.

Launch Video OpROM policy

Controls the execution of UEFI and Legacy Video OpROM.

Other PCI device ROM priority

For PCI devices other than Network, Mass storage or Video defines which OpROM to launch.

Security Settings

This section allows you to configure and improve your system and allows you to set up some system features according to your preference.

Aptio Setup Utility – Copyright © 2012 American Megatrends, Inc.

Main	Advanced	Chipset	Boot	Security	Save & Exit
Password Description					
If ONLY the Administrator's password is set, then this only limit access to Setup and is only asked for when entering Setup.					
If ONLY the User's password is set, then this is a power on password and must be entered to boot or enter Setup. In Setup the User will have Administrator rights				→ ← Select Screen	
The password length must be in the following range:				↑ ↓ Select Item	
Minimum length			3	Enter: Select	
Maximum length			20	+- Change Field	
Administrator Password				F1: General Help	
User Password				F2: Previous Values	
				F3: Optimized Default	
				F4: Save	
				ESC: Exit	

Administrator Password

Set Setup Administrator Password.

User Password

Set User Password.

Save & Exit Settings

Aptio Setup Utility – Copyright © 2015 American Megatrends, Inc

Main	Advanced	Chipset	Boot	Security	Save & Exit
Save Changes and Exit					
Discard Changes and Exit					
Save Changes and Reset					
Discard Changes and Reset					
Save Options					
Save Changes					→ ← Select Screen
Discard Changes					↑ ↓ Select Item
Restore Defaults					Enter: Select
Save as User Defaults					+ - Change Field
Restore User Defaults					F1: General Help
Boot Override					F2: Previous Values
					F3: Optimized Default
					F4: Save
					ESC: Exit

Save Changes and Exit

Exit system setup after saving the changes.

Discard Changes and Exit

Exit system setup without saving any changes.

Save Changes and Reset

Reset the system after saving the changes.

Discard Changes and Reset

Reset system setup without saving any changes.

Save Changes

Save Changes done so far to any of the setup options.

Discard Changes

Discard Changes done so far to any of the setup options.

Restore Defaults

Restore/Load Defaults values for all the setup options.

Save as User Defaults

Save the changes done so far as User Defaults.

Restore User Defaults

Restore the User Defaults to all the setup options.

CHAPTER 4 DRIVERS INSTALLATION

This section describes the installation procedures for software and drivers. The software and drivers are included with the motherboard. If you find the items missing, please contact the vendor where you made the purchase.

IMPORTANT NOTE:

After installing your Windows operating system, you must install first the Intel Chipset Software Installation Utility before proceeding with the drivers installation.

4.1 Intel Chipset Software Installation Utility

The Intel Chipset Drivers should be installed first before the software drivers to enable Plug & Play INF support for Intel chipset components. Follow the instructions below to complete the installation

1. Insert the DVD that comes with the board. Click Intel and then Intel(R) 8 Series Chipset Drivers.



2. Click **Intel(R) Chipset Software Installation Utility**



3. When the Welcome screen to the Intel® Chipset Device Software appears, click **Next** to continue.



4. Click **Yes** to accept the software license agreement and proceed with the installation process.



5. On the Readme File Information screen, click **Next** to continue the installation.



6. The Setup process is now complete. Click **Finish** to restart the computer and for changes to take effect.



4.2 VGA Drivers Installation

1. Insert the DVD that comes with the board. Click *Intel* and then *Intel(R) 8 Series Chipset Drivers*.



2. Click *Intel(R) HD Graphics Driver*.



3. When the Welcome screen appears, click *Next* to continue.

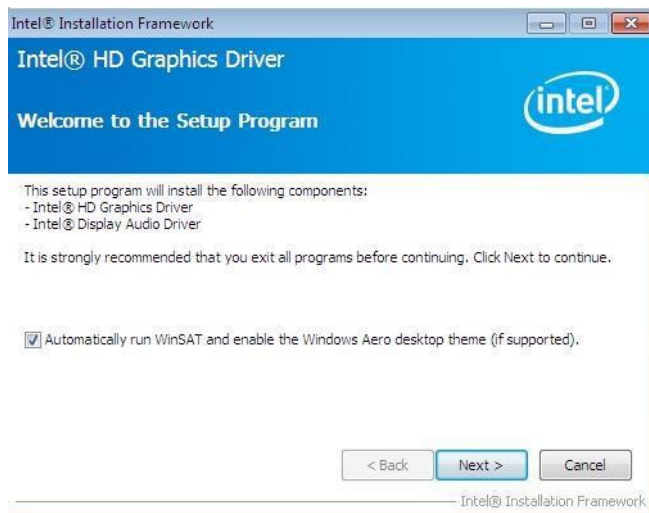

4. Click **Yes** to agree with the license agreement and continue the installation.

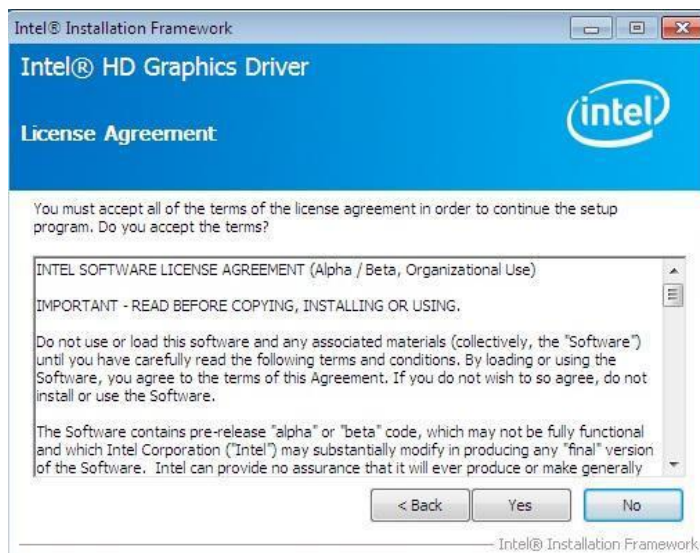

5. On the screen shown below, click **Install** to continue.



6. Setup complete. Click **Finish** to restart the computer and for changes to take effect.

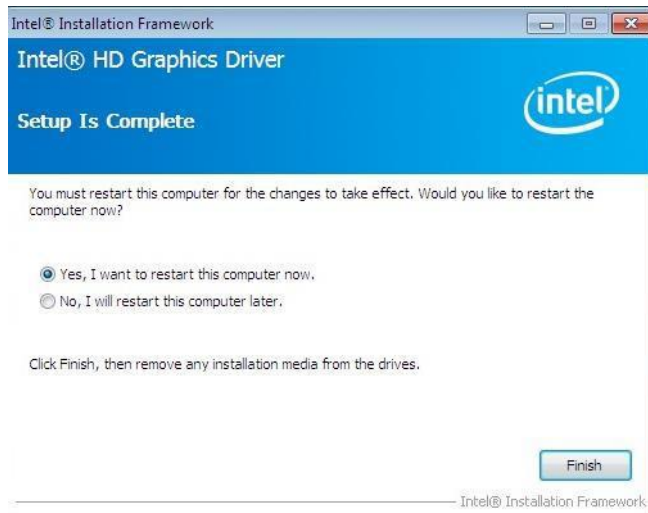

4.3 Realtek HD Audio Driver Installation

1. Insert the DVD that comes with the board. Click *Intel* and then *Intel(R) 8 Series Chipset Drivers*.



2. Click *Realtek High Definition Audio Driver*.

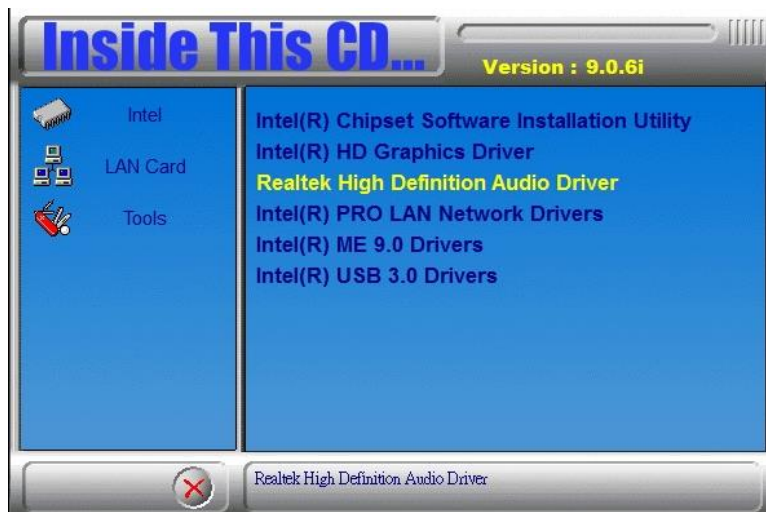

3. On the Welcome to the InstallShield Wizard screen, click *Yes* to proceed with and complete the installation process.

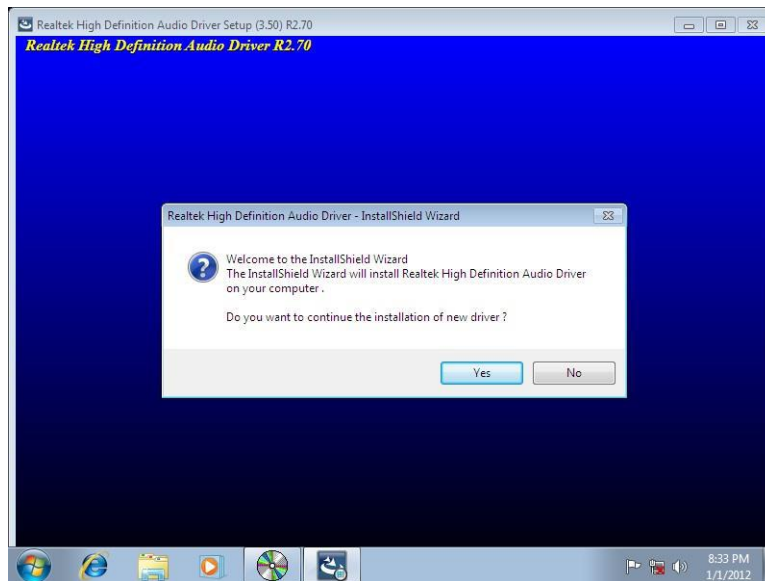

4. The InstallShield Wizard Complete. Click **Finish** to restart the computer and for changes to take effect.

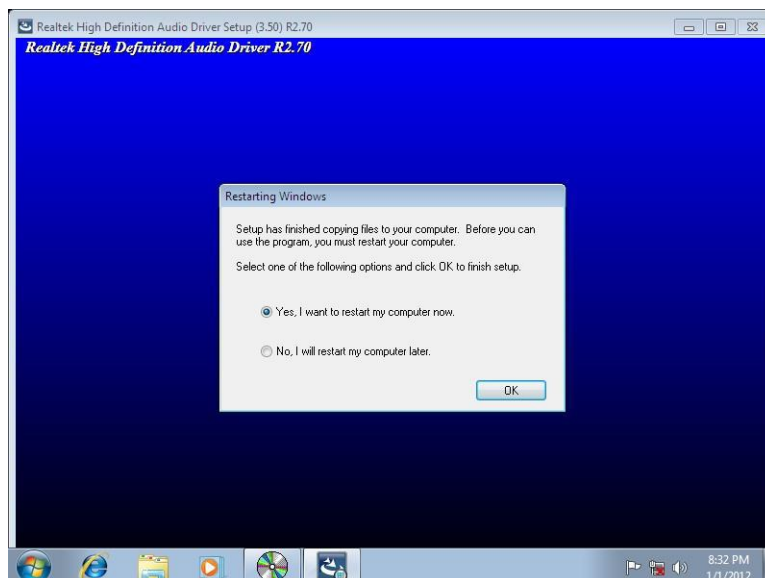

4.4 LAN Drivers Installation

1. Insert the DVD that comes with the board. Click **Intel** and then **Intel(R) 8 Series Chipset Drivers**.



2. Click *Intel(R) PRO LAN Network Driver*.

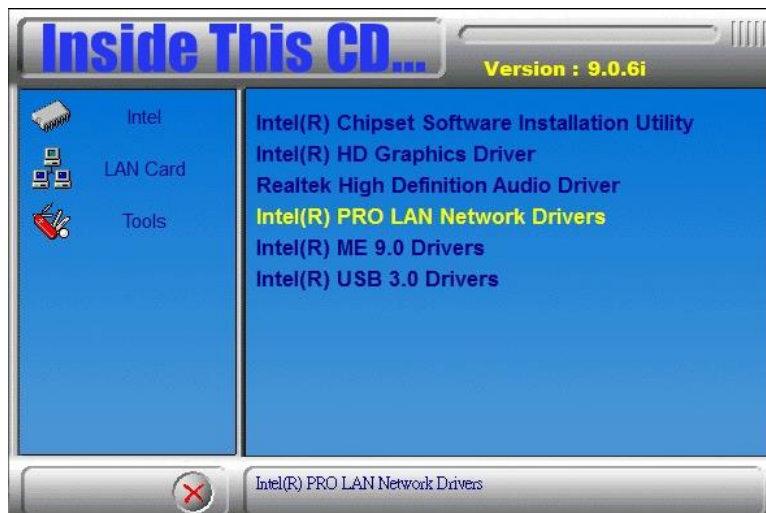

3. When the Welcome screen appears, click *Next*.

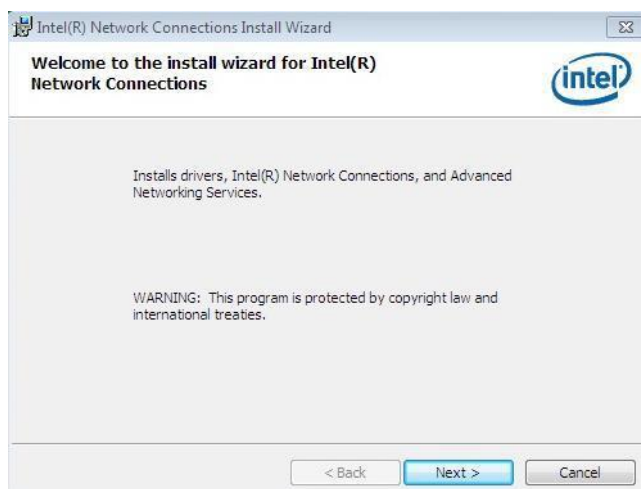

4. Click **Next** to agree with the license agreement.



5. Click the checkbox for **Drivers** in the Setup Options screen to select it and click **Next** to continue.

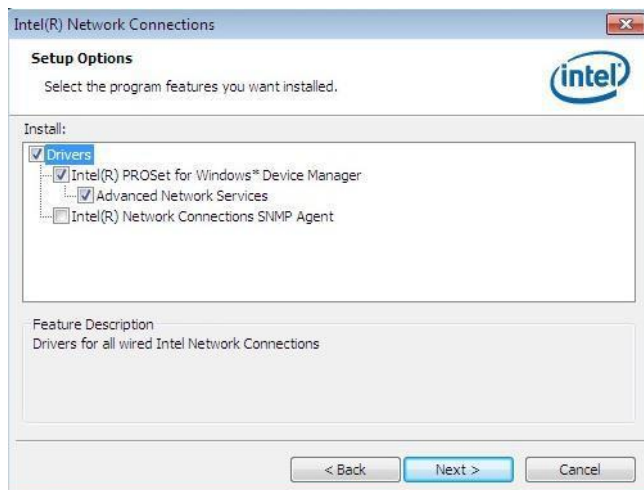

6. The wizard is ready to begin installation. Click **Install** to begin the installation.

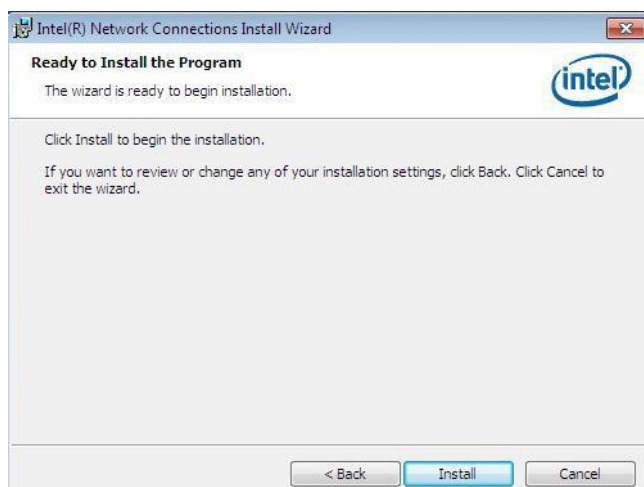

7. When Install Shield Wizard is complete, click **Finish**.

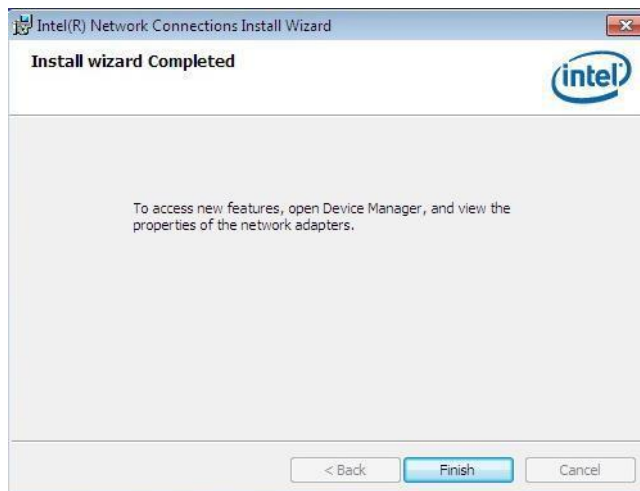

4.5 Intel Management Engine Interface

1. Insert the DVD that comes with the board. Click **Intel** and then **Intel(R) 8 Series Chipset Drivers** and then **Intel(R) ME 9.0 Drivers**.



2. When the Welcome screen to the InstallShield Wizard for Intel® Management Engine Components, click the checkbox for **Install Intel® Control Center** & click **Next**.



3. Click **Yes** to agree with the license agreement.

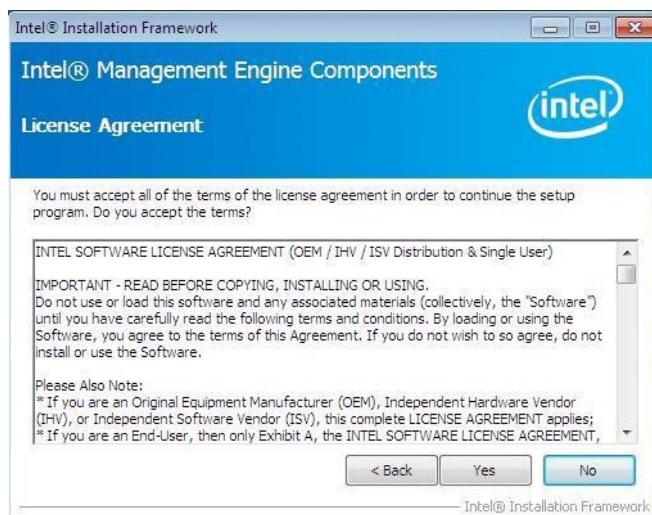

4. When the Setup Progress screen appears, click **Next**. Then, click **Finish** when the setup progress has been successfully installed.

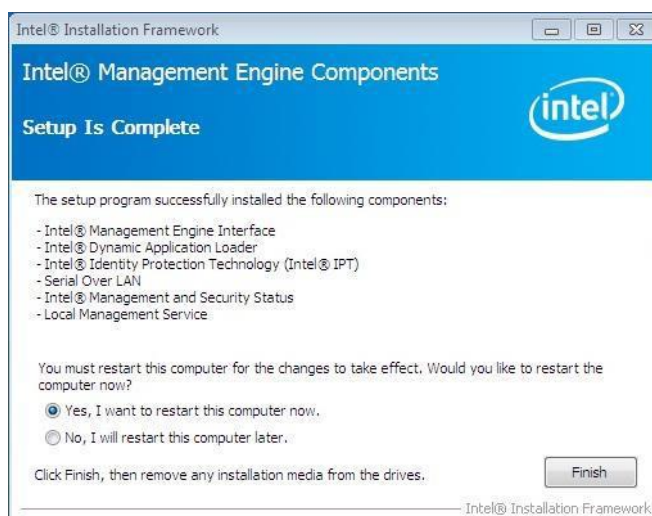

4.6 USB 3.0 Drivers

1. Insert the DVD that comes with the board. Click *Intel* and then *Intel(R) 8 Series Chipset Drivers*.



2. Click *Intel(R) USB 3.0 Drivers*.



3. When the Welcome screen to the Install Shield Wizard for Intel® USB 3.0 extensible Host Controller Driver, click *Next*.



4. Click *Yes* to agree with the license agreement and continue the installation.



Appendix

Mounting AMI210 to the wall

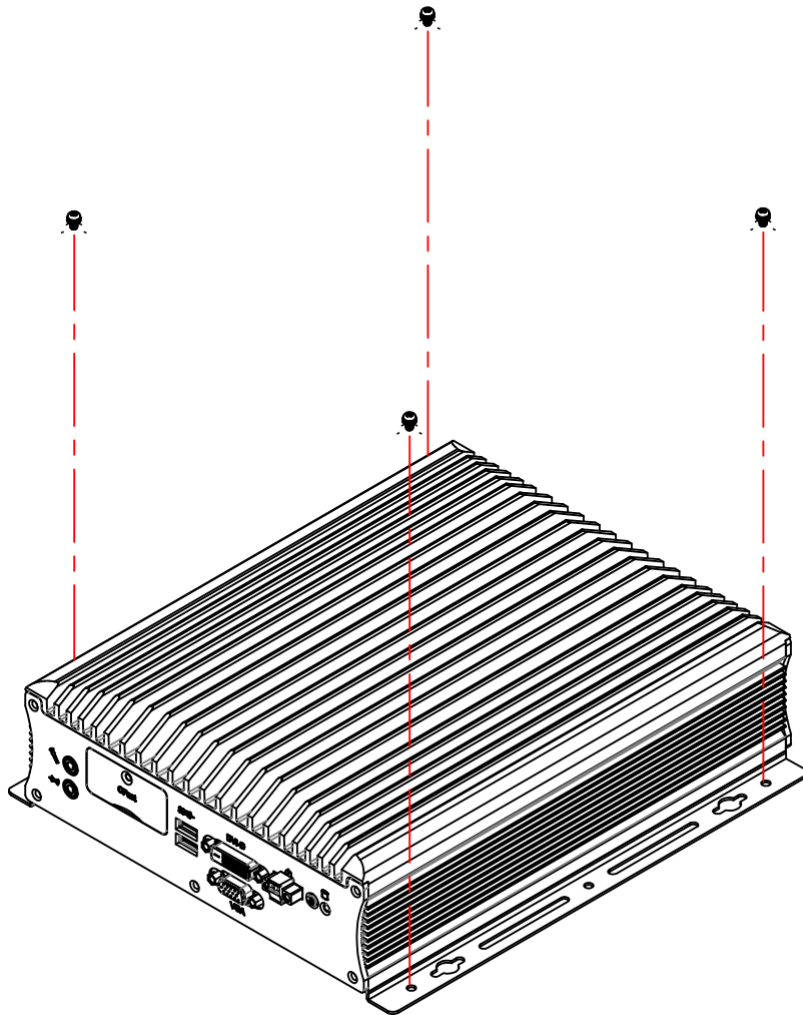

Mounting AMI210-PE to the wall

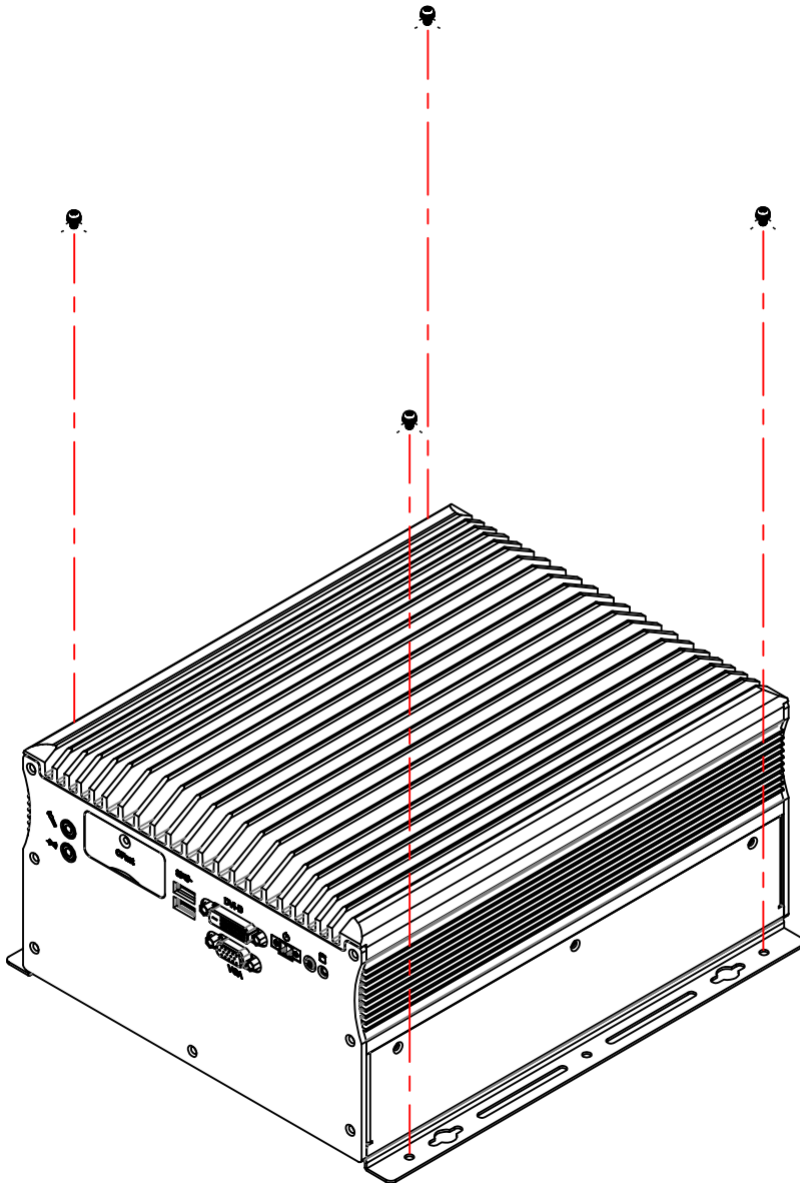

You can install AMI210 on plastic (LCD monitor), wood, drywall surface over studs, or a solid concrete or metal plane directly. Ensure the installer uses at least four M3 length 6mm screws to secure the system on wall. **Four M3 length 6mm screws are recommended to secure the system on wall.**

Fasteners are not included with the unit, and must be supplied by the installer. The types of fasteners required are dependent on the type of wall construction. Choose fasteners that are rated either "Medium Duty" or "Heavy Duty." To assure proper

fastener selection and installation, follow the fastener manufacturer's recommendations.

Wall Mounting Requirements

***Note:** Before mounting the system on wall, ensure that you are following all applicable building and electric codes.*

When mounting, ensure that you have enough room for power and signal cable routing. And have good ventilation for power adapter. The method of mounting must be able to support weight of the CSB110-902 plus the suspend weight of all the cables to be attached to the system. Use the following methods for mounting your system:

Mounting to hollow walls

- **Method 1: Wood surface** – A minimum wood thickness – 38mm (1.5in.) by 25.4 cm (10in.) – of high, construction – grade wood is recommended.
Note: This method provides the most reliable attachment of the unit with little risk that the unit will come loose or require ongoing maintenance.
- **Method 2: Drywall walls** - Drywall over wood studs is acceptable.

Mounting to a solid concrete or brick wall - Mounts on a flat smooth surface.

Selecting the Location

Plan the mounting location thoroughly. Locations such as walkway areas, hallways, and crowded areas are not recommended. Mount the unit to a flat, sturdy, structurally sound column or wall surface.

The best mounting surface is a standard countertop, cabinet, table, or other structure that is minimally the width and length of the unit. This recommendation reduces the risk that someone may accidentally walk into and damage the device. Local laws governing the safety of individuals might require this type of consideration.

Watchdog Timer Configuration

The WDT is used to generate a variety of output signals after a user programmable count. The WDT is suitable for use in the prevention of system lock-up, such as when software becomes trapped in a deadlock. Under these sorts of circumstances, the timer will count to zero and the selected outputs will be driven. Under normal circumstance, the user will restart the WDT at regular intervals before the timer counts to zero.

SAMPLE CODE:

```
//-----
//
// THIS CODE AND INFORMATION IS PROVIDED "AS IS" WITHOUT
// WARRANTY OF ANY
// KIND, EITHER EXPRESSED OR IMPLIED, INCLUDING BUT NOT LIMITED
// TO THE
// IMPLIED WARRANTIES OF MERCHANTABILITY AND/OR FITNESS FOR
// A PARTICULAR
// PURPOSE.
//
//-----
#include <dos.h>
#include <conio.h>
#include <stdio.h>
#include <stdlib.h>
#include "F81866.H"
//-----
int main (int argc, char *argv[]);
void EnableWDT(int);
void DisableWDT(void);
//-----
int main (int argc, char *argv[])
{
    unsigned char bBuf;
    unsigned char bTime;
    char **endptr;
```

```

char SIO;

printf("Fintek 81866 watch dog program\n");

SIO = Init_F81866();
if (SIO == 0)
{
printf("Can not detect Fintek 81866, program abort.\n");
return(1);
} //if (SIO == 0)

if (argc != 2)
{
printf(" Parameter incorrect!!\n");
return (1);
}

bTime = strtol (argv[1], endptr, 10);
printf("System will reset after %d seconds\n", bTime);

if (bTime)
{ EnableWDT(bTime);
}
else
{ DisableWDT();
}

return 0;
}
//-----
void EnableWDT(int interval)
{
unsigned char bBuf;

bBuf = Get_F81866_Reg(0x2B);
bBuf &= (~0x20);
Set_F81866_Reg(0x2B, bBuf);

```

```
//Enable WDTO

Set_F81866_LD(0x07);

//switch to logic device 7
Set_F81866_Reg(0x30, 0x01);

//enable timer

bBuf = Get_F81866_Reg(0xF5);
bBuf &= (~0x0F);
bBuf |= 0x52;
Set_F81866_Reg(0xF5, bBuf);

//count mode is second

Set_F81866_Reg(0xF6, interval);

//set timer

bBuf = Get_F81866_Reg(0xFA);
bBuf |= 0x01;
Set_F81866_Reg(0xFA, bBuf);

//enable WDTO output
```



```

bBuf = Get_F81866_Reg(0xF5);
bBuf |= 0x20;
Set_F81866_Reg(0xF5, bBuf);

```

```

    //start counting
}
//-----
void DisableWDT(void)
{
    unsigned char bBuf;

    Set_F81866_LD(0x07);
    //switch to logic device 7

    bBuf = Get_F81866_Reg(0xFA);
    bBuf &= ~0x01;
    Set_F81866_Reg(0xFA, bBuf);

    //disable WDTO output

    bBuf = Get_F81866_Reg(0xF5);
    bBuf &= ~0x20;
    bBuf |= 0x40;
    Set_F81866_Reg(0xF5, bBuf);

    //disable WDT
}
//-----

```

```
//-----  
//  
// THIS CODE AND INFORMATION IS PROVIDED "AS IS" WITHOUT  
// WARRANTY OF ANY  
// KIND, EITHER EXPRESSED OR IMPLIED, INCLUDING BUT NOT LIMITED  
// TO THE  
// IMPLIED WARRANTIES OF MERCHANTABILITY AND/OR FITNESS FOR  
// A PARTICULAR  
// PURPOSE.  
//  
//-----  
#include "F81866.H"  
#include <dos.h>  
//-----  
unsigned int F81866_BASE;  
void Unlock_F81866 (void);  
void Lock_F81866 (void);  
//-----  
unsigned int Init_F81866(void)  
{  
    unsigned int result;  
    unsigned char ucDid;  
  
    F81866_BASE = 0x4E;  
    result = F81866_BASE;  
  
    ucDid = Get_F81866_Reg(0x20);  
    if (ucDid == 0x07)  
  
        //Fintek 81866  
        { goto Init_Finish;  
        }  
  
    F81866_BASE = 0x2E;  
    result = F81866_BASE;
```

```

ucDid = Get_F81866_Reg(0x20);
if (ucDid == 0x07)

    //Fintek 81866
    { goto Init_Finish;
      }

F81866_BASE = 0x00;
result = F81866_BASE;

Init_Finish:
return (result);
}
//-----
void Unlock_F81866 (void)
{
outportb(F81866_INDEX_PORT, F81866_UNLOCK);
outportb(F81866_INDEX_PORT, F81866_UNLOCK);
}
//-----
void Lock_F81866 (void)
{
outportb(F81866_INDEX_PORT, F81866_LOCK);
}
//-----
void Set_F81866_LD( unsigned char LD)
{
Unlock_F81866();
outportb(F81866_INDEX_PORT, F81866_REG_LD);
outportb(F81866_DATA_PORT, LD);
Lock_F81866();
}
//-----
void Set_F81866_Reg( unsigned char REG, unsigned char DATA)

```

```
{
Unlock_F81866();
outportb(F81866_INDEX_PORT, REG);
outportb(F81866_DATA_PORT, DATA);
Lock_F81866();
}
//-----

unsigned char Get_F81866_Reg(unsigned char REG)
{
unsigned char Result;
Unlock_F81866();
outportb(F81866_INDEX_PORT, REG);
Result = inportb(F81866_DATA_PORT);
Lock_F81866();
return Result;
}
//-----
//-----
//
// THIS CODE AND INFORMATION IS PROVIDED "AS IS" WITHOUT
WARRANTY OF ANY
// KIND, EITHER EXPRESSED OR IMPLIED, INCLUDING BUT NOT LIMITED
TO THE
// IMPLIED WARRANTIES OF MERCHANTABILITY AND/OR FITNESS FOR
A PARTICULAR
// PURPOSE.
//
//-----
#ifndef __F81866_H
#define __F81866_H

    1
//-----
#define F81866_INDEX_PORT

(F81866_BASE)
```

```
#define F81866_DATA_PORT

(F81866_BASE+1)
//-----
#define F81866_REG_LD

0x07
//-----
#define F81866_UNLOCK

0x87
#define F81866_LOCK

0xAA
//-----
unsigned int Init_F81866(void);
void Set_F81866_LD( unsigned char);
void Set_F81866_Reg( unsigned char, unsigned char);
unsigned char Get_F81866_Reg( unsigned char);
//-----
#endif __F81866_H
```