

ARCDIS-1XX(P/G)(H)

(TB-6028)

7", 8", and 10.1" front panel IP66/IP69K(option)
aluminum die-casting chassis Display

User Manual

Release Date

Revision

Jan. 2019

V1.6

©2019 Aplex Technology, Inc.

All Rights Reserved.

Published in Taiwan

Aplex Technology, Inc.

15F-1, No.186, Jian Yi Road, Zhonghe District, New Taipei City 235, Taiwan

Tel: 886-2-82262881 Fax: 886-2-82262883 URL: <http://www.aplertec.com/zh/home.php>

Revision History

Reversion	Date	Description
1.0	2014/10/03	Official Version
1.1	2015/06/10	Add 15.6", 17", and 18.5"
1.2	2015/07/29	Delete description of die-casting, Modify Power Consumption
1.3	2017/04/18	<ul style="list-style-type: none"> ● Remove 15.6",17",18.5",21.5" ● Modify figure of Dimensions and Product images ● Modify Specifications: Add High Brightness External I/O Port Construction of Mechanical ● Enviroment Temperature
1.4	2017/07/25	● Modify IP65 to IP66/IP69K
1.5	2017/10/23	<ul style="list-style-type: none"> ● Modify IP69K for option ● Remove RCA function ● Modify DVI to DVI-D ● Add AR glass non-touch ● Add Auto dimming images
1.6	2019/01/09	● Add G model series information

Warning!

This equipment generates, uses and can radiate radio frequency energy and if not installed and used in accordance with the instructions manual, it may cause interference to radio communications. It has been tested and found to comply with the limits for a Class A computing device pursuant to FCC Rules, which are designed to provide reasonable protection against such interference when operated in a commercial environment. Operation of this equipment in a residential area is likely to cause interference in which case the user at his own expense will be required to take whatever measures may be required to correct the interference.

Electric Shock Hazard – Do not operate the machine with its back cover removed. There are dangerous high voltages inside.

Disclaimer

This information in this document is subject to change without notice. In no event shall Apex Technology Inc. be liable for damages of any kind, whether incidental or consequential, arising from either the use or misuse of information in this document or in any related materials.

Table of Contents

Revision History.....	1
Warning!.....	2
Disclaimer.....	2

Chapter 1 Getting Started

1.1 Features.....	5
1.2 Specifications.....	5
1.3 Dimensions.....	7
1.4 System Diagram(Full Function).....	8
1.5 Brief Description of ARCDIS-1XX(P)(H).....	9
1.6 Display Mode.....	10

Chapter 2 OSD

2.1 AD Board OSD Functions.....	11
2.2 OSD Controls.....	12
2.3 OSD Functions.....	13
2.4 Main Menu.....	13

Chapter 3 Installation

3.1 Windows 7 Universal Driver Installation for PenMount 6000 Series.....	19
3.2 Software Functions.....	27

Appendix A: Board Descriptions & Specifications 45

Descriptions.....	45
Specifications.....	45
Board Dimensions.....	46

Appendix B: Panel Mounting and VESA Mounting 47

Figures

Figure 1.1: Dimensions of ARCDIS-107(P/G)(H).....	7
Figure 1.2: Dimensions of ARCDIS-108(P/G)(H).....	7
Figure 1.3: Dimensions of ARCDIS-110(P/G)(H).....	8
Figure 1.4: System Diagram of TB-6028.....	8
Figure 1.5: Front View of ARCDIS-1xx(P/G)(H).....	9
Figure 1.6: Rear View of ARCDIS-1xx(P/G)(H).....	9
Figure A: Dimensions of TB-6028.....	46
Figure B: Panel mounting and VESA mounting.....	47

Chapter 1 Getting Started

1.1 Features

- Solid Aluminum chassis
- Variety of LCD panel size selections
- IP66 / **IP69K(option)** compliant front bezel
- VGA and DVI-D input
- Wide range DC 9~36V power input
- Auto dimming for option (not available for 7" display)
- Support protective AR glass for option (non-touch version)

1.2 Specifications

	ARCDIS-107 (P/G)	ARCDIS-107 (P/G)H	ARCDIS-108 (P/G)	ARCDIS-108 (P/G)H	ARCDIS-110 (P/G)	ARCDIS-110 (P/G)H
Hardware						
Display Type	7" color TFT LCD		8" color TFT LCD		10.1" color TFT LCD	
External I/O Port	<p>Default I/O:</p> <p>1 x 3 pins terminal block for DC 9~36V power input</p> <p>1 x DVI-D</p> <p>1 x VGA</p> <p>1 x USB type A for Touch control</p> <p>Option I/O:</p> <p>1 x line in by phone jack</p> <p>1 x RS-232 DB-9 for Touch control</p>					
LED Light	1 x system power LED light					
OSD Control	On board controller, extendable key pad from connector Transfer Board OSD Membrane Keypad					
Speaker	1 x 2W speaker for option					
LCD						
Max. Resolution	800x480		800x600		1280x800	
Max. Color	262K	262K	16.2M	16.2M	16.7M	16.2M
Luminance(cd/m ²)	350	1000	350	1000	350	1000
Contrast Ratio	400 : 1	400 : 1	500 : 1	500 : 1	800 : 1	1000:1
Viewing Angle (H/V)	140(H)/130(V)		140(H)/125(V)		170(H)/170(V)	
Backlight Lifetime	40,000 hrs	50,000 hrs(H)	40,000 hrs	30,000 hrs(H)	25,000 hrs	50,000 hrs(H)

Power Input	DC 9~36V on board		
Power Consumption	MAX: 4.2W MAX: 4.1W(P)	MAX:4.7W MAX:3.6W(P)	MAX:6.2W MAX:5.9W(P)
Touch Screen ARCDIS-1XX (H)			
Type	Resistive Touch Window		
Interface	Default USB / RS-232 for option		
Light Transmission	Over 80%		
Touch Screen ARCDIS-1XXP(H)			
Type	Projected Capacitive		
Interface	USB		
Light Transmission	Over 90%		
Touch Screen ARCDIS-1XXG(H)			
Type	Glass-AR		
Interface	NA(Glass)		
Light Transmission	Over 93%		
Mechanical			
Construction	Aluminum die-casting chassis		
Dimensions	202x149x40 mm	231.1x176.1x50 mm	285x189x48.9 mm
Net Weight	1 kg	1.8 kg	1.7 kg
Mounting	Panel mount / VESA 75x75		Panel mount / VESA 100x100
Environment Specifications			
Operating Temperature	0 ~ 50 °C 20 ~ 60 °C for option		
Storage Temperature	-30 ~ 70 °C		
Storage Humidity	10 ~ 90% @40°C Non-condensing, without touch screen		
IP Rating	Front Panel IP66 / IP69K(option)		
Certificate	CE/FCC Class A		

1.3 Dimensions

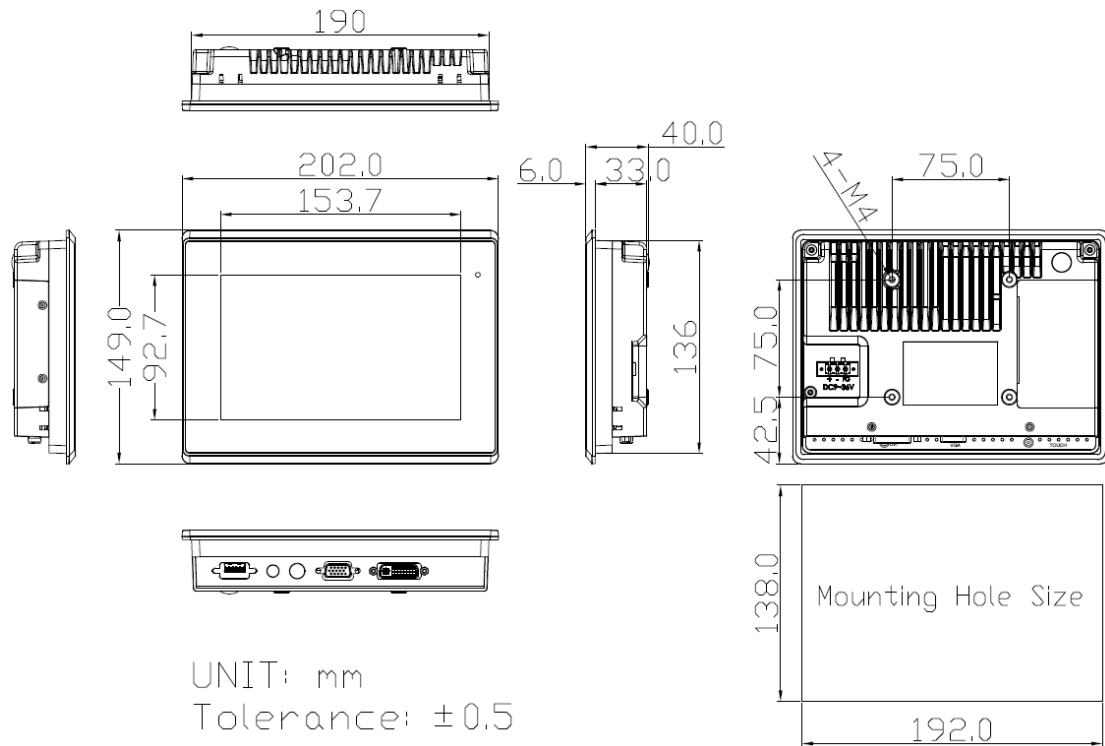

Figure 1.1: Dimensions of ARCDIS-107 (P/G) (H)

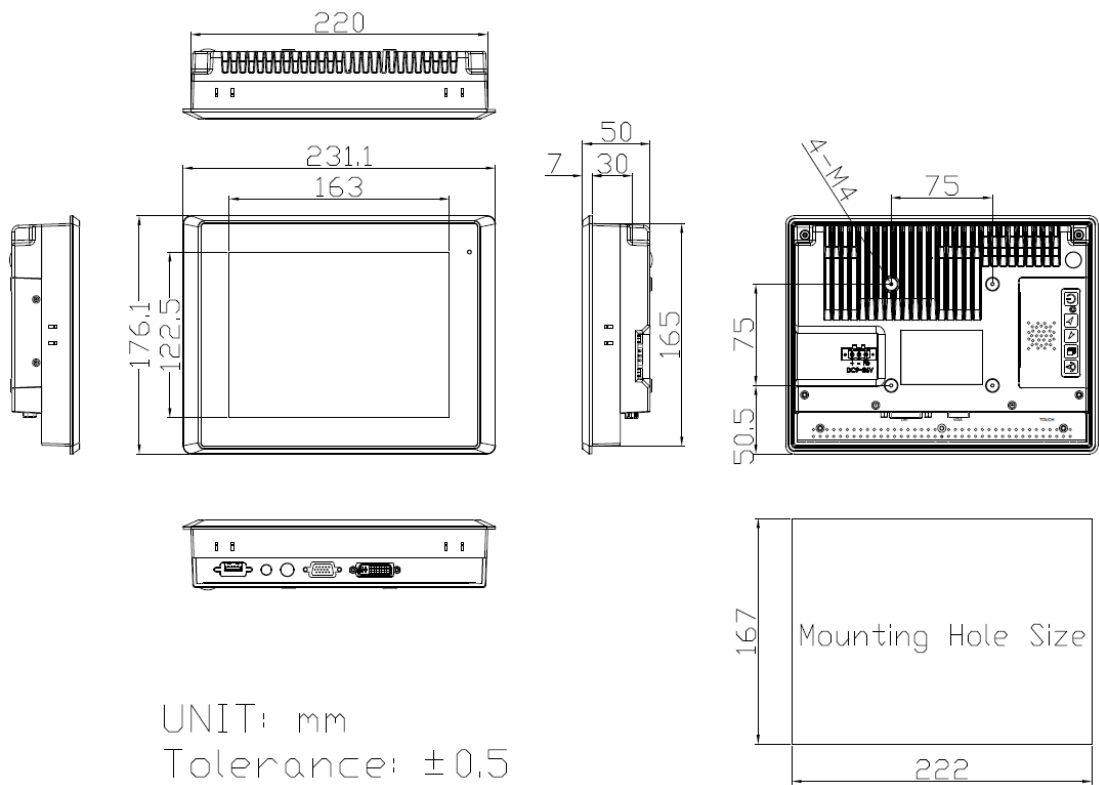

Figure 1.2: Dimensions of ARCDIS-108 (P/G) (H)

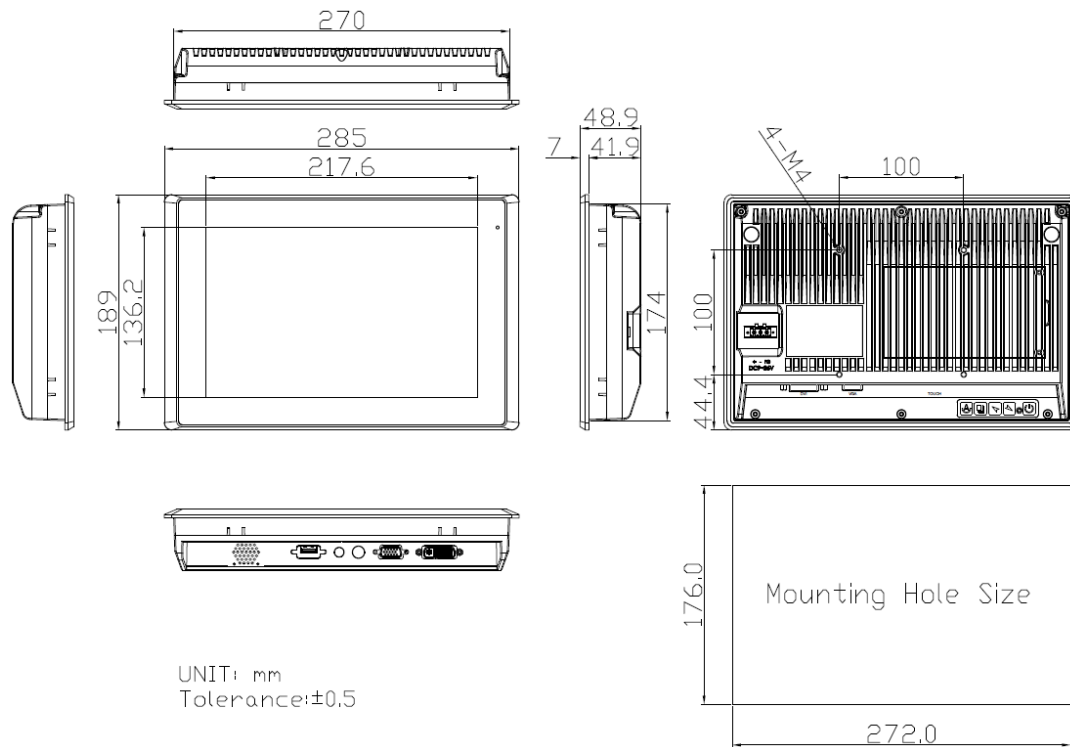

Figure 1.3: Dimensions of ARCDIS-110 (P/G) (H)

1.4 System Diagram (Full Function)

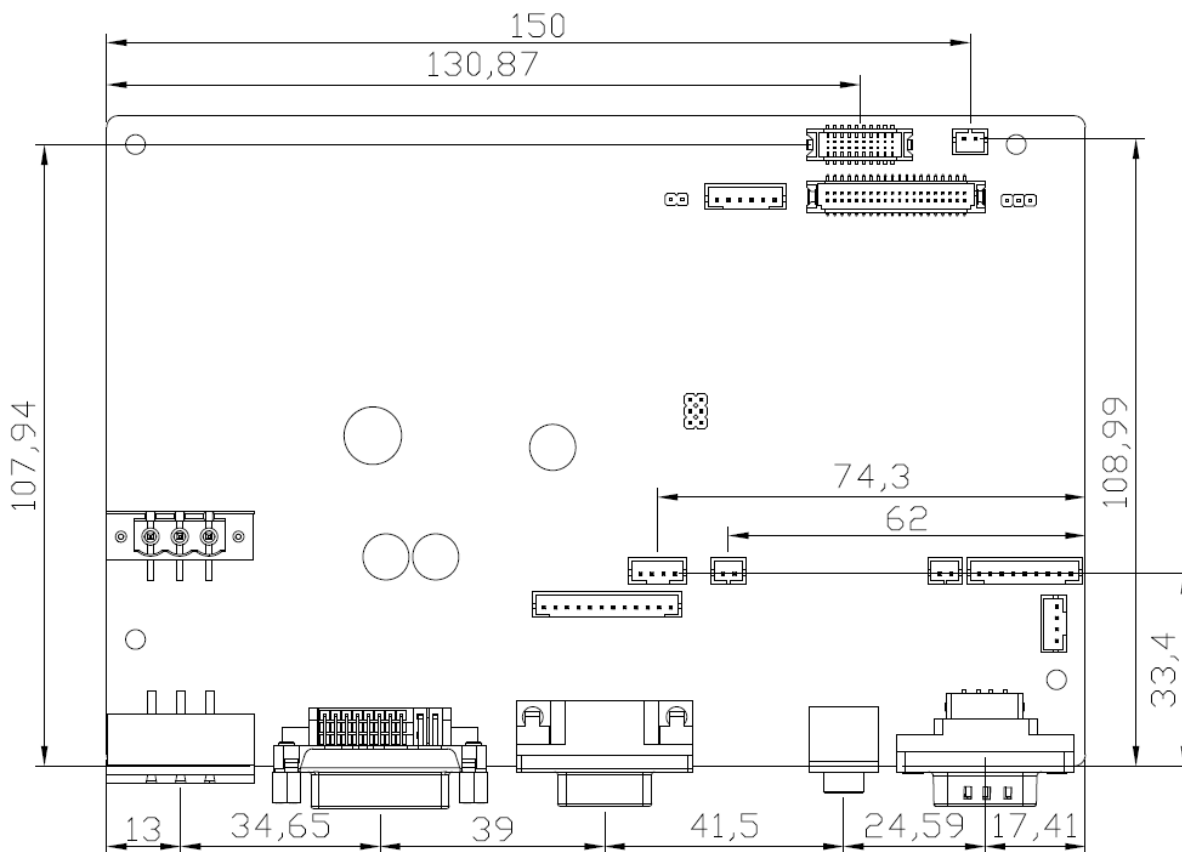

Figure 1.4: System diagram of TB-6028

1.5 Brief Description of ARCDIS-1XX (P/G)(H)

ARCDIS-1XX(P/G)(H) series with TB-6028 AD Board is an IP66 / **IP69K(option)** compliant front panel designed aluminum die-casting chassis LCD display, which comes with 7, 8, and 10.1 inch color TFT LCD. It can be panel mounted in front bezel and VESA 75 x 75 or VESA 100 x 100 mounted in rear bezel. There are multiple external I/O ports come with VGA, DVI-D, USB, and RS-232...etc. The power supports wide range DC 9~36V power input. Furthermore, High brightness 1,000 nits LCD is ideal for sunlight readable semi-outdoors applications, and LCD can be optical bonding designed for option. ARCDIS-1XX (P/G)(H)series model has more outstanding features, thus giving the best in monitoring and control application.



Figure 1.5: Front View of ARCDIS-1xx (P/G) (H)

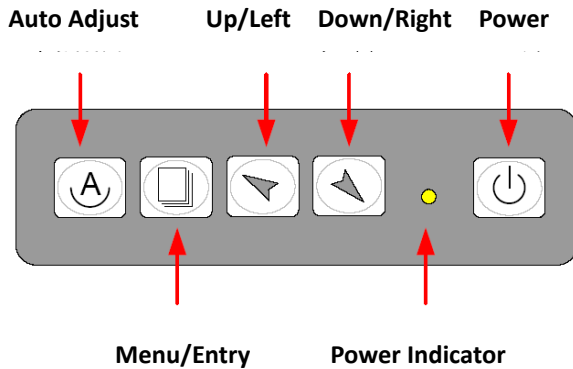



Figure 1.6: Rear View of ARCDIS-1xx (P/G) (H)

1.6 Display Mode

Item	Resolution	H Freq.(kHz)	V Freq.(Hz)	Remark
1	640x350@70	31.469	70.087	VGA
2	640x400@70	31.469	70.087	VGA
3*	640x480@60	31.469	59.940	VESA
4	640x480@66	35.000	66.667	MAC
5	640x480@72	37.861	72.809	VESA
6*	640x480@75	37.500	75.000	VESA
7	720x400@70	31.469	75.000	TEXT
8	800x600@56	35.156	56.250	VESA
9*	800x600@60	37.879	60.317	VESA
10	800x600@72	48.077	72.188	VESA
11*	800x600@75	46.875	75.000	VESA
12	832x624@75	49.107	75.087	MAC
13	848x480@60	31.020	60.000	VESA
14*	1024x768@60	48.363	60.004	VESA
15*	1024x768@75	60.023	75.029	VESA
17	1152x864@70	63.850	70.000	VESA
18	1152x864@75	67.500	75.000	VESA
19	1152x900@76	71.809	76.149	SUN
20*	1280x768@60	47.730	60.000	VESA
21*	1280x768@75	60.290	74.890	VESA
22	1280x960@60	60.000	60.000	VESA
23*	1280x1024@60	63.980	60.000	VESA
24*	1280x1024@75	79.976	75.025	VESA
25*	1366x768@60	47.710	60.020	VESA
26	1440x900@60	56.040	60.000	VESA
27	1440x1050@60	65.320	59.980	VESA
28	1440x1050@75	82.280	74.870	VESA
29*	1920x1080@60	67.500	60.000	VESA

2.1 AD Board OSD Functions



 Power switch: To turn ON or OFF the power



 Shift the icon to the right side or shift it up

 Shift the icon to the left side or shift it down



 Menu: To enter OSD menu for related icon and item.

 Auto Button: One-touch auto adjustment





1.) Getting into Burn-in Mode

Before setting into a burn-in mode, first disconnect the AC power cord. Then press (don't let them go) the   buttons until the AC power cord is connected and the "RGB" appears on the top left corner of your screen. Now it can be put into the burn-in mode for changing colors.

2.) Getting Out of Burn-in Mode









Before getting out of the burn-in mode, please first disconnect the AC power cord. Then press the  button (If not workable, press the  button and don't let them go) until the AC power cord is connected. Please don't let your fingers go until the AC power cord is connected again and the wording of "RGB" appears on the top left corner of your screen, and wait for 3 second. Under the non-signal entry situation, if **Cable Not Connected** is seen, exit is thus successfully made.

When the Burn-in Mode is Unable to Eradicate...

- 1.) If the “RGB” is still on the top left corner of the screen, press  to enter “Miscellaneous” and choose “Reset”, and then **Yes**, and press . When the screen goes black, disconnect power and repeat the above steps.
- 2.) If the “RGB” is not found, disconnect the AC power cord first. Then press the   buttons (don't let them go) until the AC power cord is connected, and wait for 2 to 3 seconds. When “RGB” appears, repeat the above steps.

2.2 OSD Controls

To make any adjustment, select the following:

1. Press  (Menu) to show the OSD menu or disable the OSD menu.
2. Select the icon that you wish to adjust with the ( /  or +/-) key in the menu.
3. Press  (Menu) and then choose the item with the ( /  or +/-) key.
4. Press  (Menu) and then adjust the quality with the ( /  or +/-) key.

2.3 OSD Function

1. Power button: Power on/off
2. Down button: Brightness
3. Up button: Volume
4. Menu button: Menu
5. Auto button: Auto adjustment

2.4 Main Menu

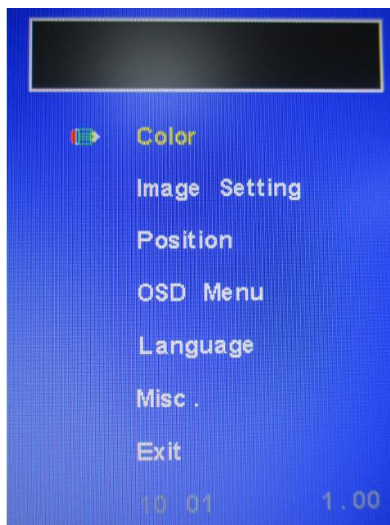

In the **Main menu**, there are the following items:

- Color
- Image Setting
- Position
- OSD Menu
- Language
- Misc.
- Exit

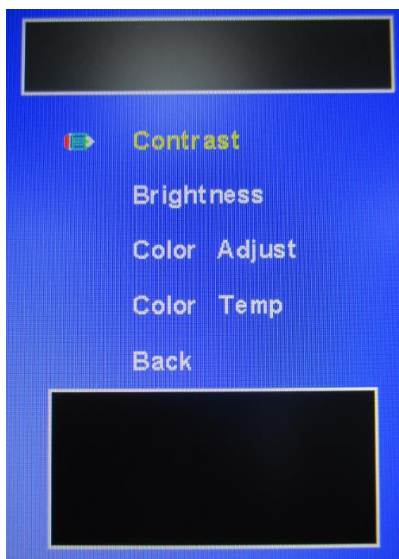

For **Color**, check out the following:

- Contrast
- Brightness
- Color Adjust
- Color Temp
- Back

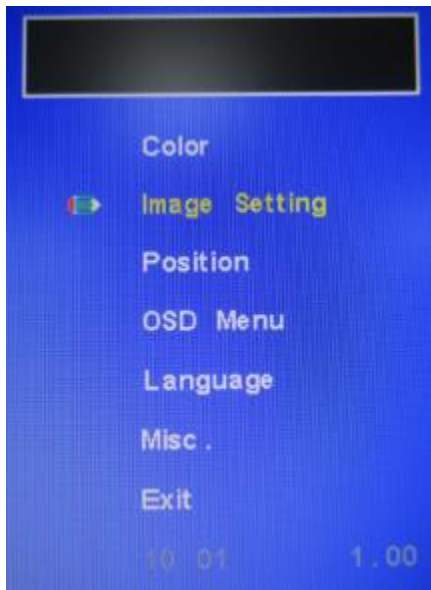

For **Image setting**, check out the following:

- Clock
- Phase
- Gamma
- Sharpness
- Back

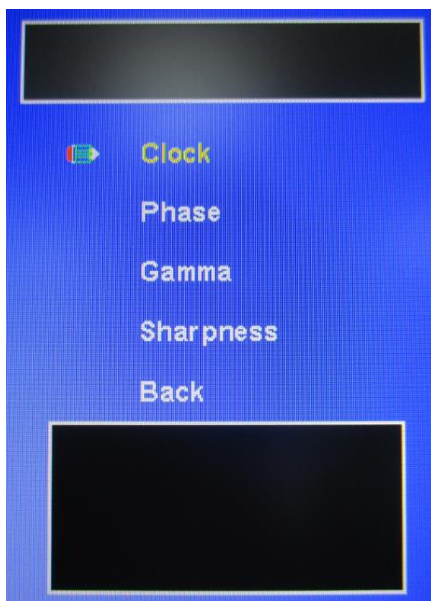

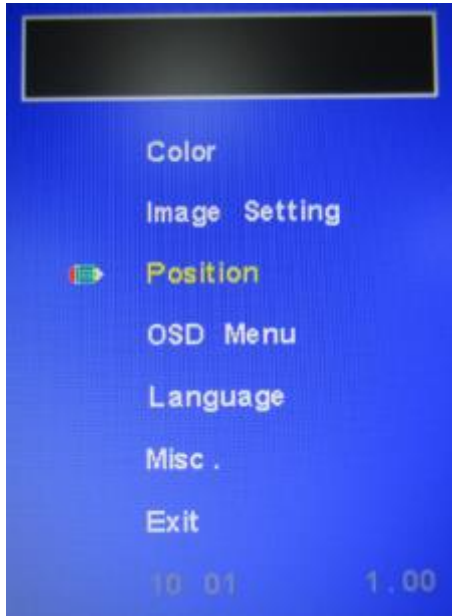

In the **Position**, there are the following:

- H. Position
- V. Position
- Back

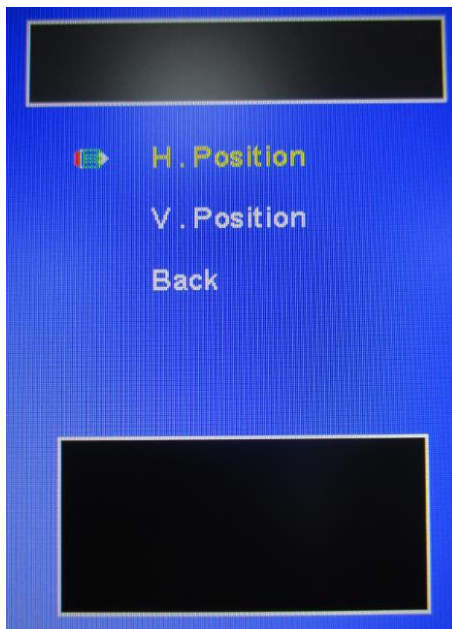



In the **OSD** menu, there are:

- OSD H. Pos.
- OSD V. Pos.
- OSD Timer
- Back

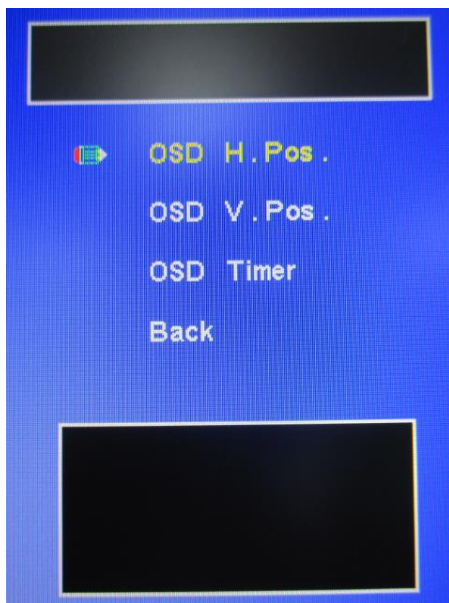

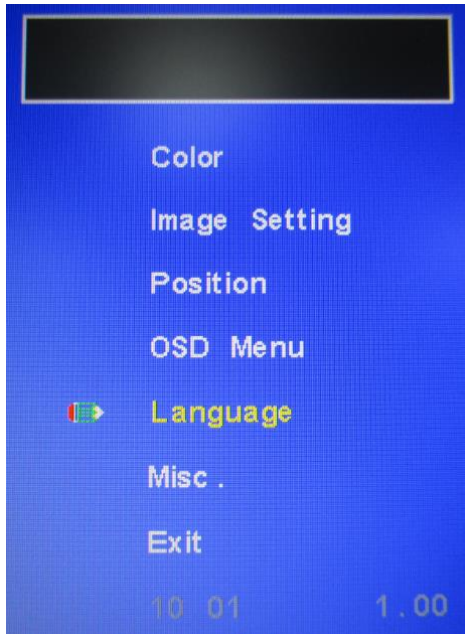

In the **Language** menu, there are:

- English
- Frances
- Germany
- Spanish
- Traditional Chinese
- Simplified Chinese
- Japanese



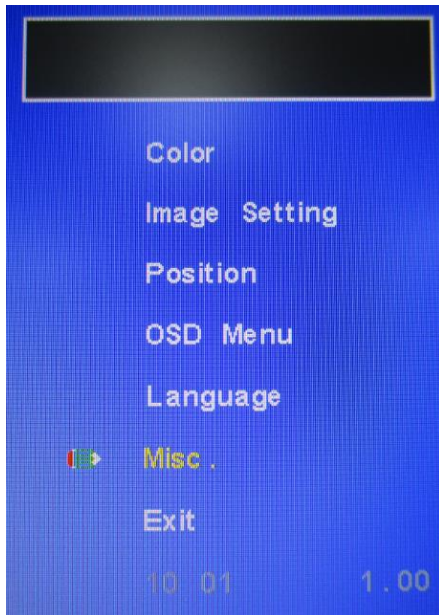

In the **Misc** menu, there are:

- Signal Source
Select VGA: Analogue VGA Input
Select DVI: Digital DVI-D Input
Select AV: Composite Video Input
Select SV: S-Video Video Input
- Reset
- Auto Dimming
Select Enable: function on
Select disable: Function off
- Back

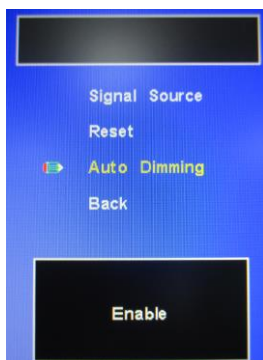
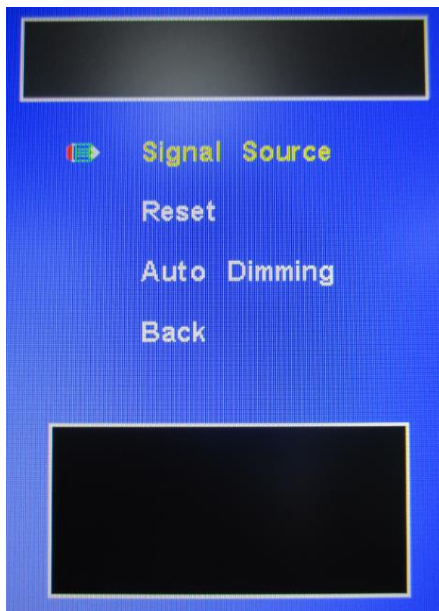

function on

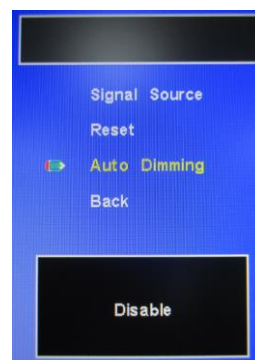

function off

Chapter 3 Installation

This chapter describes how to install drivers and other software that will allow your touch screen work with different operating systems.

3.1 Windows 7 Universal Driver Installation for

PenMount 6000 Series

Before installing the Windows 7 driver software, you must have the Windows 7 system installed and running on your computer. You must also have one of the following PenMount 6000 series controller or control boards installed: PM6500, PM6300.

3.1.1 Installing Software(Resistive Touch)

If you have an older version of the PenMount Windows 7 driver installed in your system, please remove it first. Follow the steps below to install the PenMount DMC6000 Windows 7 driver.

Step 1. Click **Next** to continue.

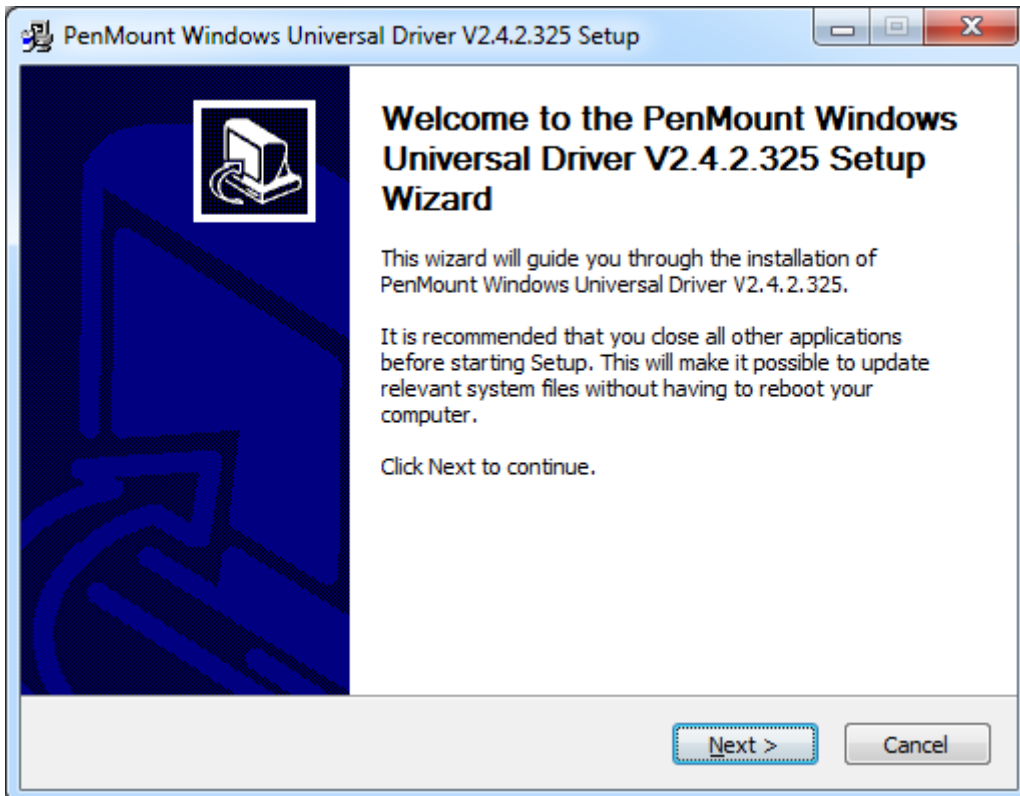

Step 2. Read the license agreement. Click **I Agree** to agree the license agreement.

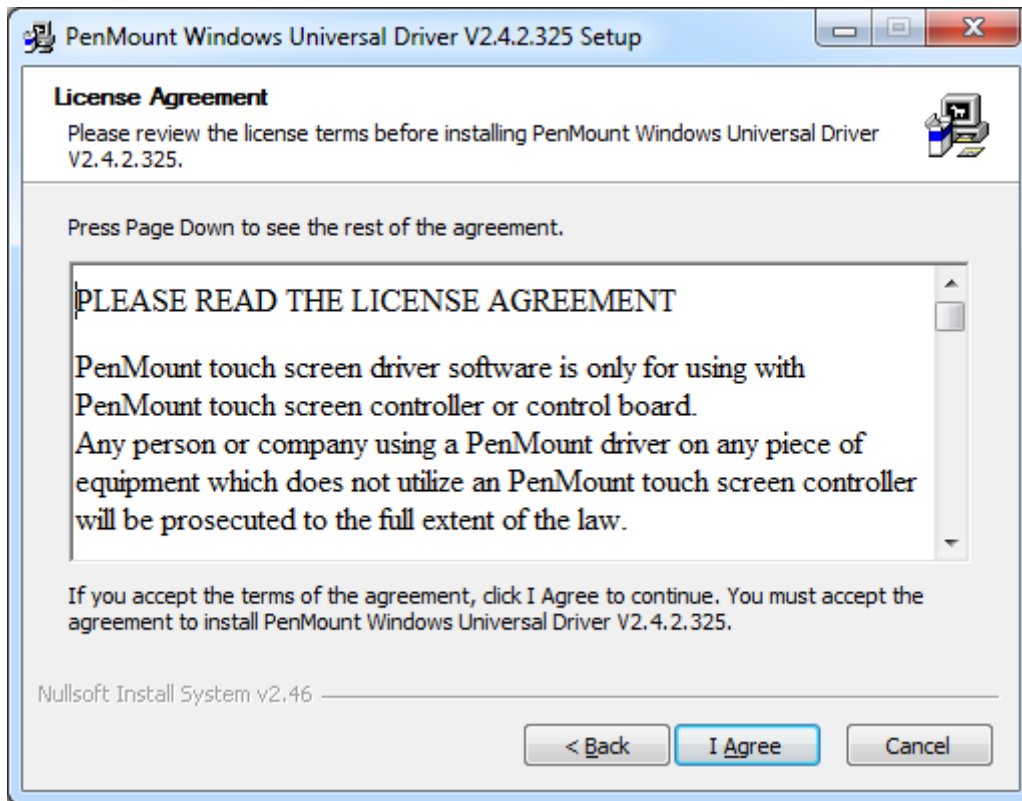

Step 3. Choose the folder in which to install PenMount Windows Universal Driver. Click **Install** to start the installation.

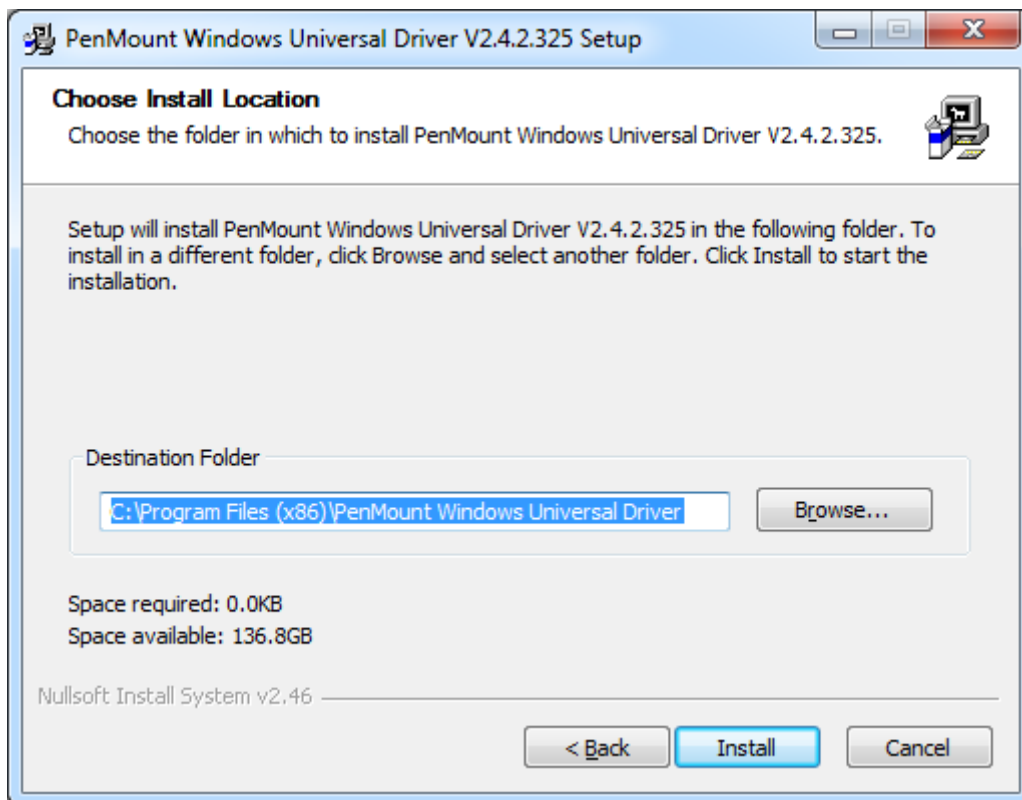

Step 4. Click **Yes** to continue.

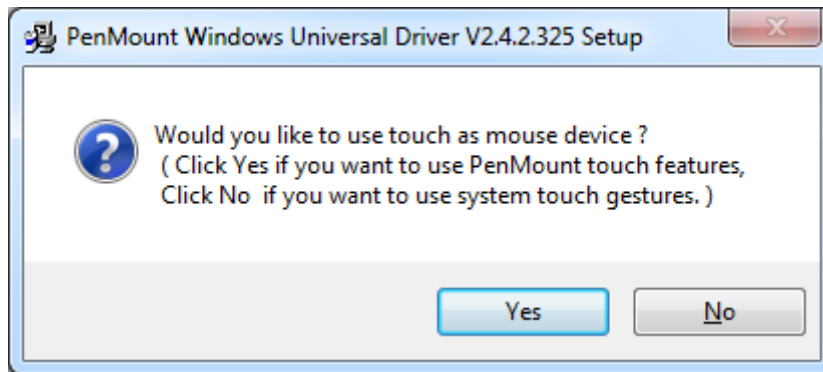

Step 5. Click **Finish** to complete installation.

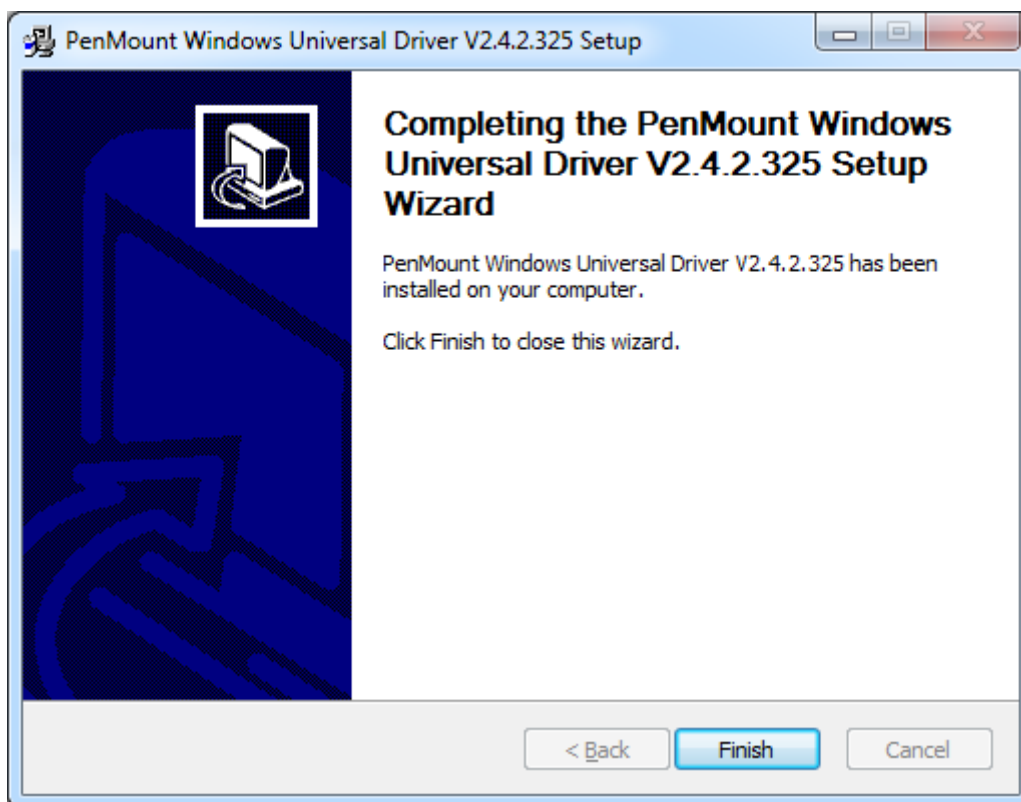

3.1.2 Installing Software (Projected Capacitive)

Step 1. Click **Next** to continue.

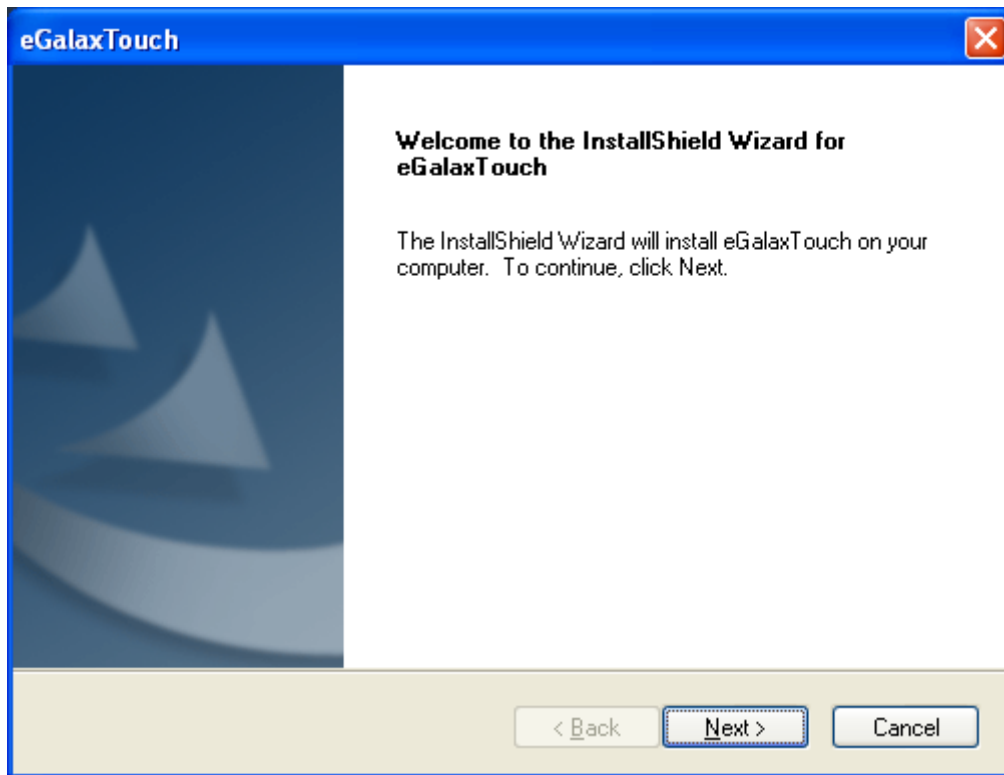

Step 2. Select **I accept the terms of the license agreement**. Click **Next**.

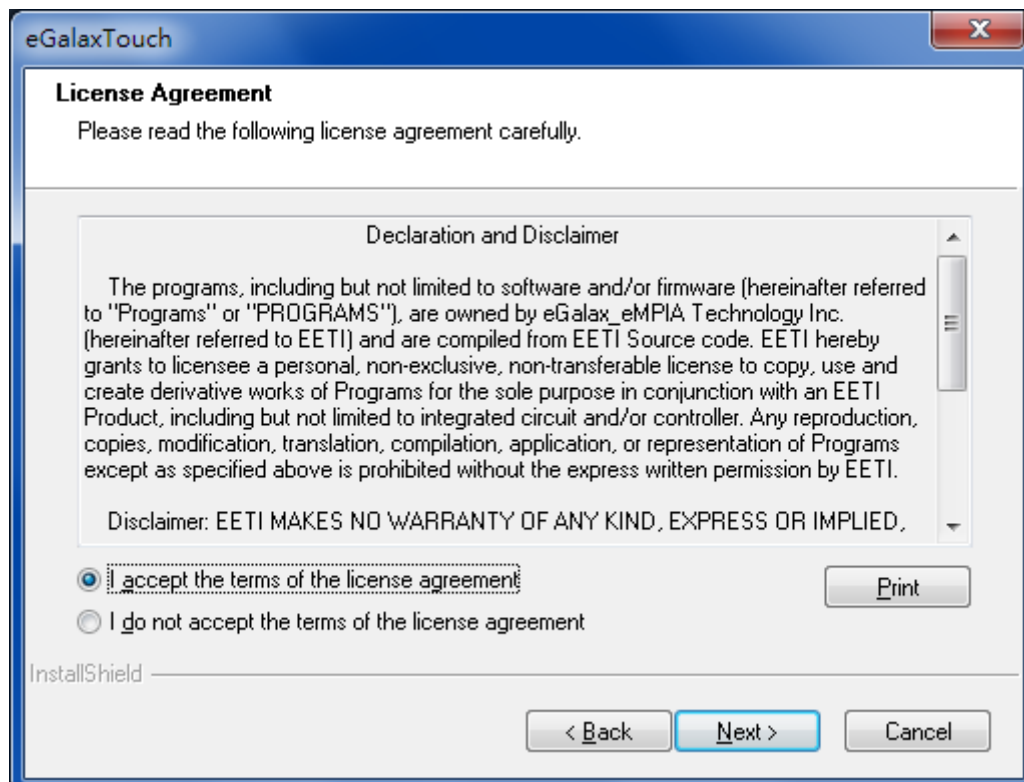

Step.3. Click **Next** to continue.

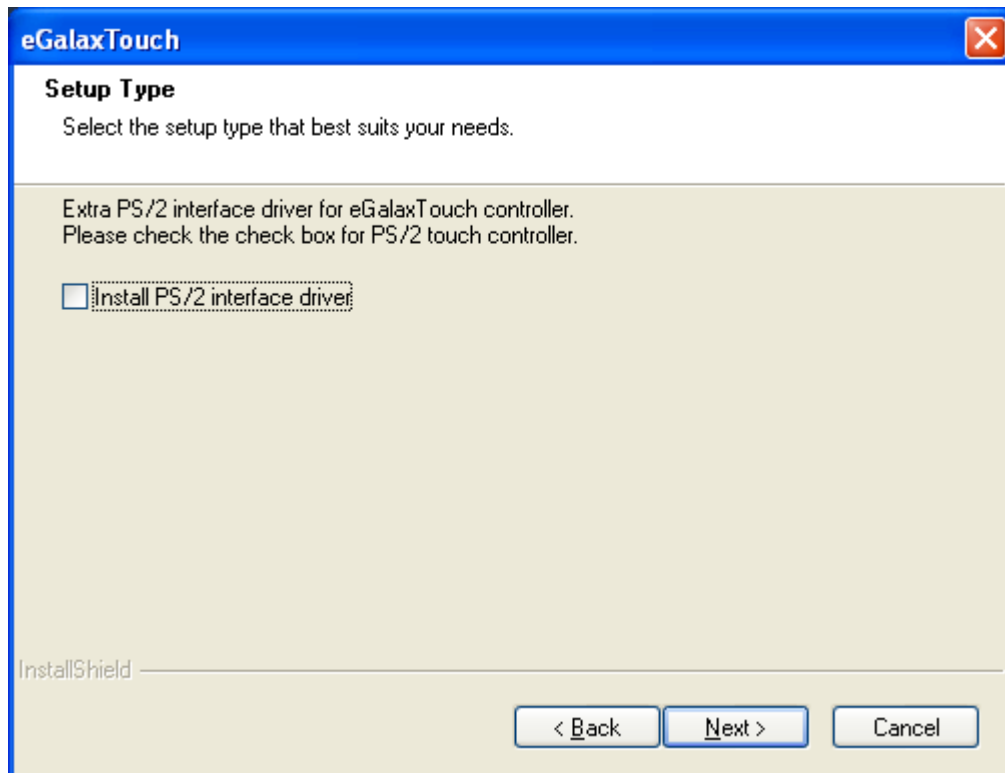

Step 4. Click **Install RS232 interface driver**.

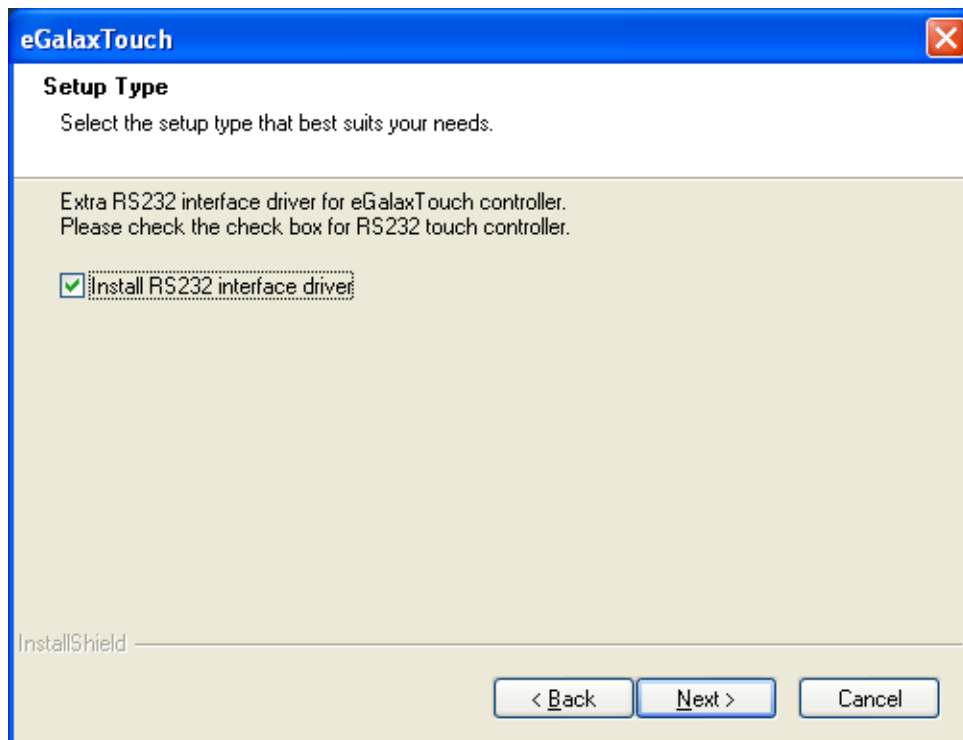

Step 5. Select None. Click Next.

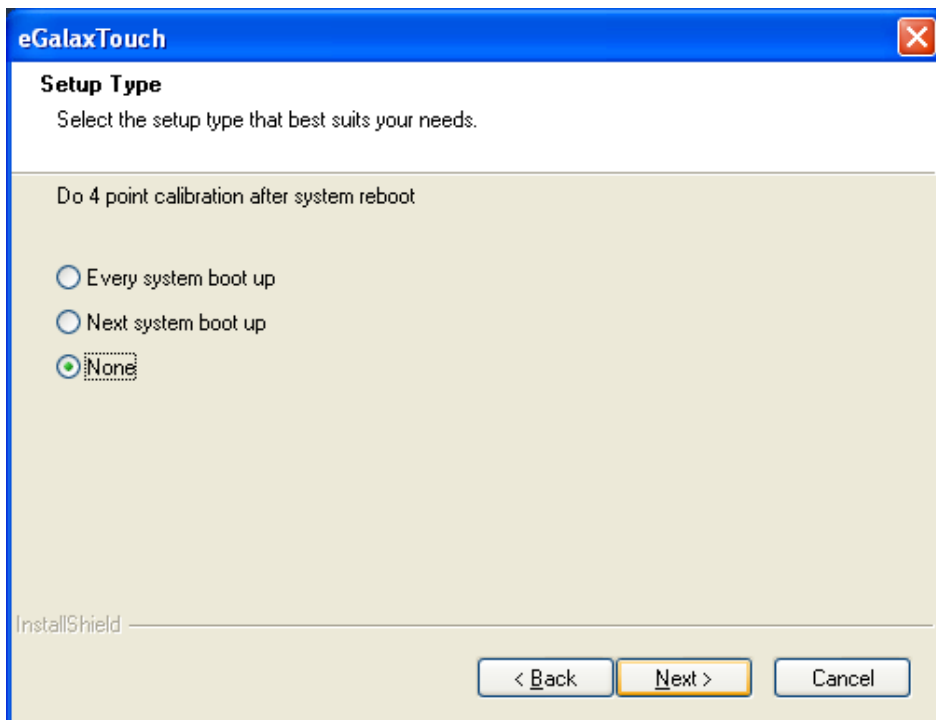

Step 6. Click OK.

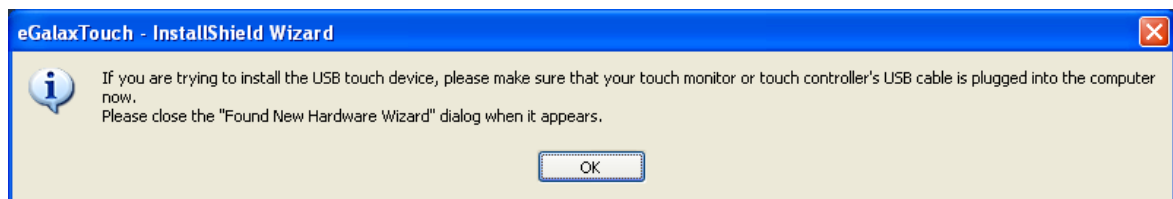

Step 7. Click Support Multi-Monitor System. Click Next.

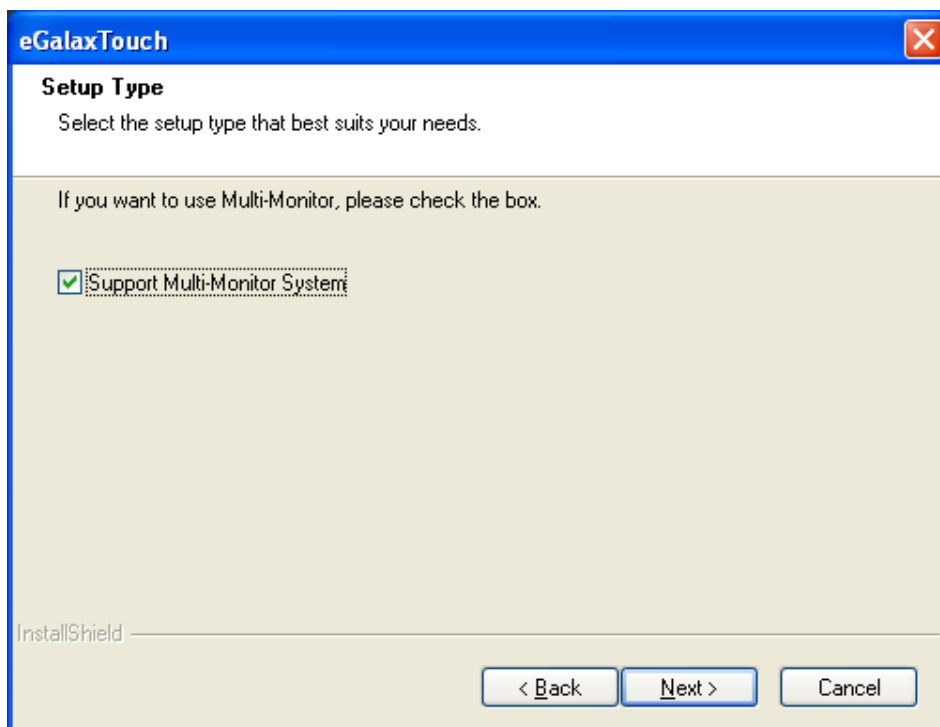

Step 8. Go to **C:\Program Files\eGalaxTouch**. Click **Next**.

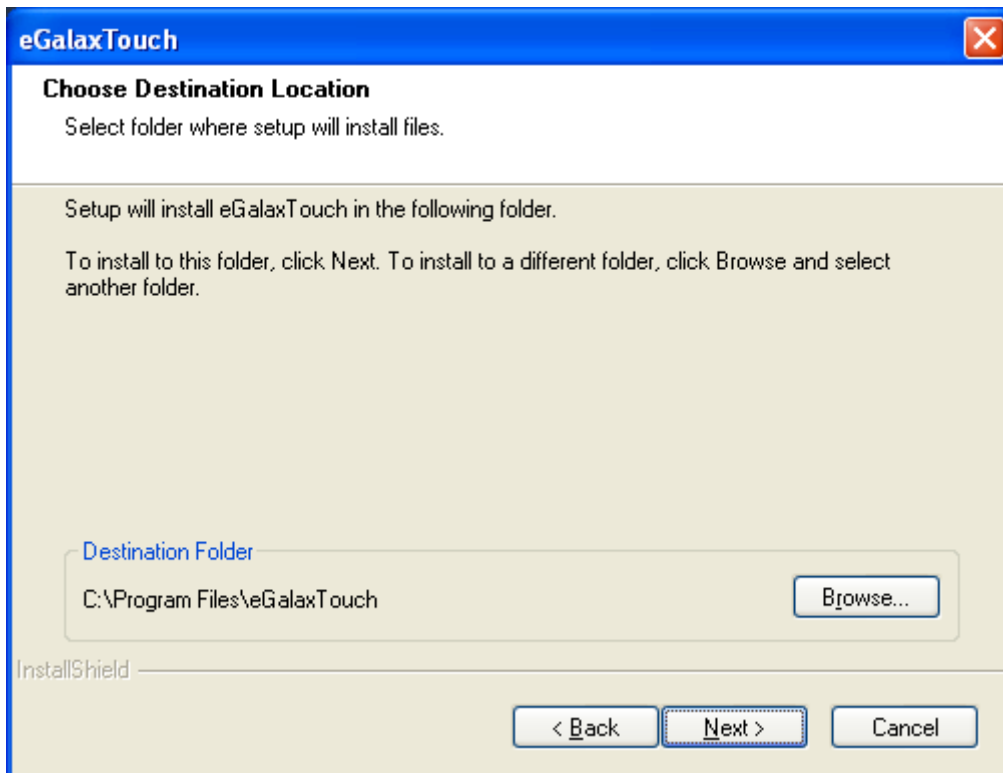

Step 9. Click **Next**.

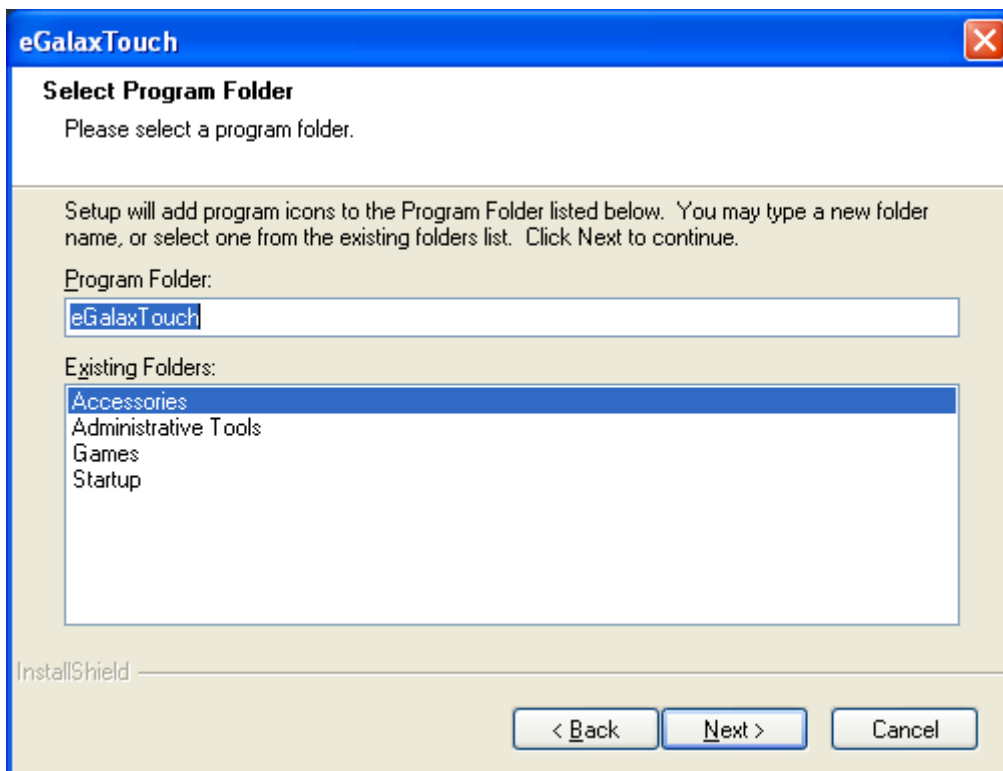

Step 10. Click **Create a eGalaxTouch Utility shortcut on desktop.** Click **Next.**

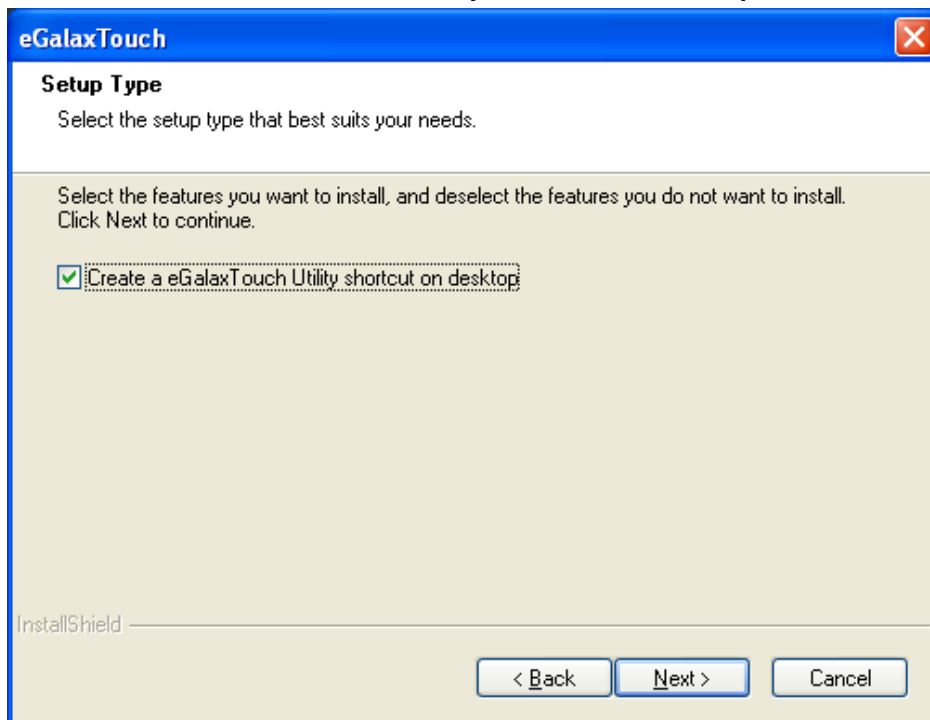

Step 11. Wait for installation.

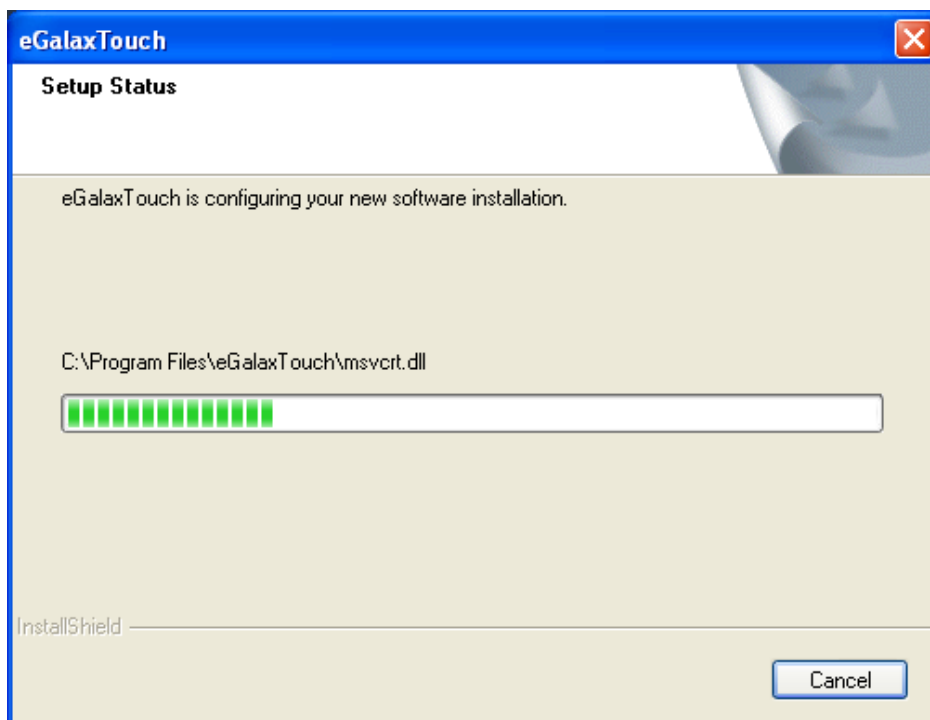

Step 12. Click **Yes** to do 4 point calibration.

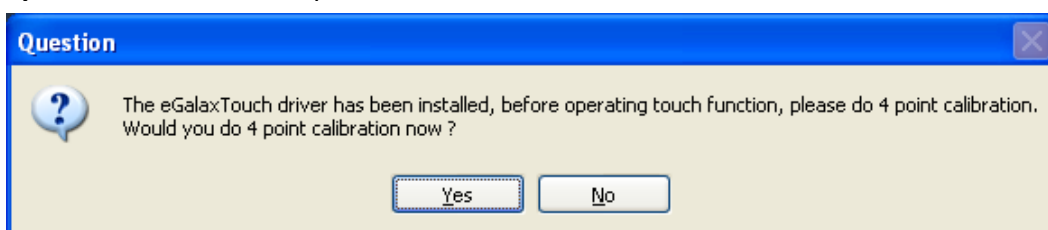

3.2 Software Functions

3.2.1 Software Functions(Resistive Touch)

Upon rebooting, the computer automatically finds the new 6000 controller board. The touch screen is connected but not calibrated. Follow the procedures below to carry out calibration.

1. After installation, click the PenMount Monitor icon “PM” in the menu bar.
2. When the PenMount Control Panel appears, select a device to “Calibrate.”

PenMount Control Panel(Resistive Touch)

The functions of the PenMount Control Panel are **Device**, **Multiple Monitors**, **Tools** and **About**, which are explained in the following sections.

Device

In this window, you can find out that how many devices be detected on your system.

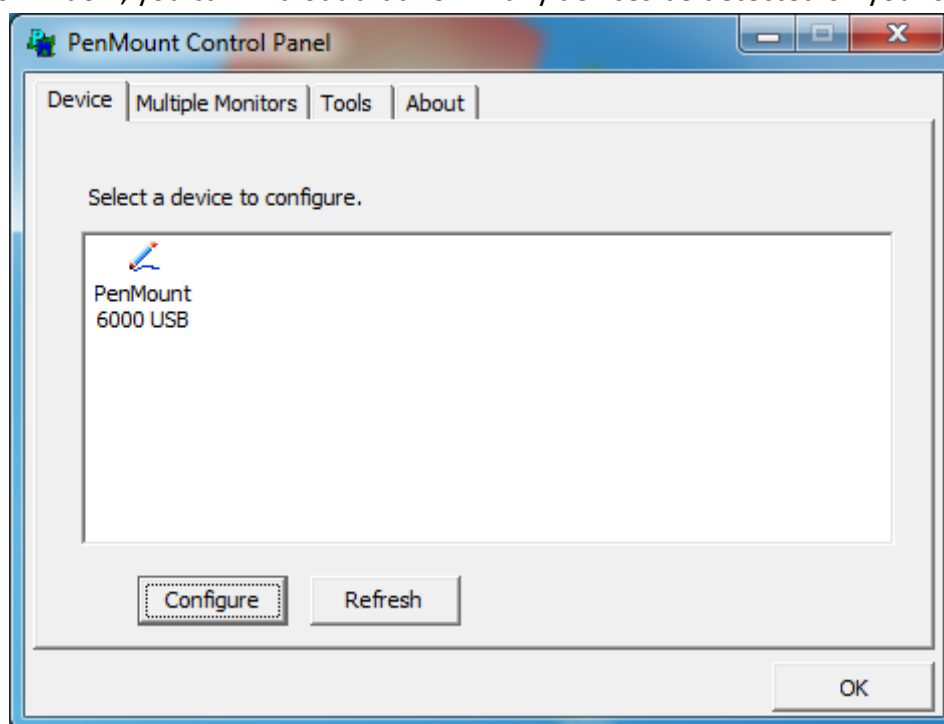

Calibrate

This function offers two ways to calibrate your touch screen. ‘Standard Calibration’ adjusts most touch screens. ‘Advanced Calibration’ adjusts aging touch screens.

Standard Calibration	Click this button and arrows appear pointing to red squares. Use your finger or stylus to touch the red squares in sequence. After the fifth red point calibration is complete. To skip, press 'ESC'.
Advanced Calibration	Advanced Calibration uses 4, 9, 16 or 25 points to effectively calibrate touch panel linearity of aged touch screens. Click this button and touch the red squares in sequence with a stylus. To skip, press ESC'.

Step 1. Please select a device then click “Configure”. You can also double click the device too.

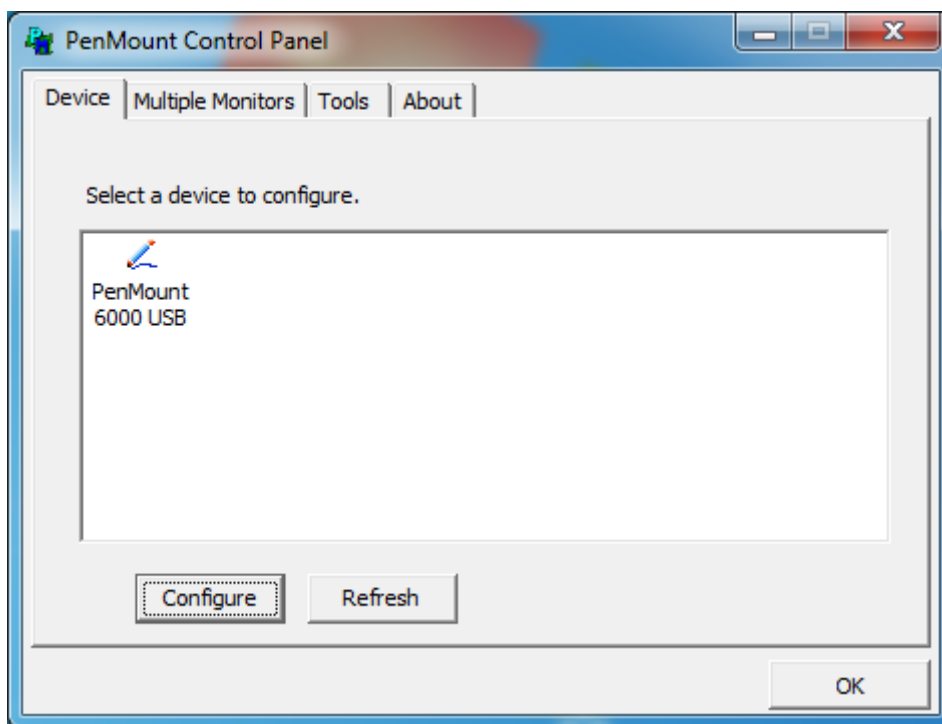

Step 2. Click “Standard Calibration” to start calibration procedure

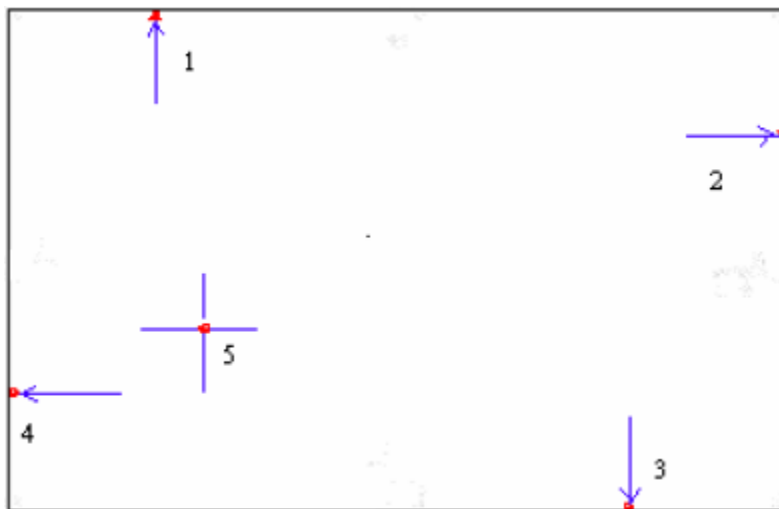
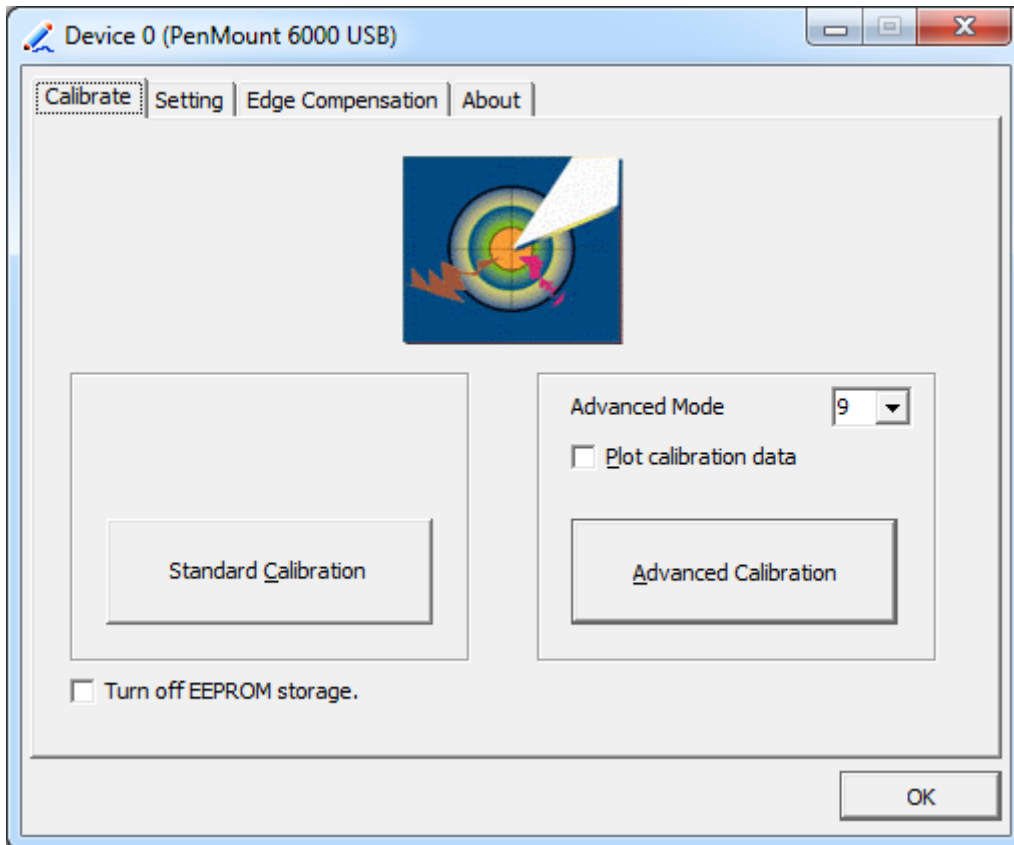

NOTE: The older the touch screen, the more Advanced Mode calibration points you need for an accurate calibration. Use a stylus during Advanced Calibration for greater accuracy. Please follow the step as below:

Step 3. Select **Device** to calibrate, then you can start to do **Advanced Calibration**.

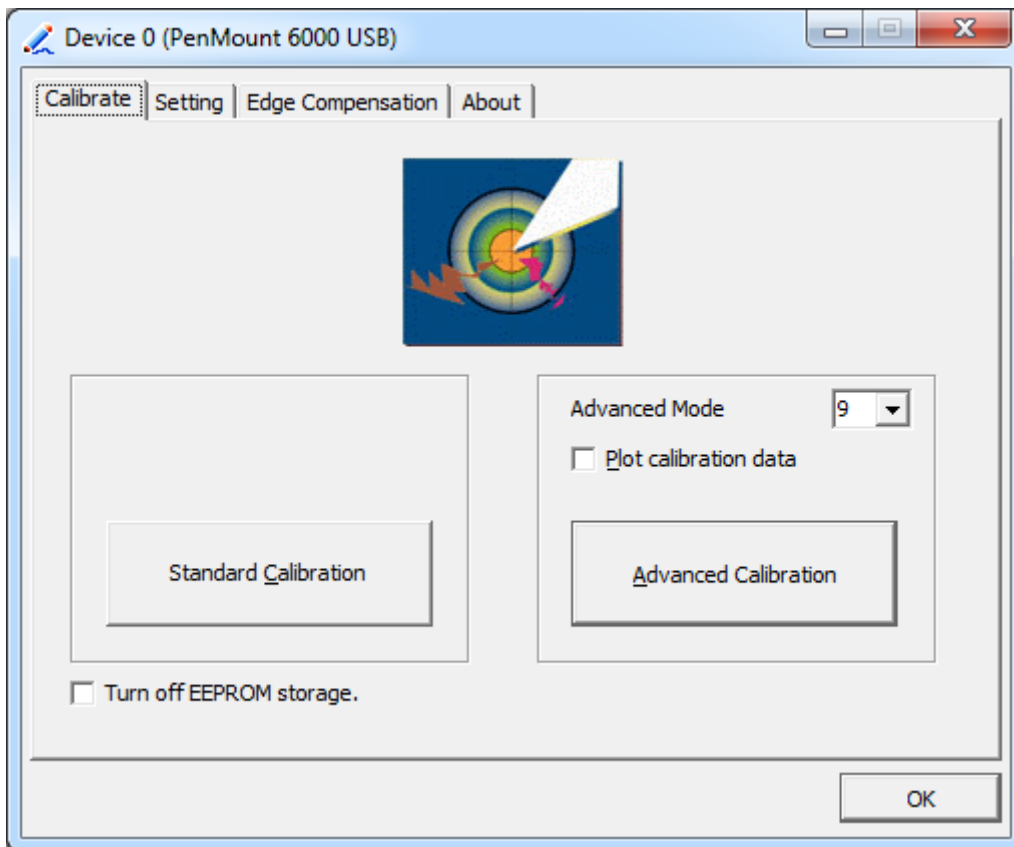

NOTE: Recommend to use a stylus during Advanced Calibration for greater accuracy.



Plot Calibration Data	Check this function and a touch panel linearity comparison graph appears when you have finished Advanced Calibration. The blue lines show linearity before calibration and black lines show linearity after calibration.
Turn off EEPROM storage	The function disable for calibration data to write in Controller. The default setting is Enable.

Setting

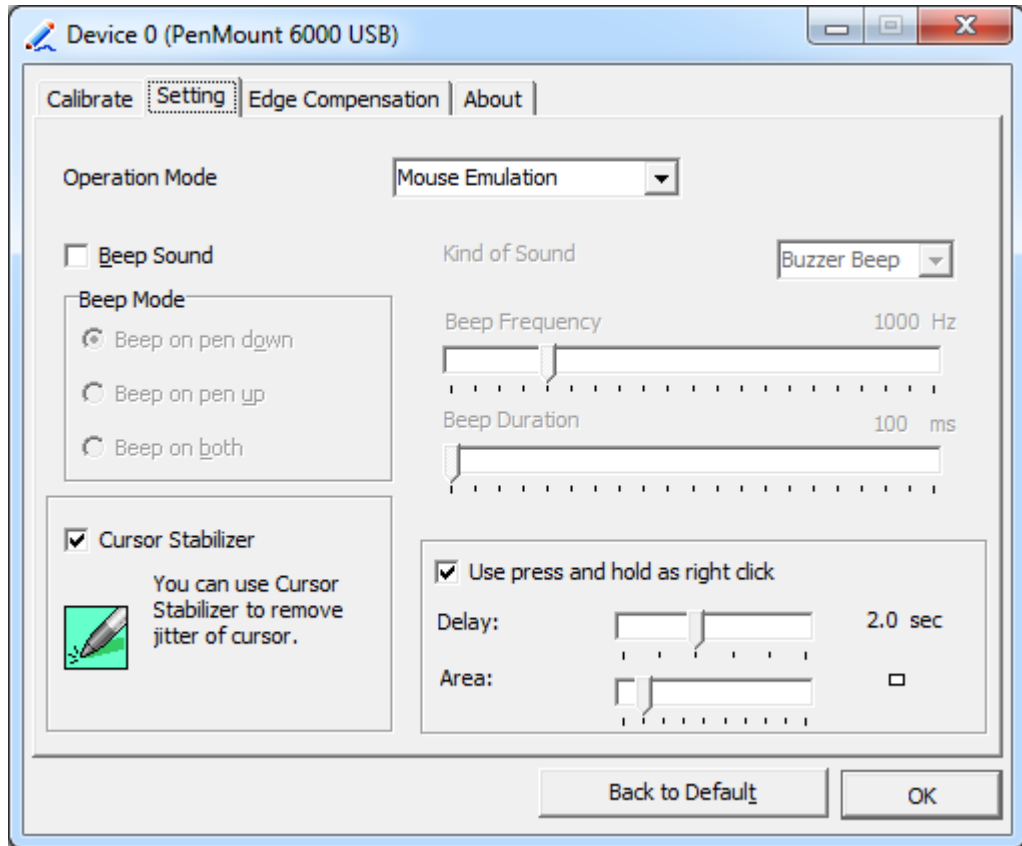

Touch Mode	<p>This mode enables and disables the mouse’s ability to drag on-screen icons – useful for configuring POS terminals.</p> <p>Mouse Emulation – Select this mode and the mouse functions as normal and allows dragging of icons.</p> <p>Click on Touch – Select this mode and mouse only provides a click function, and dragging is disables.</p>
Beep Sound	<p>Enable Beep Sound – turns beep function on and off</p> <p>Beep on Pen Down – beep occurs when pen comes down</p> <p>Beep on Pen Up – beep occurs when pen is lifted up</p> <p>Beep on both – beep occurs when comes down and lifted up</p> <p>Beep Frequency – modifies sound frequency</p> <p>Beep Duration – modifies sound duration</p>
Cursor Stabilizer	<p>Enable the function support to prevent cursor shake.</p>
Use press and hold as right click	<p>You can set the time out and area for you need.</p>

Edge Compensation

You can use Edge Compensation to calibrate more subtly.

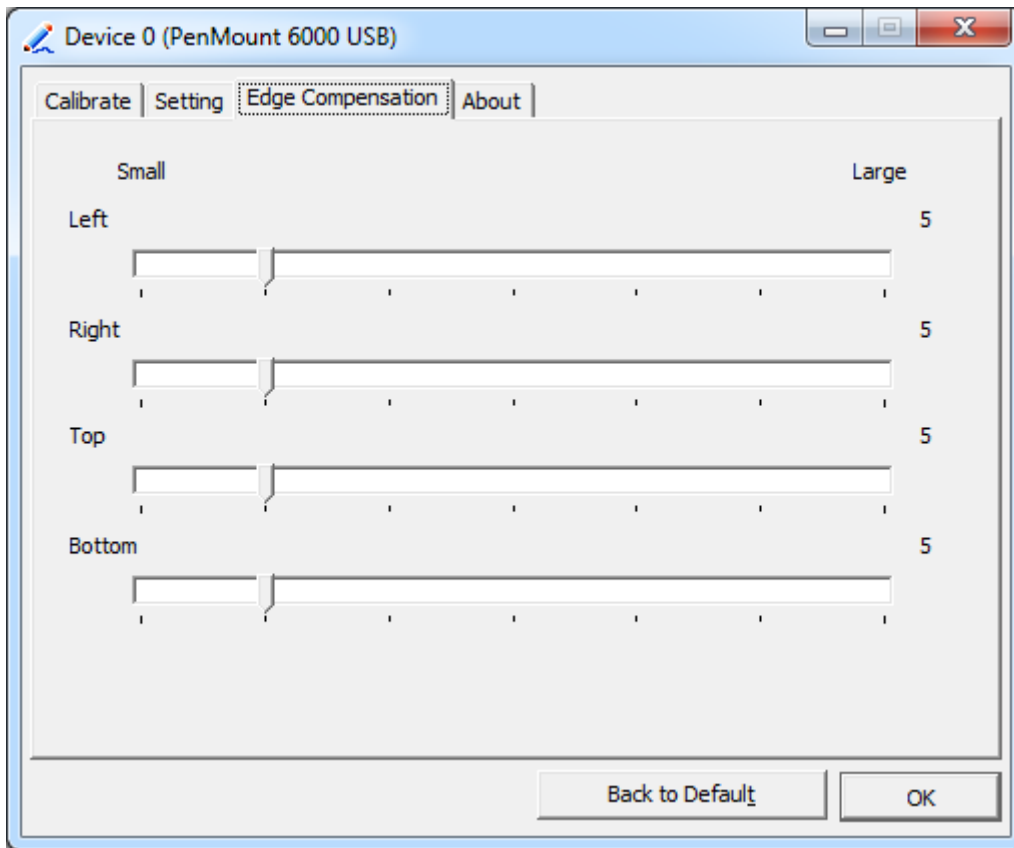

About

This panel displays information about the PenMount controller and driver version.

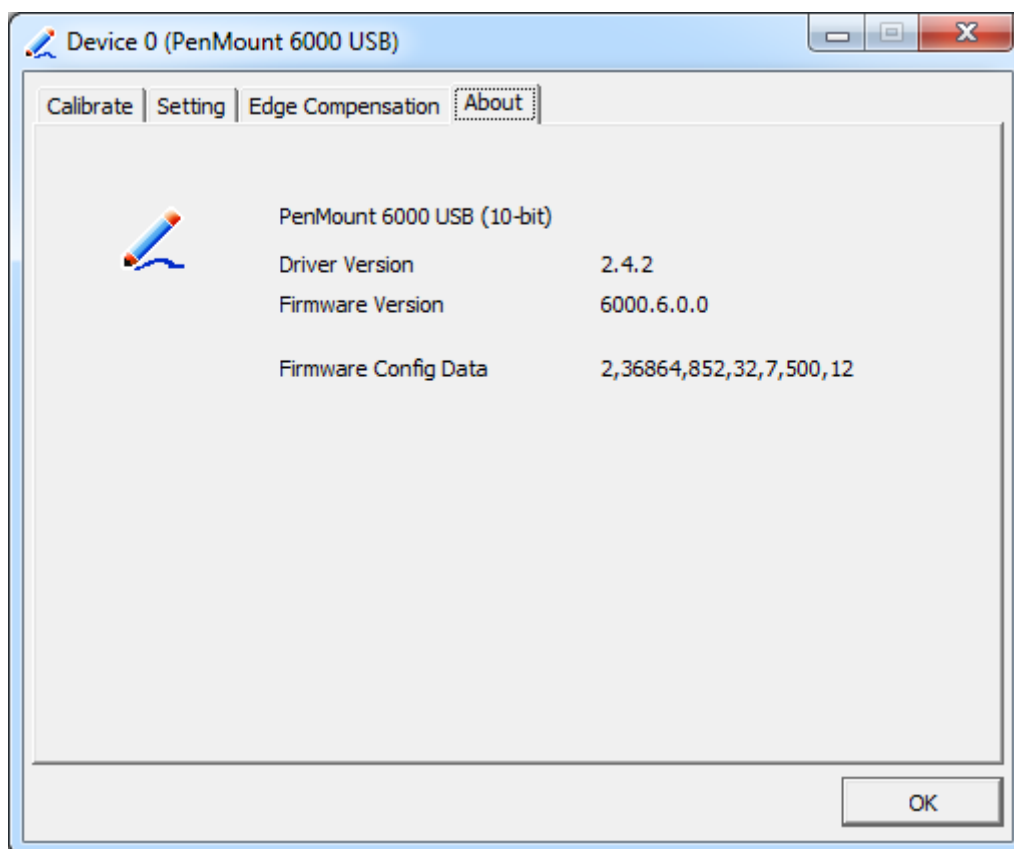

Multiple Monitors

Multiple Monitors support from two to six touch screen displays for one system. The PenMount drivers for Windows 7 support Multiple Monitors. This function supports from two to six touch screen displays for one system. Each monitor requires its own PenMount touch screen control board, either installed inside the display or in a central unit. The PenMount control boards must be connected to the computer COM ports via the USB interface. Driver installation procedures are the same as for a single monitor. Multiple Monitors support the following modes:

- Windows Extends Monitor Function
- Matrox DualHead Multi-Screen Function
- nVidia nView Function

NOTE: The Multiple Monitor function is for use with multiple displays only. Do not use this function if you have only one touch screen display. Please note once you turn on this function the rotating function is disabled.

Enable the multiple display function as follows:

1. Check the **Enable Multiple Monitor Support** box; then click **Map Touch Screens**

to assign touch controllers to displays.

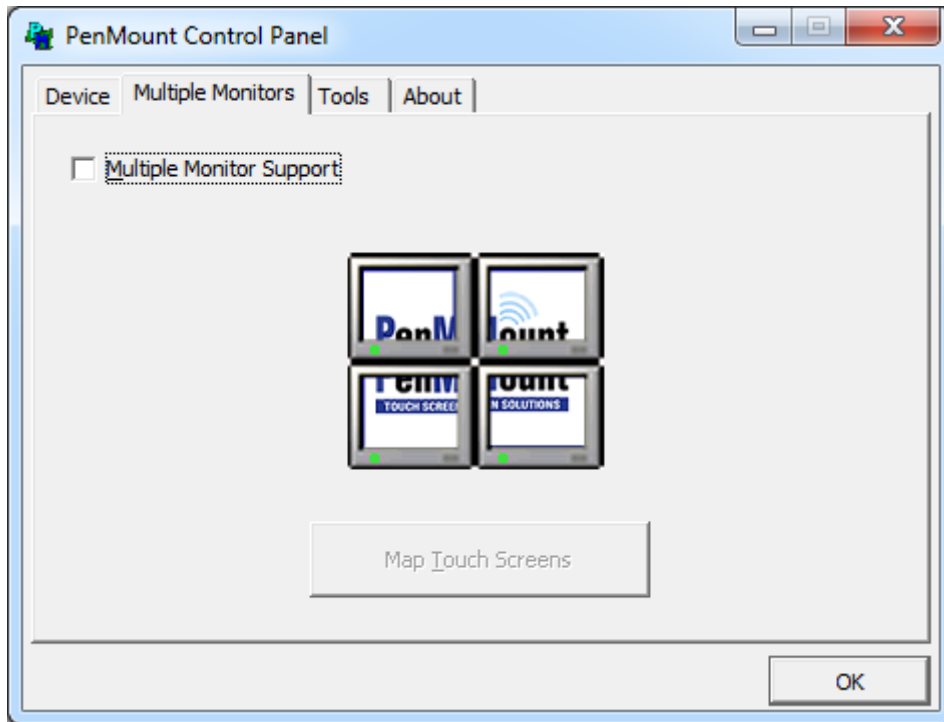

2. When the mapping screen message appears, click **OK**.
3. Touch each screen as it displays “Please touch this monitor”. Following this sequence and touching each screen is called **mapping the touch screens**.



4. Touching all screens completes the mapping and the desktop reappears on the monitors.
5. Select a display and execute the “Calibration” function. A message to start calibration appears. Click **OK**.

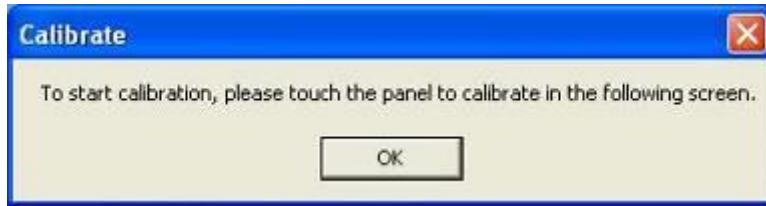

6. "Touch this screen to start its calibration" appears on one of the screens. Touch the screen.
7. "Touch the red square" messages appear. Touch the red squares in sequence.
8. Continue calibration for each monitor by clicking **Standard Calibration** and touching the red squares.

NOTES:

1. If you use a single VGA output for multiple monitors, please do not use the **Multiple Monitor** function. Just follow the regular procedure for calibration on each of your desktop monitors.
2. The Rotating function is disabled if you use the Multiple Monitor function.
3. If you change the resolution of display or screen address, you have to redo **Map Touch Screens**, so the system understands where the displays are.

About

This panel displays information about the PenMount controller and this driver version.

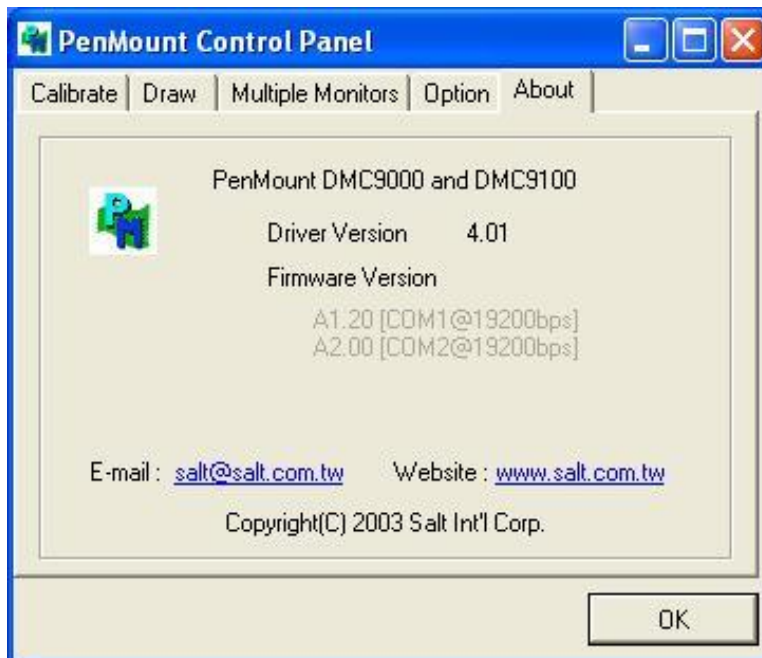

PenMount Monitor Menu Icon

The PenMount monitor icon (PM) appears in the menu bar of Windows 7 system when you turn on PenMount Monitor in PenMount Utilities.



PenMount Monitor has the following function



Control Panel	Open Control Panel Windows
Beep	Setting Beep function for each device
Right Button	When you select this function, a mouse icon appears in the right-bottom of the screen. Click this icon to switch between Right and Left Button functions. 
Exit	Exits the PenMount Monitor function.

Configuring the Rotate Function

1. Install the rotation software package.
2. Choose the rotate function (0°, 90°, 180°, 270°) in the 3rd party software. The calibration screen appears automatically. Touch this point and rotation is mapped.

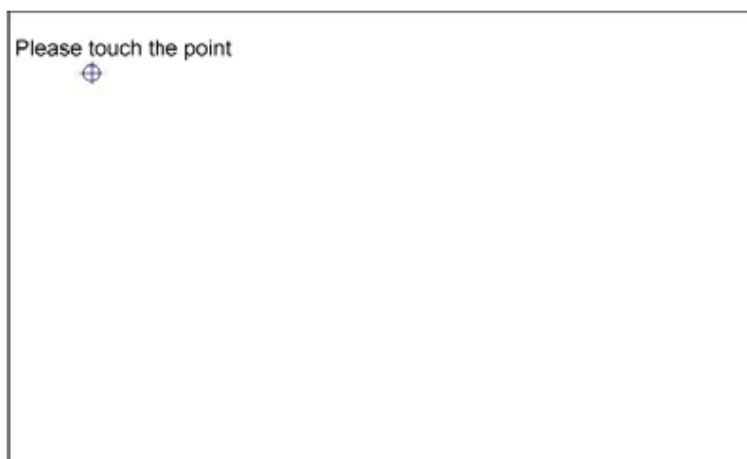

NOTE: The Rotate function is disabled if you use Monitor Mapping

3.2.2 Software Functions(Projected Capacitive)

General

In this window, you can see there is USB Controller. Click **OK** to continue.

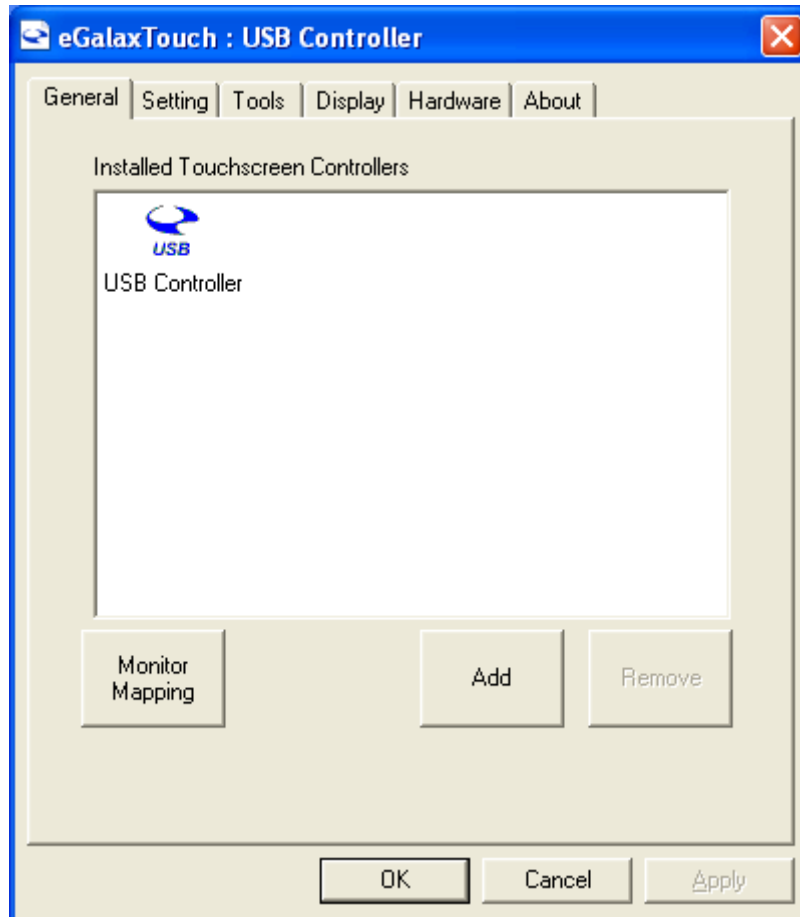

Monitor Mapping

to adjust touch panel

Add

to search for device

Setting

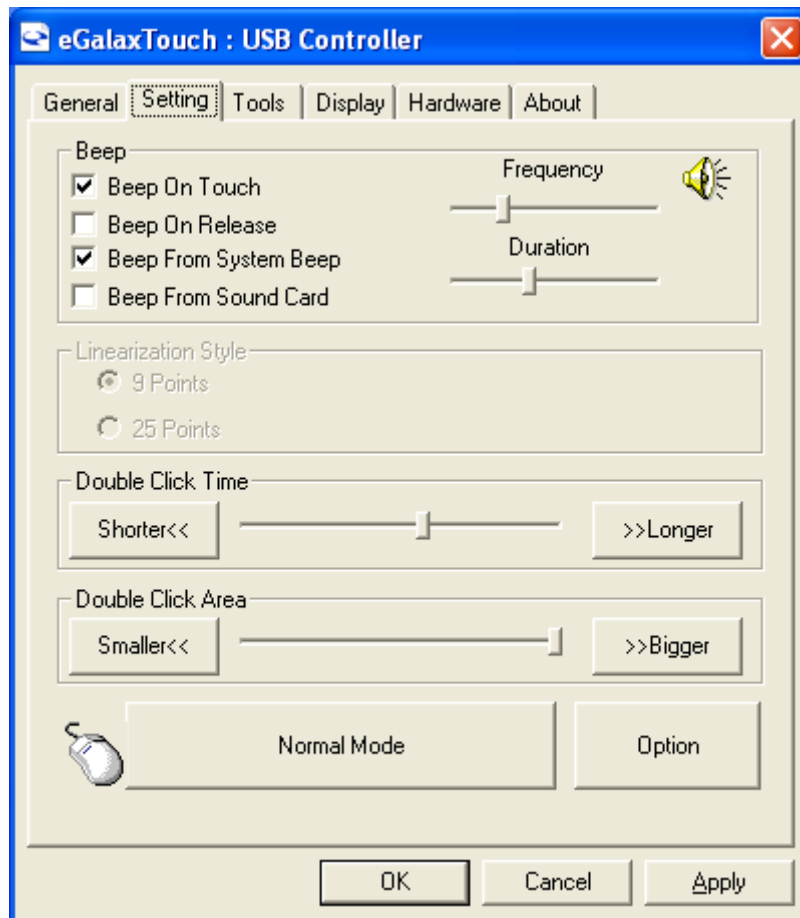

Beep

- Beep On Touch
- Beep On Release
- Beep From System Beep
- Beep From Sound Card

Linearization Style

- 9 points
- 25 points

Double Click Time

- Shorter
- Longer

Double Click Area

- Smaller
- Bigger

Normal mode

- Simulate the mouse mode

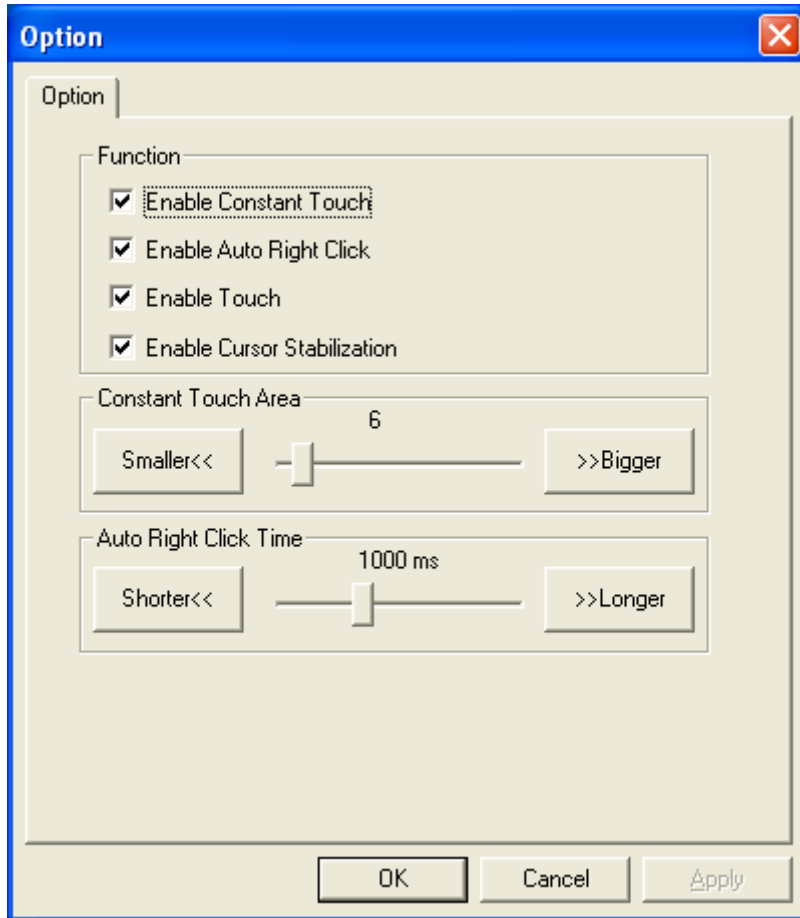

Option

Function

Enable Constant Touch

Enable Auto Right Click

Enable Touch

Enable Cursor Stabilization

Constant Touch Area

Auto Right Click Time

Tools

Click **OK** to continue the settings.

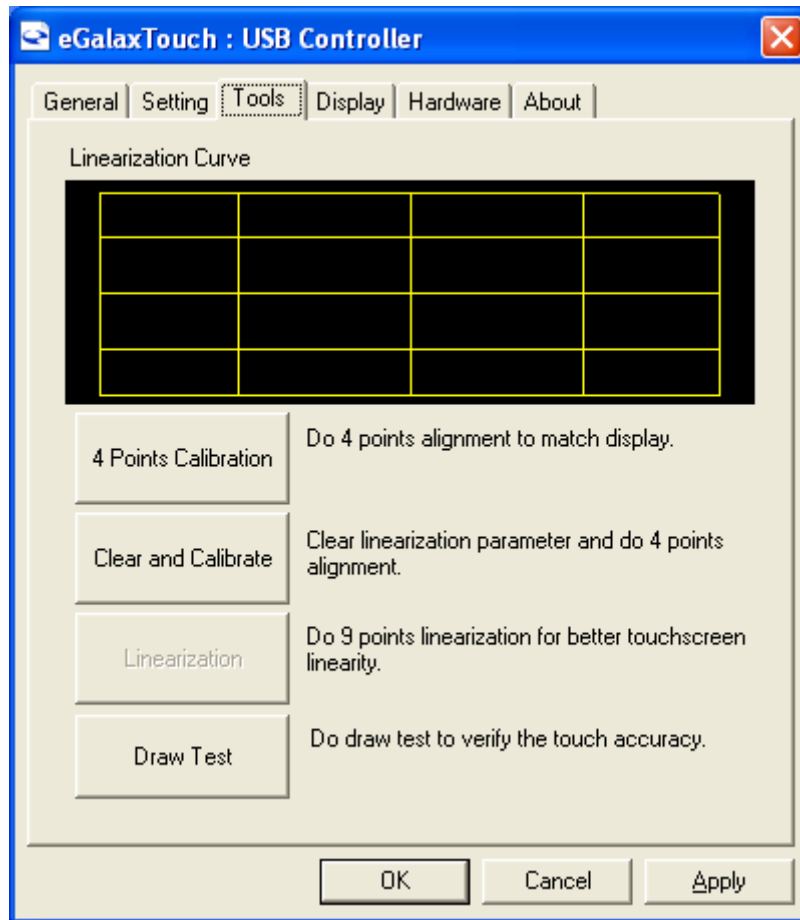

4 Points Calibration

Do 4 points alignment to match display.

Clear and Calibrate

Clear linearization parameter and do 4 points alignment.

Linearization

Do 9 points linearization for better touchscreen linearity.

Draw Test

Do draw test to verify the touch accuracy.

Display

In this window, it shows the mode of display.

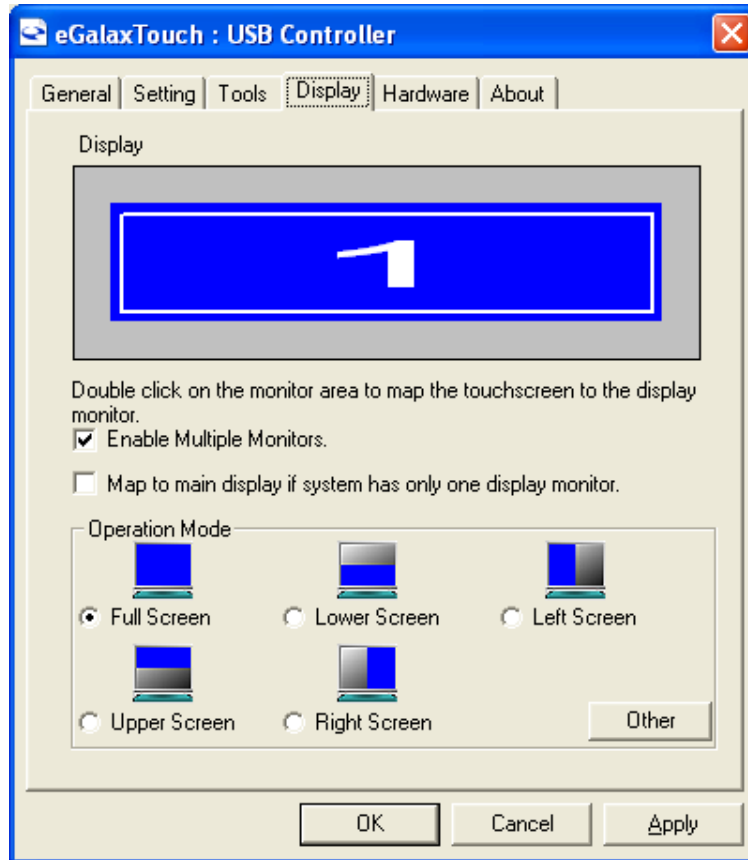

Enable Multiple Monitors.

Map to main display if system has only one display monitor

Full Screen

Lower Screen

Left Screen

Upper Screen

Right Screen

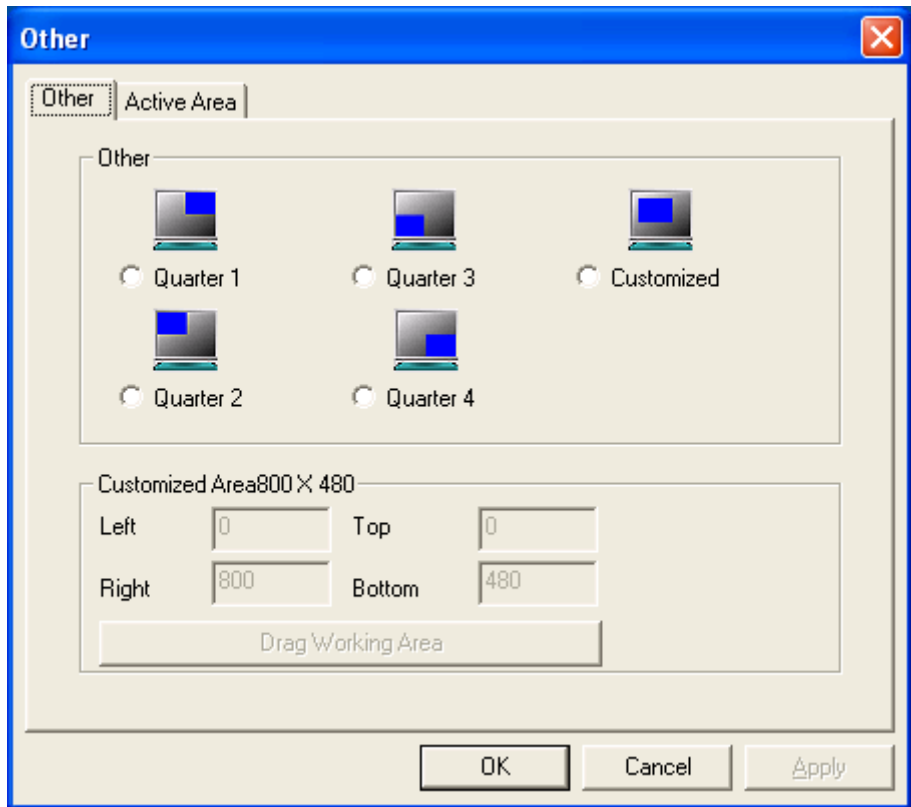

Other

Other mode of display. Quarter1~4 and Customized area.

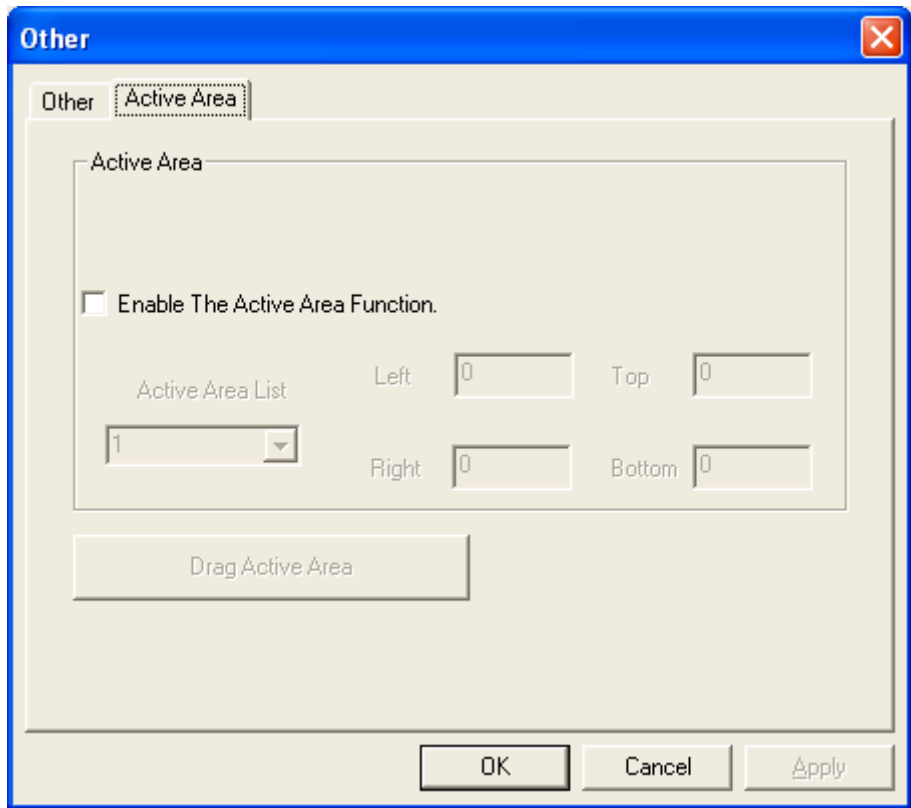

Active Area

Drag active area to enable Active Area Function.

Hardware

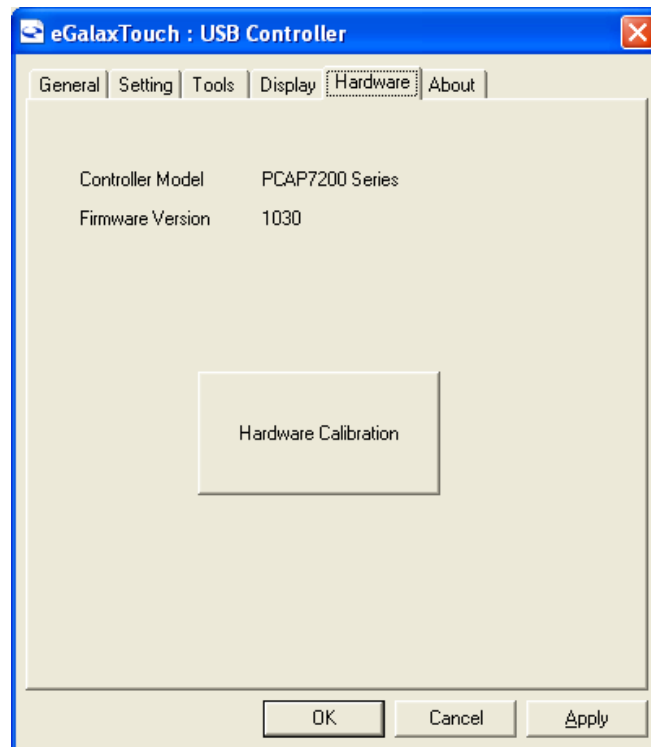

Saturn Hardware Configuration

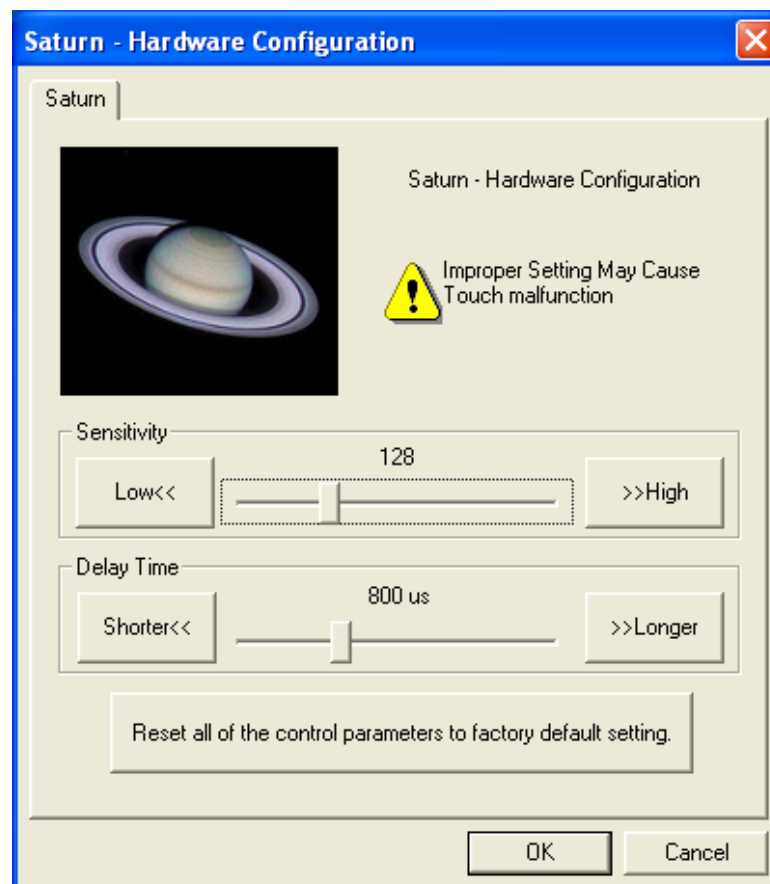

About

To display information about eGalaxTouch and its version.

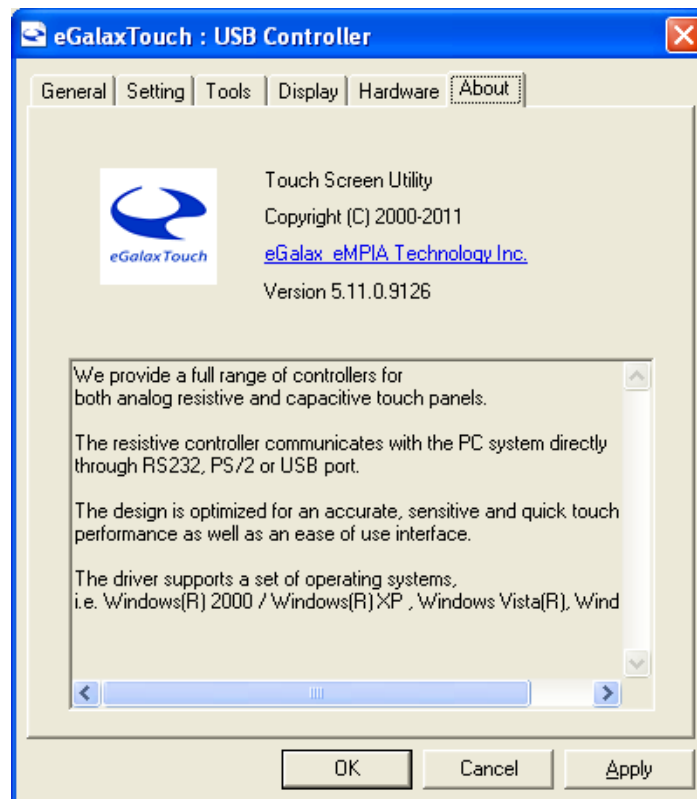

Appendix A: Board Descriptions & Specifications

Descriptions

Model	Function Description
TB-6028	AD board, VGA/DVI-D input, LVDS output
TB-6028TU	AD board, VGA/DVI-D input, LVDS output, USB/Touch controller
TB-6028RTS	AD board, VGA/DVI-D input, LVDS output, RS-232/Touch controller

Specifications

Specifications	
Board Size	170 x 113 x 1.6 mm
Chipset	Realtek RTD2533VH PenMount 6000
Input	1 x VGA input Port 1 x DB15 connector (Default) 1 x 1*12Pin Wafer (option) 1 x DVI-D input 1 x RS232 input port, DB9 connector (option) 1 x USB 2.0 input port, Single USB connector (option) 1 x Line in port, Phone Jack (option) 1 x 3-pin power input connector (Wide range DC+9V~36V) 1 x OSD function support 1 x Touch controller(option)
Output	1 x 24bit Dual Channel LVDS output interface 1 x Audio Power Amplifier (Line out, option) 1 x USB 2.0 Port (option)
Resolution	Up to 1920 x1200 for LVDS
Power input	DC9V-36V
Temperature	Operating: -20°C to 70°C Storage: -40°C to 85°C
Humidity	0% - 80%, non-condensing, operating
EMI/EMS	Meet CE/FCC class A

Board Dimensions

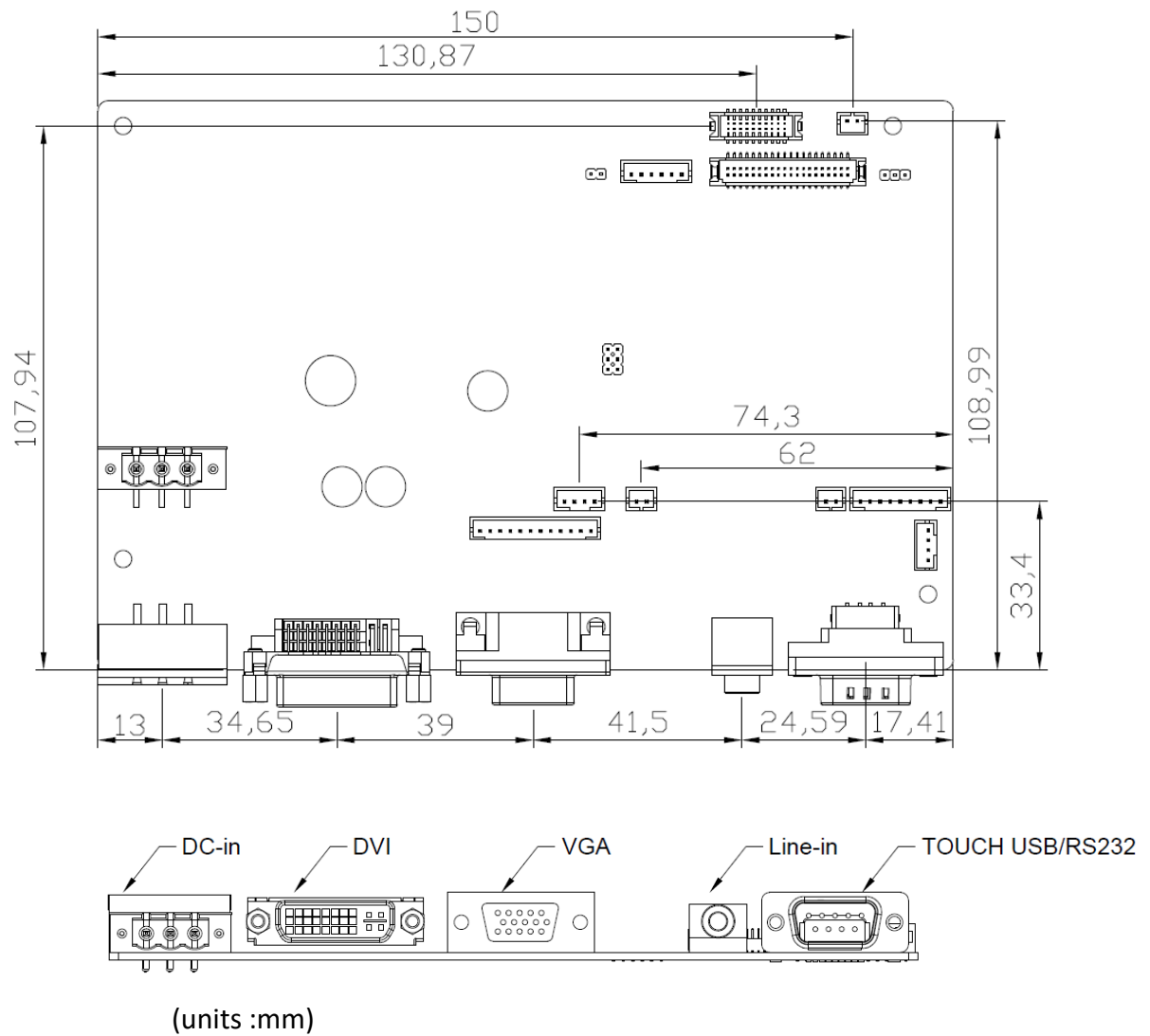

Figure A: Dimensions of TB-6028

Appendix B: Panel Mounting and VESA Mounting

The ARCDIS-1XX (P/G)(H) series is designed to be panel-mounted and VESA mounted as shown in Picture. Just carefully place the unit through the hole and tighten the given screws from the rear to secure the mounting.

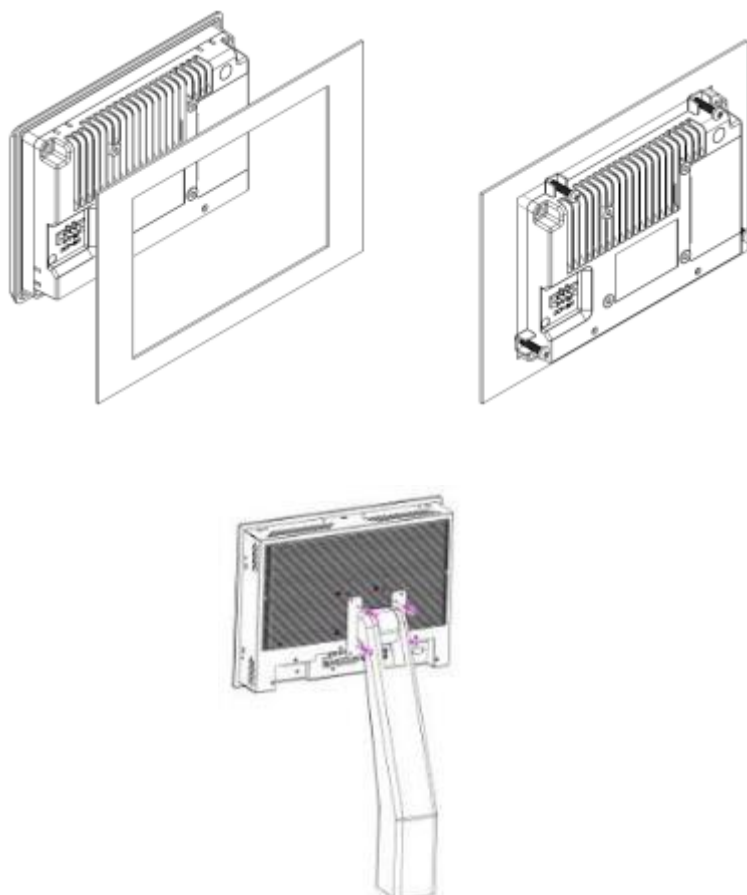

Figure B: Panel mounting and VESA mounting



Attention

*Notice :

Tighten the mounting clip screws by hand until the gasket seal contacts the mounting surface uniformly.

Tighten the mounting clips screws to a torque of 8 ~ 10 kgf-cm by using the specified sequence, making sure not to overtighten.

*Tighten the mounting clips to the specified torque to provide a proper seal and to prevent damage to the product. Aplex assumes no responsibility for water or chemical damage to the product or other equipment within the enclosure due to improper installation.