

ECM-3455J

Intel® J3455 SoC
3.5 Inch Single Board Computer (SBC)

User's Manual

Edition 1.01 – Nov, 2021

FCC Statement



THIS DEVICE SUPPORTS PART 15 FCC RULES. OPERATION IS SUBJECT TO THE FOLLOWING TWO CONDITIONS:

(1) THIS DEVICE MAY NOT CAUSE HARMFUL INTERFERENCE.

(2) THIS DEVICE MUST ACCEPT ANY INTERFERENCE RECEIVED INCLUDING INTERFERENCE THAT MAY CAUSE UNDESIRED OPERATION.

THIS EQUIPMENT HAS BEEN TESTED AND FOUND TO COMPLY WITH THE LIMITS FOR A CLASS "A" DIGITAL DEVICE, PURSUANT TO PART 15 OF THE FCC RULES.

THESE LIMITS ARE DESIGNED TO PROVIDE REASONABLE PROTECTION AGAINST HARMFUL INTERFERENCE WHEN THE EQUIPMENT IS OPERATED IN A COMMERCIAL ENVIRONMENT. THIS EQUIPMENT GENERATES, USES, AND CAN RADIATE RADIO FREQUENCY ENERGY AND, IF NOT INSTALLED AND USED IN ACCORDANCE WITH THE INSTRUCTION MANUAL, MAY CAUSE HARMFUL INTERFERENCE TO RADIO COMMUNICATIONS.

OPERATION OF THIS EQUIPMENT IN A RESIDENTIAL AREA IS LIKELY TO CAUSE HARMFUL INTERFERENCE IN WHICH CASE THE USER WILL BE REQUIRED TO CORRECT THE INTERFERENCE AT HIS OWN EXPENSE.

Notice

This guide is designed for experienced users to setup the system within the shortest time. For detailed information, please always refer to the electronic user's manual.

Copyright Notice

Copyright © 2021 BCM Advanced Research, ALL RIGHTS RESERVED.

No part of this document may be reproduced, copied, translated, or transmitted in any form or by any means, electronic or mechanical, for any purpose, without the prior written permission of the original manufacturer.

Trademark Acknowledgement

Brand and product names are trademarks or registered trademarks of their respective owners.

Disclaimer

BCM Advanced Research reserves the right to make changes, without notice, to any product, including circuits and/or software described or contained in this manual in order to improve design and/or performance. BCM Advanced Research assumes no responsibility or liability for the use of the described product(s), conveys no license or title under any patent, copyright, or masks work rights to these products, and makes no representations or warranties that these products are free from patent, copyright, or mask work right infringement, unless otherwise specified. Applications that are described in this manual are for illustration purposes only. BCM Advanced Research makes no representation or warranty that such application will be suitable for the specified use without further testing or modification.

Life Support Policy

BCM Advanced Research PRODUCTS ARE NOT FOR USE AS CRITICAL COMPONENTS IN LIFE SUPPORT DEVICES OR SYSTEMS WITHOUT THE PRIOR WRITTEN APPROVAL OF BCM Advanced Research.

As used herein:

1. Life support devices or systems are devices or systems which, (a) are intended for surgical implant into body, or (b) support or sustain life and whose failure to perform, when properly used in accordance with instructions for use provided in the labeling, can be reasonably expected to result in significant injury to the user.
2. A critical component is any component of a life support device or system whose failure to perform can be reasonably expected to cause the failure of the life support device or system, or to affect its safety or effectiveness.

A Message to the Customer

BCM Customer Services

Each and every BCM product is built to the most exacting specifications to ensure reliable performance in the harsh and demanding conditions typical of industrial environments. Whether your new BCM device is destined for the laboratory or the factory floor, you can be assured that your product will provide the reliability and ease of operation for which the name BCM has come to be known.

Your satisfaction is our primary concern. Here is a guide to BCM customer services. To ensure you get the full benefit of our services, please follow the instructions below carefully.

Technical Support

We want you to get the maximum performance from your products. So if you run into technical difficulties, we are here to help. For the most frequently asked questions, you can easily find answers in your product documentation. These answers are normally a lot more detailed than the ones we can give over the phone. So please consult the user's manual first.

To receive the latest version of the user's manual; please visit our Web site at:

<http://www.bcmcom.com>.

If you still cannot find the answer, gather all the information or questions that apply to your problem, and with the product close at hand, call your dealer. Our dealers are well trained and ready to give you the support you need to get the most from your BCM products. In fact, most problems reported are minor and are able to be easily solved over the phone.

In addition, free technical support is available from BCM engineers every business day. We are always ready to give advice on application requirements or specific information on the installation and operation of any of our products. Please do not hesitate to call or e-mail us.

BCM Advanced Research

11 Chrysler,
Irvine, California, 92618
USA

Tel : +1-949-470-1888

Fax : +1-949-470-0971

<http://www.bcmcom.com>

E-mail: support@bcmcom.com

Product Warranty

BCM warrants to you, the original purchaser, that each of its products will be free from defects in materials and workmanship for two years from the date of purchase.

This warranty does not apply to any products which have been repaired or altered by persons other than repair personnel authorized by BCM, or which have been subject to misuse, abuse, accident or improper installation. BCM assumes no liability under the terms of this warranty as a consequence of such events. Because of BCM high quality-control standards and rigorous testing, most of our customers never need to use our repair service. If any of BCM products is defective, it will be repaired or replaced at no charge during the warranty period. For out-of-warranty repairs, you will be billed according to the cost of replacement materials, service time, and freight. Please consult your dealer for more details. If you think you have a defective product, follow these steps:

1. Collect all the information about the problem encountered. (For example, CPU type and speed, BCM products model name, hardware & BIOS revision number, other hardware and software used, etc.) Note anything abnormal and list any on-screen messages you get when the problem occurs.
2. Call your dealer and describe the problem. Please have your manual, product, and any helpful information available.
3. If your product is diagnosed as defective, obtain an RMA (return material authorization) number from your dealer. This allows us to process your good return more quickly.
4. Carefully pack the defective product, a complete Repair and Replacement Order Card and a photocopy proof of purchase date (such as your sales receipt) in a shippable container. A product returned without proof of the purchase date is not eligible for warranty service.

Write the RMA number visibly on the outside of the package and ship it prepaid to your dealer.

Manual Objectives

This manual describes in detail the BCM ECM-3455J Main board.

We strongly recommend that you study this manual carefully before attempting to interface with this mainboard or change the standard configurations. Whilst all the necessary information is available in this manual we would recommend that unless you are confident, you contact your supplier for guidance.

Please be aware that it is possible to create configurations within the CMOS RAM that make booting impossible. If this should happen, clear the CMOS settings, (see the description of the Jumper Settings for details).

If you have any suggestions or find any errors concerning this manual and want to inform us of these, please contact our Customer Service department with the relevant details.

Safety Precautions

Warning!



Always completely disconnect the power cord from your chassis whenever you work with the hardware. Do not make connections while the power is on. Sensitive electronic components can be damaged by sudden power surges. Only experienced electronics personnel should open the PC chassis.

Caution!



Always ground yourself to remove any static charge before touching the mainboard. Modern electronic devices are very sensitive to static electric charges. As a safety precaution, use a grounding wrist strap at all times. Place all electronic components in a static-dissipative surface or static-shielded bag when they are not in the chassis.

Document Amendment History

Revision	Date	Comment
1 st (1.00)	Aug, 2021	Initial Release
2 nd (1.01)	Nov, 2021	Updated Dual Role related information

Contents

Chapter 1: System Setup	14
1.1 Welcome!.....	14
1.2 Packing Contents	14
1.3 Before you proceed	15
1.4 Mainboard Overview.....	16
1.4.1 Mounting Holes.....	16
1.4.2 Onboard LEDs.....	17
1.4.3 Mainboard Layout (Top View/ Bottom View).....	18
1.4.4 Layout Content List.....	19
1.4.4.1 Slots.....	19
1.4.4.2 Internal Jumpers.....	19
1.4.4.3 Internal Headers	20
1.4.4.4 Back Panel Connectors	21
1.5 System Memroy.....	22
1.5.1 Overview.....	22
1.5.2 Memory Configurations	22
1.5.3 Installing the DDR4 SODIMM.....	23
1.5.4 Removing the DDR4 SODIMM.....	24
1.6 Back Panel (Rear I/O Ports).....	25
1.6.1 Back Panel Connectors	25
1.7 Connectors/Headers.....	27
1.7.1 4-Pins Power Connector: DCIN_PWR	27
1.7.2 Front Panel Connector: F_Panel.....	28
1.7.3 System Fan Connector: SYS_FAN	28
1.7.4 Serial ATA 3.0 Connector: SATA3	29
1.7.5 SATA Power Connector: SATA_PWR	29
1.7.6 mSATA/ Mini-PCIE Connector: MSATA_MPCIE	30
1.7.7 uSIM Card Slot: U_SIM	30
1.7.8 M.2 Socket: M2_E (E-Key, Supportrs Wifi Cards in 2230 Only).....	31
1.7.9 Front USB2.0 Headers: F_USB1, F_USB2.....	31
1.7.10 COM Ports: COMA, COMB	32
1.7.11 LVDS Panel Connector: LVDS.....	32
1.7.12 LVDS Panel Backlight Connector: BACKLIGHT	33
1.7.13 I2C Header: I2C.....	33

1.7.14	SPI Header: SPI	34
1.7.15	SMBUS Header: SMBUS	34
1.7.16	Volume Control Header: VOLUME_CONTROL	35
1.7.17	LPT/ GPIO Header: LPT_GPIO	35
1.7.18	LPC Header: LPC	36
1.7.19	Speaker Header: SPEAKER	36
1.7.20	Chassis Intrusion Header: CI	37
1.8	Jumpers	38
1.8.1	ATX/AT Mode Select	38
1.8.2	LVDS Backlight Enable Voltage Select: BL_EN	38
1.8.3	COM Port +12V/ +5V/ Ring-In Select: COMA_PW, COMB_PW	39
1.8.4	GPIO High/ Low Select: GPIO_SET	39
1.8.5	LPT/ GPIO Selection for header "LPT_GPIO": LPT_SEL	40
1.8.6	GPIO Power Select: GPIO_PWRSEL	40
1.8.7	Clear CMOS Header: CLR_CMOS	41
Chapter 2: Starting Up the System		42
2.1	Starting Up Your System	42
Chapter 3: BIOS Setup		44
3.1	BIOS Falsh Related Procedure	44
3.2	Introducing BIOS	44
3.3	Entering BIOS Setup Menu	45
3.4	Getting Help	46
3.5	BIOS Menu Screen	47
3.6	Main Menu	48
3.6.1	System Information	48
3.6.2	System Date	48
3.6.3	System Time	48
3.7	Advanced Menu	49
3.7.1	AC Power Loss	49
3.7.2	Watch Dog	50
3.7.3	Onboard LAN Controller	50
3.7.4	Onboard LAN Controller#2	50
3.7.5	Soft-Off by PWR-BTTN	50
3.7.6	ErP	50
3.7.7	Reset Case Open Status	50
3.7.8	LVDS Support	50

3.7.9	XDCI Support	50
3.7.10	Realtek PCIe GBE Family Controller (MAC Address).....	50
3.7.11	Realtek PCIe GBE Family Controller (MAC Address).....	50
3.7.12	Trusted Computing	51
3.7.13	NCT6126D Super IO Configuration.....	52
3.7.13.1	Serial Port 1 Configuration	52
3.7.13.2	Serial Port 2 Configuration	52
3.7.13.3	Parallel Port Configuration	52
3.7.14	Hardware Monitor	53
3.7.14.1	Smart Fan Function	54
3.7.14.1.1	System Fan Mode: Manual Mode	54
3.7.14.1.2	System Fan Mode: Thermal Cruise.....	55
3.7.15	CPU Configuration.....	57
3.7.15.1	Socket 0 CPU Information	57
3.7.15.2	CPU Power Management.....	57
3.7.15.2.1	EIST	57
3.7.15.2.2	Turbo Mode	57
3.7.15.2.3	C-State	58
3.7.15.2.4	Enhanced C-States	58
3.7.15.3	Active Processor Cores	58
3.7.15.4	Intel Virtualization Technology	58
3.7.15.5	VT-d.....	58
3.7.16	USB Configuration.....	59
3.7.16.1	Onboard USB Feature.....	59
3.7.16.2	Legacy USB Support.....	59
3.7.16.3	XHCI Hand-Off	59
3.7.16.4	USB Mass Storage Driver Support.....	60
3.7.17	Network Stack Configuration	61
3.7.17.1	Network Stack	61
3.7.17.2	IPv4 PXE Support.....	61
3.7.17.3	IPv4 HTTP Support	61
3.7.17.4	Ipv6 PXE Support	61
3.7.17.5	Ipv6 HTTP Support.....	62
3.7.17.6	PXE boot wait time	62
3.7.17.7	Media detect count	62
3.7.18	SDIO Configuration	62

3.8	Security Menu.....	63
3.8.1	Setup Administrator Password.....	63
3.8.2	User Password.....	63
3.8.3	Secure Boot.....	64
3.9	Boot Menu.....	65
3.9.1	Setup Prompt Timeout.....	65
3.9.2	Bootup NumLock State.....	65
3.9.3	Full Screen LOGO Show.....	65
3.9.4	Fast Boot.....	65
3.9.5	Boot mode select.....	66
3.9.6	Fixed BOOT ORDER Priorities.....	66
3.9.7	UEFI Hard Disk Drive BBS Priorities.....	66
3.9.8	UEFI Application Boot Priorities.....	66
3.10	Save & Exit Menu.....	67
3.10.1	Save Change and Exit.....	67
3.10.2	Discard Change and Exit.....	67
3.10.3	Load Optimized Defaults.....	67
3.10.4	Boot Override.....	68
3.10.5	AMIFWUpdate.....	68
Chapter 4: Application Note.....		69
4.1	Windows 10 Drivers Installation.....	69
4.2	Boot Mode.....	69
4.3	Video Support.....	70
4.4	OTG Support.....	70
4.5	eDP Support (Available with ECM-3455J eDP version ONLY).....	70
4.6	PXE Boot.....	71
4.6.1	In "UEFI" mode:.....	71
4.6.2	In "Legacy" mode:.....	72
4.7	The "SPEAKER" Header.....	72
4.8	The MIC support under Win10.....	72

Mainboard Specifications

Model	MX310H
Processor/ Chipset	Intel® J3455 SoC (1.5GHz Base Frequency, 2.3GHz Burst Frequency)
Memory	One 204-pin SODIMM DDR3L-1600Mhz (PC3-12800) slot supports up to 8GB Max
Display	Intel® Integrated HD Graphic Engine
Maximum Resolution	HDMI: 3840 x 2160 @ 30Hz LVDS: 1920x1200 @ 60Hz Note: The max resolution could be lower which is limited by the type of monitor or LVDS panel connected.
SATA	1 x SATA III connector
Expansion Slots	1 x mSATA/Mini-PCIe Slot 1 x M.2 Type E 2230 (with USB & PCIe x1) for wifi module 1 x uSIM Slot
USB	4 x USB 3.0 ports (2x stack-up @ Rear I/O) 4 x USB 2.0 ports (2x Header) ("F_USB2" header port 0 (USB set on pin 2, 4, 6, 8, 10 only) supports Dual Role (OTG) when BIOS "XDCI Support" is set at "Device Mode").
Super I/O Controller	Nuvoton® NCT6126D
Serial Ports	1 x RS-232/ Ring-In (1x 2.0mm Locking Type Header) (with Voltage Selection) 1 x RS-232/ RS-422/ RS-485/ Ring-In/ (1x 2.0mm Locking Type Header) (with Voltage Selection)
LVDS	18/24bits Dual Channel LVDS through Chrontel® CH7511B
Watch Dog Timer	1sec ~ 255 min timer
HW Monitor	Yes
Audio	Realtek® ALC255 HD Audio Codec with auto jack sensing
LAN	Realtek® RTL8111H PCIe Gigabit LAN 1 x 10/100/1000 LAN Port Realtek® RTL8111H PCIe Gigabit LAN 1 x 10/100/1000 LAN Port
BIOS	AMI® UEFI BIOS AMI BIOS with 64Mb SPI ROM
TPM	1 x TPM 2.0 Security Device (Infineon® SLB9665TT-2.0)

Onboard I/O Headers	
SATA	1 x Std. SATA III Connector
	1 x SATA Power Header
MSATA_MPCIE	Supports mSATA SSDs
M2_E	Supports E-Key WIFI modules ³ (Supports WIFI Cards in 2230 Only)
U_SIM	Supports uSIM card
USB	2 x USB2.0 Header (2 ports/header)
COM Port	2 x Header
Front Audio	1 x Header (supports 4 ohms/ 2W speaker)
Front Panel	1 x Header
Fan Header	1 x Headers (12V, 4-pins)
LVDS	1 x Header for LVDS Panel Connection
	1 x Header for LVDS Panel Backlight Control
SMBUS	1 x Header
I2C	1 x Header
SPI	1 x Header
LPT/ GPIO	1 x Header
LPC	1 x Header
Volume Control	1 x Header
Chassis Intrusion	1 x Header
Onboard Jumpers	
COM Port Ring-In/ Power Select	2 x Headers provides power selection of "12V" or "5V" or "Ring-In" on COM ports
AT/ATX Select	1 x Header
GPIO Power Select	1 x Header
GPIO High/Low Select	1 x Header
LPT/ GPIO Select	1 x Header
Clear CMOS	1 x Header
LVDS Backlight Enable Voltage Select	1 x Header
Rear I/O Ports	
HDMI	1 x HDMI Connector
USB3.0	2x Stack up USB3.0 Connectors
LAN	2 x 10/100/1000 LAN Ports
Audio	1 x Audio port

Power & Connector	
	1 x Wide Range DC-In (9V~36V, 6A Max. 19V Recommended)
	1x Header (uses a 1x4 2.54mm to AC adapter barrel connector cable)
Form Factor	
	3.5" SBC (5.7" x 4")

Chapter 1: System Setup

This chapter describes the mainboard features and the new technologies it supports

1.1 Welcome!

The mainboard delivers a host of new features and latest technologies, making it another line of BCM long life mainboards! Before you start installing the mainboard, and hardware devices on it, check the items in your package with the list below.

If any of the items listed below is damaged or missing, please contact with your vendor.

1.2 Packing Contents

- Mainboard

- 1 x ECM3455J

- Accessories

- 1 x ECM3455J Heat Spreader

1.3 Before you proceed

Take note of the following precautions before you install mainboard components or change any mainboard settings.

- **Unplug the power cord from the wall socket before touching any component inside the system.**
- **Use a grounded wrist strap or touch a safely grounded object or to a metal object, such as the power supply case, before handling components to avoid damaging them due to static electricity.**
- **Hold components by the edges to avoid touching the ICs on them.**
- **Whenever you uninstall any component, place it on a grounded antistatic pad or in the bag that came with the component.**
- **Before you install or remove any component, ensure that the power supply is switched off or the power cord is detached from the power supply. Failure to do so may cause severe damage to the mainboard, peripherals, and/or components.**

1.4 Mainboard Overview

Before you install the mainboard, study the configuration of your chassis to ensure that the mainboard fits into it.



Make sure to unplug the power cord before installing or removing the mainboard. Failure to do so can cause you physical injury and damage mainboard components.

1.4.1 Mounting Holes

Place the screws into the mounting holes indicated by red squares to secure the mainboard to the chassis (or heat spreader).



Do not over-tighten the screws. This may damage the mainboard.

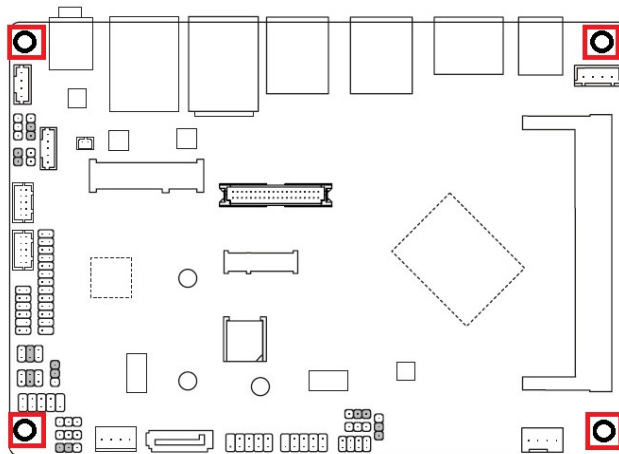

1.4.2 Onboard LEDs

The mainboard comes with a “Power On LED” (red) and one “Standby Power LED” (green) to indicate the system status. When the “Standby Power LED” lights on: It means the system is either in the standby state, or the power cable is still connected to the power source. The “Power On LED” lights on/off to indicate that the system status, in sleep mode, or in soft-off mode. This is a reminder that you should shut down the system and unplug the power cable before removing or plugging in any mainboard component. The illustration below shows the locations of onboard LEDs.

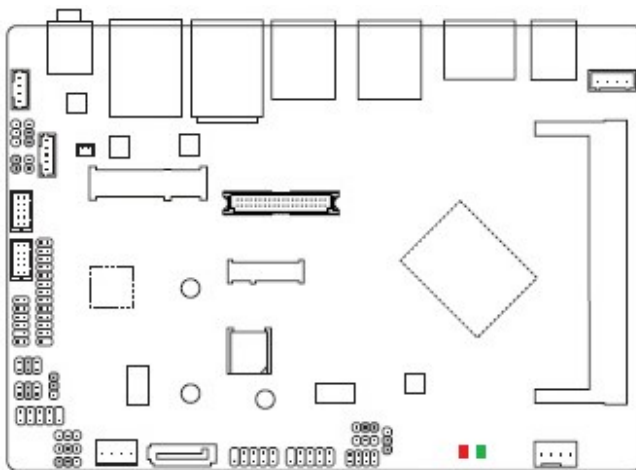

- **STB: Standy Power LED (Green)**
- **BOOT: Power On LED (Red)**

1.4.3 Mainboard Layout (Top View)

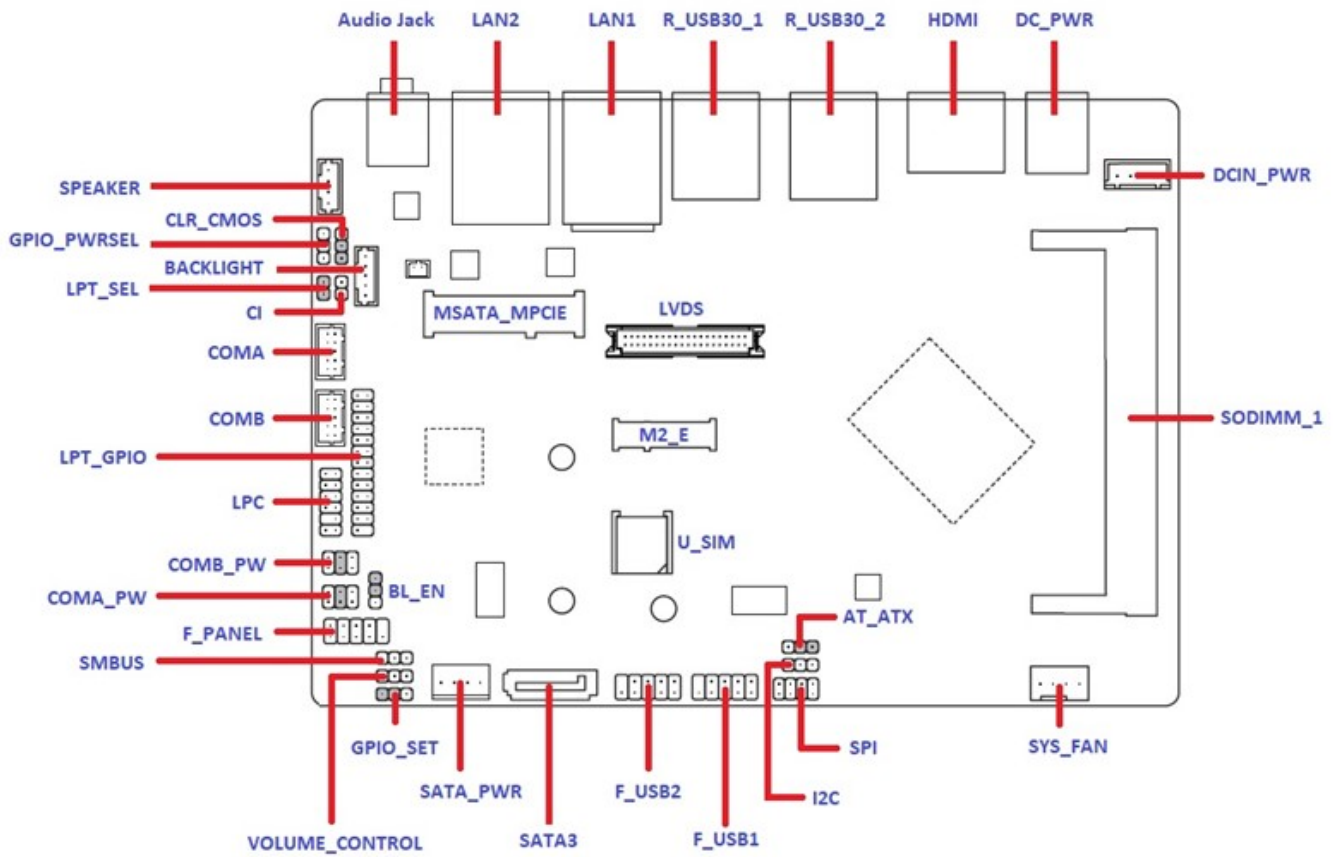

1.4.4 Layout Content List

• 1.4.4.1 Slots			
Label	Function	Note	Page
SODIMM_1	204-pin DDR3L SODIMM slot	8MB maximum	22
MSATA_MPCIE	Supports mSATA SSDs		30
U_SIM	Supports uSIM card		30
M2_E	Supports E-Key WIFI modules ³	Supports WIFI Cards (E-key) in 2230 Only	31

• 1.4.4.2 Internal Jumpers			
Label	Function	Note	Page
AT_ATX	ATX/AT Mode Select (ATX Mode (default) / AT Mode)	1 x 3 header, pitch 2.54mm	38
BL_EN	LVDS Backlight Enable Voltage Select (+3.3V (default)/ +5V)	1 x 3 header, pitch 2.54mm	38
COMA_PW	COMA +12V/ +5V/ Ring-In Select	2 x 3 header, pitch 2.54mm	39
COMB_PW	COMB +12V/ +5V/ Ring-In Select	2 x 3 header, pitch 2.54mm	39
GPIO_SET	GPIO High (+3V (default) / Low Select	1 x 3 header, pitch 2.54mm	39
LPT_SEL	LPT/ GPIO Selection Jumper for header "LPT_GPIO"	1 x 2 header, pitch 2.54mm	40
GPIO_PWRSEL	GPIO Power Select (+5V (default) /+12V)	1 x 3 header, pitch 2.54mm NOTE: When "LPT_GPIO" header is set in GPIO mode, this jumper selects its pin #10, 12 "GPIO_PWR" (GPIO Power) at the level of +12V or +5V (default).	40
CLR_CMOS	Clear CMOS	1 x 3 header, pitch 2.54mm	41

• 1.4.4.3 Internal Headers			
Label	Function	Note	Page
DCIN_PWR	4-Pin Power Connector	1 x 4 shroud header, 2.54mm 9V~36V, 6A Max (19V recommended)	27
F_PANEL	System Panel Connector	2 x 5 header, pitch 2.54mm	28
SYS_FAN	System Fan Connector	1 x 4 wafer, Pitch 2.54mm	28
SATA3	Serial ATA 3.0 Connector	7-pin header	29
SATA_PWR	SATA Power Connector		29
F_USB1	USB2.0 Port 1	2 x 5 box header, pitch 2.54mm	31
F_USB2	USB2.0 Port 2	2 x 5 box header, pitch 2.54mm ("F_USB2" header port 0 (the USB set on pin 2, 4, 6, 8, 10 only) Supports Dual Role (OTG) when BIOS "XDCI Support" is set at "Device Mode").	31
COMA	Serial Port A	2 x 5 wafer header, pitch 2.00mm	32
COMB	Serial Port B	2 x 5 wafer header, pitch 2.00mm	32
LVDS	LVDS Panel Connector	2 x 20 header, 1.25mm pitch wire to board connector (WTB) Mating Cable Reference: Cable Housing: Hirose® "DF13-40DS-1.25C" or eq Cable Terminal: Hirose® "DF13-2630SCF" or eq	32
BACKLIGHT	LVDS Panel Backlight Connector	1 x 5 wafer header, pitch 2.00mm Mating Cable Reference: Cable Housing: Molex® "87369-0500 (P=2.0mm)" or eq Cable Terminal: Molex® "502128000" or eq	33
I2C	I2C Connector	1 x 3 header, 2.54mm	33

SPI	SPI Connector	2 x 4 header, 2.00mm	34
SMBUS	SMBUS Connector	1 x 3 header, 2.54mm	34
VOLUME_CONTROL	Volume Control	1 x 3 header, 2.54mm	35
LPT_GPIO	LPT/ GPIO Header	1 x 13 header, 2.00mm	35
LPC	LPC Header	2 x 6 header, 2.00mm	36
SPEAKER	4-Pin Speaker Header	1 x 4 header, 2.00mm (Supports 4 ohms/ 2W speaker).	36
CI	Chassis Intrusion Connector	1 x 2 wafer header, 2.54mm	37

• 1.4.4.4 Back Panel Connectors (Rear I/O)			
Label	Function	Note	Page
DC_PWR	DC-In Jack	DC-In Jack for AC Adapter Power Connection. (9V~36V, 6A max)	25
HDMI	HDMI Port		25
R_USB30_1	USB3.0 Ports		25
R_USB30_2	USB3.0 Ports		25
LAN1	Gigabit LAN		25
LAN2	Gigabit LAN		26
Audio Jack	Line-Out/ MIC Port (support audio jack with 3 black rings)	This port connects a headset (audio jack with 3 black rings (OMTP or CTIA types) or speaker. NOTE: Check “Application Notes” section #8 for details.	26

1.5 System Memory

1.5.1 Overview

The mainboard comes with one 204-pin DDR3L SODIMM socket.

The following figure illustrates the location of the sockets:

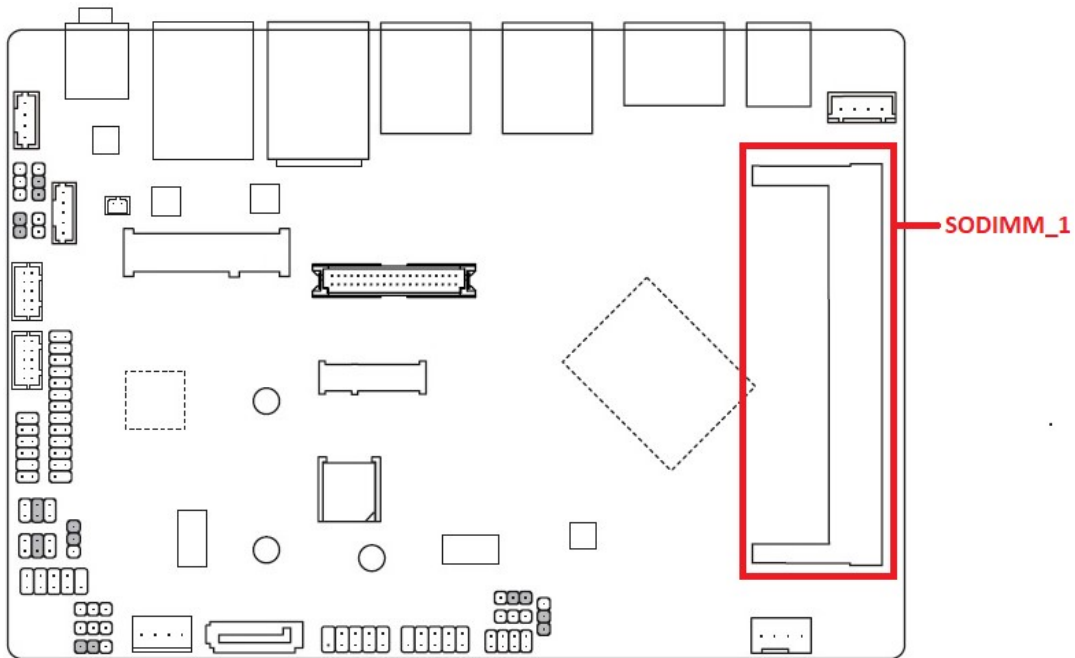

1.5.2 Memory Configurations

The ECM-3455J board supports Non-ECC, Un-buffered, 204-pins DDR3L-1600MHz (PC3-12800) SODIMM up to 8GB Max.

1.5.3 Installing the DDR3L SODIMM



Make sure to unplug the power supply before installing or removing SODIMMs, or other peripherals from the system. Failure to do so may cause severe damage to both the mainboard and the peripherals.

1. Locate the SODIMM socket onboard.
2. Hold two edges of the SODIMM module carefully, and keep away of touching its connectors.
3. Align the notch key on the SODIMM module with the rib on the slot.
4. Firmly press the SODIMM module into the socket which will be snapped into the mounting notch automatically. Do not force the SODIMM module in with extra force as the SODIMM module can only fits in one direction.

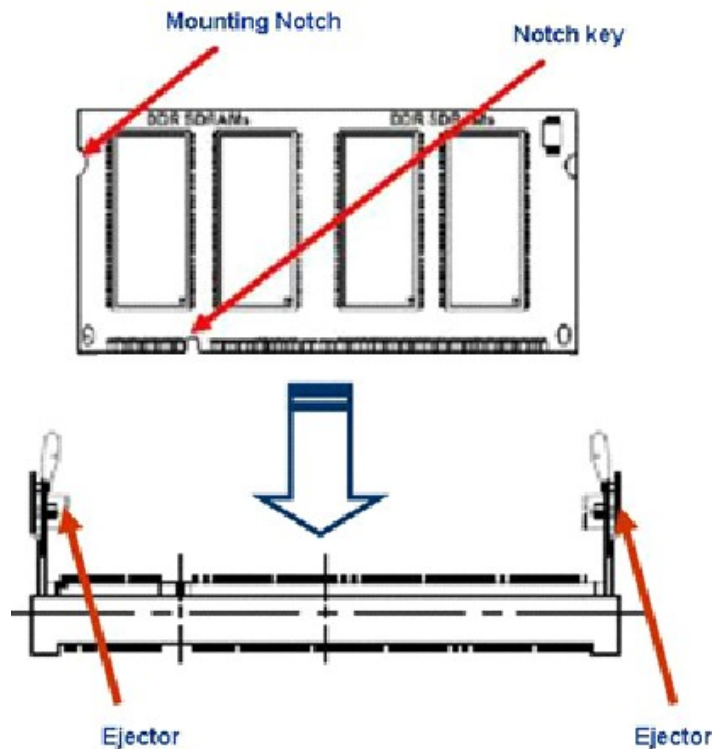

NOTE:



1. A DDR3L memory module is keyed with a notch so that it fits in only one direction.
2. **DO NOT** force the memory module into the socket in order to avoid damaging the memory module and the slot.

3. DDR3L memory modules are not interchangeable with DDR or DDR2, or DDR4. Do not install DDR, DDR2, or DDR4 SODIMMs to this board's SODIMM socket.

1.5.4 Removing the DDR3L SODIMM

Follow these steps to remove a SODIMM.

1. Press the two ejector tables on the slot outward simultaneously
2. Remove the SODIMM module from the socket.

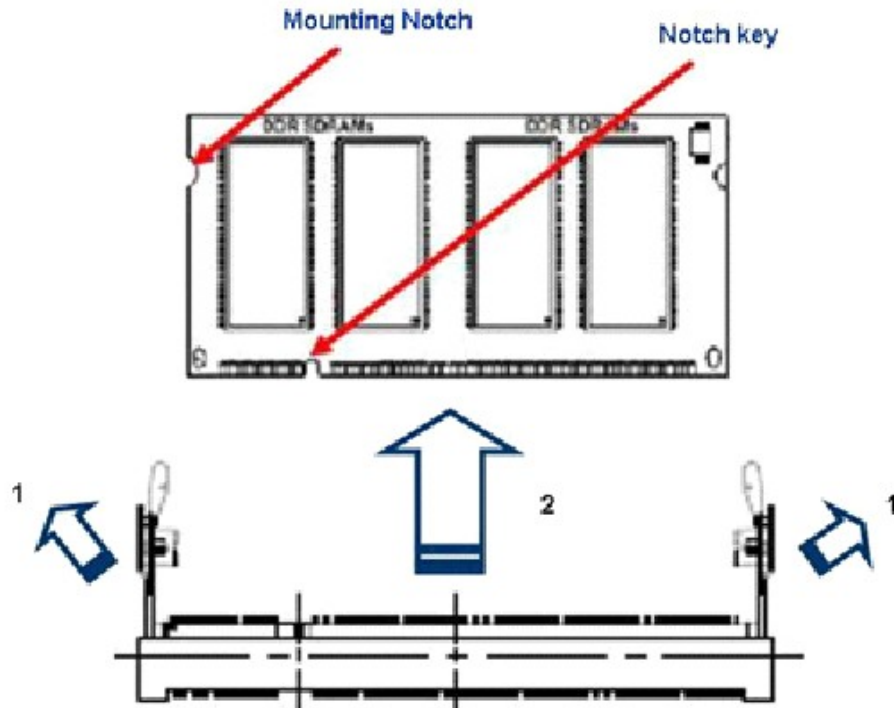

NOTE:



Hold the SODIMM module gently when pressing the ejector tabs. The SODIMM might get damaged when it flips out with extra force.

1.6 Back Panel (Rear I/O Ports)

1.6.1 Back Pane Connectors

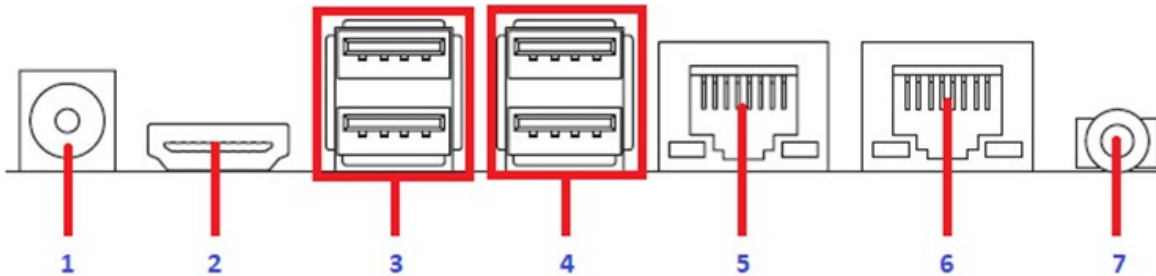

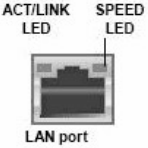
Item	Name	Function	Description																				
1	DC_PWR	DC-In Jack	DC-In Jack for AC Adapter Power Connection. (9V~36V, 6A max. 19V recommended)																				
2	HDMI	HDMI Port	The HDMI Port Connectors. NOTE: 1. Under UEFI boot mode: The HDMI and LVDS will provide video signal simultaneously. 2. Under Legacy boot mode: Only either HDMI (default) or LVDS provides video signal. (if LVDS panel is attached, please disconnect the HDMI monitor connection to ECM-3455J board in order for the video signal to be switched to the LVDS panel).																				
3	R_USB30_2	USB3.0 Ports	The USB3.0 Port Connectors																				
4	R_USB30_1	USB3.0 Ports	The USB3.0 Port Connectors.																				
5	LAN1	Gigabit LAN (RJ-45) Connectors <div style="text-align: center;">  <p>ACT/LINK LED SPEED LED</p> <p>LAN port</p> </div>	<p>This port allows Gigabit connection to a Local Area Network (LAN) through a network hub. Refer to the table below for the LAN port LED indications.</p> <table border="1"> <thead> <tr> <th colspan="2">ACT/Link LED</th> <th colspan="2">Speed LED</th> </tr> <tr> <th>Status</th> <th>Description</th> <th>Status</th> <th>Description</th> </tr> </thead> <tbody> <tr> <td>OFF</td> <td>No link</td> <td>OFF</td> <td>10Mbps connection</td> </tr> <tr> <td>Orange</td> <td>Linked</td> <td>Green</td> <td>100Mbps connection</td> </tr> <tr> <td>Blinking</td> <td>Data activity</td> <td>Orange</td> <td>1Gbps connection</td> </tr> </tbody> </table>	ACT/Link LED		Speed LED		Status	Description	Status	Description	OFF	No link	OFF	10Mbps connection	Orange	Linked	Green	100Mbps connection	Blinking	Data activity	Orange	1Gbps connection
ACT/Link LED		Speed LED																					
Status	Description	Status	Description																				
OFF	No link	OFF	10Mbps connection																				
Orange	Linked	Green	100Mbps connection																				
Blinking	Data activity	Orange	1Gbps connection																				

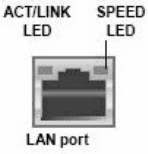
6	LAN2	<p>Gigabit LAN (RJ-45) Connectors</p> 	<p>This port allows Gigabit connection to a Local Area Network (LAN) through a network hub. Refer to the table below for the LAN port LED indications.</p> <table border="1" data-bbox="738 336 1214 724"> <thead> <tr> <th colspan="2">ACT/Link LED</th> <th colspan="2">Speed LED</th> </tr> <tr> <th>Status</th> <th>Description</th> <th>Status</th> <th>Description</th> </tr> </thead> <tbody> <tr> <td>OFF</td> <td>No link</td> <td>OFF</td> <td>10Mbps connection</td> </tr> <tr> <td>Orange</td> <td>Linked</td> <td>Green</td> <td>100Mbps connection</td> </tr> <tr> <td>Blinking</td> <td>Data activity</td> <td>Orange</td> <td>1Gbps connection</td> </tr> </tbody> </table>	ACT/Link LED		Speed LED		Status	Description	Status	Description	OFF	No link	OFF	10Mbps connection	Orange	Linked	Green	100Mbps connection	Blinking	Data activity	Orange	1Gbps connection
ACT/Link LED		Speed LED																					
Status	Description	Status	Description																				
OFF	No link	OFF	10Mbps connection																				
Orange	Linked	Green	100Mbps connection																				
Blinking	Data activity	Orange	1Gbps connection																				
7	Audio Jack	Line-out / MIC port	<p>This port connects a headset (audio jack with 3 black rings (OMTP or CTIA types) or speaker.</p> <p>NOTE: Check "Application Notes" section #8 for details.</p>																				

1.7 Connectors/ Headers

1.7.1 4-Pins Power Connector: DCIN_PWR

This header is an alternative power connection for the system chassis which doesn't provide the access to "DC_PWR" AC adapter connection through ECM-3455J rear IO. A 4-pin (2.54mm) to AC adapter barrel connector cable is required.

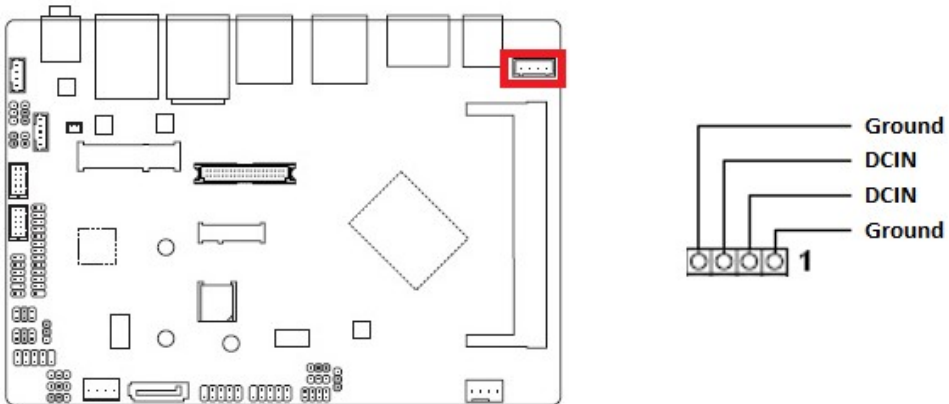

NOTE:

1. If AC adapter is connected with "DC_PWR" connector at rear IO, then this 4-pin connector doesn't need any power connection.
2. 9V~36V, 6A Max. 19V recommended.

1.7.2 Front Panel Connector: F_PANEL

These connectors are for electrical connections to the front panel switches and LEDs. The "F_PANEL" connector is compliant with Intel® Front Panel I/O Connectivity Design Guide.

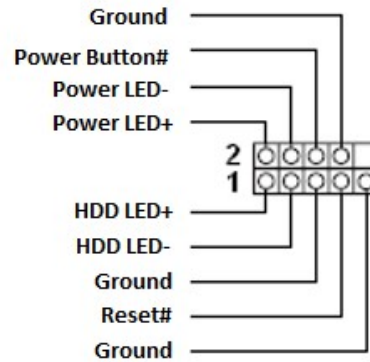
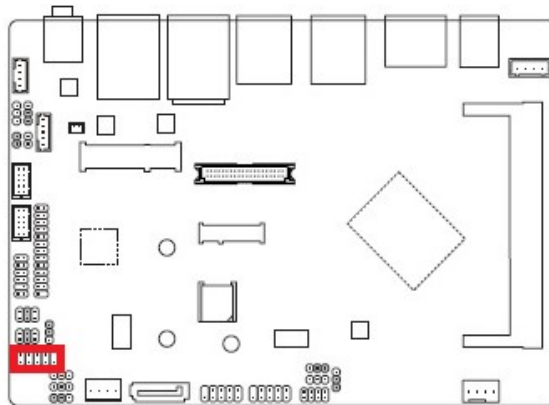

1.7.3 System Fan Connector: SYS_FAN

The fan power connectors support system cooling fan with +12V. When connecting the wire to fan connector, please note that the red wire is designated as "Power" and should be connected to "+12V" pin; the black wire is designated as "Ground" and connected to "Ground". In order to take the advantage of System Hardware Monitor and Smartfan feature, be sure to use the fan which is specifically designed with speed sensor.

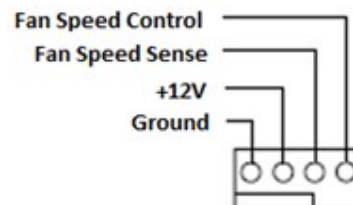
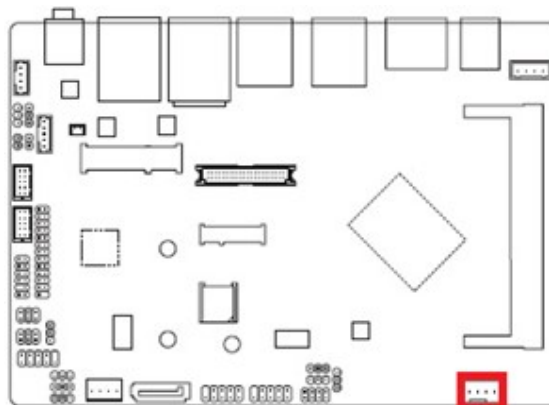

1.7.4 Serial ATA 3.0 Connector: SATA3

This SATA port supports SATA3.0 standard.

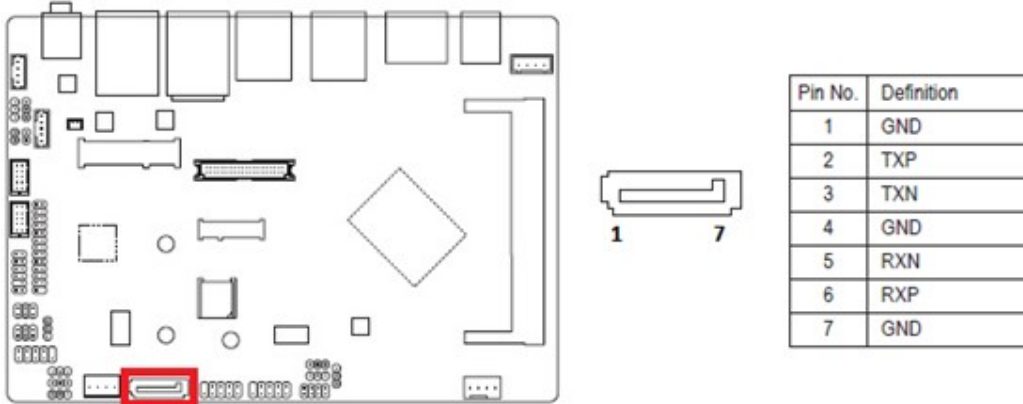

Do not fold the Serial ATA cable into 90-degree angle. Otherwise, data loss may occur during data transmission.

1.7.5 SATA Power Connector: SATA_PWR

The SATA hard drive power connection.

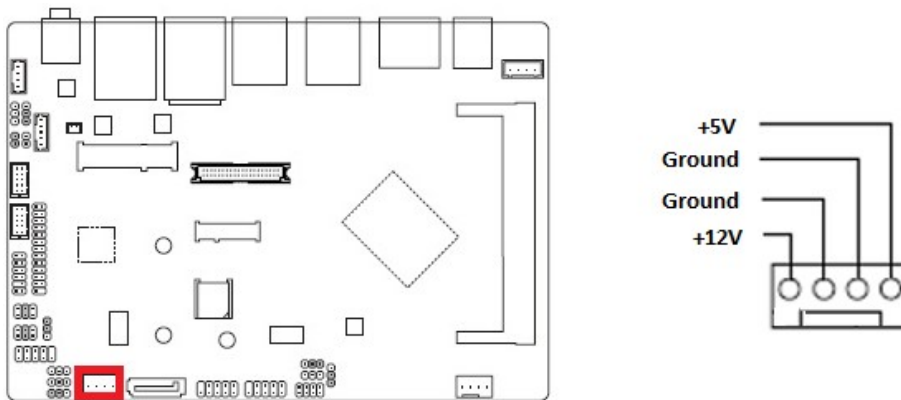

1.7.6 mSATA/ Mini-PCIE Connector: MSATA_MPCIE

This connector supports mSATA type SSDs.

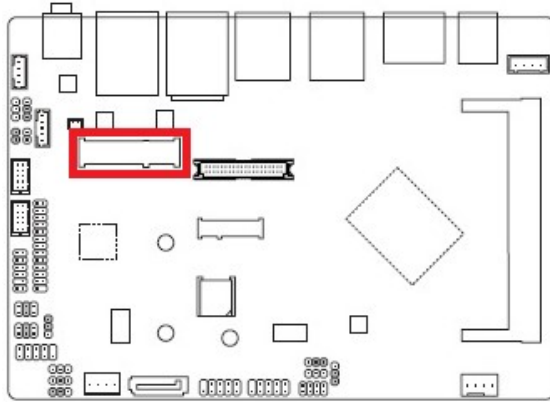

1.7.7 uSIM Card Slot: U_SIM

This slot provides connection to uSIM card.

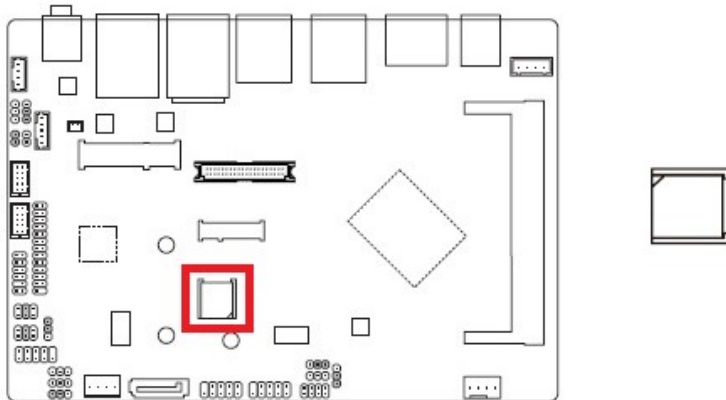

1.7.8 M.2 Socket: M2_E (E-Key, Supports Wifi Cards in 2230 Only)

This connector supports WIFI cards in 2230.

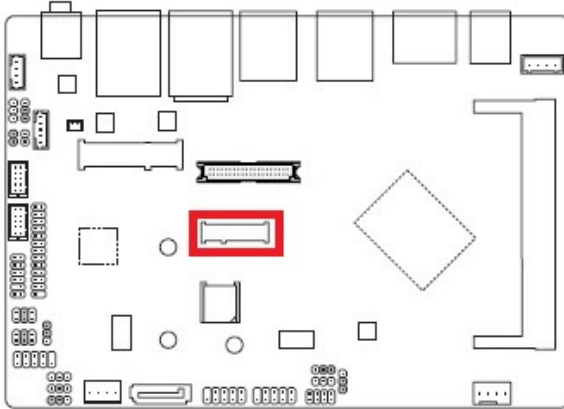

1.7.9 Front USB2.0 Headers: F_USB1, F_USB2

This header provides two USB2.0 connections (An USB2.0 cable is required).

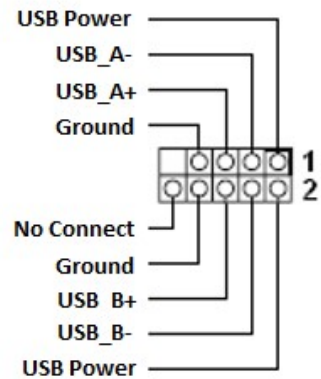
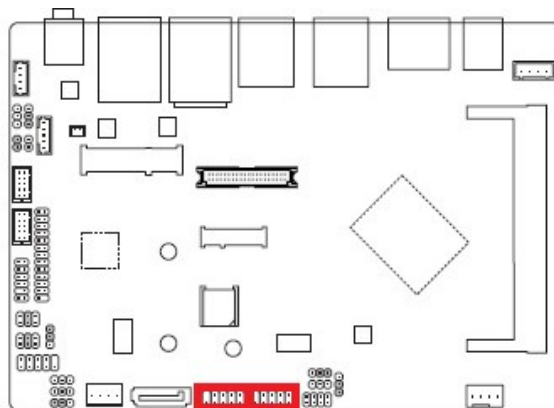

NOTE:

1. "F_USB2" header port 0 (the USB set on pin 2, 4, 6, 8, 10 only) Supports Dual Role (OTG) when BIOS "XDCI Support" is set at "Device Mode".

1.7.10 COM Ports: COMA, COMB

These headers provide serial connections with serial port COMA and COMB. COMA provides RS232 or Ring-In support. COMB supports RS232/ RS422/ RS485, or Ring-In.

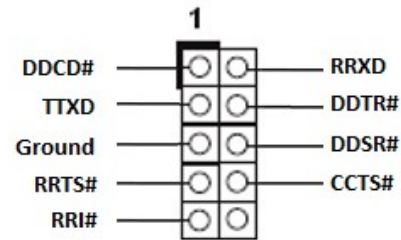
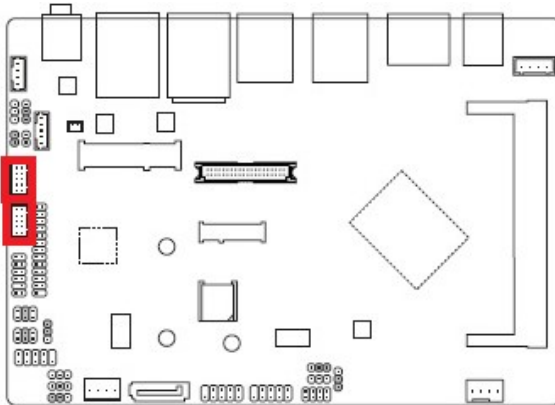

1.7.11 LVDS Panel Connector: LVDS

This header provides connection to LVDS type panels in 18/ 24-bit Single/ Dual channels.

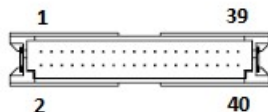
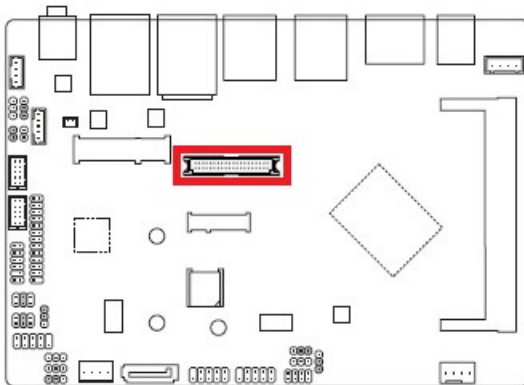

PIN	Signal Name	PIN	Signal Name
2	VDD_+5V	1	VDD_+3.3V
4	VDD_+5V	3	VDD_+3.3V
6	DDC_DATA	5	DDC_CLK
8	GND	7	GND
10	LVDS_A0+	9	LVDS_A1+
12	LVDS_A0-	11	LVDS_A1-
14	GND	13	GND
16	LVDS_A2+	15	LVDS_A3+
18	LVDS_A2-	17	LVDS_A3-
20	GND	19	GND
22	LVDS_B0+	21	LVDS_B1+
24	LVDS_B0-	23	LVDS_B1-
26	GND	25	GND
28	LVDS_B2+	27	LVDS_B3+
30	LVDS_B2-	29	LVDS_B3-
32	GND	31	GND
34	LVDS_A_CLK+	33	LVDS_B_CLK+
36	LVDS_A_CLK-	35	LVDS_B_CLK-
38	GND	37	GND
40	VDD_+12V	39	VDD_+12V

1.7.12 LVDS Panel Backlight Connector: BACKLIGHT

This header provides connection for LVDS panel backlight control connections.

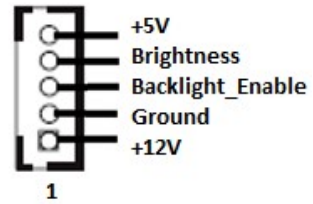
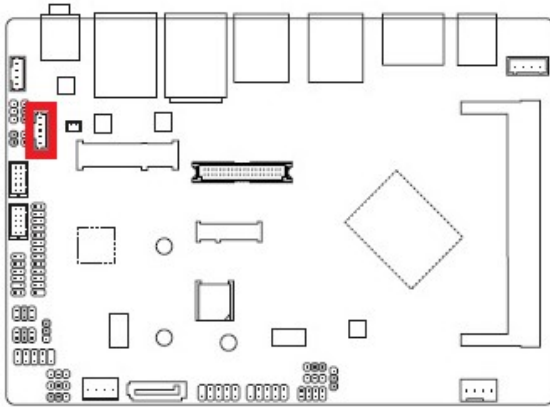

1.7.13 I2C Header: I2C

This header provides I2C signal connection.

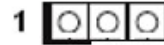
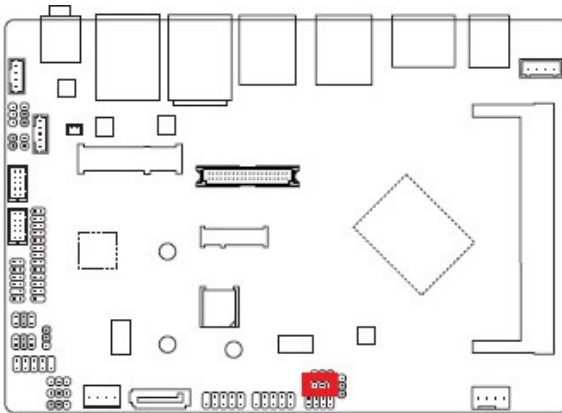

Pin No.	Definition
1	I2C_SCL
2	I2C_SDA
3	GND

1.7.14 SPI Header: SPI

This header provides SPI signal connection.

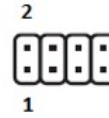
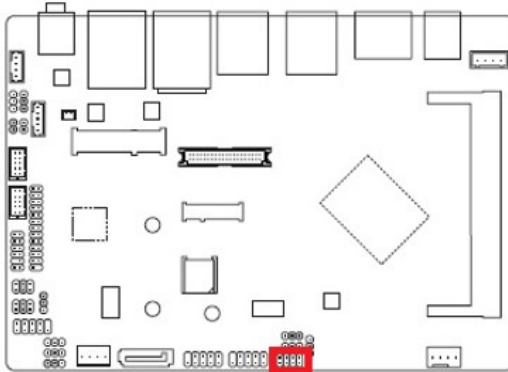

Pin No.	Definition	Pin No.	Definition
1	VCC1_8VDUAL	5	SPI_MISO_R
2	GND	6	SPI_MOSI_R
3	-SPI_CS0_R	7	-SPI_HOLD_R
4	SPI_CLK_R	8	-SPI_WP0_R

1.7.15 SMBUS Header: SMBUS

This header provides SMBUS signal connections.

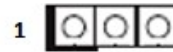
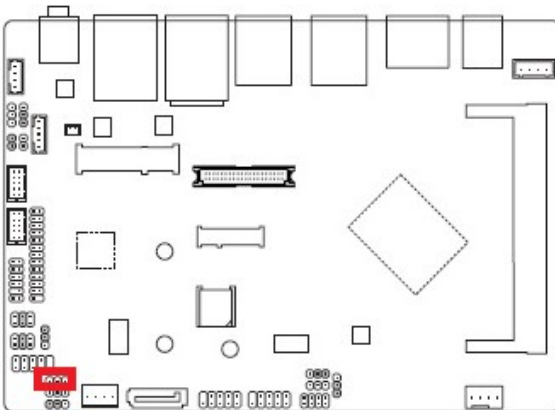

Pin No.	Definition
1	SMB_CLK
2	SMB_DATA
3	GND

1.7.16 Volume Control Header: VOLUME_CONTROL

This header provides volume control signal.

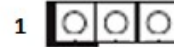
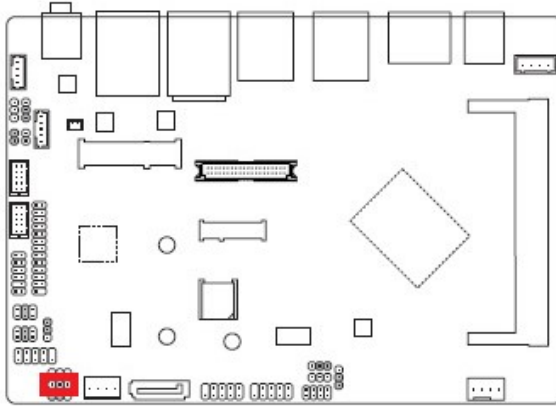

Pin No.	Definition
1	VOL_DOWN
2	GND
3	VOL_UP

1.7.17 LPT/ GPIO Header: LPT_GPIO

This header provides LPT or GPIO signal connections.

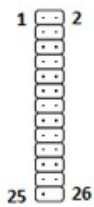
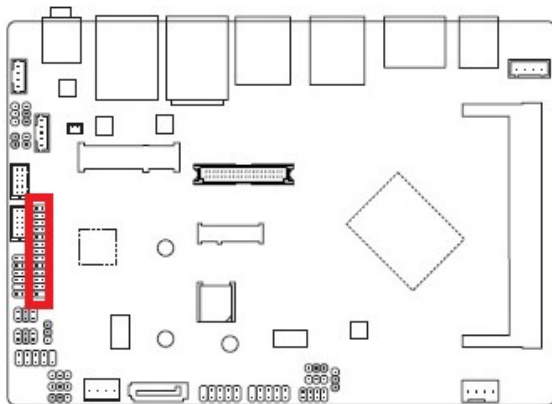

LPT Mode

Pin #	Signal Name	Pin #	Signal Name
1	STB-	2	AFD-
3	PD0	4	ERR-
5	PD1	6	INIT-
7	PD2	8	SLIN-
9	PD3	10	GND
11	PD4	12	GND
13	PD5	14	GND
15	PD6	16	GND
17	PD7	18	GND
19	ACK-	20	GND
21	BUSY	22	GND
23	PE	24	GND
25	SLCT	26	NC

GPIO Mode

Pin #	Signal Name	Pin #	Signal Name
1	SIO_GP47	2	SIO_GP46
3	SIO_GP42	4	SIO_GP45
5	SIO_GP41	6	SIO_GP44
7	SIO_GP40	8	SIO_GP43
9	SIO_GP37	10	GPIOPWR
11	SIO_GP36	12	GPIOPWR
13	SIO_GP35	14	GND
15	SIO_GP34	16	GND
17	SIO_GP33	18	GND
19	SIO_GP32	20	GND
21	SIO_GP31	22	GND
23	SIO_GP30	24	GND
25	NC	26	NC

1.7.18 LPC Header: LPC

This header provides LPC signal connections.

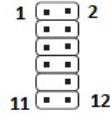
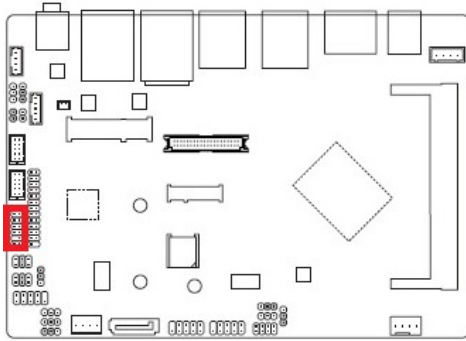

Pin No.	Definition	Pin No.	Definition
1	NC	7	-LFRAME
2	VCC3	8	LAD0
3	LAD3	9	No Pin
4	-PFMRST	10	GND
5	LAD1	11	LPC33
6	LAD2	12	GND

1.7.19 Speaker Header: SPEAKER

This header supports 4 ohms/ 2W speaker.

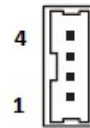
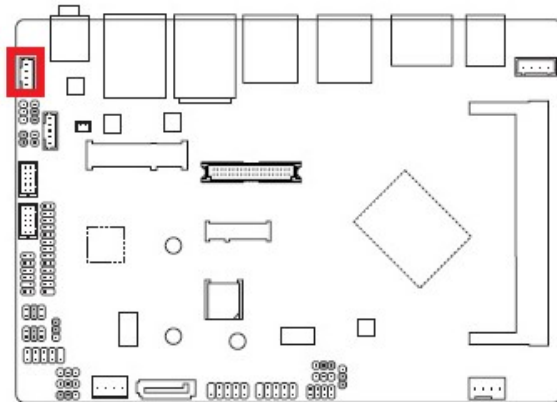

Pin No.	Definition
1	Speaker OUT R-
2	Speaker OUT R+
3	Speaker OUT L-
4	Speaker OUT L+

1.7.20 Chassis Intrusion Header: CI

This 2-pins header provides chassis intrusion warning connection.

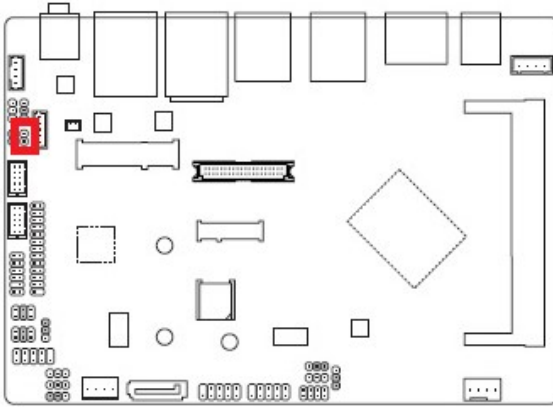

Pin No.	Definition
1	Signal
2	GND

1.8 Jumpers

1.8.1 ATX/AT Mode Select: AT_ATX

This header provides the option to boot the system in the form of ATX mode (default) or AT mode. When the system is set in AT mode, the system power on/off will be controlled directly by the power switch on the power supply. And some of the power saving modes will not function as ATX mode provided.

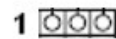
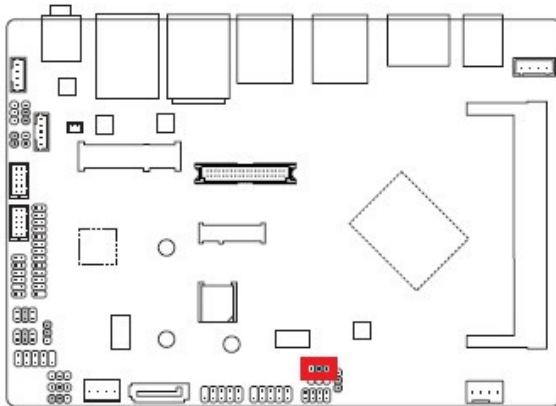

Pin 1-2: AT Mode
Pin 2-3: ATX Mode (Default)

1.8.2 LVDS Backlight Enable Voltage Select: BL_EN

This jumper provides selection of LVDS Backlight Enable Voltage level in +3.3V (default) or +5V.

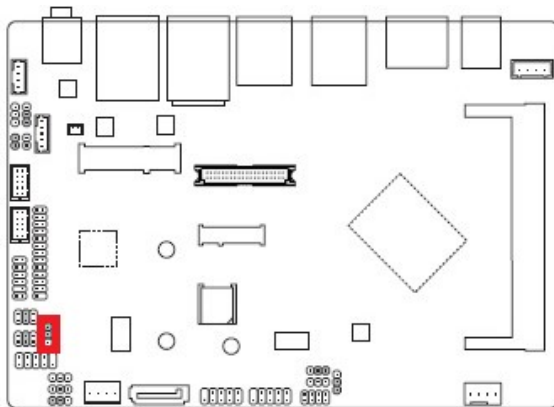

Pin 1-2: +3.3V (Default)
Pin 2-3: +5V

1.8.3 COM Port +12V/ +5V/ Ring-In Select: COMA_PW, COMB_PW

These jumpers provide selection between +12V, +5V, and Ring-In (default).

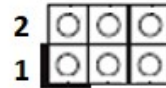
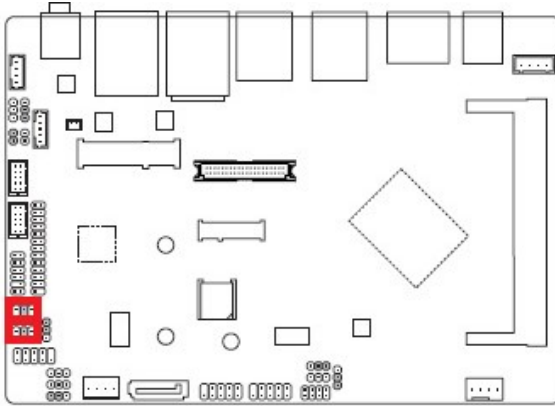

Pin 1-2: +12V
Pin 3-4: Ring-In (Default)
Pin 5-6: +5V

1.8.4 GPIO High/ Low Select: GPIO_SET

This jumper provides selection for GPIO High (+3V, default) or Low.

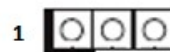
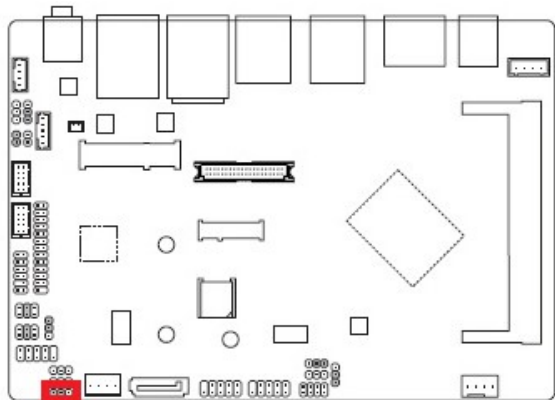

Pin 1-2: High (+3V, Default)
Pin 2-3: Low

1.8.5 LPT/ GPIO Selection for header “LPT_GPIO”: LPT_SEL

This jumper selects will designate the function of “LPT_GPIO” header in “LPT” or “GPIO”.

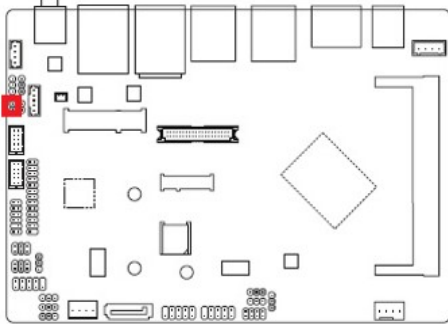

Short Pin 1-2: Configure the LPT_GPIO header to support LPT device.

Removed jumper connector on pin 1-2: Configure LPT_GPIO header in GPIO mode (Default).

1.8.6 GPIO Power Select: GPIO_PWRSEL

When “LPT_GPIO” header is set in GPIO mode, this jumper selects its pin #10, 12 “GPIOPWR” (GPIO Power) at the level of +12V or +5V (default).

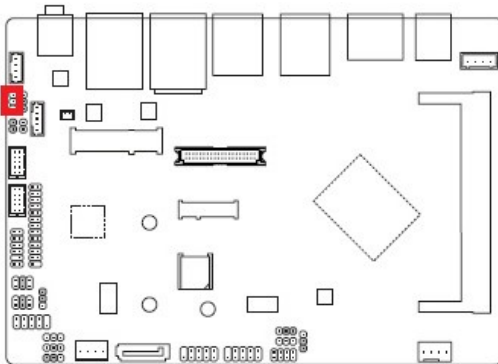

Pin 1-2: Set GPIO voltage to +12V.



Pin 2-3: Set GPIO voltage to +5V (Default).

1.8.7 Clear CMOS Header: CLR_CMOS



There is a CMOS RAM onboard that has the power supplied from an external battery to maintain the registry settings of system configuration.

For normal state (default), the jumper is set on pin location 2 and 3.

To clear the CMOS, here is the procedure:

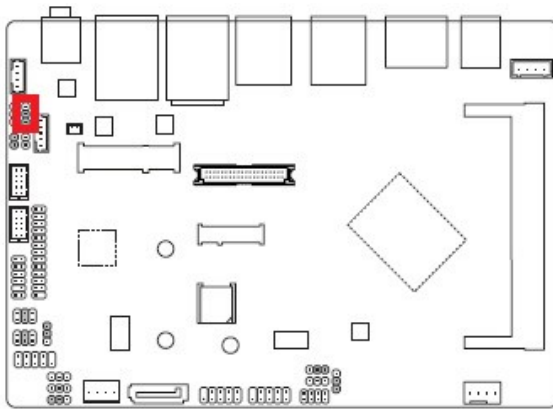
1. Disconnect all power connections to ECM-3455J first,
2. Set the "CLR_CMOS" jumper to pin location 1 and 2 for at least 30 seconds while the system is disconnected from the power.
3. Place the jumper back to pin location 2 and 3 for mainboard normal operation.



- 1  Pin 1-2: Clear CMOS
 Pin 2-3: Normal (default)



1. Avoid clearing the CMOS while the system is ON, which may damage the mainboard.

Chapter 2: Starting Up the System

2.1 Starting Up Your System

1. After all connections are made, close your computer case cover.
2. Be sure all the switches are off, and check that the power supply input voltage is set to the local voltage, usually in-put voltage is 220V~240V or 110V~120V depending on your country's voltage used.
3. Connect the power supply cord into the power supply located on the back of your system case according to your system user's manual.
4. Turn on your peripheral in following order:
 - a. Your monitor.
 - b. The other external peripheral (Printer, Scanner, External Modem etc...)
 - c. Your system power. For ATX power supplies, you need to turn on the power supply and press the ATX power switch on the front side of the case.
5. The power LED on the front panel of the system case will light on. The system will then run power-on test. While the test is running, the BIOS will alarm beeps or additional message will appear on the screen.

If you do not observe any activity on the screen within 30 seconds from the time you turn on the power, the system may have failed on power-on test. Recheck your jumper settings and connections or contact with your retailer for assistance.

Beep	Meaning
One short beep when displaying logo	No error during POST
Long beeps in an endless loop	No DRAM installed or detected
One long beep followed by three short beeps	Video card not found or video card memory bad
High frequency beeps when system is working	CPU overheated System running at a lower frequency

NOTE:

1. During system power-on (system post), press key to enter BIOS setup. Follow the instructions in BIOS SETUP.
2. If you wish to boot from a different bootable device other than the default arrangement under the BIOS, you may press <F11> key during the system power-on (system post); a menu with all detected bootable devices which are attached to the system will be displayed. Then you may select the desired first bootable device from this menu.
3. **Power off your computer:** You must first exit or shut down your operating system before switch off the power switch. If you use Windows Operating Systems, click “**Start**” button, click “**Shut down**” and then click “**Shut down the computer**” The power supply should turn off after windows shut down.

Chapter 3: BIOS Setup

3.1 BIOS Flash Related Procedure

1. **After the BIOS is flashed, shut down the system.**
2. **Disconnect all power connections from power supply to the mainboard.**
3. **Clear the CMOS (For at least 30 seconds).**
4. **Reconnect all power connections from power supply to the mainboard.**
5. **When the system is booting at first time after the new BIOS is flashed, it is recommended to enter the BIOS; load the option “Load Optimized Defaults”, and then “Save and Exit Setup”.**



IF ANY OF THE ABOVE STEPS IS NOT FOLLOWED, IT MAY CAUSE THE FLASHED BIOS NOT FUNCTION PROPERLY.

3.2 Introducing BIOS

The BIOS is a program located on a Flash Memory on the motherboard. This program is a bridge between motherboard and operating system. When you start the computer, the BIOS program gains control. The BIOS first operates an auto-diagnostic test called POST (power on self test) for all the necessary hardware, it detects the entire hardware device and configures the parameters of the hardware synchronization. Only when these tasks are completed done it gives up control of the computer to operating system (OS). Since the BIOS is the only channel for hardware and software to communicate, it is the key factor for system stability, and in ensuring that your system performance as its best.

In the BIOS Setup main menu of Figure 3-1, you can see several options. We will explain these options step by step in the following pages of this chapter, but let us first see a short description of the function keys you may use here:

- Press <Esc> to quit the BIOS Setup.
- Press ↑↓←→ (up, down, left, right) to choose, in the main menu, the option you want to confirm or to modify.
- Press <F10> when you have completed the setup of BIOS parameters to save these parameters and to exit the BIOS Setup menu.
- Press Page Up/Page Down or +/- keys when you want to modify the BIOS parameters for the active option.

3.3 Entering BIOS Setup Menu

Power on the computer and by pressing immediately allows you to enter BIOS Setup Menu.

If you are not able to enter the BIOS menu but you still wish to enter Setup, restart the system to try again by turning it OFF then ON or pressing the "RESET" button on the system case. You may also restart by simultaneously pressing <Ctrl>, <Alt> and <Delete> keys.



The items under each BIOS category described in this chapter are under continuous update for better system performance. Therefore, the description may be slightly different from the latest BIOS and should be held for reference only.

3.4 Getting Help

Main Menu

The main menu lists the setup functions you can make changes to. You can use the arrow keys to select the item. The on-line description of the highlighted setup function is displayed at the bottom of the screen.

Sub- Menu

If you find a right pointer symbol (as shown in the picture below) appears to the left of certain fields that means a sub-menu can be launched from this field. A sub-menu contains additional options for a field parameter. You can use arrow keys to highlight the field and press <Enter> to call up the sub-menu. Then you can use the control keys to enter values and move from field to field within a sub-menu. If you want to return to the main menu, just press the <ESC>.

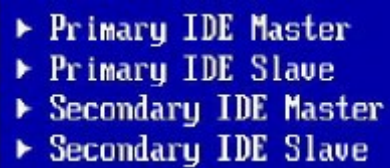

```
▶ Primary IDE Master
▶ Primary IDE Slave
▶ Secondary IDE Master
▶ Secondary IDE Slave
```

General Help <F1>

The BIOS setup program provides a General Help screen. You can call up this screen from any menu by simply pressing <F1>. The Help screen lists the appropriate keys to use and the possible selections for the highlighted item. Press <Esc> to exit the Help screen.

3.5 BIOS Menu Screen

When entering the BIOS, the following screen appears. The BIOS menu screen displays the items that allow user to make changes to the system configuration. To access the menu items, press the up/down/right/left arrow key on the keyboard until the desired item is highlighted, then press [Enter] to access the specific menu.

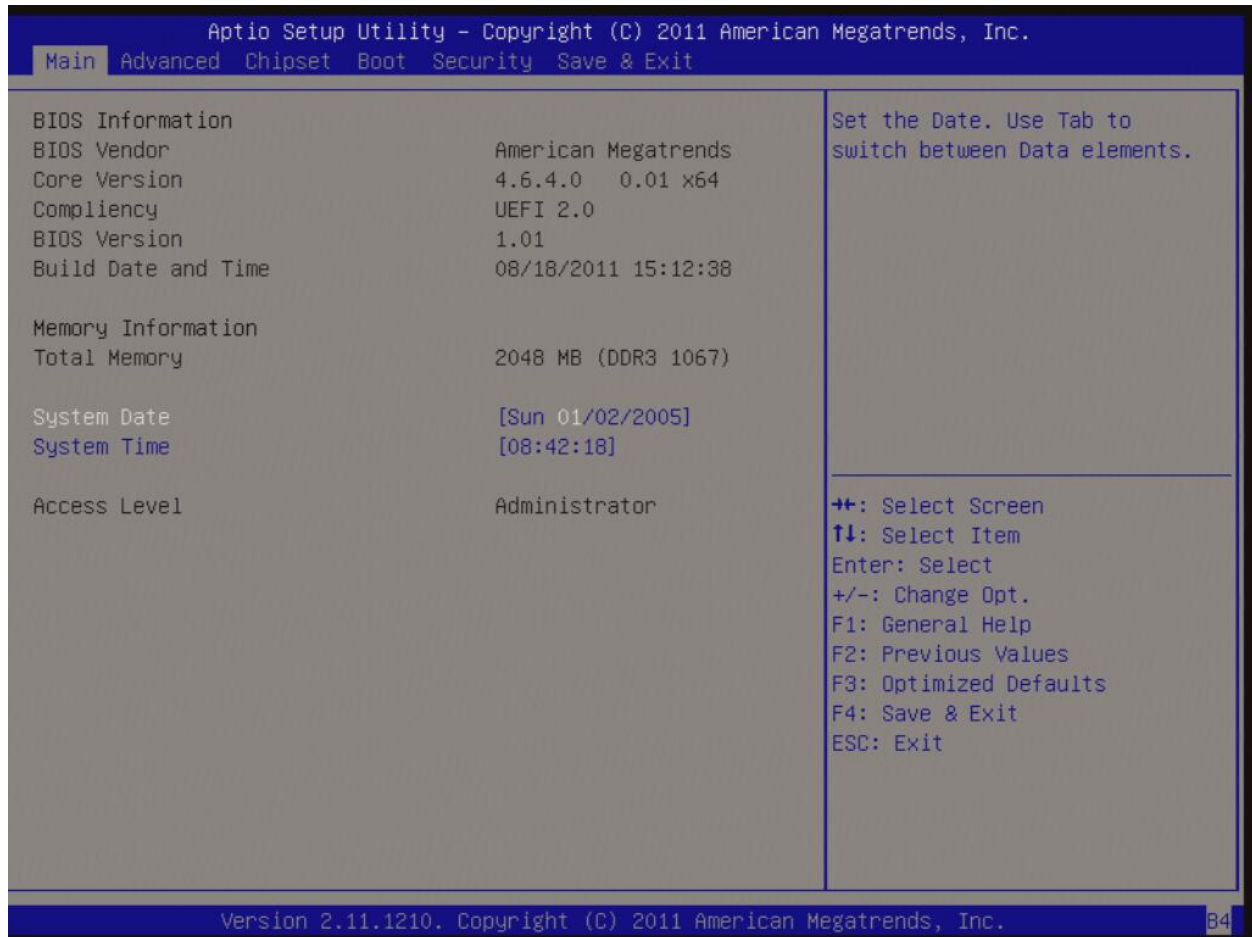

3.6 Main Menu

This menu gives user an overview of the general system specifications, such as time, date etc.

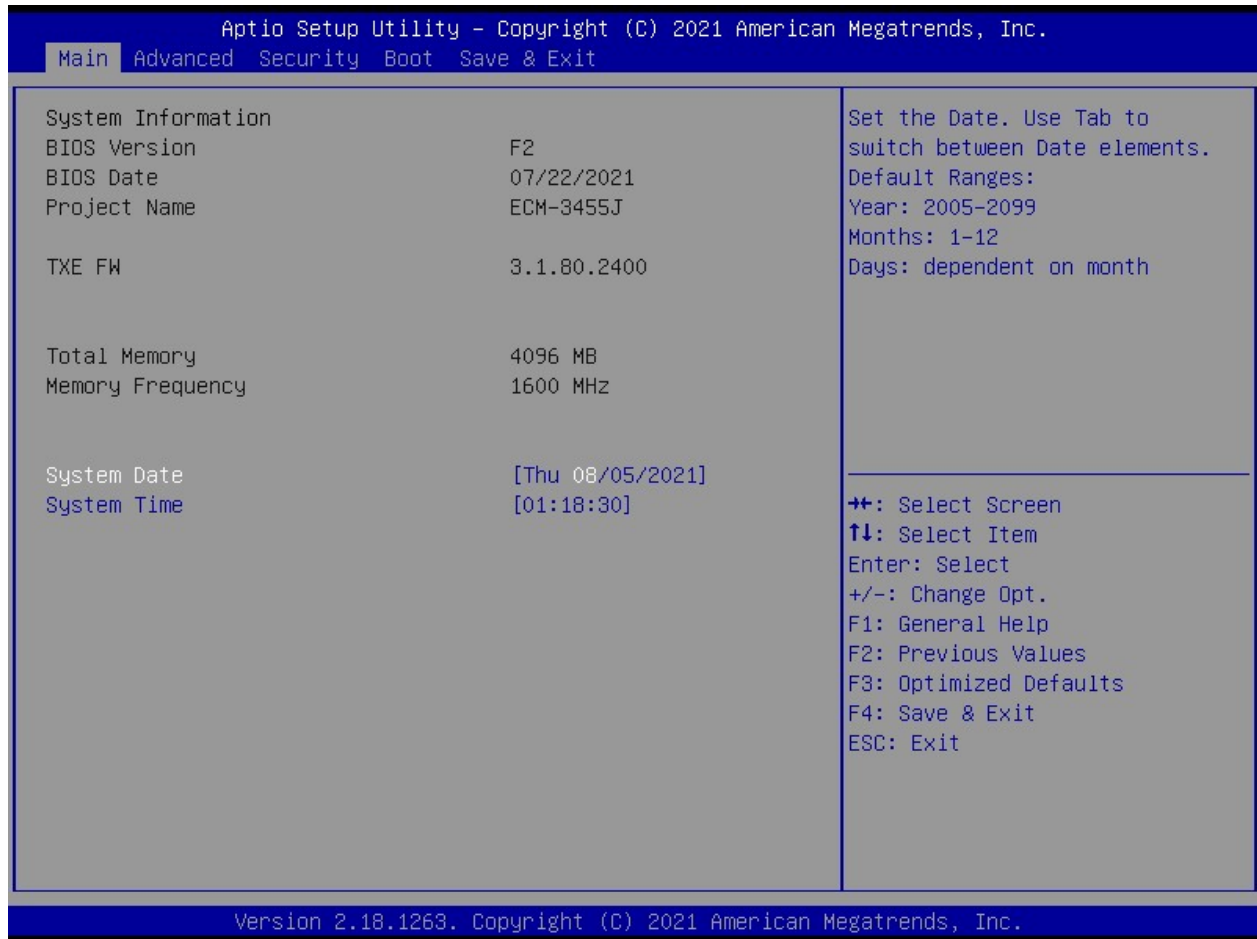

3.6.1 System Information

Displays the auto-detected BIOS information.

3.6.2 System Date

The date format is in <Day>,<Month>,<Year>.

3.6.3 System Time

The time format is in <Hour>,<Minute>,<Second>.

3.7 Advanced Menu

Select the “Advanced” tab from the BIOS menu screen to enter the Advanced BIOS Setup screen.



NOTE:
Take caution when change the settings of the Advanced menu items.
Incorrect field setting could cause the system not to function properly.

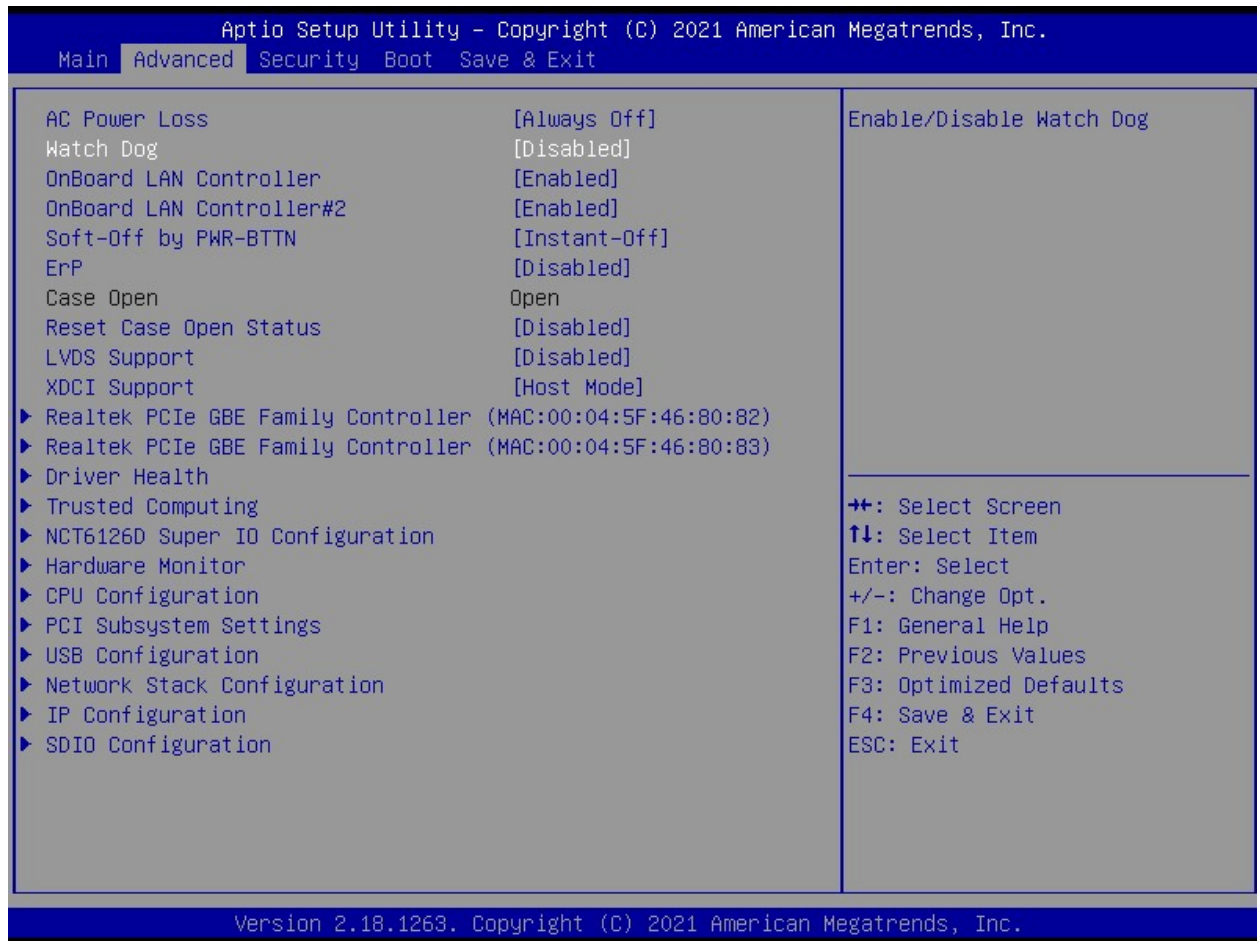

3.7.1 AC Power Loss

System's state after AC power loss.

Options:

Always Off = System stays off upon power return.

Always On = System turns on when power return.

Last State = System returns to last known awake state upon power return.

3.7.2 Watch Dog

Enable/ Disable Watch Dog Timer.

3.7.3 Onboard LAN Controller

Enable/ Disable onboard LAN Controller#1 (The one next to the USB3.0 ports).

3.7.4 Onboard LAN Controller#2

Enable/ Disable onboard LAN Controller#2 (The one next to the audio port).

3.7.5 Soft-Off by PWR-BTTN

Power Button soft-off control.

Options:

Instant Off: Press power button to power off system instantly.

Delay 4 Sec.: Press power button 4 sec to power off.

3.7.6 ErP

Configure the ErP mode configuration.

3.7.7 Reset Case Open Status

Select enable to clear the record of previous chassis intrusion status notifications.

3.7.8 LVDS Support

LVDS Support Enabled/ Disabled.

3.7.9 XDCI Support

When XDCI Support setting as "Device Mode", then the "F_USB2" header port 0 (the USB set on pin 2, 4, 6, 8, 10 only) will support Dual Role (OTG).

3.7.10 Realtek PCIe GBE Family Controller (MAC Address)

Information of LAN1 (the one next to rear IO USB3.0 port).

3.7.11 Realtek PCIe GBE Family Controller (MAC Address)

Information of LAN2 (the one next to rear IO audio port).

3.7.12 Trusted Computing

Trusted Computing Settings.

NOTE:

When “TPM Support” is enabled, it requires to save and exit BIOS once. And reboot the system in order to initiate the TPM support at BIOS.



CAUTION:

When TPM is enabled and utilized through TPM software under OS, there is a possibility that the encrypted data will not be accessible, or recoverable if one of the following situations occurred:

1. Lost of TPM password.
2. System or board failure, or being replaced.
3. Hard Drive failure.

3.7.13 NCT6126D Super IO Configuration

System Super IO chip parameters.

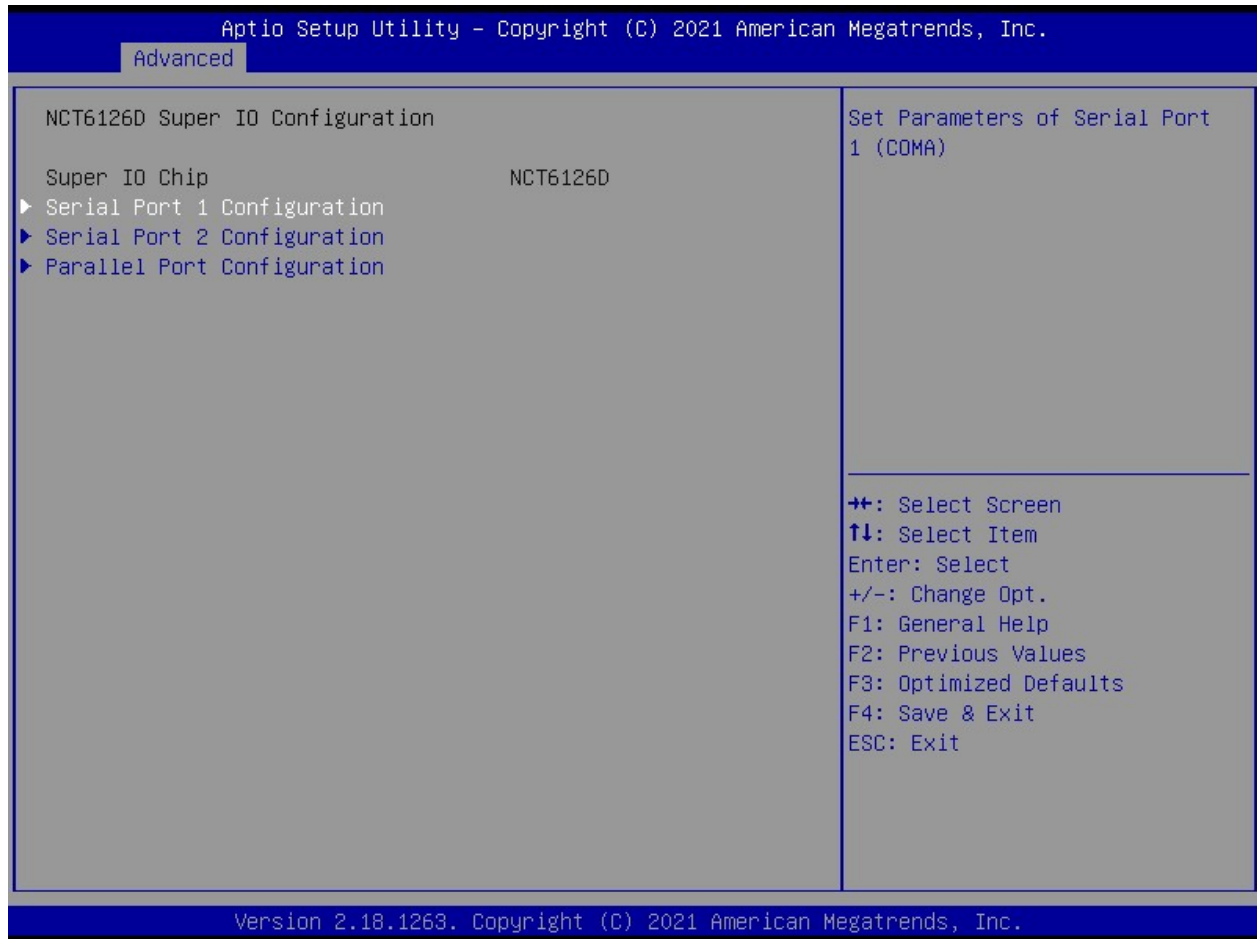

3.7.13.1 Serial port 1 Configuration

Set parameters of Serial Port 1 ("COMA" header).

3.7.13.2 Serial port 2 Configuration

Set parameters of Serial Port 2 ("COMB" header).

3.7.13.3 Parallel port Configuration

Set parameters of parallel Port ("LPT" header).

3.7.14 Hardware Monitor

Monitor hardware status.

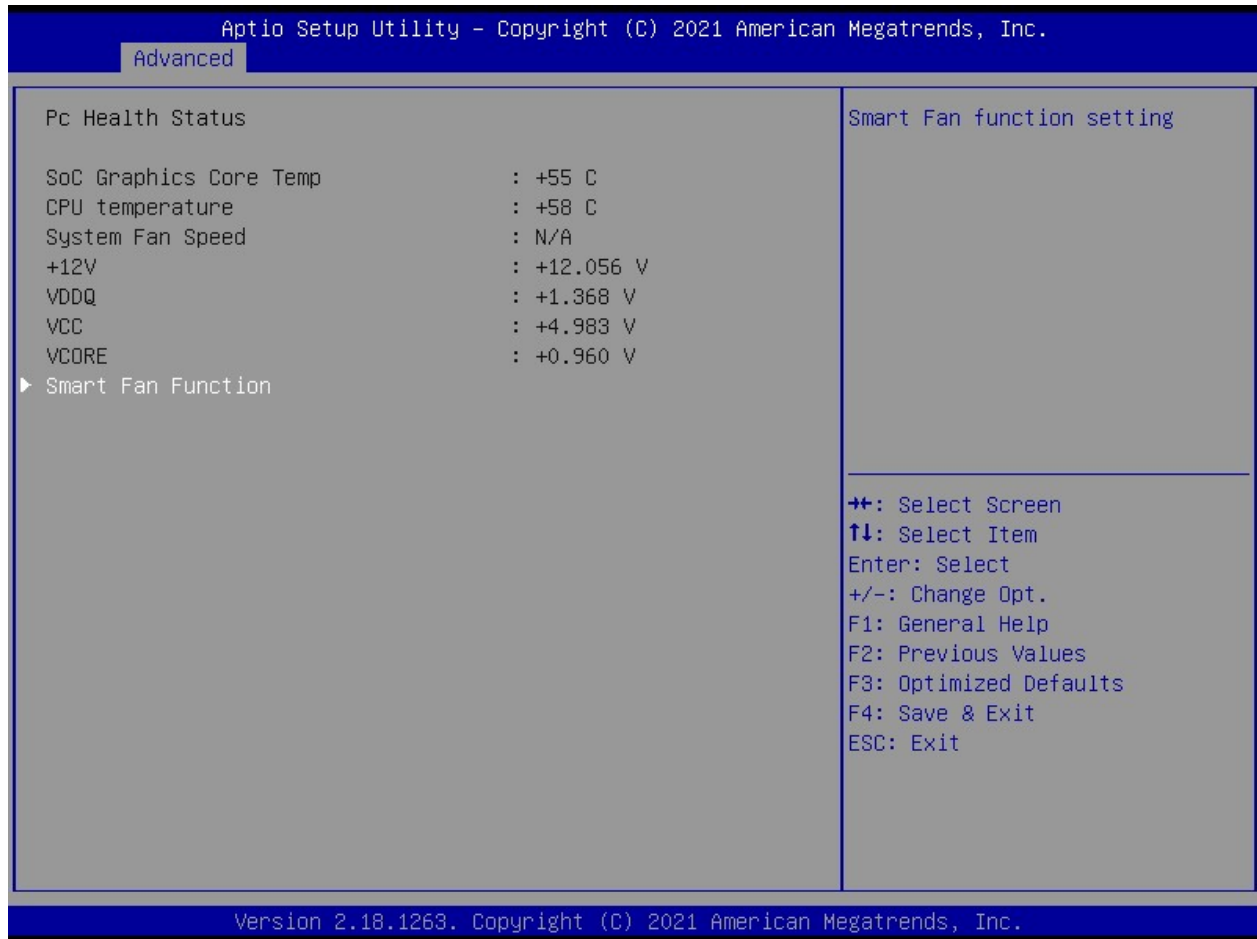

3.7.14.1 Smart Fan Function

Smart Fan setting for system fan header "SYS_FAN".

3.7.14.1.1 System Fan Mode: Manual Mode

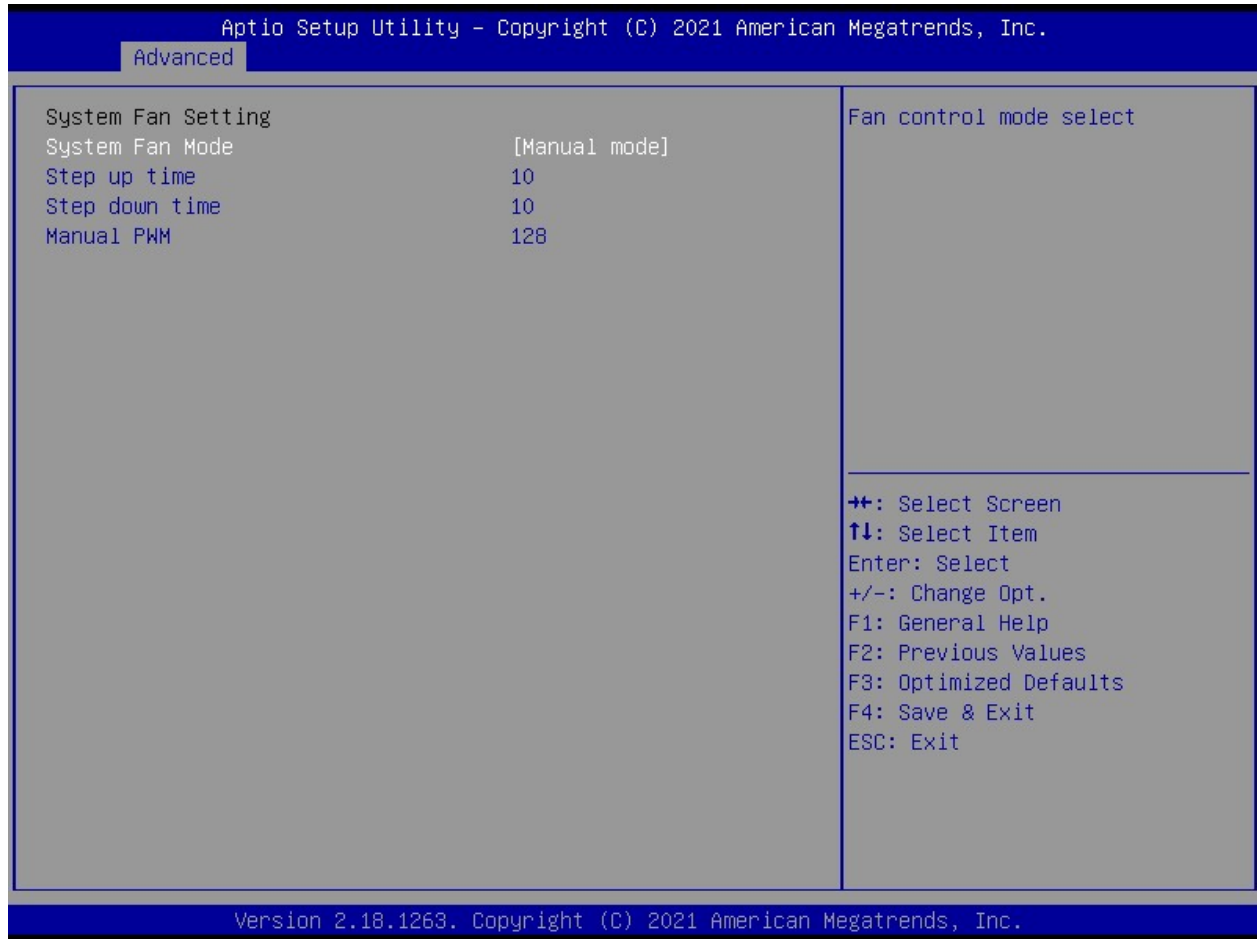

Step up time: The amount of time fan takes to increase its value by one step. (Units are intervals of 0.1 second). 10 x 0.1 sec = 1 sec as default.

Step down time: The amount of time fan takes to decrease its value by one step. (Units are intervals of 0.1 second). 10 x 0.1 sec = 1 sec as default.

Manual PWM: Fan will work with this manual PWM value (0~255 for 0% to 100%).

3.7.14.1.2 System Fan Mode: Thermal Cruise

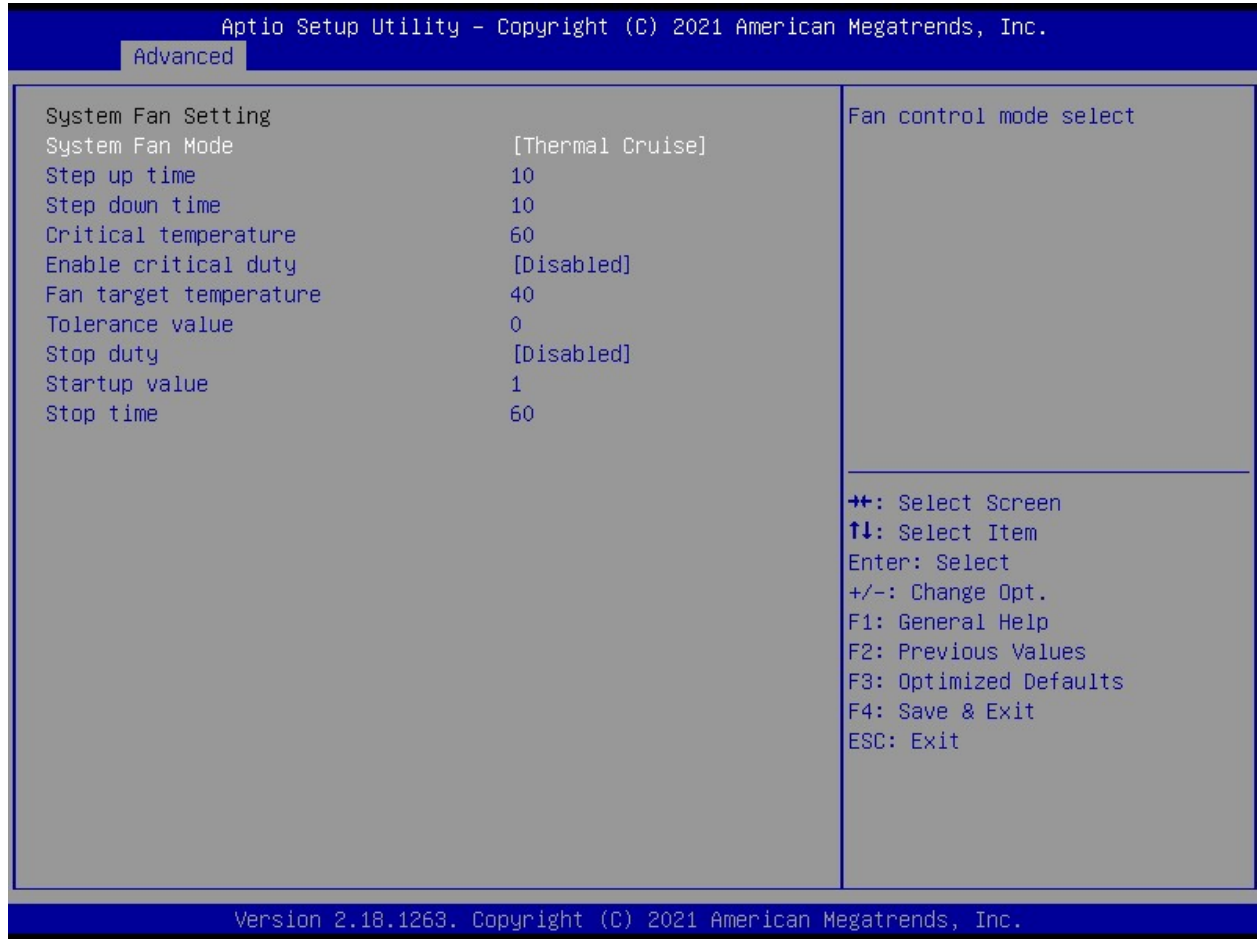

Step up time: The amount of time fan takes to increase its value by one step. (Units are intervals of 0.1 second). 10 x 0.1 sec = 1 sec as default.

Step down time: The amount of time fan takes to decrease its value by one step. (Units are intervals of 0.1 second). 10 x 0.1 sec = 1 sec as default.

The max and min value of “Fan target Temperature”, “tolerance value”, “stop duty”, “startup value” can be set from 0 to 127.

Thermal Cruise mode controls the fan speed to keep the temperature in a specified range. First, this range is defined in BIOS by a temperature and the interval (e.g., 55 °C ± 3 °C). As long as the current temperature remains below the low end of this range (i.e., 52 °C), the fan is off. Once the temperature exceeds the low end, the fan turns on at a speed defined in BIOS (e.g., 20% output). Thermal Cruise mode then controls the fan output according to the current temperature.

Three conditions may occur:

1. If the temperature still exceeds the high end, fan output increases slowly. If the fan is operating at full speed but the temperature still exceeds the high end, a warning message is issued to protect the system.
2. If the temperature falls below the high end (e.g. 58°C) but remains above the low end (e.g. 52 °C), fan output remains the same.
3. If the temperature falls below the low end (e.g., 52 °C), fan output decreases slowly to zero or to a specified "stop value".

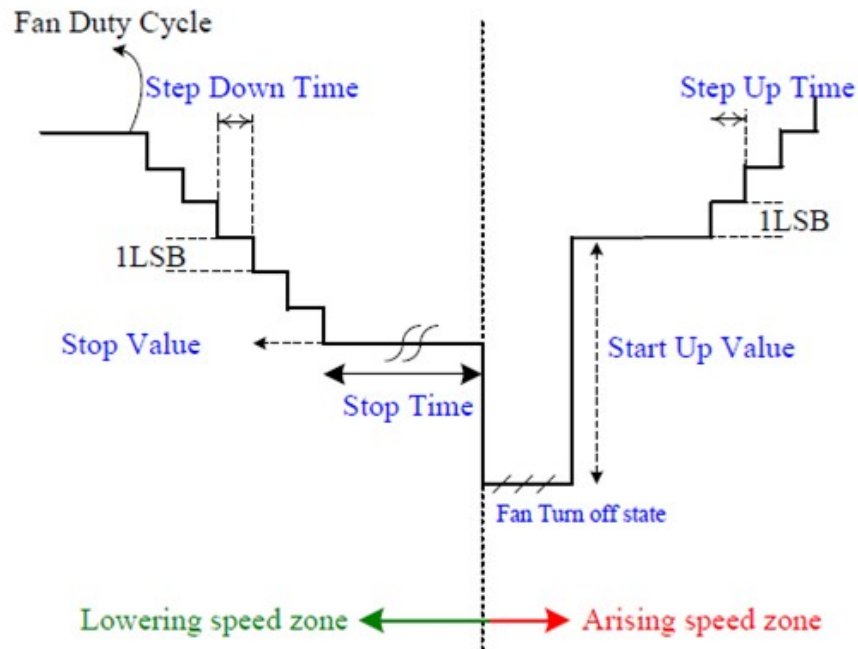

3.7.15 CPU Configuration

CPU Configuration Parameters.

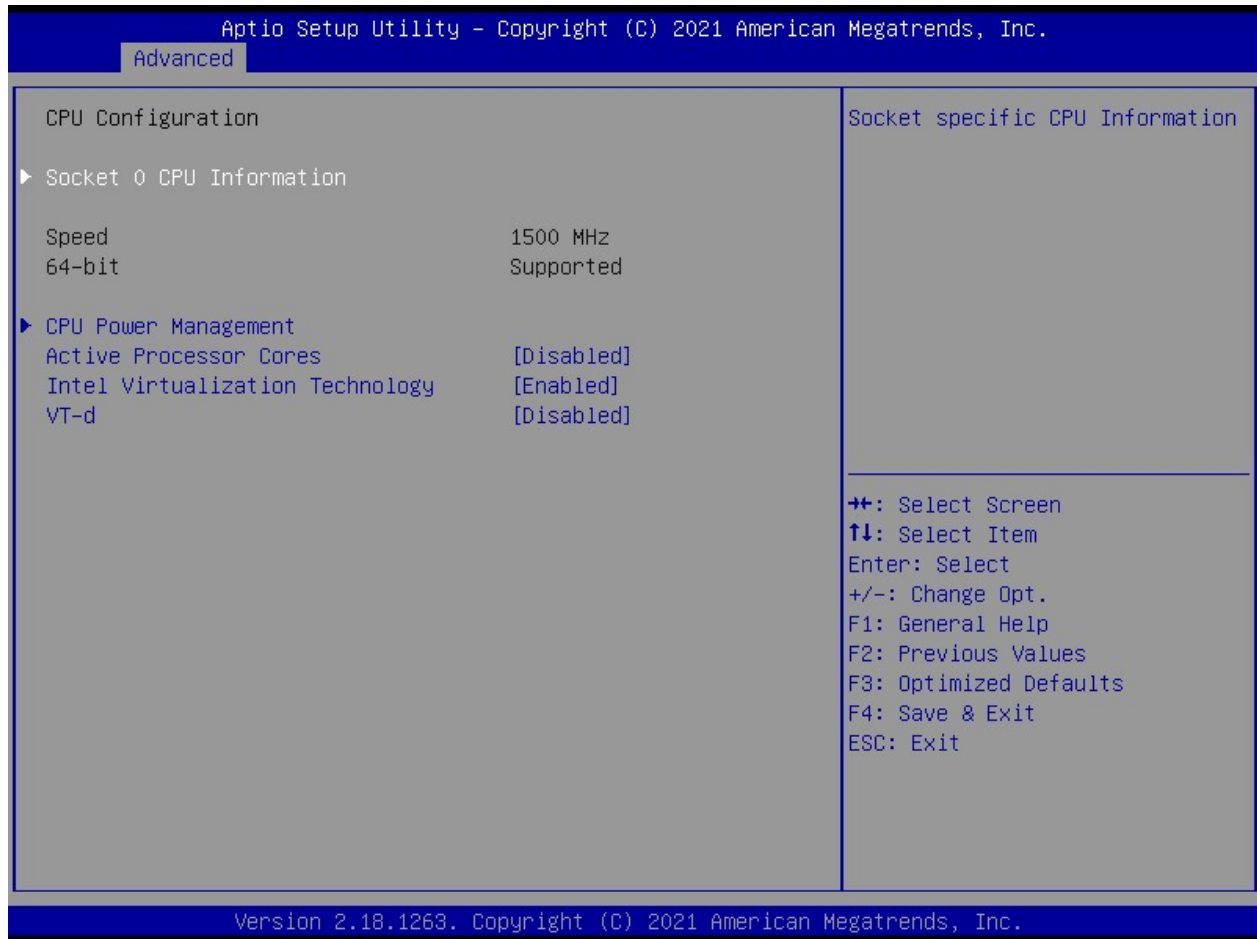

3.7.15.1 Socket 0 CPU Information

Socket specific CPU information.

3.7.15.2 CPU Power Management

CPU Power Management options.

3.7.15.2.1 EIST

Enable/ Disable Intel Speedstep.

3.7.15.2.2 Turbo Mode

Turbo mode enable/ disable.

3.7.15.2.3 C-States

Enable/ disable C states.

3.7.15.2.4 Enhanced C-States

Enable/ disable C1E. When enabled, CPU will switch to minimum speed when all cores enter C-State.

3.7.15.3 Active Processor Cores

Number of cores to enable in each processor package.

3.7.15.4 Intel Virtualization Technology

When enabled, a VMM can utilize the additional hardware capabilities provided by Vanderpool Technology.

3.7.15.5 VT-d

Enable/ disable CPU VT-d.

3.7.16 USB Configuration

USB Configuration parameters.

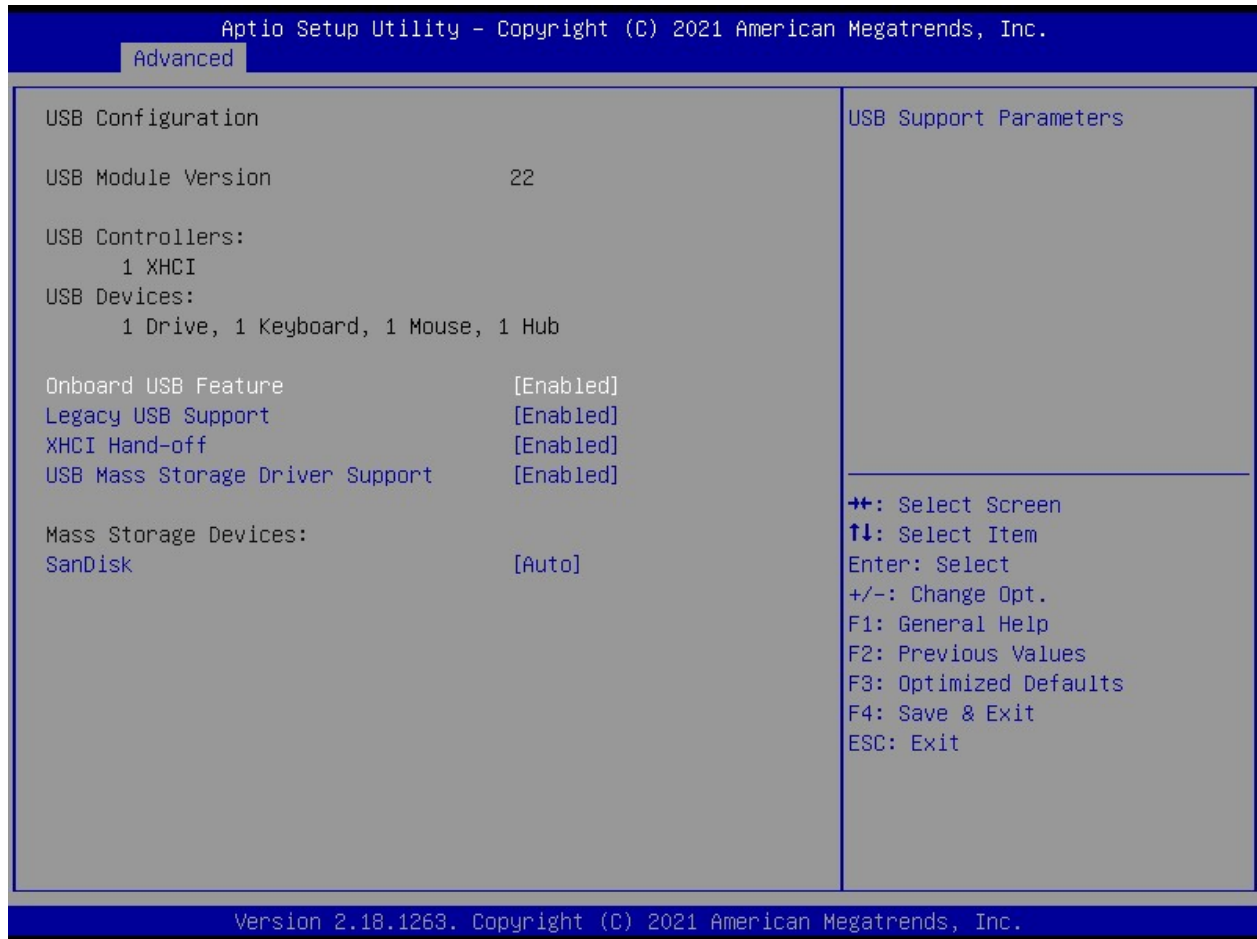

3.7.16.1 Onboard USB Feature

USB Support parameters.

3.7.16.2 Legacy USB Support

Enable Legacy USB support. Auto option disables legacy support if no USB devices are connected. Disable option will keep USB devices available only for EFI applications.

3.7.16.3 XHCI Hand-Off

This is a workaround for OSes without XHCI hand-off support. The XHCI ownership change should be claimed by XHCI driver.

3.7.16.4 USB Mass Storage Driver Support

Enable/ disable USB Mass Storage Driver Support.

3.7.17 Network Stack Configuration

Network Stack Settings.

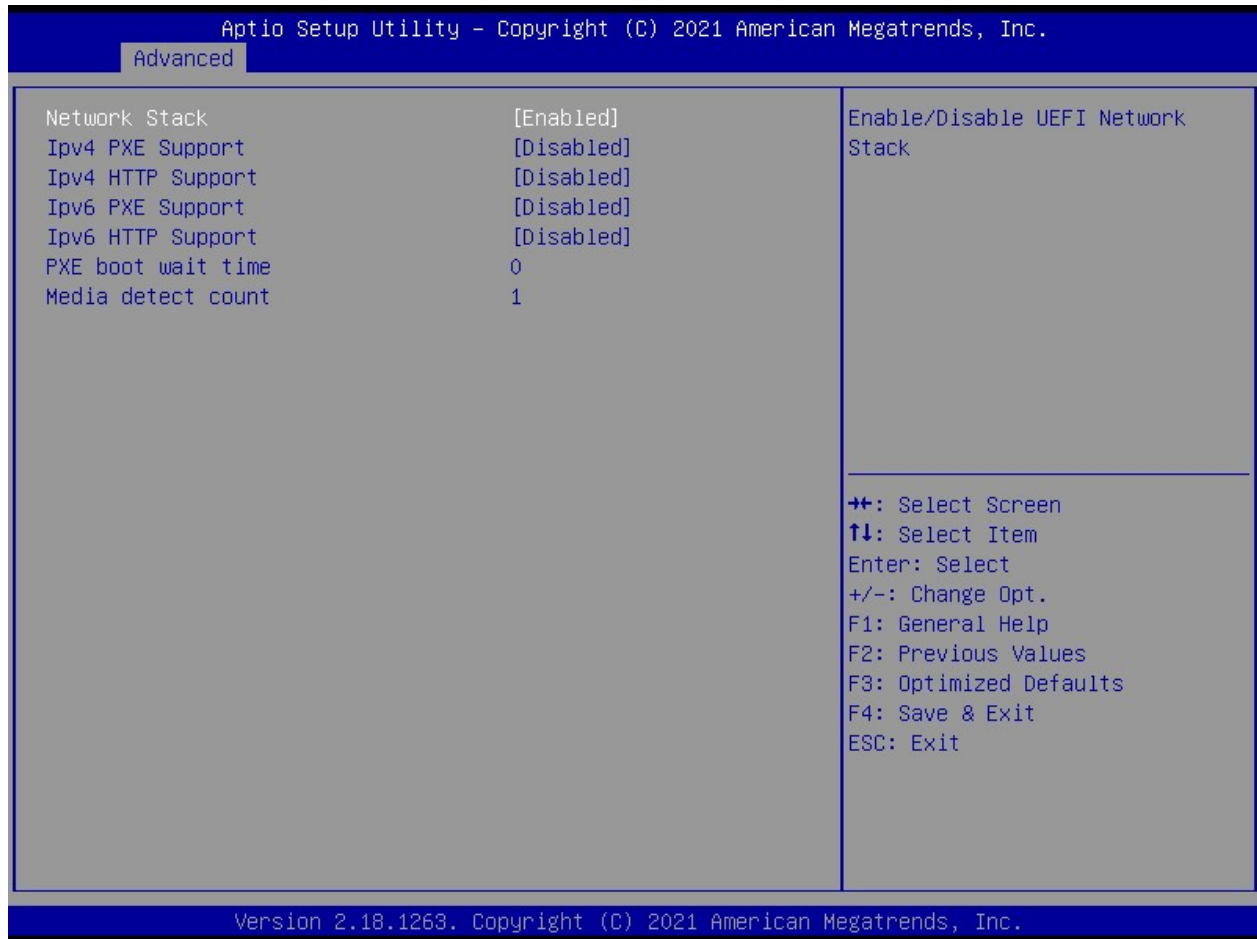

3.7.17.1 Network Stack

Enable/ disable UEFI Network Stack.

3.7.17.2 Ipv4 PXE Support

Enable Ipv4 PXE Boot Support. If disabled IPV4 PXE boot option will not be created.

3.7.17.3 Ipv4 HTTP Support

Enable Ipv4 HTTP Boot Support. If disabled IPV4 HTTP option will not be created.

3.7.17.4 Ipv6 PXE Support

Enable Ipv6 PXE Boot Support. If disabled IPV6 PXE boot option will not be created.

3.7.17.5 Ipv6 HTTP Support

Enable Ipv6 HTTP Boot Support. If disabled IPV6 HTTP option will not be created.

3.7.17.6 PXE boot wait time

Wait time too press ESC key to abort the PXE boot.

3.7.17.7 Media detect count

Number of times presence of media will be checked.

3.7.18 SDIO Configuration

SDIO Configuration parameters.

3.8 Security Menu

Set setup administrator/ user password or secure boot related settings.

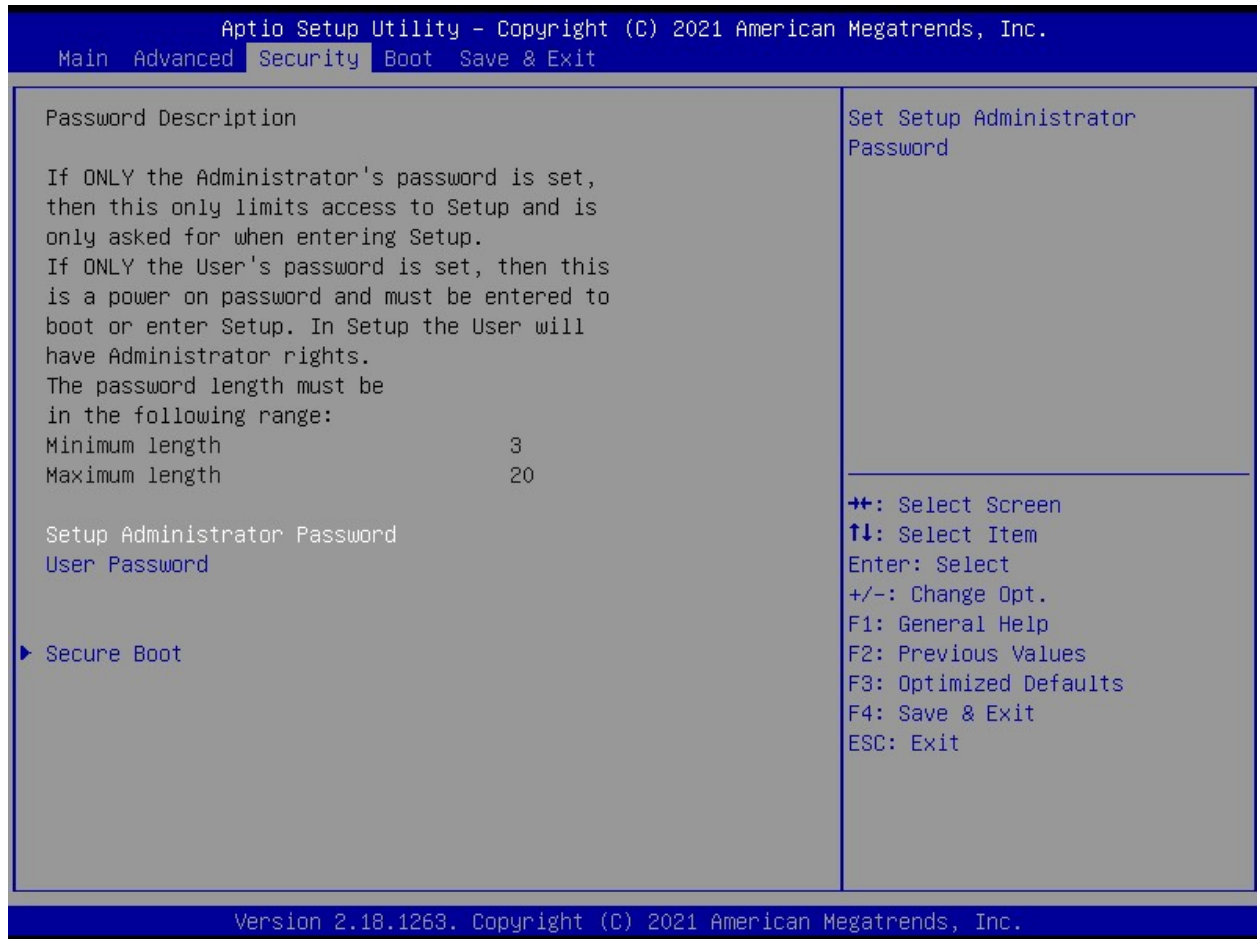

3.8.1 Setup Administrator Password

Setup Administrator Password.

If only the administrator's password is set, then this only limits access to BIOS menu and is only asked for when entering BIOS.

3.8.2 User Password

Set User Password.

If only the User's password is set, then this is a power on password and must be entered to boot or enter BIOS menu.

3.8.3 Secure Boot

Customizable Secure Boot settings.

Customer needs to provide the code to the board manufacture in order to insert the code to the BIOS. Customer also needs to embedded the corresponding key in their OS image.

3.9 Boot Menu

Set the system boot order.

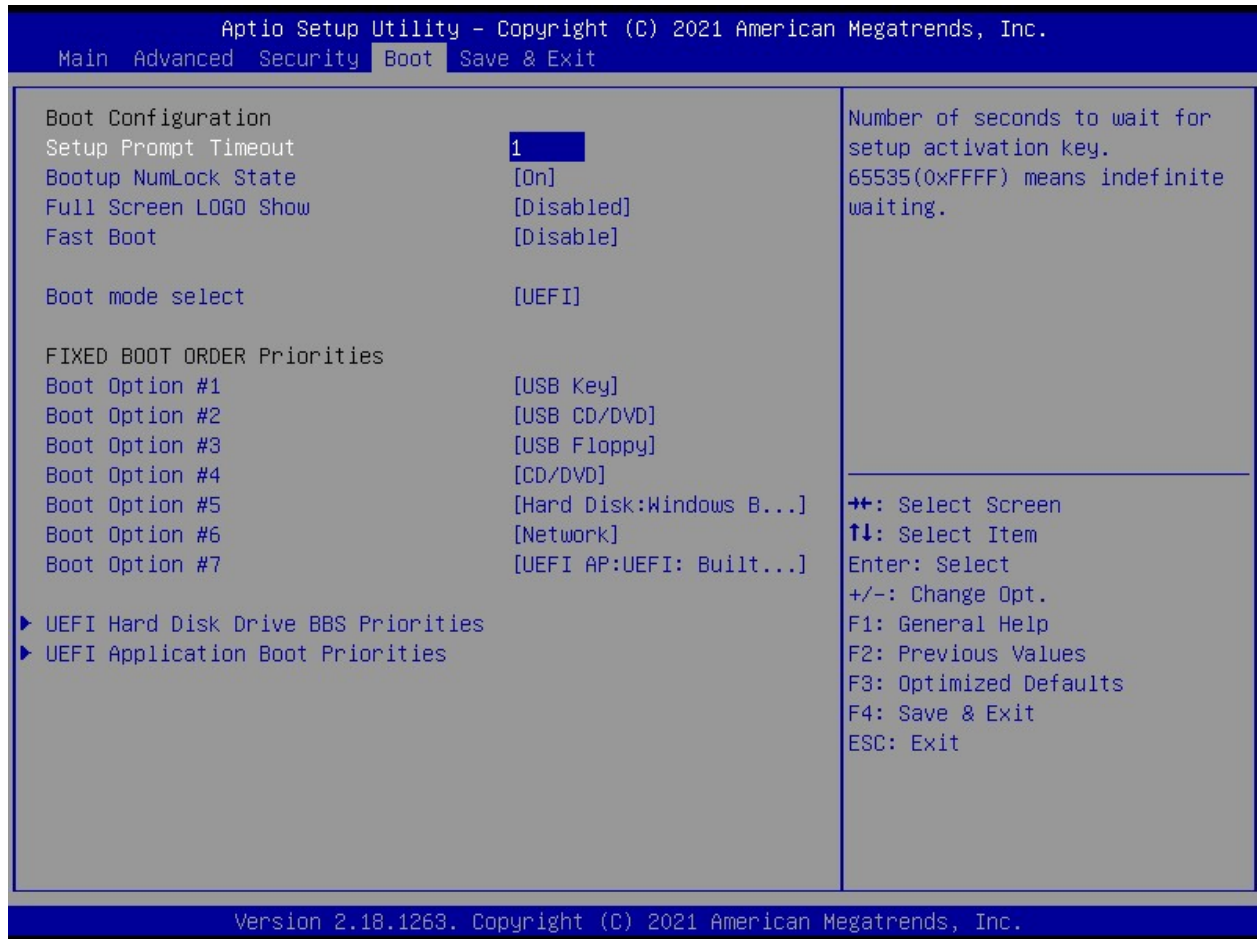

3.9.1 Setup Prompt Timeout

Number of second to wait for setup activation key.

3.9.2 Bootup NumLock State

Select the keyboard NumLock state.

3.9.3 Full Screen LOGO Show

Enable or disables Quiet Boot option.

3.9.4 Fast Boot

Enables or disables boot with initialization of a minimal set of devices required to launch active boot option. Has no effect for BBS boot options.

3.9.5 Boot mode select

Select boot mode in Legacy or UEFI (default).

NOTE:

If user needs to switch the boot mode between UEFI and Legacy; then user needs to select the desired boot mode first, then save and exit BIOS. The system needs to reboot once in order for the selected boot mode to take effect.

3.9.6 Fixed BOOT ORDER Priorities

Setup the boot priority of the system.

The following is the default boot priorities:

Boot Option #1: USB key (USB thumb drive)

Boot Option #2: USB CD/DVD

Boot Option #3: USB Floppy

Boot Option #4: CD/DVD (connected to SATA port)

Boot Option #5: Hard Disk (connected to SATA ports, or MSATA port)

Boot Option #6: Network

Boot Option #7: UEFI Shell (only available when boot mode is set in "UEFI" mode).

User can override the boot priorities manually by highlight the preferred boot option, and change the boot device. Then save and exit BIOS.

3.9.7 UEFI Hard Disk Drive BBS Priorities

Specifies the boot device priority sequence from available UEFI hard disk drives. In other words, if there are multiple hard disk drives installed at the system, user may set the hard disk drive boot priorities through this option.

3.9.8 UEFI Application Boot Priorities

Specifies the boot device priority sequence from available UEFI application

3.10 Save & Exit

Save and Exit BIOS settings.

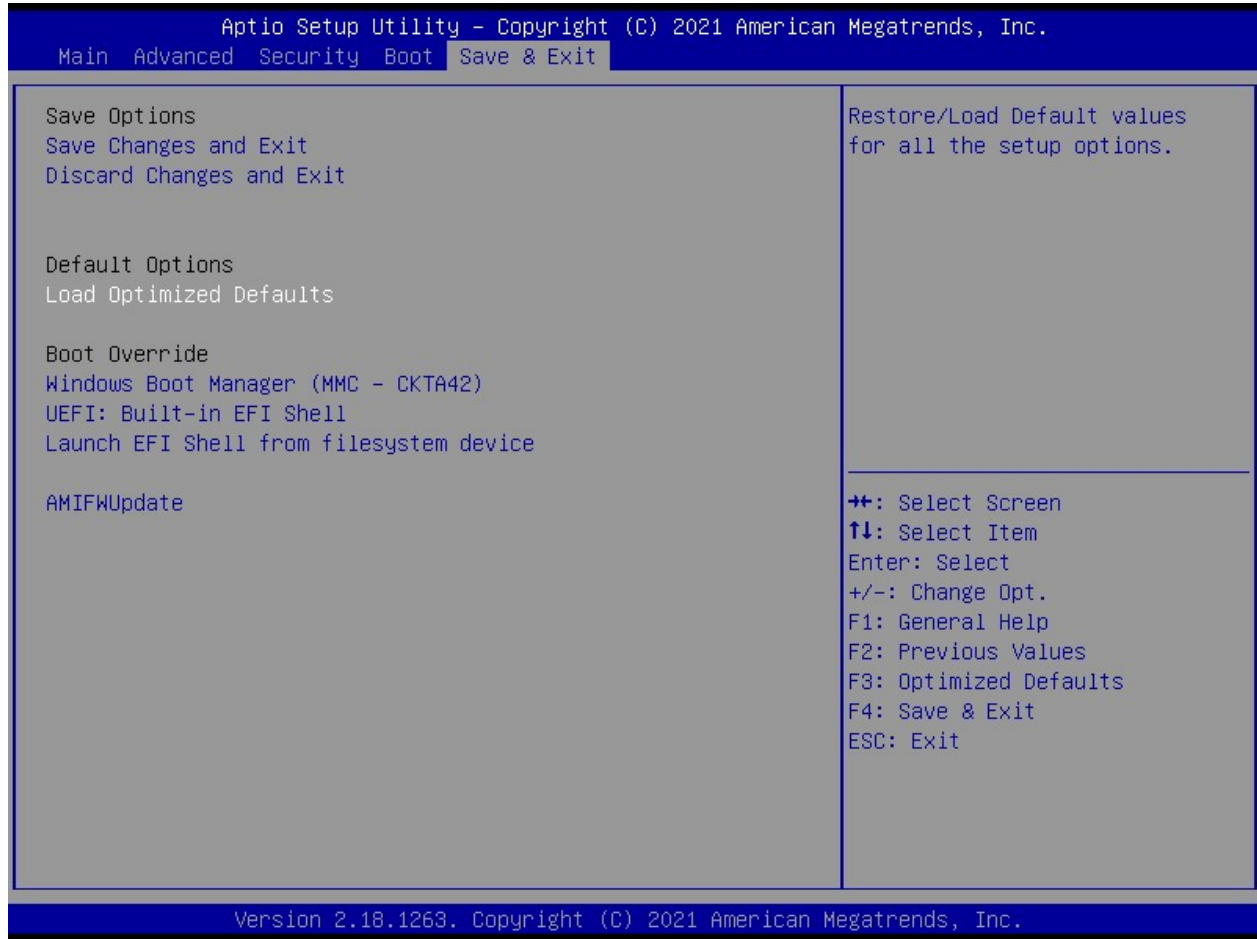

3.10.1 Save Changes and Exit

Exit system setup after saving the changes.

3.10.2 Discard Changes and Exit

Exit BIOS without saving any changes made.

3.10.3 Load Optimized Defaults

Automatically load optimal BIOS settings.

NOTE:

Loading this option is recommended after BIOS update. Then save and exit BIOS.

3.10.4 Boot Override

Choose the desired boot device to be the first boot device at next reboot.

NOTE:

This function will only function once after rebooted. If user prefers to set the boot device boot order permanently, then the change will need to be made under "Boot"-> "Fixed Boot Order Priorities" menu.

3.10.5 AMIFWUpdate

User may use this utility to update BIOS by selecting the desired BIOS file.

Chapter 4: Application Note

Please read the following application notes before proceed with the system setup and/or OS installation:

4.1 Windows 10 Drivers Installation

It is recommended to load the ECM-3455J drivers with following sequence:

1. Install "Intel INF Driver".
2. Install "Intel Video Driver".
3. Install "Realtek LAN Driver".
4. Install "Realtek Audio Driver".
5. Install "Intel TXE Driver".
6. Install "Intel Serial IO Driver".
7. Make sure there is no exclamation mark shown for any device under Windows "Device Manager".

NOTE:

1. If any of the driver listed above can't be installed, you may update Win10 to the latest version through Windows Update by connecting ethernet cable to one of two ECM-3455J onboard LANs.
2. If the Intel video driver is installed, and the video installer shows again after the system reboot, just close it.
3. Win10 user may download "Intel Graphics Command Center" app from MS Store in order to access the Intel video settings directly.

4.2 Boot Mode

The default boot mode is set as "UEFI". If you want to switch the boot mode to "Legacy", it can be changed through BIOS option "Boot"->"Boot Mode Select". Then save and exit BIOS once in order for the new boot mode to take effect.

4.3 Video Support

1. Under UEFI boot mode: The HDMI and LVDS will provide video signal simultaneously.
2. Under Legacy boot mode: Only either HDMI (default) or LVDS provides video signal. (if LVDS panel is attached, please disconnect the HDMI monitor connection to ECM-3455J board in order for the video signal to be switched to the LVDS panel).

4.4 Dual Role (OTG) Support

The "Port 0" of "F_USB2" header (the USB port pin 2, 4, 6, 8, 10, right next to the SATA header) can support Dual Role when:

1. Set the BIOS option "Advanced"->"XDCI Support" to "Device Mode", then save and exit BIOS.

NOTE:

1. Dual Role is recommended to be used under Android or Linux OS with its own Dual Role driver support.
2. Win10 doesn't provide Dual Role driver support.

4.5 eDP Support (Available with ECM-3455J eDP version ONLY)

For eDP version of ECM-3455J:

1. Connect the eDP panel signal cable to "LVDS" header.
2. Connect the backlight control cable to "BACKLIGHT" header.
3. There is no eDP BIOS related setting required.

4.6 PXE Boot

4.6.1 In “UEFI” mode:

1. Under BIOS option “Boot”->”Boot mode select”; change it to “UEFI”.
2. Under BIOS option “Advance”->”Network Stack Configuration”:
 - a. Change “Network Stack” to “Enabled”.
 - b. Enable “Ipv4 PXE Support”.
3. Save and exit BIOS.
4. After system reboot, enter BIOS again.
5. Under BIOS option “Boot”->”UEFI NETWORK Drive BBS Priorities”, set the desired PXE LAN port as “Boot Option #1”.

NOTE:

- a. LAN1 (the one next to USB ports) is described as “PXE iP4 Realtek PCIe GBE Family Controller (LAN1)” under BIOS “UEFI NETWORK Drive BBS Priorities” list.
- b. LAN2 (the one next to audio port) is described as “PXE iP4 Realtek PCIe GBE Family Controller (LAN2)” under BIOS “UEFI NETWORK Drive BBS Priorities” list.)

6. Press “ESC” key to get back to “Boot” menu.
7. Under BIOS option “Boot”->”Boot Option #1”; change the 1st boot device to the desired PXE LAN that selected under step 5.
8. Save and Exit BIOS.
9. The system will be prompted with message “Check media presence....” and establish link with PXE server.

4.6.2 In “Legacy” mode:

1. Under BIOS option “Boot”->”Boot mode select”; change it to “Legacy”.
2. Save and exit BIOS.
3. After system reboot, enter BIOS again.
4. Under BIOS option “Boot”->”NETWORK Drive BBS Priorities”, set the desired PXE LAN port as “Boot Option #1”.

NOTE:

- a. LAN1 (the one next to USB ports) is described as “Realtek PXE B02 D00” under BIOS “NETWORK Drive BBS Priorities” list.
- b. LAN2 (the one next to audio port) is described as “Realtek PXE B03 D00” under BIOS “NETWORK Drive BBS Priorities” list.

5. Press “ESC” key to get back to “Boot” menu.
6. Under BIOS option “Boot”->”Boot Option #1”; change the 1st boot device to the desired PXE LAN that selected under step 4.
7. Save and Exit BIOS.
8. The system will be prompted with PCIe version and establish link with PXE server.

4.7 The “SPEAKER” Header

The “SPEAKER” header supports 4 ohms/ 2W speaker.

4.8 The MIC support under Win10

The rear audio port supports “headset” (the headphone with lineout + microphone) with 3 black rings (OMTP or CTIA types).

Here is the installation procedure for MIC support under Win10 environment:

1. Install BCM provided ECM-3455J specific Realtek Win10 audio driver.
2. When the headset is plug-in to ECM-3455J rear audio port; the system will be prompted for the selection of “Headset” or “Headphone”, Please select “Headset” ONLY.
3. The Realtek HD Audio Manager will be prompted and displays the “Microphone” icon. The microphone on the plugged-in headset is ready to use.