

5" Rugged Handheld Computer

Qualcomm® Snapdragon™ 660, Octa-core up to 2.2 GHz
Android 9.0



User Guide

Document Version 1.4

Document Part No. 9152050K1001

Please read these instructions carefully before using this product, and save this manual for future use.

Contents

Preface	4
Advisory Conventions.....	4
Safety Information	5
Handling and Maintenance.....	7
Declaration of Conformity (DoC).....	8
About This User Guide	9
Chapter 1: Getting Started	10
1.1 Introduction	11
1.2 Product Features.....	11
1.3 Unpacking	11
1.4 Description of Parts	12
1.5 Dimensions	14
1.6 Getting Started	15
1.6.1 SIM Card Installation	15
1.6.2 Charging the Battery.....	16
1.7 Turning On and Off the Device	17
1.7.1 Turning On	17
1.7.2 Turning Off	17
1.8 Resetting to Factory Defaults	18
Chapter 2: Using the Rugged Handheld Computer	19
2.1 Using the Touch Screen	20
2.2 Waking Up the Rugged Handheld Computer.....	21
2.3 Using the Home Screen	21
2.3.1 Personalizing Home Screen	22
2.3.2 Viewing Other Parts of the Home Screen	24
2.4 Status and Notification Icons	25
2.4.1 Notification Icons	25
2.4.2 Status Icons.....	25
2.5 Using the On-Screen Keyboard.....	26
2.5.1 Entering Text.....	26
2.5.2 Editing Text	27
2.6 Display Settings.....	28
2.7 Audio Profile Settings	29
2.7.1 Sound Settings	29
2.7.2 Adjusting Volume	29
2.8 Language and Keyboard Settings	30
2.8.1 Changing the Keyboard Language	31
2.9 About Phone	32
Chapter 3: Winmate Home Manager	33
3.1 How to Lock Applications	34
3.2 How to Unlock Applications	36
3.3 How to Change Password	38
Chapter 4: Networks and Wireless Devices	39
4.1 Connecting to Mobile Networks	40
4.1.1 Checking the Network (GPRS/3G/4G) Connection	40
4.1.2 Turning on Data Service.....	40
4.2 Connecting to WLAN Networks	40

4.2.1 Turning on WLAN and Connecting to WLAN Networks	40
4.2.2 Adding WLAN Network.....	41
4.3 Connecting to BT. Devices	42
4.3.1 Turning BT On or Off	42
4.3.2 Connecting to BT. Device	42
4.3.3 Disconnecting BT. Device.....	43
4.4 Connecting to Computer via USB	43
4.4.1 USB Computer Connection	44
4.4.2 USB Debugging Settings.....	45
Chapter 5: Using Camera.....	46
5.1 Capturing Photos or Video	47
5.1.1 Opening Camera	47
5.1.2 Taking Pictures.....	47
5.1.3 Viewing pictures	47
5.1.4 Shooting Videos	48
5.2 The Gallery.....	48
Chapter 6: Accessories.....	49
6.1 Accessories List	50
Appendix.....	51
Appendix A: Product Specifications.....	52
Appendix B: Software Development Kit.....	53
Appendix C: OS Image Update	54
Appendix D: OTA Online Update.....	55

Preface

Advisory Conventions

Four types of advisories are used throughout the user manual to provide helpful information or to alert you to the potential for hardware damage or personal injury. These are Notes, Important, Cautions, and Warnings. The following is an example of each type of advisory.

**Note:**

A note is used to emphasize helpful information.



Important: An important note indicates information that is important for you to know.



Caution A Caution alert indicates potential damage to hardware and explains how to avoid the potential problem.

Attention Une alerte d'attention indique un dommage possible à l'équipement et explique comment éviter le problème potentiel.



Warning! An Electrical Shock Warning indicates the potential harm from electrical hazards and how to avoid the potential problem.

Avertissement! Un Avertissement de Choc Électrique indique le potentiel de chocs sur des emplacements électriques et comment éviter ces problèmes.

Safety Information



Precaution on Battery Pack *Précaution avec le bloc-pile*

Do Not Disassemble, Modify, or Insert Sharp Objects Into the Battery Pack. Electrolyte leakage, generation of heat, ignition or rupture may result.

[FR] Ne pas démonter, modifier, ou insérer des objets pointus à l'intérieur du bloc-pile. Une fuite d'électrolyte, la génération de chaleur, l'amorçage ou la rupture peuvent être occasionnés.

Do Not Short the Positive (+) and Negative (-) Terminals of the Battery. Generation of heat, ignition or rupture may result. When carrying or storing the device, do not place the battery pack together with articles that may contact electricity.

[FR] Ne pas court-circuiter les bornes Positive (+) et Négative (-) de la pile, la génération de chaleur, l'amorçage ou la rupture peuvent être occasionnés. Lors du transport et du rangement de l'appareil, ne pas placer le bloc-pile en même temps que des articles pouvant créer un contact électrique.

Do Not Apply Shocks to the Battery by Dropping It or Applying Strong Pressure to It. Electrolyte leakage, generation of heat, ignition or rupture of battery may occurs.

[FR] Ne pas faire subir de choc à la pile en la laissant tomber ou en appliquant une forte pression dessus. Une fuite d'électrolyte, la génération de chaleur, l'amorçage ou la rupture peuvent être occasionnés.

Do Not Charge the Battery Other Than Methods Those Specified In This Manual. If the battery is not charged using one of the specified methods, electrolyte leakage, generation of heat, ignition or rupture may result.

[FR] Ne pas charger la pile par d'autres méthodes que celles spécifiées dans ce manuel. Si la pile n'est pas chargée en utilisant l'une des méthodes spécifiées, une fuite d'électrolyte, la génération de chaleur, l'amorçage ou la rupture peuvent être occasionnés.

When the Battery Pack Has Deteriorated, Replace It with a New Battery. Continued use of a damaged battery pack may result in heat generation, ignition or battery rupture.

[FR] Lorsque la pile est détériorée, la remplacer par une nouvelle pile. L'utilisation continue d'une pile endommagée peut occasionner une génération de chaleur, l'amorçage ou la rupture de la pile.

Do Not Expose the Battery Pack to Excessive Heat, or Extreme Heat (Near Fire, in Direct Sunlight for example) Generation of heat, ignition or rupture may result

[FR] Ne pas exposer le bloc-pile à une Chaleur Excessive, ou une Chaleur Extrême (Près d'un feu, sous la lumière du soleil par exemple) Une production de chaleur, l'amorçage ou la rupture peuvent être occasionnés

Do Not Use the Battery Pack With Any Other Products. The battery pack is rechargeable and is only designed for this specific product. If it is used with a product other than the specified product, electrolyte leakage, generation of heat, ignition or rupture may result.

[FR] Ne pas utiliser avec un autre produit La batterie est rechargeable et a été conçue pour un produit spécifique. Si elle est utilisée sur un produit différent de celui pour lequel elle a été conçue, des pertes d'électrolytes et une production de chaleur sont possibles, elle risque également de prendre feu ou de casser.

Do Not Use This Product With Battery Other Than the One Specified.

[FR] Ne pas utiliser ce produit avec une batterie autre que celle spécifiée

Discontinue using device immediately if you notice the battery is swelling, or looks puffy or misshapen. Do not attempt to charge or use the device. Do not handle a damaged or leaking battery. Do not let leaking battery fluid come into contact with your eyes, skin or clothing.

[FR] Si vous remarquez une pile gonflée, élargie ou anormale, cesser l'utilisation de l'appareil immédiatement. N'essayez pas de recharger l'appareil ou de l'utiliser. Ne pas manipuler une pile qui fuit ou qui est endommagée. Ne laissez pas de liquide qui fuit entrer en contact avec vos yeux, votre peau ou vos vêtements.



General Product Safety
Sécurité générale des produits

- Do not block any ventilation openings. Do not place the product against a wall or in an enclosed space as doing so might impede the flow of cooling air.
 - *[FR] Ne pas bloquer les ouvertures de ventilation. Ne pas placer le produit contre un mur ou dans un espace clos de façon à entraver la circulation de l'air de refroidissement.*
- Do not place the product near any heat sources such as radiators, warm air intakes, stoves or other heat-generating devices (including amplifiers or other heat producing equipment).
 - *[FR] Ne pas placer le produit près d'une source de chaleur comme des radiateurs, les arrivées d'air chaud, poêles ou autres produits générant de la chaleur (y compris les amplificateurs ou autre équipement produisant de la chaleur.)*
- Protect the power cord from being crushed or pinched, particularly in the area of the plugs, any receptacles used, and the point of exit from the apparatus. Do not break off the ground pin of the power cord.
 - *[FR] Empêcher le cordon d'alimentation d'être écrasé ou pincé, en particulier dans les zones de prises, des containers utilisés, et du point de sortie de l'appareil. Ne pas casser la broche de terre du cordon d'alimentation.*
- Do not disregard the safety that a polarized or grounded connection can provide. A polarized connection consists of two plugs, one of which is larger than the other. A grounded connection has two blades and a third one that is grounded. If the main plug provided cannot be inserted into your outlet, consult an electrician to replace your obsolete outlet.
 - *[FR] Ne pas ignorer la sécurité qu'une prise polarisée ou une prise de terre peut prévoir. Une prise polarisée se compose de deux fiches, dont l'une est plus large que l'autre. Une prise de terre possède deux lames et une troisième qui est la terre. Si la fiche principale fournie ne peut être insérée dans votre prise, consultez un électricien pour remplacer votre prise obsolète.*

- Use only accessories specified by the manufacturer.
[FR] Utiliser uniquement les accessoires spécifiés par le fabricant.
- This product should not be used near water such as bathtubs, sinks, swimming pools, wet basement, etc.
[FR] Ce produit ne doit pas être utilisé près de l'eau comme les baignoires, les éviers, les piscines, les sous-sols humides, etc.
- Use only with its transport carriage, stand, tripod, console or table specified by the manufacturer or sold with the product. When using a carriage, move the carriage assembly with the product carefully to avoid damage from falling over.
 - *[FR] Utiliser uniquement avec son chariot de transport, support, trépied, console ou table spécifiés par le fabricant ou vendu avec le produit. Lors de l'utilisation d'un charriot, déplacez l'ensemble chariot avec le produit avec soin pour éviter tout dommage de chute.*
- Unplug this apparatus during lightning storms or when it is not being used for long periods.
 - *[FR] Débrancher cet appareil durant les orages ou lorsqu'il n'est pas utilisé pendant de longues périodes.*
- Refer all servicing to qualified service personnel. A technical intervention is required when the apparatus has been damaged in any way, for example if the power cord or plug is damaged, liquid has been spilled or objects have fallen inside the unit, if the product has been exposed to rain or moisture, if it does not operate normally or if it has been dropped.
 - *[FR] Confier toute réparation à du personnel qualifié. Une intervention technique est nécessaire lorsque l'appareil a été endommagé de quelque façon, par exemple si le cordon d'alimentation ou la fiche est endommagé, du liquide a été renversé ou des objets sont tombés à l'intérieur de l'unité, si le produit a été exposé à la pluie ou à l'humidité, s'il ne fonctionne pas normalement ou s'il a été jeté.*

Handling and Maintenance



General Guideline Guide Général

Keep the product at least 13 cm (5 inches) away from electrical appliances that can generate a strong magnetic field such as TV, refrigerator, motor, or a large audio speaker.
 [FR] Garder le produit au moins à 13 cm (5 pouces) de distance des appareils électriques qui peuvent générer un fort champ magnétique comme une télévision, un réfrigérateur, un moteur, ou un important haut-parleur.

Do not place heavy objects on top of the tablet computer as this may damage the display.
 [FR] Ne pas placer d'objets lourds sur le dessus de l'ordinateur tablette cela peut endommager l'écran.

The screen surface can be easily scratched. Use with care. Do not use paper towels to clean the display but use the included cleaning cloth. Avoid touching it with a pen or pencil.
 [FR] La surface de l'écran peut être facilement rayée. Utiliser avec précaution. Ne pas utiliser de serviette en papier pour nettoyer l'écran mais utiliser le chiffon de nettoyage inclus. Éviter de toucher avec un stylo ou un crayon.

To maximize the life of the backlight in the display, allow backlight to automatically turn off as a result of power management. Avoid using a screen saver or other software that prevents the power management from working.
 [FR] Pour maximiser la durée de vie du rétroéclairage de l'écran, autoriser le rétroéclairage résultant de la gestion de l'alimentation. Éviter d'utiliser un économiseur d'écran ou un autre logiciel empêchant la gestion de l'alimentation de fonctionner.



Cleaning Guideline Guide de nettoyage

Use a soft cloth moistened with water or a non-alkaline detergent to wipe the exterior of the product.
 [FR] Utiliser un chiffon doux humidifié avec de l'eau ou un détergeant non alcalin pour essuyer l'extérieur du produit.

Gently wipe the display with a soft, lint-free cloth. Do not use alcohol or detergent on the product.

[FR] Essuyer délicatement l'écran avec un chiffon doux non pelucheux. Ne pas utiliser d'alcool ou un détergent sur le produit.



Touchscreen Guideline Guide de l'écran tactile

Use your finger or the stylus on the display. Using sharp or metallic object may cause scratches and damage the display, thereby causing errors.

[FR] Utiliser votre doigt ou le stylet sur l'écran. L'utilisation d'un objet pointu ou métallique peut provoquer des rayures.

Use a soft cloth to remove dirt on the display. The touchscreen surface has a special protective coating that prevents dirt from sticking to it. Not using a soft cloth may cause damage to the special protective coating on the touchscreen surface. To clean off hard to remove dirt, blow some steam on the particular area and gently wipe away using a soft cloth.
 [FR] Utiliser un chiffon doux pour enlever la poussière sur l'écran. La surface de l'écran tactile a un revêtement protecteur spécial empêchant la saleté de se coller à lui. Ne pas utiliser un chiffon doux peut endommager le revêtement spécial sur la surface de l'écran tactile. Pour nettoyer les saletés plus difficiles à enlever, souffler de la buée sur la zone particulière et essuyer doucement avec un chiffon doux.

Do not use excessive force on the display. Avoid placing objects on top of the display as this may cause the glass to break.
 [FR] Ne pas utiliser une force excessive sur l'écran. Éviter de placer des objets au dessus de l'écran cela pourrait provoquer une cassure du verre.

When there is a noticeable discrepancy in the operation of the touchscreen function (your touch does not correlate to the proper location on the screen), recalibrate the touchscreen display.
 [FR] Lorsqu'il y a un écart sensible dans le fonctionnement de l'écran tactile (votre contact ne correspond pas à la bonne position sur l'écran), recalibrer l'écran tactile.

Declaration of Conformity (DoC)

FCC Statement

This device complies with part 15 FCC rules.



Operation is subject to the following two conditions:

- This device may not cause harmful interference.
- This device must accept any interference received including interference that may cause undesired operation

This equipment has been tested and found to comply with the limits for a class "B" digital device, pursuant to part 15 of the FCC rules. These limits are designed to provide reasonable protection against harmful interference when the equipment is operated in a commercial environment. This equipment generates, uses, and can radiate radio frequency energy and, if not installed and used in accordance with the instruction manual, may cause harmful interference to radio communications. Operation of this equipment in a residential area is likely to cause harmful interference in which case the user will be required to correct the interference at his own expense.

CE Notice (European Union)



Electromagnetic Compatibility Directive (2014/30/E.U.)

- EN55024: 2010/ A1: 2015
 - IEC61000-4-2: 2009
 - IEC61000-4-3: 2006+A1: 2007+A2: 2010
 - IEC61000-4-4: 2012
 - IEC61000-4-5: 2014
 - IEC61000-4-6: 2014
 - IEC61000-4-8: 2010
 - IEC61000-4-11: 2004
- EN55032: 2012/AC:2013
- EN61000-3-2:2014
- EN61000-3-3:2013

Low Voltage Directive (2014/35/E.U.)

- EN 60950-1:2006/A11:2009/A1:2010/A12:2011/ A2:2013

This equipment is in conformity with the requirement of the following EU legislations and harmonized standards. Product also complies with the Council directions.

About This User Guide

This User Guide provides information about using the Winmate® 5" Rugged Handheld Computer E500QK and its accessories.



Note: Some pictures in this guide are samples and can differ from actual product.

Documentation Set

The documentation set for the E500QK provides information for specific user needs, and includes:

- **E500QK Series Quick Start Guide** - describes how to get the E500QK up and running.
- **E500QK Series User Guide** – contains detailed description on how to use the E500QK, its components and features.

Chapter Descriptions

Chapter 1, Getting Started provides basic instructions on how to use E500QK, including SD card and battery installation, powering on and resetting E500QK.

Chapter 2, Using the Rugged Handheld Computer provides basic instructions on using the E500QK.

Chapter 3, Winmate Home Manager explains how to use WHM to lock the launcher.

Chapter 4, Network and Wireless Devices explains how to connect E500QK to networks, BT devices, and computer.

Chapter 5, Using Camera provides instructions on how to use camera on E500QK.

Chapter 6, Accessories describes the available accessories and how to use them with the E500QK.

Chapter 1: Getting Started

This chapter tells you information about Winmate® Rugged Handheld Computer E500QK Series, its highlighted features, and provides basic instructions for using the E500QK, including powering on and resetting the E500QK.

1.1 Introduction

Thank you for purchasing Winmate 5" Rugged Handheld Computer E500QK. Winmate E500QK is an enterprise-class rugged handheld computer with powerful Qualcomm® Snapdragon™ 660 mobile platform. The E500QK series rugged handheld computer brings a new level of flexibility, functionality and rugged design to pocket-sized mobile devices, providing task workers and managers with the power to streamline business processes, increasing productivity and improving customer service. The E500QK packs WLAN, WWAN, BT and GPS function—all into a single device. With great multiple wireless communicate design, this product will be applicable to mobile worker, business application, and IT requirements.

1.2 Product Features

Winate® 5" Rugged Handheld Computer E500QK features:

- Qualcomm® Snapdragon™ 660, Octa-core up to 2.2 GHz
- 5" 1280 x 720 Panel with Projective Capacitive Multi-touch
- Supports Android 9.0 OS
- IP67 waterproof and dustproof
- 19 buttons keypad including power key
- Built-in 8 Mega-pixel Camera at front side and 13 Mega-pixel Camera with LED. at rear side

1.3 Unpacking

If any of the following items are missing or damaged, contact us. Your package may include optional accessories based on your order.

Standard packing list includes:



- **E500QK Series Rugged Handheld Computer**



- **Quick Start Guide (Hardcopy)**

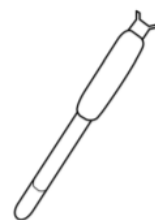

- **Hand Strap**

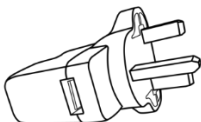

- **Universal USB Adapter**
Input: AC 100-240V 50/60 Hz,
Output: 5V-1A

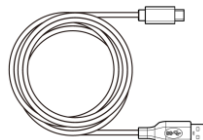

- **USB Type-C Cable**

Universal USB Adapter socket varies by country and region. E500QK will be shipped with the socket according to your order.

1.4 Description of Parts

Front View

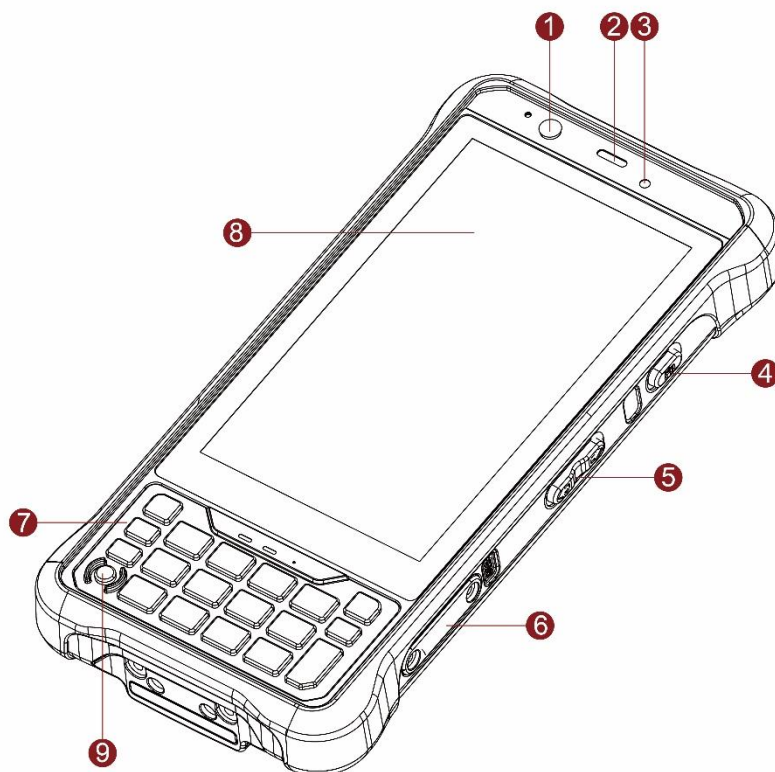

Parts Description:

No	Item	Description
1	8MP Front Camera	To capture a front view picture and use for Video call.
2	Receiver	Use to listen during a phone conversation.
3	LED Indicator	LED indicator indicates the battery power or charging status. Red: 0~89% Green: 90~100%
4	Function Key	If the device is equipped with scanners, this button could function as a trigger button.
5	Volume Up / Down	Increases or decreases the call volume when a call is in progress. In other applications, it controls the volume of the music.
6	Micro SIM card slot	Allows installing micro SIM card.
7	Physical Keypad	19 buttons keypad, including a power key.
8	5" Touch Screen	Displays all information needed to operate the device.
9	Power Button	Press and hold to turn on and off the device.

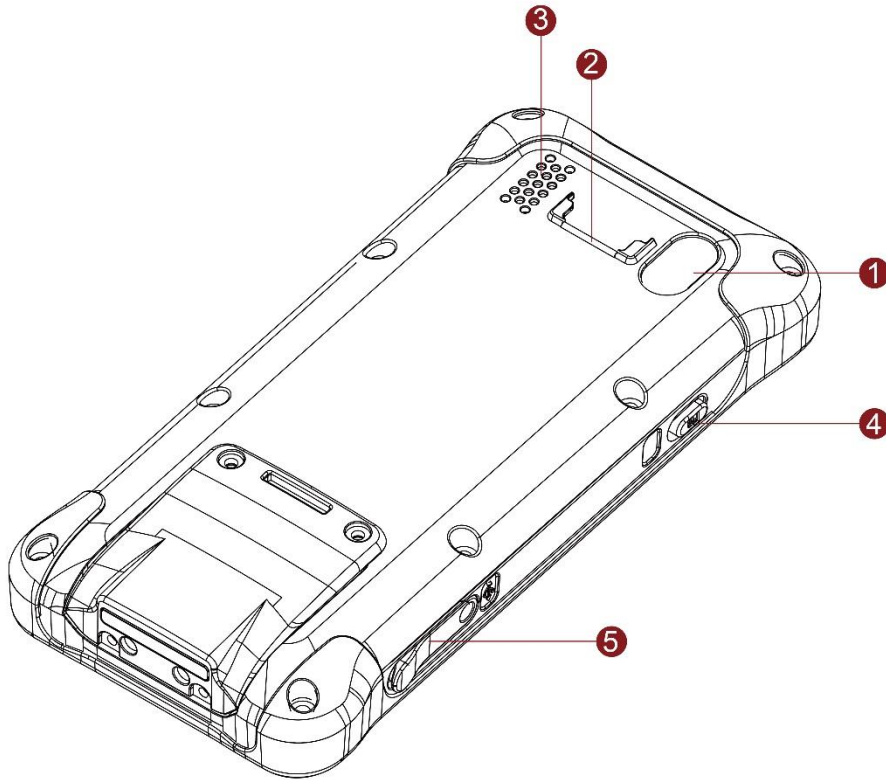
Rear View**Parts Description:**

No	Item	Description
1	13MP Rear Camera	To capture a rear view picture and use for making videos.
2	Strap Clip	To install a hand strap
3	Speaker	Provides audio output for music and video.
4	Function Key	If the device was equipped with scanners, this button can be function as a trigger button.
5	USB Type-C	Use for power input and communication with peripheral devices.

1.5 Dimensions

Unit: mm

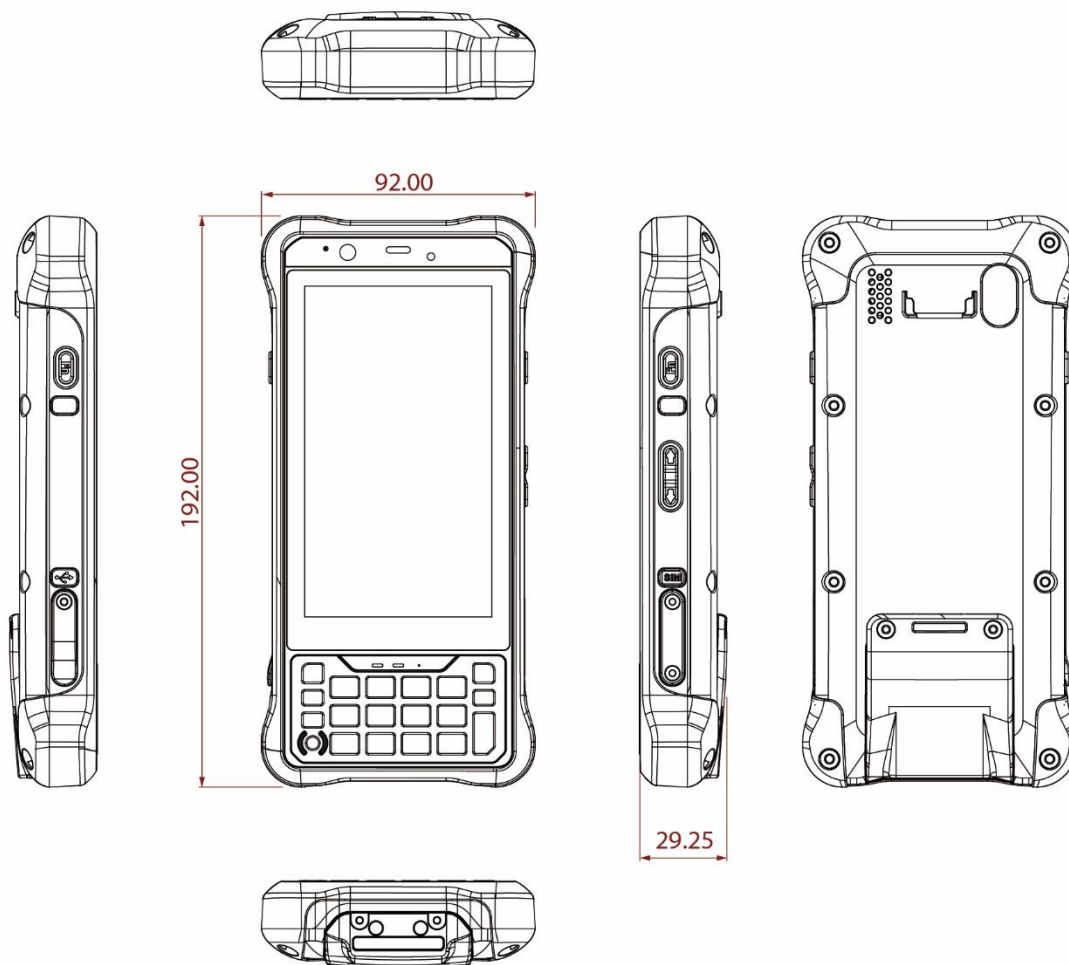

Note: This is a simplified drawing and some components are not marked in detail. Please contact our sales representative if you need further product information.

1.6 Getting Started

To start using the E500QK for the first time:

- Install SIM Card.
- Charge the E500QK.
- Power on the E500QK.
- Configure the E500QK.

1.6.1 SIM Card Installation



To Install the SIM Card:

1. Remove the SIM card cover screw
2. Install the SIM card.
3. Screw the SIM card cover back.



1.6.2 Charging the Battery

Charge the battery before using the rugged handheld computer for the first time, charge the battery until the LED indicator turns solid green. To charge the E500QK, use a cable or a docking with appropriate power supply.

LED Status	Indicator	
Off	The E500QK is not charging or not properly connected.	
Solid Red		Battery charged 0~89%.
Green		Battery charged 90~100%.

1.6.2.1 Charging the battery using USB Cable

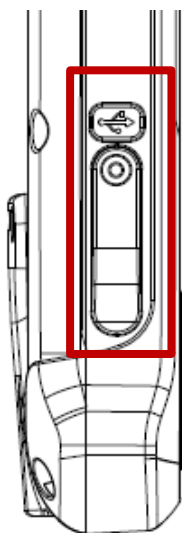

1. Connect the power supply output connector to the input power port on the USB cable.
2. Remove the protective cover and connect the USB cable to the side of E500QK. The battery charge LED. indicates the battery charging status.

1.7 Turning On and Off the Device

This section describes how to turn on/ off the device.

1.7.1 Turning On

1. Press and hold the power button for 3 seconds, located on the right side of the unit.

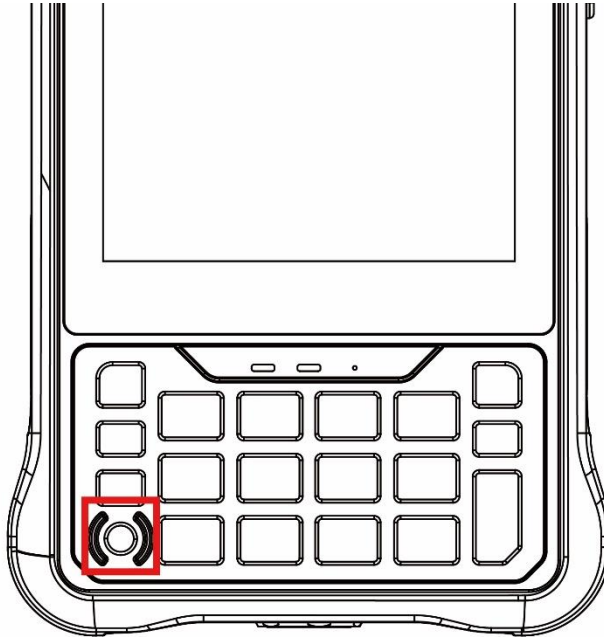

2. When the device vibrates, release the power button.
The desktop screen is displayed.

1.7.2 Turning Off

1. To turn off the device, press and hold the power button until the phone options menu appears, tap the **Power Off**.
2. User can also use the Phone options menu to put the device into silent or airplane mode, see features table.

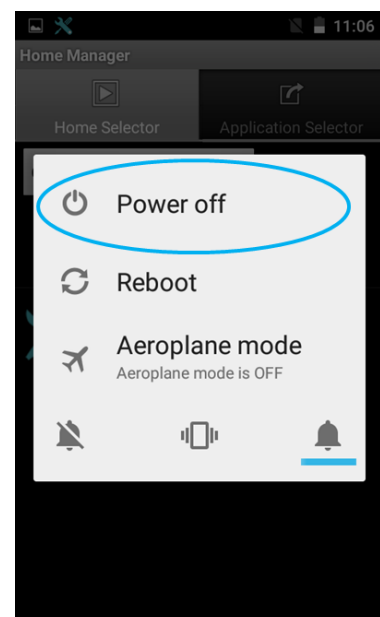

1.8 Resetting to Factory Defaults

To reset the device to factory defaults:

1. Slide from the bottom side, then tap **Settings** .
2. Tap **System**, user can select to back up application data, WLAN passwords and other settings to Google servers by tapping **Backup My Data**.
3. Tap **Advanced**, then tap **Reset options**, final tap **Erase all data** to reset the Rugged Handheld Computer.
4. Read all the available information and then check Erase storage if user wants to erase all the data in storage such as music or photo.

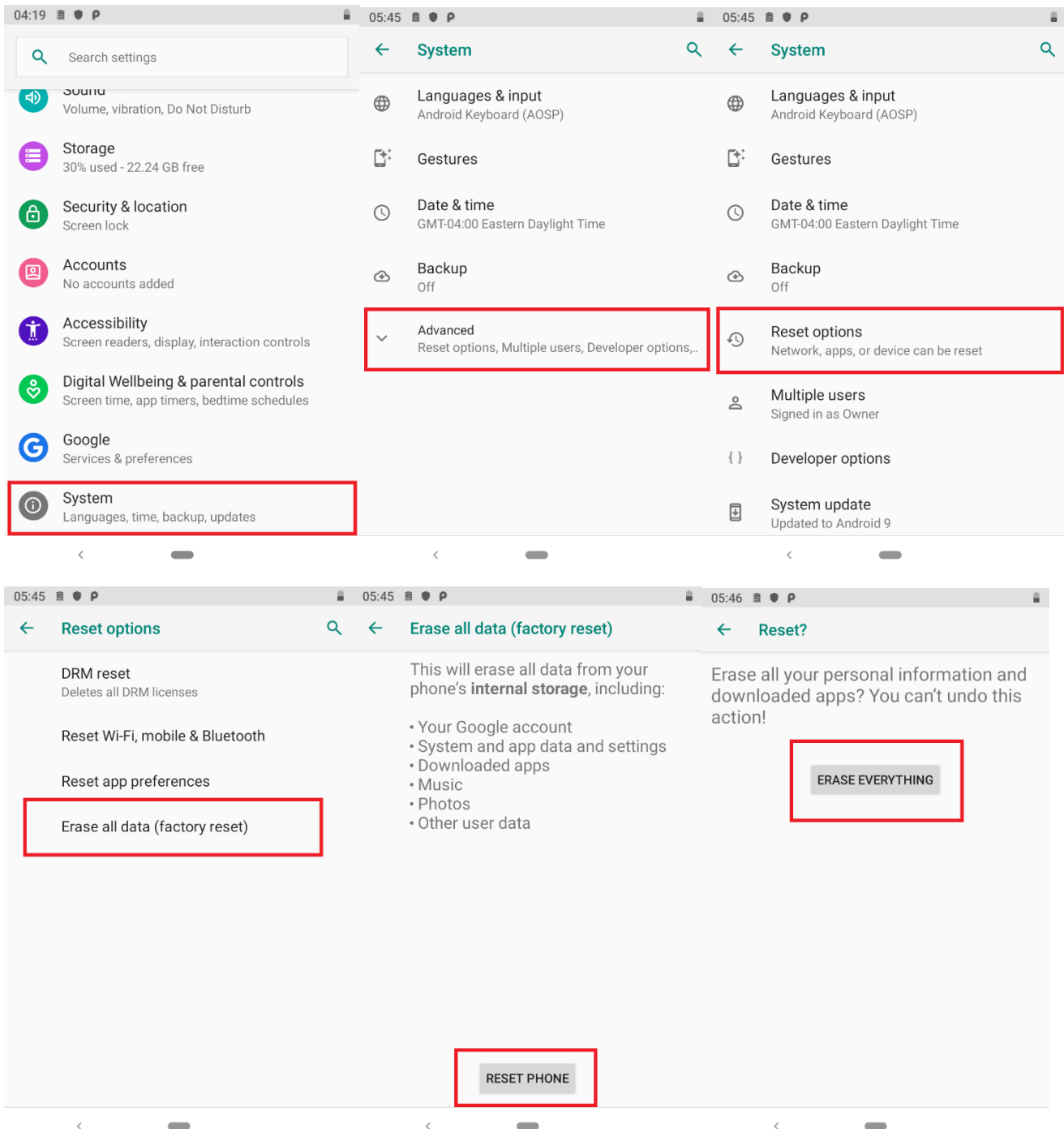







Chapter 2: Using the Rugged Handheld Computer

This chapter explains how to use the buttons, status icons, and controls of E500QK Rugged Handheld Computer running on Android 9.0 operating system and provides instructions on entering and capturing data.

2.1 Using the Touch Screen

The touchscreen supports the core gestures for Android.

Gesture	Action	Description
Tap		To select or activate something.
Tap & Hold		Touch and hold an item on the screen by touching it and not lifting your finger until it respond.
Touch, Hold & Drag		Touch and hold an item for a moment and then without lifting your finger, move your finger on the screen until you reach the target position. i.e. moving the apps around the home screen.
Swipe or slide		Quickly move the finger across the surface of the screen. i.e. slide a lock screen to open the lock.
Double-tap		Tap quickly twice on a webpage, screen, or App to zoom.
Scale		Place two finger on the screen and pinching them together.
Rotate		Two-finger press, simultaneously orbit both fingers around the center point, lift.

2.2 Waking Up the Rugged Handheld Computer

If you do not use the E500QK for a while, the screen dims and then darkens to conserve the Battery. To wake up the Rugged Handheld Computer:

1. Press the Power button on the top side of the Rugged Handheld Computer.
2. Drag the lock icon  upwards to unlock the screen.

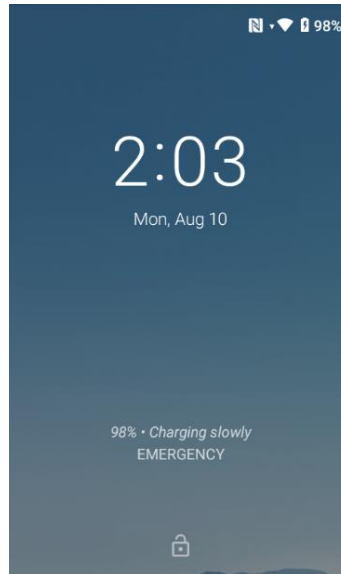

2.3 Using the Home Screen

Home screen is the starting point to access all the features on your E500QK. It displays application icons, widgets, shortcuts, and other features. User can personalize the home screen. See “Personalizing home screen”.

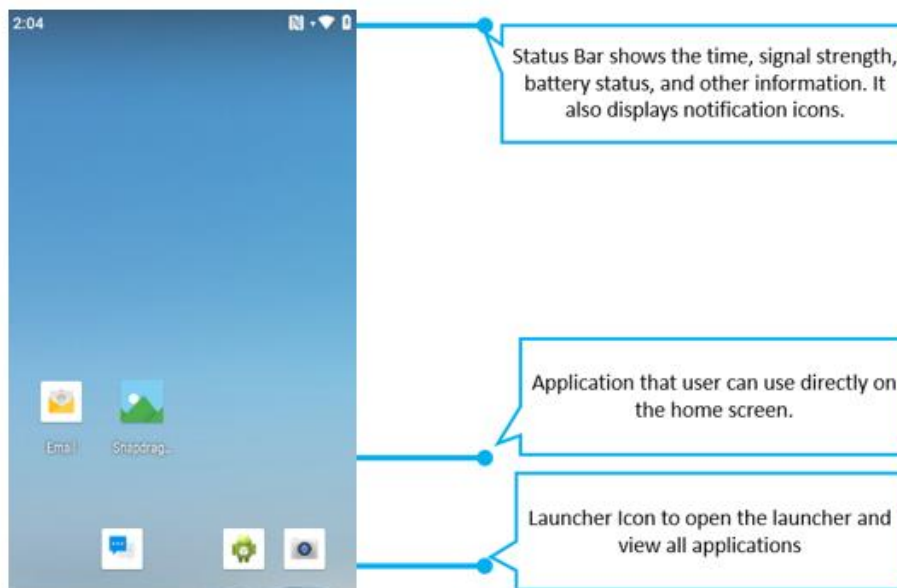

2.3.1 Personalizing Home Screen

User can add application icons, shortcuts, widgets, and other items to any part of any Home screen where there is free space. User can also switch the wallpaper.

To change wallpaper on the HOME SCREEN:

1. Slide from the bottom side, and then open **Settings** .
2. Tap **Display > Wallpaper**.
3. In the Wallpaper menu select the location of wallpaper, and then tap the type of item you want to add.

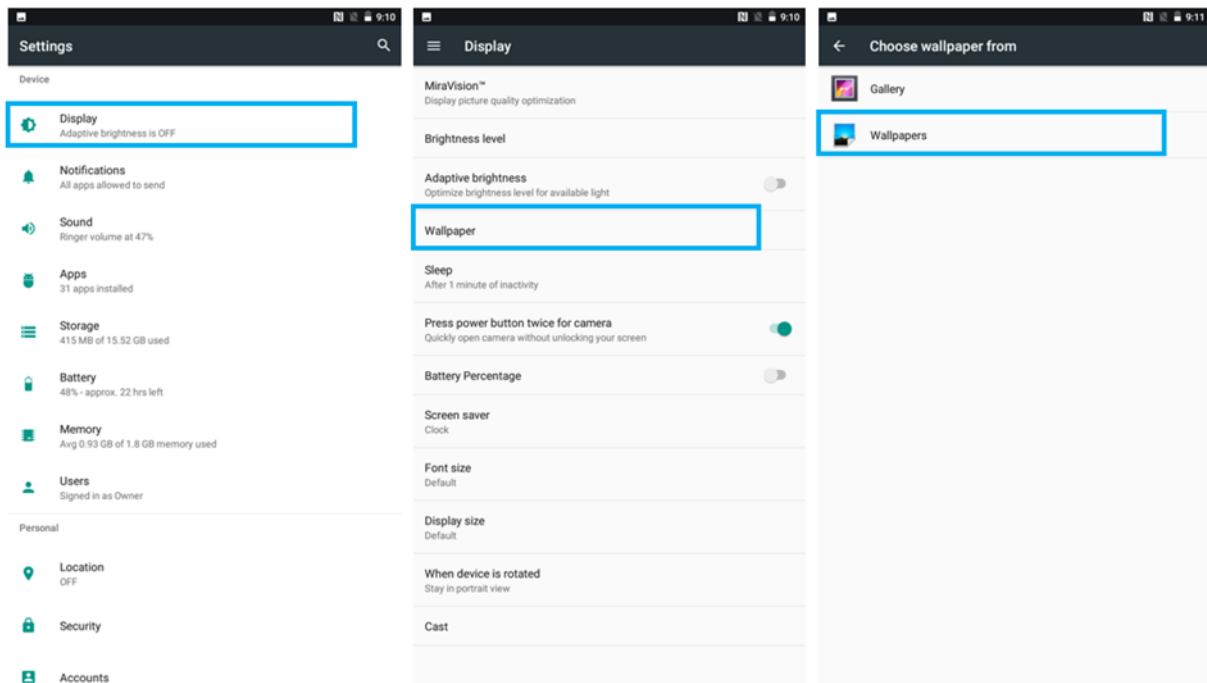

To move an item on the HOME SCREEN:

1. Tap and hold the item you want to move, until it can be moved.
2. Drag it to a new location on the screen.
3. Place the item where you want to put it and lift your finger.

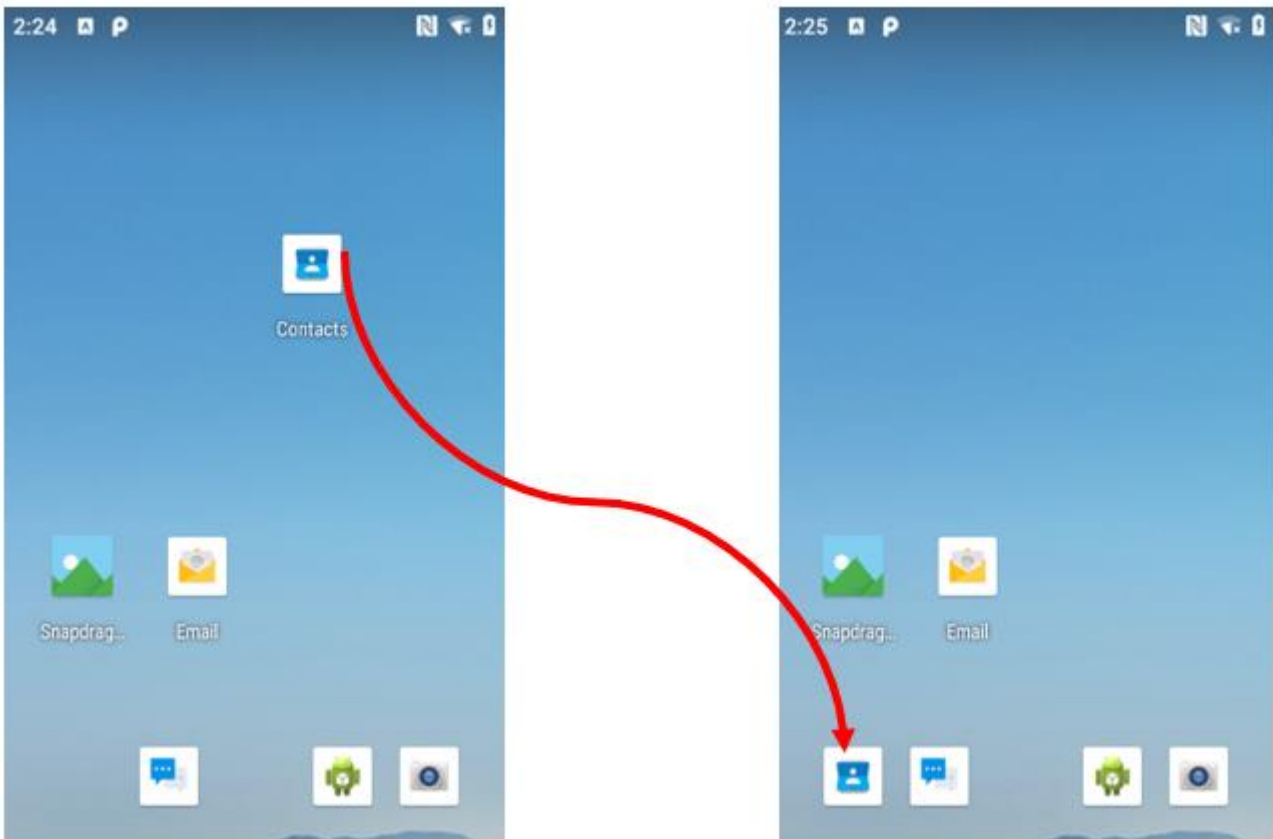
**To remove items from the HOME SCREEN:**

1. Tap and hold the item you want to remove. The launcher icon will show **Remove** on the top of the screen.
2. Drag the item you want to remove to the Remove icon.
3. When the icon turns gray, release your finger.

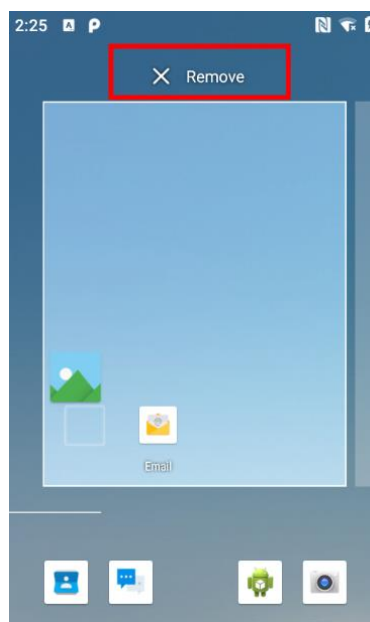

2.3.2 Viewing Other Parts of the Home Screen

1. Slide your finger left or right across the Home screen. Extensions to the Home screen provide extra space for APPS, shortcuts, and other items.



2. Slide from the bottom side to view the entire APPS of the device.

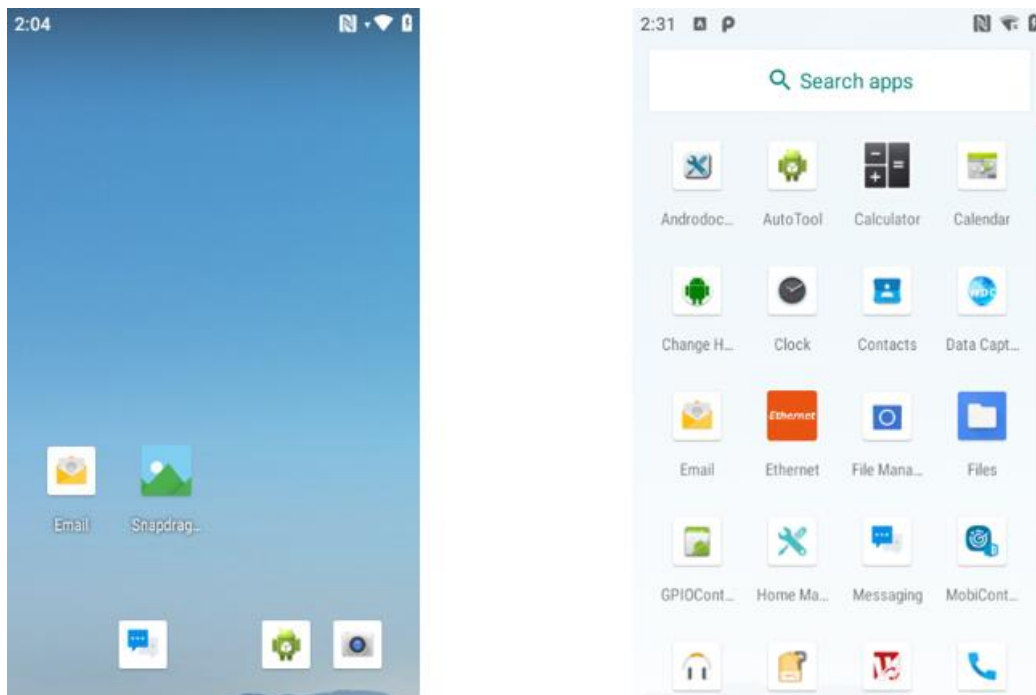

The status bar appears at the top of every screen. On the left are notification icons and on the right are status icons, along with the current time.

2.4 Status and Notification Icons



2.4.1 Notification Icons

Pull down from the left top of the screen to get the notifications area. The following icons indicate that you have received notification.

	New email message		Incoming call
	New text or multimedia message		Missed call
	Alarm is set		Speakerphone is activated
	Upcoming event		Phone microphone is muted
	Data is syncing		Downloading data
	Problem with sign-in or sync		Phone is connected via USB cable
	A screenshot is captured		

2.4.2 Status Icons

Pull down from the right top of the screen to get the notifications area. The following icons indicate the status of your device, for example if users are connected to a WLAN network that is not connected to the internet, the network icons are appears in white color.

Status icons that appear in the status bar are as follows:

	Connected to GPRS mobile network		Bluetooth is on
	Connected to 1xRTT mobile network		Connected to a Bluetooth device
	Connected to EDGE mobile network		No SIM card installed
	Connected to 3G mobile network		Vibrate mode
	Connected to 4G mobile network		Ringer is silenced
	Mobile network signal strength		Battery is very low
	Searching for a network signal		Battery is low
	No signal		Battery is partially drained
	Connected to a Wi-Fi network		Battery is full
	Roaming		Battery is charging
	Airplane mode		Receiving location data from GPS

2.5 Using the On-Screen Keyboard



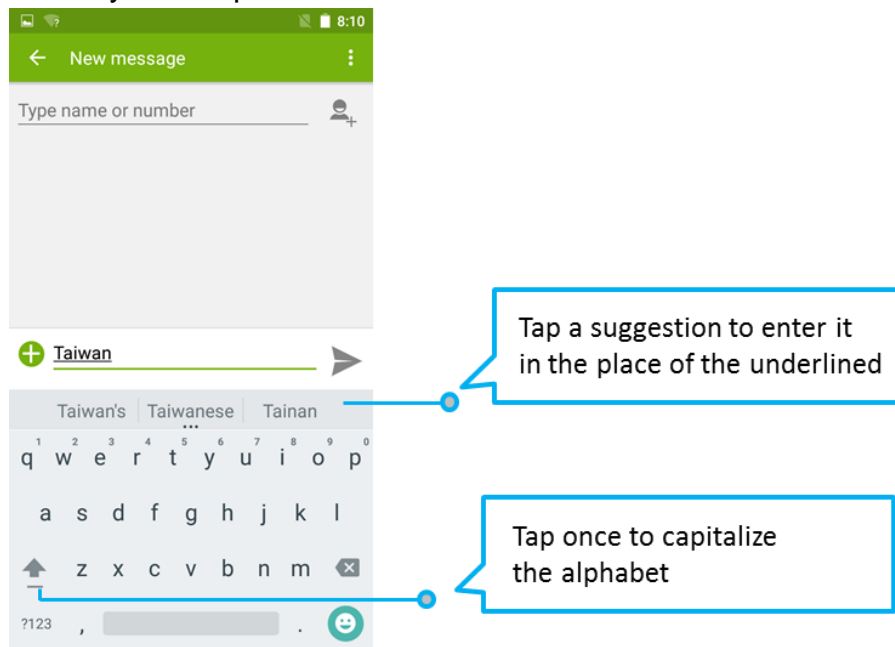

User will be able to enter text using the On-Screen Keyboard. Some applications will launch the keyboard automatically. In others, user needs to touch a text field where user wants to enter text to launch the keyboard.

2.5.1 Entering Text

1. Open a text field, in this example we used Messaging  to compose a message. The On-Screen Keyboard opens.



**If user taps in a text field which already contains text, the insertion point is set where user tap and the cursor appears. User can drag the cursor to pick exactly where you want to add more text. User can also select a word to copy, cut and paste it.*

2. Tap the delete key  to erase characters to the left of the cursor.
3. Tap  to enter numbers. Tap  to return to letters.
4. To enter symbols and other characters, tap and hold one of the top-row keys and slide your finger up to the list of the options. Lift your finger when you find your selection.
5. To view additional symbols, tap  on the numeric keyboard.

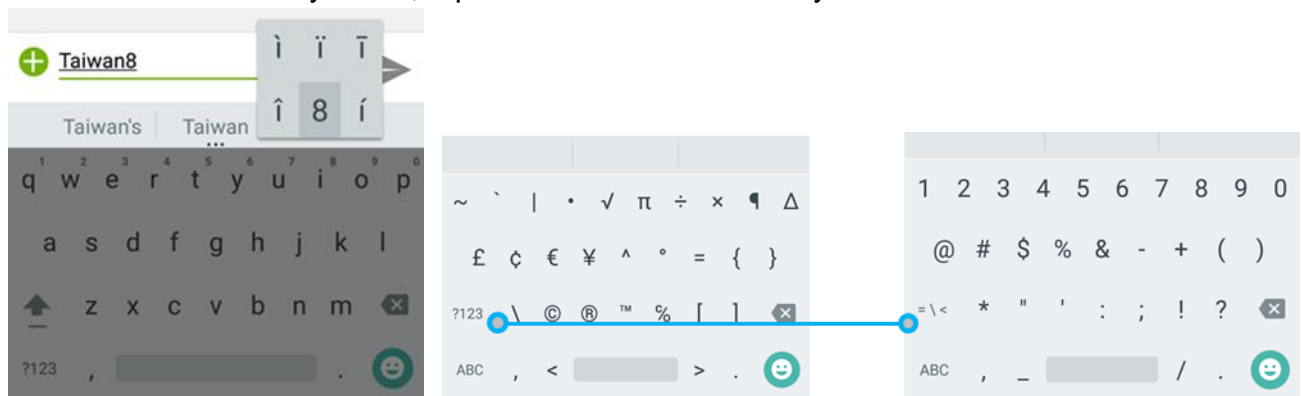

6. To close the On-Screen keyboard, press the back button .



2.5.2 Editing Text

To select text:

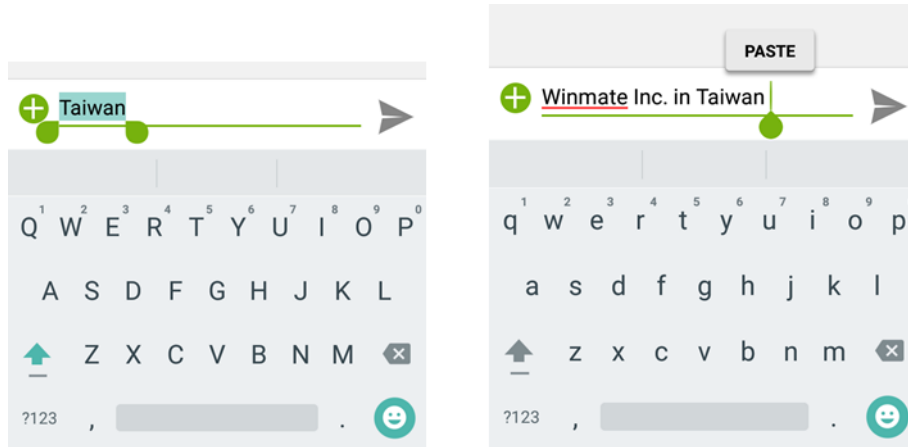
1. Double-tap the text you want to select.
2. Tap  to select all the sentences in the menu that appears, the selected text is highlighted in blue, with a tab at each end of the selected word.
3. Drag selection tab to expand or reduce the range of the selected text.



To Cut or Copy Text:

1. Select the text to cut or copy, see the section above “[To select text](#)”.
2. Tap  or  in the Edit text menu.
3. If you select , the selected text is removed from the text field; it is stored in temporary area so that you can paste it into different text field.

To Paste Text:

1. After Cut or Copy the text, see the section above “[To Cut or Copy Text](#)”
2. Place the cursor in the text field where you want to paste the text, user can paste text that you copied from one application into a text field in any application.
3. Tap and hold into the location that you want to paste. Tap **PASTE** in the menu that opens or user can also tap  to replace the existing text with copied text.

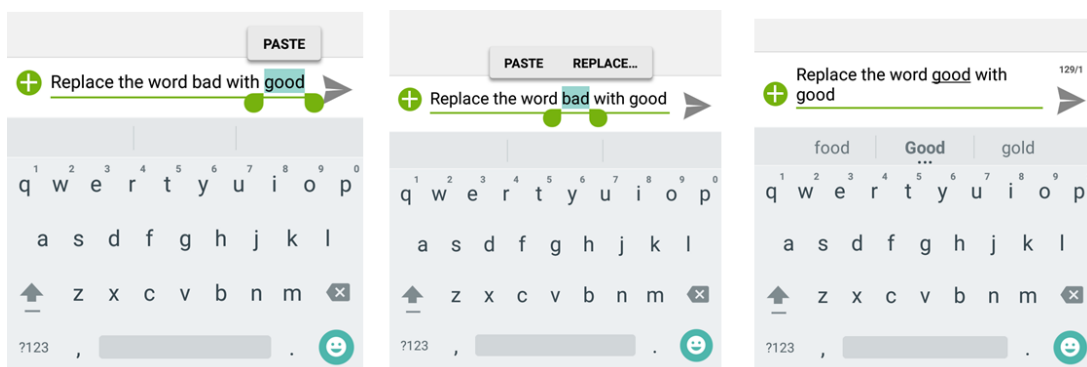

2.6 Display Settings

Use the display settings to configure brightness and other screen settings.

1. Slide from the bottom side and then tap **Settings** .
2. In the **Device** tab, tap **Display**:
 - **Display**
 - **MiraVision™** - to display picture quality optimization options.
 - **Brightness level** – for adjusting the brightness of the screen.
 - **Adaptive brightness** – to optimize brightness level for available light
 - **Wallpaper** – to select wallpaper
 - **Sleep** – to set up the device's sleep mode after the specified period of inactivity
 - **Press power button twice for camera** – Quickly open camera without unlocking your screen
 - **Battery Percentage** – to control battery percentage display.
 - **Screen saver** – to control what happens when the Rugged Handheld Computer is docked and/or sleeping, turn screen saver on
 - **Font size** – Make the text on screen smaller or larger
 - **Display size** – Make the items on your screen smaller or larger. Some apps on your screen may change position.
 - **When device is rotated** – for switching the orientation of the screen when user turns the device sideways or upright.
 - **Cast** – allows displaying whatever is visible on the device's screen on another screen, mostly wirelessly using WLAN as a medium for sharing the screen.

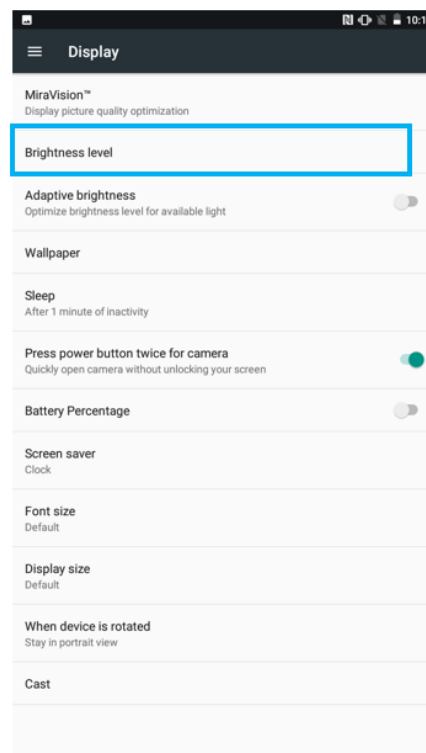
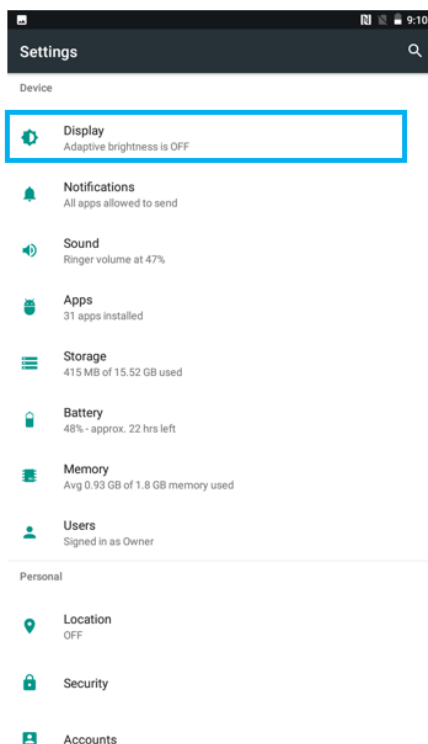

Note: For the longest battery life between charges, use the shortest Sleep time.

2.7 Audio Profile Settings

Use the sound settings to configure how and at what volume the Rugged Handheld Computer rings, vibrates or alerts user in other ways when user receive a call, receive a notification or an alarm sound.

2.7.1 Sound Settings

1. Tap **Settings** .
2. In the **Device** tab, tap **Sound & Notification** and then user can select General, Silent, Meeting or Outdoor profile.

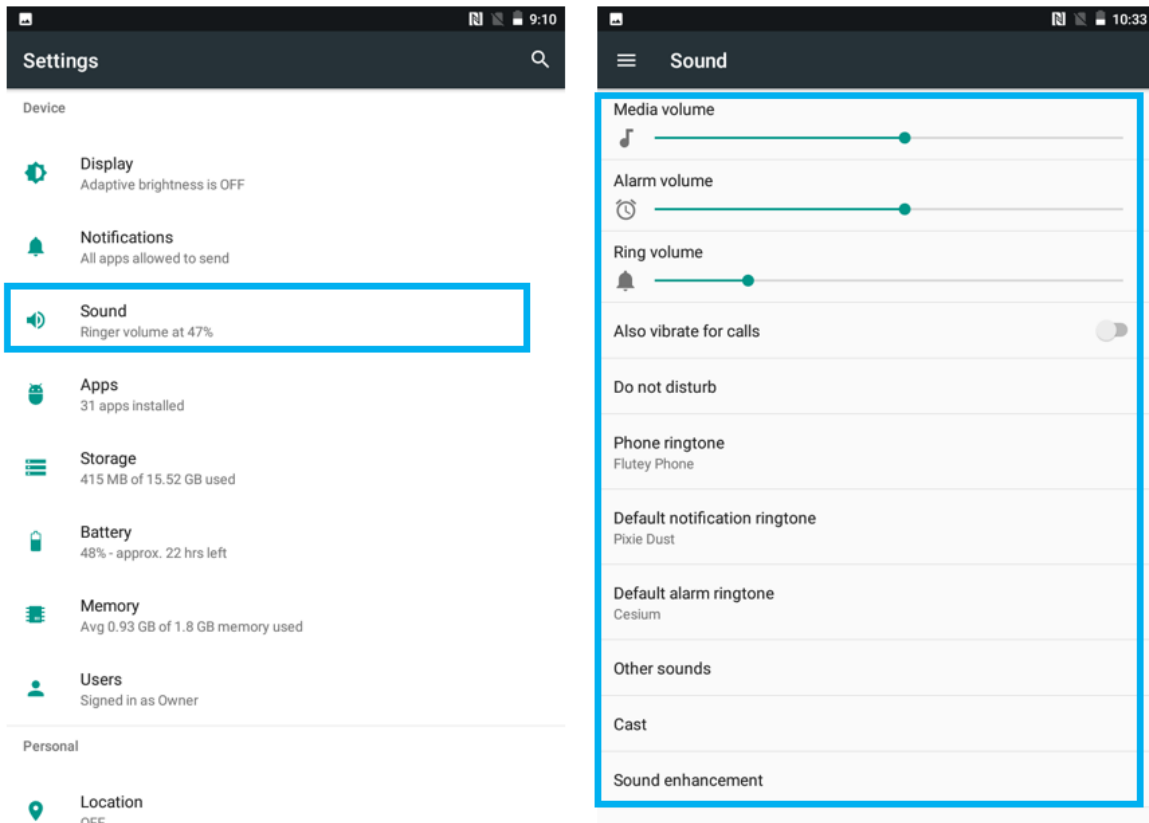

2.7.2 Adjusting Volume

1. Press the volume keys to change the ring volume (On Home screen) or earpiece volume (during a call).



2. Press the volume key to set up Vibration mode.



2.8 Language and Keyboard Settings

Use the Language & keyboard settings to select the language for the text on your Rugged Handheld Computer and for configuring On-Screen Keyboard, including words that you have added to its dictionary.

1. Tap **Settings** .
2. Tap System, then select **Language & Input**.
 - **Language** – to open the language screen, where user can select the language to use for the text on the device.
 - **Spell Checker** – to activate Android Spell Checker (AOSP) and check to correct misspelled words.
 - **Personal dictionary**- to open a personal dictionary.
 - **Keyboard & input methods**
 - **Virtual Keyboard** – to apply the onscreen keyboard that is included with user's device. Default Android Keyboard (AOSP).
 - **Physical Keyboard** – allows the user to apply physical keyboard settings if connected.
 - **Appearance & layouts**
 - **Theme** – to select the theme of layout.
 - **Custom input styles** – user can select custom input style, such as QWERTY keyboard.
 - **Enable split keyboard** – toggle to activate split keyboard layout.
 - **Text Correction**
 - **Personal dictionaries**
 - **Add-on dictionaries**
 - **Block offensive words** – disable suggesting potentially offensive words
 - **Auto-correction** – spacebar and punctuation automatically correct mistyped words.
 - **Show correction suggestions** – display suggested words while typing.
 - **Personalized suggestions** – learn from your communications and typed data to improve suggestions.
 - **Suggest contact names** – use names from Contacts for suggestions and corrections.
 - **Next-word suggestion** – use previous word in making suggestion.
 - **Advanced**
 - **Keypress vibration duration**
 - **Keypress sound volume**
 - **Key long press delay**
 - **Emoji for physical keyboard**
 - **Show app icon**

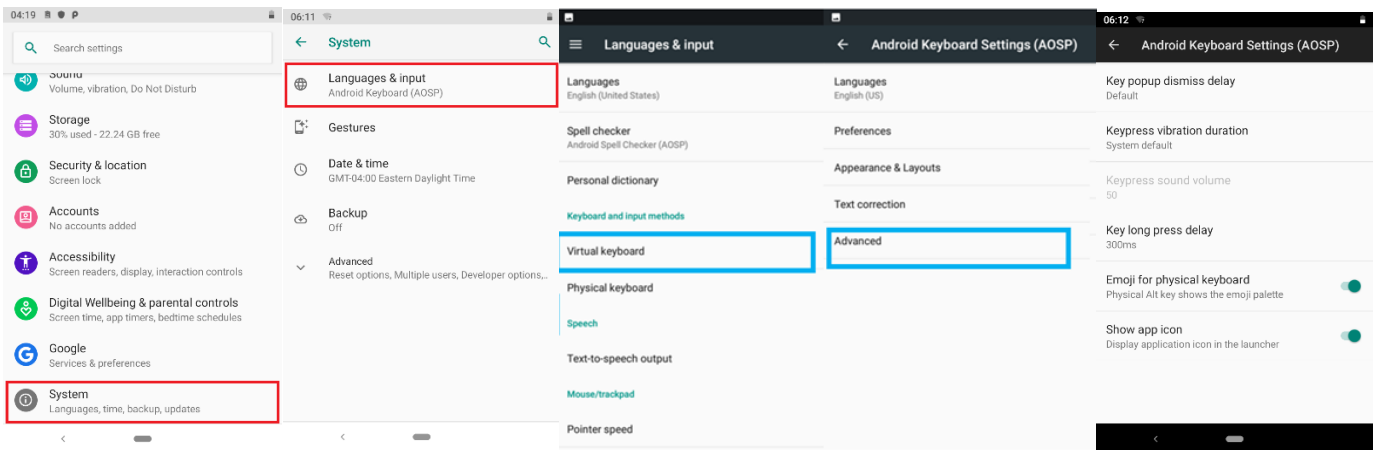

2.8.1 Changing the Keyboard Language

The current keyboard language is displayed on the Space key and user can switch languages.

1. Tap and hold the space key
2. Without lifting the finger, slide it to the left or right until the language you want to use appears in the center of the small window above the Space Key.
3. Lift the finger to change the keyboard language.

2.9 About Phone

About Phone includes information about user's device.

- **System Update** — provides information regarding the local or online update of your devices.
- **Status** — opens the status screen with a list of information about battery, network, signal strength and other details.
- **Legal information** — lists details about the model number, Android Version, Baseband version etc. this information is useful if user need to work with support team.
- **Model number** – displays the model name of the current device.
- **Android version** – displays the current Android operating system version the device running

To access the information about the phone:

1. Tap **Settings** 

Scroll down to tap **About phone**.

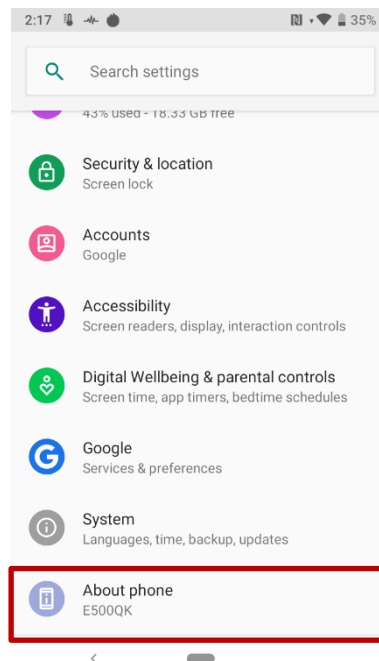

Chapter 3: Winmate Home Manager

Every E500QK Series Rugged Handheld Computer comes with preinstalled APP named Winmate® Home Manager (W.H.M.). This application lets the device manager to lock the launcher. When the launcher is locked the user can only use one application assigned by the device manager.

3.1 How to Lock Applications

Step 1

- In the main APPS window, select the Home Manager APP and enable it.
- Select Home Manager to start your settings.
- Go to **Password Manager** and set your own password for this APP. The default password is "0000".

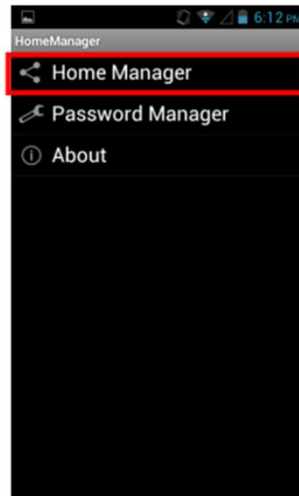
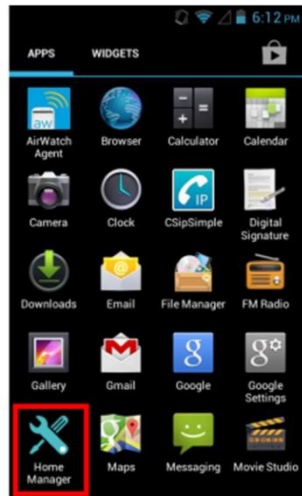

Step 2

- Go to "Application Selector" and choose an Application to be locked.

Example: Select the Calendar AP.

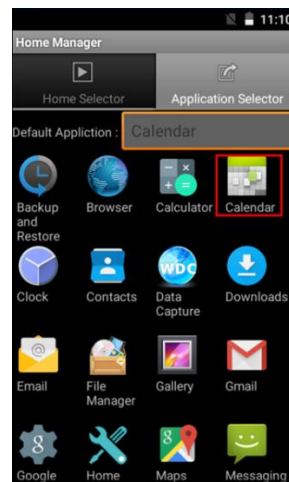

- Go back to "Home Selector" and press "Clear and Reset Default Home".

Step 4 Select “**Restrict Home**”, and then restart the Rugged Handheld Computer.

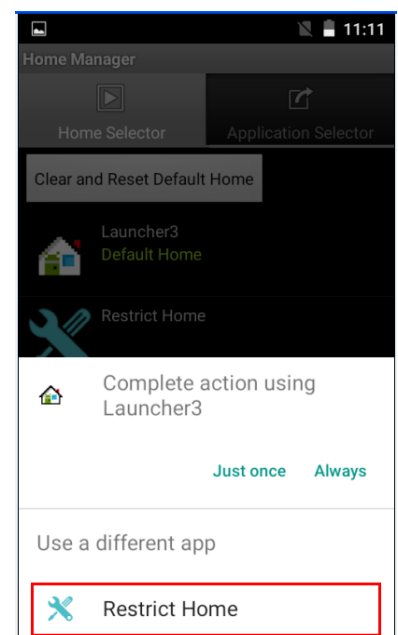
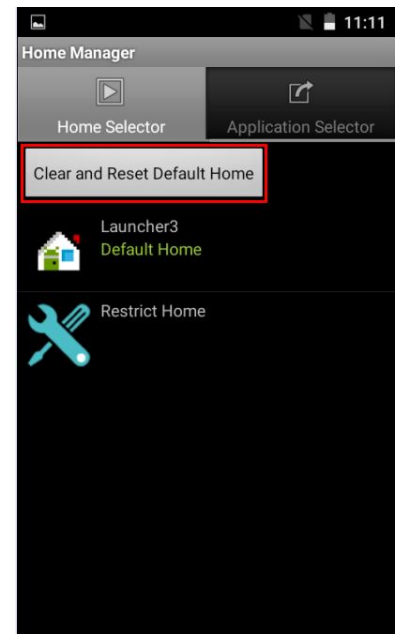

Step 6 System will ask to select “**Just once**” or “**Always**” to use this launcher, please select “**Always**”.

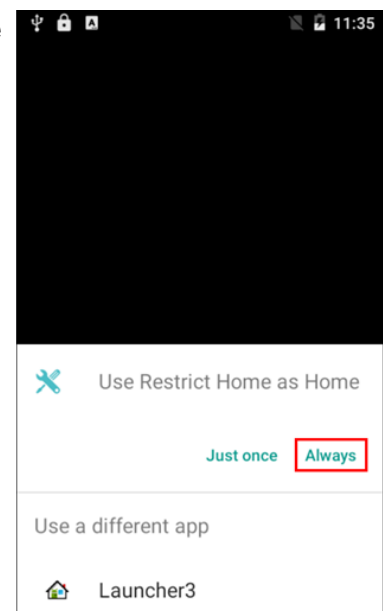

The system will automatically start the application which you selected and lock it.

Any time you press home key or back key, the system will go back to the same application which you have selected.

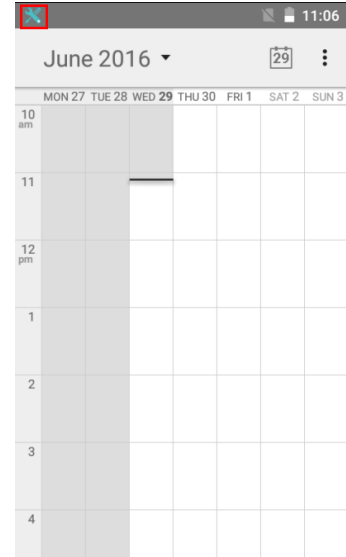

3.2 How to Unlock Applications

Step 1 Slide down the top bar and press “**Home Manager**” icon then you can find the menu and please enter the password to login (The default password is “**0000**”).

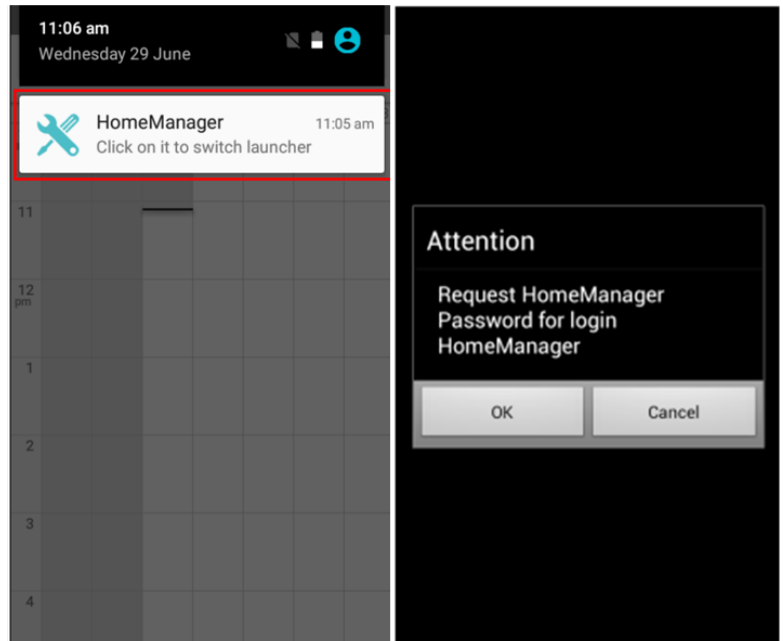

Step 2 Go back to “Home Selector” and press “Clear and Reset Default Home”.

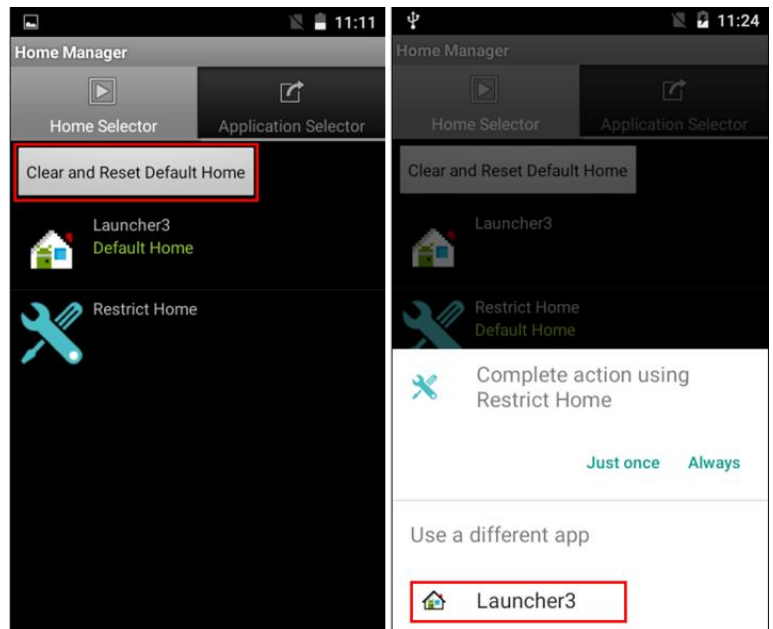

Step 3 Restart the system and you will go back to the normal Launcher.

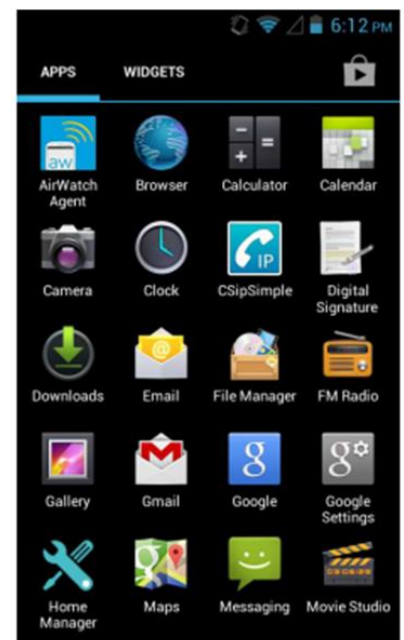

3.3 How to Change Password

Step 1 Go to **Password Manager** and set your own password for this APP.

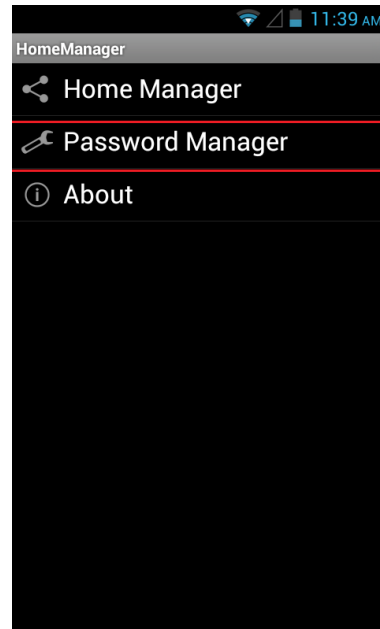

Step 2 The default password is “0000” . Enter a new password in **New Password** field, and then tap **Change Password**.

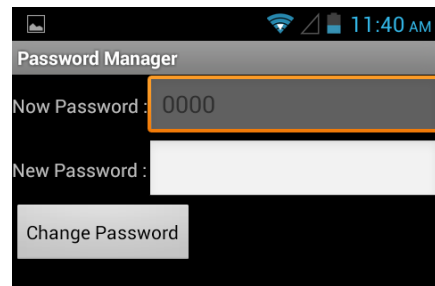

Chapter 4: Networks and Wireless Devices

This chapter explains how to connect the Rugged Handheld Computer to network and peripheral devices.



4.1 Connecting to Mobile Networks

When users install a SIM card from service provider to the E500QK, the device is configured to use the provider's networks for voice calls and for transmitting data. Different locations may have different mobile networks available; user may need to configure E500QK to use certain networks.



Note: To obtain faster networks configure the device to 4G. To extend the life of battery user can use 2G network.



4.1.1 Checking the Network (GPRS/3G/4G) Connection

1. Tap and then tap **System Settings** .
2. Tap **More** in the **Wireless & networks**, and then tap **Mobile networks**.
3. Tap **3G/4G Service** to check the network connection.





Important: Do not change the parameters of the access point to prevent inability to access network sources.

4.1.2 Turning on Data Service

1. Tap **MENU**  and then tap **Settings** .
2. Tap **More** in the **Wireless & networks**, and then tap **Cellular networks**.
3. Tap **Data connection**.
4. Select the desired network operator to enable the data connection.

4.2 Connecting to WLAN Networks

4.2.1 Turning on WLAN and Connecting to WLAN Networks

1. Tap **Settings** .
2. Tap **Wireless & networks** and then select **WLAN** to turn it on .
3. Tap **WLAN**. The device scans for available WLAN networks and displays the list of it. Secured networks are indicated with a lock icon. If the Rugged Handheld Computer finds a network that you have connected previously, it connects to it automatically.
4. Tap a network to connect to it:
 - If the network is open, you are prompted to confirm that you want to connect it by tapping **Connect**.

- If the network is secured, users are prompted to enter a password or other credentials.
5. To check the details about the speed, security, address and related settings, tap its name in the WLAN settings screen.

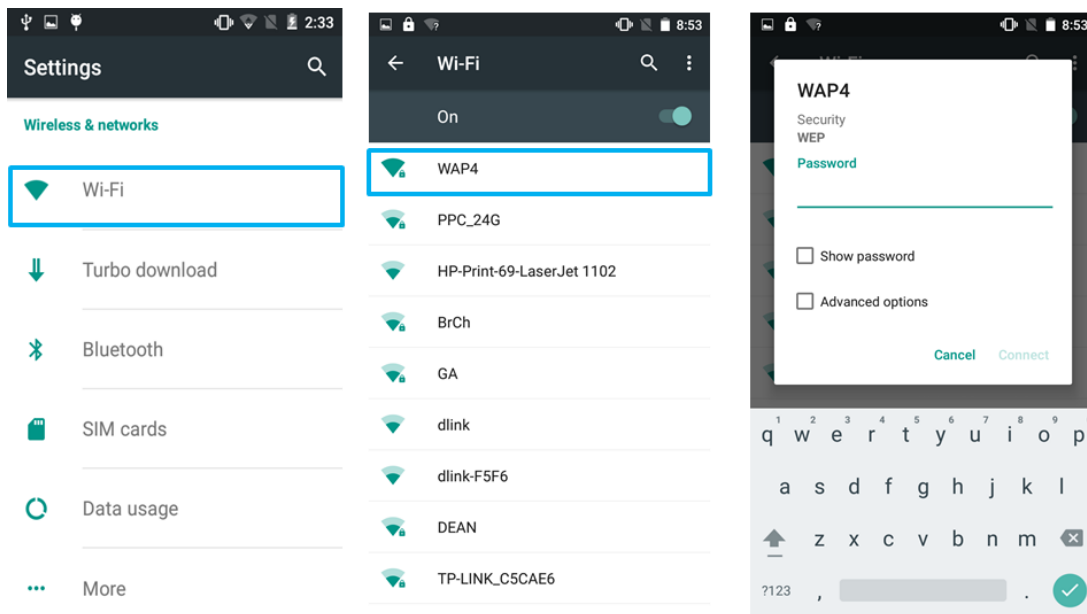

4.2.2 Adding WLAN Network

1. Turn on Wi-Fi, in the WLAN settings screen, tap **+ Add network** (at the bottom of the list of discovered networks).
2. Input the SSID (name) of the network, if the network is secured, tap the security menu and then tap the type of security deployed on the network.
3. Enter any required security credentials.
4. Tap **Save**.

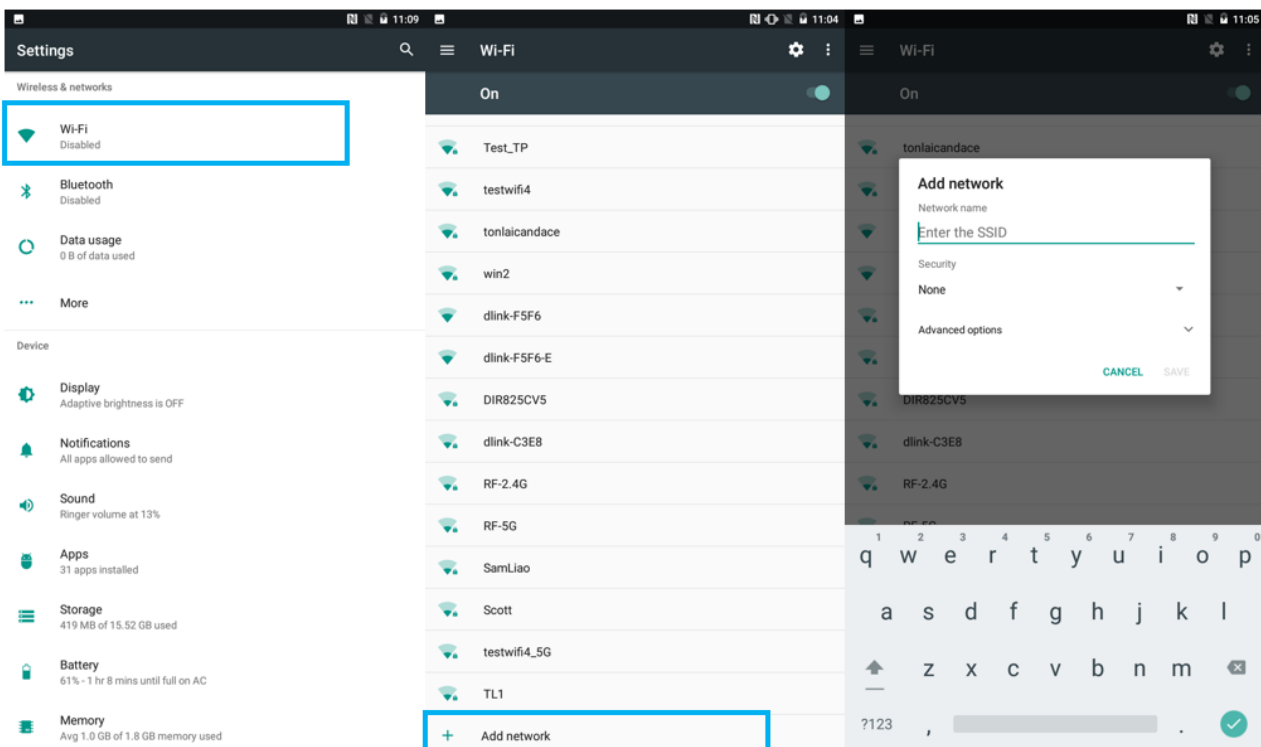

4.3 Connecting to BT. Devices

4.3.1 Turning BT On or Off

1. Tap **Settings** .
2. Tap **connected devices**, then tap **connection preferences**, and then select **BT**.
3. Toggle the on/off switch on the top-right hand side to turn on **BT**.

4.3.2 Connecting to BT. Device

1. Go to **Settings** .
2. Tap **connected devices**, and then select **Pair new device**.
3. It will automatically scan and displays the IDs of all available BT devices in range.
4. Tap the **ID** of the other device in the list in Settings to pair them.

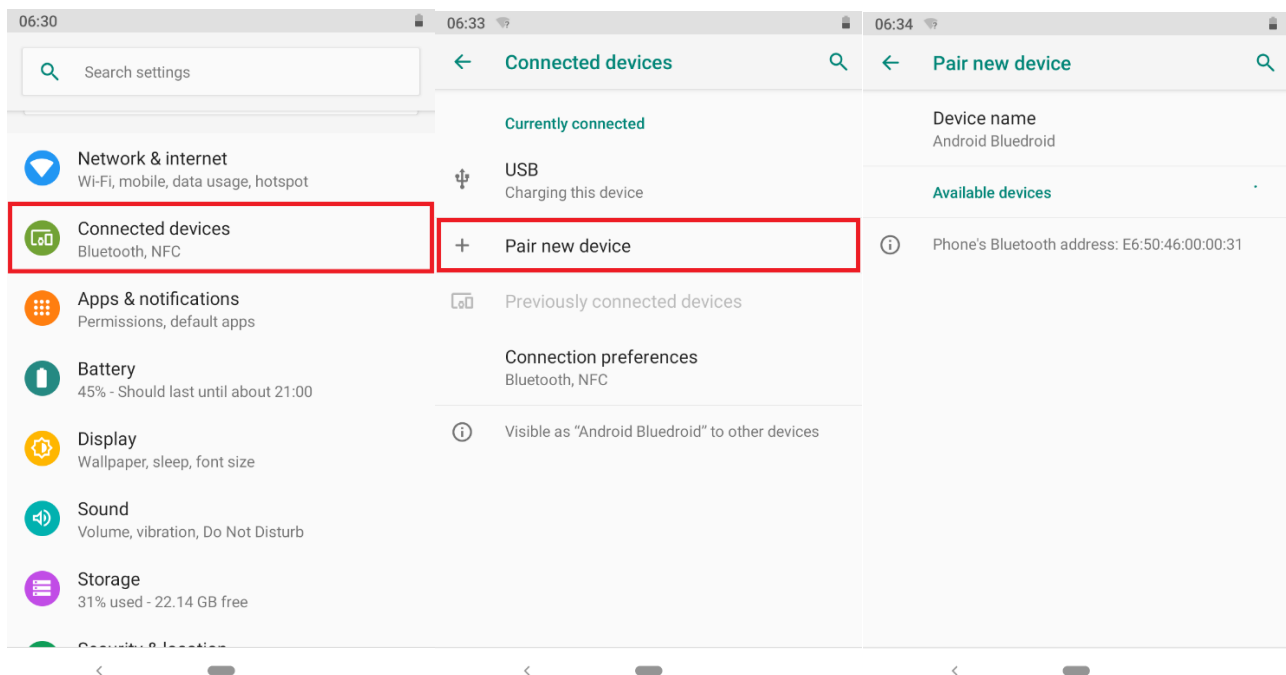

4.3.3 Disconnecting BT. Device

1. Tap the device in the **connected devices** screen.
2. Tap the devices and select **Forget**.

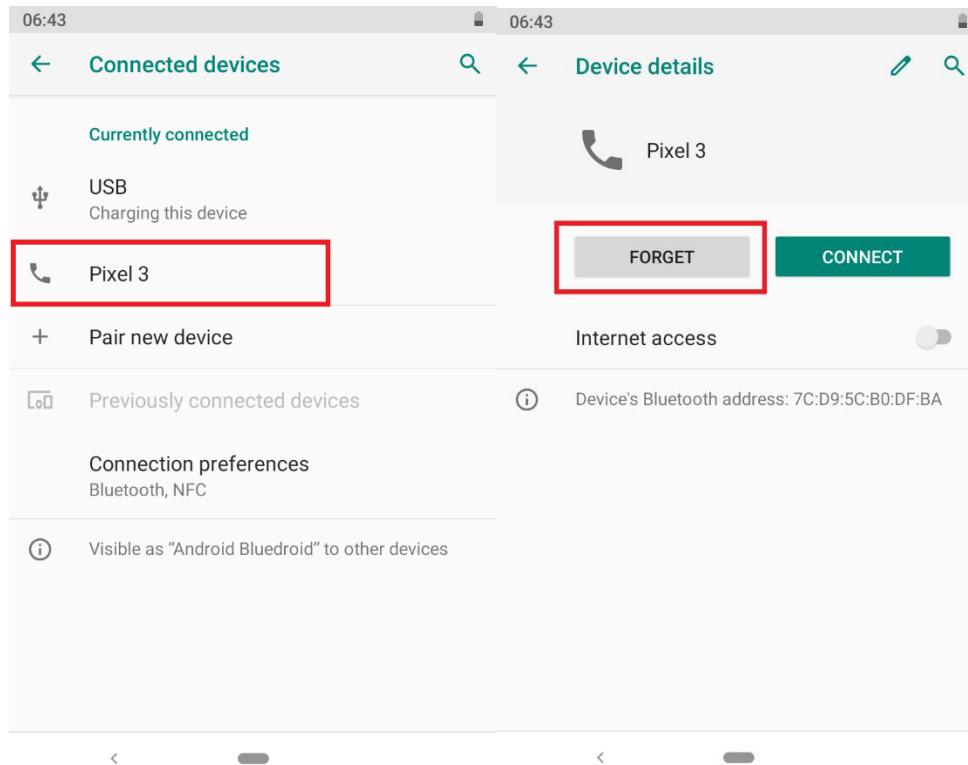

4.4 Connecting to Computer via USB

User can connect their Rugged Handheld Computer to a computer with USB cable to transfer files between Rugged Handheld Computer and computer.



Important: When connecting your Rugged Handheld Computer to a computer and inserting its USB storage or SD card, user must follow the computer's instructions for connecting and disconnecting USB device, to avoid damaging or corrupting files.

4.4.1 USB Computer Connection

1. Connect Rugged Handheld Computer to the computer via USB connector.
2. In the notifications area **USB connected sign**  will appear.
3. Pull down the notification area to open notification panel.

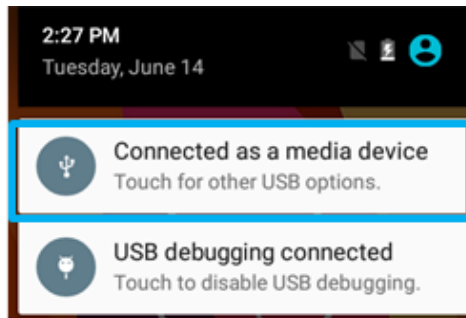

4. Tap this icon  to choose the type of USB connection.
 - **Transfer files** –let user transfers files between computer and Rugged Handheld Computer.
 - **Transfer photos (PTP)** – let users transfer photos or media files if MTP is not supported.
 - **Use device as MIDI** – let users use device as MIDI

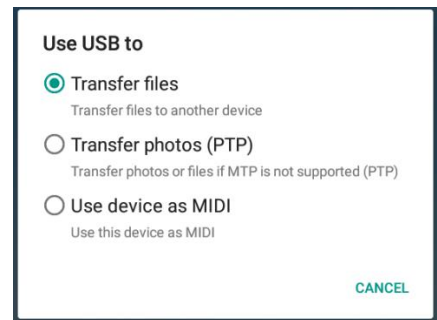

4.4.2 USB Debugging Settings

To permit debugging tools on a computer to communicate with User's Rugged Handheld Computer via USB Connection.

1. Connect Rugged Handheld Computer to the computer via USB cable.
2. In the notifications area **USB debugging connect** sign  will appear.
3. Pull down the screen to open notification panel.

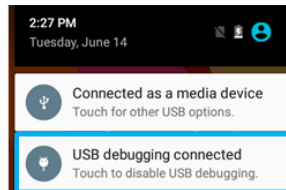

4. Tap **USB debugging connected**.
5. In the **Developer options** user can choose the action to perform.

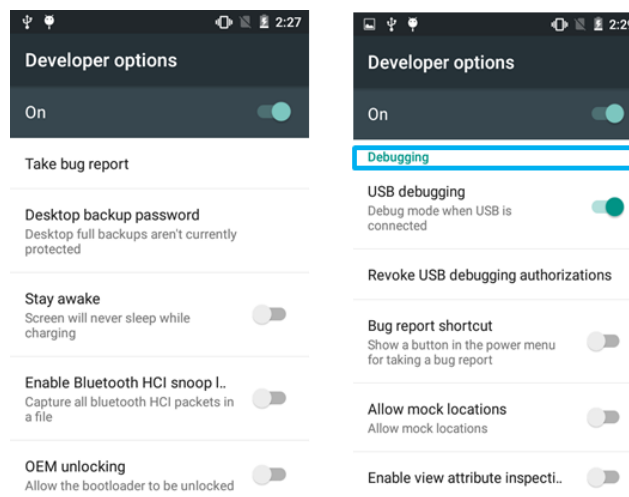

Important: Carefully follow your computer's instructions to un-mount the USB storage or SD card. Disconnect USB device not properly can cause a loss of important data or information.

Chapter 5: Using Camera

This chapter explains how to use camera to capture photos and videos.



5.1 Capturing Photos or Video

Winmate® E500QK is equipped with an 13MP Camera on the rear side and an 8 MP Camera on the front side, which user can use to capture photos or video.

5.1.1 Opening Camera

1. Tap the launcher and then tap **Camera** .

Camera opens in Portrait mode, ready to take a picture or shoot a video.



Important: Make sure the protective lens cover is clean before taking pictures. A lens cover with smudges from fingers can cause blurry pictures.

5.1.2 Taking Pictures





1. Adjust the exposure, flash, and other necessary settings. Or leave it automatic.

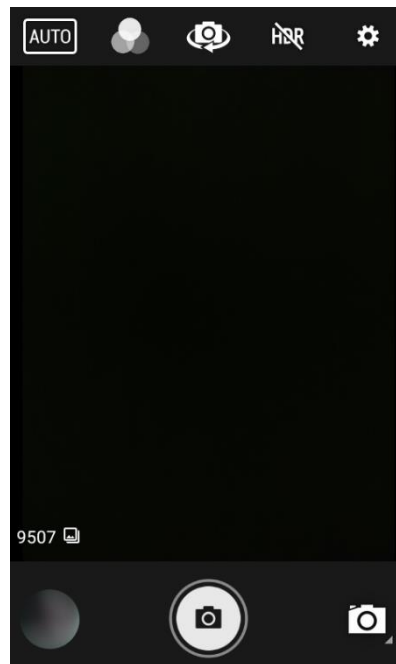



2. Tap the On Screen Shutter icon.
3. The camera brings the image into focus, when the image is in focus, the focus indicators in each corner will turn green and ready to capture.
4. Tap  to change camera settings.



5.1.3 Viewing pictures

1. After taking a photo, a thumbnail of the picture is shown on the corner of the capture screen. Tap the thumbnail to view it.
2. Tap the onscreen button:
 -  to share a photo.
 -  to share through BT.
 -  to edit the photo.
 -  For more Camera options such as Delete, Edit, Rotate, Crop or photo details.
3. Swipe right or left to view more photos.

5.1.4 Shooting Videos

1. Tap the , then tap the  to start recording video.
1. The countdown time remaining to shoot is located on the top; when the time left is less than a minute, the countdown turns red.
2. Point the lens to record the scene where you want to start.

Tap the  icon again to stop shooting.

The time remaining to shoot counts down; when less than a minute is left, the countdown turns red.

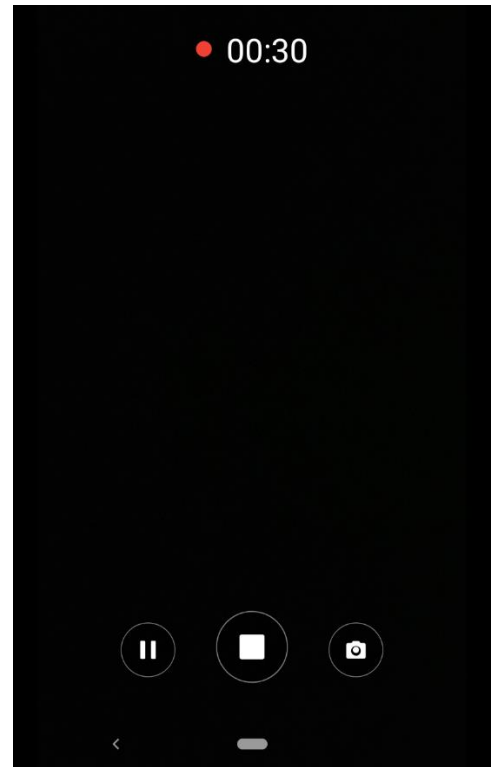

5.2 The Gallery

1. Go to the launcher and then tap Gallery .
2. Tap a folder to view the pictures or video inside in full screen mode.
3. Flick the pictures left or right to view the previous or next picture.

Chapter 6: Accessories

The E500QK accessories provide a variety of product support capabilities. Some of the accessories are optional and are not included to standard packaging list.

6.1 Accessories List

Standard Accessory List E500QK:

Accessory	Part Number	Description
Standard		
Hand Strap	9B0000000416	Hand strap to firmly grasp the device without having the fear of dropping it.
Universal USB Adapter	922Z005W05V1 USA 922Z005W05V4 EU 922Z005W05V2 UK 922Z005W05V3 AUS	Input: AC 100-240V 50/60Hz Output: 5V-1A
USB Type C Cable	9480247090K0	USB Type C Cable

Optional Accessory List E500QK:

Accessory	Part Number	Description
Optional		
Micro SD Card (The Micro SD card is built into the device internally and is not user-accessible.)	76000000000V 760000000001	16GB MicroSD Card 32GB MicroSD Card
Desk Dock	98TA05Z00008	1 x LAN 2 x USB

Appendix

Appendix includes additional product information, including technical specifications; order information, OS image and OTA update procedures.



Appendix A: Product Specifications

		Model Name
		E500QK
Display Specification	Size	5"
	Resolution	1280 x 720
	Brightness	500 nit (typ.)
	Touch	Projected capacitive multitouch
	Contrast Ratio	800:1
	Viewing Angle	80/80/80/80
System Specification	Processor	Qualcomm® Snapdragon™ 660 (Octa-core 2.2 GHz)
	System Memory	3 GB RAM
	Storage	32GB eMMC + Internal non-accessible Micro SD Card Slot(Micro SD Card options up to 128GB)
	OS	Android 9.0
Wireless Communications	WLAN	Support 802.11 a/b/g/n/ac
	BT	BT 5.0
	GNSS	GPS/ AGPS/ GLONASS
	WWAN	Optional WWAN
Interface	Docking	1 x Docking Connector
	USB Ports	1 x USB Type C
	SIM Card Slot	1 x SIM Card Slot
Keyboard and Input	Touch	10-point multi touch, support Hand / Gloves and Rain Mode
	Button	On-screen QWERTY keyboard Button: 1 x Volume +/-, 2 x function key
	Physical Keypad	19 buttons keypad including power key
	LED. Indicators	1 x LED. indicators (Power, Battery)
Audio	Microphone	Built-in Mic
	Speaker	1 x 1 W Speaker
	Earphone	1 x Earphone
Data Capture	Camera	Rear: 13 MP Camera with LED. auxiliary light (auto focus) Front: 8 MP Camera
	Data Capture	NFC (Read / Write, Peer to Peer mode) (Optional)
Mechanical and Environment	Dimensions	192 x 92 x 29.25 mm
	Weight	370 g
	Operating Temp.	-10°C ~ +50°C (Battery Mode)
	Storage Temp.	-30°C to 70°C (-22°F to 158°F)
	IP Rating	IP67, water and dust proof
	Shock	MIL-STD-810G Method 516.6 Procedure I
	Vibration	MIL-STD-810G Method 514.6 Procedure I
Drop	MIL-STD-810G Method 516.6, 5 ft, Free to concrete	
Power Management	Power Input	5V DC, 1A
	Battery	3.7V 3900mAh Non-removable Battery
	Adapter	100-240V, 50~60Hz

1. Total usable memory will be less dependent upon actual system configuration.
2. Computrace theft protection is available upon request.
3. Length measurements do not include protrusions. Weight varies with options and a digitizer pen.
4. Measured at dimming LCD brightness. Varies depending on the usage conditions, or when an external device is attached.
5. Accessories and integrated options may vary depending on your configuration.
6. This is a simplified drawing, and some components are not marked in detail.
7. The product shown in this datasheet is a standard model. For diagrams that contain customized or optional I/O, please contact the Winmate Sales Team for more information.

Appendix B: Software Development Kit

Winmate® provides the following drivers and SDK for E500QK. Download SDK from Winmate Download Center at <https://www.winmate.com> > Support > Download Center

Item	File Type	Description
1	E500QK Drivers	Android Debug Bridge(ADB) Driver / USB Driver
2	E500QK Flash Tool	Flash Tool
3	General SDK (WDC)	Development kit for WDC

Appendix C: OS Image Update

Winmate provide OS Image update tool. Refer to “OS Image Update Tool Guide” for a detailed instruction on how to update OS image.

Download OS Image update tool and OS Image Update Tool Guide from [Winmate Download Center](#).

Appendix D: OTA Online Update

You can use online OTA Update tool to update firmware version.



Important Battery capacity must not be lower than 30% during update.

To update OTA:

1. Select **OTA-firmware**.
2. Select **Manual update**.
3. Check **"I agree to update"** and click **"UPDATE"**.

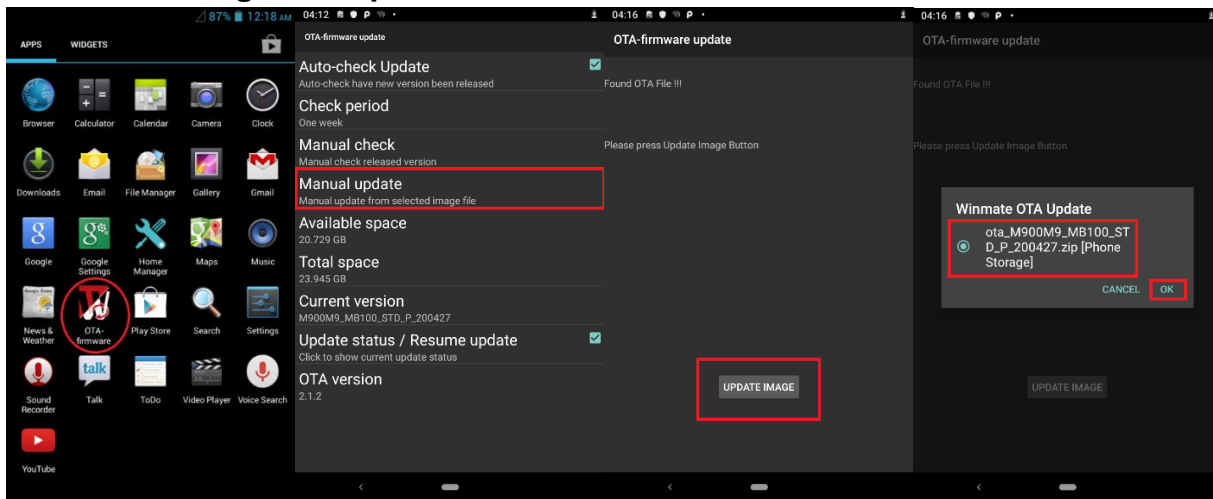

4. Wait for download finish it will take some time.
5. Click **"REBOOT NOW"**.
6. Wait while Ota is updating.

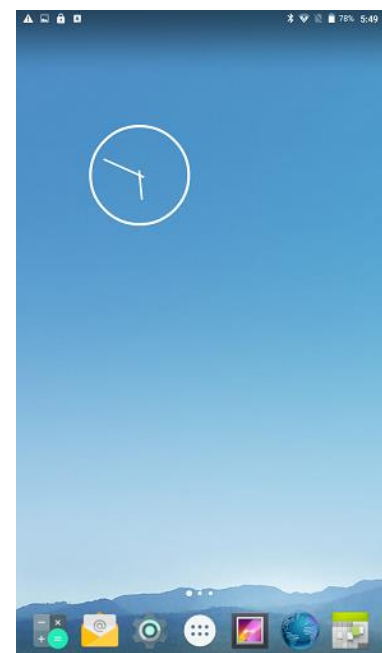
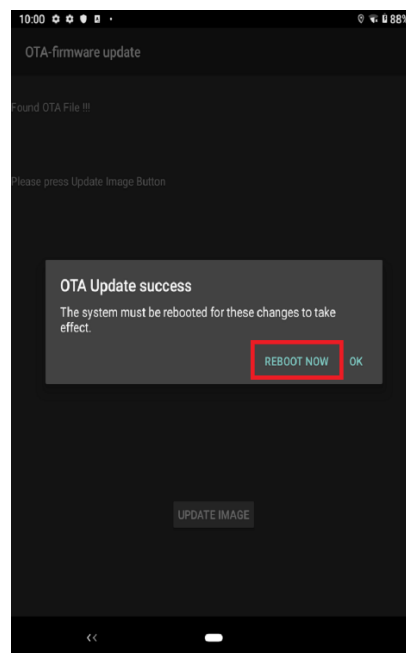
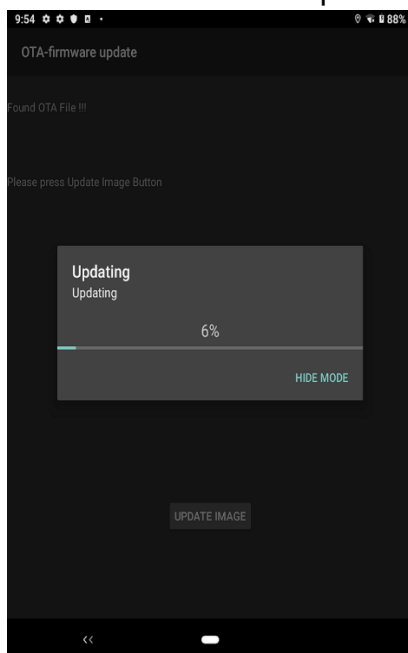

Winmate Inc.
9F, No.111-6, Shing-De Rd., San-Chung District,
New Taipei City 24158, Taiwan, ROC
www.winmate.com

