

# EMX-H310DP

Intel® 8/9th Generation Core™ Processor Thin Mini ITX  
Motherboard With Intel® H310 Chipset

## User's Manual

---

6<sup>th</sup> Ed – 25 January 2022

## FCC Statement



THIS DEVICE COMPLIES WITH PART 15 FCC RULES. OPERATION IS SUBJECT TO THE FOLLOWING TWO CONDITIONS:

- (1) THIS DEVICE MAY NOT CAUSE HARMFUL INTERFERENCE.
- (2) THIS DEVICE MUST ACCEPT ANY INTERFERENCE RECEIVED INCLUDING INTERFERENCE THAT MAY CAUSE UNDESIRE OPERATION.

THIS EQUIPMENT HAS BEEN TESTED AND FOUND TO COMPLY WITH THE LIMITS FOR A CLASS "A" DIGITAL DEVICE, PURSUANT TO PART 15 OF THE FCC RULES.

THESE LIMITS ARE DESIGNED TO PROVIDE REASONABLE PROTECTION AGAINST HARMFUL INTERFERENCE WHEN THE EQUIPMENT IS OPERATED IN A COMMERCIAL ENVIRONMENT. THIS EQUIPMENT GENERATES, USES, AND CAN RADIATE RADIO FREQUENCY ENERGY AND, IF NOT INSTALLED AND USED IN ACCORDANCE WITH THE INSTRUCTION MANUAL, MAY CAUSE HARMFUL INTERFERENCE TO RADIO COMMUNICATIONS.

OPERATION OF THIS EQUIPMENT IN A RESIDENTIAL AREA IS LIKELY TO CAUSE HARMFUL INTERFERENCE IN WHICH CASE THE USER WILL BE REQUIRED TO CORRECT THE INTERFERENCE AT HIS OWN EXPENSE.

## Notice

This guide is designed for experienced users to setup the system within the shortest time. For detailed information, please always refer to the electronic user's manual.

## Copyright Notice

Copyright © 2022 Avalue Technology Inc., ALL RIGHTS RESERVED.

No part of this document may be reproduced, copied, translated, or transmitted in any form or by any means, electronic or mechanical, for any purpose, without the prior written permission of the original manufacturer.

## Trademark Acknowledgement

Brand and product names are trademarks or registered trademarks of their respective owners.

## Disclaimer

Avalue Technology Inc. reserves the right to make changes, without notice, to any product, including circuits and/or software described or contained in this manual in order to improve design and/or performance. Avalue Technology assumes no responsibility or liability for the use of the described product(s), conveys no license or title under any patent, copyright, or masks work rights to these products, and makes no representations or warranties that

these products are free from patent, copyright, or mask work right infringement, unless otherwise specified. Applications that are described in this manual are for illustration purposes only. Avalue Technology Inc. makes no representation or warranty that such application will be suitable for the specified use without further testing or modification.

### Life Support Policy

Avalue Technology's PRODUCTS ARE NOT FOR USE AS CRITICAL COMPONENTS IN LIFE SUPPORT DEVICES OR SYSTEMS WITHOUT THE PRIOR WRITTEN APPROVAL OF Avalue Technology Inc.

As used herein:

1. Life support devices or systems are devices or systems which, (a) are intended for surgical implant into body, or (b) support or sustain life and whose failure to perform, when properly used in accordance with instructions for use provided in the labeling, can be reasonably expected to result in significant injury to the user.
2. A critical component is any component of a life support device or system whose failure to perform can be reasonably expected to cause the failure of the life support device or system, or to affect its safety or effectiveness.

### A Message to the Customer

#### *Avalue Customer Services*

Each and every Avalue's product is built to the most exacting specifications to ensure reliable performance in the harsh and demanding conditions typical of industrial environments. Whether your new Avalue device is destined for the laboratory or the factory floor, you can be assured that your product will provide the reliability and ease of operation for which the name Avalue has come to be known.

Your satisfaction is our primary concern. Here is a guide to Avalue's customer services. To ensure you get the full benefit of our services, please follow the instructions below carefully.

#### *Technical Support*

We want you to get the maximum performance from your products. So if you run into technical difficulties, we are here to help. For the most frequently asked questions, you can easily find answers in your product documentation. These answers are normally a lot more detailed than the ones we can give over the phone. So please consult the user's manual first.

To receive the latest version of the user's manual; please visit our Web site at:

<http://www.avalue.com.tw/>

## EMX-H310DP User's Manual

### *Product Warranty*

Avalue warrants to you, the original purchaser, that each of its products will be free from defects in materials and workmanship for two years from the date of purchase.

This warranty does not apply to any products which have been repaired or altered by persons other than repair personnel authorized by Avalue, or which have been subject to misuse, abuse, accident or improper installation. Avalue assumes no liability under the terms of this warranty as a consequence of such events. Because of Avalue's high quality-control standards and rigorous testing, most of our customers never need to use our repair service. If any of Avalue's products is defective, it will be repaired or replaced at no charge during the warranty period. For out-of-warranty repairs, you will be billed according to the cost of replacement materials, service time, and freight. Please consult your dealer for more details. If you think you have a defective product, follow these steps:

1. Collect all the information about the problem encountered. (For example, CPU type and speed, Avalue's products model name, hardware & BIOS revision number, other hardware and software used, etc.) Note anything abnormal and list any on-screen messages you get when the problem occurs.
2. Call your dealer and describe the problem. Please have your manual, product, and any helpful information available.
3. If your product is diagnosed as defective, obtain an RMA (return material authorization) number from your dealer. This allows us to process your good return more quickly.
4. Carefully pack the defective product, a complete Repair and Replacement Order Card and a photocopy proof of purchase date (such as your sales receipt) in a shippable container. A product returned without proof of the purchase date is not eligible for warranty service.
5. Write the RMA number visibly on the outside of the package and ship it prepaid to your dealer.

# Content

<b>1. Getting Started</b>	<b>8</b>
1.1 Safety Precautions	8
1.2 Packing List	8
1.3 Document Amendment History	9
1.4 Manual Objectives	10
1.5 System Specifications	11
1.6 Architecture Overview—Block Diagram	17
<b>2. Hardware Configuration</b>	<b>18</b>
2.1 Product Overview	19
2.2 Jumper and Connector List	21
2.3 Setting Jumpers & Connectors	23
2.3.1 Serial port 1 pin9 signal select (JRI1)	23
2.3.2 BIOS ME function configuration (JME1)	23
2.3.3 Clear CMOS (JCMOS1)	24
2.3.4 JPGE connector (JPGE1)	24
2.3.5 AT/ATX Power Mode Select (JSATX1)	25
2.3.6 General purpose I/O connector (DIO1)	25
2.3.7 ATX Power connector (ATXPWR1)	26
2.3.8 USB connector (JUSB1)	26
2.3.9 USB connector (JUSB2)	27
2.3.10 Battery connector (BAT1)	27
2.3.11 LPC connector (JLPC1)	28
2.3.12 Miscellaneous setting connector (SPI1)	28
2.3.13 Speaker connector (SPK1)	29
2.3.14 LCD Inverter connector (JBKL1)	29
2.3.15 Front Panel connector (JFP1)	30
2.3.16 CPU fan connector (CPUFAN1)	30
2.3.17 System fan connector (SYSFAN1)	31
2.3.18 Auxiliary Panel connector (JAUXP1)	31
2.3.19 Serial port connector (COM1)	32
2.3.20 Serial port connector (COM2)	32
2.3.21 Serial port connector (COM3)	33
2.3.22 Serial port connector (COM4)	33
2.3.23 J1RS1 connector (J1RS1)	34
2.3.24 Front Audio connector (FAUD1)	34
2.3.25 PS/2 keyboard & mouse header (KBMS1)	35

## EMX-H310DP User's Manual

2.3.26	SATA Power connector 1/2 (SPWR1/2)	35
2.3.27	SMBus connector (JSMB1)	36
2.3.28	eDP-Panel connector (EDP 1)	36
2.3.29	LVDS connector (LVDS1)	37
2.3.30	DC power-in connector (PWR1)	38
<b>3</b>	<b>BIOS Setup</b>	<b>39</b>
3.1	Introduction	40
3.2	Starting Setup	40
3.3	Using Setup	41
3.4	Getting Help	42
3.5	In Case of Problems	42
3.6	BIOS setup	43
3.6.1	Main Menu	43
3.6.1.1	System Language	44
3.6.1.2	System Date	44
3.6.1.3	System Time	44
3.6.2	Advanced Menu	44
3.6.2.1	CPU Configuration	45
3.6.2.1.1	CPU - Power Management Control	46
3.6.2.2	PCH-FW Configuration	47
3.6.2.2.1	Firmware Update Configuration	47
3.6.2.3	Trusted Computing	48
3.6.2.4	ACPI Settings	48
3.6.2.5	Super IO Configuration	49
3.6.2.5.1	Serial Port 1 Configuration	50
3.6.2.5.2	Serial Port 2 Configuration	50
3.6.2.5.3	Serial Port 3 Configuration	51
3.6.2.5.4	Serial Port 4 Configuration	51
3.6.2.6	NCT6106D H/W Monitor	52
3.6.2.6.1	Smart Fan Configuration	52
3.6.2.7	S5 RTC Wake Settings	54
3.6.2.8	Serial Port Console Redirection	54
3.6.2.8.1	Legacy Console Redirection Settings	55
3.6.2.9	USB Configuration	56
3.6.2.10	Network Stack Configuration	57
3.6.3	Chipset	57
3.6.3.1	System Agent (SA) Configuration	58
3.6.3.1.1	Memory Configuration	58
3.6.3.1.2	Graphics Configuration	59
3.6.3.1.3	DMI/OPI Configuration	60

3.6.3.1.4	PEG Port Configuration .....	60
3.6.3.1.4.1	PEG Port Feature Configuration.....	61
3.6.3.2	PCH-IO Configuration.....	62
3.6.3.2.1	PCI Express Configuration .....	62
3.6.3.2.1.1	Intel I211/I210 LAN Chip (PCI-E Port 6).....	63
3.6.3.2.1.2	M.2 KeyE (PCI-E Port 7~8) .....	64
3.6.3.2.1.3	Intel I211/I210 LAN Chip (PCI-E Port 11).....	65
3.6.3.2.2	SATA And RST Configuration .....	66
3.6.3.2.3	HD Audio Configuration .....	67
3.6.3.3	Board Configuration.....	67
3.6.4	Security.....	69
3.6.4.1	Secure Boot .....	69
3.6.4.1.1	Restore Factory Keys .....	70
3.6.4.1.2	Key Management.....	71
3.6.5	Boot .....	71
3.6.6	Save & Exit.....	72
3.6.5.1	Save Changes and Reset.....	72
3.6.5.2	Discard Changes and Reset.....	73
3.6.5.3	Restore Defaults .....	73
3.6.5.4	Launch EFI Shell from filesystem device .....	73
<b>4.</b>	<b>Drivers Installation.....</b>	<b>74</b>
4.1	Install Chipset Driver .....	75
4.2	Install VGA Driver.....	76
4.3	Install ME Driver .....	78
4.4	Install Audio Driver .....	79
4.5	Install LAN Driver .....	80
4.6	Install RST Driver .....	82
<b>5.</b>	<b>Mechanical Drawing .....</b>	<b>84</b>

# 1. Getting Started

## 1.1 Safety Precautions

### Warning!



Always completely disconnect the power cord from your chassis whenever you work with the hardware. Do not make connections while the power is on. Sensitive electronic components can be damaged by sudden power surges. Only experienced electronics personnel should open the PC chassis.

### Caution!



Always ground yourself to remove any static charge before touching the CPU card. Modern electronic devices are very sensitive to static electric charges. As a safety precaution, use a grounding wrist strap at all times. Place all electronic components in a static-dissipative surface or static-shielded bag when they are not in the chassis.

## 1.2 Packing List

Before you begin installing your single board, please make sure that the following materials have been shipped:

- 1 x EMX-H310DP motherboard
- 2 x SATA cables
- 1 x SATA power cable
- 1 x I/O Shield



---

If any of the above items is damaged or missing, contact your retailer.

---



### 1.3 Document Amendment History

Revision	Date	By	Comment
1 <sup>st</sup>	May 2020	Avalue	Initial Release
2 <sup>nd</sup>	July 2020	Avalue	Update System Specifications
3 <sup>rd</sup>	October 2020	Avalue	Update Setting Jumpers & Connectors
4 <sup>th</sup>	March 2021	Avalue	Update Setting Jumpers & Connectors
5 <sup>th</sup>	October 2021	Avalue	Update System Specifications
6 <sup>th</sup>	January 2022	Avalue	Update System Specifications

### 1.4 Manual Objectives

This manual describes in details Avalue Technology EMX-H310DP Single Board.

We have tried to include as much information as possible but we have not duplicated information that is provided in the standard IBM Technical References, unless it proved to be necessary to aid in the understanding of this board.

We strongly recommend that you study this manual carefully before attempting to set up EMX-H310DP or change the standard configurations. Whilst all the necessary information is available in this manual we would recommend that unless you are confident, you contact your supplier for guidance.

Please be aware that it is possible to create configurations within the CMOS RAM that make booting impossible. If this should happen, clear the CMOS settings, (see the description of the Jumper Settings for details).

If you have any suggestions or find any errors regarding this manual and want to inform us of these, please contact our Customer Service department with the relevant details.

## 1.5 System Specifications

System	
<b>CPU</b>	Intel® 8th Gen Supports LGA 1151 CPU Up to 65W Max Intel® 9th Gen Supports 4 core & 6 core CPU (TDP: 65W), 8 core CPU, only support CPU TDP up to 35W Max.
<b>BIOS</b>	AMI uEFI BIOS, 256Mbit SPI Flash ROM
<b>System Chipset</b>	Intel® H310 Chipset
<b>I/O Chip</b>	Nuvoton® NCT6106D
<b>System Memory</b>	Two 260-pin DDR4 2400/2666MHz SO-DIMM socket, supports up to 64GB Max (non ECC only)
<b>Watchdog Timer</b>	H/W Reset, 5~255 seconds/5~255 minutes
<b>H/W Status Monitor</b>	Monitoring CPU & System Temperature and Voltage
<b>TPM</b>	Onboard Infineon SLB9665 support TPM 2.0
Expansion Slot	
<b>M.2</b>	1 x M.2 (2230) E-Key, support WiFi module 1 x M.2 (3042/2242/2260/2280) B-Key, support WWAN+GNSS (USB2.0) with SIM card slot & SSD (SATA)
<b>PCIe</b>	1 x PCI-e x16 (Max TDP 25W)
Storage	
<b>SATA</b>	2 x SATA III
Edge I/O	
<b>LAN</b>	1 x Intel® I219LM Gigabit Ethernet PHY 2 x Intel® I210AT PCI-e Gigabit Ethernet (Co-lay Intel® I211AT/I210AT)
<b>USB 3.1</b>	4 x USB 3.1 Gen 1 at I/O
<b>HDMI</b>	3 x HDMI 1.4b: 3840 x 2160 @ 30 Hz
Onboard I/O	
<b>COM</b>	COM 1: Support RS232/422/485 selected by BIOS 1 x 2 x 3 pin, pitch 2.00mm connector for COM1 support RS422/485 connector, Pin 5 with +5V(JIRS1) 1 x 2 x 3 pin, pitch 2.00mm connector(for jumper setting) for COM 1 support RS232 with Pin 9,+5V/+12V/RI by jumper 4 x 2 x 5 pin, pitch 2.00mm connector for COM 1~4 support RS-232 connector
<b>USB 2.0</b>	1 x 2 x 5 pin pitch 2.54mm connector for 2 x USB 2.0 1 x 1 x 5 pin pitch 2.54mm connector for 1 x USB 2.0 (JUSB2)
<b>GPIO</b>	1 x 2 x 10 pin, pitch 2.00mm connector for GPIO: 16 bits & +5VS Level SMBus
<b>SATA Power</b>	2 x SATA power connectors

## EMX-H310DP User's Manual

<b>CPU/System FAN</b>	1 x 1 x 4 pin, pitch 2.54mm CPU fan connector with smart fan function supported 1 x 1 x 4 pin, pitch 2.54mm System fan connector with smart fan function supported
<b>Buzzer</b>	1 x Onboard buzzer
<b>Front Panel</b>	1 x 2 x 5 pin, pitch 2.54mm connector for front panel
<b>RTC Battery</b>	1 x 2 Pin Pitch 1.25mm Vertical type battery connector
<b>AT/ATX Selector</b>	1 x 1 x 3 pin pitch 2.00mm connector for AT/ATX jumper
<b>Clear CMOS</b>	1 x 1 x 3pin, pitch 2.54mm connector for COMS Clear
<b>LVDS</b>	1 x 2 x 20 pin, pitch 1.25mm connector for LVDS
<b>LCD Inverter</b>	1 x 1 x 5 pin, pitch 2.00mm Wafer connector for LCD inverter backlight connector (5V/12V)
<b>LPC</b>	1 x 2 x 5 pin, pitch 2.0mm connector for LPC
<b>BIOS SPI</b>	1 x 2 x 4 pin, pitch 2.00mm connector for BIOS SPI
<b>Audio</b>	1 x 2 x 5 pin, pitch 2.54mm connector for front Audio
<b>Activity Indicator LED</b>	1 x 2 x 3 pin, pitch 2.00mm connector for LAN1 ~LAN3 Activity Indicator LED Power good LED
<b>DC-Input</b>	1 x 2 x 2 pin for DC in power connector DC in +12V~26V(+/-5%) 4-pin DC-in
<b>Amp Connector</b>	1 x 4 pin, pitch wafer 2.00mm connector for 6W Speaker
<b>PS2</b>	1 x PS2 KB/MS by pin header
<b>Display</b>	
<b>Graphic Chipset</b>	Intel® 8/9th Generation CPU integrated
<b>Spec. &amp; Resolution</b>	3 x HDMI 1.4b: 3840 x 2160 @ 30 Hz Note: This resolution is actual test result. Intel resolution: 4096x2160@24Hz 2CH 18/24bits LVDS 1920 x 1080 (Chrontel. CH7511B eDP to LVDS Converter)
<b>Multiple Display</b>	Dual Display
<b>Audio</b>	
<b>Audio Codec</b>	Realtek ALC888S HD Audio Decoding Controller
<b>Amplifier</b>	TI TPA3113D2PWP Stereo Class-D 6W amplifier
<b>Ethernet</b>	
<b>LAN Chipset</b>	1 x Intel® I219LM Gigabit Ethernet PHY 2 x Intel® I210AT PCI-e Gigabit Ethernet (Co-lay Intel® I211AT/I210AT)
<b>LAN Spec.</b>	10/100/1000 Base-Tx GbE compatible
<b>Mechanical &amp; Environmental Specification</b>	
<b>Power Requirement</b>	DC in +12V~26V(+/-5%) 4-pin DC-in
<b>ACPI</b>	Single power ATX Support S0, S3, S4, S5 ACPI 5.0 Compliant
<b>Power Mode</b>	AT / ATX mode Switchable Through Jumper
<b>Operating Temp.</b>	0°C ~ 60°C with 0.2m/s air flow

<b>Storage Temp.</b>	-40~ +75°C
<b>Operating Humidity</b>	40°C @ 95% Relative Humidity, Non-condensing
<b>Size (L x W)</b>	6.7" x 6.7" (170mm x 170mm)
<b>Weight</b>	0.40 kg
<b>Vibration Test</b>	<p>Package Vibration Test</p> <p>Reference IEC60068-2-64 Testing procedures</p> <p>Test Fh: Vibration broadband random Test</p> <ol style="list-style-type: none"> <li>1. PSD: 0.026G<sup>2</sup>/Hz, 2.16 Grms</li> <li>2. Non-operation mode</li> <li>3. Test Frequency: 5-500Hz</li> <li>4. Test Axis: X,Y and Z axis</li> <li>5. 30 min. per each axis</li> <li>6. IEC 60068-2-64 Test:Fh</li> </ol> <p>Random Vibration Operation</p> <p>Reference IEC60068-2-64 Testing procedures</p> <p>Test Fh : Vibration broadband random Test</p> <ol style="list-style-type: none"> <li>1. PSD: 0.00454G<sup>2</sup>/Hz, 1.5 Grms</li> <li>2. Operation mode</li> <li>3. Test Frequency : 5-500Hz</li> <li>4. Test Axis : X,Y and Z axis</li> <li>5. 30 minutes per each axis</li> <li>6. IEC 60068-2-64 Test:Fh</li> </ol> <p>Random Vibration Non Operation</p> <p>Reference IEC60068-2-64 Testing procedures</p> <p>Test Fh : Vibration broadband random Test</p> <ol style="list-style-type: none"> <li>1. PSD: 0.01818G<sup>2</sup>/Hz, 3.0 Grms</li> <li>2. Non Operation mode</li> <li>3. Test Frequency : 5-500Hz</li> <li>4. Test Axis : X,Y and Z axis</li> <li>5. 30 minutes per each axis</li> <li>6. IEC 60068-2-64 Test:Fh</li> </ol>
<b>Drop Test</b>	<p>Packing Drop</p> <p>Reference ISTA 2A, Method : IEC-60068-2-32 Test: Ed</p> <p>Drop Test</p> <ol style="list-style-type: none"> <li>1 One corner , three edges, six faces</li> <li>2 ISTA 2A, IEC-60068-2-32 Test:Ed</li> </ol>
<b>OS Information</b>	Win10 64bit, Linux

# EMX-H310DP User's Manual



**Note:** Specifications are subject to change without notice.

## User condition suggestion:

Per motherboard wide voltage power solution:

<b>Power Adapter</b> AWG: 14, DC Length: 400~1000mm	<b>12V</b>	<b>24V</b>
<b>CPU TDP: 35W</b>	✓	✓
<b>CPU TDP: 65W</b>	✗	✓

- For DC-IN 12V/24V  
Total power supply should be at least 144W, (Exclude PCI-e x16 device)  
Total power supply should be at least 174W, (Include PCI-e x16 device)  
Power Adapter suggestion: AWG: 14, DC Length: 400~1000mm.
- PCI-e x16 Slot device TDP: 25W Max.
- 1U low profile CPU cooler can only be used for CPU TDP: 35W or lower.
- Suggestion Cooler type

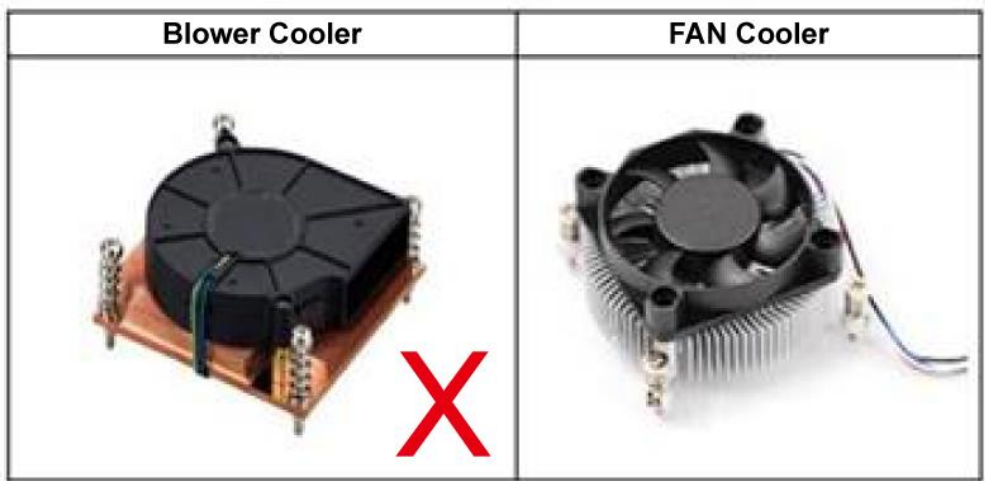

Surrounding components of processor will generate heat and need to be cool down by FAN Cooler

- ATXPWR1 is suggest for internal test only, if needed, cable suggestion: AWG: 16, DC Length: 100mm Max. & 24V DC-in adapter.

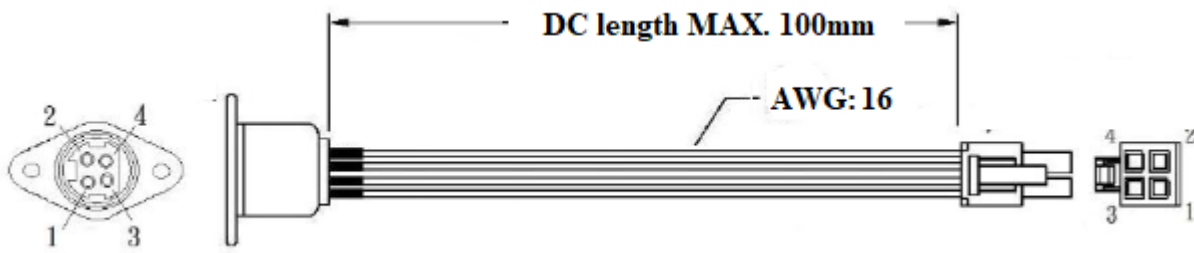

- By referring to INTEL Thin Mini-ITX Based PC System Design Guide for your system product. Reference to below link PDF file, Item 5 Mechanical & Item 6 Low Profile Reference Heat Pipe Thermal Solution.

<https://www.intel.com/content/dam/www/public/us/en/documents/product-specifications/thin-mini-itx-based-pc-system-design-guide-rev-1-2.pdf>

Avalue do not recommend to design fanless system product with EMX-H310DP.

For Fanless design, please check especially with CPU temperature; it is highly recommend to add thermal solutions to avoid over specification.

Especially, it is highly recommended to carefully design thermal solutions for the components marked in green area.

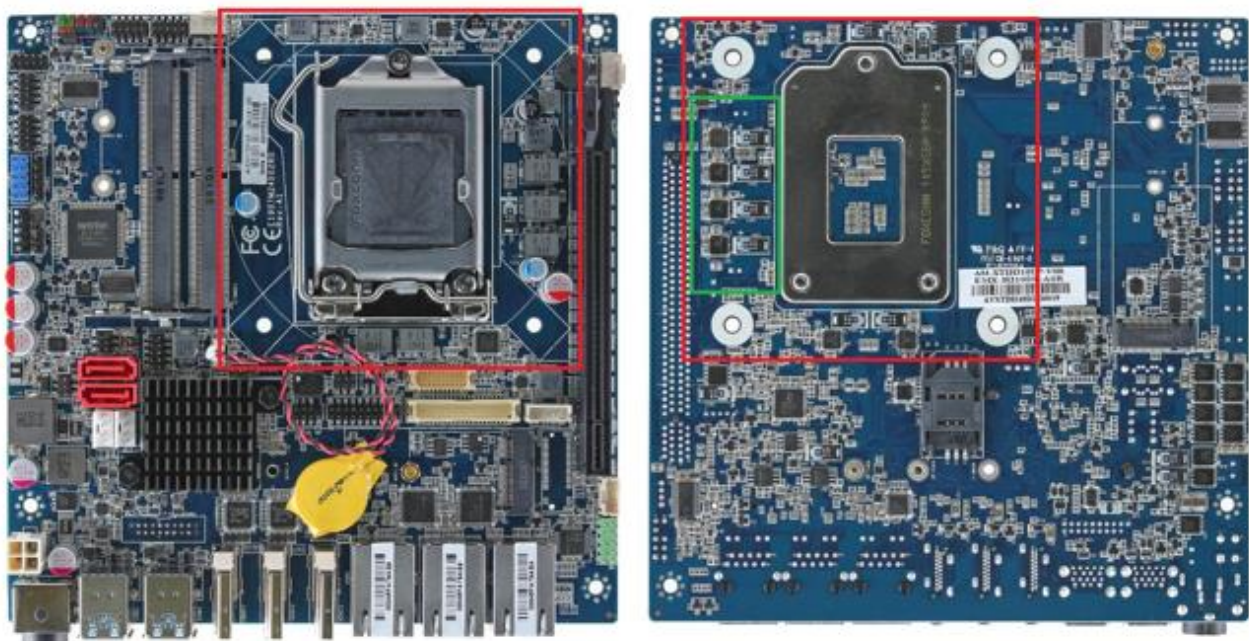

## EMX-H310DP User's Manual

- IOTG CPU support list:

Intel C246 Express Chipset (CPU with ECC DRAM support)		Intel® C246 Chipset (CPU with ECC DRAM support)	
<b>8th Generation Intel® Core™ Processors - 14nm Coffee Lake Platform</b>		<b>9th Generation Intel® Xeon® Processor E Family (Workstation) - 14nm Coffee Lake-S Refresh</b>	
i7-8700		E-2278GEL	O
i7-8700T		E-2226GE	O
i5-8500		<b>9th Generation Intel® Core™ Processors - 14nm Coffee Lake-S Platform</b>	
i5-8500T		i7-9700TE	
i3-8100	O	i5-9500E	
i3-8100T	O	i5-9500TE	
<b>Intel® Pentium® Processors - 14nm Coffee Lake Platform</b>		i3-9100E	O
G5400	O	i3-9100TE	O
G5400T	O		
<b>Intel® Celeron® Processors - 14nm Coffee Lake Platform</b>			
G4900	O		
G4900T	O		

Note: "O" means support ECC

Information refer to Intel® 's IOTG documentations.

- Display Options:

Display option	Default	
LVDS	Enabled	Disabled
HDMI 1	One out of three.	Two out of three.
HDMI 2		
HDMI 3		

Display Priority: LVDS>HDMI1>HDMI2>HDMI3

Due to Intel® H310 Chipset only support dual display.

LVDS is configured through BIOS setting.



## 1.6 Architecture Overview—Block Diagram

The following block diagram shows the architecture and main components of EMX-H310DP.

**only support 26V**

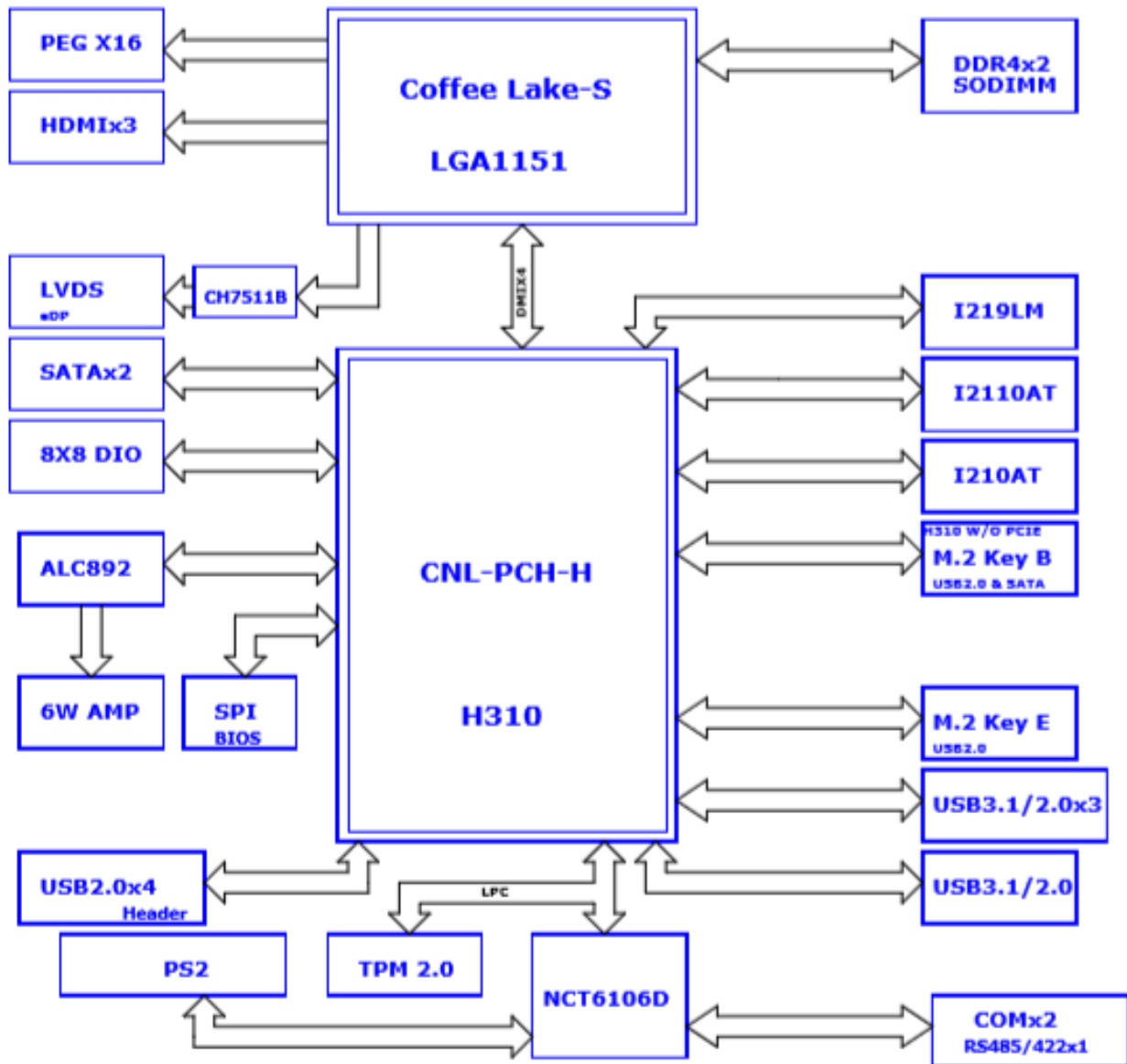

# 2. Hardware Configuration

---

## 2.1 Product Overview

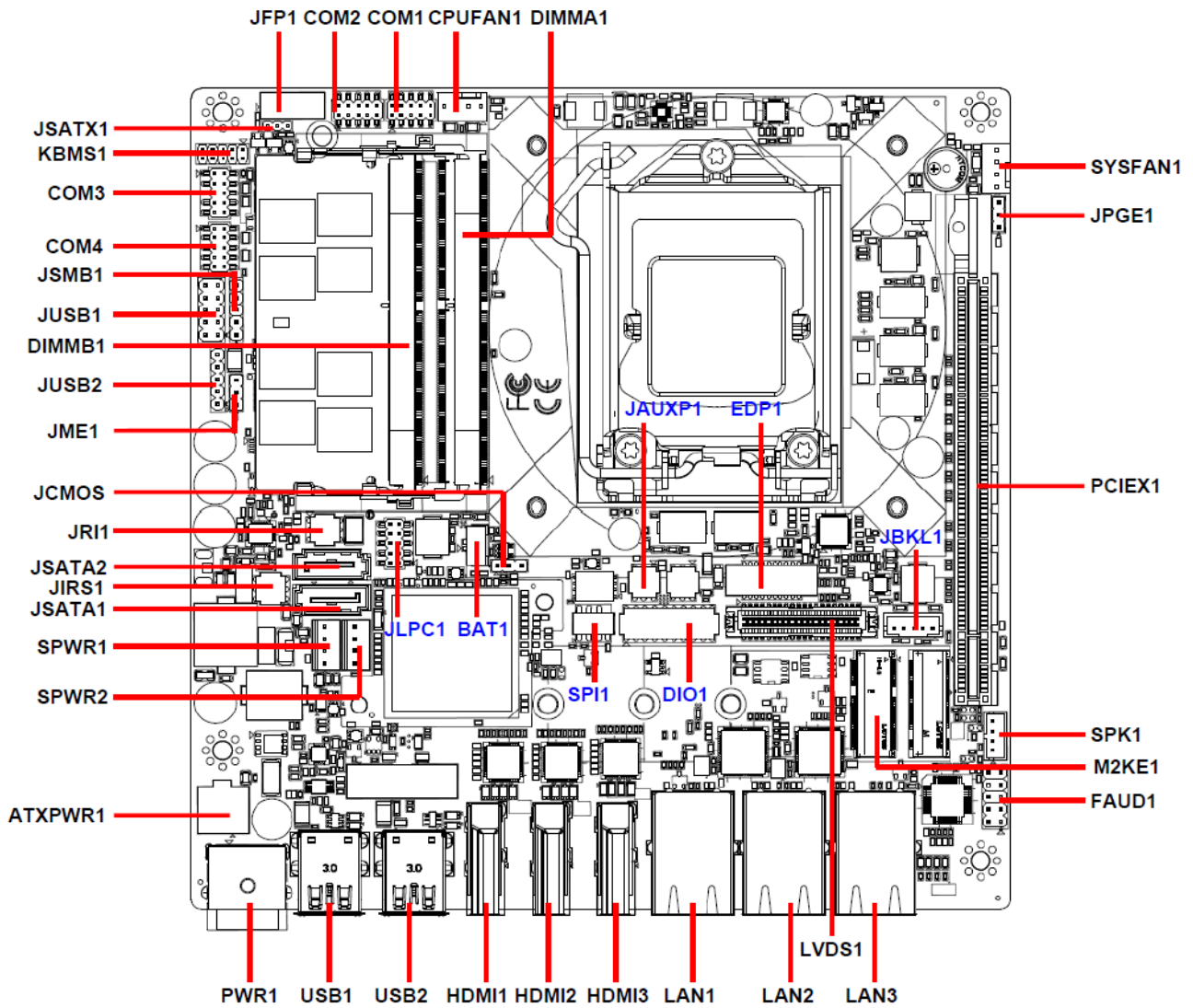

# EMX-H310DP User's Manual

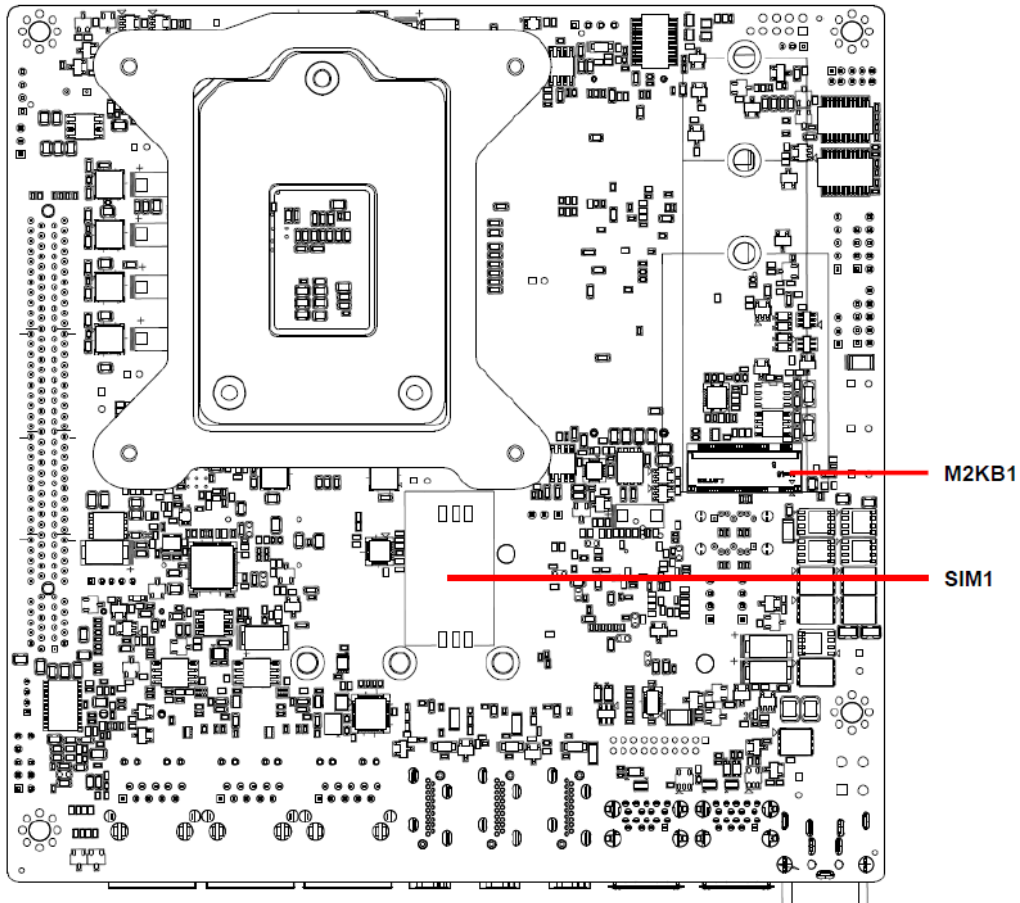

## 2.2 Jumper and Connector List

You can configure your board to match the needs of your application by setting jumpers. A jumper is the simplest kind of electric switch.

It consists of two metal pins and a small metal clip (often protected by a plastic cover) that slides over the pins to connect them. To “close” a jumper you connect the pins with the clip. To “open” a jumper you remove the clip. Sometimes a jumper will have three pins, labeled 1, 2, and 3. In this case, you would connect either two pins.

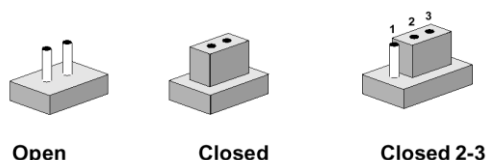

The jumper settings are schematically depicted in this manual as follows:



A pair of needle-nose pliers may be helpful when working with jumpers.

Connectors on the board are linked to external devices such as hard disk drives, a keyboard, or floppy drives. In addition, the board has a number of jumpers that allow you to configure your system to suit your application.

If you have any doubts about the best hardware configuration for your application, contact your local distributor or sales representative before you make any changes.

The following tables list the function of each of the board's jumpers and connectors.

### Jumpers

Label	Function	Note
JRI1	Serial port 1 pin9 signal select	3 x 2 header, pitch 2.00mm
JME1	BIOS ME function configuration	3 x 1 header, pitch 2.54mm
JSATX1	AT/ATX Power Mode Select	3 x 1 header, pitch 2.00mm
JCMOS1	Clear CMOS	3 x 1 header, pitch 2.54mm
JPGE1	JPGE connector	3 x 1 header, pitch 2.54mm

### Connectors

Label	Function	Note
CPUFAN1	CPU fan connector	4 x 1 wafer, pitch 2.54mm
SYSFAN1	System fan connector 1 (with smart fan function supported)	4 x 1 wafer, pitch 2.54mm
JAUXP1	Auxiliary Panel connector	3 x 2 header, pitch 2.00mm

**EMX-H310DP User's Manual**

<b>SPI1</b>	Miscellaneous setting connector	4 x 2 header, pitch 2.00mm
<b>COM1~4</b>	Serial Port1/2/3/4 connector	5 x 2 header, pitch 2.00 mm
<b>FAUD1</b>	Front Audio connector	5 x 2 header, pitch 2.54mm
<b>KBMS1</b>	PS/2 keyboard & mouse header	5 x 2 header, pitch 2.00 mm
<b>SPWR1/2</b>	SATA Power connector 1/2	4 x 1 wafer, pitch 2.54mm
<b>DIO1</b>	General purpose I/O connector	10 x 2 header, pitch 2.00mm
<b>SPK1</b>	Speaker connector	4 x 1 wafer, pitch 2.00 mm
<b>JBKL1</b>	LCD Inverter connector	5 x 1 wafer, pitch 2.00 mm
<b>JFP1</b>	Front Panel connector	5 x 2 header, pitch 2.54mm
<b>LAN1/2/3</b>	2 x RJ-45	
<b>JUSB1</b>	USB connector	5 x 2 header, pitch 2.54mm
<b>JUSB2</b>	USB connector	5 x 1 header, pitch 2.54mm
<b>JSMB</b>	SMBus connector	3 x 2 header, pitch 2.00 mm
<b>EDP1</b>	eDP-Panel connector	10 x 2 wafer, pitch 1.25mm
<b>LVDS1</b>	LVDS connector	20 x 2 wafer, pitch 1.25mm
<b>J1RS1</b>	J1RS1 connector	3 x 2 header, pitch 2.00 mm
<b>JLPC1</b>	LPC connector	5 x 2 header, pitch 2.00mm
<b>BAT1</b>	Battery connector	2 x 1 wafer, pitch 1.25mm
<b>ATXPWR1</b>	ATX Power connector	2 x 2 wafer, pitch 4.20mm
<b>HDMI1~3</b>	HDMI connector	
<b>PWR1</b>	Power connector	
<b>USB1/2</b>	USB connector	
<b>JSATA1/2</b>	Serial ATA connector	
<b>DIMMA1</b>	260-pin DIMM slot 1	
<b>DIMMB1</b>	260-pin DIMM slot 2	
<b>M2KE1</b>	M.2 Key E	
<b>M2KB1</b>	M.2 Key B	
<b>PCIEX1</b>	PCI-e x16 slot	
<b>PWR1</b>	DC power-in connector	
<b>SIM1</b>	SIM card slot	

## 2.3 Setting Jumpers & Connectors

### 2.3.1 Serial port 1 pin9 signal select (JRI1)

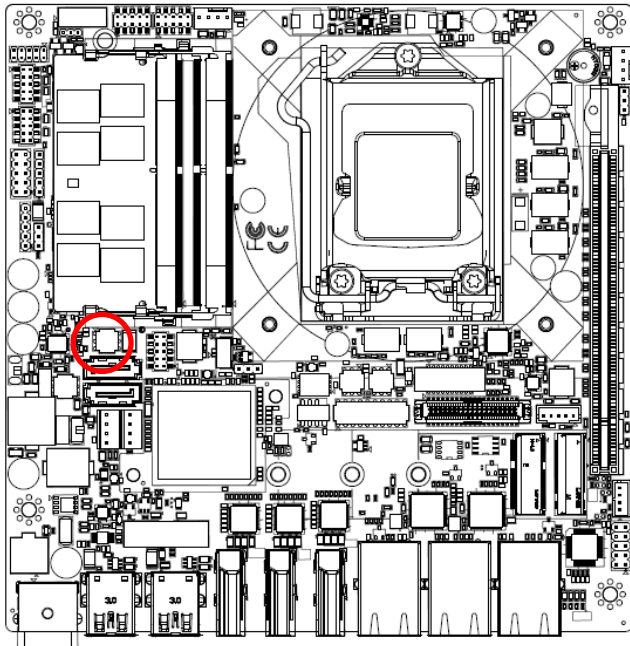

Ring\*

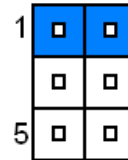

+12V

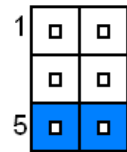

+5V

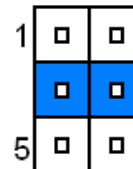

\* Default

### 2.3.2 BIOS ME function configuration (JME1)

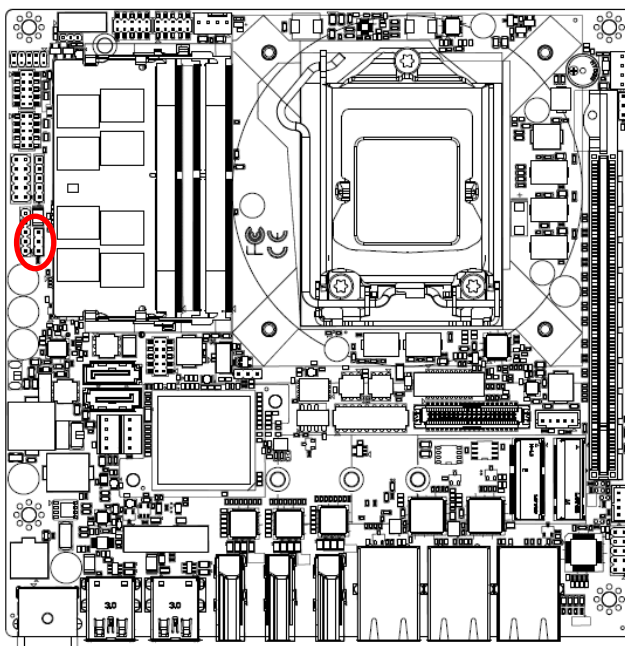

Enable ME \*

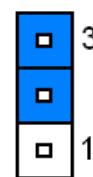

Disable ME

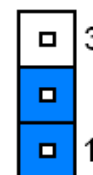

\* Default

### 2.3.3 Clear CMOS (JCMOS1)

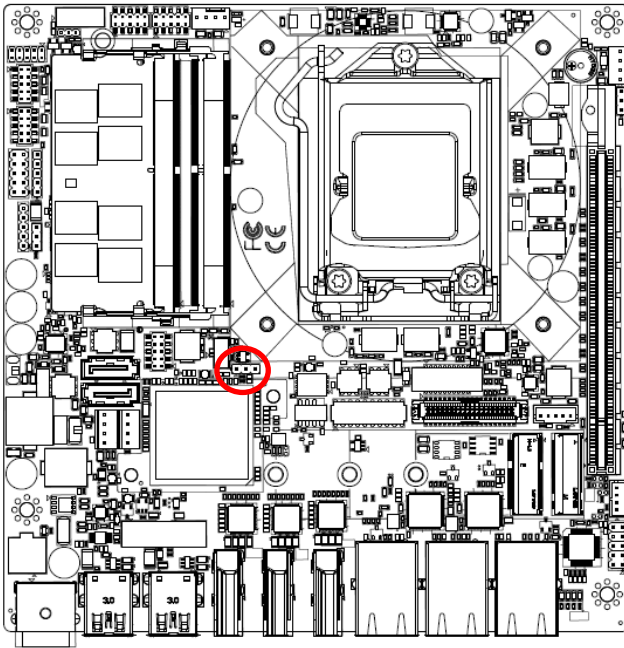

Protect\*

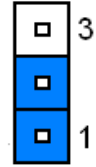

Clear CMOS

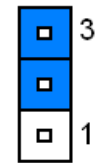

\* Default

### 2.3.4 JPGE connector (JPGE1)

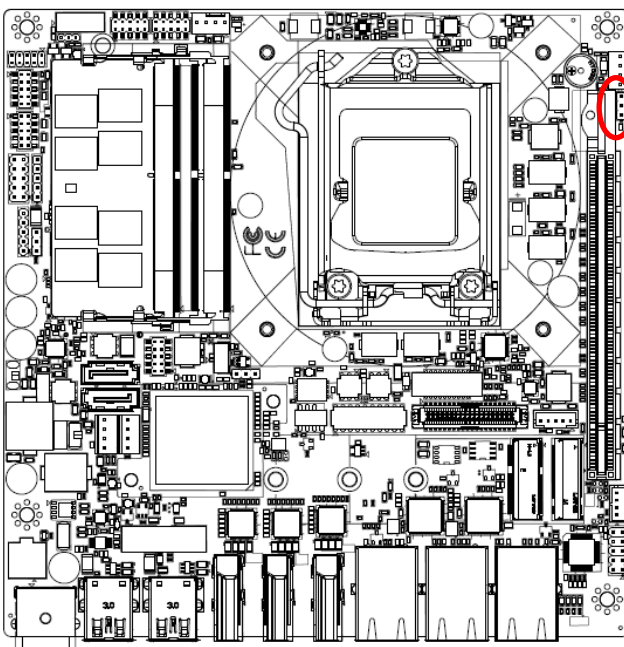

PCIE X16\*

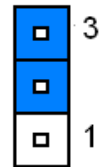

PCIE X8

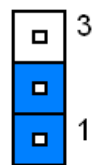

\* Default



### 2.3.5 AT/ATX Power Mode Select (JSATX1)

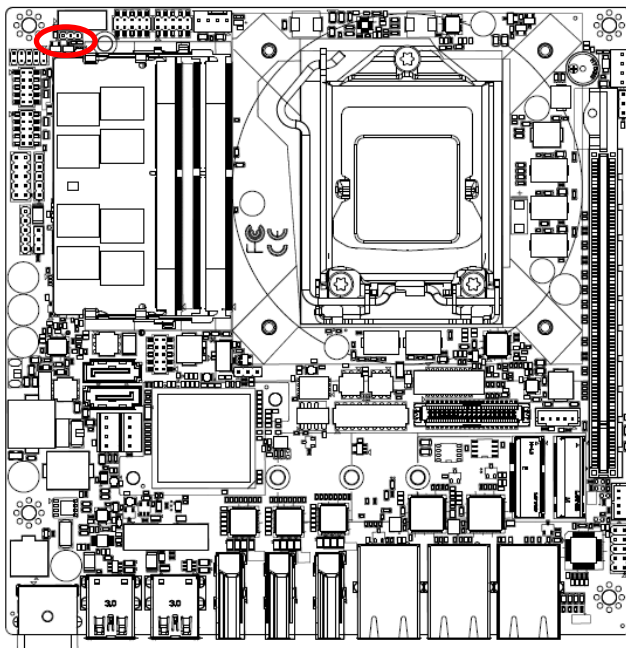

AT

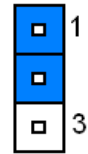

ATX\*

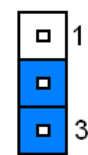

\* Default

### 2.3.6 General purpose I/O connector (DIO1)

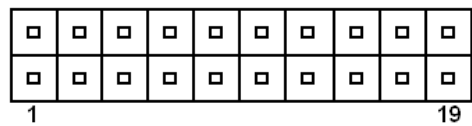
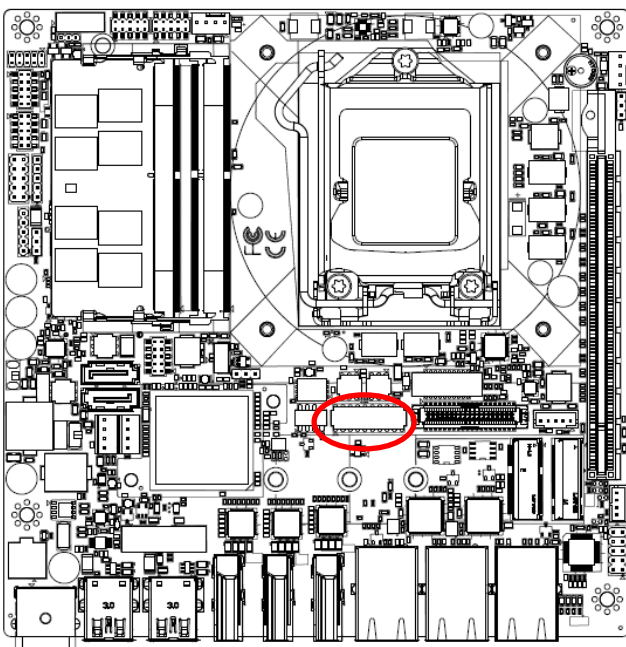

Signal	PIN	PIN	Signal
DI0	1	2	DO0
DI1	3	4	DO1
DI2	5	6	DO2
DI3	7	8	DO3
DI4	9	10	DO4
DI5	11	12	DO5
DI6	13	14	DO6
DI7	15	16	DO7
5V_SMB_CLK	17	18	5V_SMB_DATA
GND	19	20	+5V

2.3.7 ATX Power connector (ATXPWR1)

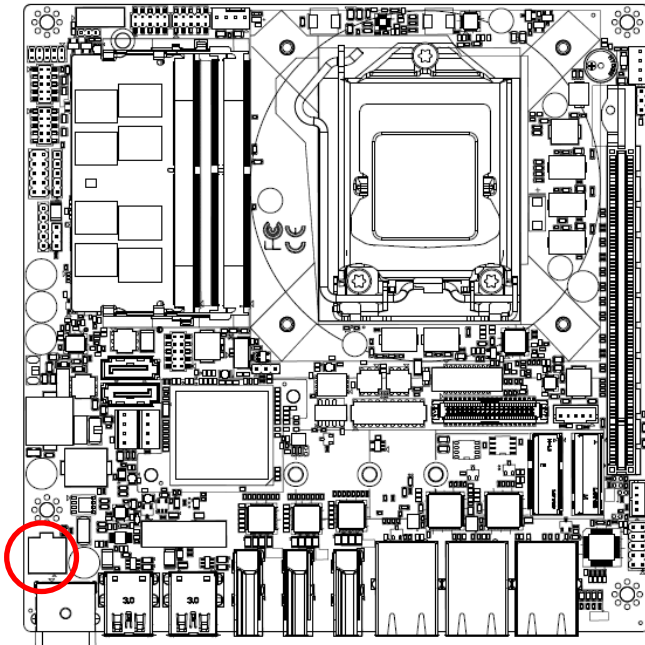

Signal	PIN	PIN	Signal
+VDC12_26V	4	3	+VDC12_26V
GND	2	1	GND

2.3.8 USB connector (JUSB1)

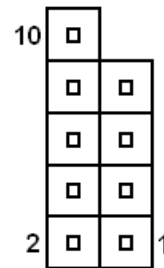
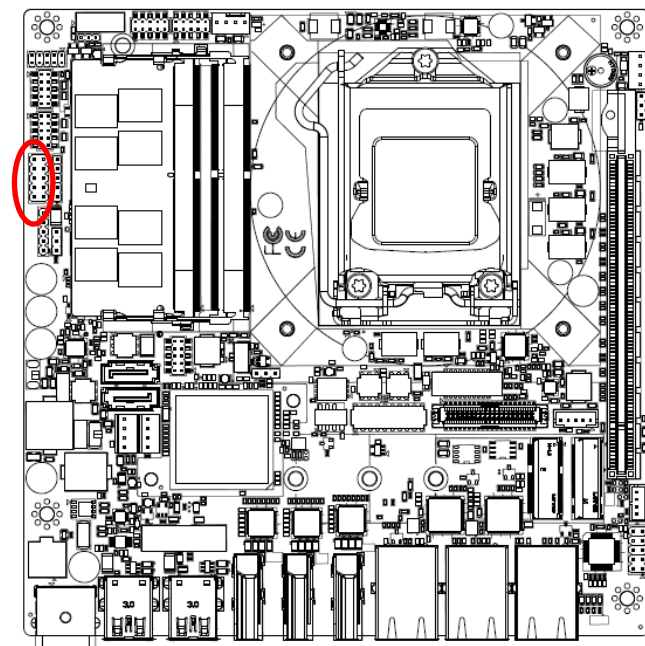

Signal	PIN	PIN	Signal
NC	10		
GND	8	7	GND
USB_P6	6	5	USB_P5
USB_N6	4	3	USB_N5
+V5A_USB_56	2	1	+V5A_USB_56

### 2.3.9 USB connector (JUSB2)

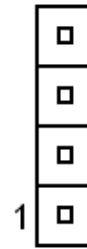
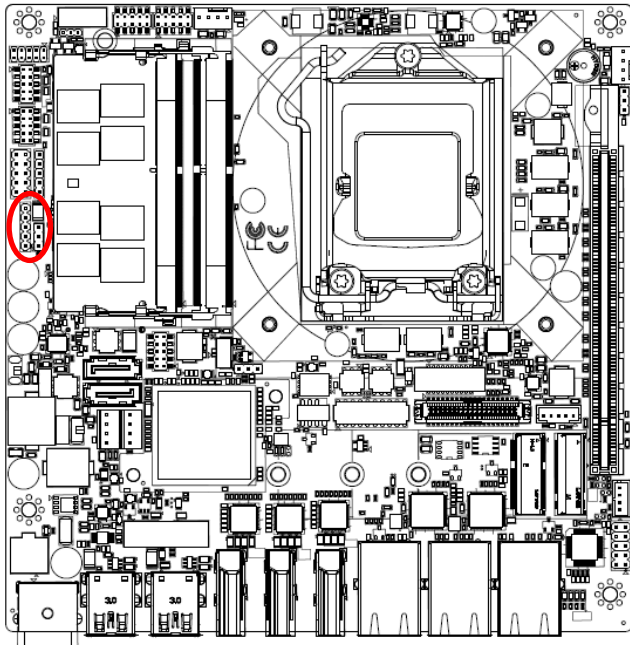

PIN	Signal
4	GND
3	USB_P7
2	USB_N7
1	+V5A_USB_711

### 2.3.10 Battery connector (BAT1)

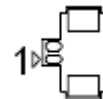
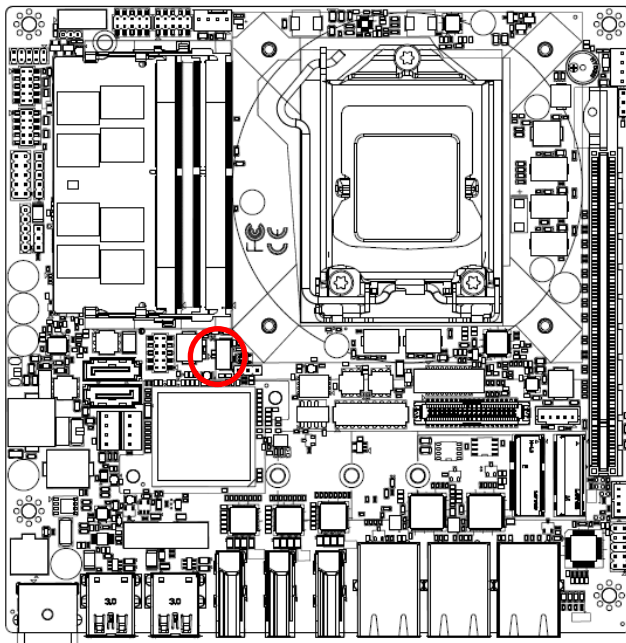

PIN	Signal
1	+3.3V
2	GND

2.3.11 LPC connector (JLPC1)

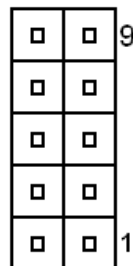
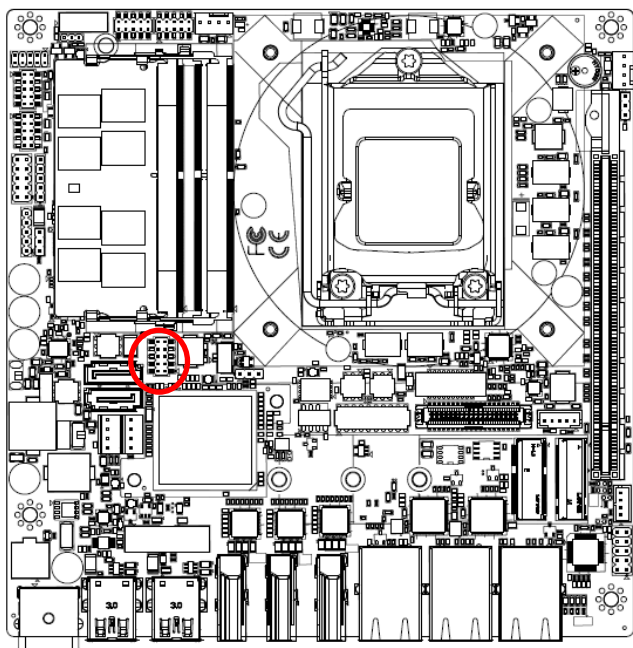

Signal	PIN	PIN	Signal
GND	10	9	LPC_SERIRQ
LPC_DEG_CLK	8	7	LPC_AD3
LPC_FRAME#	6	5	LPC_AD2
PLT_RST#_BUF	4	3	LPC_AD1
+3.3V	2	1	LPC_AD0

2.3.12 Miscellaneous setting connector (SPI1)

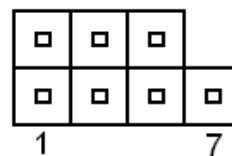
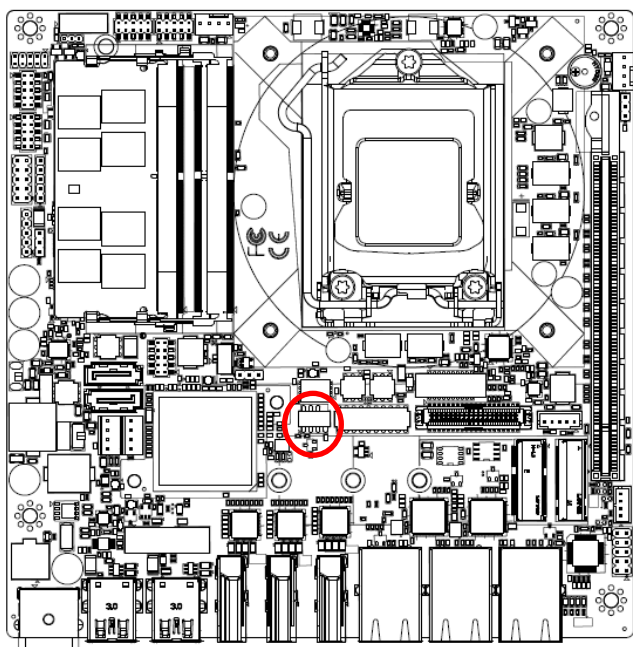

Signal	PIN	PIN	Signal
+ V3.3A_SPI	1	2	GND
SPI_CS0#	3	4	SPI_CLK
SPI_MISO	5	6	SPI_MOSI
SPI_HOLD#	7		

### 2.3.13 Speaker connector (SPK1)

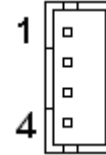
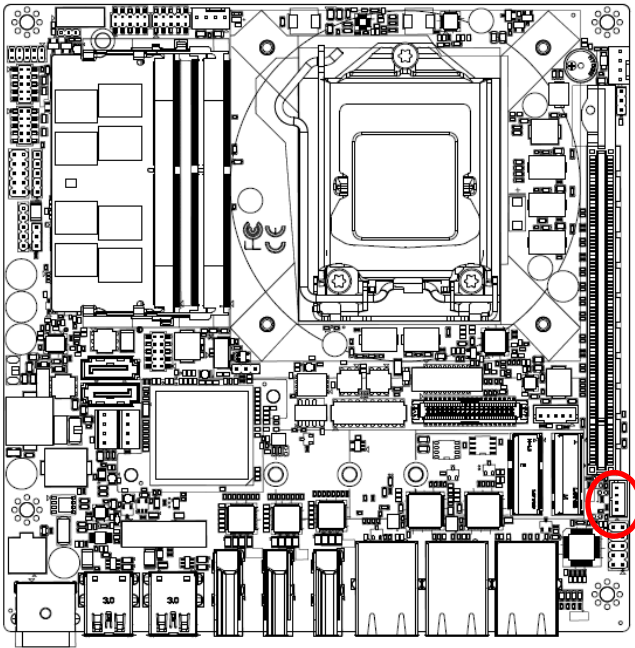

PIN	Signal
1	LSPK+
2	LSPK-
3	RSPK+
4	RSPK-

### 2.3.14 LCD Inverter connector (JBKL1)

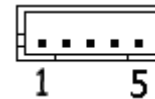
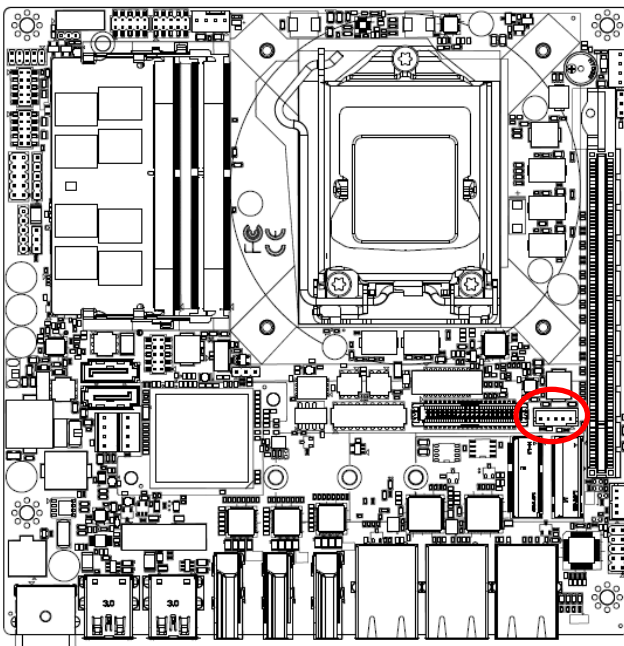

Signal	PIN
+12V	1
GND	2
LVDS_BKLTEN	3
LVDS_BKLADJ	4
+5V	5

2.3.15 Front Panel connector (JFP1)

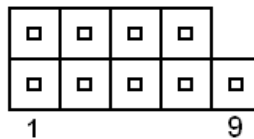
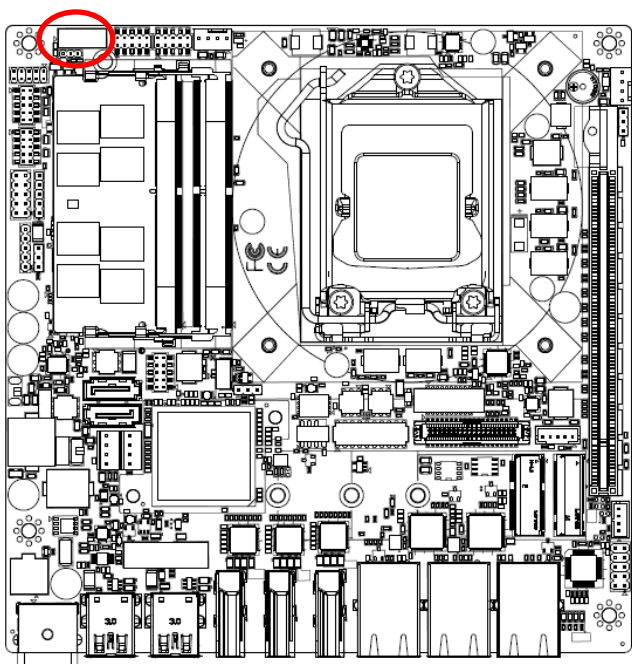

Signal	PIN	PIN	Signal
HDD_LED+	1	2	PWR_LED+
HDD_LED-	3	4	PWR_LED-
SYS_RST#	5	6	PWRBTN#
GND	7	8	GND
NC	9		

2.3.16 CPU fan connector (CPUFAN1)

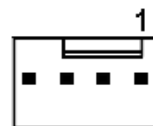
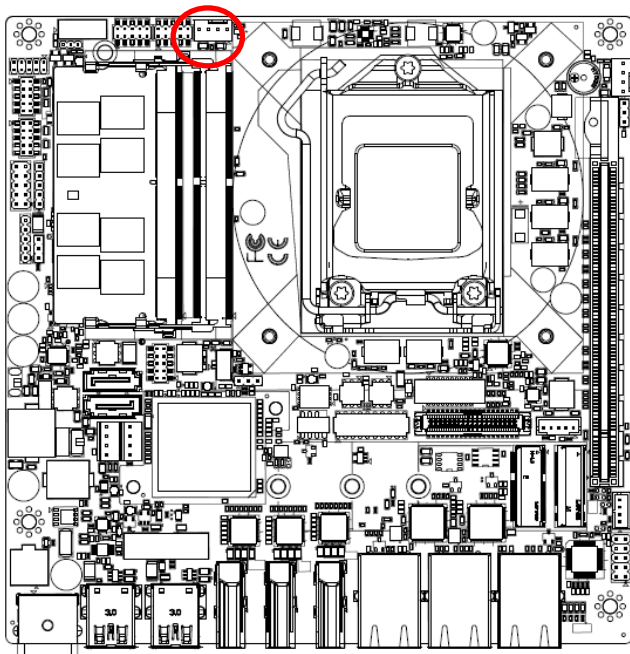

PIN	Signal
1	GND
2	+12V
3	CPU_R_FANIN
4	CPU_FANOUT

### 2.3.17 System fan connector (SYSFAN1)

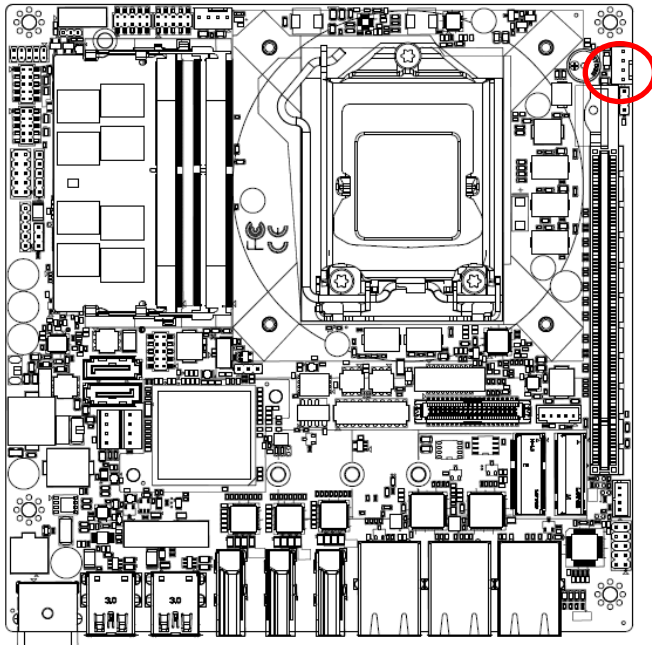

PIN	Signal
4	SYS_FANOUT
3	SYS_R_FANIN
2	+12V
1	GND

### 2.3.18 Auxiliary Panel connector (JAUXP1)

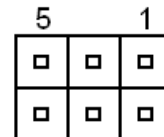
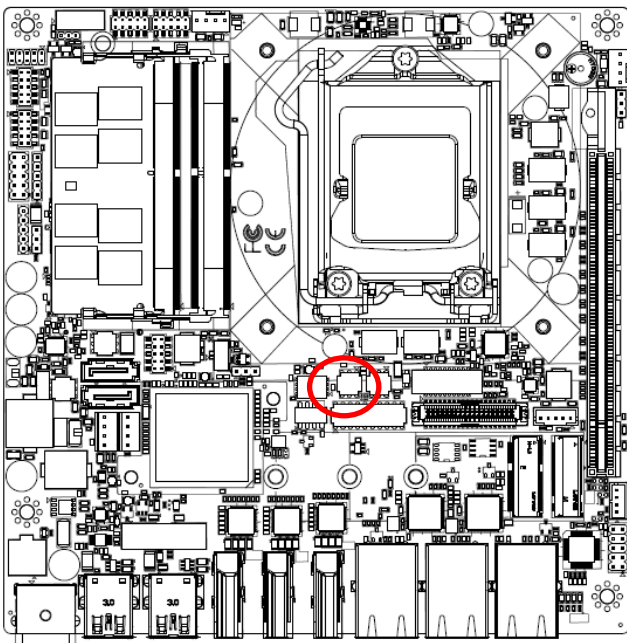

Signal	PIN	PIN	Signal
FRONT_LAN1_ACT	1	2	GND
FRONT_LAN2_ACT	3	4	GND
FRONT_LAN3_ACT	5	6	GND

2.3.19 Serial port connector (COM1)

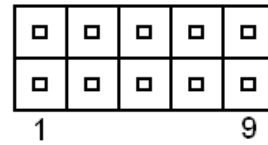
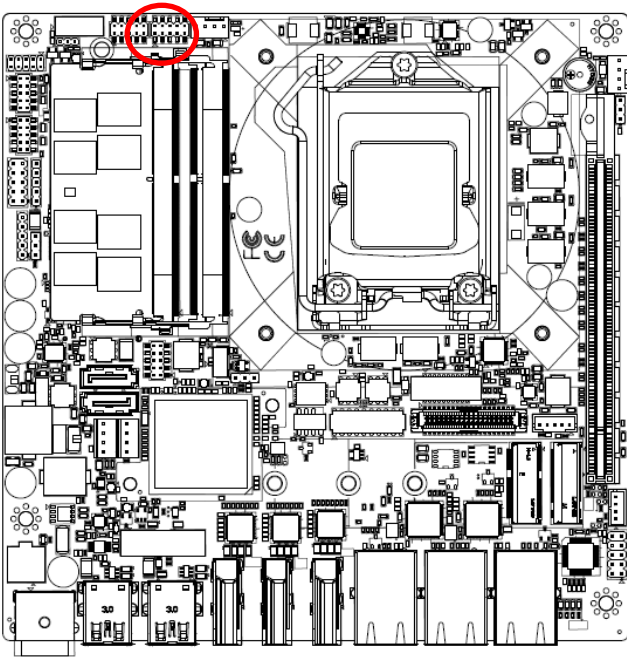

Signal	PIN	PIN	Signal
NDCDA#	1	2	NRXDA
NTXDA	3	4	NDTRA#
GND	5	6	NDSRA#
NRTSA#	7	8	NCTSA#
NRIA#	9	10	NC

2.3.20 Serial port connector (COM2)

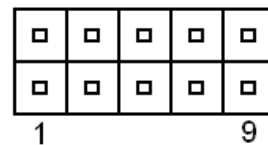
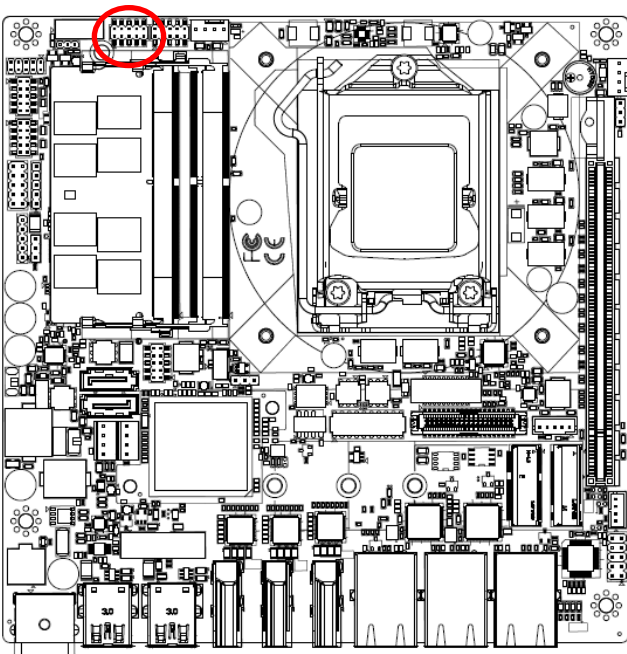

Signal	PIN	PIN	Signal
NDCDB#	1	2	NRXDB
NTXDB	3	4	NDTRB#
GND	5	6	NDSRB#
NRTSB#	7	8	NCTSB#
NRIB#	9	10	NC



### 2.3.21 Serial port connector (COM3)

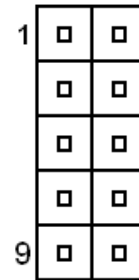
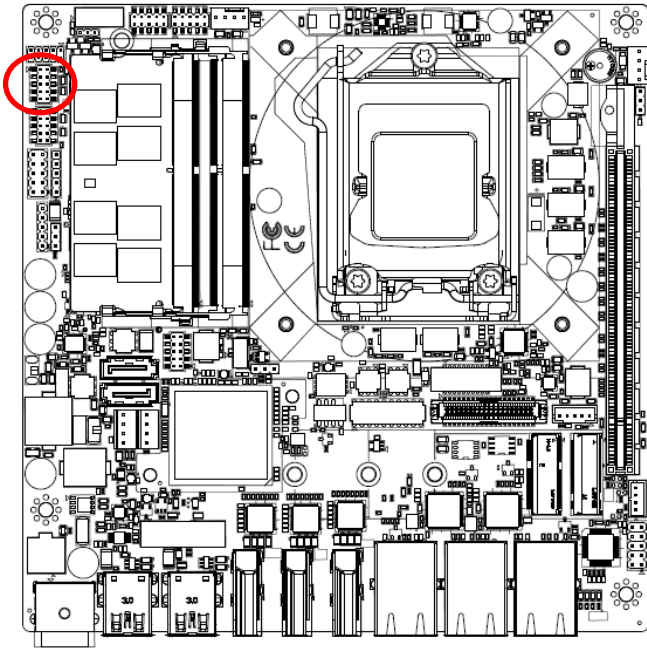

Signal	PIN	PIN	Signal
NDCDC#	1	2	NRXDC
NTXDC	3	4	NDTRC#
GND	5	6	NDSRC#
NRTSC#	7	8	NCTSC#
NRIC#	9	10	NC

### 2.3.22 Serial port connector (COM4)

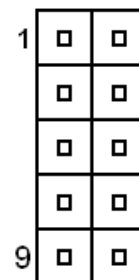
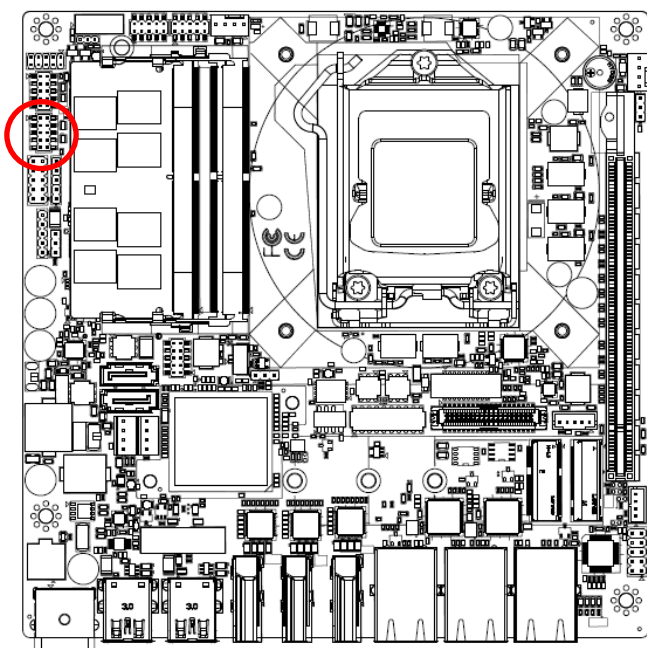

Signal	PIN	PIN	Signal
NDCDD#	1	2	NRXDD
NTXDD	3	4	NDTRD#
GND	5	6	NDSRD#
NRTSD#	7	8	NCTSD#
NRID#	9	10	NC

2.3.23 J1RS1 connector (J1RS1)

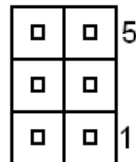
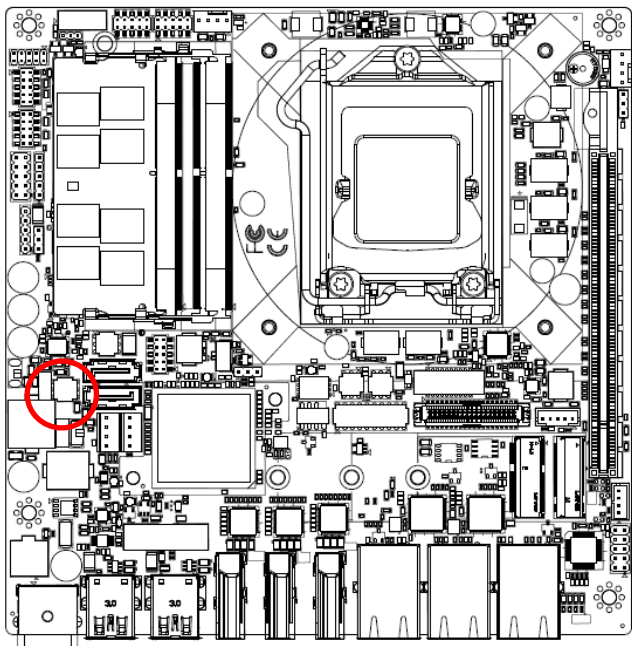

Signal	PIN	PIN	Signal
GND	6	5	+5V
A422RX+	4	3	A485TX+
A422RX-	2	1	A485TX-

2.3.24 Front Audio connector (FAUD1)

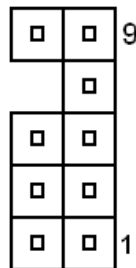
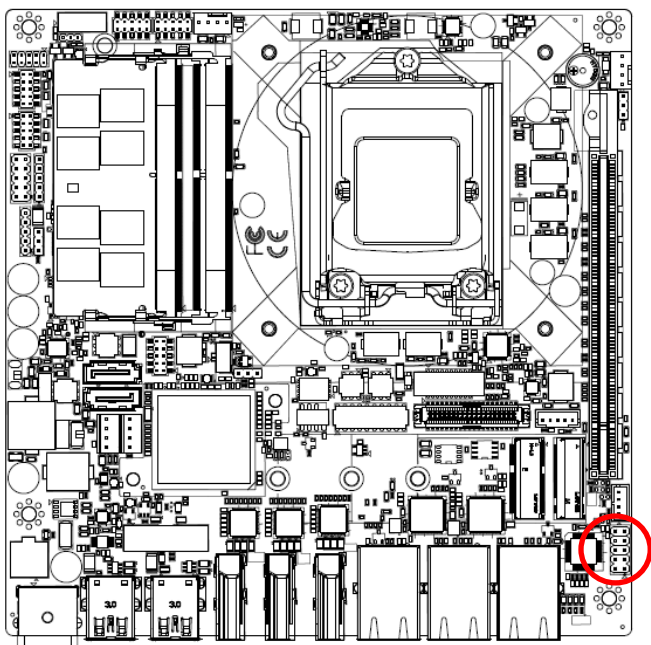

Signal	PIN	PIN	Signal
LINE2_JD	10	9	LINE2_LIN
		7	SENSE_B
MIC2_JD	6	5	LINE2_RIN
ACZ_DET#	4	3	MIC2_RIN
GND	2	1	MIC2_LIN

### 2.3.25 PS/2 keyboard & mouse header (KBMS1)

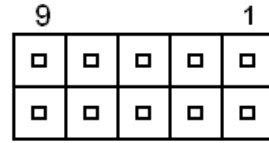
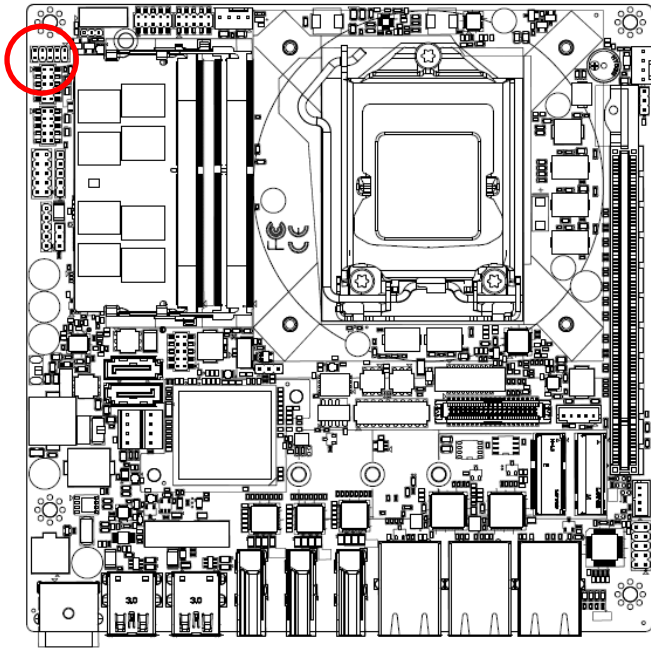

Signal	PIN	PIN	Signal
KBDAT	1	2	KBCK
GND	3	4	+V5A_KB
MSDAT	5	6	MSCK
NC	7	8	NC
NC	9	10	NC

### 2.3.26 SATA Power connector 1/2 (SPWR1/2)

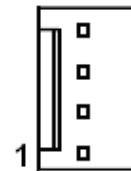
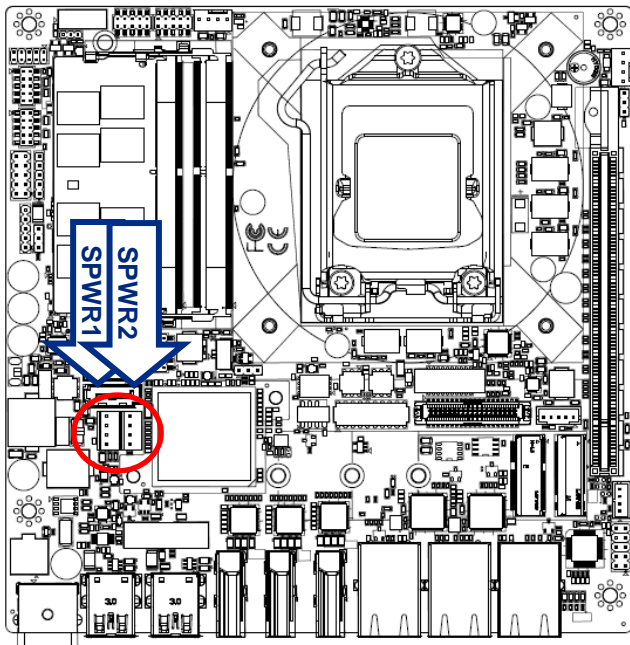

PIN	Signal
1	+V5S_SATA
2	GND
3	GND
4	+V12S_SATA

2.3.27 SMBus connector (JSMB1)

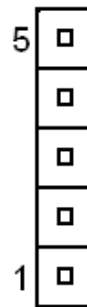
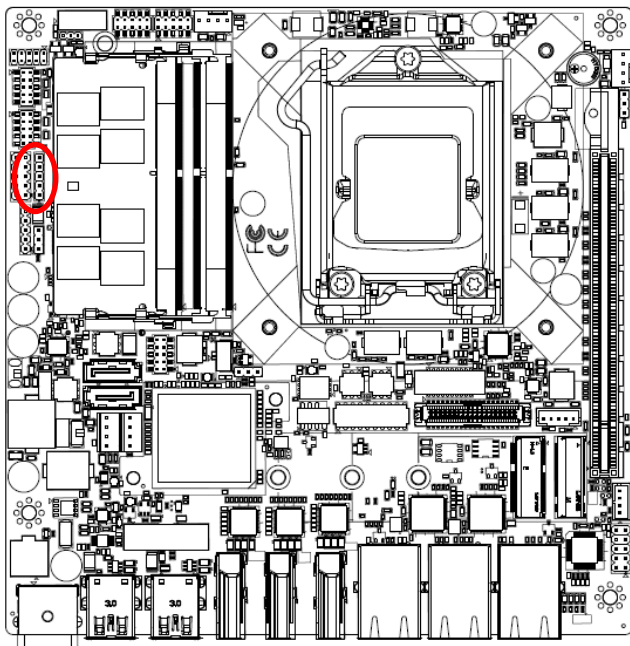

PIN	Signal
5	+3.3V
4	GND
3	SMB_ALERT#
2	SMB_DATA
1	SMB_CLK

2.3.28 eDP-Panel connector (EDP 1)

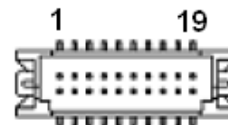
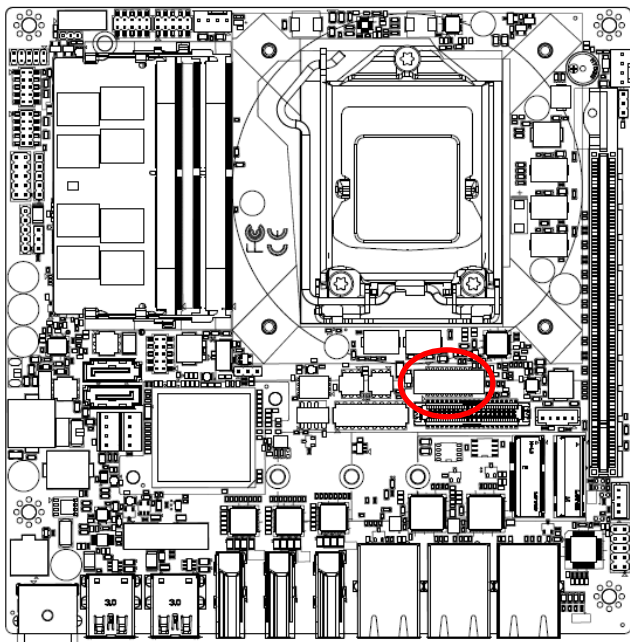

Signal	PIN	PIN	Signal
GND	1	2	GND
EDP_TXN0	3	4	EDP_TXN3
EDP_TXP0	5	6	EDP_TXP3
GND	7	8	NC
EDP_TXN1	9	10	GND
EDP_TXP1	11	12	EDP_AUXN
GND	13	14	EDP_AUXP
EDP_TXN2	15	16	GND
EDP_TXP2	17	18	EDP_C_HPDP
EDP_VCC_PAL	19	20	EDP_VCC_PAL

### 2.3.29 LVDS connector (LVDS1)

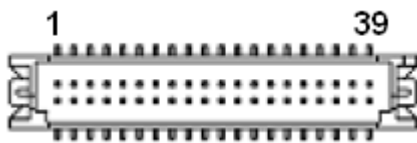
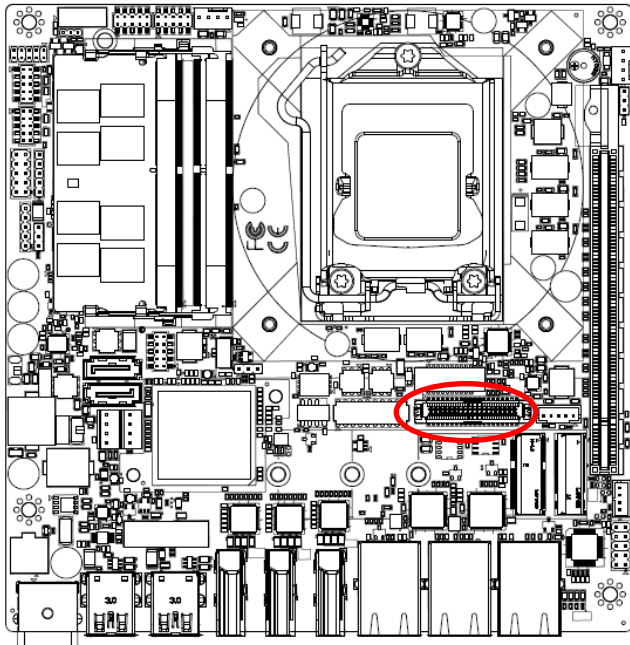

Signal	PIN	PIN	Signal
LVDS_VDD33V	1	2	LVDS_VDD5V
LVDS_VDD33V	3	4	LVDS_VDD5V
NC	5	6	NC
GND	7	8	GND
LVDS_DATAP1	9	10	LVDS_DATAP0
LVDS_DATAN1	11	12	LVDS_DATAN0
GND	13	14	GND
LVDS_DATAP3	15	16	LVDS_DATAP2
LVDS_DATAN3	17	18	LVDS_DATAN2
GND	19	20	GND
LVDS_DATAP5	21	22	LVDS_DATAP4
LVDS_DATAN5	23	24	LVDS_DATAN4
GND	25	26	GND
LVDS_DATAP7	27	28	LVDS_DATAP6
LVDS_DATAN7	29	30	LVDS_DATAN6
GND	31	32	GND
LVDS_CLK2P	33	34	LVDS_CLK1P
LVDS_CLK2N	35	36	LVDS_CLK1N
GND	37	38	GND
LVDS_VDD12V	39	40	LVDS_VDD12V

2.3.30 DC power-in connector (PWR1)

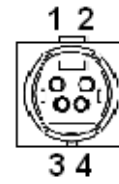
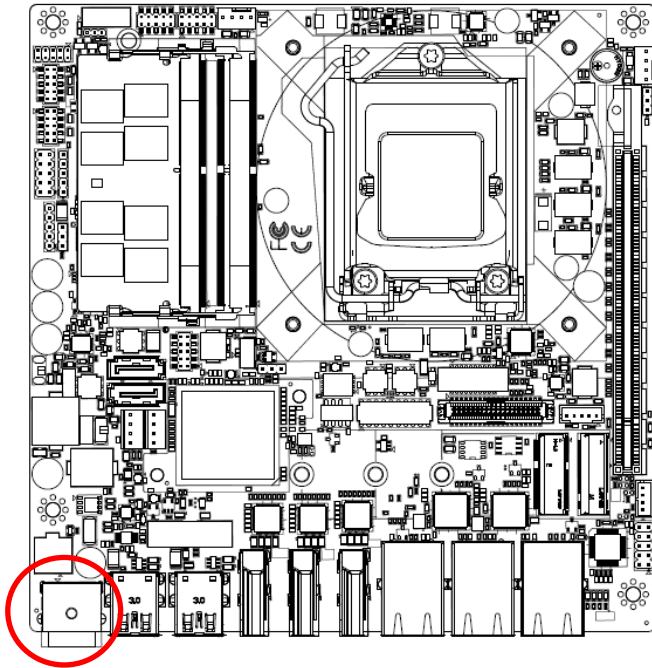

Signal	PIN	PIN	Signal
+VDC12_26V	1	2	+VDC12_26V
GND	3	4	GND

**Note:**  $V_{IN} = 12\sim 26V$

# 3. BIOS Setup

---

### 3.1 Introduction

The BIOS setup program allows users to modify the basic system configuration. In this following chapter will describe how to access the BIOS setup program and the configuration options that may be changed.

### 3.2 Starting Setup

The AMI BIOS™ is immediately activated when you first power on the computer. The BIOS reads the system information contained in the NVRAM and begins the process of checking out the system and configuring it. When it finishes, the BIOS will seek an operating system on one of the disks and then launch and turn control over to the operating system.

While the BIOS is in control, the Setup program can be activated in one of two ways:

By pressing <Del> or <F2> immediately after switching the system on, or

By pressing the <Del> or <F2> key when the following message appears briefly at the left-top of the screen during the POST (Power On Self Test).

**Press <Del> or <F2> to enter SETUP**

If the message disappears before you respond and you still wish to enter Setup, restart the system to try again by turning it OFF then ON or pressing the "RESET" button on the system case. You may also restart by simultaneously pressing <Ctrl>, <Alt>, and <Delete> keys. If you do not press the keys at the correct time and the system does not boot, an error message will be displayed and you will again be asked to.

**Press F1 to Continue, DEL to enter SETUP**



### 3.3 Using Setup

In general, you use the arrow keys to highlight items, press <Enter> to select, use the PageUp and PageDown keys to change entries, press <F1> for help and press <Esc> to quit. The following table provides more detail about how to navigate in the Setup program using the keyboard.

Button	Description
↑	Move to previous item
↓	Move to next item
←	Move to the item in the left hand
→	Move to the item in the right hand
Esc key	Main Menu -- Quit and not save changes into NVRAM Status Page Setup Menu and Option Page Setup Menu -- Exit current page and return to Main Menu
+ key	Increase the numeric value or make changes
- key	Decrease the numeric value or make changes
F1 key	General help, only for Status Page Setup Menu and Option Page Setup Menu
F2 key	Previous Values.
F3 key	Optimized defaults
F4 key	Save & Exit Setup

- **Navigating Through The Menu Bar**

Use the left and right arrow keys to choose the menu you want to be in.



**Note:** Some of the navigation keys differ from one screen to another.

- **To Display a Sub Menu**

Use the arrow keys to move the cursor to the sub menu you want. Then press <Enter>. A “>” pointer marks all sub menus.

### 3.4 Getting Help

Press F1 to pop up a small help window that describes the appropriate keys to use and the possible selections for the highlighted item. To exit the Help Window press <Esc> or the F1 key again.

### 3.5 In Case of Problems

If, after making and saving system changes with Setup, you discover that your computer no longer is able to boot, the AMI BIOS supports an override to the NVRAM settings which resets your system to its defaults.

The best advice is to only alter settings which you thoroughly understand. To this end, we strongly recommend that you avoid making any changes to the chipset defaults. These defaults have been carefully chosen by both BIOS Vendor and your systems manufacturer to provide the absolute maximum performance and reliability. Even a seemingly small change to the chipset setup has the potential for causing you to use the override.

### 3.6 BIOS setup

Once you enter the Aptio Setup Utility, the Main Menu will appear on the screen. The Main Menu allows you to select from several setup functions and exit choices. Use the arrow keys to select among the items and press <Enter> to accept and enter the sub-menu.

#### 3.6.1 Main Menu

This section allows you to record some basic hardware configurations in your computer and set the system clock.

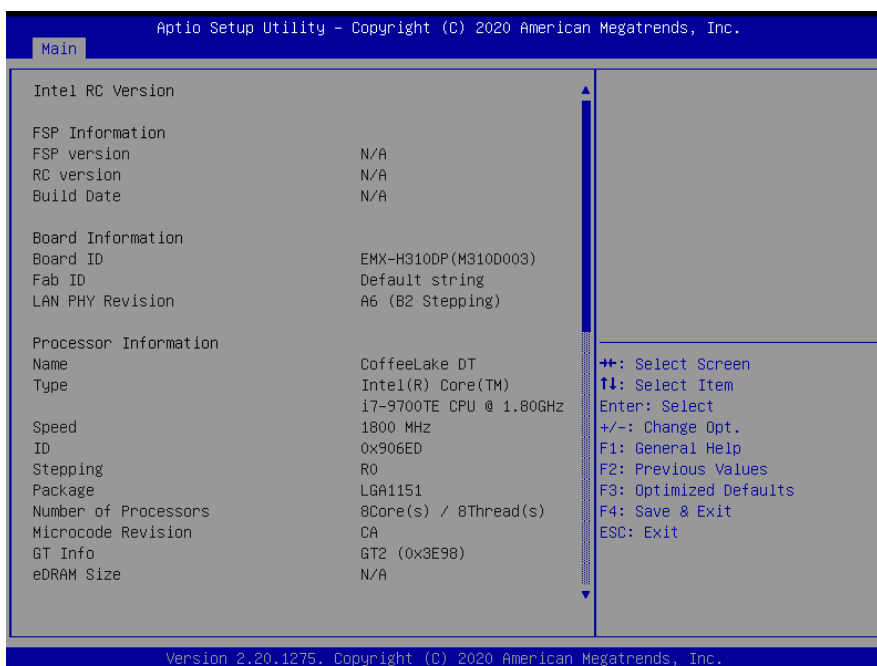
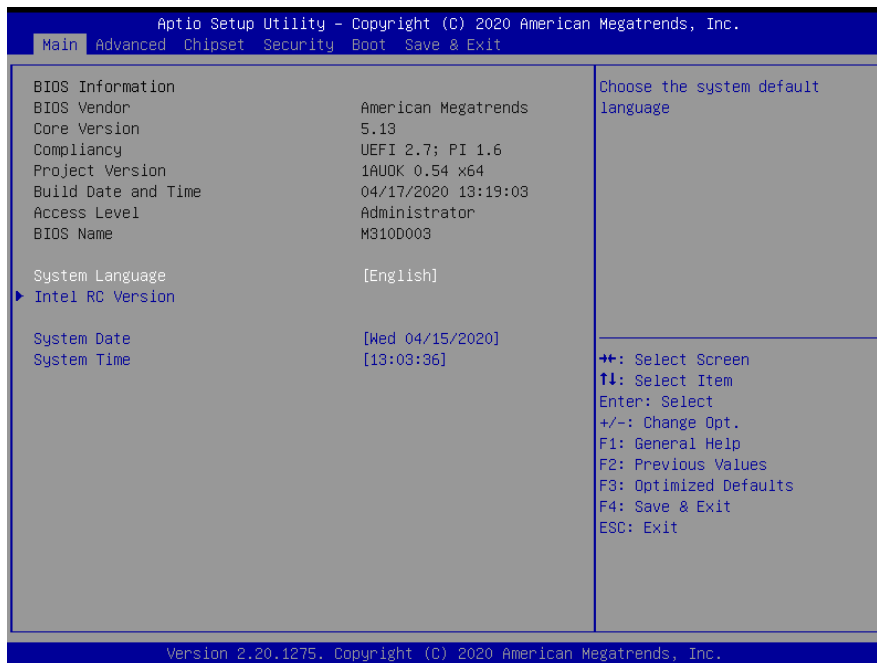

## EMX-H310DP User's Manual

### 3.6.1.1 System Language

This option allows choosing the system default language.

### 3.6.1.2 System Date

Use the system date option to set the system date. Manually enter the day, month and year.

### 3.6.1.3 System Time

Use the system time option to set the system time. Manually enter the hours, minutes and seconds.



**Note:** The BIOS setup screens shown in this chapter are for reference purposes only, and may not exactly match what you see on your screen. Visit the Avalue website ([www.avalue.com.tw](http://www.avalue.com.tw)) to download the latest product and BIOS information.

## 3.6.2 Advanced Menu

This section allows you to configure your CPU and other system devices for basic operation through the following sub-menus.

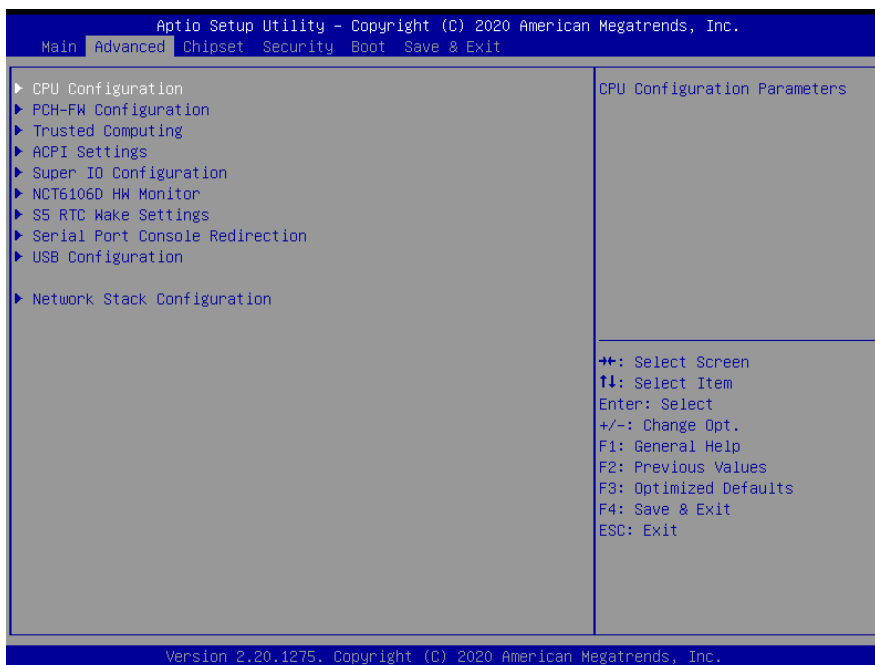

### 3.6.2.1 CPU Configuration



Item	Options	Description
<b>Intel (VMX) Virtualization Technology</b>	Disabled Enabled[ <b>Default</b> ],	When enabled, a VMM can utilize the additional hardware capabilities provided by Vanderpool Technology.
<b>Active Processor Cores</b>	All[ <b>Default</b> ], 1 2 3 4 5 6 7 8	Number of cores to enable in each processor package.

# EMX-H310DP User's Manual

## 3.6.2.1.1 CPU - Power Management Control

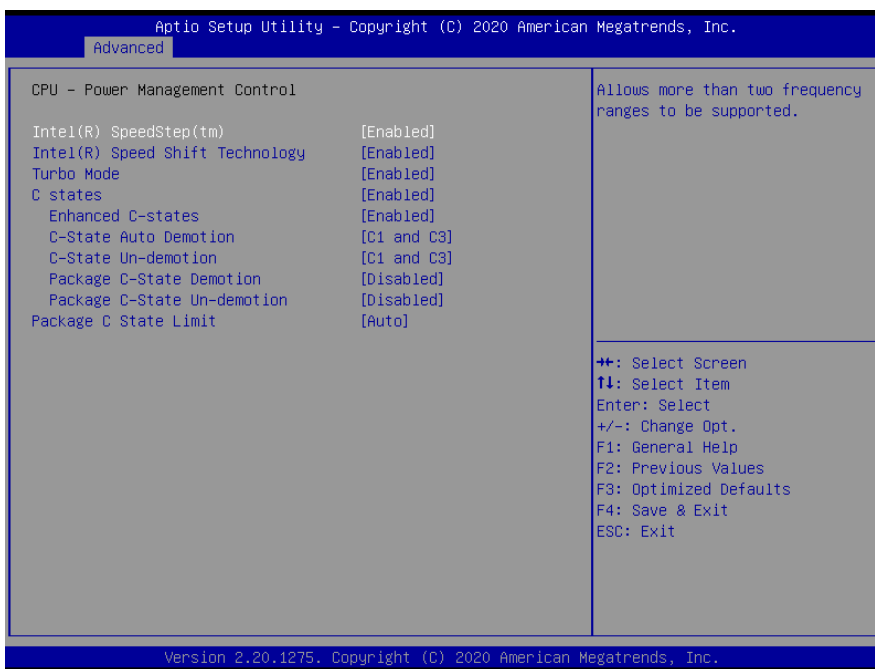

Item	Options	Description
<b>Intel(R) SpeedStep(tm)</b>	Disabled Enabled[ <b>Default</b> ],	Allows more than two frequency ranges to be supported.
<b>Intel(R) Speed Shift Technology</b>	Disabled Enabled[ <b>Default</b> ],	Enable/Disable Intel(R) Speed Shift Technology support. Enabling will expose the CPPC v2 interface to allow for hardware controlled P-states.
<b>Turbo Mode</b>	Disabled Enabled[ <b>Default</b> ],	Enable/Disable processor Turbo Mode (requires Intel Speed Step or Intel Speed Shift to be available and enabled).
<b>C states</b>	Disabled Enabled[ <b>Default</b> ],	Enable/Disable CPU Power Management. Allows CPU to go to C states when it's not 100% utilized
<b>Enhanced C-states</b>	Disabled Enabled[ <b>Default</b> ],	Enable/Disable C1E. When enabled, CPU will switch to minimum speed when all cores enter C-states.
<b>C-State Auto Demotion</b>	Disabled C1 C3 C1 and C3[ <b>Default</b> ],	Configure C-State Auto Demotion
<b>C-State Un-demotion</b>	Disabled C1 C3 C1 and C3[ <b>Default</b> ],	Configure C-State Un-demotion
<b>Package C-State Demotion</b>	Disabled[ <b>Default</b> ], Enabled	Package C-State Demotion
<b>Package C-State Un-demotion</b>	Disabled[ <b>Default</b> ], Enabled	Package C-State Un-demotion
<b>Package C State Limit</b>	C0/C1	Maximum Package C State Limit Setting. Cpu

	C2 C3 C6 C7 C7S C8 C9 C10 Cpu Default Auto[Default],	Default: Leaves to Factory default value.Auto: Initializes to deepest available Package C State Limit.
--	---	--

### 3.6.2.2 PCH-FW Configuration

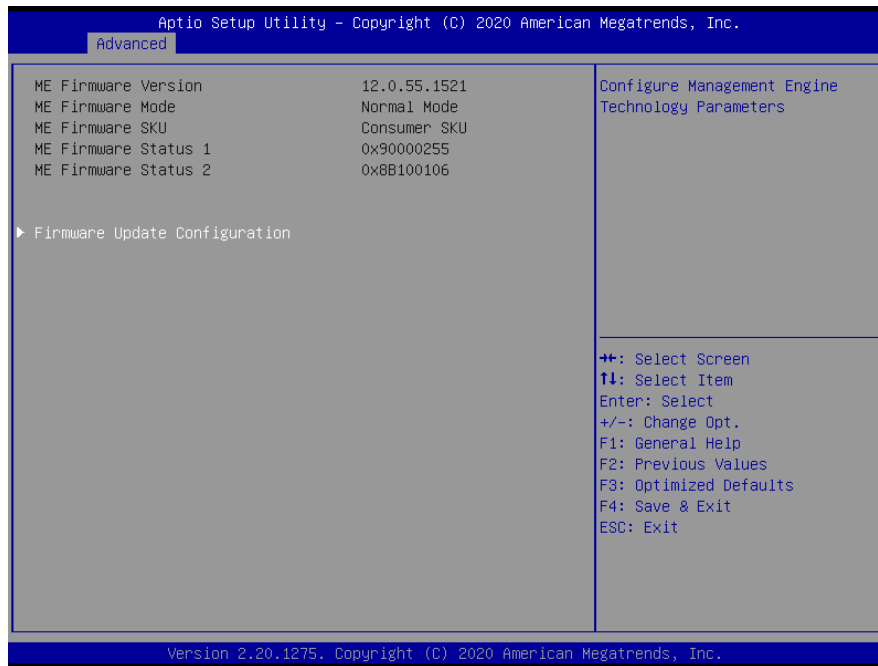

#### 3.6.2.2.1 Firmware Update Configuration

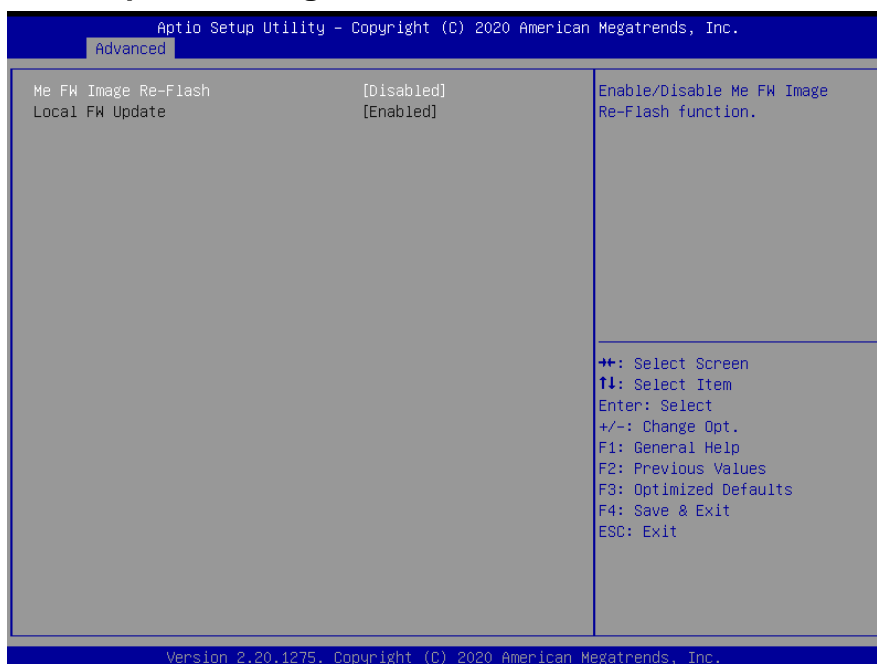

## EMX-H310DP User's Manual

Item	Option	Description
Me FW Image Re-Flash	Disabled[Default], Enabled	Enable/Disable Me FW Image Re-Flash function.

### 3.6.2.3 Trusted Computing



Item	Options	Description
Security Device Support	Disable, Enable[Default]	Enables or Disables BIOS support for security device. O.S. will not show Security Device. TCG EFI protocol and INT1A interface will not be available.

### 3.6.2.4 ACPI Settings

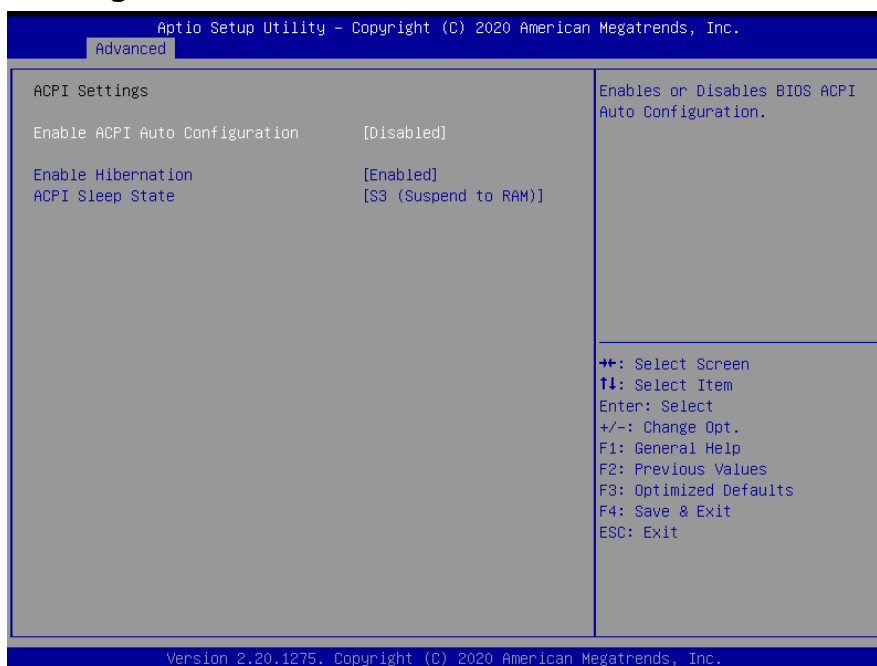



Item	Options	Description
<b>Enable ACPI Auto Configuration</b>	Disabled[Default], Enabled	Enables or Disables BIOS ACPI Auto Configuration.
<b>Enable Hibernation</b>	Disabled Enabled[Default],	Enables or Disables System ability to Hibernate (OS/S4 Sleep State). This option may not be effective with some operating systems.
<b>ACPI Sleep State</b>	Suspend Disabled, S3 (Suspend to RAM)[Default]	Select the highest ACPI sleep state the system will enter when the SUSPEDN button is pressed.

### 3.6.2.5 Super IO Configuration

You can use this item to set up or change the Super IO configuration for serial ports. Please refer to 3.6.2.5.1~ 3.6.2.5.4 for more information.

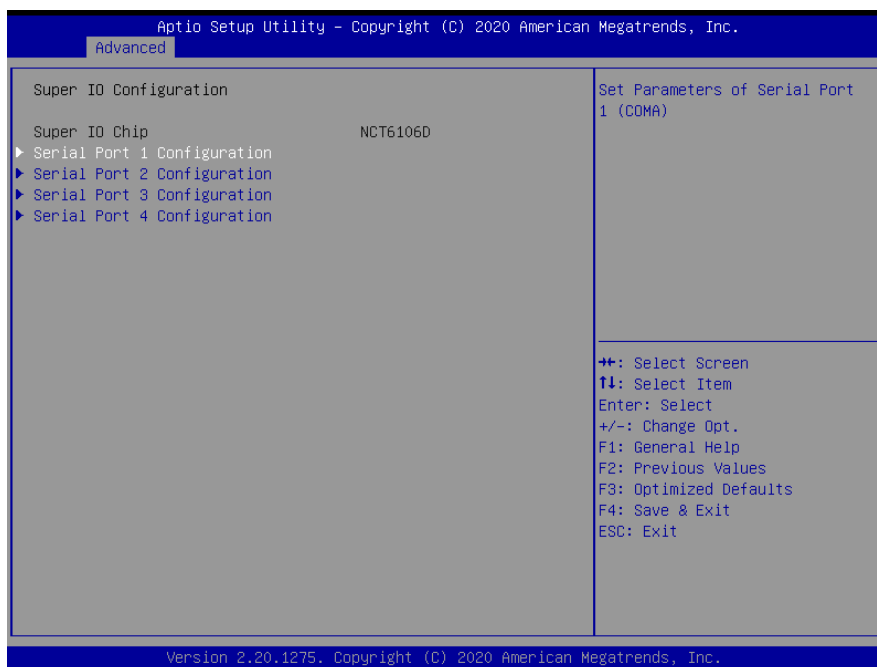

Item	Description
<b>Serial Port 1 Configuration</b>	Set Parameters of Serial Port 1 (COMA).
<b>Serial Port 2 Configuration</b>	Set Parameters of Serial Port 2 (COMB).
<b>Serial Port 3 Configuration</b>	Set Parameters of Serial Port 3 (COMC).
<b>Serial Port 4 Configuration</b>	Set Parameters of Serial Port 4 (COMD).

3.6.2.5.1 Serial Port 1 Configuration



Item	Option	Description
Serial Port	Disabled Enabled[Default],	Enable or Disable Serial Port (COM).
UART 232 422 485	RS232[Default], RS422 RS485	Set COM Port as RS232, RS422 or RS485 mode.

3.6.2.5.2 Serial Port 2 Configuration

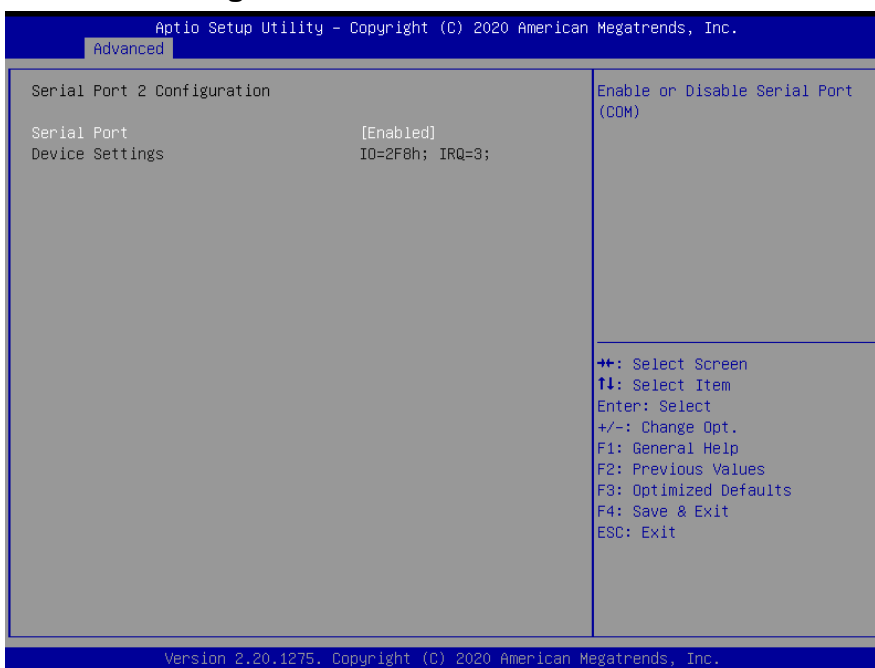

Item	Option	Description
Serial Port	Disabled Enabled[Default],	Enable or Disable Serial Port (COM).

### 3.6.2.5.3 Serial Port 3 Configuration

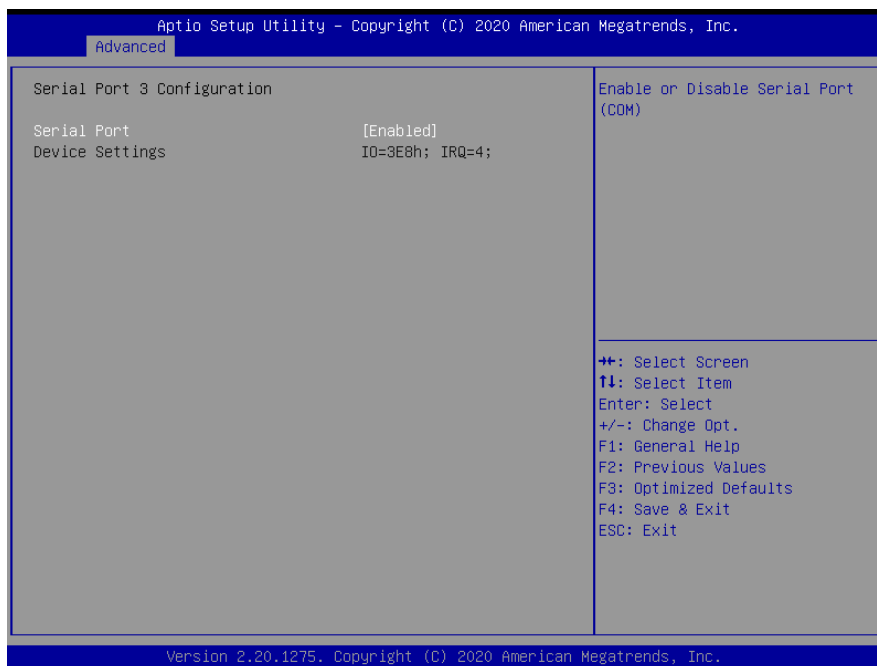

Item	Option	Description
Serial Port	Disabled Enabled[Default],	Enable or Disable Serial Port (COM).

### 3.6.2.5.4 Serial Port 4 Configuration

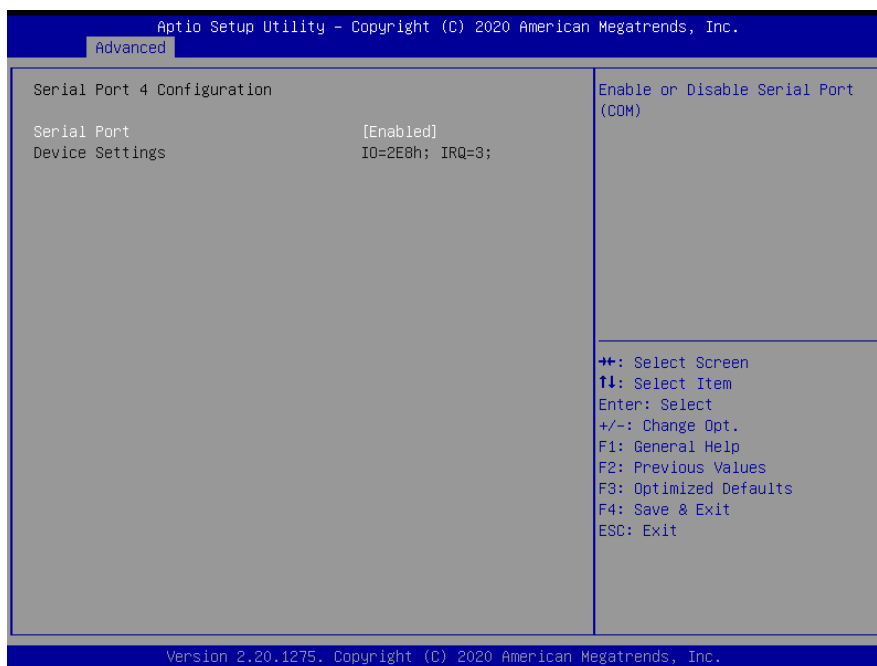

## EMX-H310DP User's Manual

Item	Option	Description
Serial Port	Disabled Enabled[Default],	Enable or Disable Serial Port (COM).

### 3.6.2.6 NCT6106D H/W Monitor

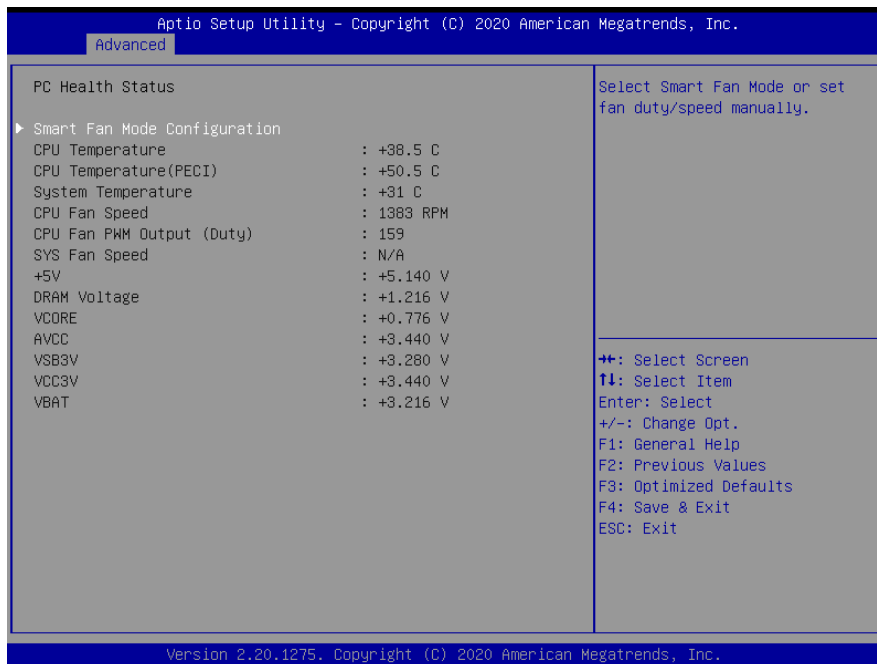

#### 3.6.2.6.1 Smart Fan Configuration

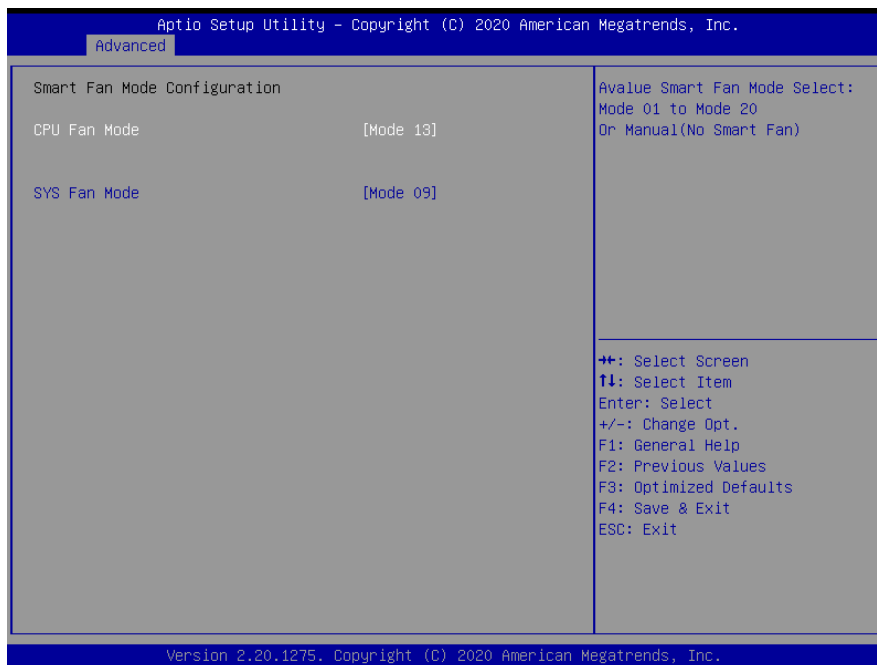

Item	Option	Description
CPU Fan Mode	Manual Mode	Avalue Smart Fan Mode Select: Mode 01 to Mode 20 Or Manual (No Smart Fan)
	Mode 01	
	Mode 02	
	Mode 03	
	Mode 04	

	<p>Mode 05  Mode 06  Mode 07  Mode 08  Mode 09  Mode 10  Mode 11  Mode 12  <b>Mode 13[Default],</b>  Mode 14  Mode 15  Mode 16  Mode 17  Mode 18  Mode 19  Mode 20</p>	
<p><b>SYS Fan Mode</b></p>	<p>Manual Mode  Mode 01  Mode 02  Mode 03  Mode 04  Mode 05  Mode 06  Mode 07  Mode 08  <b>Mode 09[Default],</b>  Mode 10  Mode 11  Mode 12  Mode 13  Mode 14  Mode 15  Mode 16  Mode 17  Mode 18  Mode 19  Mode 20</p>	<p>Avalue Smart Fan Mode Select: Mode 01 to Mode 20 Or Manual (No Smart Fan)</p>

3.6.2.7 S5 RTC Wake Settings



Item	Options	Description
Wake system from S5	Disabled[Default], Fixed Time Dynamic Time	Enable or disable System wake on alarm event. Select FixedTime, system will wake on the hr::min::sec specified. Select Dynamic Time, System will wake on the current time + Increase minute(s).

3.6.2.8 Serial Port Console Redirection

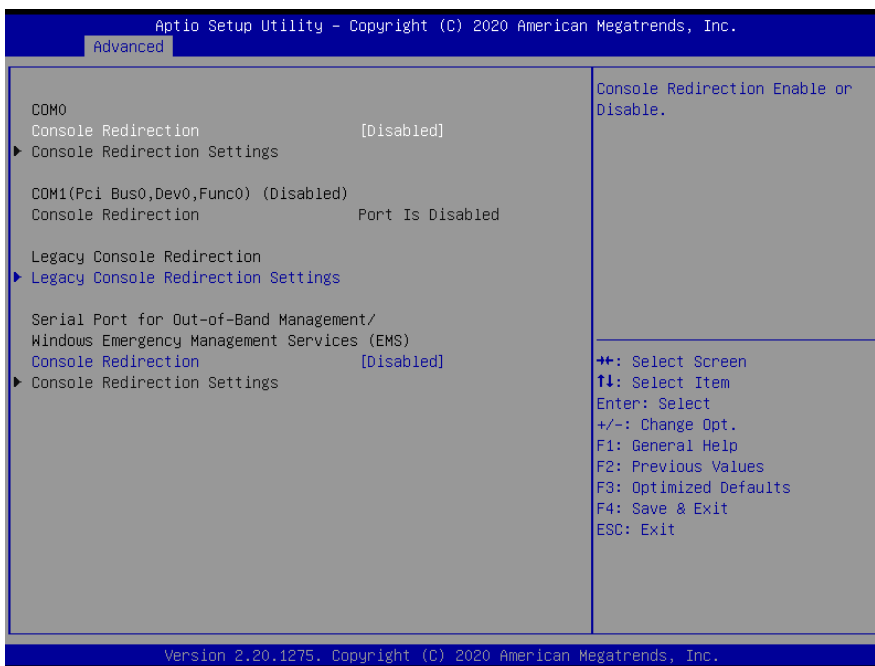

Item	Options	Description
Console Redirection	Disabled[Default], Enabled	Console Redirection Enable or Disable.

### 3.6.2.8.1 Legacy Console Redirection Settings

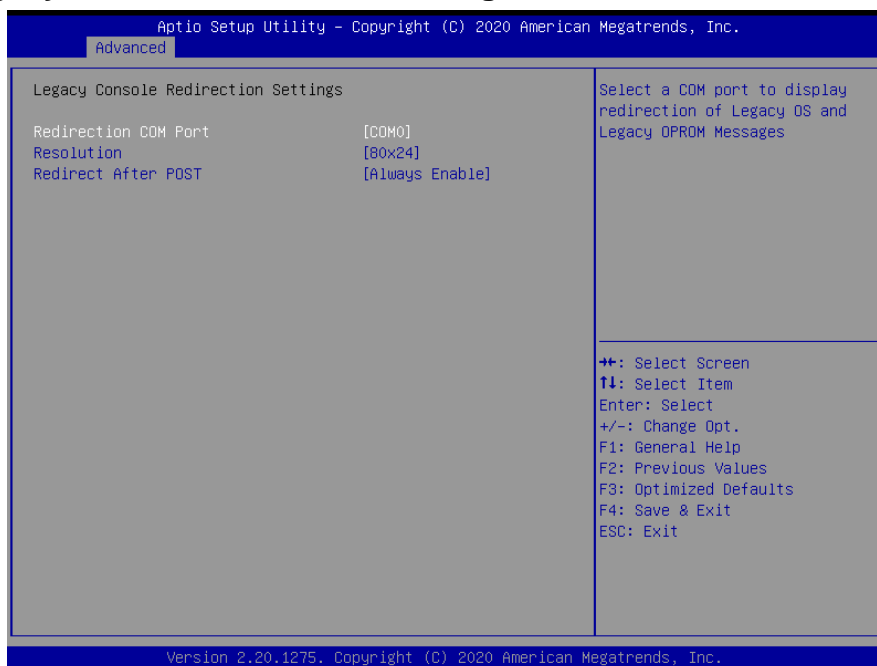

Item	Option	Description
<b>Redirection COM Port</b>	COM0[Default]	Select a COM port to display redirection of Legacy OS and Legacy OPROM Messages.
<b>Resolution</b>	80X24[Default] 80X25	On Legacy OS, the Number of Rows and Columns supported redirection
<b>Redirect After POST</b>	Always Enable[Default] BootLoader	When Bootloader is selected, then Legacy Console Redirection is disabled before booting to legacy OS. When Always Enable is selected, then Legacy Console Redirection is enabled for legacy OS. Default setting for this option is set to Always Enable.

3.6.2.9 USB Configuration

The USB Configuration menu helps read USB information and configures USB settings.

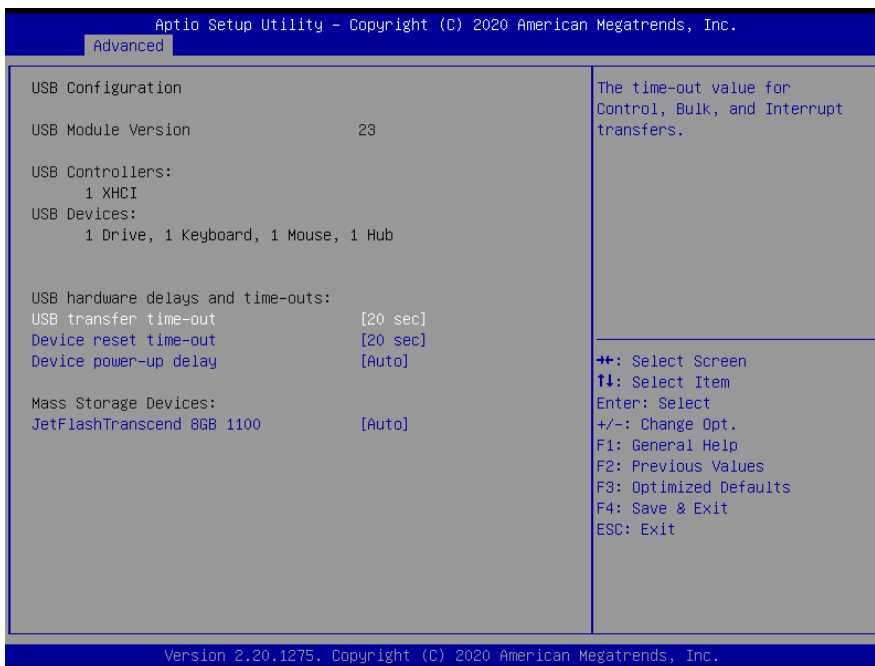

Item	Options	Description
<b>USB transfer time-out</b>	1 sec 5 sec 10 sec 20 sec <b>[Default]</b>	The time-out value for Control, Bulk, and Interrupt transfers.
<b>Device reset time-out</b>	10 sec 20 sec <b>[Default]</b> 30 sec 40 sec	USB mass storage device Start Unit command time-out.
<b>Device power-up delay</b>	Auto <b>[Default]</b> Manual	Maximum time the device will take before it properly reports itself to the Host Controller. 'Auto' uses default value: for a Root port it is 100ms, for a Hub port the delay is taken form Hub descriptor.
<b>JetF lashTranscend 8GB 1100</b>	Auto <b>[Default]</b> Floppy Forced FDD Hard Disk CD-ROM	Mass storage device emulation type. 'AUTO' enumerates devices according to their media format. Optical drives are emulated as 'CDROM' drives with no media will be emulated according to a drive type.



### 3.6.2.10 Network Stack Configuration



Item	Options	Description
Network Stack	Disabled[Default], Enabled	Enable/Disable UEFI Network Stack.



**Note:** Motherboard designed with quad Gigabit LAN consumes longer startup time when Network Stack setting at “Enable”, this is a normal phenomenon.

### 3.6.3 Chipset

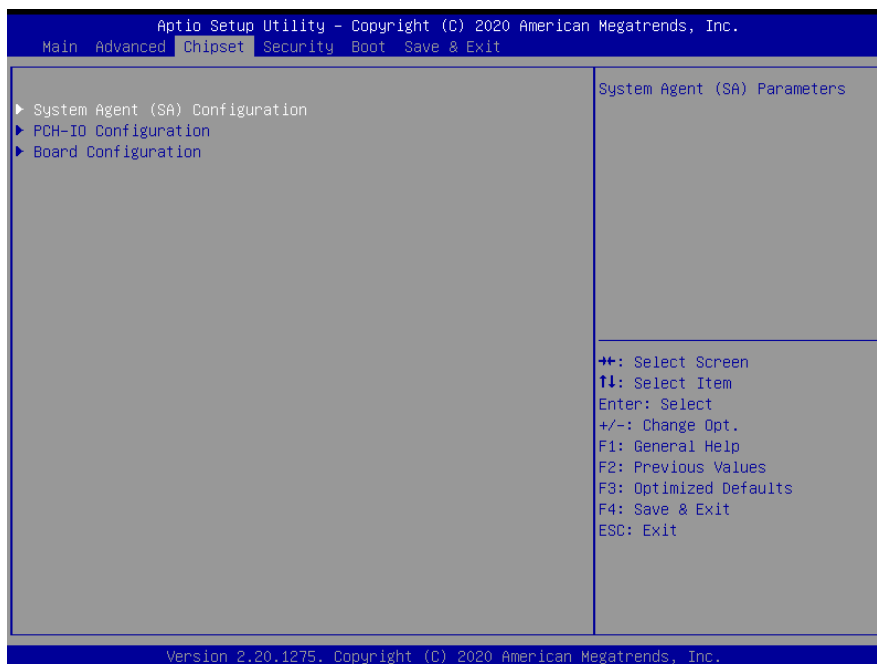

### 3.6.3.1 System Agent (SA) Configuration

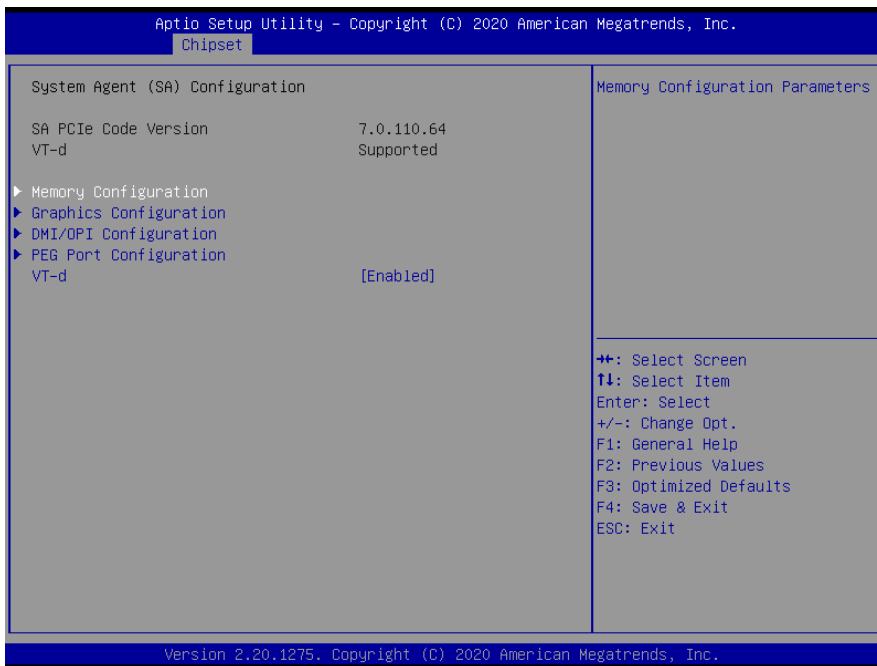

Item	Option	Description
VT-d	Disabled Enabled[Default]	VT-d capability.

#### 3.6.3.1.1 Memory Configuration

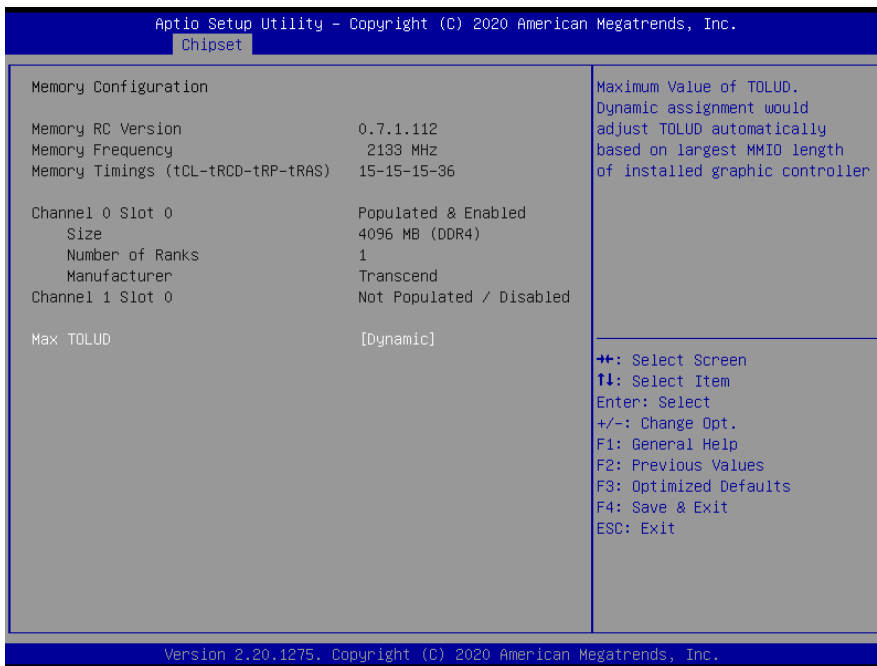

Item	Option	Description
Max TOLUD	Dynamic[Default] 1GB 1.25 GB	Maximum Value of TOLUD. Dynamic assignment would adjust TOLUD automatically based on largest MMIO length

	1.5 GB 1.75 GB 2 GB 2.25 GB 2.5 GB 2.75 GB 3 GB	of installed graphic controller
--	---	---------------------------------

### 3.6.3.1.2 Graphics Configuration

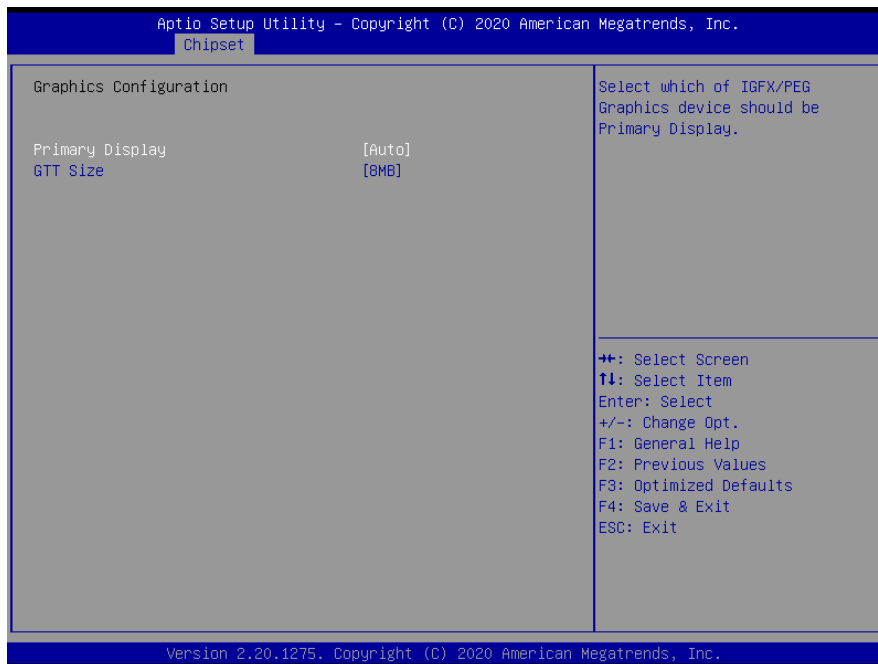

Item	Option	Description
<b>Primary Display</b>	Auto[Default] IGFX PEG	Select which of IGFX/PEG Graphics device should be Primary Display
<b>GTT Size</b>	2MB 4MB 8MB[Default]	Select the GTT Size

3.6.3.1.3 DMI/OPI Configuration

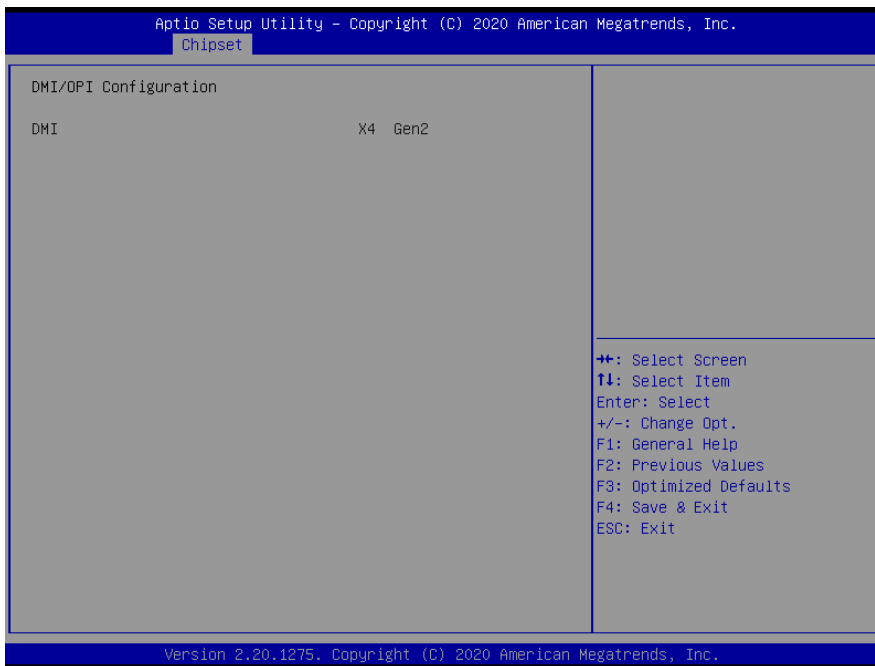

3.6.3.1.4 PEG Port Configuration

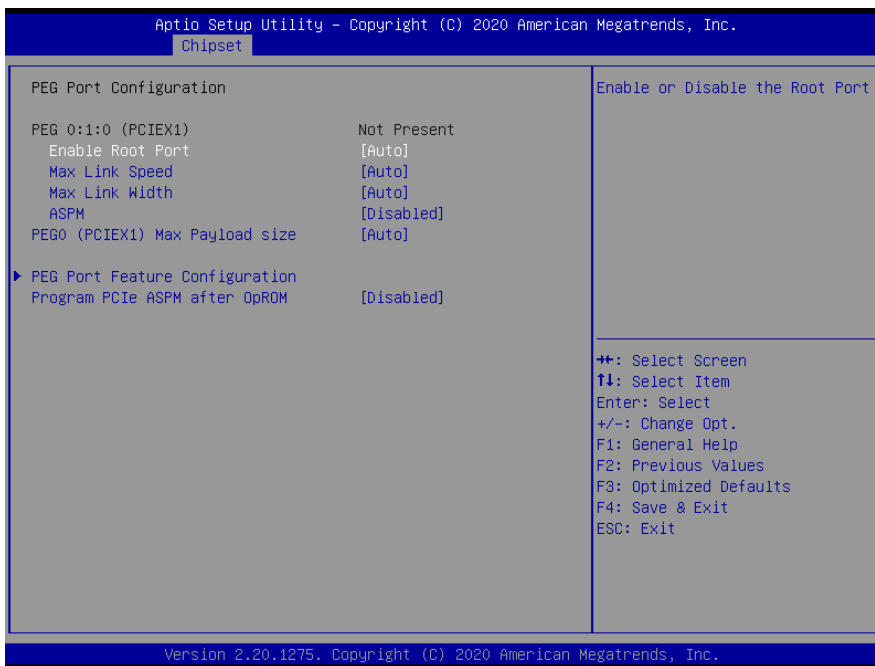

Item	Option	Description
Enable Root Port	Disabled Enabled Auto[Default]	Enable or Disable the Root Port.
Max Link Speed	Auto[Default] Gen1 Gen2 Gen3	Configure PEG 0:1:0 Max Speed

<b>Max Link Width</b>	Auto[Default] Force X1 Force X2 Force X4 Force X8	Force PEG link to retrain to X1/2/4/8
<b>ASPM</b>	Disabled[Default] Auto ASPM L0s ASPM L1 ASPM L0sL1	Control ASPM support for the PEG 0. This has no effect if PEG is not the currently active device.
<b>PEG0 (PCIEX1) Max Payload size</b>	Auto[Default] 128 256 TLP	Select PEG0 Max Payload size; Choose Auto(Default Device Capability) or force to 128/256 Bytes
<b>Program PCIe ASPM after OpROM</b>	Disabled[Default] Enabled	Enabled: PCIe ASPM will be programmed after OpROM. Disabled: PCIe ASPM will be programmed before OpROM.

### 3.6.3.1.4.1 PEG Port Feature Configuration

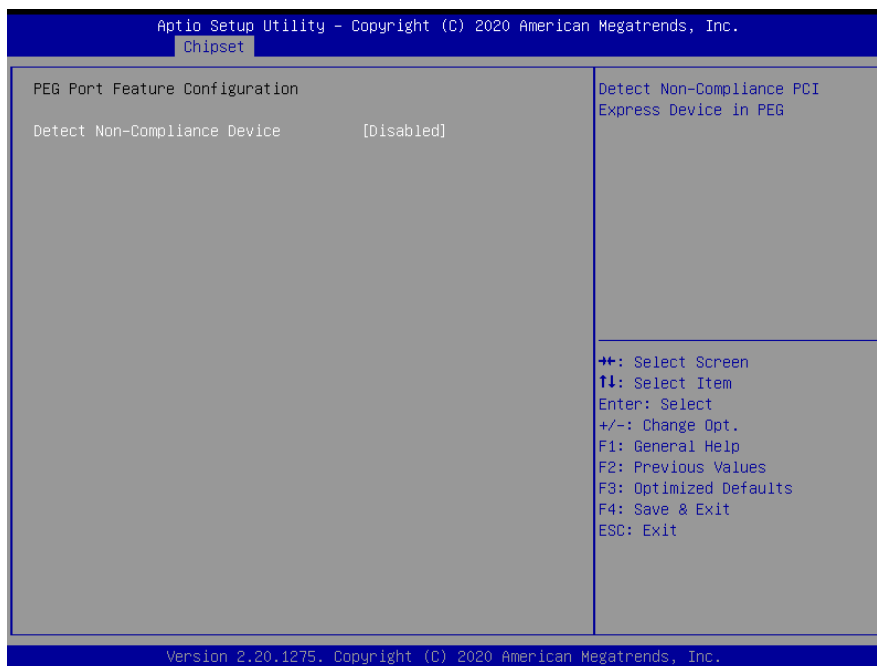

Item	Option	Description
<b>Detect Non-Compliance Device</b>	Disabled[Default] Enabled	Detect Non-Compliance PCI Express Device in PEG

### 3.6.3.2 PCH-IO Configuration

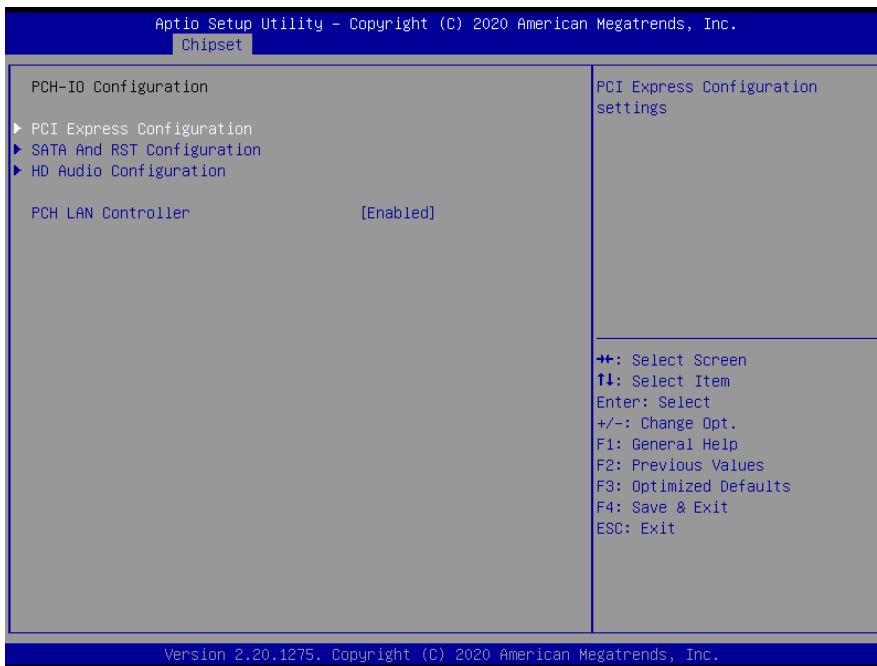

Item	Option	Description
PCH LAN Controller	Enabled[Default] Disabled	Enable/Disable onboard NIC.

#### 3.6.3.2.1 PCI Express Configuration

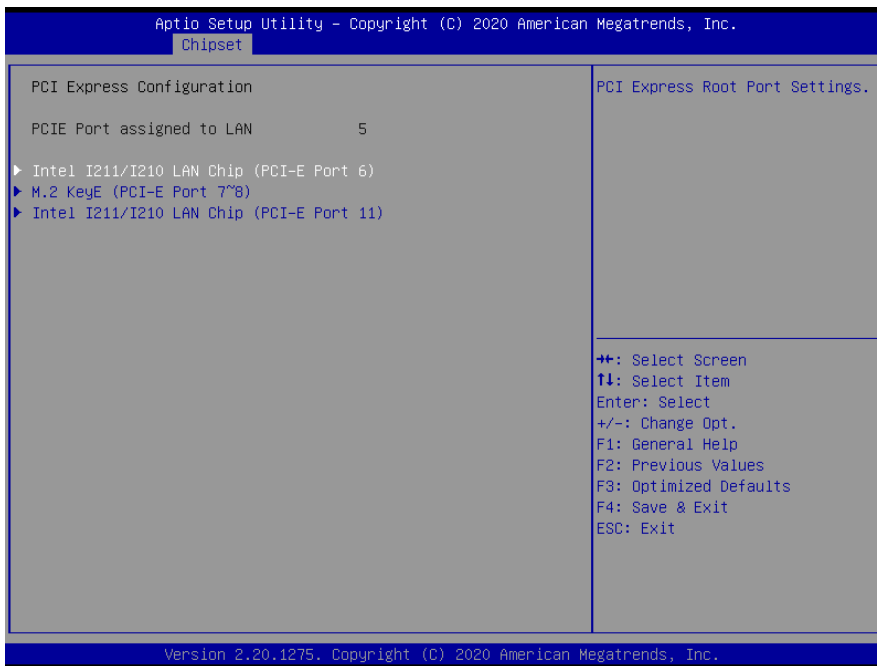

### 3.6.3.2.1.1 Intel I211/I210 LAN Chip (PCI-E Port 6)



Item	Option	Description
<b>Intel I211/I210 LAN Chip (PCI-E Port 6)</b>	Disabled Enabled[ <b>Default</b> ],	Control the PCI Express Root Port.
<b>ASPM 5</b>	Disabled[ <b>Default</b> ] L0s L1 L0sL1 Auto	Set the ASPM Level: Force L0s – Force all links to L0s State AUTO – BIOS auto configure DISABLE – Disables ASPM.
<b>L1 Substates</b>	Disabled L1.1 L1.1 & L1.2[ <b>Default</b> ]	PCI Express L1 Substates settings.
<b>PCIe Speed</b>	Auto[ <b>Default</b> ] Gen1 Gen2 Gen3	Configure PCIe Speed
<b>Detect Timeout</b>	0	The number of milliseconds reference code will wait for link to exit Detect state for enabled ports before assuming there is no device and potentially disabling the port.

3.6.3.2.1.2 M.2 KeyE (PCI-E Port 7~8)

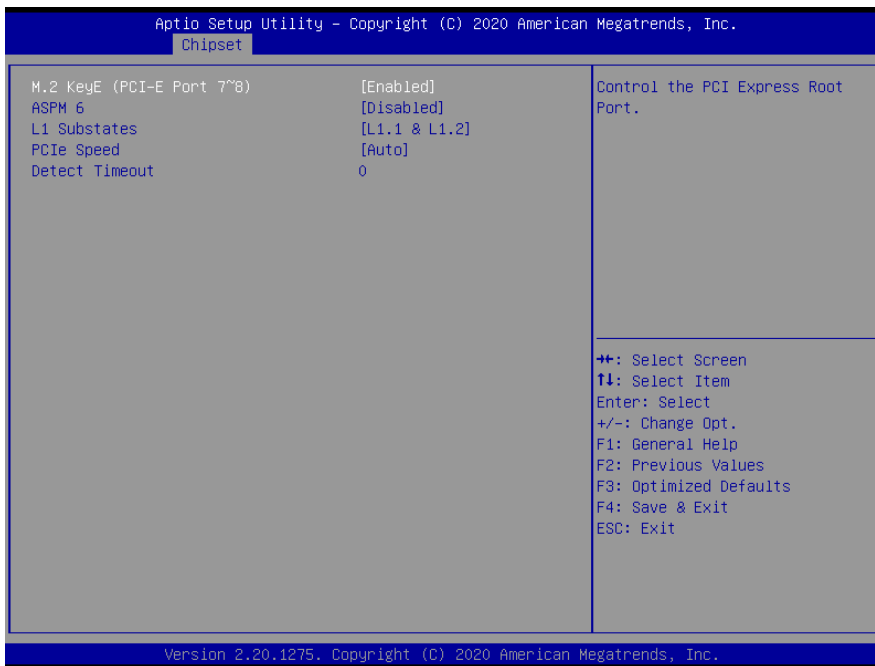

Item	Option	Description
<b>M.2 KeyE (PCI-E Port 7~8)</b>	Disabled Enabled[Default],	Control the PCI Express Root Port.
<b>ASPM 6</b>	Disabled[Default] L0s L1 L0sL1 Auto	Set the ASPM Level: Force L0s – Force all links to L0s State AUTO – BIOS auto configure DISABLE – Disables ASPM.
<b>L1 Substates</b>	Disabled L1.1 L1.1 & L1.2[Default]	PCI Express L1 Substates settings.
<b>PCIe Speed</b>	Auto[Default] Gen1 Gen2 Gen3	Configure PCIe Speed
<b>Detect Timeout</b>	0	The number of milliseconds reference code will wait for link to exit Detect state for enabled ports before assuming there is no device and potentially disabling the port.



### 3.6.3.2.1.3 Intel I211/I210 LAN Chip (PCI-E Port 11)

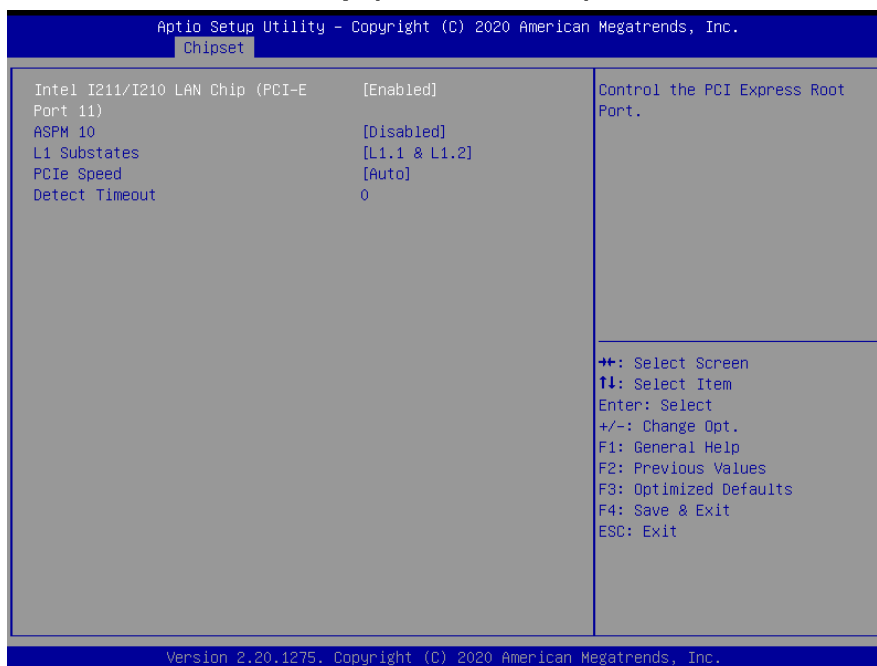

Item	Option	Description
<b>Intel I211/I210 LAN Chip (PCI-E Port 11)</b>	Disabled Enabled[ <b>Default</b> ],	Control the PCI Express Root Port.
<b>ASPM 10</b>	Disabled[ <b>Default</b> ] L0s L1 L0sL1 Auto	Set the ASPM Level: Force L0s – Force all links to L0s State AUTO – BIOS auto configure DISABLE – Disables ASPM.
<b>L1 Substates</b>	Disabled L1.1 L1.1 & L1.2[ <b>Default</b> ]	PCI Express L1 Substates settings.
<b>PCIe Speed</b>	Auto[ <b>Default</b> ] Gen1 Gen2 Gen3	Configure PCIe Speed
<b>Detect Timeout</b>	0	The number of milliseconds reference code will wait for link to exit Detect state for enabled ports before assuming there is no device and potentially disabling the port.

3.6.3.2.2 SATA And RST Configuration

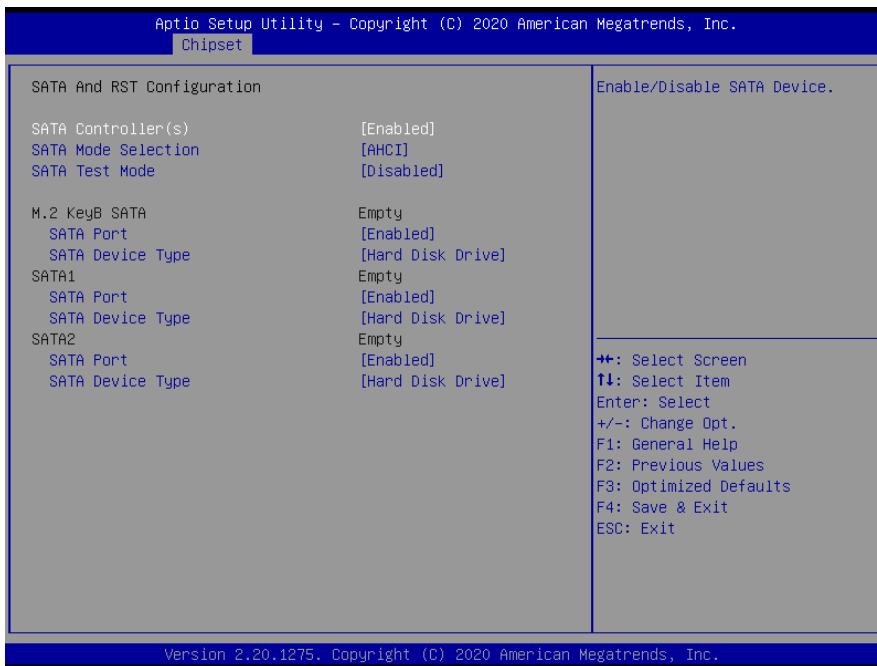

Item	Options	Description
<b>SATA Configuration(S)</b>	Enabled[ <b>Default</b> ], Disabled	Enable/Disable SATA Device.
<b>SATA Mode Selection</b>	AHCI[ <b>Default</b> ], RAID	Determines how SATA controller(s) operate.
<b>SATA Test Mode</b>	Enabled Disabled[ <b>Default</b> ],	Test Mode Enable/Disable (Loop Back).
<b>SATA Port</b>	Disabled Enabled[ <b>Default</b> ],	Enable or Disable SATA Port
<b>SATA Device Type</b>	Hard Disk Drive[ <b>Default</b> ], Solid State Drive	Identify the SATA port is connected to Solid State Drive or Hard Disk Drive.

### 3.6.3.2.3 HD Audio Configuration

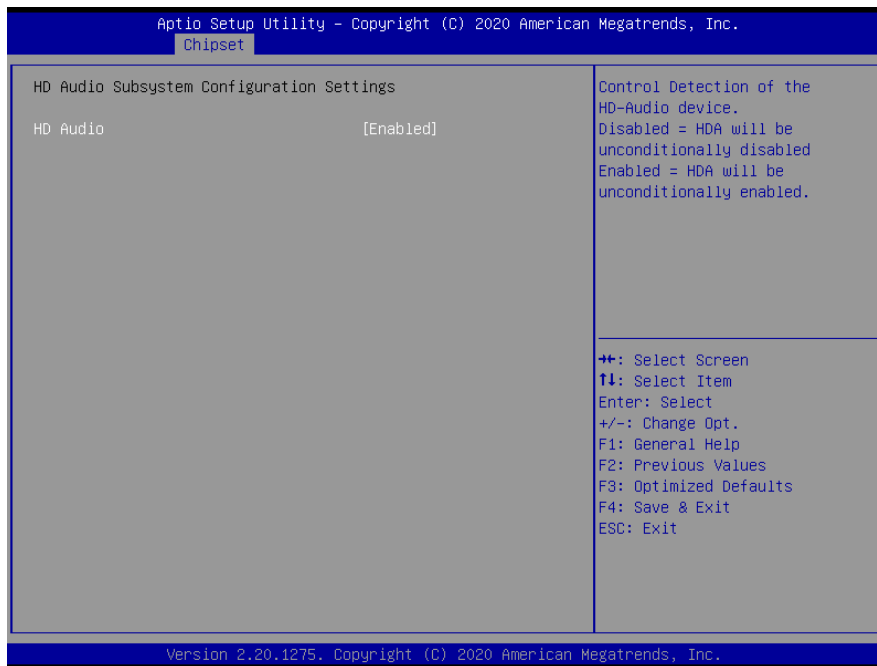

Item	Option	Description
HD Audio	Disabled Enabled[Default],	Control Detection of the HD-Audio device. Disabled = HDA will be unconditionally disabled Enabled = HDA will be unconditionally enabled.

### 3.6.3.3 Board Configuration

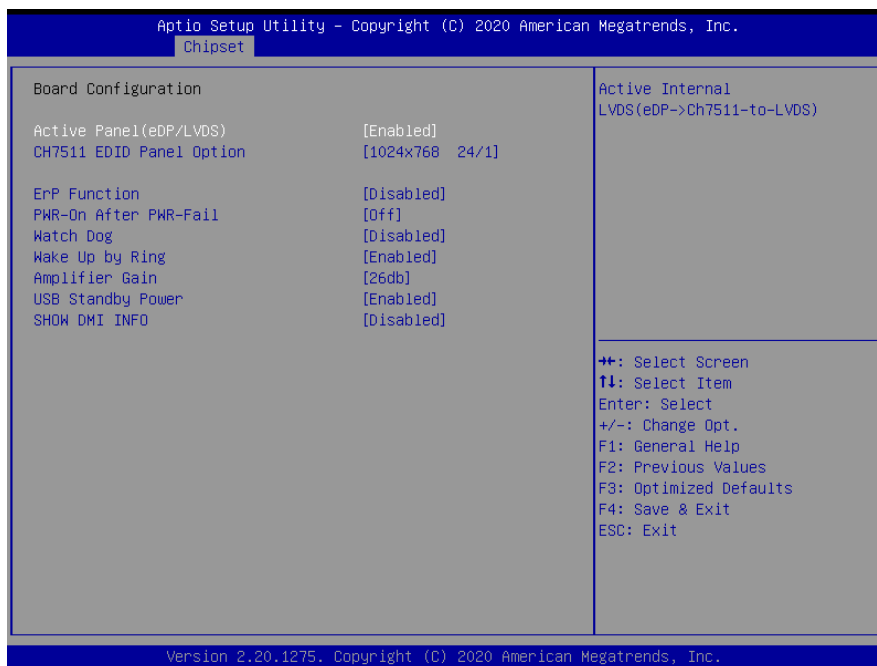

Item	Option	Description
Active Panel (eDP/LVDS)	Disabled Enabled[Default],	Active Internal LVDS(eDP->Ch7511-to-LVDS)

## EMX-H310DP User's Manual

<b>CH7511 EDID Panel Option</b>	1024x768 24/1[Default], 800x600 18/1 1024x768 18/1 1366x768 18/1 1024x600 18/1 1280x800 18/1 1920x1200 24/2 1920x1080 18/2 1280x1024 24/2 1440x900 18/2 1600x1200 24/2 1366x768 24/1 1920x1080 24/2 1680x1050 24/2	Port1-EDP to LVDS(Chrotel 7511) Panel EDID Option
<b>ErP Function</b>	Disabled[Default], Enabled	ErP Function (Deep S5).
<b>PWR-On After PWR-Fail</b>	Off[Default], On Last state	AC loss resume.
<b>Watch Dog</b>	Disabled[Default], 30 sec 40 sec 50 sec 1 min 2 min 10 min 30 min	Select WatchDog.
<b>Wake Up by Ring</b>	Disabled Enabled[Default],	Wake Up by Ring from S3/S4/S5
<b>Amplifier Gain</b>	20db 26db[Default], 32db	Amplifier Gain
<b>USB Standby Power</b>	Disabled Enabled[Default],	Enabled/Disabled USB Standby Power during S3/S4/S5
<b>SHOW DMI INFO</b>	Disabled[Default], Enabled	SHOW DMI INFO

### 3.6.4 Security

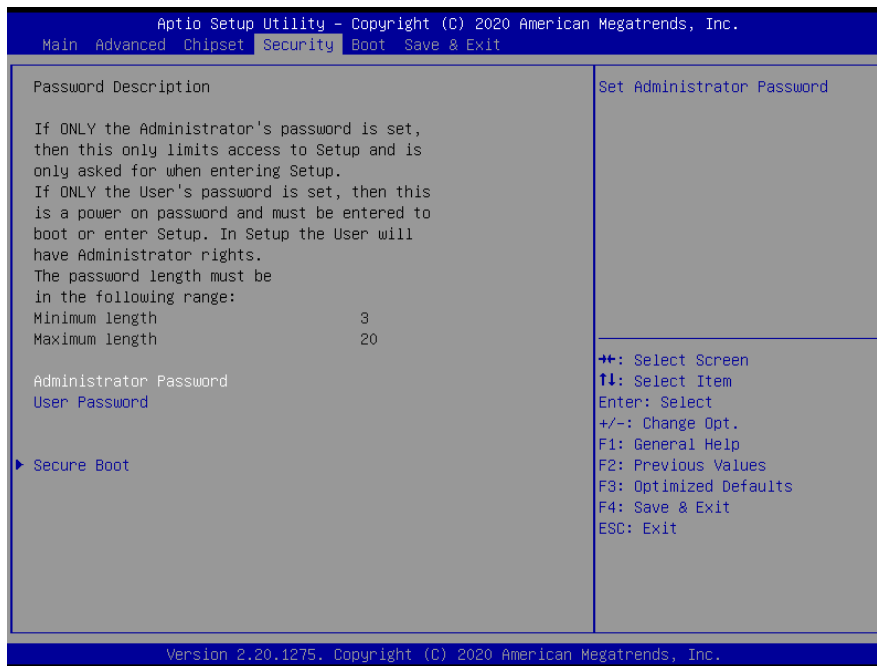

Item	Description
<b>Administrator Password</b>	Set Administrator Password
<b>User Password</b>	Set User Password

#### 3.6.4.1 Secure Boot



## EMX-H310DP User's Manual

Item	Option	Description
Secure Boot	Disabled[Default], Enabled	Secure Boot feature is Active if Secure Boot is Enabled, Platform Key(PK) is enrolled and the System is in User mode. The mode change requires platform reset
Secure Boot Mode	Standard Custom[Default],	Secure Boot mode options: Standard or Custom. In Custom mode, Secure Boot Policy variables can be configured by a physically present user without full authentication

### 3.6.4.1.1 Restore Factory Keys

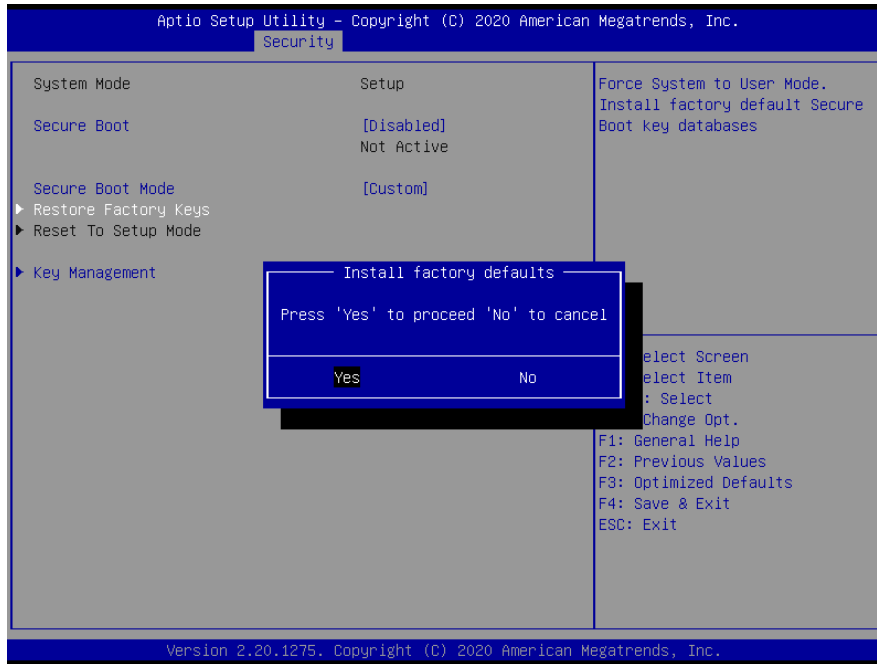

### 3.6.4.1.2 Key Management

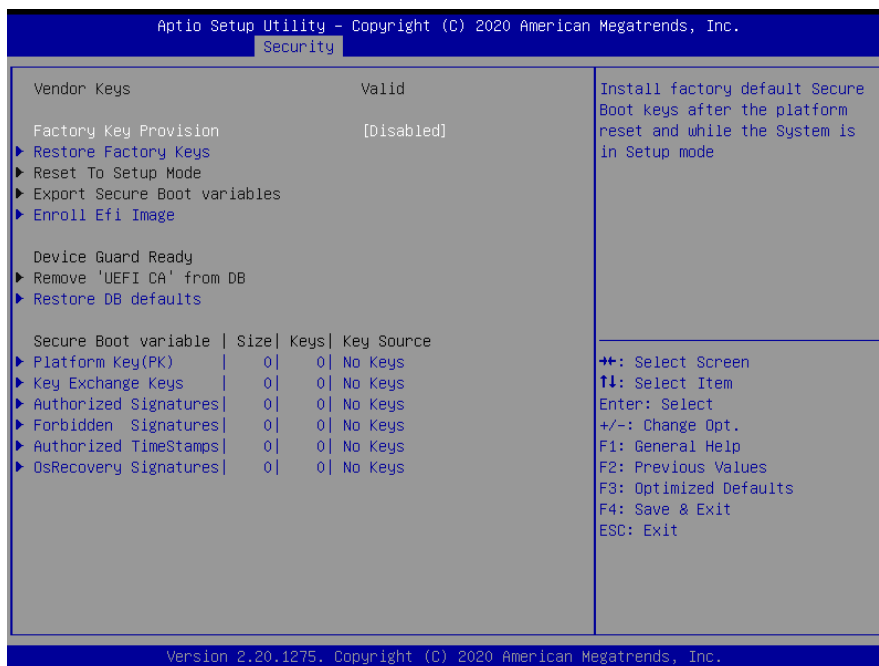

### 3.6.5 Boot

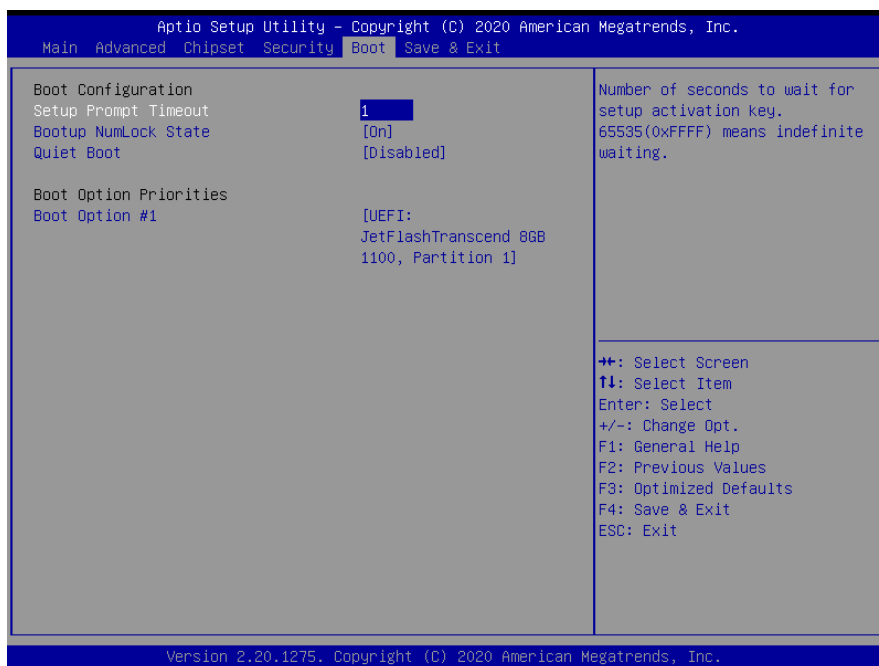

Item	Option	Description
Setup Prompt Timeout	1	Number of seconds to wait for setup activation key. 65535(0xFFFF) means indefinite waiting.
Bootup NumLock State	On[Default] Off	Select the keyboard NumLock state.
Quiet Boot	Disabled[Default]	Enable or disable Quiet Boot option.

# EMX-H310DP User's Manual

	Enabled	
<b>Boot Option #1</b>	Sets the system boot order	

## 3.6.6 Save & Exit

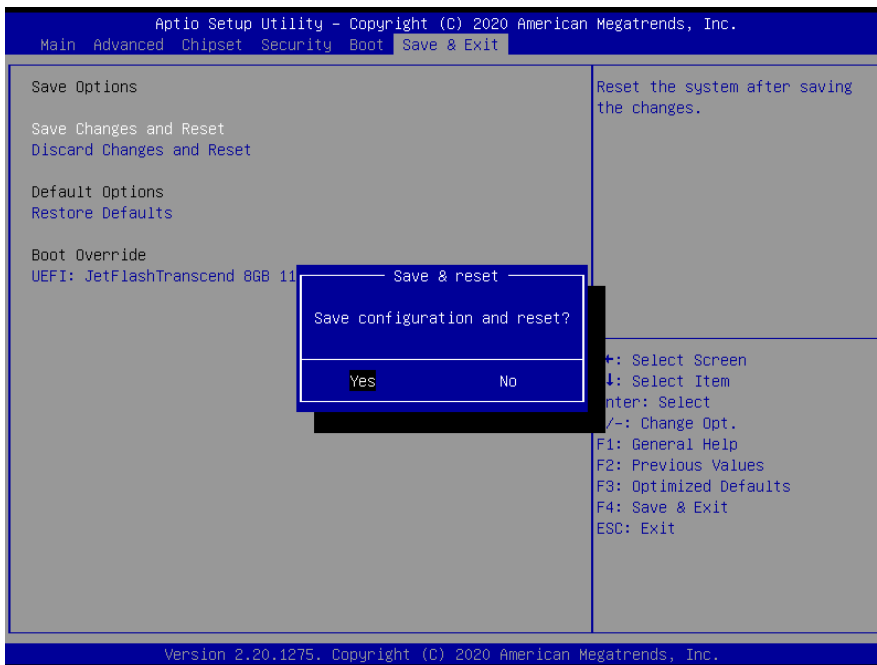

### 3.6.5.1 Save Changes and Reset

Reset the system after saving the changes.



### **3.6.5.2 *Discard Changes and Reset***

Any changes made to BIOS settings during this session of the BIOS setup program are discarded. The setup program then exits and reboots the controller.

### **3.6.5.3 *Restore Defaults***

This option restores all BIOS settings to the factory default. This option is useful if the controller exhibits unpredictable behavior due to an incorrect or inappropriate BIOS setting.

### **3.6.5.4 *Launch EFI Shell from filesystem device***

Attempts to Launch EFI Shell application (Shellx64.efi) from one of the available filesystem devices.

# 4. Drivers Installation

---



**Note:** Installation procedures and screen shots in this section are for your reference and may not be exactly the same as shown on your screen.

## 4.1 Install Chipset Driver

All drivers can be found on the Avalue Official Website:

<http://www.avalue.com.tw>.



**Note:** The installation procedures and screen shots in this section are based on Windows 10 operation system. If the warning message appears while the installation process, click Continue to go on.

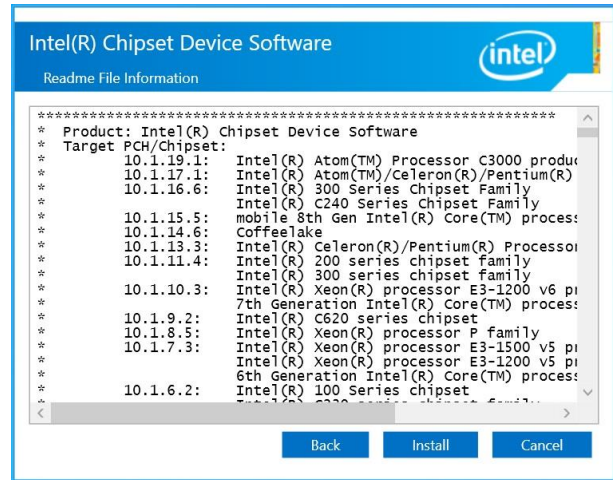

### Step 3. Click Install.



### Step 1. Click Next.

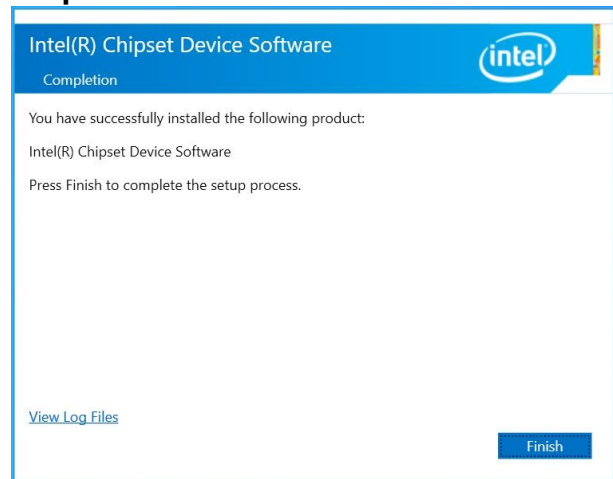

### Step 4. Complete setup.

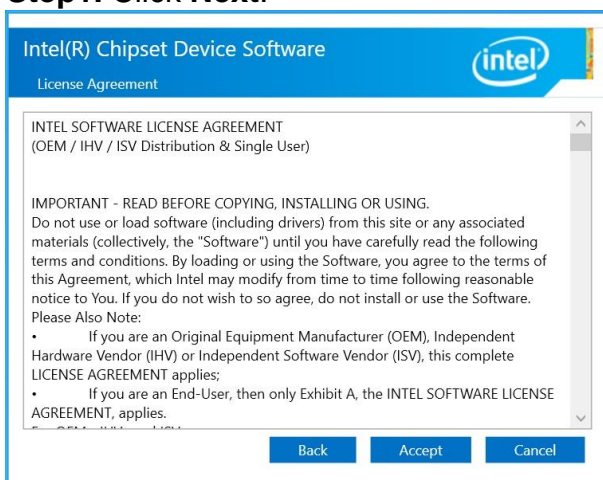

### Step 2. Click Accept.

## 4.2 Install VGA Driver

All drivers can be found on the Avalue Official Website:

<http://www.avalue.com.tw>.



**Note:** The installation procedures and screen shots in this section are based on Windows 10 operation system. If the warning message appears while the installation process, click Continue to go on.

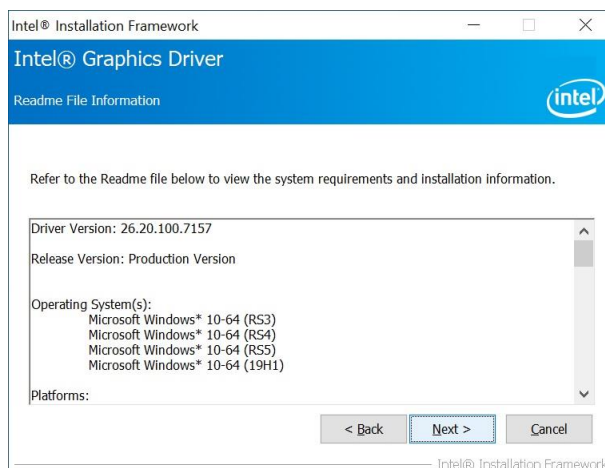

**Step 3. Click Next.**

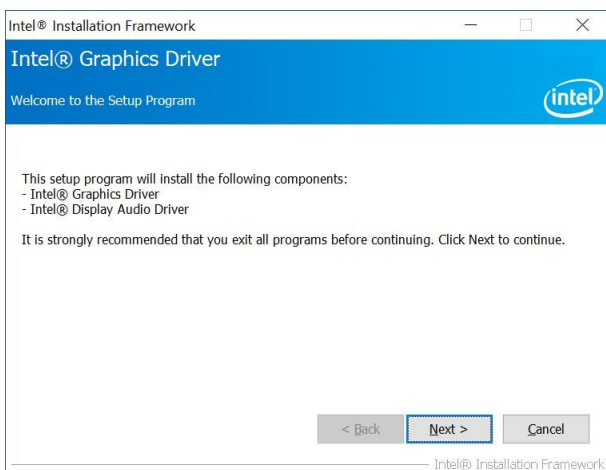

**Step 1. Click Next** to continue installation.

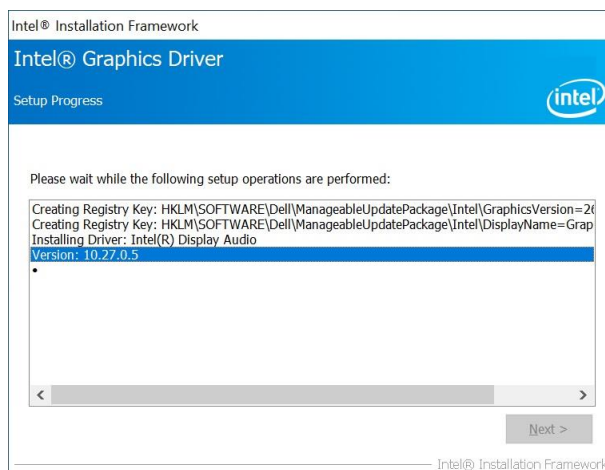

**Step 4. Click Next.**

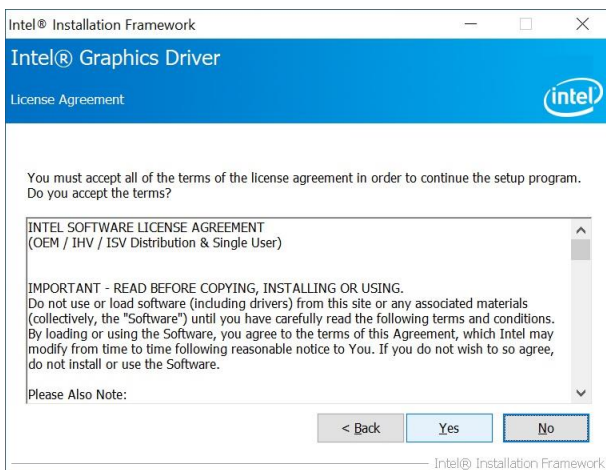

**Step 2. Click Yes.**

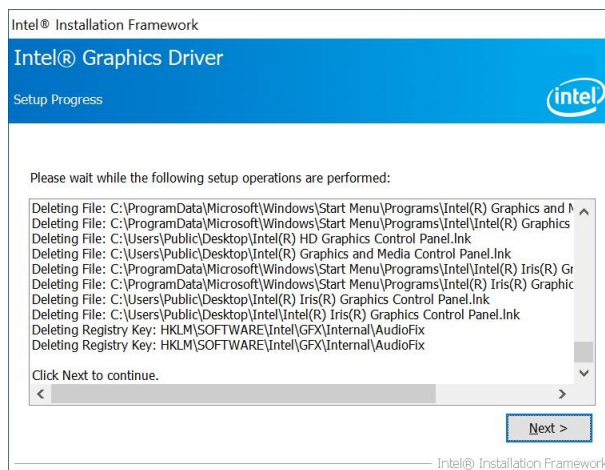

**Step 5. Click Next.**

### SUPPORTED PRODUCTS:

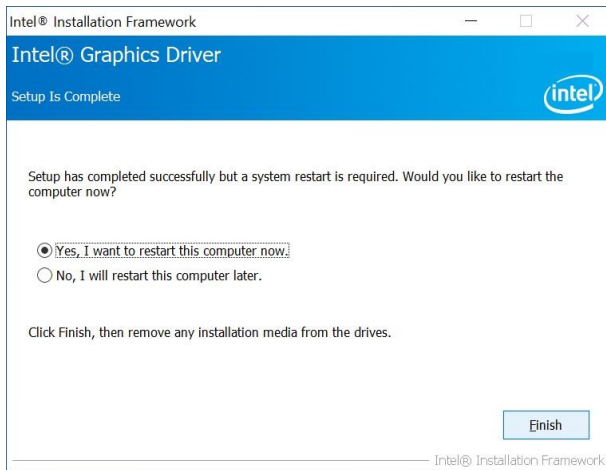

**Step 6. Click Finish** to complete setup.

The Intel® Graphics Driver contains support for the following Intel Chipsets/Processors with the following graphic support: Intel®, Iris® Pro and Intel® HD graphics:

- 6<sup>th</sup> Gen Intel® Core™ processor family (codename Skylake) (Workstation-Xeon)

## 4.3 Install ME Driver

All drivers can be found on the Avalue Official Website:

<http://www.avalue.com.tw>.



**Note:** The installation procedures and screen shots in this section are based on Windows 10 operation system. If the warning message appears while the installation process, click Continue to go on.

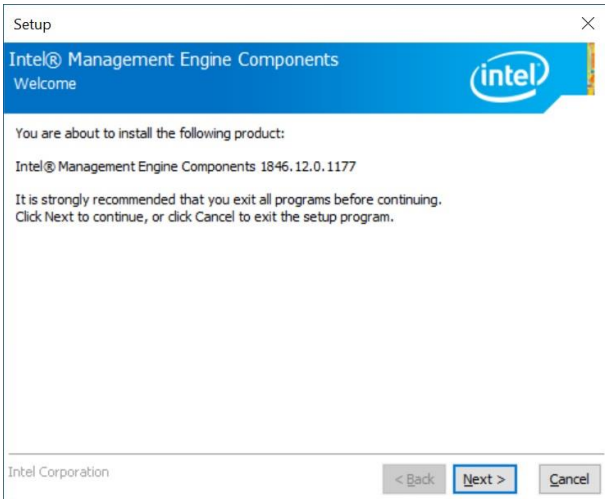

**Step 1.** Click **Next** to continue setup.



**Step 2.** Click **Next**.

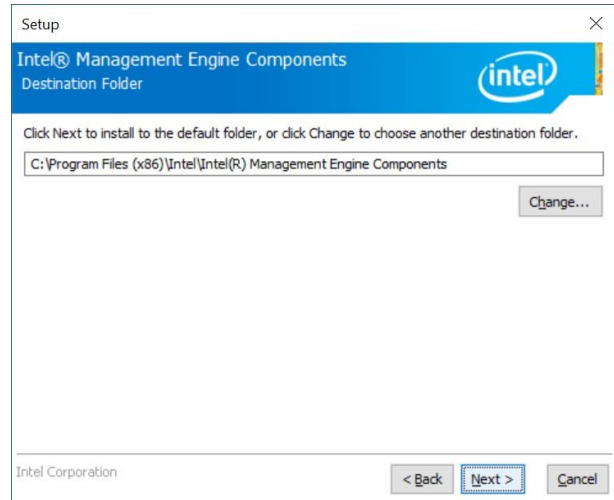

**Step 3.** Click **Next**

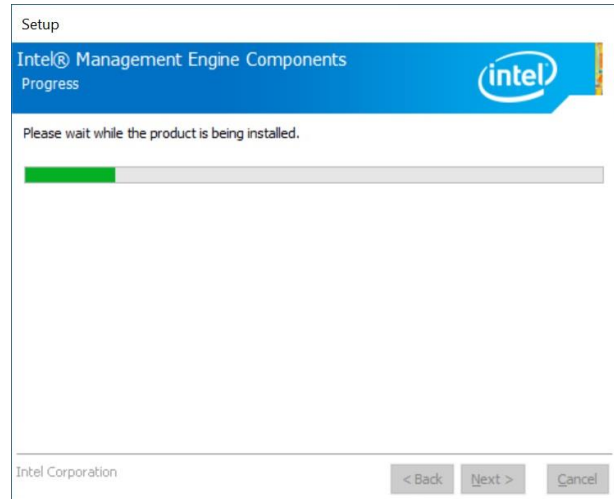

**Step 4.** Click **Next**

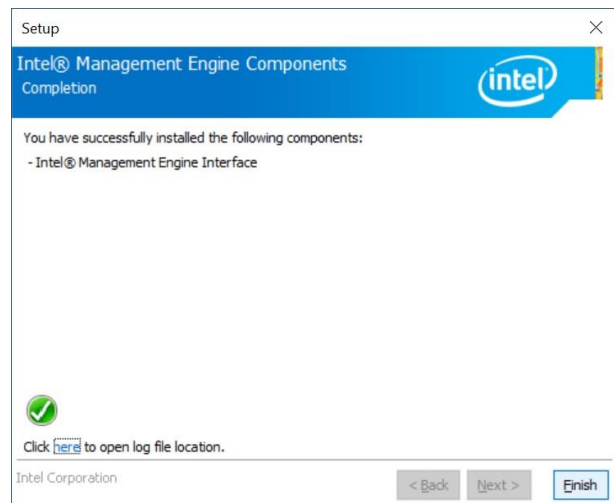

**Step 5.** Click **Finish** to complete the setup

## 4.4 Install Audio Driver

All drivers can be found on the Avalue Official Website:

<http://www.avalue.com.tw>.



**Note:** The installation procedures and screen shots in this section are based on Windows 10 operation system.

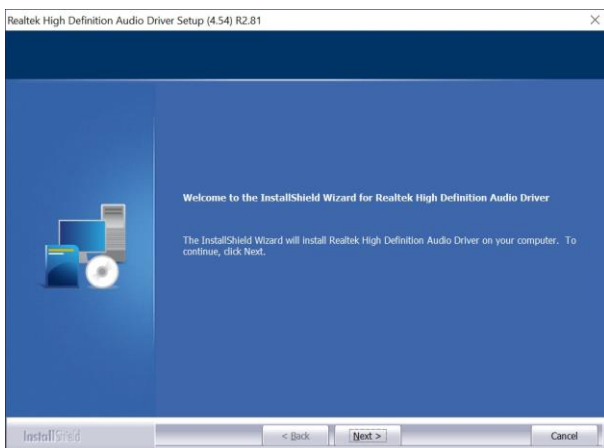

**Step 1.** Click **Next** to Install.



**Step 3.** Select **Finish** to complete Installation.

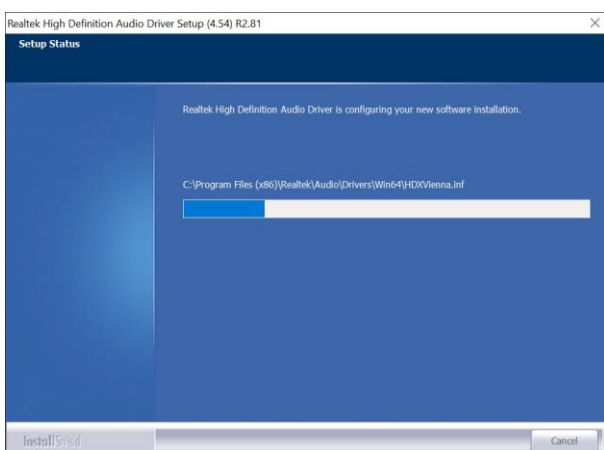

**Step 2.** Click **Next**.

## 4.5 Install LAN Driver

All drivers can be found on the Avalue Official Website:  
<http://www.avalu.com.tw>.



**Note:** The installation procedures and screen shots in this section are based on Windows 10 operation system.

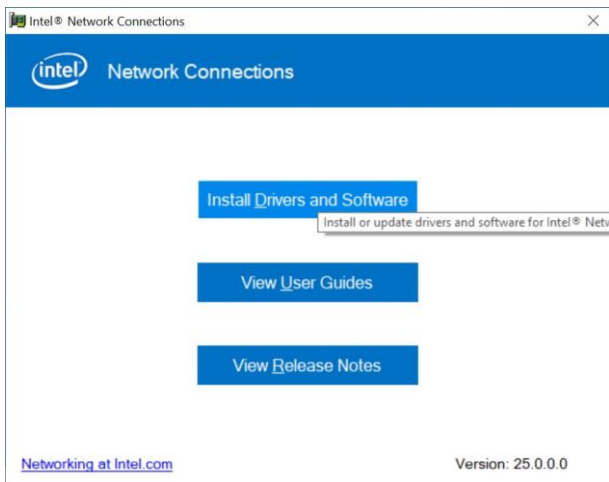

**Step 1. Click Install Drivers and Software**

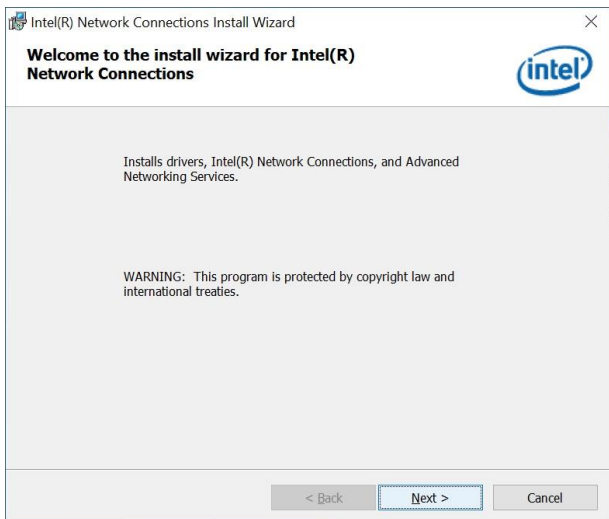

**Step 2. Click Next** to continue installation.

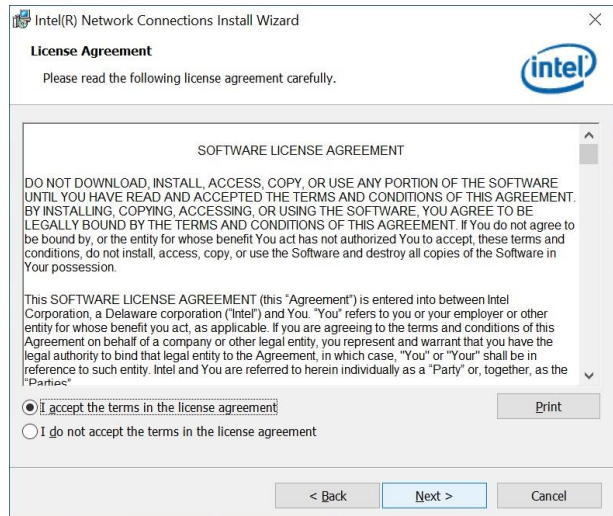

**Step 3. Click Next.**

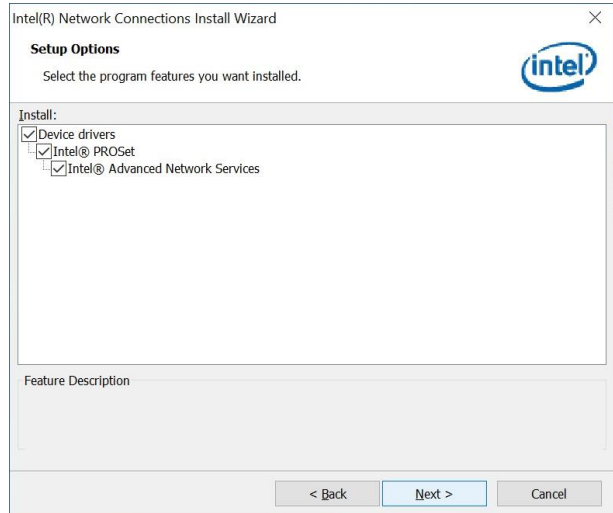

**Step 4. Click Next.**

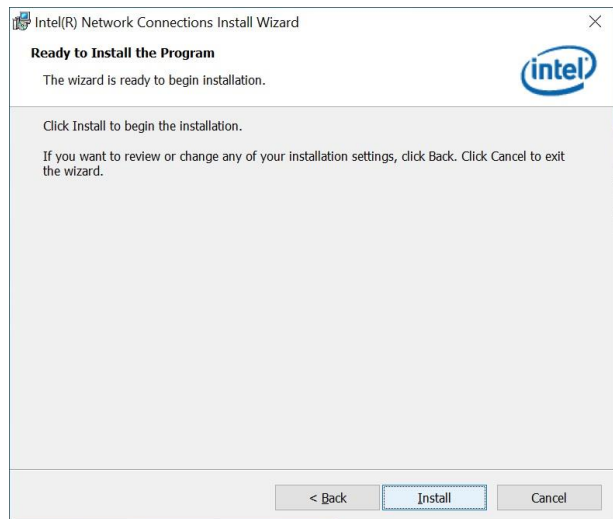

**Step 5. Click Install.**



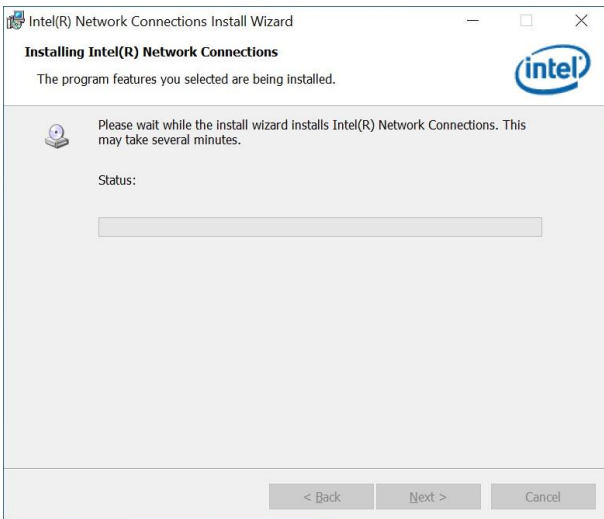

**Step 6. Click Next.**

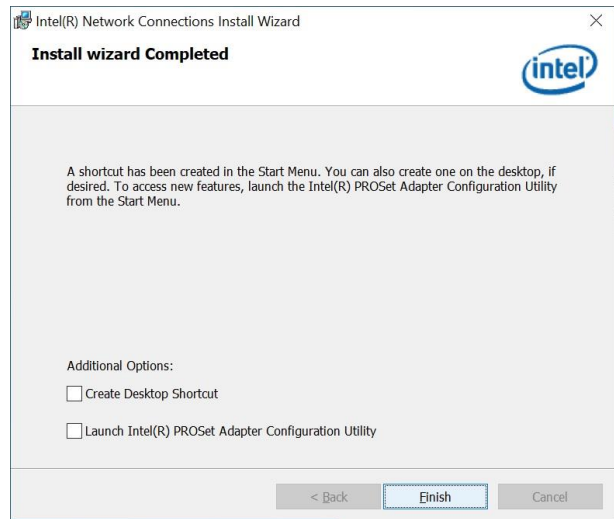

**Step 7. Click Finish to complete setup.**

## 4.6 Install RST Driver

All drivers can be found on the Avalue Official Website:  
<http://www.avalue.com.tw>.



**Note:** The installation procedures and screen shots in this section are based on Windows 10 operation system.

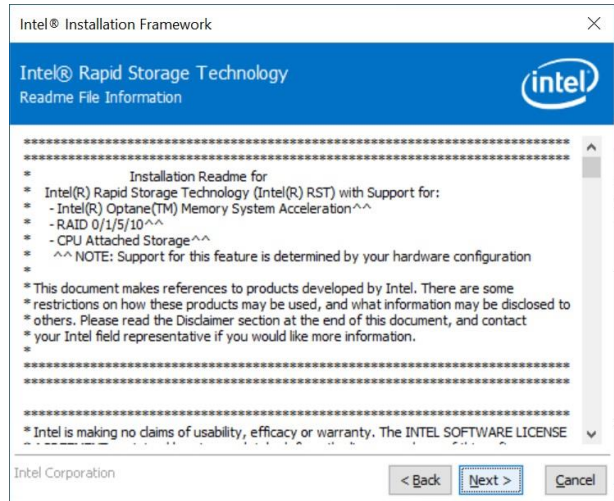

**Step 3. Click Next.**

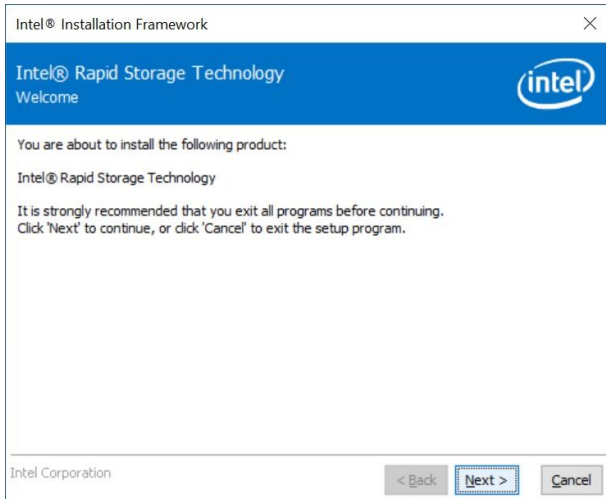

**Step 1. Click Next** to continue installation.

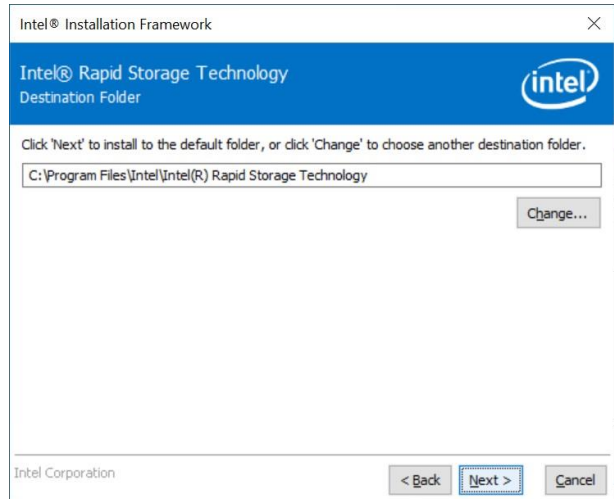

**Step 4. Click Next.**

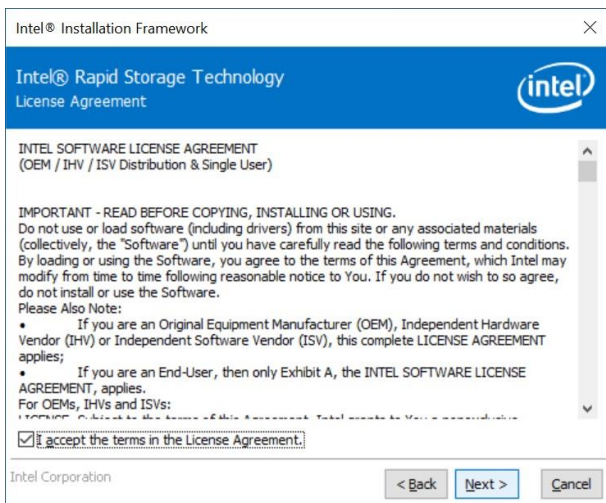

**Step 2. Click Next.**

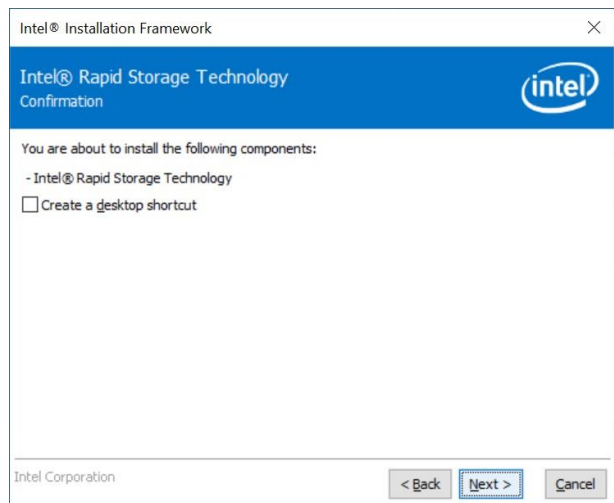

**Step 5. Click Finish** to complete setup.

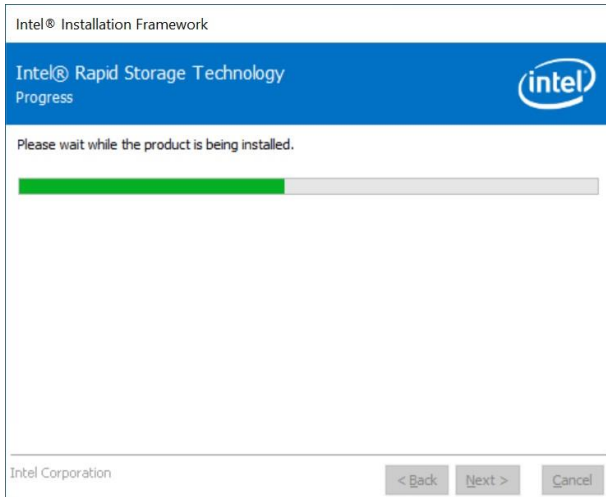

**Step 6. Click Next.**

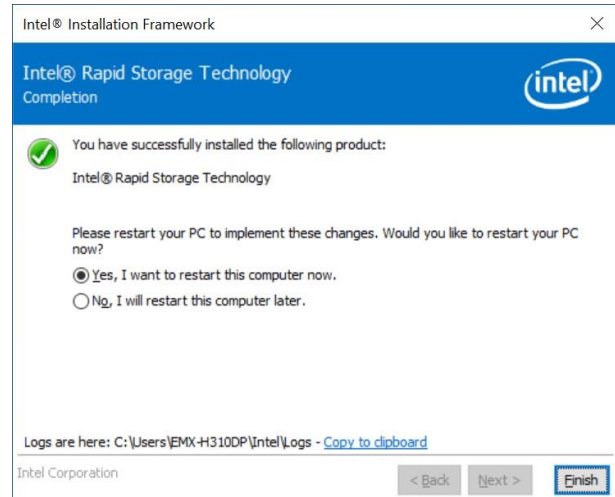

**Step 6. Click Finish to complete setup.**

# 5. Mechanical Drawing



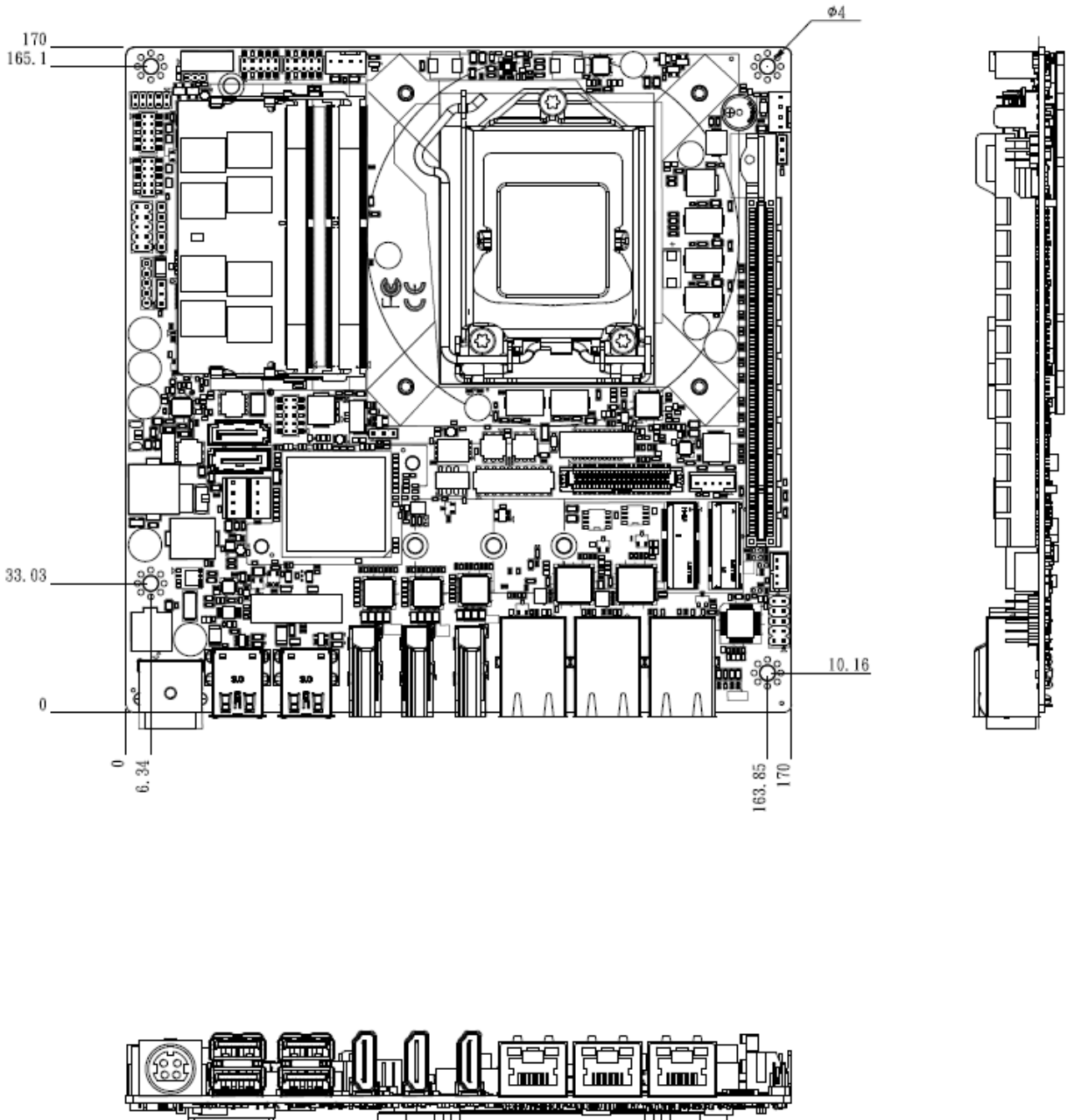

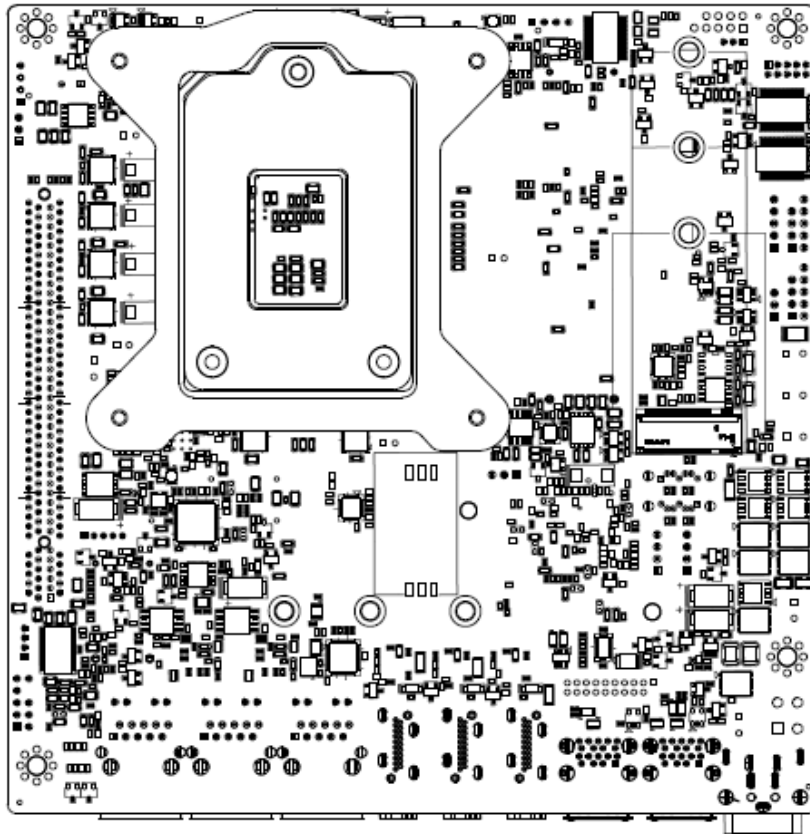

Unit: mm

