



L18

1U Liquid Cooler

PRODUCT SPECIFICATIONS

Table of Contents

- 1. PRODUCT DESCRIPTION 2
- 2. THERMAL PERFORMANCE CURVE..... 4
- 3. ASSEMBLY DRAWING 5
- 4. FAN SPECIFICATION 8

Model Number: L18

- Server Liquid Cooling Solution Recommended for AMD® Ryzen Threadripper Processor, Socket sWRX8, sTRX4, TR4, and AMD® Epyc Processor Socket SP3
- For 1U Server and up

Overall Specification

- Cold Plate Module with Copper base
- Space-saving lightweight Radiator
- 4cm Cooling Fans with 4-Pin PWM Function
- Stand-alone Water Pump with Powerful Flow Rate 1.7 Litter Per Minute
- EPDM Hoses Assembled
- Mounting Accessories are included
- Shin-Etsu 7762 Thermal Compound Pre-Printed on Base
- Support up to 225 Watts CPU Power Heat Dissipation

Fan Specification

Model Number	DF124028BM - PWM
Dimension	40 x 40 x 28 mm
Bearing	Double Ball
Rated Voltage	12V
Rated Speed	At Duty Cycle 0~20%: 2500 ± 10% RPM At Duty Cycle 50%: 6700 ± 10% RPM At Duty Cycle 100%: 12000 ±10% RPM
Input Power	At Duty Cycle 0~20%: 1.2 W At Duty Cycle 50%: 3.0 W At Duty Cycle 100%: 8.4 W
Maximum Airflow	At Duty Cycle 0~20%: 5.175 CFM At Duty Cycle 50%: 13.869 CFM At Duty Cycle 100%: 24.840 CFM
Rated Static Pressure	At Duty Cycle 0~20%: 1.39 mm-H2O At Duty Cycle 50%: 9.98 mm-H2O At Duty Cycle 100%: 32.01 mm-H2O
Acoustical Noise	At Duty Cycle 0~20%: 18.74 dBA At Duty Cycle 50%: 40.15 dBA At Duty Cycle 100%: 52.80 dBA

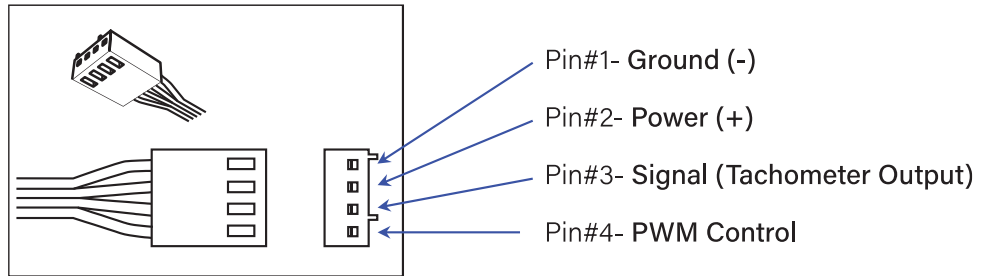
**Lead Wire Pin Out
Diagram**

L18 Thermal Performance Curve Cooling Performance vs. Airflow

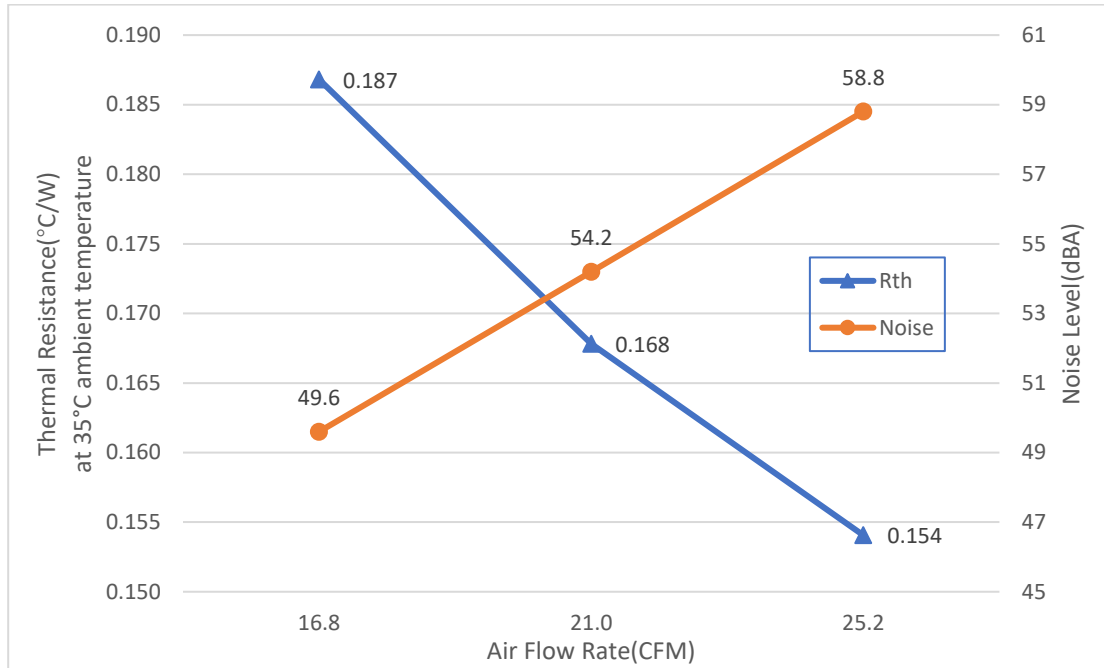

Cooling Performance vs. Fan Speed

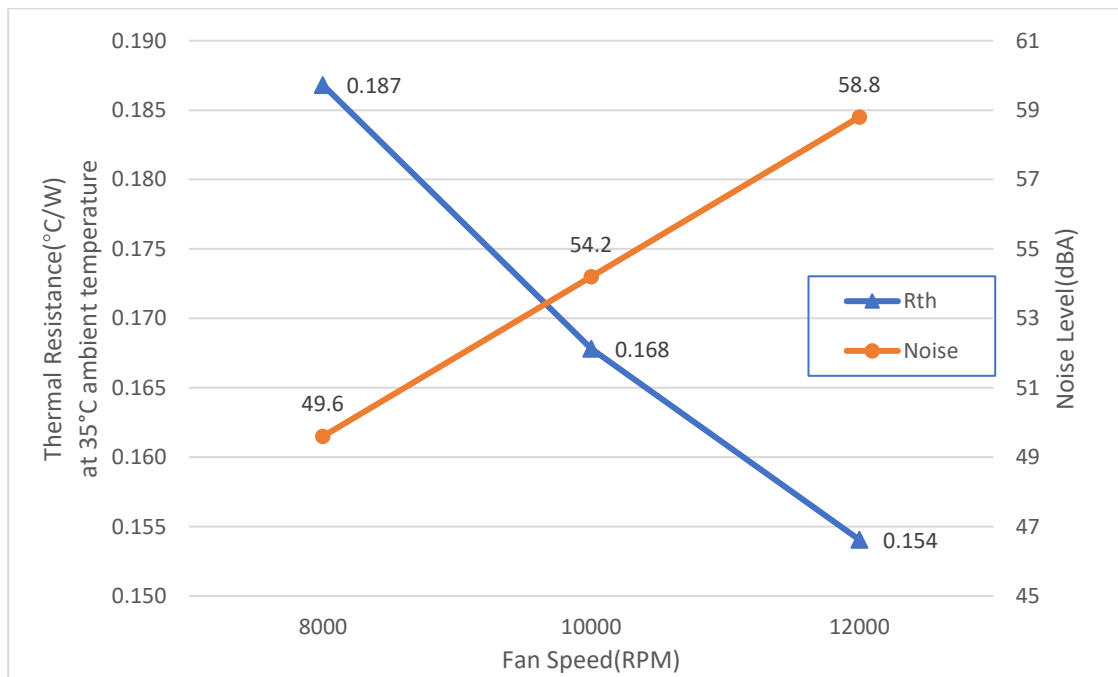

CONFIDENTIAL DOCUMENT

THIS DRAWING CONTAINS INFORMATION PROPRIETARY TO DYNATRON CORPORATION AND DYNAEON INDUSTRIAL CO., LTD. ANY REPRODUCTION, DISCLOSURE, OR USE OF THIS DRAWING IS EXPRESSLY PROHIBITED EXCEPT AS DYNATRON CORPORATION AND DYNAEON INDUSTRIAL CO., LTD. MAY OTHERWISE AGREE TO IN WRITING.

ASSEMBLY PARTS

REV#	DESCRIPTION	CHECKER	DATE
0.0	INITIAL RELEASE	LANG	11/21/2019
1.0	HOSE LENGTH CHANGE	LANG	12/13/2019
2.0	SPRING CHANGE WASHER CHANGE	JOY	10/14/20

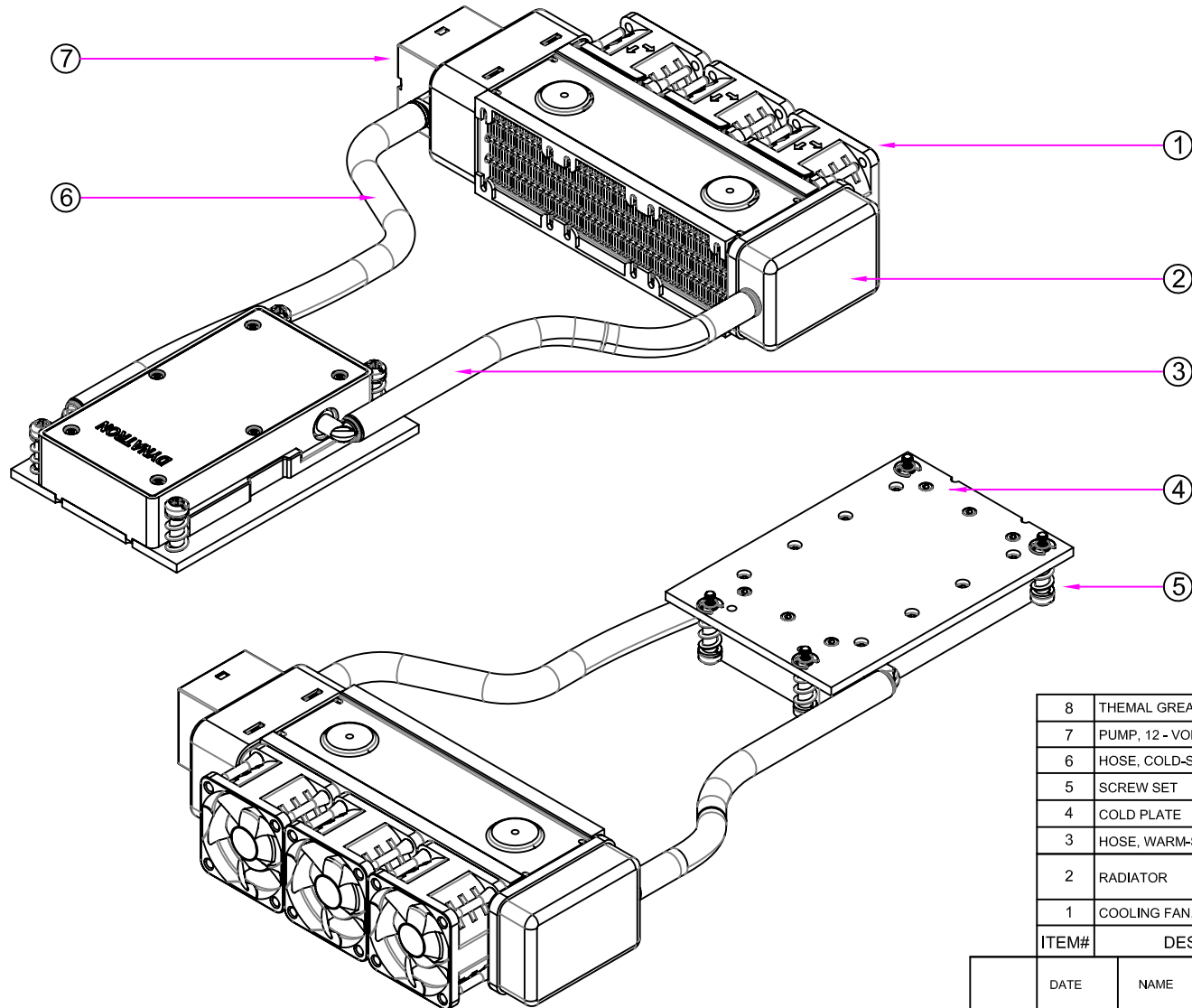

ITEM#	DESCRIPTION	MATERIAL	QTY.
8	THEMAL GREASE, PRE-PRINTED	SHIN-ETSU 7762	1
7	PUMP, 12 - VOLT	PLASTIC	1
6	HOSE, COLD-SIDE, 350 mm L	EPDM	1
5	SCREW SET	STEEL / SUS304	4
4	COLD PLATE	SEE PAGE 8	1
3	HOSE, WARM-SIDE, 300 mm L	EPDM	1
2	RADIATOR	ALUMINUM ALLOY SEE PAGE 7	1
1	COOLING FAN, DF124028BM-PWM, 12000RPM	PLASTIC	3

NOTES:
1. THE FIGURE IS FOR REFERENCE ONLY, AND NOT FOR SCALE

DATE	NAME	 DYNATRON CORPORATION	
DRAWN	12/13/2019		Engr
CHECKED	10/14/2020		JOY
ENG. APPR.			
MFG. APPR.			
Q.A.			
COMMENTS:			
DWG. No:		DYN-EP-L18	
REV		1.0	

TITLE:
Liquid Cooler Model **L18**
BOM & Assembly Drawing

1 2 3 4 5 6 7

REV#	DESCRIPTION	CHECKER	DATE
0.0	INITIAL RELEASE	LANG	11/22/2019

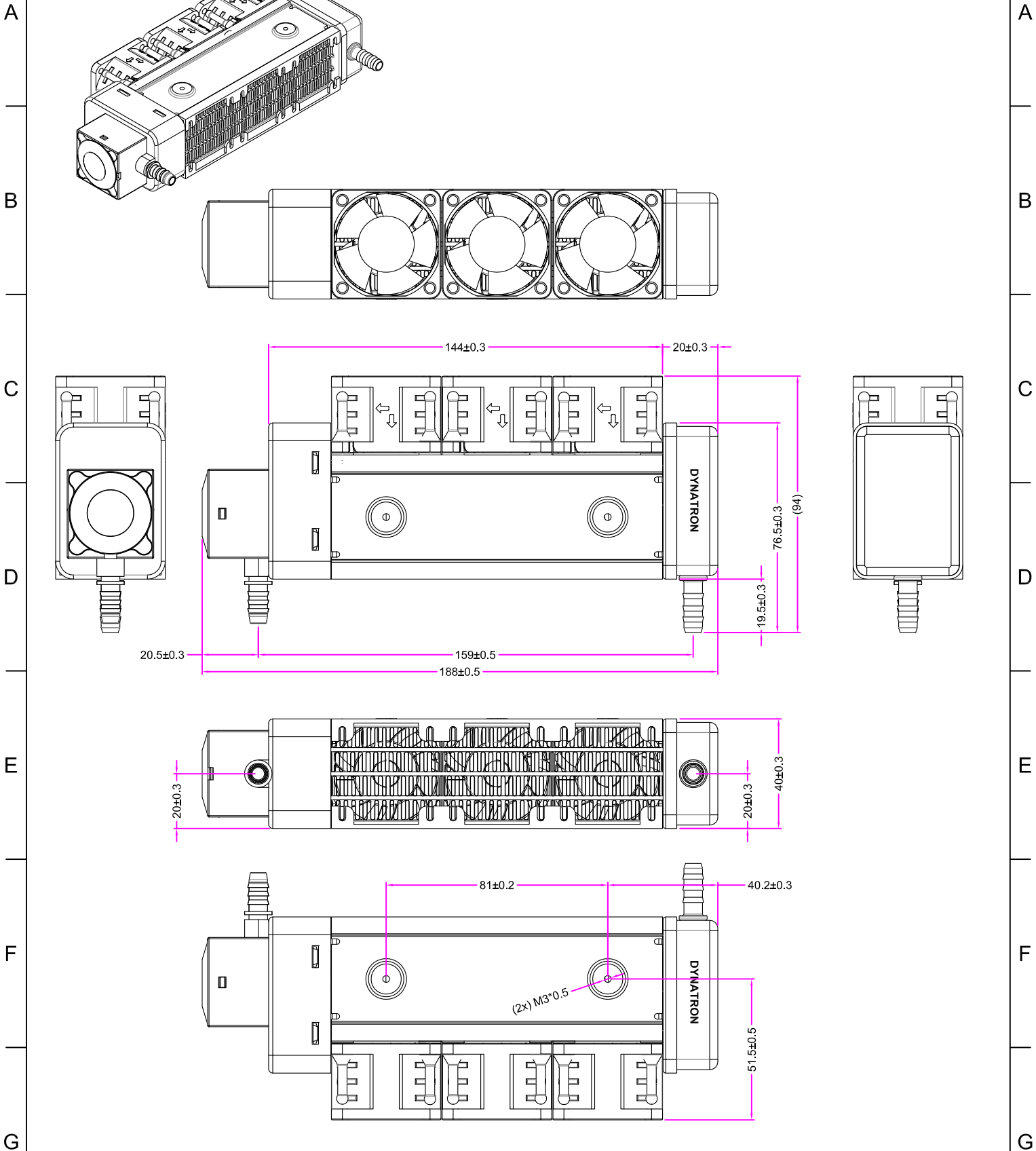

	NAME	DATE
DRAWN BY	ENGR	11/22/19
CHECKED BY	LANG	11/22/19
ENG. APPROVED		
MFG. APPROVED	-	-



DYNATRON CORPORATION

TOP MOTOR

TITLE: 1U Server Liquid Cooler Condenser
Overall Dimension Drawing

CONFIDENTIAL DOCUMENT
THIS DRAWING CONTAINS INFORMATION PROPRIETARY TO DYNATRON CORPORATION AND DYNAEON INDUSTRIAL CO., LTD. ANY REPRODUCTION, DISCLOSURE, OR USE OF THIS DRAWING IS EXPRESSLY PROHIBITED EXCEPT AS DYNATRON CORPORATION AND DYNAEON INDUSTRIAL CO., LTD. MAY OTHERWISE AGREE TO IN WRITING.

VIEW	
UNITS	MM

DWG. No:

REV. 0.0

1 2 3 4 5 6 7

REV#	DESCRIPTION	CHECKER	DATE
0.0	INITIAL RELEASE	LANG	11/22/19
1.0	SPRING CHANGE WASHER CHANGE	JOY	10/14/20

A

A

B

B

C

C

D

D

E

E

F

F

G

G

H

H

1

2

3

4

5

6

7

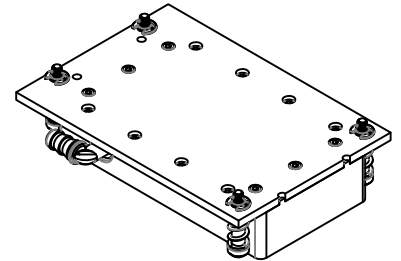
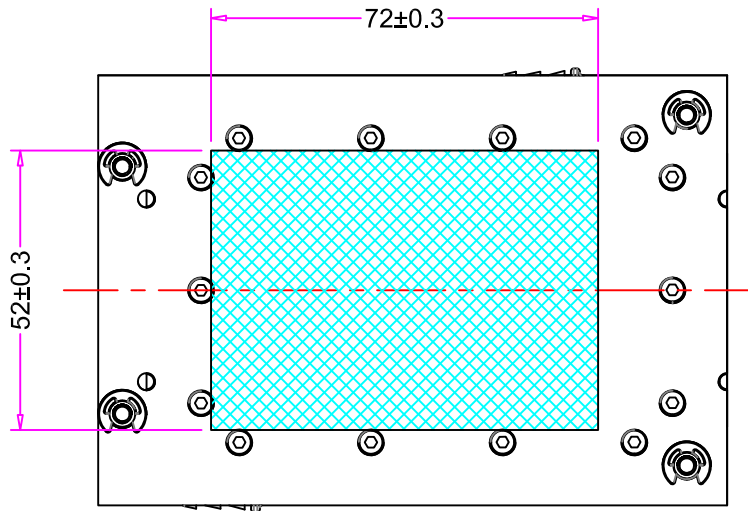
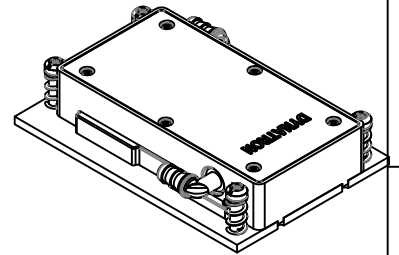
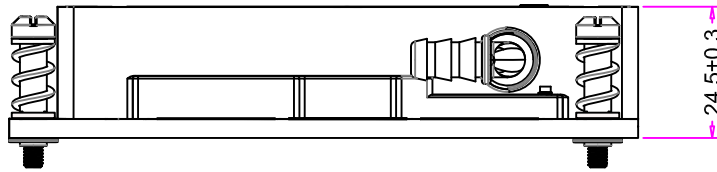
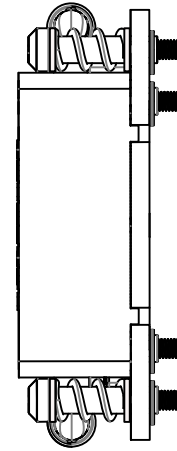
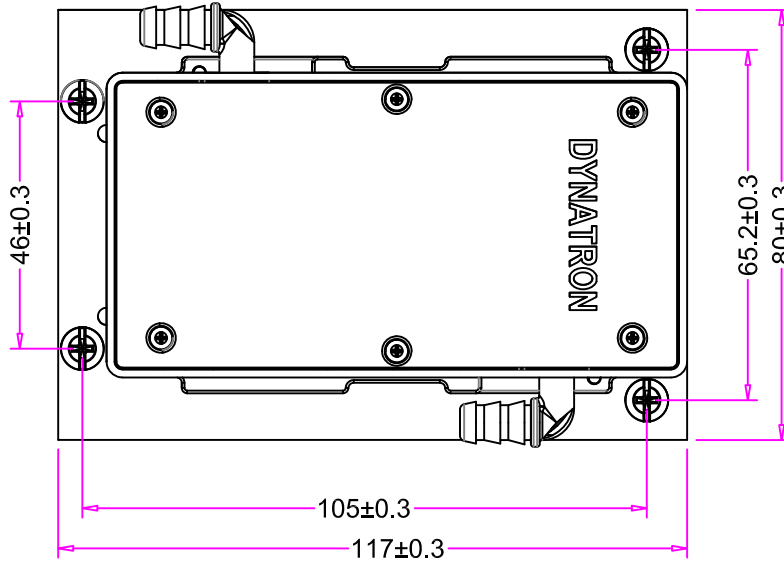
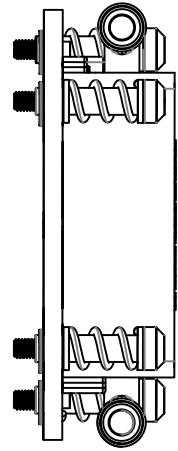
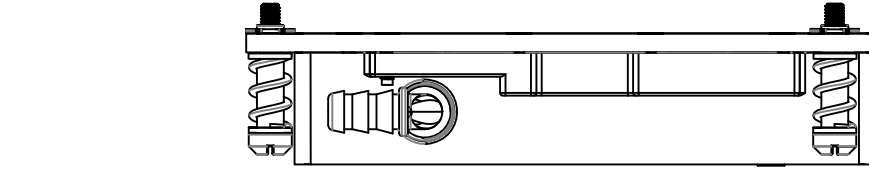

9	THERMAL GREASE, PRE-APPLIED	SHIN-ETSU 7762	1
8	C-CLIP	STEEL	4
7	WASHER	STEEL	8
6	SPRING	SUS304	4
5	SCREW, COLD PLATE MOUNTING	STEEL	4
4	SCREW, ENCLOSURE MOUNTING	STEEL	14
3	HOSE FITTING	PPS	2
2	COLD PLATE ENCLOSURE	PPS	1
1	COLD PLATE BASE	COPPER 1100	1
ITEM#	DESCRIPTION	MATERIAL	QTY.

	NAME	DATE
DRAWN BY	Engr.	11/22/19
CHECKED BY	JOY	10/14/2020
ENG. APPROVED		
MFG. APPROVED	-	-



TOP MOTOR

DYNATRON CORPORATION

TITLE: Cold Plate, Liquid Cooler
for AMD Socket SP3/TR3/TR4
BOM & Overall Dimension Drawing

VIEW	
UNITS	MM

DWG. No:

DYN-BD-CP

REV.

0.0

1

2

3

4

5

6

7

CONFIDENTIAL DOCUMENT

THIS DRAWING CONTAINS INFORMATION PROPRIETARY TO DYNATRON CORPORATION AND DYNAEON INDUSTRIAL CO., LTD. ANY REPRODUCTION, DISCLOSURE, OR USE OF THIS DRAWING IS EXPRESSLY PROHIBITED EXCEPT AS DYNATRON CORPORATION AND DYNAEON INDUSTRIAL CO., LTD. MAY OTHERWISE AGREE TO IN WRITING.



DYNATRON CORPORATION

TOP MOTOR TECHNOLOGY (HUIZHOU) CO, LTD

Specification for Approval

Customer:		
Model Number:	DF124028BM-PWM (40*40*28mm)	
Part Number:	LF04280026	
Issued Date:	Friday, March 11, 2016	
Version:	A	
Customer Approval		
Approval:	Check:	
Corporate Headquarters Dynatron Corporation 33200 Western Avenue Union City, CA 94587 U.S.A. Tel: 510-498-8888 Fax: 510-498-8488	<i>Taipei Office</i> (Taiwan, R.O.C.) 8F, No. 35, Lane:221 Gang Cian. Road, Taipei, Taiwan, R.O.C. Tel: 886-2-27995799 (Rep.) Fax: 886-2-2799-9577	Manufactory TOP MOTOR TECHNOLOGY(HUI ZHOU)CO,LTD Baishi Village, QiuchangTown, Huiyang Dist, HuizhouCity, Guangdong Province, P.R.China Tel: 86-752-822-8000 (Rep.) Fax: 86-752-822-8999
Approval:	Check:	Handler:
Simon Wang	-	Hui mei



DYNATRON CORPORATION

TOP MOTOR TECHNOLOGY (HUIZHOU) CO, LTD

CONTENTS		Page
1.	SCOPE	3
2.	ELECTRICAL CHARACTERISTICS	3
3.	MECHANICAL CHARACTERISTICS	4
4.	ENVIRONMENTAL	4
5.	PROTECTION	5
6.	ATTACHMENTS	5
	6.1. Product Dimension	6
	6.2. Frequency Generator Output	7
	6.3. TUV Certificate	8
	6.4. UL Certificate	9-12
	6.5. Electrical specifications for PWM production	13-14



DYNATRON CORPORATION

TOP MOTOR TECHNOLOGY (HUIZHOU) CO, LTD

1. SCOPE

This specification defines the electrical and mechanical characteristics of the AC / DC Brush Less (Sleeve Bearing / 1-Ball Bearing / 2-Balls Bearing) axial flow fan, which is carefully designed and manufactured for your special needs by Dynatron Corporation.

2. ELECTRICAL CHARACTERISTICS

Items		Description		
1.	Rated Voltage	DC 12 V		
2.	Operating Voltage	12V±10%		
3.	PWM Frequency 25KHz	Duty Cycle D=20%	Duty Cycle D=50%	Duty Cycle D=100%
4.	Start Voltage	DC 7V		
5.	Air Flow – At rated voltage zero static pressure (minimal value)	0.147 m ³ /z min (5.175CFM)	0.393m ³ /z min (13.869CFM)	0.704m ³ / min (24.840CFM)
6.	Static Pressure – At rated voltage At zero air flow	1.39mm-H ₂ O (0.055inch-H ₂ O)	9.98mm-H ₂ O (0.393inch-H ₂ O)	32.01mm-H ₂ O (1.260inch-H ₂ O)
7.	Input Current (Max.)	0.10A	0.25A	0.70A
8.	Speed (Max.)	2500RPM ±10%	6700RPM ±10%	12000RPM ±10%
9.	Acoustical Noise	18.74dBA	40.15dBA	52.80dBA
10.	Input Power	1.2W	3.0W	8.4W
11.	Insulation Resistance – Between Frame and Terminal	10 M ohm at DC 500 V		
12.	Dielectric Strength – Between Frame and Terminal	5 mA (Max.) @ AC 500 V 60 Hz 1 min.		
13.	Life – Continuous operating under normal temperature (40 °C or 104 °F)	70,000 hours		
14.	Rotation	Anticlockwise Air Discharged		
15.	Lead Wires	UL 1061, awg 28 or Equivalent “-”: Black; “+”: Yellow; “s”: Green; “PWM”: Blue.		



DYNATRON CORPORATION

TOP MOTOR TECHNOLOGY (HUIZHOU) CO, LTD

3. MECHANICAL CHARACTERISTICS

Items		Description
1.	Dimension	Display as Drawing
2.	Frame	PBT UL94V-0 (Black GP)
3.	Impeller	PBT UL94V-0 (Black GP)
4.	Bearing System	Two Ball Bearing
5.	Weight	40±10grams

4. ENVIRONMENTAL

Items		Description
1.	Operating Temperature	- 10 °C ~ + 65 °C (65 %RH)
2.	Storage Temperature	- 30 °C ~ + 70 °C (65 %RH)
3.	Vibration Test	Displacement Amplitude: 0.75mm(Equivalent 10G) Frequency Range: 10Hz<->55Hz/30SEC. Linear Scanning 120 Cycle Endurance Timer Per Axis: 30Min. Orientation:X,Y,Z.
4.	Drop Test	Motor withstands one free body drop from 30 cm in high onto 10 mm thickness of wooden board for each of the three faces in minimum packing condition.
5.	Acoustic Noise	18.74/40.15/52.80dBA – Curve (19.24/40.65/53.30Max) Measuring Condition – Under rated voltage in semi-anechoic chamber equipment sound level meter. (Figure A.)

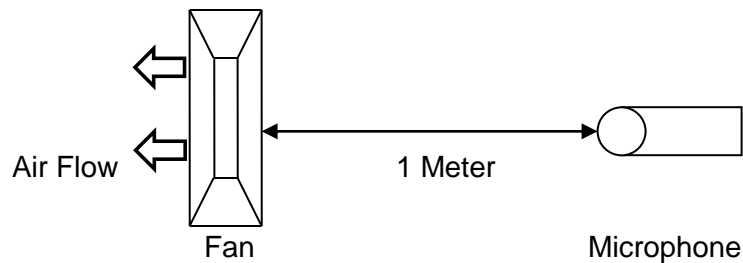

Figure A – Noise Level is measure at rated voltage in anechoic chamber in free air as above.



DYNATRON CORPORATION

TOP MOTOR TECHNOLOGY (HUIZHOU) CO, LTD

5. PROTECTION

Items		Description
1.	Polarity Protection	For polarity error connection to power, the circuit withstands reversed connection between positive and negative leads.
2.	Locked Rotor Protection	Motor winding protects the motor from damage in 72 hours of locked rotor condition at rated voltage.

6. ATTACHMENTS

- 6.1. Product Dimension
- 6.2. Frequency Generator Output
- 6.3. TUV Certificate
- 6.4. UL Certificate
- 6.5. Electrical specifications for PWM production



DYNATRON CORPORATION

TOP MOTOR TECHNOLOGY (HUIZHOU) CO, LTD

6.1. Product Dimension

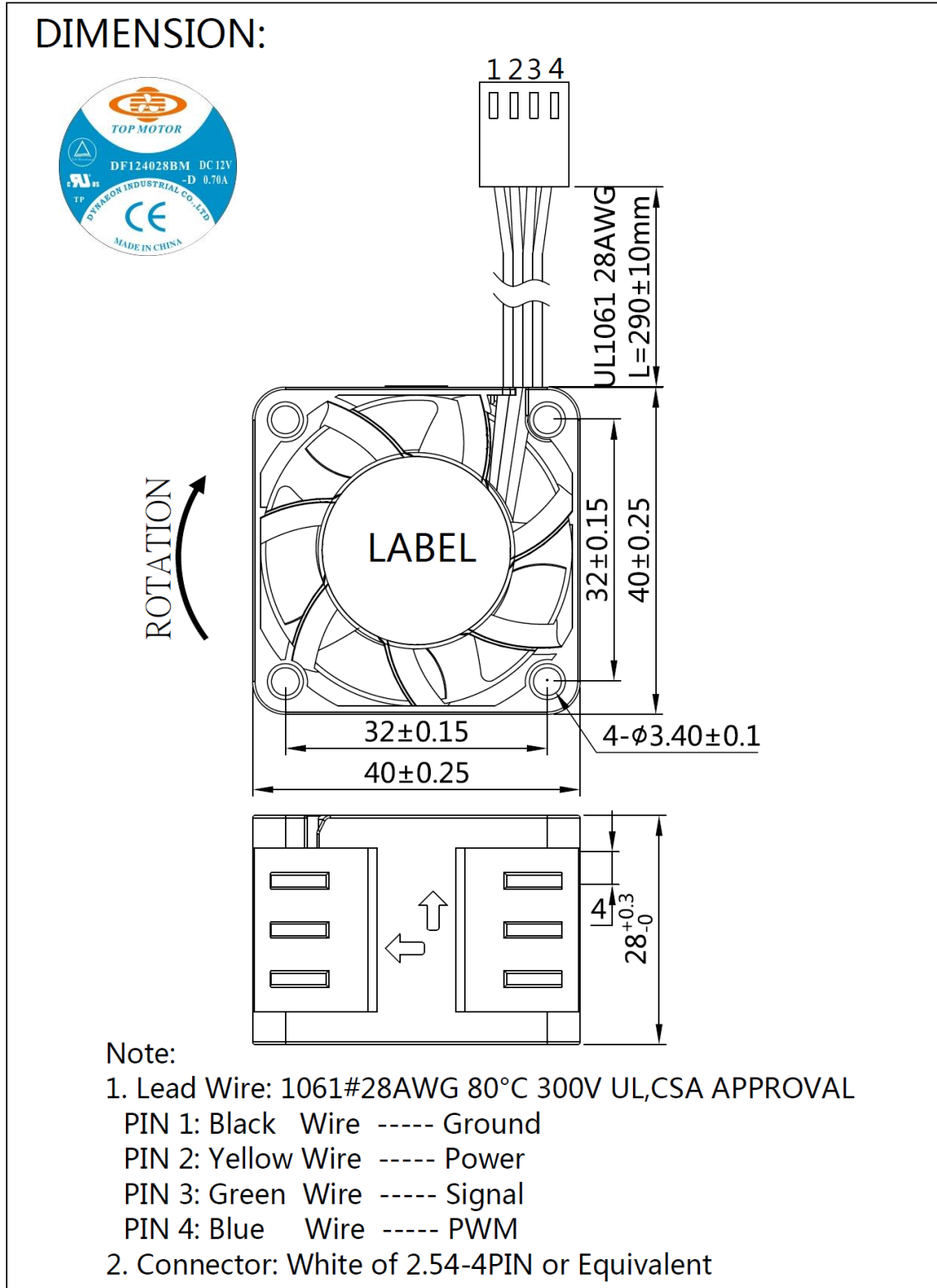



DYNATRON CORPORATION

TOP MOTOR TECHNOLOGY (HUIZHOU) CO, LTD

6.2. Frequency Generator Output

FREQUENCY GENERATOR O/P:

Frequency generator function is activated by an internal IC for customer's application.
Electrical schematic:

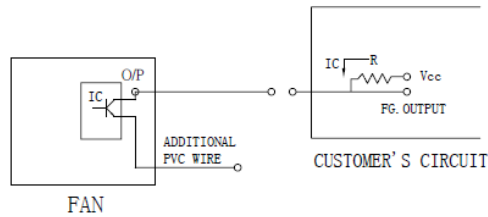

CUSTOMER'S CIRCUIT

V_{cc} = From +5 To +28 VDC (Generally using +12 or +24 VDC)

I_c = 5 mA max.

$R = V/I$ (Output "R" value calculation)

• SUPPLY A WAVEFORM:

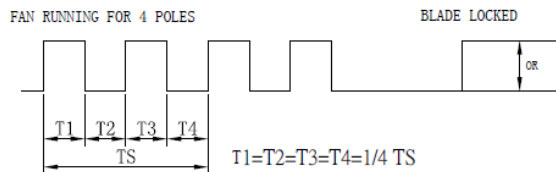

$N = R.P.M.$ (Rotation speed will be different for various models
L/M/H/HH/VH/SH)

$TS = 60/N$ (Sec)

* Voltage level after blade locked

• OUTPUT LEVEL:

High = V_{cc} 10%

Low = 0~0.5V

I_c = 5 mA max.

• APPLICATION:

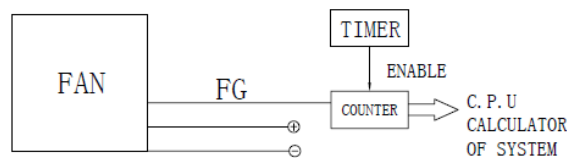

• FUNCTIONS:

- . By means of waveform & customer's design, schematic can reach alarm function, either in the form of buzzing or LED flashing.
Adjust rotation speed.
- . When power supply output voltage level decreases, it will result in the lowering of fan rotation speed. The irregular situation will be controlled by using FG. O/P through P/S circuit to increase the output voltage and result in a stable rotation speed.



DYNATRON CORPORATION

TOP MOTOR TECHNOLOGY (HUIZHOU) CO, LTD

6.3. TUV Certificate

Zertifikat		Certificate			
Zertifikat Nr. <i>Certificate No.</i> R 50064443		Blatt Page 0007			
Ihr Zeichen <i>Client Reference</i> 12046290/LC Tech	Unser Zeichen <i>Our Reference</i> ZTW1-CCO- 10013649 006	Ausstellungsdatum 07.05.2007	<i>Date of Issue (day/month/year)</i>		
Genehmigungsinhaber <i>License Holder</i> Dynaeon Industrial Co., Ltd. 8F, No. 35, 37, Lane 221 Gang Cian Rd. Neihu, Taipei 114 Taiwan, R.O.C.			Fertigungsstätte <i>Manufacturing Plant</i> Dynaeon Ind. Co., Ltd. Ta-Li Management Zone Ching-Hsi, Dongguan P.R. China		
Prüfzeichen <i>Test Mark</i>		Geprüft nach <i>Tested acc. to</i> EN 60950-1:2001+A11			
Zertifiziertes Produkt (Geräteidentifikation) <i>Certified Product (Product Identification)</i>			Lizenzentgelte - Einheit <i>License Fee - Unit</i>		
Ventilator (DC Fan)					
wie Blatt (as page) 01					
Ergänzung (Addition)					
Bezeichnung : DF(X1)(X2)(X3)(X4)(X5)ZZZZZ-(X6)					
(Type Designation)					
(X1) steht für (stands for): 05, 12, 24					
(X2) steht für (stands for): 12, 14, 15, 25, 40, 50, 60, 70, 77, 80, 92			1		
(X3) steht für (stands for): 10, 15, 20, 25, 28			1		
(X4) steht für (stands for): S, B, P, Q					
(X5) steht für (stands for): U, H, M, L, E					
(X6) steht für (stands for): A, B, C, D			1		
Z steht für (stands for): A-Z, 0-9 oder (or) freibleibend (blank)					
Nennspannung : DC 5V ((X1)= 05); DC 12V ((X1)= 12);					
(Rated Voltage) DC 24V ((X1)= 24)					
Nennstrom : siehe Anlage					
(Rated Current) (see appendix)					
ANLAGE (Appendix): 1					
Dem Zertifikat liegt unsere Prüf- und Zertifizierungsordnung zugrunde. Das Produkt entspricht den o.g. Anforderungen, die Herstellung wird überwacht. This certificate is based on our Testing and Certification Regulation. The product fulfills above mentioned requirements, the production is subject to surveillance.					
TÜV Rheinland Product Safety GmbH, Am Grauen Stein, D-51105 Köln Tel.: (+49/221)8 06 - 13 71 e-mail: cert-validity@de.tuv.com Fax: (+49/221)8 06 - 39 35 http://www.tuv.com/safety			 Zertifizierungsstelle		
			 Dipl.-Ing. F. Stöckel		



DYNATRON CORPORATION

TOP MOTOR TECHNOLOGY (HUIZHOU) CO, LTD

6.4. UL Certificate

15-10-29

GPWW2.E157868 - Fans, Electric - Component



ONLINE CERTIFICATIONS DIRECTORY

GPWW2.E157868 Fans, Electric - Component

[Page Bottom](#)

Fans, Electric - Component

[See General Information for Fans, Electric - Component](#)

DYNAEON INDUSTRIAL CO LTD
8TH FL 35 LANE 221 GANGCIAN RD
NEIHU DIST
TAIPEI, 114 TAIWAN

E157868

DC fans, Models D(F)1206(Z)(Y1)(X1), D(F)1207(Z)(Y1)(X1), where (F) may be F or C, (Z) may be SH, BH, BA, SM, BM, BB, SL, BL, BC, SD, BE, BF, SG, BI, BJ, SK, BN, BO, SP, BQ, BR, SS, BT, BU, SV, BW, BX, SY, BY or BZ, (Y1) may be "-" or 0 through 9 or A through Z, (X1) may be 0 through 9 or A through Z.

Models DF248015(S)(X)(Y)(Z)(W), DF488015(S)(X)(Y)(Z)(W), where (S) may be S, B or P, (X) may be U, H, M or L, (Y) and (Z) may be any alphanumeric character, blank, "-" or any symbol, (W) may be seven any alphanumeric character, blank, "-" or any symbol.

Models DF121225(A)(B)(C), DF121225(A)E(C), DF241225(A)(B)(C), DF128015(A)U(C), DF128015(A)(B)(C), DF128025(A)U(C), DF128025(A)(B)(C), DF128025(A)E(C), DF248025(A)U(C), DF248025(A)(B)(C), DF129225(A)(B)(C), DF129225(A)E(C), DF249225(A)U(C), DF249225(A)(B)(C), DF126010(A)(B)(C), DF246025(A)U(C), DF246025(A)(B)(C), DF126025(A)U(C), DF126025(A)(B)(C), DF126025(A)E(C), DB126015BU(C), DB126015B(B)(C), DF123010(A)(B)(C), DF053010(A)(B)(C), DF127015(A)U(C), DF127015(A)(B)(C), DF245010(A)(B)(C), where (A) may be S, B, P or Q, (B) may be H, M or L, (C) may be xxxxxxxx, where x may be A through Z, 0 through 9, "-" or blank.

Models DF122510(X)(Y2)(Z)-(M), DF124020(X)(Y2)(Z)-(M), DF244020(X)(Y1)(Z)-(M), DF126025(X)(Y3)(Z)-(M), DF246025(X)(Y3)(Z)-(M), DF121225(X)(Y1)(Z)-(M), DF124028(X)(Y3)(Z)-(M), where (X) may be S, B, P, Q, (Y1) may be H, M or L, (Y2) may be U, H, M or L, (Y3) may be U, H, M, L or E, (Z) is alphanumeric combination of five digits and/or alphabets, may be A through Z, 0 through 9 or blank, (M) may be A or B.

Models DF054010(X)(Y2)(Z1)(Z2)-A, DF054010(X)L(Z1)(Z2)-B, DF124010(X)(Y2)(Z1)(Z2)-A, DF124010(X)L(Z1)(Z2)-B, DF244010(X)(Y2)(Z1)(Z2)-A, DF125015(X)(Y1)(Z1)(Z2)-A, DF125020(X)(Y3)(Z1)(Z2)-A, DF126015(X)(Y1)(Z1)(Z2)-A, DF246015(X)M(Z1)(Z2)-A, DF246015(X)L(Z1)(Z2)-A, DF128020(X)(Y1)(Z1)(Z2)-A, DF128020(X)L(Z1)(Z2)-B, DB127015(X)(Y2)(Z)-A series, where (X) may be S, B, P, Q, (Y1) may be H, M or L, (Y2) may be U, H, M or L, (Y3) may be H, M, L or E, (Z1) may be blank or 3, (Z2) is alphanumeric combination of four digits and/or alphabets, may be A through Z, 0 through 9 or blank, (Z) is alphanumeric combination of five digits and/or alphabets, may be A through Z, 0 through 9 or blank.

Models DF125010(X)(Y)(Z)-A, DF126020(X)(Y)(Z)-A, DF246020(X)(Y)(Z)-A, DF121525(X)(Y1)(Z)-A, DF121525(X)(Y2)(Z)-B series, where (X) may be S, B, P or Q, (Y) may be H, M or L, (Y1) may be U, H or M, (Y2) may be L or E, (Z) is alphanumeric combination of five digits and/or alphabets, may be A through Z, 0 through 9 or blank.

Models DF128025(X)(a)(Y)-A, DF121225(X)(b)(Y)-C, DF121225(X)E(Y)-C, DF127720(X)(a)(Y)-A, DF121425(X)(c)(Y)-A, DF126010(X)E(Y)-A series, where (X) may be S, B, P, Q, (a) may be H, M, L or E, (b) may be M or L, (c) may be U, H, M, L or E, (Y) is alphanumeric combination of five digits and/or alphabets, may be A through Z, 0 through 9 or blank.

Models DF054010(X)(Y1)(Z1)(Z2)-C, DF124010(X)(Y2)(Z1)(Z2)-C, DF244010(X)(Y2)(Z1)(Z2)-C, DF124020BU(Z1)(Z2)-C, DF124020(X)(Y1)(Z1)(Z2)-C, DF124028BU(Z1)(Z2)-C, DF124028(X)(Y1)(Z1)(Z2)-C, DF126025BU(Z1)(Z2)-C, DF126025(X)(Y1)(Z1)(Z2)-C, DF127015BU(Z1)(Z2)-A, DF127015(X)(Y1)(Z1)(Z2)-A, DF128025BU(Z1)(Z2)-B, DF128025(X)(Y1)(Z1)(Z2)-B, DF129225BU(Z1)(Z2)-A, DF129225(X)(Y1)(Z1)(Z2)-A, DF121225BU(Z1)(Z2)-D, DF121225(X)(Y1)(Z1)(Z2)-D, DF121425(X)(Y1)(Z1)(Z2)-B, DB127015BU(Z1)(Z2)-B, DB127015(X)(Y1)(Z1)(Z2)-B, DB058015(X)(Y3)(Z1)(Z2)-A, where (X) may be S, B, P or Q, where (Y1) may be H, M, L or E, where (Y2) may be U, H, M, L or E, where (Y3) may be M or L, where (Z1) may be blank or 3, where (Z2) may be alphanumeric combination of four digits and/or alphabets, may be A through Z, 0 through 9 or blank.

Models DB128015(X)(Y1)-(Z)-A, DF128038(X)(Y1)-(Z)-A, DB121225(X)(Y2)-(Z)-A, DF054010(X)(Y2)-(Z)-D, DF124010(X)(Y3)-(Z)-D, DF244010(X)(Y4)-(Z)-D, DF125010(X)(Y2)-(Z)-B, DF126010(X)(Y5)-(Z)-B series, where (X) may be S, B, P, Q, (Y1) may be U, H, M, L or E, (Y2) may be H, M or L, (Y3) may be U, M, L or E, (Y4) may be U, H, M or L, (Y5) may be H, M, L or E, (Z) is alphanumeric combination of five digits and/or alphabets, may be A through Z, 0 through 9 or blank.

Series 7515: Models DB127515(X)U-ZZZZ-(A), DB127515(X)H-ZZZZ-(A), DB127515(X)M-ZZZZ-(A), DB127515(X)L-ZZZZ-(A).

Series 9225: Models DF129225(X)U-ZZZZ-(A), DF129225(X)H-ZZZZ-(A), DF129225(X)M-ZZZZ-(A), DF129225(X)L-ZZZZ-(A).

database.ul.com/cgi-bin/XYV/template/LISEXT/1FRAME/showpage.html?name=GPWW2.E157868&ccnshorttitle=Fans,+Electric+--+Component&objid=107... 1/2



DYNATRON CORPORATION

TOP MOTOR TECHNOLOGY (HUIZHOU) CO, LTD

15-10-29

GPWW2.E157868 - Fans, Electric - Component

Models DB128015(X)(Y)-(Z)-B and DF126028(X)(W)-(Z)-A series, where (X) may be S, B, P or Q; (Y) may be U, H, M or L; (W) may be U, H, M, L or E; (Z) stands for five variables, each may be A through Z, 0 through 9 or blank.

Model DF124028(X)(Y)-(Z)-D, where (X) may be S, B, P or Q; (Y) may be U, H, M, L, E; (Z) is alphanumeric combination of five digits and/or alphabets, may be A through Z, 0 through 9 or blank.

Electric fans, Models DC0504, -1204, -1205, -1206, DF1204, -1208, -2408, -0504, -0505, -1205, -2406 followed by "S" or "B", followed by two alphanumeric characters.

Low voltage fans, Models DB1206, DF1209, -1212, -2409, DH1204 followed by B or S, followed by two alphanumeric characters.

Models DF124056(X)(Y)-(Z)-(Z1), DF126038(X)(Y)-(Z)-(Z1), DB129015(X)(Y)-(Z)-(Z1) and DB129215(X)(Y)-(Z)-(Z1); where (X) may be S, B, P, Q; (Y) may be U, H, M, L, E; (Z) may be A through Z, 0 through 9 or blank; (Z1) may be A, B, C or D.



Marking: Company name or trademark  and model designation.

Last Updated on 2015-10-06

[Questions?](#)

[Print this page](#)

[Terms of Use](#)

[Page Top](#)

◆ 2015 UL LLC

The appearance of a company's name or product in this database does not in itself assure that products so identified have been manufactured under UL's Follow-Up Service. Only those products bearing the UL Mark should be considered to be Certified and covered under UL's Follow-Up Service. Always look for the Mark on the product.

UL permits the reproduction of the material contained in the Online Certification Directory subject to the following conditions: 1. The Guide Information, Assemblies, Constructions, Designs, Systems, and/or Certifications (files) must be presented in their entirety and in a non-misleading manner, without any manipulation of the data (or drawings). 2. The statement "Reprinted from the Online Certifications Directory with permission from UL" must appear adjacent to the extracted material. In addition, the reprinted material must include a copyright notice in the following format: "© 2015 UL LLC".



DYNATRON CORPORATION

TOP MOTOR TECHNOLOGY (HUIZHOU) CO, LTD

15-10-29

GPWV8.E157868 - Fans, Electric Certified for Canada - Component



ONLINE CERTIFICATIONS DIRECTORY

GPWV8.E157868 Fans, Electric Certified for Canada - Component

[Page Bottom](#)

Fans, Electric Certified for Canada - Component

[See General Information for Fans, Electric Certified for Canada - Component](#)

DYNAEON INDUSTRIAL CO LTD
8TH FL 35 LANE 221 GANGCIAN RD
NEIHU DIST
TAIPEI, 114 TAIWAN

E157868

DC fans, Models D(F)1206(Z)(Y1)(X1), D(F)1207(Z)(Y1)(X1), where (F) may be F or C, (Z) may be SH, BH, BA, SM, BM, BB, SL, BL, BC, SD, BE, BF, SG, BI, BJ, SK, BN, BO, SP, BQ, BR, SS, BT, BU, SV, BW, BX, SY, BY or BZ, (Y1) may be "-" through 9 or A through Z, (X1) may be 0 through 9 or A through Z.

Models DF248015(S)(X)(Y)(Z)(W), DF488015(S)(X)(Y)(Z)(W), where (S) may be S, B or P, (X) may be U, H, M or L, (Y) and (Z) may be any alphanumeric character, blank, "-" or any symbol, (W) may be seven any alphanumeric character, blank, "-" or any symbol.

Models DF121225(A)(B)(C), DF121225(A)E(C), DF241225(A)(B)(C), DF128015(A)U(C), DF128015(A)(B)(C), DF128025(A)U(C), DF128025(A)(B)(C), DF128025(A)E(C), DF248025(A)U(C), DF248025(A)(B)(C), DF129225(A)(B)(C), DF129225(A)E(C), DF249225(A)U(C), DF249225(A)(B)(C), DF126010(A)(B)(C), DF246025(A)U(C), DF246025(A)(B)(C), DF126025(A)U(C), DF126025(A)(B)(C), DF126025(A)E(C), DB126015BU(C), DB126015B(B)(C), DF123010(A)(B)(C), DF053010(A)(B)(C), DF127015(A)U(C), DF127015(A)(B)(C), DF245010(A)(B)(C), where (A) may be S, B, P or Q, (B) may be H, M or L, (C) may be xxxxxxxx, where x may be A through Z, 0 through 9, "-" or blank.

Models DF122510(X)(Y2)(Z)-(M), DF124020(X)(Y2)(Z)-(M), DF244020(X)(Y1)(Z)-(M), DF126025(X)(Y3)(Z)-(M), DF246025(X)(Y3)(Z)-(M), DF121225(X)(Y1)(Z)-(M), DF124028(X)(Y3)(Z)-(M), where (X) may be S, B, P, Q, (Y1) may be H, M or L, (Y2) may be U, H, M or L, (Y3) may be U, H, M, L or E, (Z) is alphanumeric combination of five digits and/or alphabets, may be A through Z, 0 through 9 or blank, (M) may be A or B.

Models DF054010(X)(Y2)(Z1)(Z2)-A, DF054010(X)L(Z1)(Z2)-B, DF124010(X)(Y2)(Z1)(Z2)-A, DF124010(X)L(Z1)(Z2)-B, DF244010(X)(Y2)(Z1)(Z2)-A, DF125015(X)(Y1)(Z1)(Z2)-A, DF125020(X)(Y3)(Z1)(Z2)-A, DF126015(X)(Y1)(Z1)(Z2)-A, DF246015(X)M(Z1)(Z2)-A, DF246015(X)L(Z1)(Z2)-A, DF128020(X)(Y1)(Z1)(Z2)-A, DF128020(X)L(Z1)(Z2)-B, DB127015(X)(Y2)(Z)-A series, where (X) may be S, B, P, Q, (Y1) may be H, M or L, (Y2) may be U, H, M or L, (Y3) may be H, M, L or E, (Z1) may be blank or 3, (Z2) is alphanumeric combination of four digits and/or alphabets, may be A through Z, 0 through 9 or blank, (Z) is alphanumeric combination of five digits and/or alphabets, may be A through Z, 0 through 9 or blank.

Models DF125010(X)(Y)(Z)-A, DF126020(X)(Y)(Z)-A, DF246020(X)(Y)(Z)-A, DF121525(X)(Y1)(Z)-A, DF121525(X)(Y2)(Z)-B series, where (X) may be S, B, P or Q, (Y) may be H, M or L, (Y1) may be U, H or M, (Y2) may be L or E, (Z) is alphanumeric combination of five digits and/or alphabets, may be A through Z, 0 through 9 or blank.

Models DF128025(X)(a)(Y)-A, DF121225(X)(b)(Y)-C, DF121225(X)E(Y)-C, DF127720(X)(a)(Y)-A, DF121425(X)(c)(Y)-A, DF126010(X)E(Y)-A series, where (X) may be S, B, P, Q, (a) may be H, M, L or E, (b) may be M or L, (c) may be U, H, M, L or E, (Y) is alphanumeric combination of five digits and/or alphabets, may be A through Z, 0 through 9 or blank.

Models DF054010(X)(Y1)(Z1)(Z2)-C, DF124010(X)(Y2)(Z1)(Z2)-C, DF244010(X)(Y2)(Z1)(Z2)-C, DF124020BU(Z1)(Z2)-C, DF124020(X)(Y1)(Z1)(Z2)-C, DF124028BU(Z1)(Z2)-C, DF124028(X)(Y1)(Z1)(Z2)-C, DF126025BU(Z1)(Z2)-C, DF126025(X)(Y1)(Z1)(Z2)-C, DF127015BU(Z1)(Z2)-A, DF127015(X)(Y1)(Z1)(Z2)-A, DF128025BU(Z1)(Z2)-B, DF128025(X)(Y1)(Z1)(Z2)-B, DF129225BU(Z1)(Z2)-A, DF129225(X)(Y1)(Z1)(Z2)-A, DF121225BU(Z1)(Z2)-D, DF121225(X)(Y1)(Z1)(Z2)-D, DF121425(X)(Y1)(Z1)(Z2)-B, DB127015BU(Z1)(Z2)-B, DB127015(X)(Y1)(Z1)(Z2)-B, DB058015(X)(Y3)(Z1)(Z2)-A, where (X) may be S, B, P or Q, where (Y1) may be H, M, L or E, where (Y2) may be U, H, M, L or E, where (Y3) may be M or L, where (Z1) may be blank or 3, where (Z2) may be is alphanumeric combination of four digits and/or alphabets, may be A through Z, 0 through 9 or blank.

Models DB128015(X)(Y1)(Z)-A, DF128038(X)(Y1)(Z)-A, DB121225(X)(Y2)(Z)-A, DF054010(X)(Y2)(Z)-D, DF124010(X)(Y3)(Z)-D, DF244010(X)(Y4)(Z)-D, DF125010(X)(Y2)(Z)-B, DF126010(X)(Y5)(Z)-B series, where (X) may be S, B, P, Q, (Y1) may be U, H, M, L or E, (Y2) may be H, M or L, (Y3) may be U, M, L or E, (Y4) may be U, H, M or L, (Y5) may be H, M, L or E, (Z) is alphanumeric combination of five digits and/or alphabets, may be A through Z, 0 through 9 or blank.

Series 7515: Models DB127515(X)U-ZZZZZ-(A), DB127515(X)H-ZZZZZ-(A), DB127515(X)M-ZZZZZ-(A), DB127515(X)L-ZZZZZ-(A).

Series 9225: Models DF129225(X)U-ZZZZZ-(A), DF129225(X)H-ZZZZZ-(A), DF129225(X)M-ZZZZZ-(A), DF129225(X)L-ZZZZZ-(A).

database.ul.com/cgi-bin/XYV/template/LISEXT/1FRAME/showpage.html?name=GPWV8.E157868&ccnshorttitle=Fans,+Electric+Certified+for+Canada+... 1/2



DYNATRON CORPORATION

TOP MOTOR TECHNOLOGY (HUIZHOU) CO, LTD

15-10-29

GPWW8.E157868 - Fans, Electric Certified for Canada - Component

Models DB128015(X)(Y)-(Z)-B and DF126028(X)(W)-(Z)-A series, where (X) may be S, B, P or Q; (Y) may be U, H, M or L; (W) may be U, H, M, L or E; (Z) stands for five variables, each may be A through Z, 0 through 9 or blank.

Model DF124028(X)(Y)-(Z)-D, where (X) may be S, B, P or Q; (Y) may be U, H, M, L, E; (Z) is alphanumeric combination of five digits and/or alphabets, may be A through Z, 0 through 9 or blank.

Electric fans, Models DC0504, -1204, -1205, -1206, DF0504, -0505, -1204, -1205, -1208, -2406, -2408 followed by "S" or "B", followed by two alphanumeric characters.

Low voltage fans, Models DB1206, DF1209, -1212, -2409, DH1204 followed by B or S, followed by two alphanumeric characters.

Models DF124056(X)(Y)-(Z)-(Z1), DF126038(X)(Y)-(Z)-(Z1), DB129015(X)(Y)-(Z)-(Z1) and DB129215(X)(Y)-(Z)-(Z1); where (X) may be S, B, P, Q; (Y) may be U, H, M, L, E; (Z) may be a through Z, 0 through 9 or blank; (Z1) may be A, B, C or D.



Marking: Company name or trademark TOP MOTOR, model designation and Recognized Component Mark for Canada,



Last Updated on 2015-10-06

[Questions?](#)

[Print this page](#)

[Terms of Use](#)

[Page Top](#)

◆ 2015 UL LLC

The appearance of a company's name or product in this database does not in itself assure that products so identified have been manufactured under UL's Follow-Up Service. Only those products bearing the UL Mark should be considered to be Certified and covered under UL's Follow-Up Service. Always look for the Mark on the product.

UL permits the reproduction of the material contained in the Online Certification Directory subject to the following conditions: 1. The Guide Information, Assemblies, Constructions, Designs, Systems, and/or Certifications (files) must be presented in their entirety and in a non-misleading manner, without any manipulation of the data (or drawings). 2. The statement "Reprinted from the Online Certifications Directory with permission from UL" must appear adjacent to the extracted material. In addition, the reprinted material must include a copyright notice in the following format: "© 2015 UL LLC".



DYNATRON CORPORATION

TOP MOTOR TECHNOLOGY (HUIZHOU) CO, LTD

6.5. Electrical specifications for PWM production

USA Dynatron Corp.

Electrical Specifications for PWM production

Voltage

Fan operating voltage shall be within the range 12V \pm 1.2V.

Current

Peak fan current draw during start-up operation (with 13.2V applied, with fan operating in the free stream condition) shall not exceed 2.0 A.

Fan current spike during start-up operation (with 13.2V applied with fan operating in the free stream condition) shall be allowed to exceed 1.0 A for a duration of no greater than 1.0 sec.

Tachometer Output Signal

Fan shall provide tachometer output signal with the following characteristics:

- * Two pulses per revolution
- * Open-collector or open-drain type output
- * Motherboard will have a pull up to 12V, maximum 13.2V

PWM Control Input Signal

The following requirements are measured at the PWM(control) pin of the fan cable

connector: PWM Frequency: Target frequency 25kHz,

acceptable operational range 21 kHz to 28 KHz

Maximum voltage for logic low: VIL=0.8V

Absolute maximum current sourced: I_{max}=5mA (short circuit current)

Absolute maximum voltage level: V_{max}=5.25V (open circuit voltage)

Fan Speed Control

1.1 Maximum Fan Speed Requirements

The maximum fan speed shall be specified for the fan model by the vendor and correspond to 100% duty cycle PWM signal input.

1.2 Minimum Fan Speed Requirements

The vendor shall specify the minimum RPM and the corresponding PWM duty cycle. This specified minimum RPM shall be 30% of maximum RPM or less. The fan shall be able to start and run at this RPM. To allow a lower specified minimum RPM, it is acceptable to provide a higher PWM duty cycle to the fan motor for a short period of time for startup conditions. This pulse should not exceed 30% maximum RPM and should last no longer than 2 seconds.



DYNATRON CORPORATION

TOP MOTOR TECHNOLOGY (HUIZHOU) CO, LTD

USA Dynatron Corp.

1.3 Fan Speed Response PWM Control Input Signal

The PWM input shall be delivered to the fan through the control signal on Pin4. Fan speed response to this signal shall be a continuous and monotonic of the duty cycle of the signal, from 100% to the minimum specified RPM. The fan RPM (as a percentage of maximum RPM) should match the PWM duty cycle within $\pm 10\%$. If no control signal is present the fan shall operate at maximum RPM.

Figure 1 Fan speed Response to PWM Control input Signal

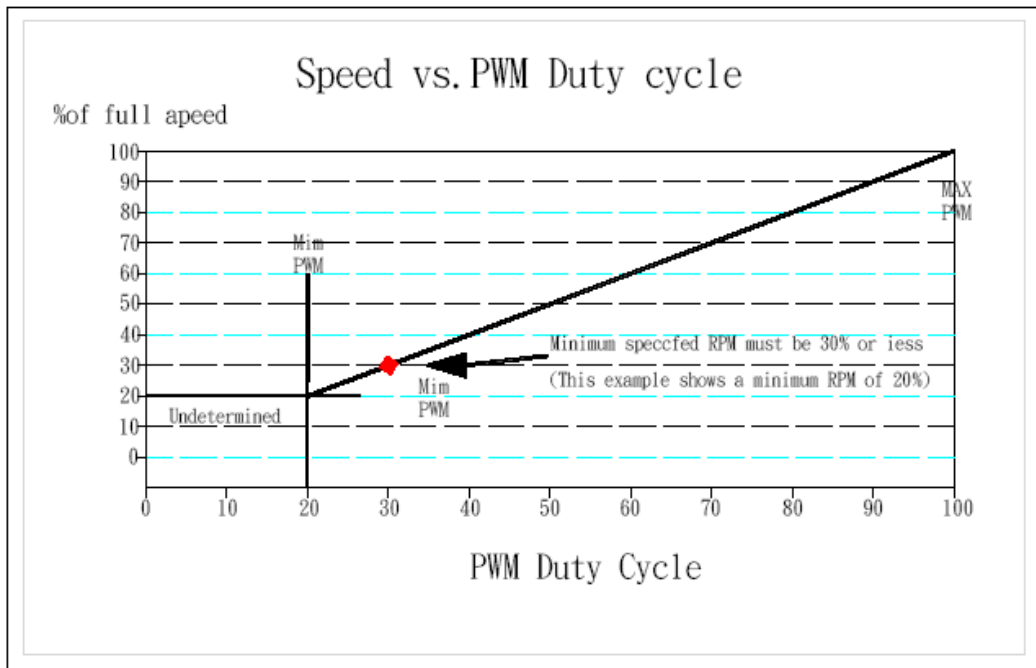

1.4 Operation Below Minimum RPM

For all duty cycles less than the minimum duty cycle, the RPM shall not be greater than the minimum RPM. The following graphs and definitions show three recommended solutions to handle PWM duty cycles that are less than the minimum operational PRM, as a percentage of maximum.

Reference resource by Intel's 4-wire PWM Fan controlled specification.



DYNATRON CORPORATION

TOP MOTOR TECHNOLOGY (HUIZHOU) CO, LTD

Specification for Approval

Customer:		
Model Number:	1U watercooler pump	
Part Number:		
Issued Date:	Wednesday, August 31, 2016	
Version:	A	
Customer Approval		
Approval:	Check:	
<p>Corporate Headquarters Dynatron Corporation 33200 Western Avenue Union City, CA 94587 U.S.A. Tel: 510-498-8888 Fax: 510-498-8488</p>	<p><i>Taipei Office</i> (Taiwan, R.O.C.) 8F, No. 35, Lane:221 Gang Cian. Road, Taipei, Taiwan, R.O.C. Tel: 886-2-27995799 (Rep.) Fax: 886-2-2799-9577</p>	<p>Manufactory TOP MOTOR TECHNOLOGY(HUI ZHOU)CO,LTD Baishi Village, QiuchangTown, Huiyang Dist, HuizhouCity, Guangdong Province, P.R.China Tel: 86-752-822-8000 (Rep.) Fax: 86-752-822-8999</p>
Approval:	Check:	Handler:
Simon Wang	-	Hui mei



DYNATRON CORPORATION

TOP MOTOR TECHNOLOGY (HUIZHOU) CO, LTD

	CONTENTS	Page
1.	SCOPE	3
2.	ELECTRICAL CHARACTERISTICS	3
3.	MECHANICAL CHARACTERISTICS	4
4.	ENVIRONMENTAL	4
5.	PROTECTION	5
6.	ATTACHMENTS	5
	6.1. Product Dimension	6



DYNATRON CORPORATION

TOP MOTOR TECHNOLOGY (HUIZHOU) CO, LTD

1. SCOPE

This specification defines the electrical and mechanical characteristics of the AC / DC Brush Less (Sleeve Bearing / 2-Balls Bearing) axial flow fan, which is carefully designed and manufactured for your special needs by Dynatron Corporation.

2. ELECTRICAL CHARACTERISTICS

Items		Description
1.	Rated Voltage	DC 12 V
2.	Start Voltage	DC 9 V
3.	Operating Voltage	10.2V~13.8V
4.	Flow Rate (minimal value)	1.7 LPM
5.	Input Current	0.25 A (Max)
6.	Input Power	3.0 W
7.	Speed	4000RPM \pm 10%
8.	Insulation Resistance – Between Frame and Terminal	10 M ohm at DC 500 V
9.	Dielectric Strength – Between Frame and Terminal	5 mA (Max.) @ AC 500 V 60 Hz 1 min.
10.	Life – Continuous operating under normal temperature (25 °C or 77 °F)	35,000 hours
11.	Rotation	Anticlockwise Air Discharged
12.	Autorestart Time	3-5sec
13.	Lead Wires	UL 2468, awg 26 or Equivalent “-”: Black; “+”: Black; “s”: Black.
14.	Acoustical Noise	30.00dBA



DYNATRON CORPORATION

TOP MOTOR TECHNOLOGY (HUIZHOU) CO, LTD

3. MECHANICAL CHARACTERISTICS

Items		Description
1.	Dimension	Display as Drawing
2.	Frame	PPS UL94V-0 (Black GP)
3.	Impeller	PPS UL94V-0 (Black GP)
4.	Bearing System	Ceramic Bearing
5.	Weight	56±5grams

4. ENVIRONMENTAL

Items		Description
1.	Operating Temperature	- 10 °C ~ + 65 °C (65 %RH)
2.	Storage Temperature	- 30 °C ~ + 70 °C (65 %RH)
3.	Vibration Test	Displacement Amplitude: 0.75mm(Equivalent 10G) Frequency Range: 10Hz<->55Hz/30SEC. Linear Scanning 120 Cycle Endurance Timer Per Axis: 30Min. Orientation:X,Y,Z.
4.	Drop Test	Motor withstands one free body drop from 30 cm in high onto 10 mm thickness of wooden board for each of the three faces in minimum packing condition.
5.	Acoustic Noise	30.00dBA – Curve (30.50Max) Measuring Condition – Under rated voltage in semi-anechoic chamber equipment sound level meter. (Figure A.)

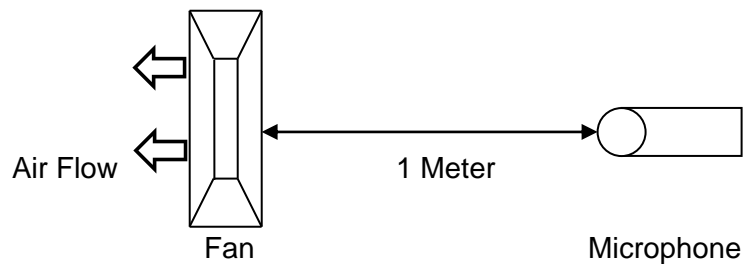

Figure A – Noise Level is measure at rated voltage in anechoic chamber in free air as above.



DYNATRON CORPORATION

TOP MOTOR TECHNOLOGY (HUIZHOU) CO, LTD

DIMENSION:

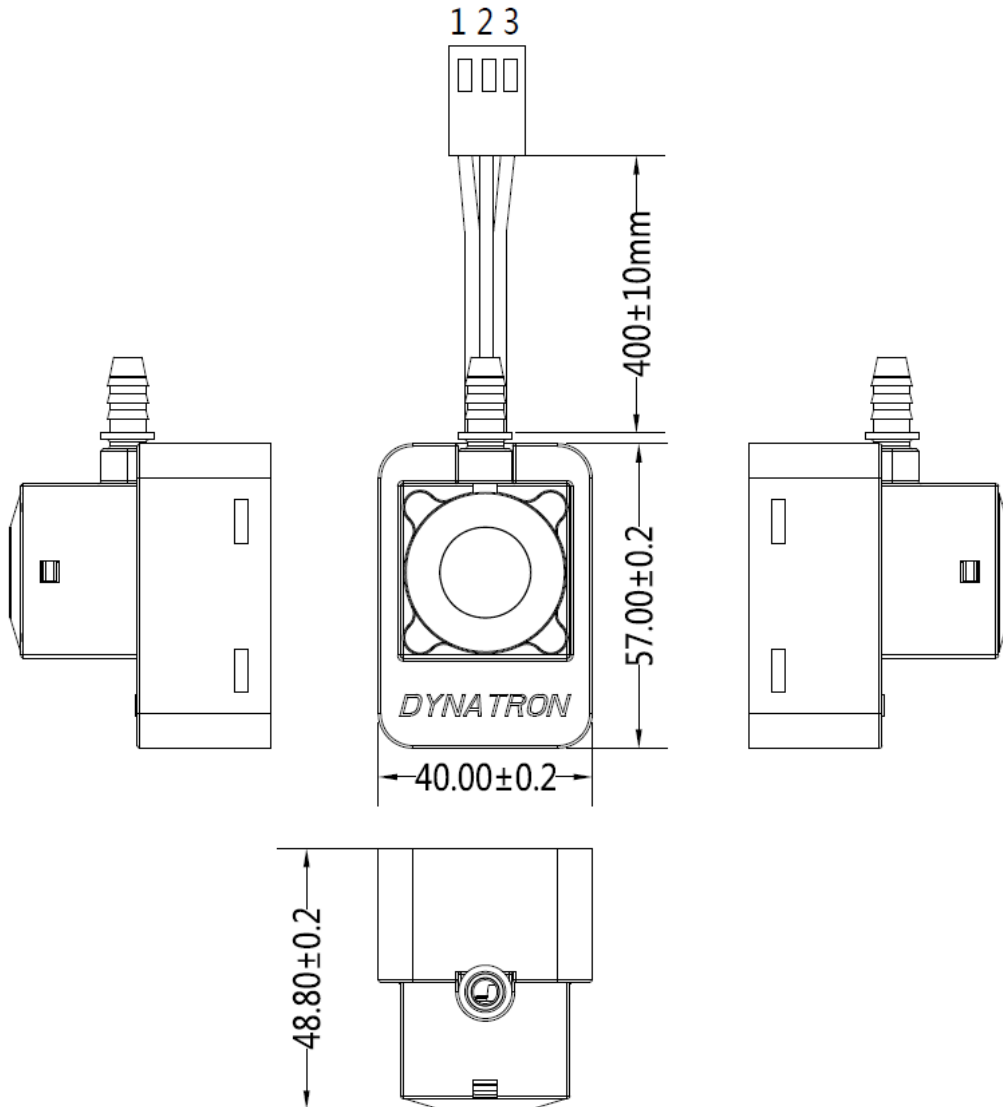

1.Note:

1.Leed Wire:UL2468 #26AWG

PIN 1: Black Wire ----Ground

PIN 2: Black Wire ----Power

PIN 3: Black Wire ----Signal

2.Connector:2510-3P



Certificate of Environment Protection

環保證明書

Document Number: RH-L18-R0

Customer: 客戶名稱:	Company: _____ Address: _____ Phone Number: ____ - ____ - _____
Issue Date:	11/22/2019
Product Model Number:	L 18
<p> Dynatron Corporation hereby declares and certifies that all components manufactured are RoHS compliant according to the definitions and restrictions given by the European Union's Restriction (Directive 2002/95/EC) (Decision2011/65/EU)RoHS 2, on the restriction of the use of certain Hazardous Substances in the electrical and electronic equipment. Also, compliance to the most recent list of substances on the REACH candidate list. </p> <p> Number of substances on the Candidate List: 168 (last updated: 17/12/2015) </p> <p> No exemptions are claimed in order for the part to be compliant with the RoHS directive. </p> <p> Dynatron Corporation / 政久興業股份有限公司證明所有產品,零件 (包括附屬品, 包裝類) 之環境管理物質完全符合 RoHS, WEEE, 及該環保標準之規定, 並承諾遵 循以上之證明. </p> <div style="text-align: right; margin-top: 20px;"> Dynatron Corporation. 33200 Western Ave, Union City, CA 94587 www.Dynatron-corp.com </div> <p style="margin-top: 20px;"> Title (職務): _____ ASSISTANT-MANAGER _____ </p> <p style="margin-top: 10px;"> Signature (簽字): _____  _____ </p> <p style="text-align: right; margin-top: 5px;"> Date: 11 / 22 / 2019 </p>	

