

N10

1U Passive Cooler

PRODUCT SPECIFICATIONS

Table of Contents

| | |
|-----------------------------------|---|
| 1. PRODUCT DESCRIPTION | 2 |
| 2. THERMAL PERFORMANCE CURVE..... | 2 |
| 3. EP DRAWING | 3 |
| 4. DM DRAWING | 4 |
| 5. ROHS CERTIFICATE | 5 |

Model Number : N10

- Intel® Ice Lake and Cooper Lake Server Processor Socket FCLGA4189-4 / -5 (Socket P4 / P5 or P+)
- Passive Cooler for 1U Server or up

Overall Specification

| | |
|-----------------|---|
| Dimension | 113 x 78 x 27 mm |
| Weight | 420 g |
| Material | Copper1100 for both Vapor Chamber Base and Fin Stack |
| Mounting Sets | Intel standard Anti-Tilt Rotating heat sink captive mounting sets |
| Package Carrier | PHM Package Carrier is included |
| Thermal Grease | Shin-Etsu 7762 pre-printed |
| TDP | Support CPU Power up to 205 Watts Heat Dissipation |

Performance Chart: Passive Cooler N10 Thermal Resistance VS. Airflow

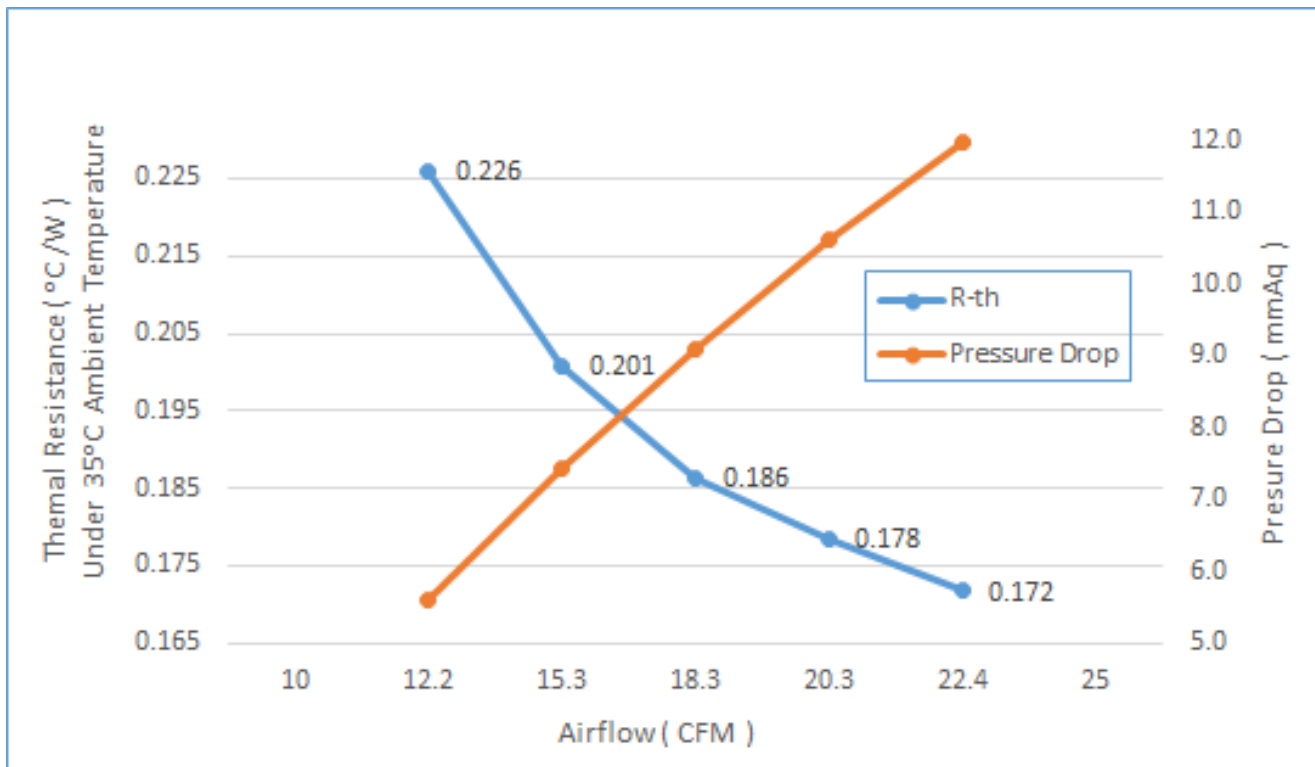

(Tested by Intel Ice Lake TTV)

CONFIDENTIAL DOCUMENT

THIS DRAWING CONTAINS INFORMATION PROPRIETARY TO DYNATRON CORPORATION AND DYNAEON INDUSTRIAL CO., LTD. ANY REPRODUCTION, DISCLOSURE, OR USE OF THIS DRAWING IS EXPRESSLY PROHIBITED EXCEPT AS DYNATRON CORPORATION AND DYNAEON INDUSTRIAL CO., LTD. MAY OTHERWISE AGREE TO IN WRITING.

| REV# | DESCRIPTION | CHECKER | DATE |
|------|-----------------|---------|------------|
| 0.0 | INITIAL RELEASE | LANG | 09/21/2020 |

ASSEMBLY PARTS

WHOLE SET OF HEATSINK

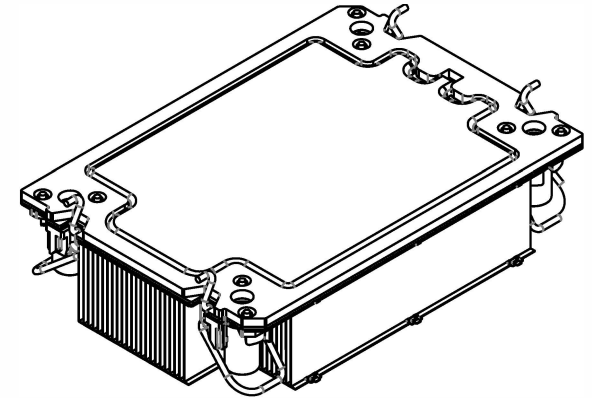
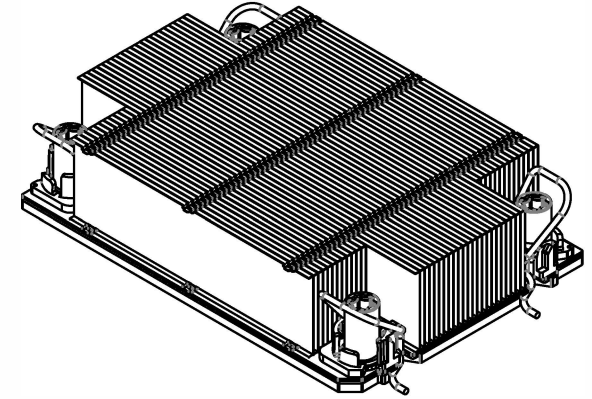
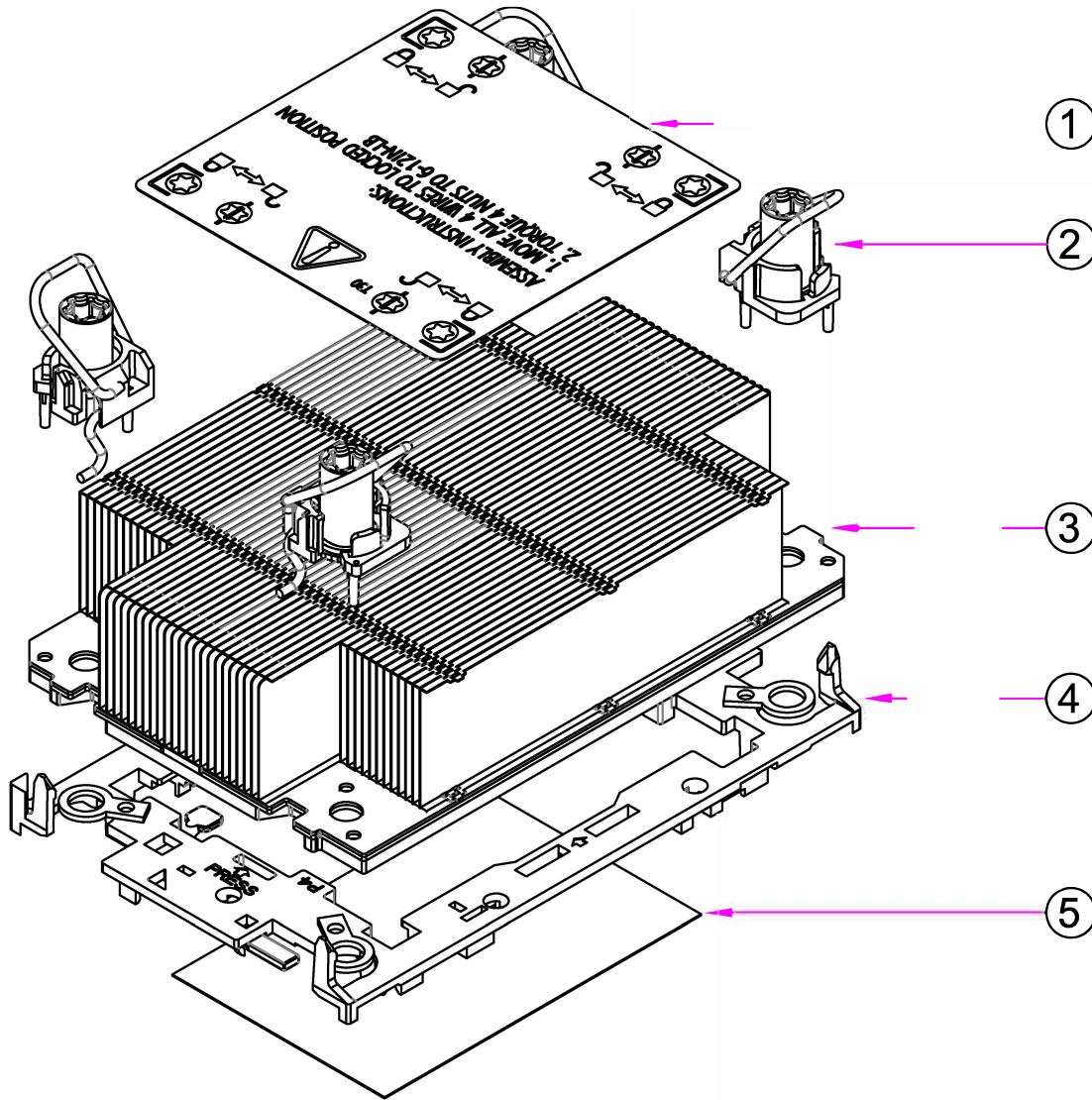

| 5 | THERMAL GREASE, PRE-PRINTED | SHIN-ETSU 7762 | 1 |
|-------|--------------------------------------|--|------|
| 4 | INTEL PACKAGE CARRIER, P4 | PLASTIC | 1 |
| 3 | HEATSINK, with STACKED FINS | COPPER FIN STACK COPPER VAPOR CHAMBER BASE STEEL RETENTION | 1 |
| 2 | ANTI-TILT ROTATING WIRE ASSEMBLY SET | PLASTIC NUT AND CAPTIVATION STEEL ROTATING WIRE | 4 |
| 1 | MOUNTING INSTRUCTION LABEL | PLASTIC | 1 |
| ITEM# | DESCRIPTION | MATERIAL | QTY. |

NOTES:

1. THE FIGURE IS FOR REFERENCE ONLY, AND NOT FOR SCALE
2. OVERALL DIMENSION : 113 x 78 x 27 mm
3. OVERALL WEIGHT : 420 g

| | | | | | | |
|------------|------------|------|----------|--|-----|-----|
| DATE | | NAME | |  DYNATRON CORPORATION | | |
| DRAWN | 09/21/2020 | Engr | | | | |
| CHECKED | 09/21/2020 | LANG | | TITLE: 1U Passive Cooler N10 BOM & Exploded Assembly Drawing | | |
| ENG. APPR. | | | | | | |
| MFG. APPR. | | | | | | |
| G.A. | | | | | | |
| COMMENTS: | | | DWG. No: | DYN-EP-N10 <table border="1" style="float: right;"> <tr> <td>REV</td> <td>0.0</td> </tr> </table> | REV | 0.0 |
| REV | 0.0 | | | | | |

| REV# | DESCRIPTION | CHECKER | DATE |
|------|-----------------|---------|------------|
| 0.0 | INITIAL RELEASE | LANG | 09/21/2020 |

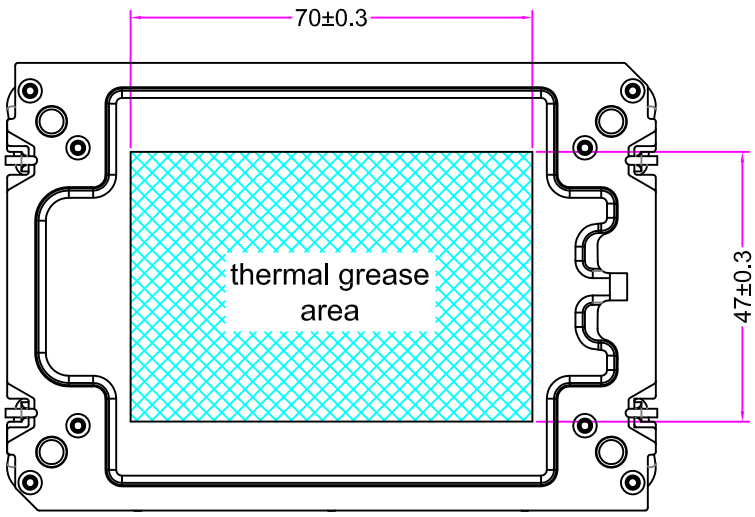
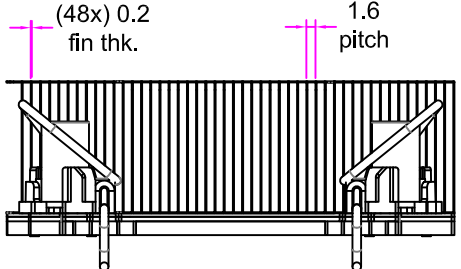
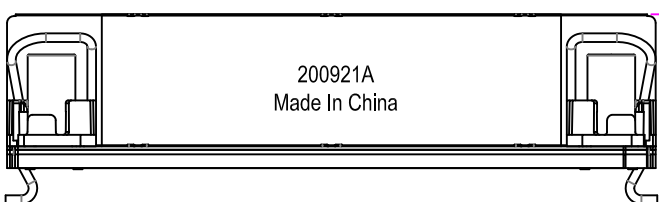
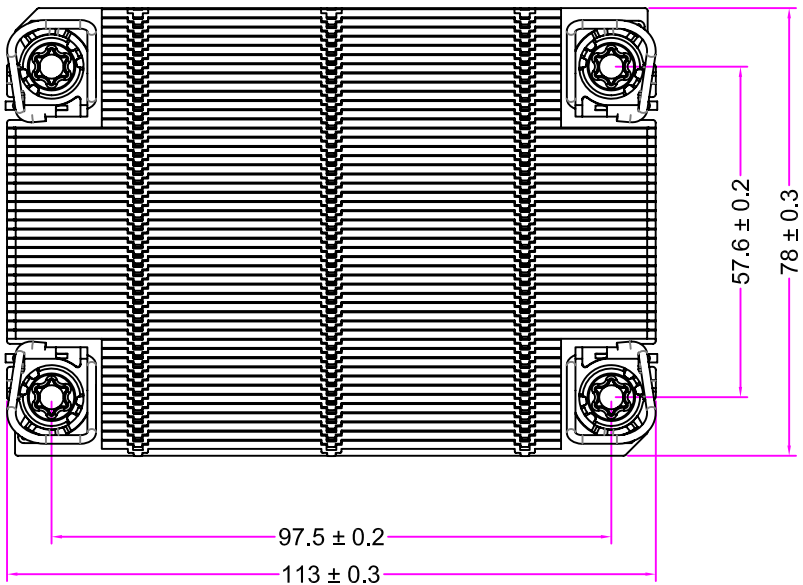

| | NAME | DATE |
|---------------|------|------------|
| DRAWN BY | engr | 09/21/2020 |
| CHECKED BY | LANG | 09/21/2020 |
| ENG. APPROVED | | |
| MFG. APPROVED | - | - |



DYNATRON CORPORATION

TOP MOTOR

TITLE: 1U Passive Cooler **N10**
Overall Dimension Drawing

CONFIDENTIAL DOCUMENT
THIS DRAWING CONTAINS INFORMATION PROPRIETARY TO DYNATRON CORPORATION AND DYNAEON INDUSTRIAL CO., LTD. ANY REPRODUCTION, DISCLOSURE, OR USE OF THIS DRAWING IS EXPRESSLY PROHIBITED EXCEPT AS DYNATRON CORPORATION AND DYNAEON INDUSTRIAL CO., LTD. MAY OTHERWISE AGREE TO IN WRITING.

| | |
|-------|----|
| VIEW | |
| UNITS | MM |

DWG. No: **DYN-DM-N10**

REV. **0.0**



Certificate of Environment Protection

環保證明書

| | |
|---|---|
| Customer: 客戶名稱: | Company: _____ Address: _____ Phone Number: _____ - _____ - _____ |
| Issue Date: | 02/02/2021 |
| Product Model Number: | N10 |
| <p>Dynatron Corporation hereby declares and certifies that all components manufactured are RoHS compliant according to the definitions and restrictions given by the European Union's Restriction (Directive 2002/95/EC) (Decision2011/65/EU)RoHS 2, on the restriction of the use of certain Hazardous Substances in the electrical and electronic equipment. Also, compliance to the most recent list of substances on the REACH candidate list.</p> <p>Number of substances on the Candidate List: 168 (last updated: 17/12/2015)</p> <p>No exemptions are claimed in order for the part to be compliant with the RoHS directive.</p> <p>Dynatron Corporation / 政久興業股份有限公司證明所有產品,零件 (包括附屬品, 包裝類) 之環境管理物質完全符合 RoHS, WEEE, 及該環保標準之規定, 並承諾遵循以上之證明.</p> <p style="text-align: right;">Dynatron Corporation. 33200 Western Ave, Union City, CA 94587</p> <p>Title (職務): _____ ASSISTANT-MANAGER _____</p> <p>Signature (簽字): _____ <i>Alan Lee</i> _____</p> <p style="text-align: right;">Date: 02 / 02 / 2021</p> | |

