

OFP-15W38

15.6" Open Frame Panel PC

Quick Reference Guide

2nd Ed – 04 October, 2022

Copyright Notice

Copyright © 2022 Avalue Technology Inc., ALL RIGHTS RESERVED.



Federal Communication Commission Interference Statement

THIS DEVICE COMPLIES WITH PART 15 OF THE FCC RULES. OPERATION IS SUBJECT TO THE FOLLOWING TWO CONDITIONS: (1) THIS DEVICE MAY NOT CAUSE HARMFUL INTERFERENCE AND (2) THIS DEVICE MUST ACCEPT ANY INTERFERENCE RECEIVED, INCLUDING INTERFERENCE THAT MAY CAUSE UNDESIRE OPERATION.

Note: This equipment has been tested and found to comply with the limits for a Class A digital device, pursuant to Part 15 of FCC Rules. These limits are designed to provide reasonable protection against harmful interference in a residential installation. This equipment generates, uses and can radiate radio frequency energy and, if not installed and used in accordance with the instruction, may cause harmful interference to radio communications. However, there is no guarantee that interference will not occur in a particular installation. If this equipment does cause harmful interference to radio or television reception, which can be determined by turning the equipment off and on, the user is encouraged to try to correct the interference by one or more of the following measures:

- Reorient or relocate the receiving antenna.
- Increase the separation between the equipment and receiver.
- Connect the equipment into an outlet on a circuit different from that to which the receiver is connected.
- Consult the dealer or an experienced radio/TV technician for help.

Notice:

- (1) A Unshielded-type power cord is required in order to meet FCC emission limits and also to prevent interference to the nearby radio and television reception. It is essential that only the supplied power cord be used.
- (2) Use only shielded cables to connect I/O devices to this equipment.
- (3) Changes or modifications not expressly approved by the party responsible for compliance could void the user's authority to operate the equipment.

FCC RF Radiation Exposure Statement

This Wireless LAN radio device has been evaluated under FCC Bulletin OET 65 and found compliant to the requirements as set forth in CFR 47 Sections 2.1091, 2.1093, and 15.247 (b) (4) addressing RF Exposure from radio frequency devices. The radiated output power of this Wireless LAN device is far below the FCC radio frequency exposure limits. Nevertheless, this device shall be used in such a manner that the potential for human contact during normal operation is minimized. When nearby persons has to be kept to ensure RF exposure compliance, in order to comply with RF exposure limits established in the ANSI C95.1 standards, the distance between the antennas and the user should not be less than 20 cm.

WARNING

“CAUTION – Use suitable mounting apparatus to avoid risk of injury.”

“CAUTION – This is a Class A product. In a domestic environment this product may cause radio interference in which case the user may be required to take adequate measures”

“CAUTION –Risk of explosion if battery is replaced by an incorrect type. Dispose of used batteries according to the instructions.”

“CAUTION - Use a power cord that matches the voltage of the power outlet, which has been approved and complies with the safety standard of your particular country.”

“WARNING – To avoid risk of electric shock, this equipment must only be connected to a supply mains with protective earth.”

Content

1. Getting Started	8
1.1 Safety Precautions	8
1.2 Packing List	8
1.3 System Specifications	9
1.4 System Overview.....	12
1.4.1 Right View	12
1.4.2 Left View	12
1.4.3 Bottom View	12
1.5 System Dimensions.....	13
1.5.1 Front and Rear side	13
1.6 Panel Mounting	14
1.7 Wall Mounting.....	25
2. Hardware Configuration	35
2.1 OFP-15W38 connector mapping	36
2.1.1 Serial Port connector (COM).....	36
2.1.2 DC power-in connector (DC in).....	37
2.2 EMX-TGLP Product Overview	38
2.3 EMX-TGLP Jumper and Connector List	39
2.4 EMX-TGLP Setting Jumpers & Connectors.....	41
2.4.1 Serial port 1/2 pin9 signal select (JRI1/JRI2).....	41
2.4.2 LVDS Back Light power selection (JSBKL1)	41
2.4.3 AT/ATX Power Mode Select (JSATX1)	42
2.4.4 M2KB1 Voltage setting (JP1).....	42
2.4.5 Clear CMOS (JBAT1)	43
2.4.6 LCD Inverter connector (JBKL1).....	43
2.4.7 LCD Inverter connector (JBKL2).....	44
2.4.8 LVDS connector (LVDS1)	44
2.4.9 eDP_Panel connector (EDP1)	45
2.4.10 General purpose I/O connector (DIO1)	45
2.4.11 Serial port1 connector (JCOM1).....	46
2.4.12 Serial port2 connector (JCOM2).....	46
2.4.13 Serial port 3/4/5/6 connector (JCOM3/4/5/6).....	47
2.4.14 Serial Port 1/2 RS485/422 Mode connector (JRS485_1/2)	47
2.4.15 SATA Power connector 1 (SPWR1).....	48
2.4.16 Power connector (PWR1).....	48

OFF-15W38

2.4.17	USB connector 3 (JUSB3)	49
2.4.18	USB connector 4 (JUSB4)	49
2.4.19	Speaker connector (SPK1)	50
2.4.20	SPI connector (JSPI1)	50
2.4.21	Battery connector (BT1)	51
2.4.22	Audio connector (JFAUD1)	51
2.4.23	EC Debug (JEC_SPI)	52
2.4.24	Miscellaneous setting connector 1 (JFPT1)	52
2.4.25	Miscellaneous setting connector 2 (FPT2)	53
2.4.26	LPC connector (JLPC1)	53
2.4.27	CPU fan connector (CPU_FAN1)	54
3	BIOS Setup	55
3.1	Introduction	56
3.2	Starting Setup	56
3.3	Using Setup	57
3.4	Getting Help	58
3.5	In Case of Problems	58
3.6	BIOS setup	59
3.6.1	Main Menu	59
3.6.1.1	System Language	60
3.6.1.2	System Date	60
3.6.1.3	System Time	60
3.6.2	Advanced Menu	60
3.6.2.1	Connectivity Configuration	61
3.6.2.2	CPU Configuration	61
3.6.2.3	Power & Performance	62
3.6.2.3.1	CPU - Power Management Control	62
3.6.2.4	PCH-FW Configuration	63
3.6.2.4.1	Firmware Update Configuration	63
3.6.2.5	Trusted Computing	64
3.6.2.6	ACPI Settings	64
3.6.2.7	IT8528 Super IO Configuration	65
3.6.2.7.1	Serial Port 1 Configuration	66
3.6.2.7.2	Serial Port 2 Configuration	66
3.6.2.7.3	Serial Port 3 Configuration	67
3.6.2.7.4	Serial Port 4 Configuration	67
3.6.2.7.5	Serial Port 5 Configuration	68
3.6.2.8	EC 8528 H/W monitor	68
3.6.2.9	S5 RTC Wake Settings	69
3.6.2.10	Serial Port Console Redirection	69

3.6.2.10.1 Legacy Console Redirection Settings	70
3.6.2.11 USB Configuration.....	70
3.6.2.12 Network Stack Configuration.....	71
3.6.2.13 NVMe Configuration	72
3.6.3 Chipset.....	72
3.6.3.1 System Agent (SA) Configuration	73
3.6.3.1.1 Memory Configuration	73
3.6.3.1.2 Graphics Configuration.....	74
3.6.3.1.3 VMD Configuration	74
3.6.3.2 PCH-IO Configuration	75
3.6.3.2.1 PCI Express Configuration.....	75
3.6.3.2.1.1 PCI Express Root Port 5(LAN2-I225).....	76
3.6.3.2.1.2 PCI Express Root Port 6(M.2 KeyE)	77
3.6.3.2.1.3 PCI Express Root Port 9(M.2 KeyB)	78
3.6.3.2.2 SATA And RST Configuration	79
3.6.3.2.3 HD Audio Configuration	79
3.6.3.3 Board & Panel Configuration.....	80
3.6.4 Security	81
3.6.4.1 Secure Boot menu.....	81
3.6.5 Boot.....	82
3.6.6 Save and exit	83
3.6.6.1 Save Changes and Reset	83
3.6.6.2 Discard Changes and Reset	83
3.6.6.3 Restore Defaults.....	84
3.6.6.4 Launch EFI Shell from filesystem device	84
4. Drivers Installation.....	85
4.1 Install Chipset Driver	86
4.2 Install VGA Driver	87
4.3 Install ME Driver	88
4.4 Install Audio Driver (For Realtek ALC897 and ALC888S HD Audio)	89
4.5 Install LAN Driver.....	90
4.6 Install RST for RAID Driver.....	92
4.7 Ascending Network Adapter	93
5. Development Resource.....	95

1. Getting Started

1.1 Safety Precautions

Warning!



Always completely disconnect the power cord from your chassis whenever you work with the hardware. Do not make connections while the power is on. Sensitive electronic components can be damaged by sudden power surges. Only experienced electronics personnel should open the PC chassis.

Caution!



Always ground yourself to remove any static charge before touching the CPU card. Modern electronic devices are very sensitive to static electric charges. As a safety precaution, use a grounding wrist strap at all times. Place all electronic components in a static-dissipative surface or static-shielded bag when they are not in the chassis.

1.2 Packing List

- 1 x OFP-15W38 Open Frame Panel PC
- 4 x VESA Screw



If any of the above items is damaged or missing, contact your retailer.

1.3 System Specifications

Board Specification	
Mother Board	EMX-TGLP-S05-A1R (6305E, 15W) EMX-TGLP-S15-A1R (I3-1115G4E, 15W) EMX-TGLP-S45-A1R (I5-1145G7E, 15W) EMX-TGLP-S85-A1R (I7-1185G7E, 15W)
CPU	Onboard Tiger Lake U 11th Intel® Core™ SoC i7/i5/i3 & Celeron® BGA Processor
CPU Cooler (Type)	Fanless
Memory	2* 260-pin DDR4 3200 MHz SO-DIMM socket, supports up to 64GB Max (non ECC only)
Wireless LAN	IEEE802.11 ax/ac/a/b/g/n 2.4 GHz, 5 GHz, 6GHz (optional)
Bluetooth	BT5.1 (optional)
Operating System	Win10 64bit, Linux
Expansion Card	1 x M.2 Key B 3042/3052/2242/2260/2280 Support 1xPCIE/SATA/USB3.0/USB2.0 with 1 x SIM card slot, support WWAN+GNSS * M.2 key B SATA share from SATA2 1 x M.2 Key E 2230 support WiFi module and CNVi (1 x PCI-e x1 & USB 2.0 Signal)
Storage	
Solid State Drive	N/A (Reserve space for future 1 x 2.5" Drive Bay design)
Other Storage Device	Default by M.2 Type B 3042/3052/2242/2260/2280 SSD (SATA/NVMe) * M.2 key B SATA share from SATA2
Panel	
LCD Panel	15.6" eDP Panel, BOE NV156FHM-N42 1920*1080
LCD Control Board	Built in
Touch Screen	15.6" PCAP Touch, Henghao HD-T156WP05-F4SB
Touch Controller	EETI
External I/O	
Serial Port	1 x RS232(default)/422/485, 1 x RS232/422/485(optional), 3 x RS232 (optional)
USB Port	3 x USB3.1 Gen2 1 x USB 3.1 Gen1 2 x USB 2.0 (optional)

Video Port	2 x DP++: 1920 x 1080@60 Hz
Audio Port	Mic-in, Line-out
LAN Port	2 x RJ45 LAN port: 1 x Intel® I219LM Gigabit Ethernet PHY (LAN1) 1 x Intel® I225LM 2.5 Gigabit Ethernet (LAN2)
Wireless LAN Antenna	6 x Antenna Mounting with Dust Cover
Switch	2 pins Phoenix connector for reset
Mechanical	
Power Type	+12V~24V DC in
Power Connector Type	1 x Mini Din 4-pin DC Jack 1 x Phoenix connector for DC in 1 x Phoenix connector for reset * Default AT mode
Dimension	387 x 235 x 48 mm
Weight	4.4 Kg
Color	Silver
Fanless	Fanless
OS Support	Windows 10 64bits, Linux (Linux does not support ACPI S3 Function)
Reliability	
EMI Test	CE/FCC Class A
Vibration Test	<p>Random Vibration Operation</p> <p>1 Test PSD : 0.00454G²/Hz , 1.5 Grms</p> <p>2 System condition : operation mode</p> <p>3 Test frequency : 5~500 Hz</p> <p>4 Test axis : X,Y and Z axis</p> <p>5 Test time : 30 minutes per each axis</p> <p>6 IEC60068-2-64 Test Fh</p> <p>6 Storage : mSATA</p> <p>Sine Vibration test (Non-operation)</p> <p>1 Test Acceleration : 2G</p> <p>2 Test frequency : 5~500 Hz</p> <p>3 Sweep : 1 Oct/ per one minute. (logarithmic)</p> <p>4 Test Axis : X,Y and Z axis</p> <p>5 Test time :30 min. each axis</p> <p>6 System condition : Non-Operating mode</p> <p>7. Reference IEC 60068-2-6 Testing procedures</p> <p>Package Vibration Test:</p>

	<p>1 Test PSD : 0.026G²/Hz , 2.16 Grms</p> <p>2 Test frequency : 5~500 Hz</p> <p>3 Test axis : X,Y and Z axis</p> <p>4 Test time : 30 minutes per each axis</p> <p>5 IEC 60068-2-64 Test Fh</p>
Mechanical Shock Test	<p>1 Wave form : Half Sine wave</p> <p>2 Acceleration Rate : 10g for operation mode</p> <p>3 Duration Time : 11ms</p> <p>4 No. of shock : Z axis 300 times</p> <p>5 Test Axis : Z axis</p> <p>6 operation mode</p> <p>7 Reference IEC 60068-2-27 testing procedures</p> <p>Test Eb : Shock Test</p>
Drop Test	<p>Package drop test</p> <p>Reference ISTA 2A, Method : IEC-60068-2-32 Test:Ed</p> <p>Test Ea : Drop Test</p> <p>1 Test phase : One corner, three edges, six faces</p> <p>2 Test high : 96.5cm</p> <p>3 Package weight : 4.4 kg</p> <p>4 Test drawing</p>
Operating Temperature	<p>0°C ~ 45°C (32°F ~ 113°F)</p> <p>*Air flow=0.5 m/s</p>
Operating Humidity	<p>40°C @ 95% Relative Humidity, Non-condensing</p>
Storage Temperature	<p>-20°C ~ 60°C (-4°F ~ 140°F)</p>
Power Consumption	<p>Max. load 48.64W with intel core i7-1195G7E/4GB/64GB(M.2 SSD)/64BG(2.5" SSD), 24V DC in</p>



Note: Specifications are subject to change without notice.

1.4 System Overview

1.4.1 Right View

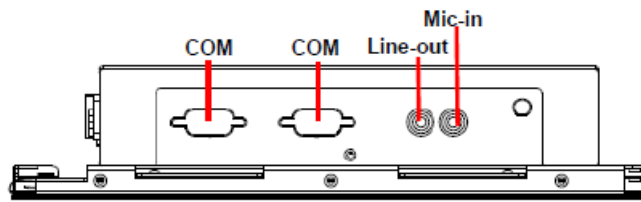

1.4.2 Left View

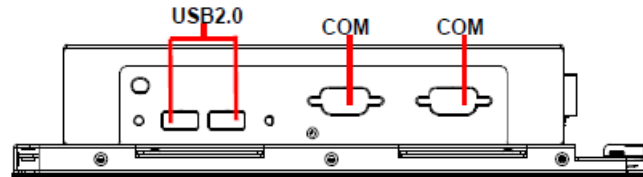

1.4.3 Bottom View

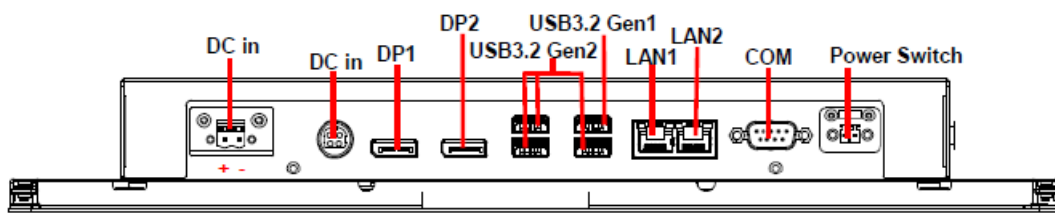

Connectors

Label	Function	Note
COM	5 x Serial port connector	1 x RS232(default)/422/485, 1 x RS232/422/485(optional) 3 x RS232 (optional)
HDMI	HDMI connector	
USB3.2 Gen1	USB 3.2 Gen1 connector	
USB3.2 Gen2	3 x USB 3.2 Gen2 connector	
USB2.0	2 x USB 2.0 connector(option)	
LAN1/2	2 x RJ-45 Ethernet	
Line-out	Line-out jack	
Mic-in	Mic-in audio jack	
DC in	DC power-in connector	
DC in	2 pins Phoenix connector	
DP1/2	2 x DP connector	
Power Switch	2 pins Phoenix connector for remote power	

1.5 System Dimensions

1.5.1 Front and Rear side

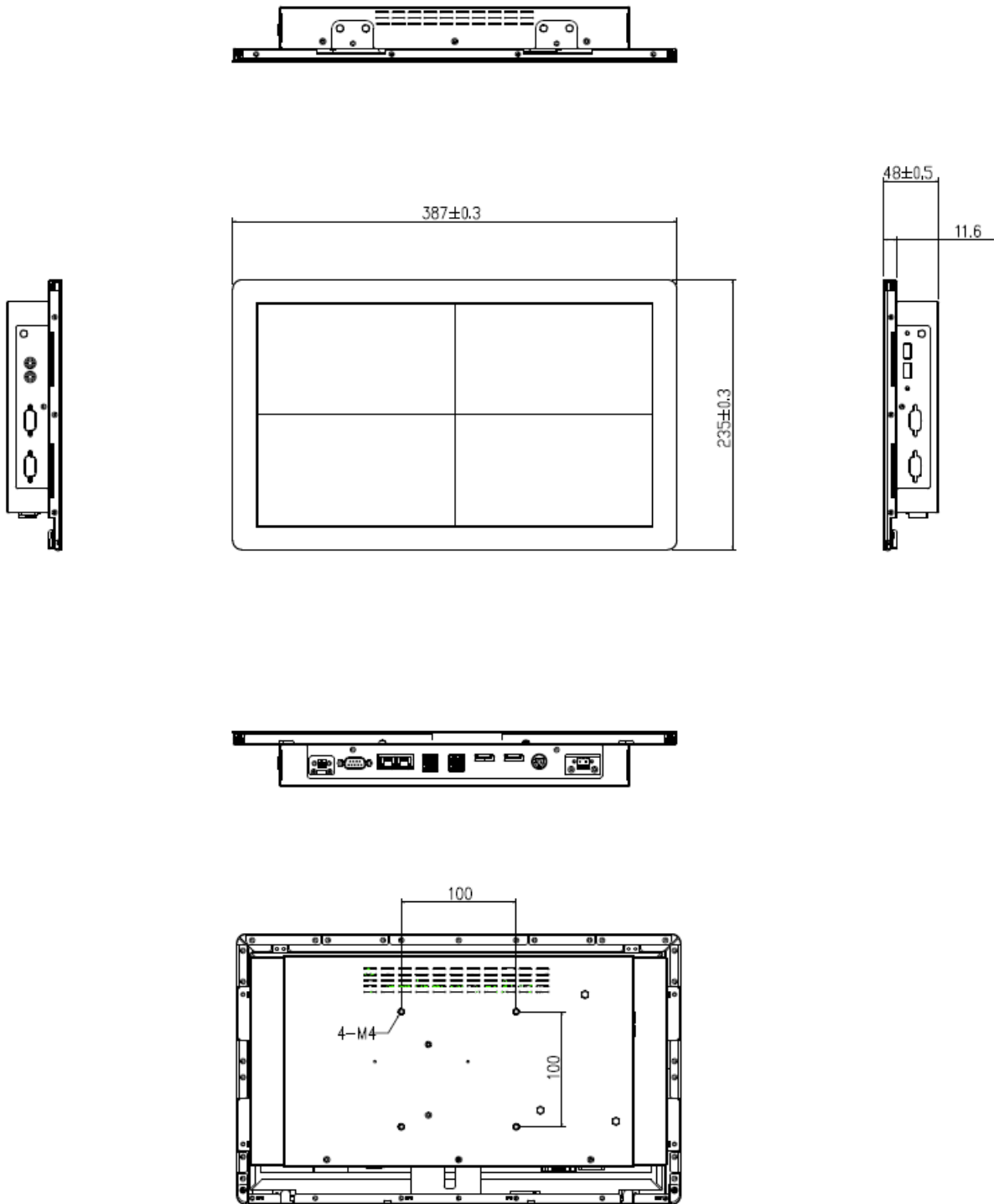

(Unit: mm)

1.6 Panel Mounting

Panel mount is the solution for mounting OFP into the opening of wall (or cabinet).

The dimension of opening is as below:

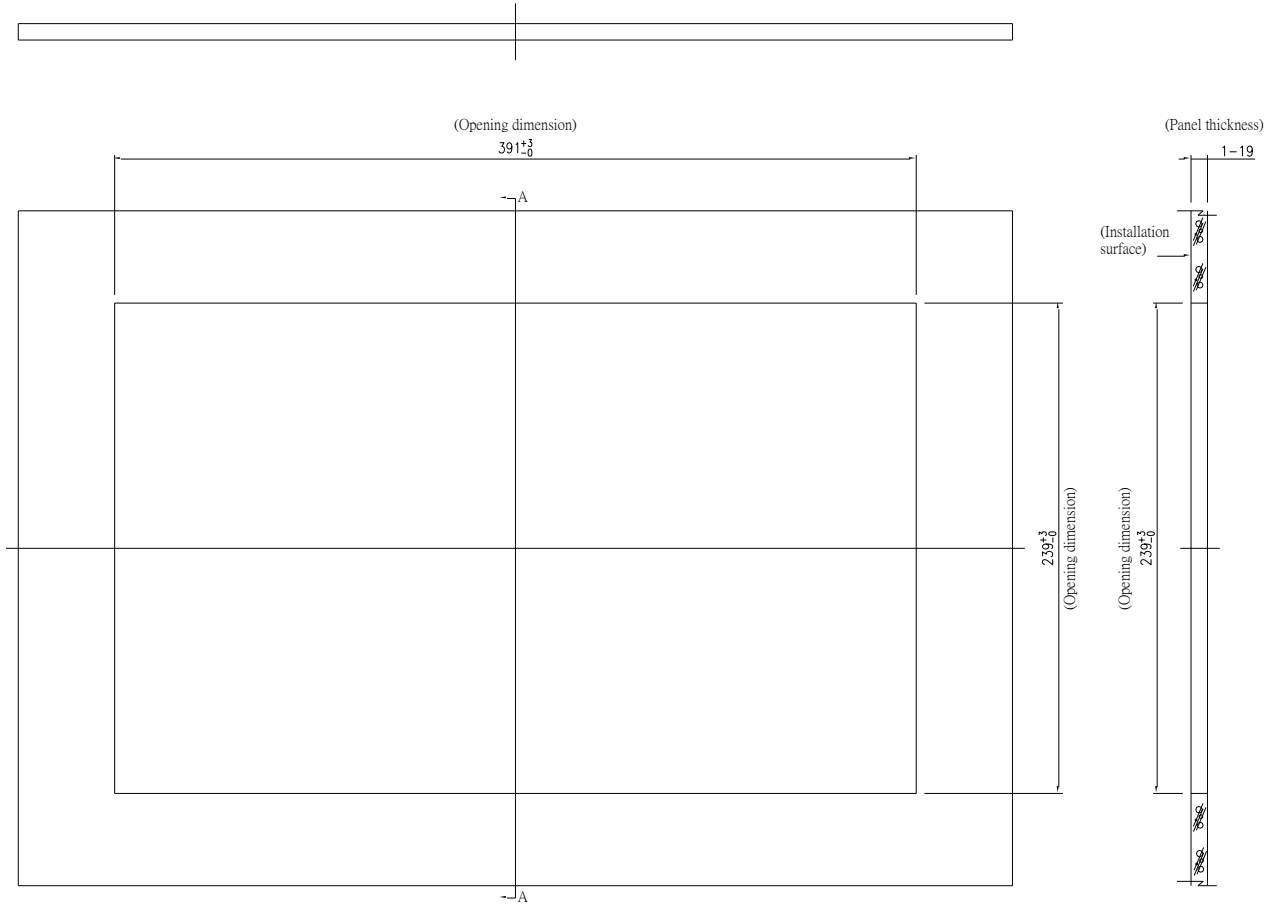

(Unit: mm)

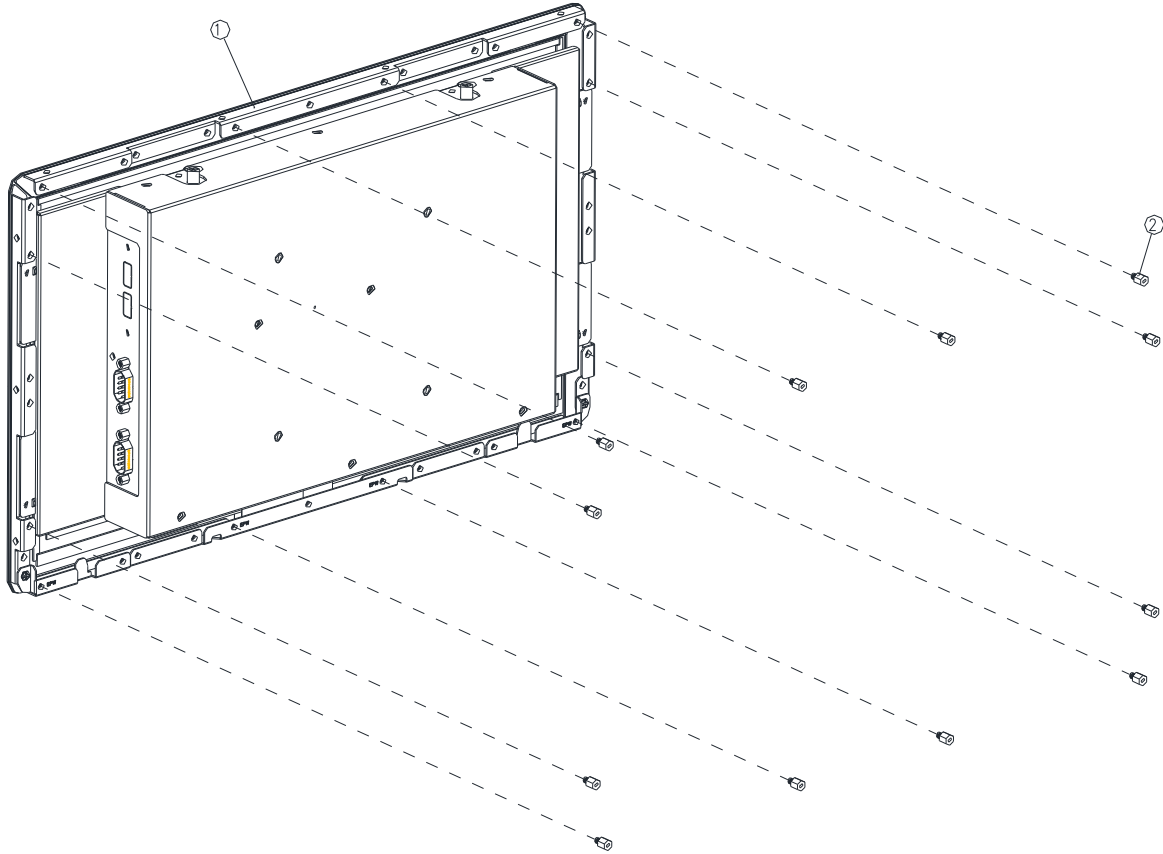

Step1. Insert and fasten 12 pcs Hexagon Studs on each side of the OFP-15W38 Bracket.

2	Hexagon Stud	12
1	OFP-15W38	1
Item	Part Name	Quantity

OFP-15W38

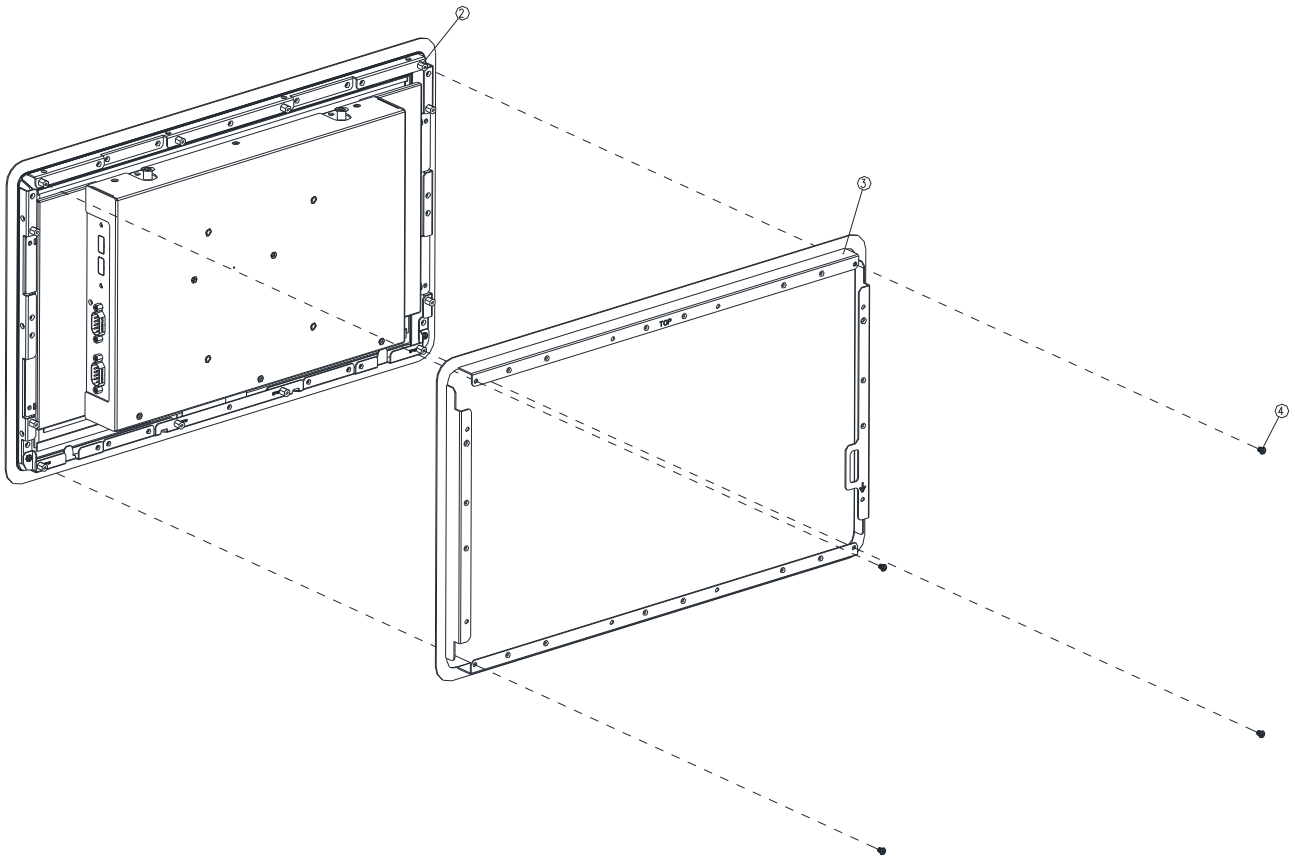

Step2. Assemble the Front bracket to OFP-15W38 and fasten 4 screws on the corresponding Hexagon Studs.

4	Screw	4
3	Front Bracket	1
2	Hexagon Stud	4
Item	Part Name	Quantity

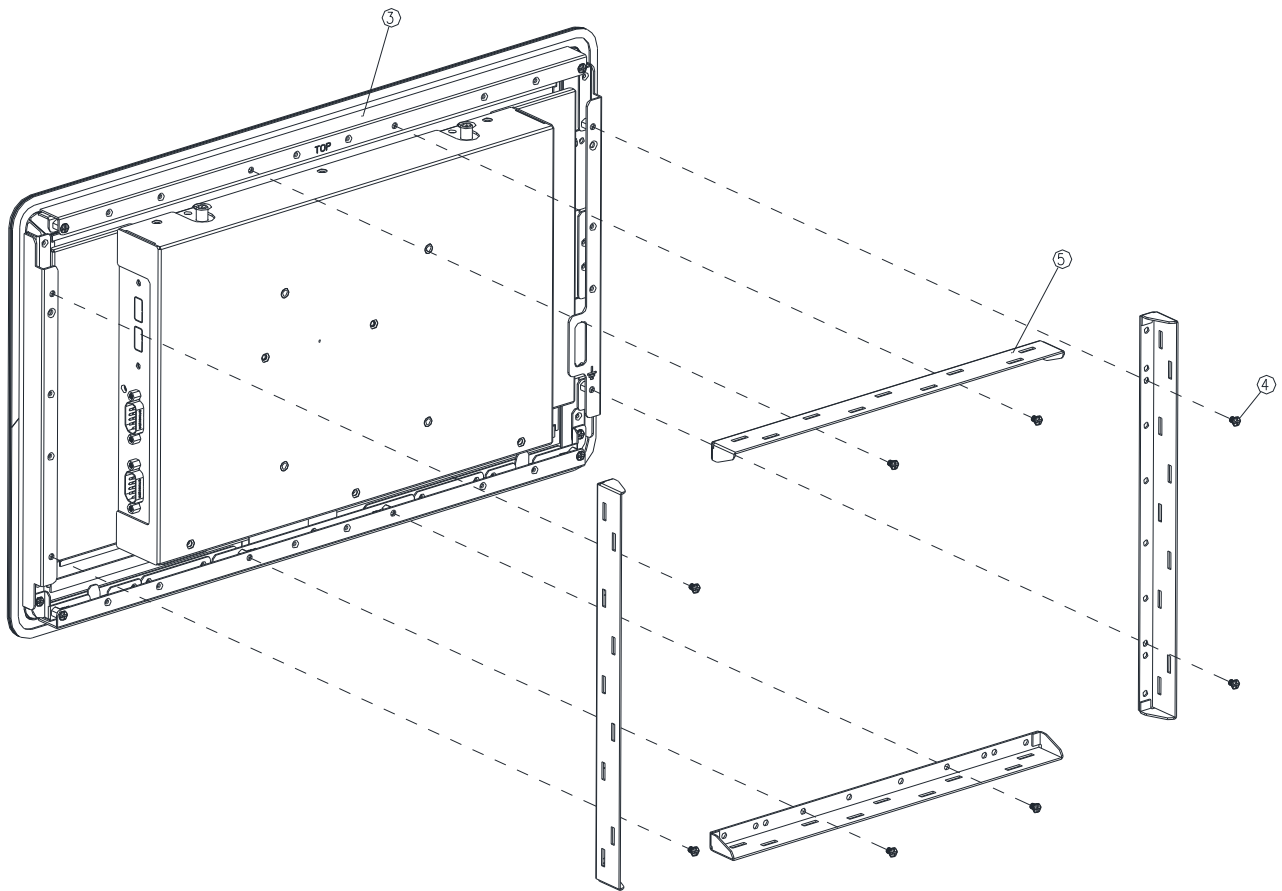

Step3. Assemble the 4pcs Panel Mount Brackets on the Front Bracket and fasten the 8 pcs screws to the corresponding holes.

5	Panel Mount Bracket	4
4	Screw	8
3	Front Bracket	1
Item	Part Name	Quantity

OFP-15W38

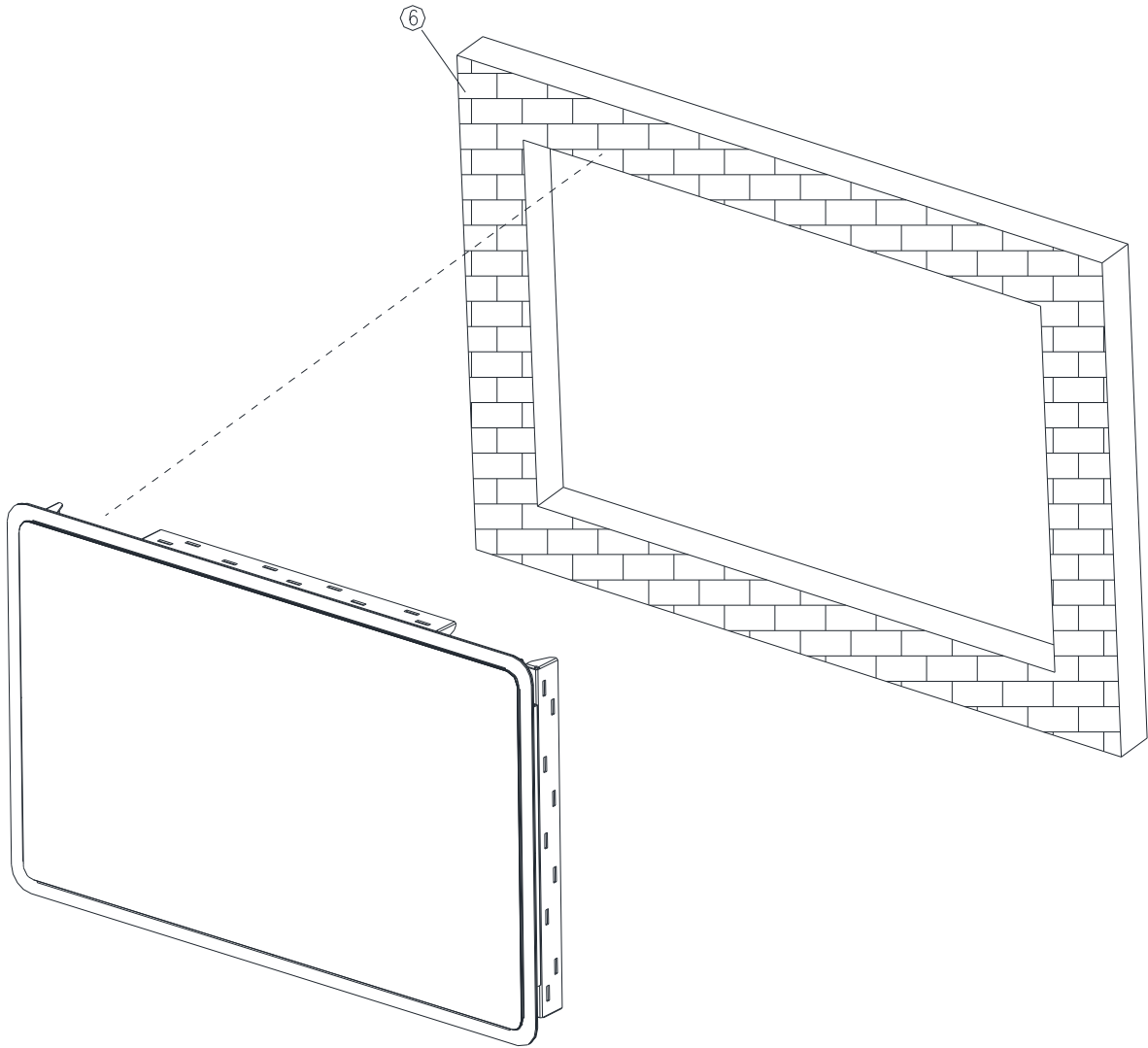

(outside the wall (or cabinet) opening)

Step4. Embed the OFP-15W38 semi-finished product into the wall (or cabinet) opening.

6	Wall	1
Item	Part Name	Quantity

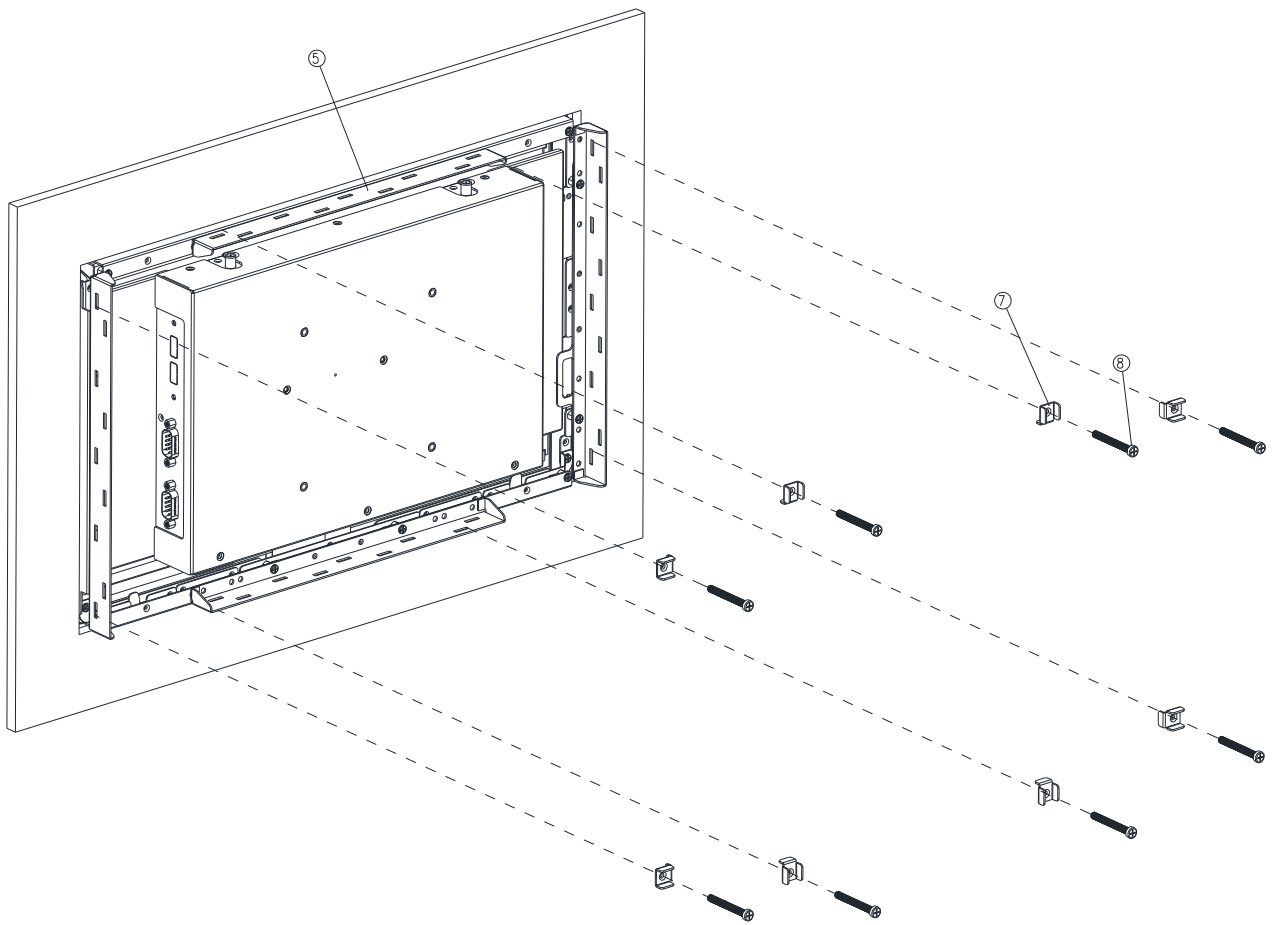

(inside the wall (or cabinet))

Step5. Fasten the Panel mount screw*8 to the Panel mount kit bracket*8 (as shown in Figure 5-1), and then attach them to the Panel Mount Bracket*4 fixing slots.

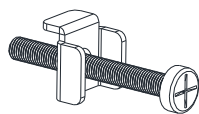
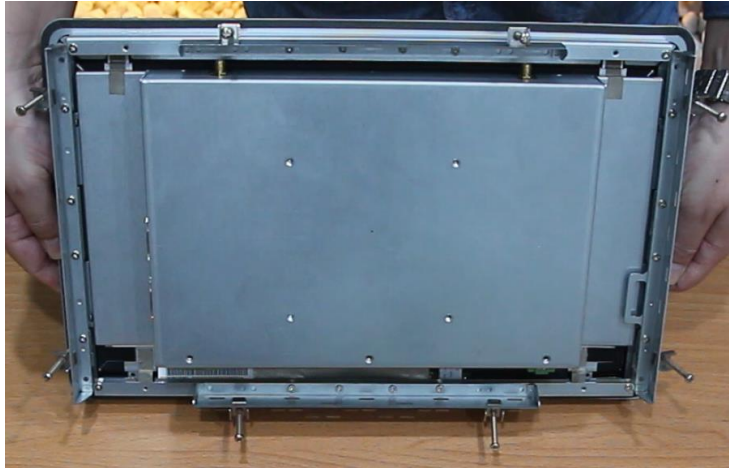
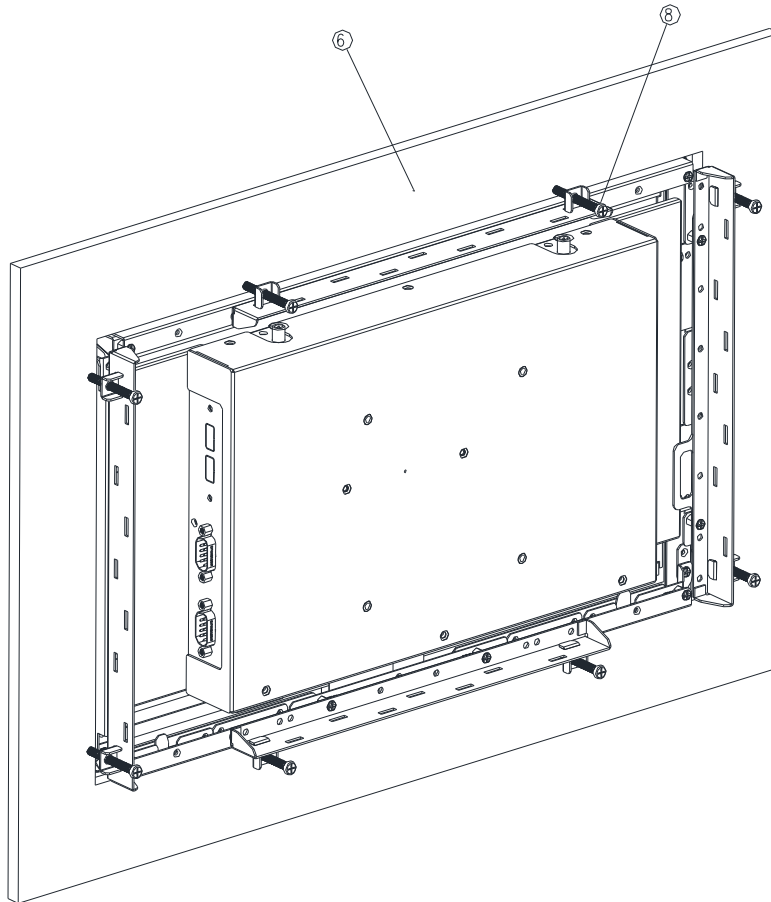

Figure 5-1

8	Panel mount Screw	8
7	Panel Mount Kit Bracket	8
5	Panel Mount Bracket	4
Item	Part Name	Quantity

OFP-15W38





Step6. Fasten the Panel mount screw*8 against the wall, so that the entire module can be secured by the Panel mount screws and Panel mount kit brackets..

8	Panel mount Screw	8
6	Wall	1
Item	Part Name	Quantity

OFP-15W38



(The diagram is demonstrated by OFP-10W01, but the concept “the entire module can be secured by fastening the Panel mount screws against the wall” is the same)

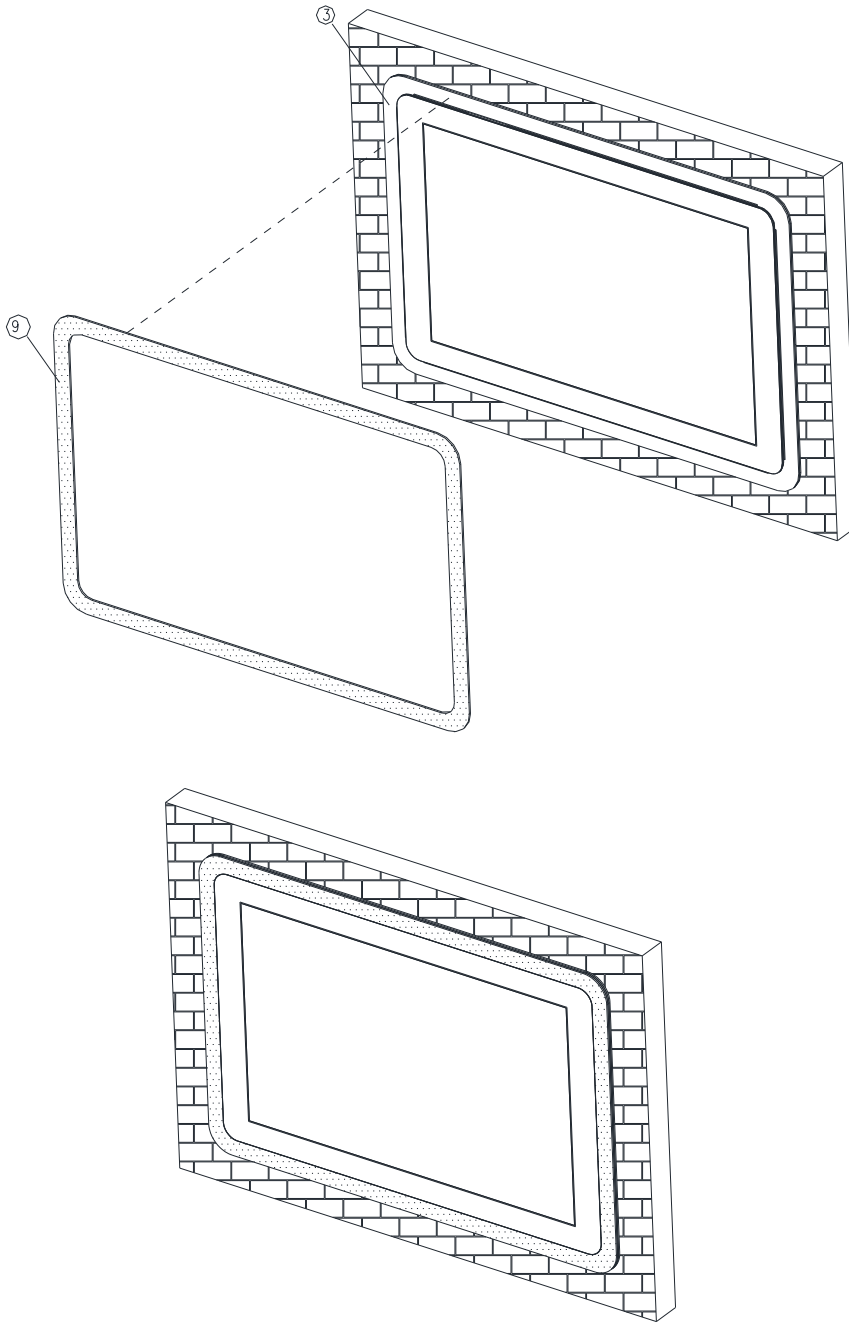

Step7. Paste the Decoration Plate on the Front bracket to complete installation.

9	Decoration Plate	1
3	Front Bracket	1
Item	Part Name	Quantity



1.7 Wall Mounting

Wall mount is the solution for mounting OFP into the wall.

Size of the opening:

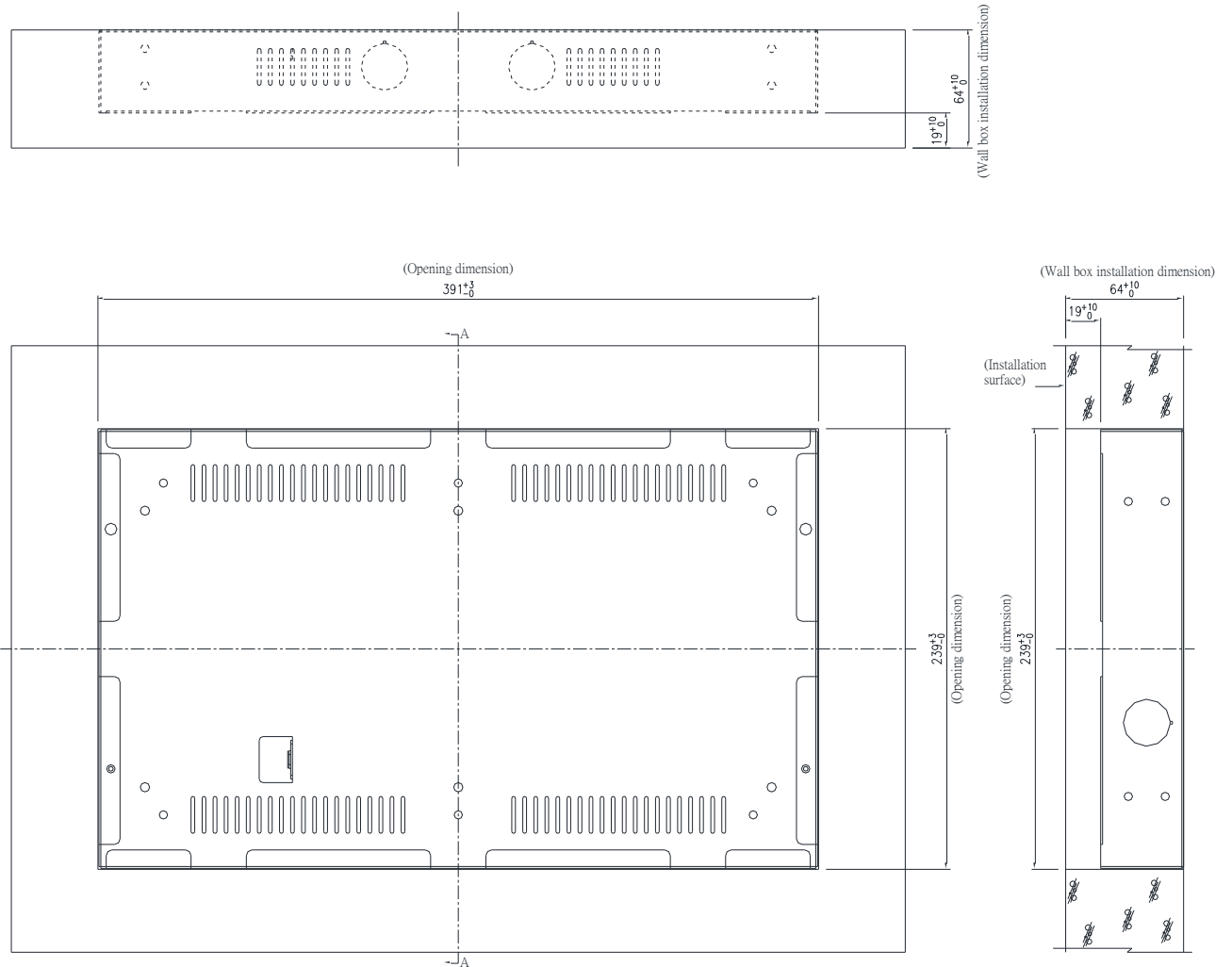

(Unit: mm)

OFP-15W38

Screw hole location:

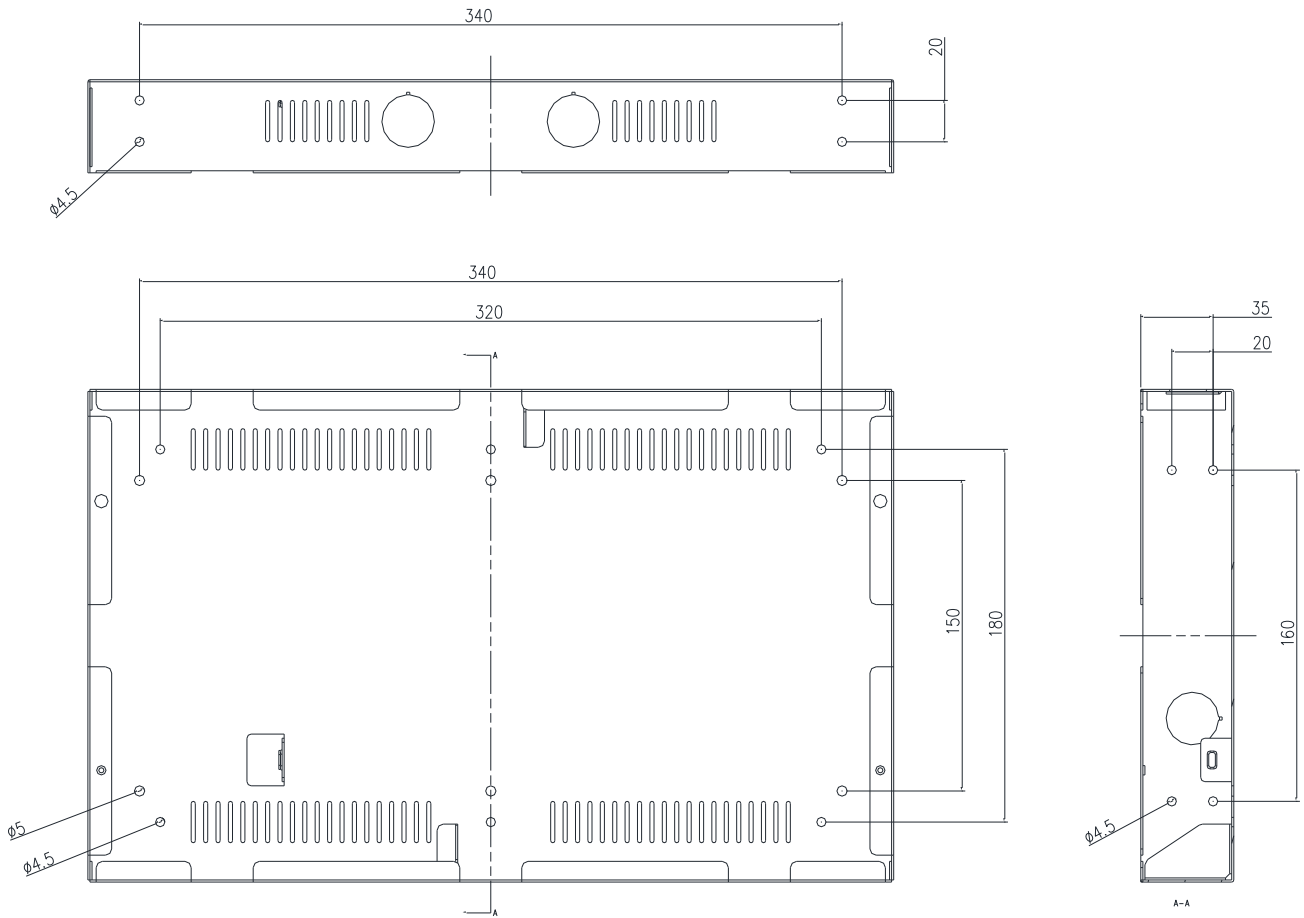

(Unit: mm)

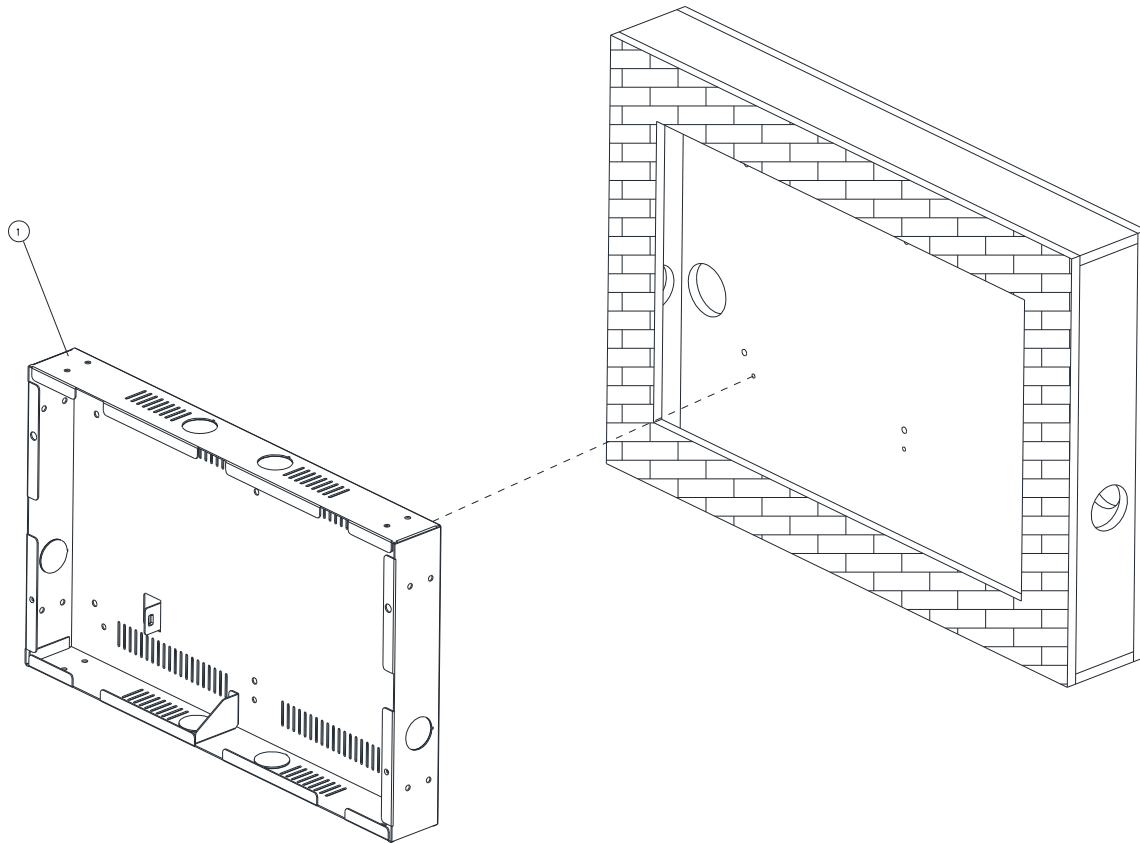

Step1. Install the 15" Wall Box and fix it on the wall, and use suitable screws to lock the wall box (the screws can be purchased according to actual needs)

1	Wall box	1
Item	Part Name	Quantity

OFP-15W38

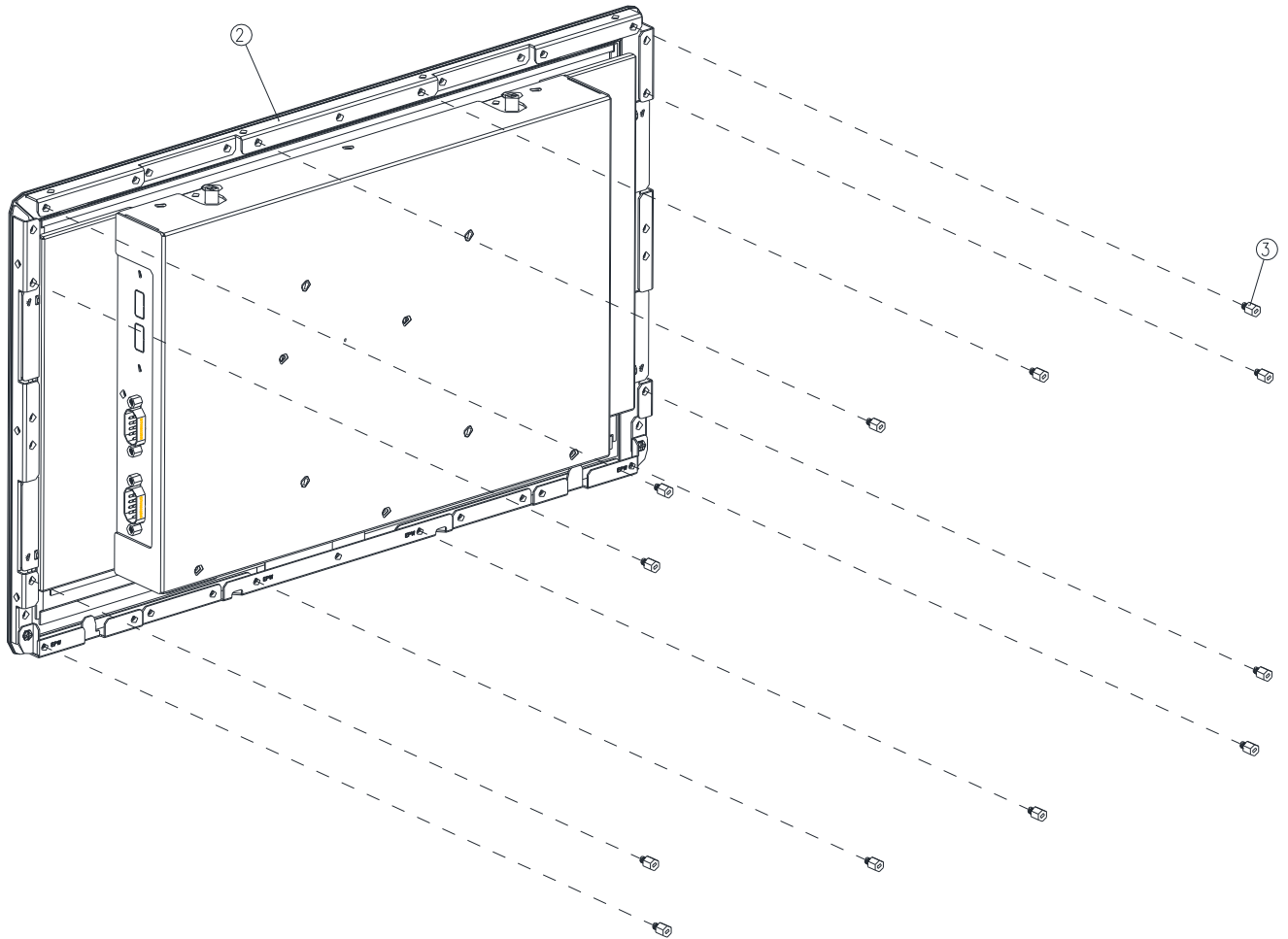

Step2. Fasten 12pcs Hexagon Studs on each side of the OFP-15W38 Panel Bracket.

3	Hexagon Stud	12
2	OFP-15W38	1
Item	Part Name	Quantity

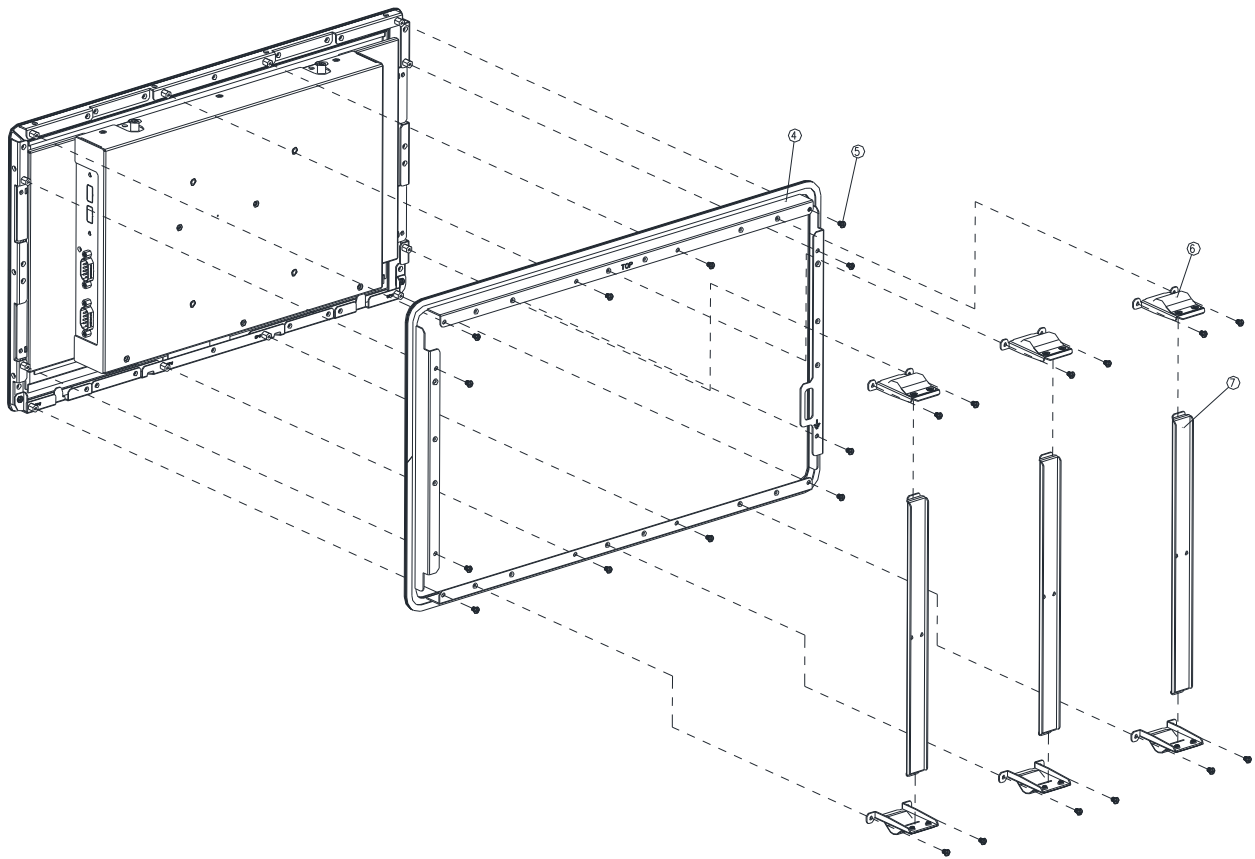

Step3-1. Assemble the Front bracket to the OFP-15W38, and fasten the 12 pcs screws on the corresponding Hexagon Studs;

Step3-2. Assemble the 3 pcs Wall mount kit to the Front bracket with 6pcs screws.

Step3-3. Insert the 3 pcs Support Bracket into the rectangular hole of Wall mount kit.

Step3-4. Insert the 3 pcs Wall mount kit's rectangular hole into the 3 pcs Support Bracket and fasten 6 pcs screws into the front bracket.

7	Support Bracket	3
6	Wall mount kit	6
5	Screw	24
4	Front bracket	1
Item	Part Name	Quantity

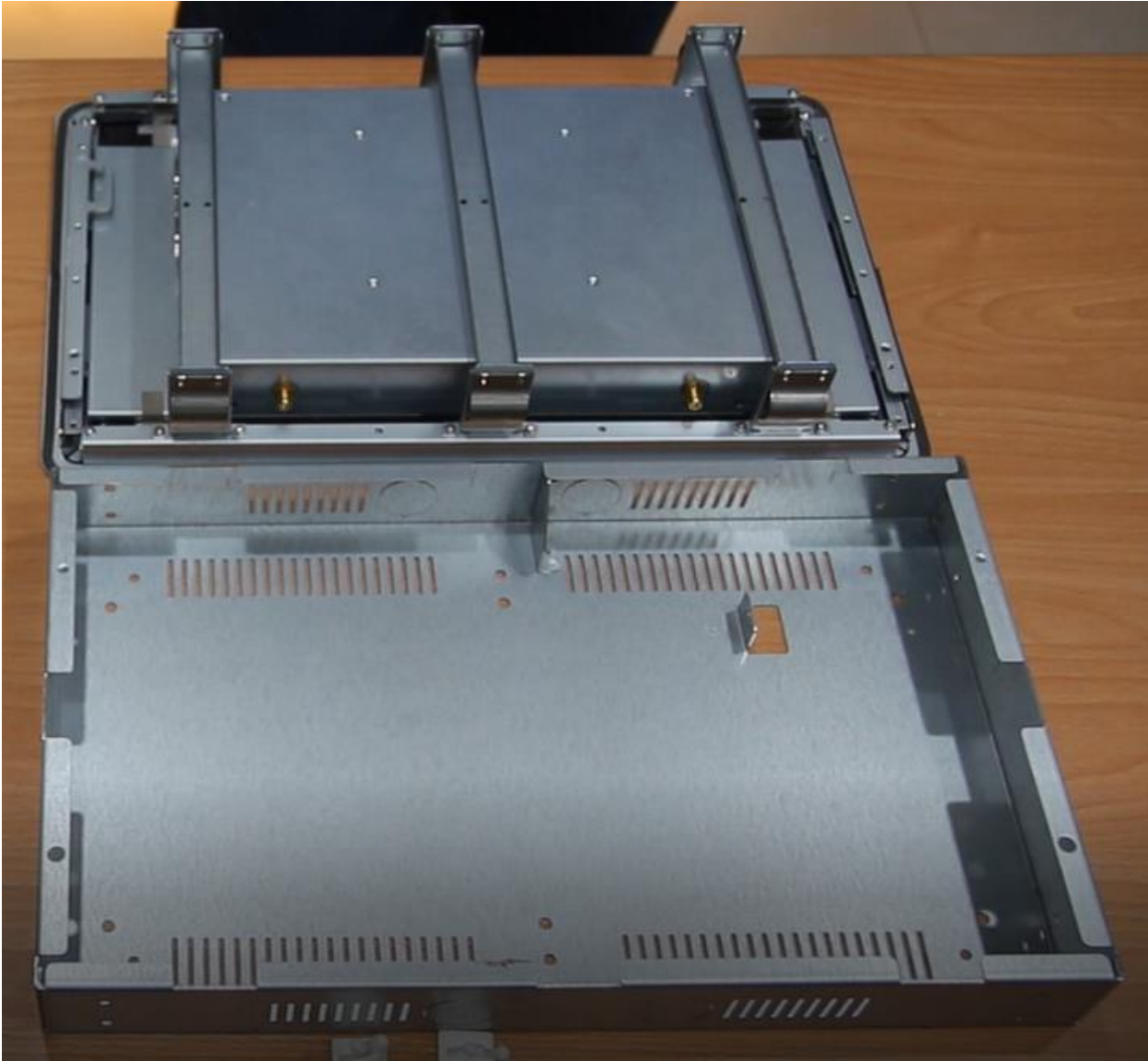
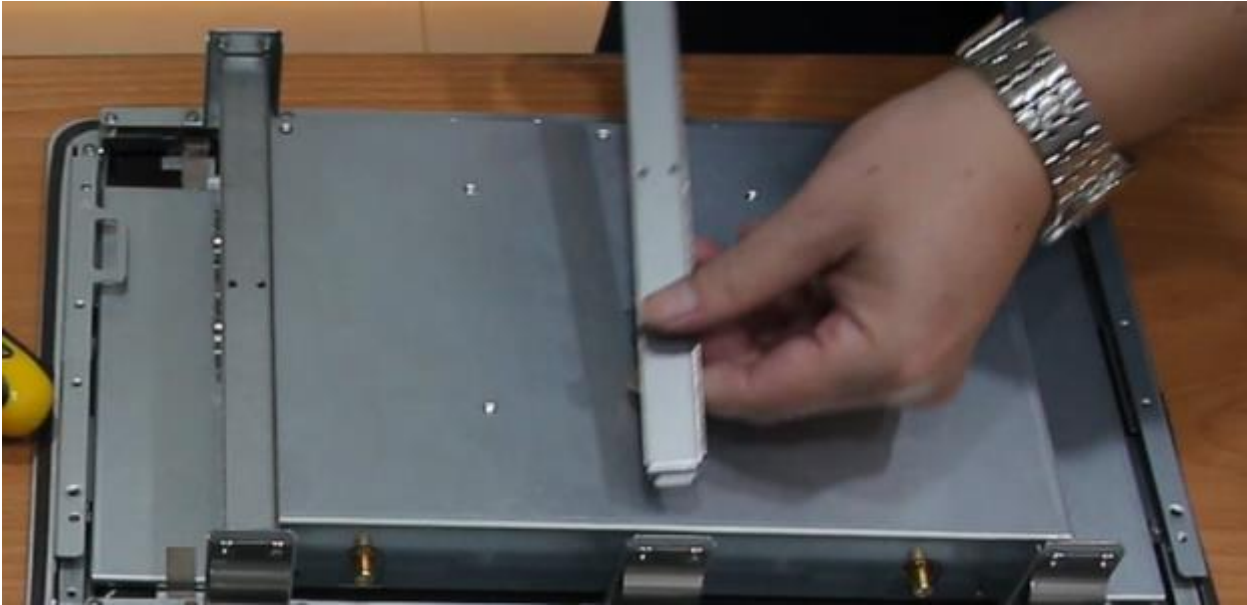

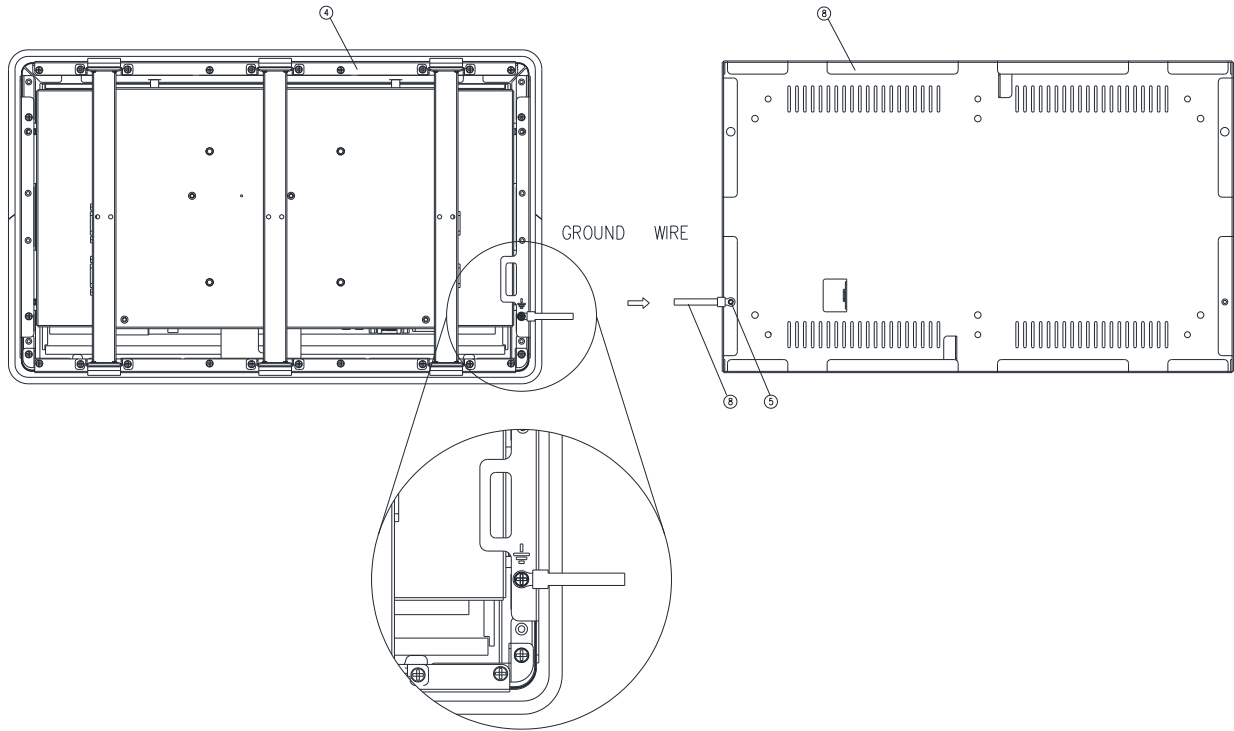

Step4. Fasten the Ground wire with 2 screws on the ground screw holes of Front bracket and Wall box.

8	Ground wire	1
5	Screw	2
4	Front bracket	1
1	Wall box	1
Item	Part Name	Quantity

OFP-15W38

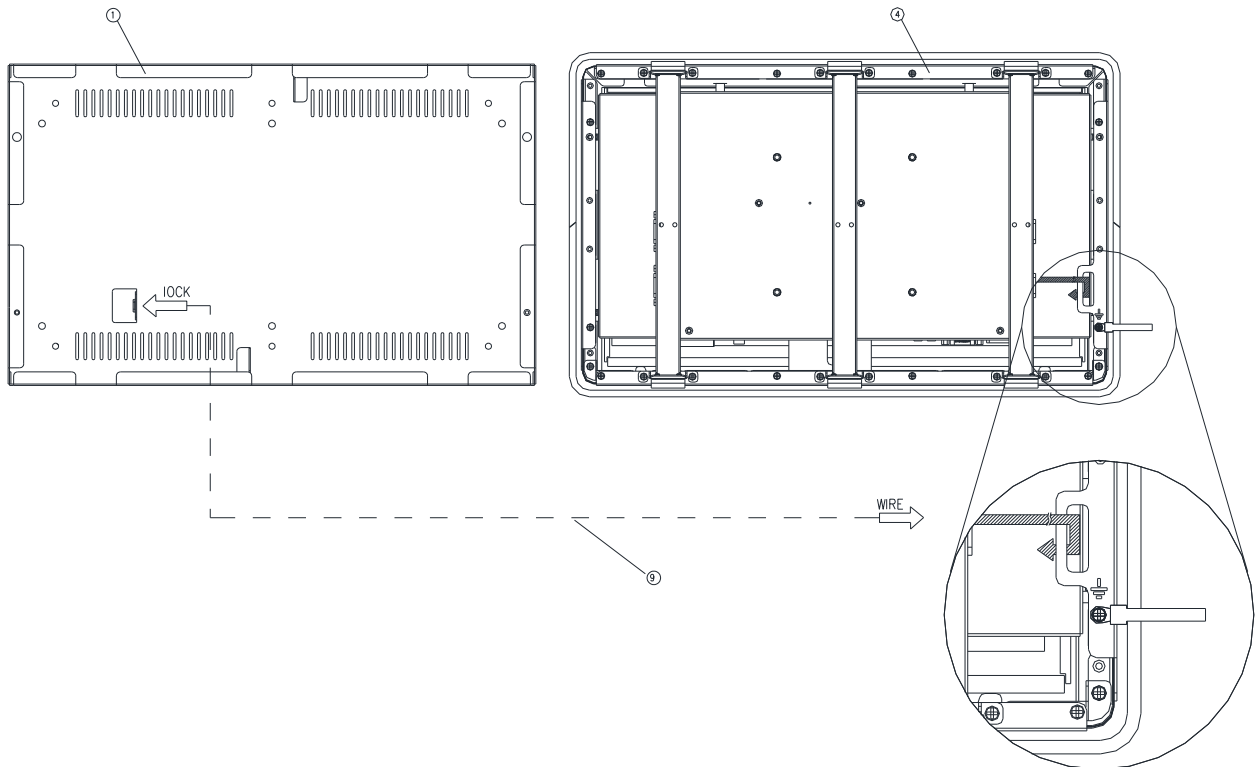

Step5. Wrap the Kensington lock (option) around the hole in the Front bracket and attach the lock to the keyhole in the Wall box.

9	Kensington lock	1
4	Front bracket	1
1	Wall box	1
Item	Part Name	Quantity

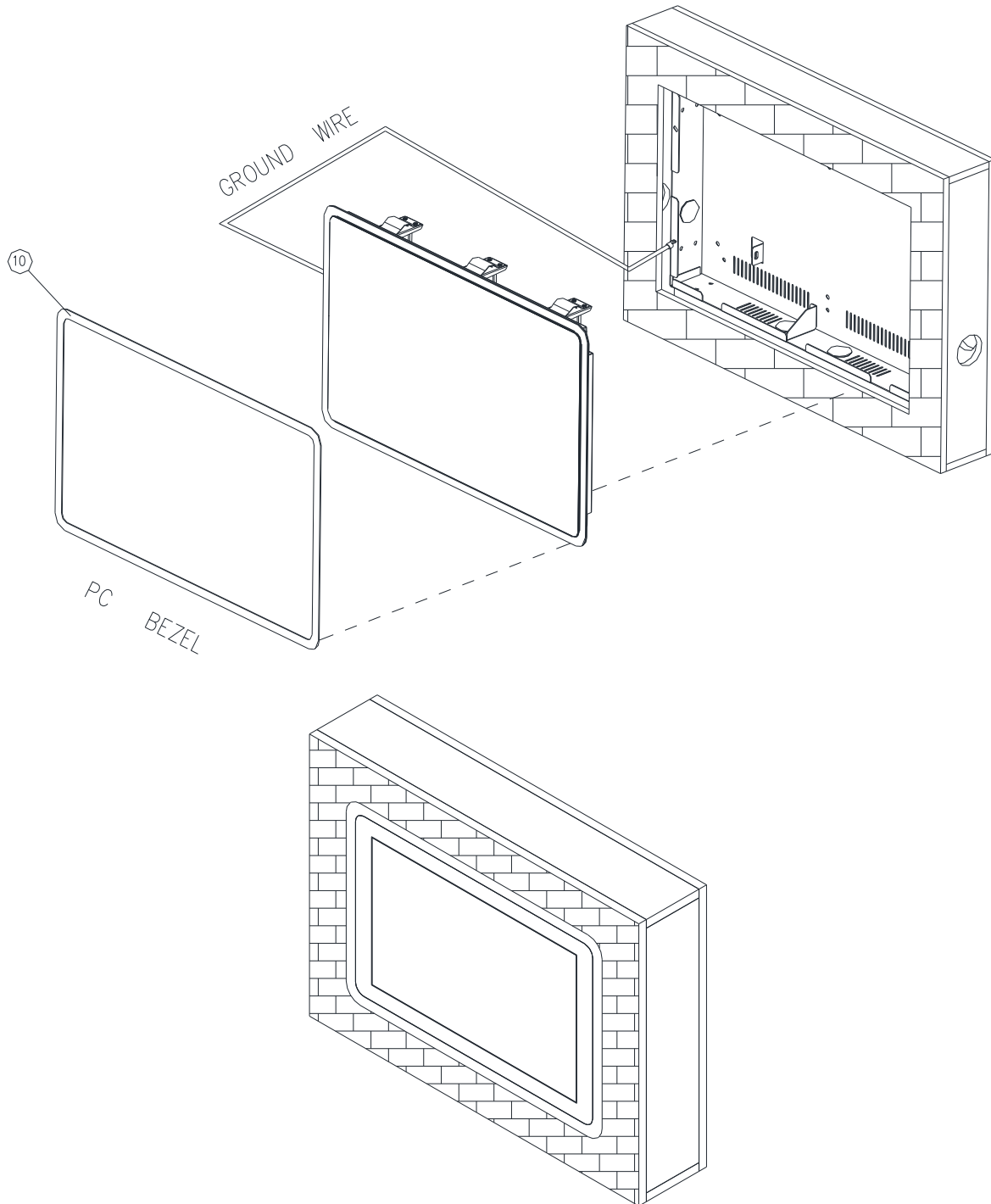

Step6-1. Store the Ground wire and Kensington lock in the Wall box and embed the OFP-15W38 semi-finished product into the wall (Wall Box).

Step6-2. Paste the Decoration Plate on the Front bracket to complete installation.

10	PC bezel	1
Item	Part Name	Quantity



2. Hardware Configuration

For advanced information, please refer to:

- 1- EMX-TGLP included in this manual.



Note: If you need more information, please visit our website:

<http://www.avalue.com.tw>

2.1 OFP-15W38 connector mapping

2.1.1 Serial Port connector (COM)

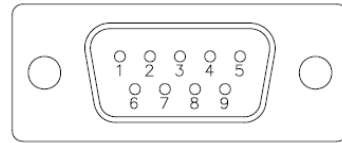
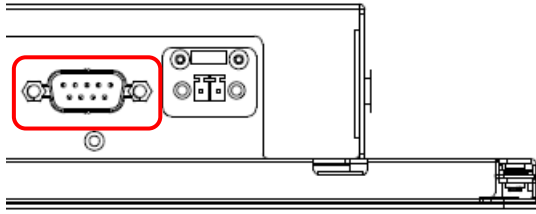

In RS-232 Mode

Signal	PIN	PIN	Signal
NDCD#	1	6	NDSR#
NRXD	2	7	NRTS#
NTXD	3	8	NCTS#
NDTR#	4	9	NRI#
GND	5		

In RS-422 Mode

Signal	PIN	PIN	Signal
TxD1-	1	6	NC
TxD1+	2	7	NC
RxD1+	3	8	NC
RxD1-	4	9	NC
GND	5		

In RS-485 Mode

Signal	PIN	PIN	Signal
DATA1-	1	6	NC
DATA1+	2	7	NC
NC	3	8	NC
NC	4	9	NC
GND	5		

2.1.2 DC power-in connector (DC in)

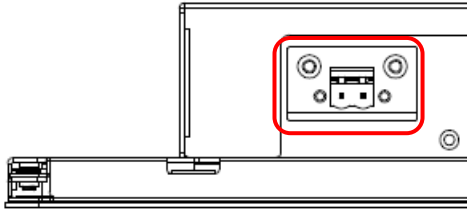

+ -
1 2

Signal	PIN
+V12-24_DCIN	1
GND	2

2.2 EMX-TGLP Product Overview

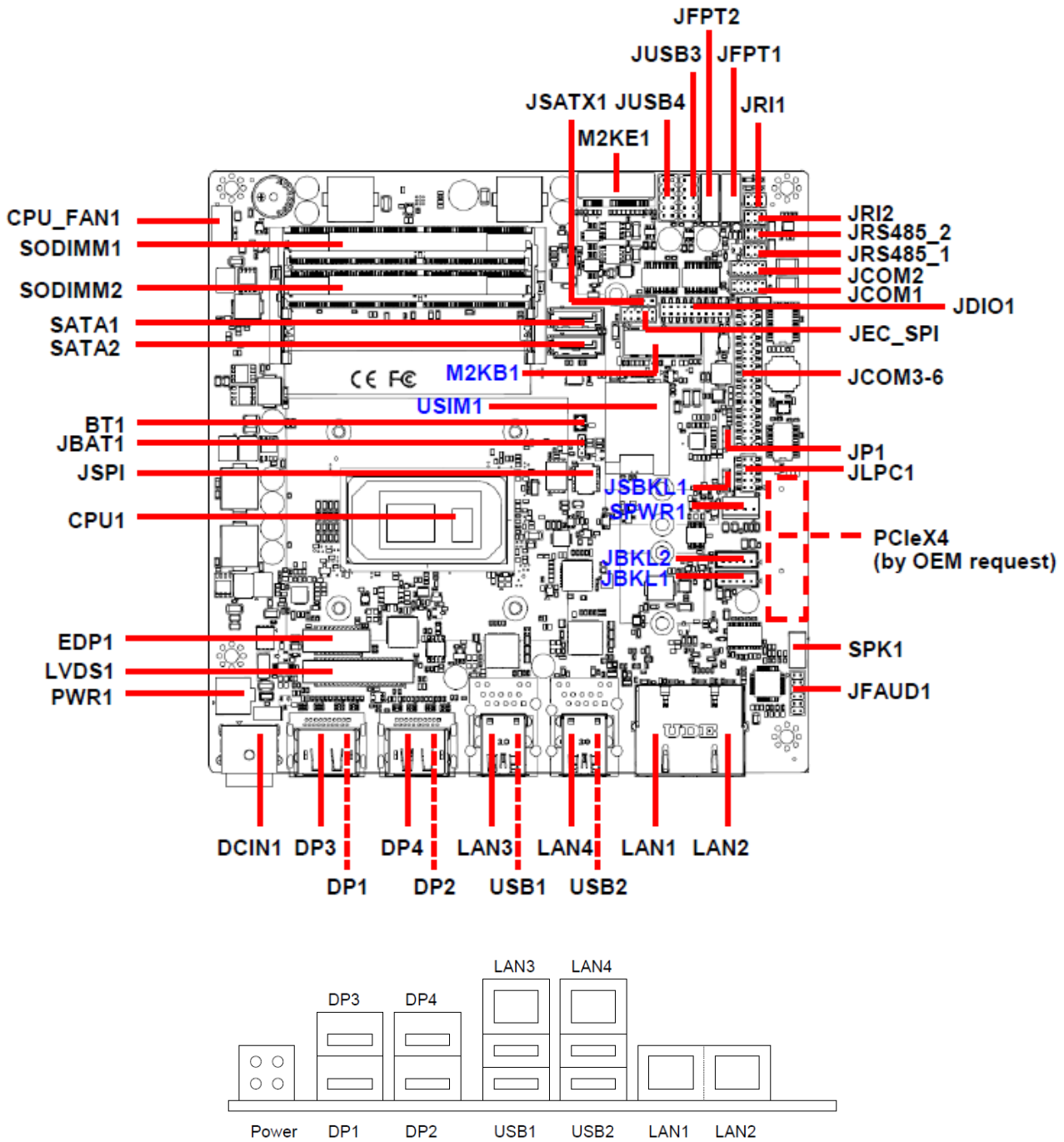

2.3 EMX-TGLP Jumper and Connector List

You can configure your board to match the needs of your application by setting jumpers. A jumper is the simplest kind of electric switch.

It consists of two metal pins and a small metal clip (often protected by a plastic cover) that slides over the pins to connect them. To “close” a jumper you connect the pins with the clip. To “open” a jumper you remove the clip. Sometimes a jumper will have three pins, labeled 1, 2, and 3. In this case, you would connect either two pins.

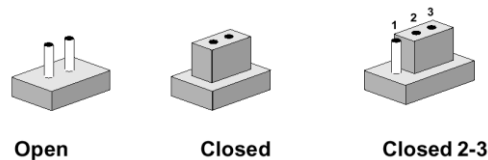

The jumper settings are schematically depicted in this manual as follows:



A pair of needle-nose pliers may be helpful when working with jumpers.

Connectors on the board are linked to external devices such as hard disk drives, a keyboard, or floppy drives. In addition, the board has a number of jumpers that allow you to configure your system to suit your application.

If you have any doubts about the best hardware configuration for your application, contact your local distributor or sales representative before you make any changes.

The following tables list the function of each of the board’s jumpers and connectors.

Jumpers

Label	Function	Note
JRI1/2	Serial port 1/2 pin9 signal select	3 x 2 header, pitch 2.00mm
JSBKL1	LVDS Back Light power selection	3 x 1 header, pitch 2.00mm
JSATX1	AT/ATX Power Mode Select	3 x 1 header, pitch 2.54mm
JP1	M2KB1 Voltage setting	3 x 1 header, pitch 2.00mm
JBAT1	Clear CMOS	2 x 1 wafer, pitch 2.00mm

Connectors

Label	Function	Note
FPT1	Miscellaneous setting connector 1	5 x 2 header, pitch 2.54mm
FPT2	Miscellaneous setting connector 2	5 x 2 header, pitch 2.54mm
SODIMM1/2	206-pin DDR4 SO-DIMM socket	
JFAUD1	Front Audio connector	6 x 2 header, pitch 2.00mm

OFP-15W38

JBKL1/2	LCD Inverter connector	5 x 1 wafer, pitch 2.00mm
JSPI1	SPI connector	4 x 2 header, pitch 2.00mm
JEC_SPI	EC Debug	5 x 2 header, pitch 2.00mm
JCOM1	Serial Port 1 connector	5 x 2 header, pitch 2.00mm
JCOM2	Serial Port 2 connector	5 x 2 header, pitch 2.00mm
JCOM3-6	Serial Port 3-6 connector	20 x 2 header, pitch 2.00mm
JDIO1	General purpose I/O connector	10 x 2 header, pitch 2.00mm
SPK1	Speaker connector	4 x 1 wafer, pitch 2.00mm
LVDS1	LVDS Connector	20 x 2 wafer, pitch 1.25mm
EDP1	eDP_Panel connector	10 x 2 wafer, pitch 1.25mm
USB1/2	USB connector 1/2	
JUSB3/4	USB connector 3/4	5 x 2 header, pitch 2.54mm
LAN1/2/3/4	RJ-45 Ethernet 1/2/3/4	
BT1	Battery connector	2 x 1 wafer, pitch 1.25mm
M2KE1	M.2 2230 Type E Slot	
M2KB1	M.2 3042/2242/2260/2280 Type B Slot	
DP1/2/3/4	DP connector 1/2/3/4	
JRS485_1/2	Serial Port 1/2 RS485/422 Mode connector	3 x 2 header, pitch 2.00mm
JLPC	LPC connector	5 x 2 header, pitch 2.00mm
DCIN1	DC Power-in connector	
PWR1	Power connector	2 x 2 wafer, pitch 4.20mm
SATA1/2	Serial ATA connector 1/2	
SPWR1	SATA Power connector 1	4 x 1 wafer, pitch 2.54mm
USIM1	USIM card slot	
CPU_FAN1	CPU fan connector	4 x 1 wafer, pitch 2.54mm
PCIEX4_1	PCIe connector	By OEM request. Due to poor compatibility concern, remove this connector.

2.4 EMX-TGLP Setting Jumpers & Connectors

2.4.1 Serial port 1/2 pin9 signal select (JRI1/JRI2)

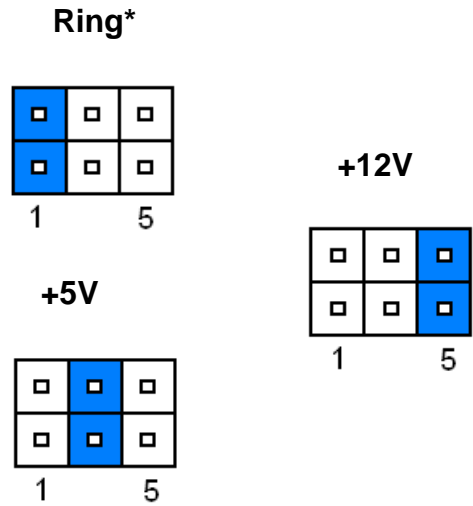
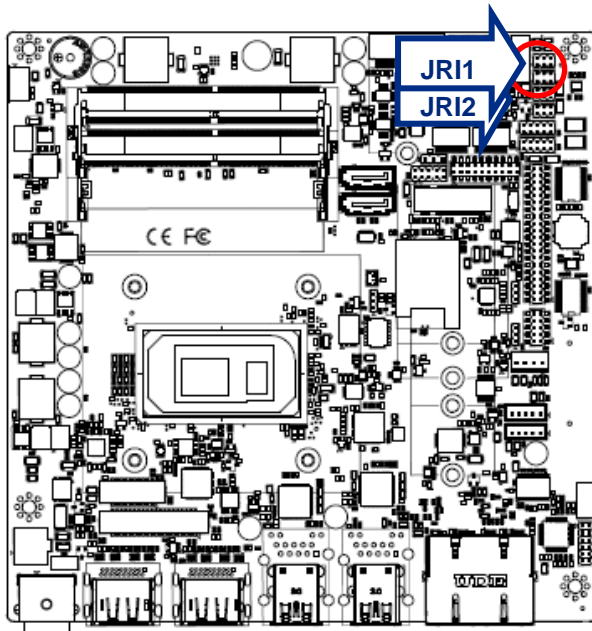

* Default

2.4.2 LVDS Back Light power selection (JSBKL1)

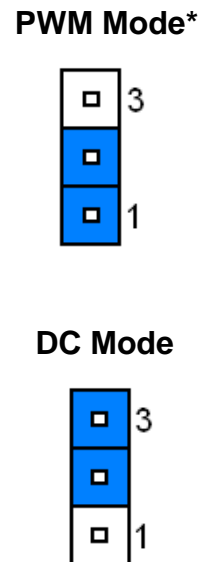
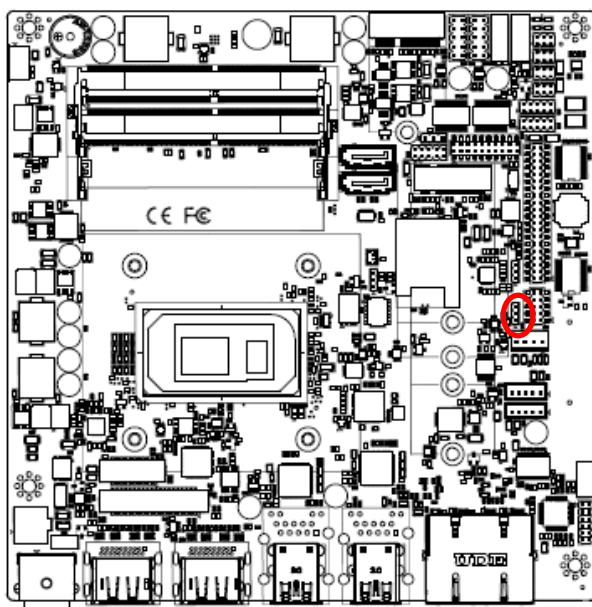

* Default

2.4.3 AT/ATX Power Mode Select (JSATX1)

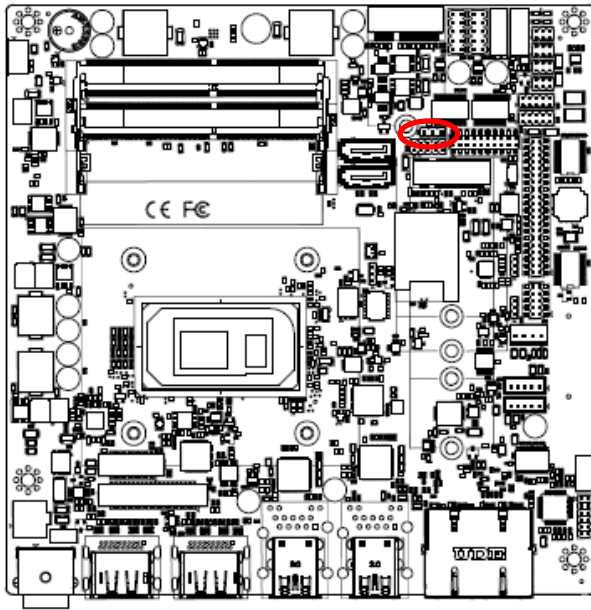

ATX*

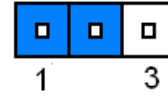

AT

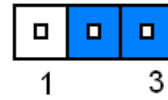

* Default

2.4.4 M2KB1 Voltage setting (JP1)

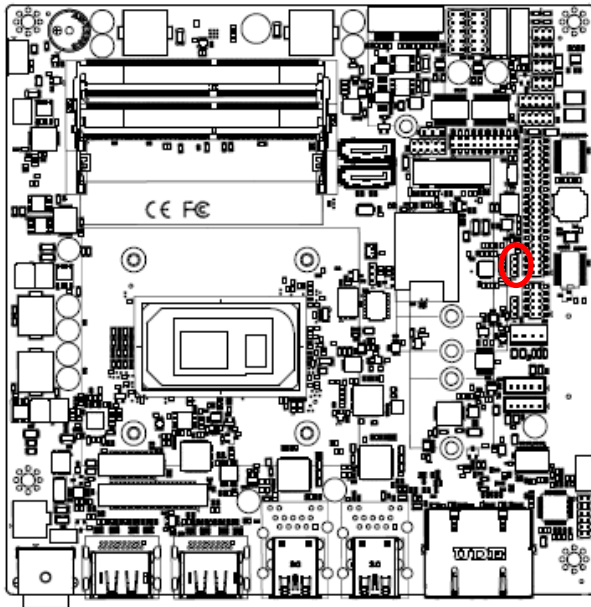

+3.8V

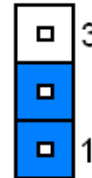

+3.3V*

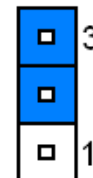

* Default

2.4.5 Clear CMOS (JBAT1)

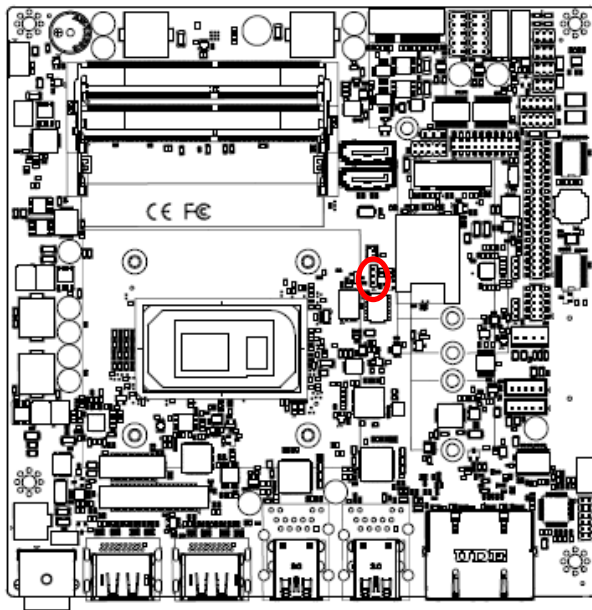

Protect*

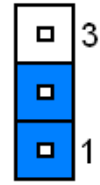

Clear CMOS

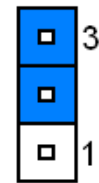

* Default

2.4.6 LCD Inverter connector (JBKL1)

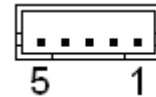
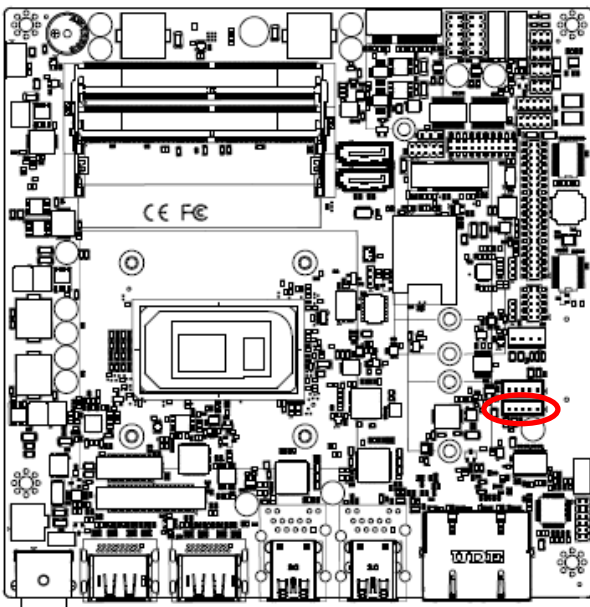

PIN	Signal
1	+12V
2	GND
3	LVDS_BKLT_EN
4	LVDS_BKLTCTL
5	+5V

2.4.7 LCD Inverter connector (JBKL2)

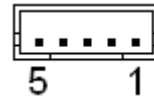
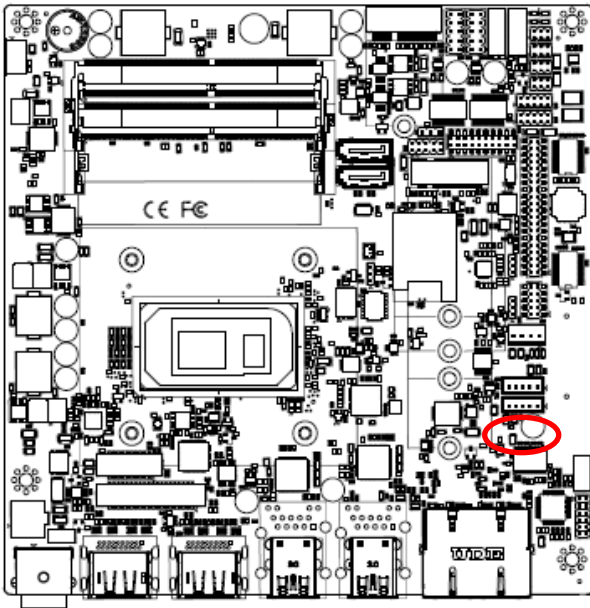

PIN	Signal
1	+12V
2	GND
3	EDP2_BKLTEN
4	EDP2_BKLT_CTL
5	+5V

2.4.8 LVDS connector (LVDS1)

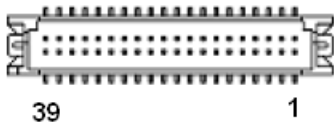
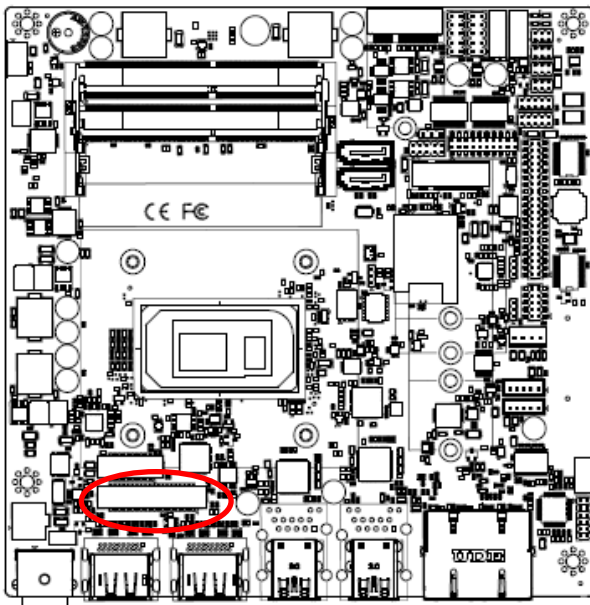

Signal	PIN	PIN	Signal
+V5S_LVDS	2	1	+ V3.3S_LVDS
+V5S_LVDS	4	3	+ V3.3S_LVDS
NC	6	5	NC
GND	8	7	GND
LVDS_DATA0_P	10	9	LVDS_DATA1_P
LVDS_DATA0_N	12	11	LVDS_DATA1_N
GND	14	13	GND
LVDS_DATA2_P	16	15	LVDS_DATA3_P
LVDS_DATA2_N	18	17	LVDS_DATA3_N
GND	20	19	GND
LVDS_DATA4_P	22	21	LVDS_DATA5_P
LVDS_DATA4_N	24	23	LVDS_DATA5_N
GND	26	25	GND
LVDS_DATA6_P	28	27	LVDS_DATA7_P
LVDS_DATA6_N	30	29	LVDS_DATA7_N
GND	32	31	GND
LVDS_CLK1_P	34	33	LVDS_CLK2_P
LVDS_CLK1_N	36	35	LVDS_CLK2_N
GND	38	37	GND
+V12S_LVDS	40	39	+V12S_LVDS

2.4.9 eDP_Panel connector (EDP1)

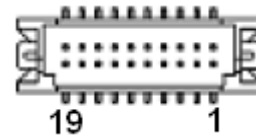
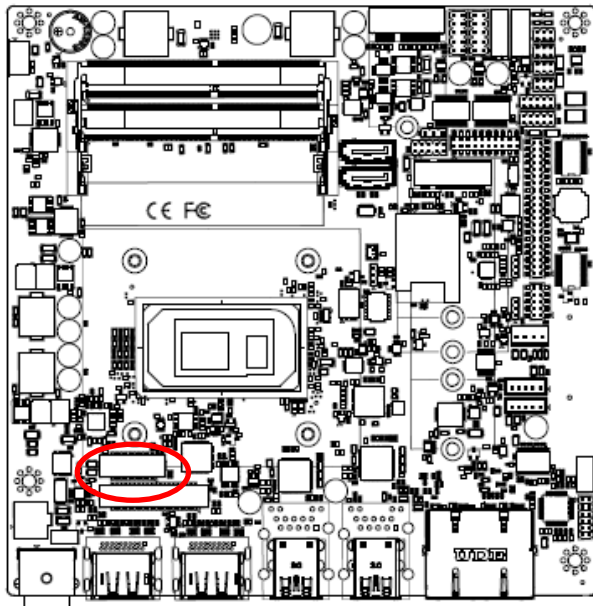

Signal	PIN	PIN	Signal
GND	1	2	GND
EDP_PANEL_TXN0	3	4	EDP_PANEL_TXN3
EDP_PANEL_TXP0	5	6	EDP_PANEL_TXP3
GND	7	8	NC
EDP_PANEL_TXN1	9	10	GND
EDP_PANEL_TXP1	11	12	EDP_PANEL_AUXN
GND	13	14	EDP_PANEL_AUXP
EDP_PANEL_TXN2	15	16	GND
EDP_PANEL_TXP2	17	18	EDP_PANEL_HPDP
+V35_EDP	19	20	+V35_EDP

2.4.10 General purpose I/O connector (DIO1)

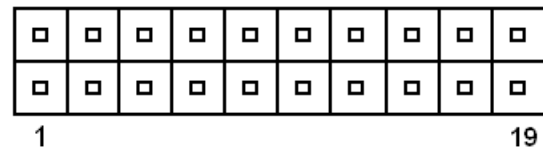
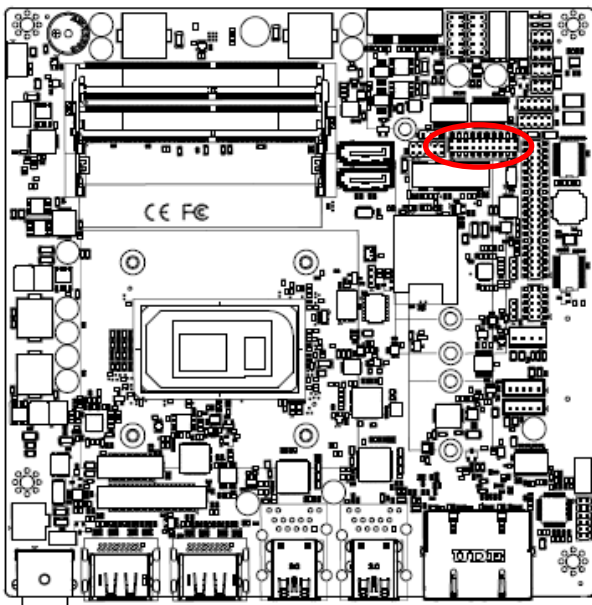

Signal	PIN	PIN	Signal
DI0	1	2	DO0
DI1	3	4	DO1
DI2	5	6	DO2
DI3	7	8	DO3
DI4	9	10	DO4
DI5	11	12	DO5
DI6	13	14	DO6
DI7	15	16	DO7
SMB_SCL_S0_3P3EXT	17	18	SMB_SDA_S0_3P3EXT
GND	19	20	+5V (Max current = 0.5A)

2.4.11 Serial port1 connector (JCOM1)

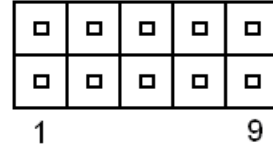
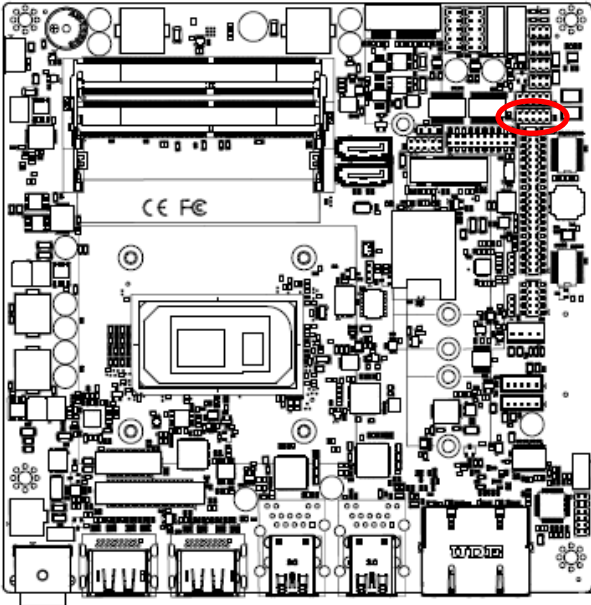

Signal	PIN	PIN	Signal
COM_DCD#_1	1	2	COM_RXD_1
COM_TXD_1	3	4	COM_DTR#_1
GND	5	6	COM_DSR#_1
COM_RTS#_1	7	8	COM_CTS#_1
COM_RI#_1	9	10	NC

2.4.12 Serial port2 connector (JCOM2)

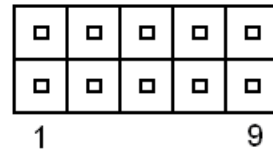
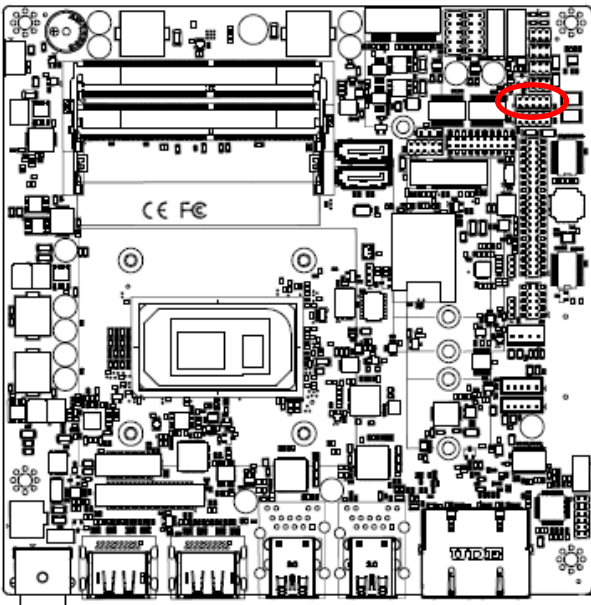

Signal	PIN	PIN	Signal
COM_DCD#_2	1	2	COM_RXD_2
COM_TXD_2	3	4	COM_DTR#_2
GND	5	6	COM_DSR#_2
COM_RTS#_2	7	8	COM_CTS#_2
COM_RI#_2	9	10	NC

2.4.13 Serial port 3/4/5/6 connector (JCOM3/4/5/6)

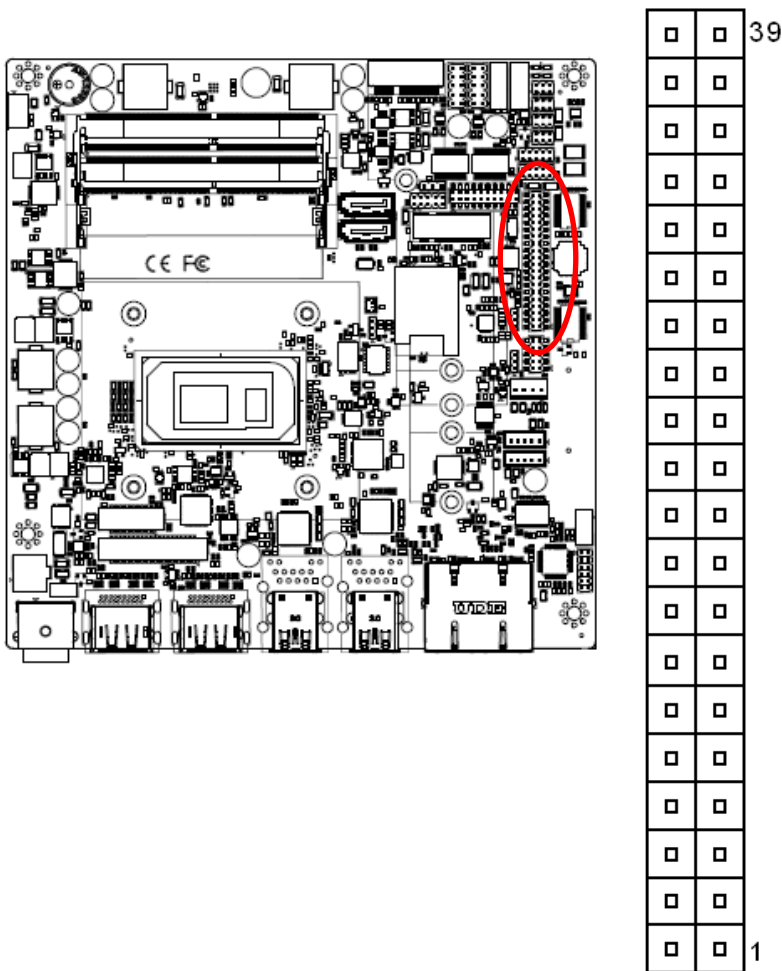

Signal	PIN	PIN	Signal
NC	40	39	COM_RI#_6
COM_CTS#_6	38	37	COM_RTS#_6
COM_DSR#_6	36	35	GND
COM_DTR#_6	34	33	COM_TXD_6
COM_RXD_6	32	31	COM_DCD#_6
NC	30	29	COM_RI#_5
COM_CTS#_5	28	27	COM_RTS#_5
COM_DSR#_5	26	25	GND
COM_DTR#_5	24	23	COM_TXD_5
COM_RXD_5	22	21	COM_DCD#_5
NC	20	19	COM_RI#_4
COM_CTS#_4	18	17	COM_RTS#_4
COM_DSR#_4	16	15	GND
COM_DTR#_4	14	13	COM_TXD_4
COM_RXD_4	12	11	COM_DCD#_4
NC	10	9	COM_RI#_3
COM_CTS#_3	8	7	COM_RTS#_3
COM_DSR#_3	6	5	GND
COM_DTR#_3	4	3	COM_TXD_3
COM_RXD_3	2	1	COM_DCD#_3

2.4.14 Serial Port 1/2 RS485/422 Mode connector (JRS485_1/2)

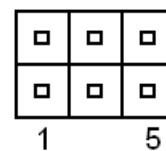
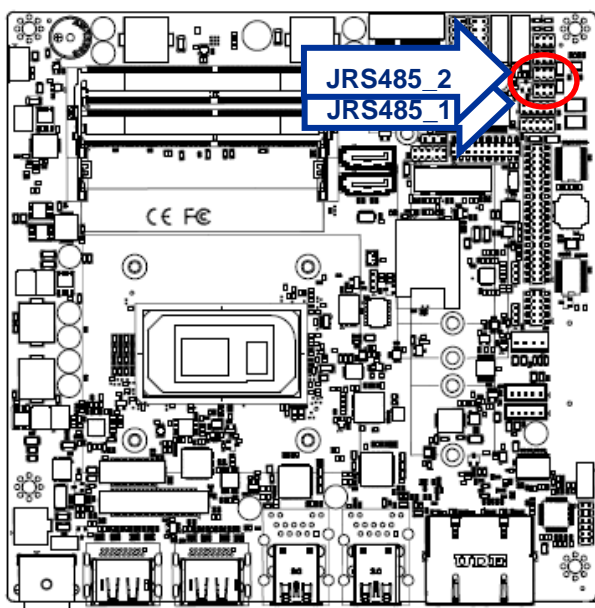

Signal	PIN	PIN	Signal
485_422TX-	1	2	422RX-
485_422TX+	3	4	422RX+
+5V	5	6	GND

2.4.15 SATA Power connector 1 (SPWR1)

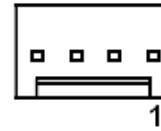
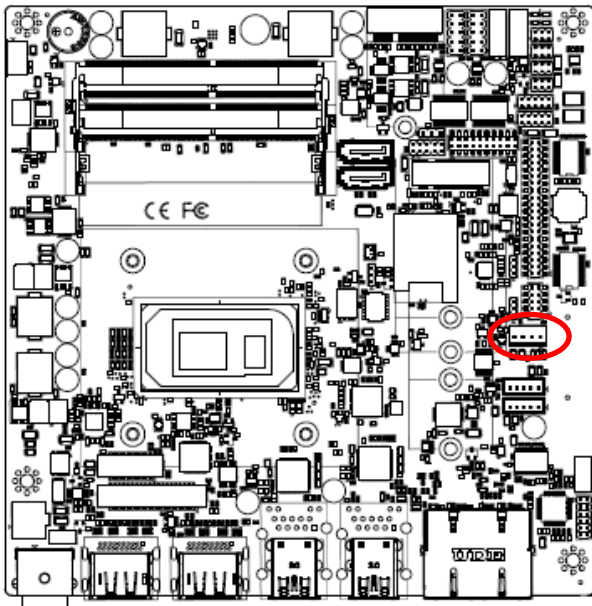

PIN	Signal
1	+V5S_SATA
2	GND
3	GND
4	+V12S_SATA

2.4.16 Power connector (PWR1)

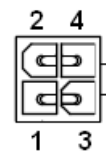
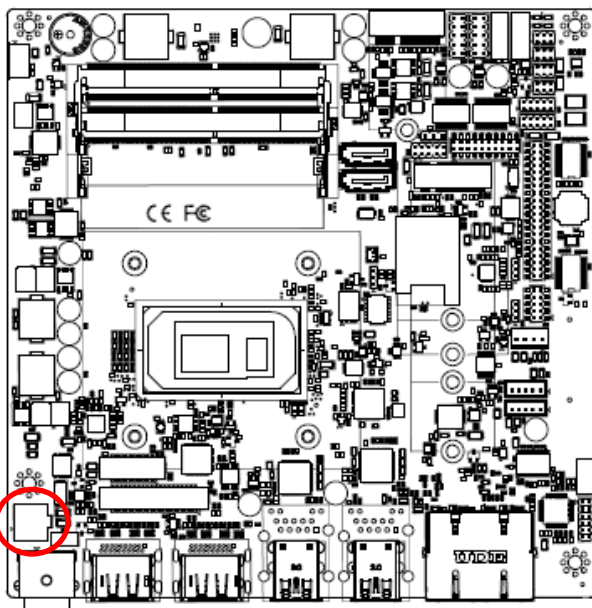

Signal	PIN	PIN	Signal
GND	2	4	+VIN
GND	1	3	+VIN

2.4.17 USB connector 3 (JUSB3)

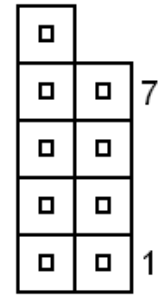
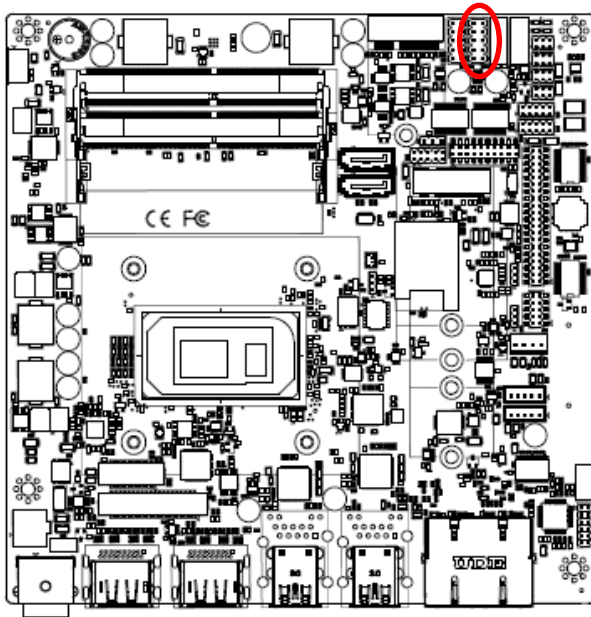

Signal	PIN	PIN	Signal
+V5A_USB56	1	2	+V5A_USB56
USB_DN5	3	4	USB_DN6
USB_DP5	5	6	USB_DP6
GND	7	8	GND
		10	GND

2.4.18 USB connector 4 (JUSB4)

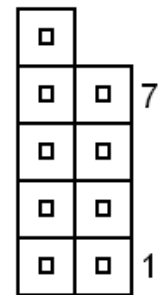
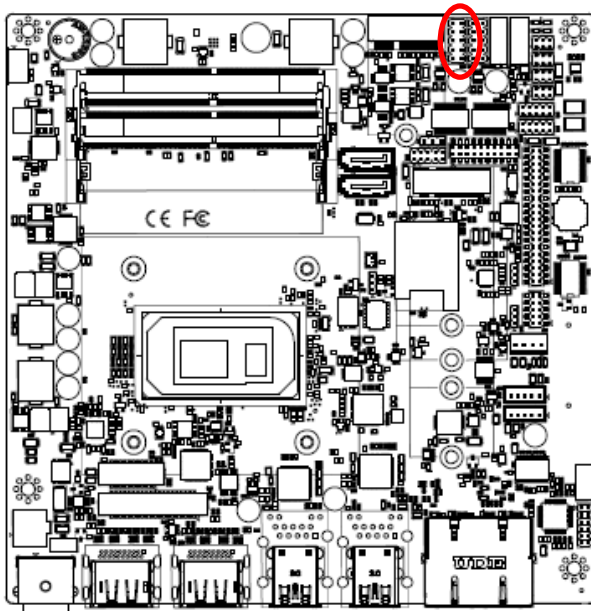

Signal	PIN	PIN	Signal
+V5A_USB78	1	2	+V5A_USB78
USB_DN7	3	4	USB2_DN8
USB_DP7	5	6	USB2_DP8
GND	7	8	GND
		10	GND

2.4.19 Speaker connector (SPK1)

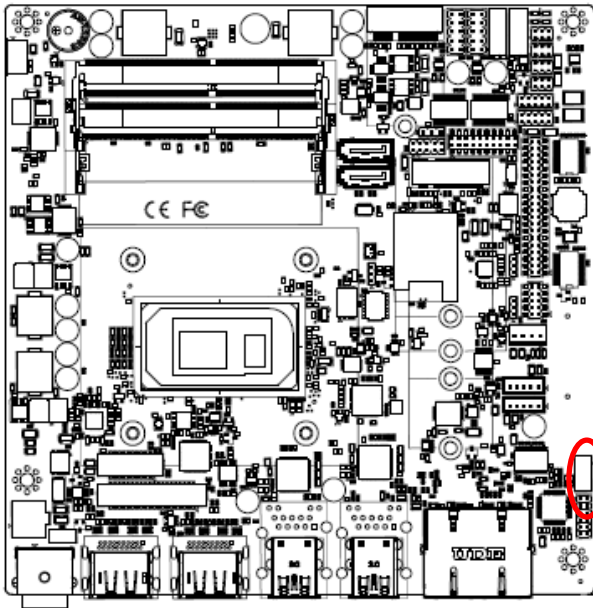

Signal	PIN
SPK_L+	1
SPK_L-	2
SPK_R+	3
SPK_R-	4

2.4.20 SPI connector (JSPI1)

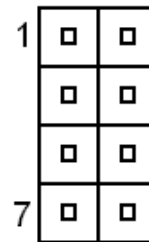
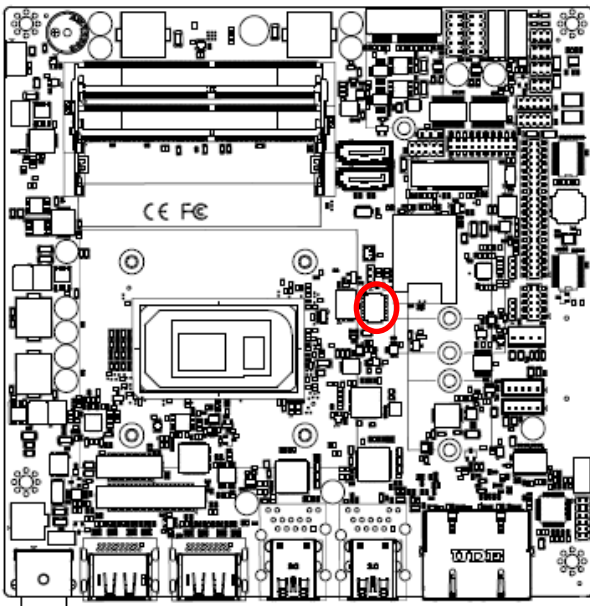

Signal	PIN	PIN	Signal
+V3.3A_1.8A_SPI	1	2	GND
SPI0_CS0#	3	4	SPI0_BIOS_CLK
SPI0_BIOS_MISO	5	6	SPI0_BIOS_MOSI
BIOS_HOLD#	7	8	BIOS_WP#

2.4.21 Battery connector (BT1)

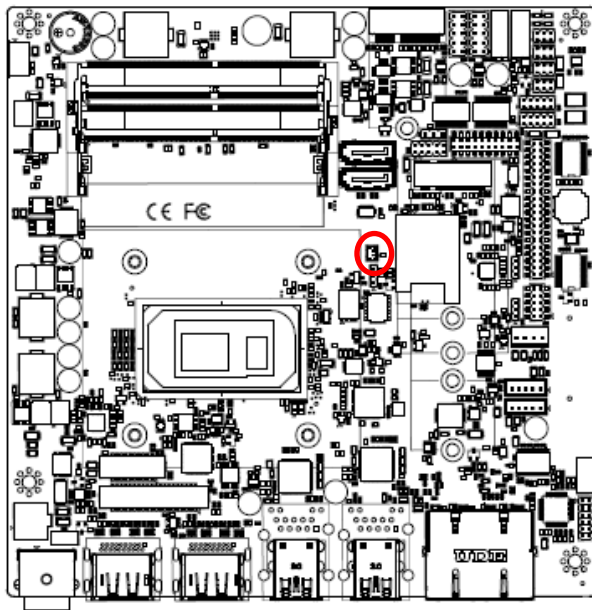

PIN	Signal
1	+RTCBAT
2	GND

2.4.22 Audio connector (JFAUD1)

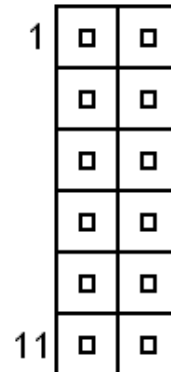
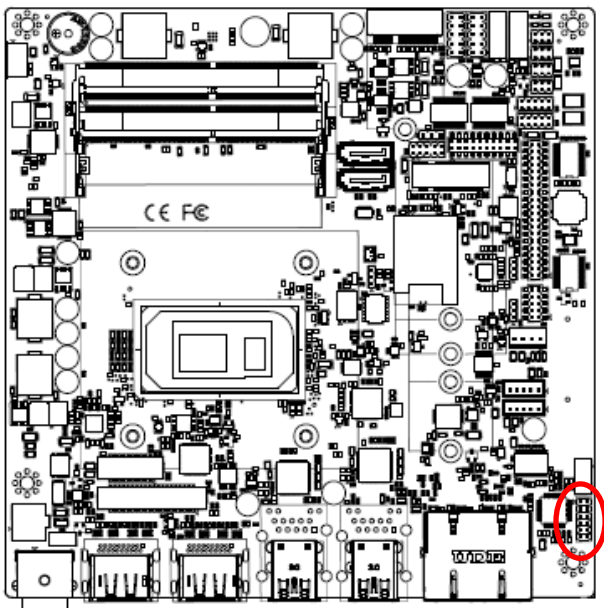

Signal	PIN	PIN	Signal
LINEOUT_R	1	2	LINEOUT_L
GND_AUD	3	4	GND_AUD
LINEIN_R	5	6	LINEIN_L
MICIN_R	7	8	MICIN_L
LINEOUT1_JD	9	10	LINE1-JD
MIC1_JD	11	12	GND_AUD

2.4.23 EC Debug (JEC_SPI)

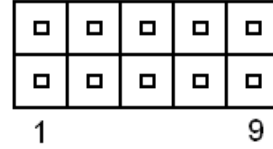
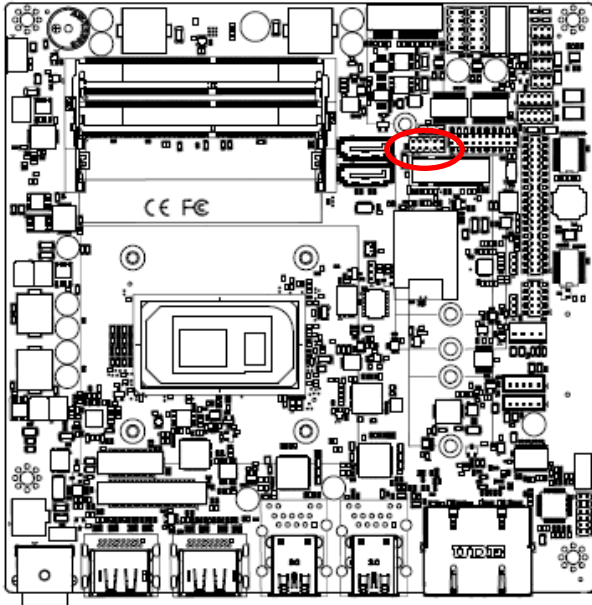

Signal	PIN	PIN	Signal
+V3.3A_EC	1	2	GND
EC_FSCE#	3	4	EC_FSCK
EC_FMISO	5	6	EC_FMOSI
EC_HOLD#	7	8	NC
EC_SMCLK_DEBUG	9	10	EC_SMDAT_DEBUG

2.4.24 Miscellaneous setting connector 1 (JFPT1)

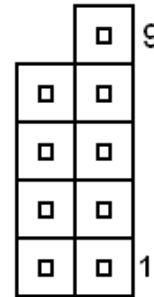
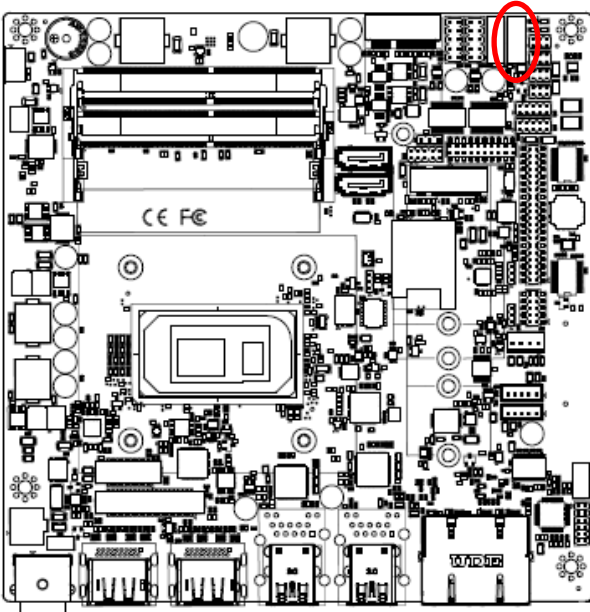

Signal	PIN	PIN	Signal
		9	NC
-PWR_BNT	8	7	-Reset
+PWR_BNT	6	5	+Reset
-PWR_LED	4	3	-HD_LED
+PWR_LED	2	1	+HD_LED

2.4.25 Miscellaneous setting connector 2 (FPT2)

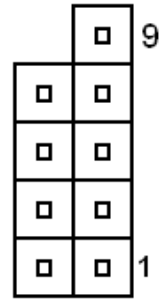
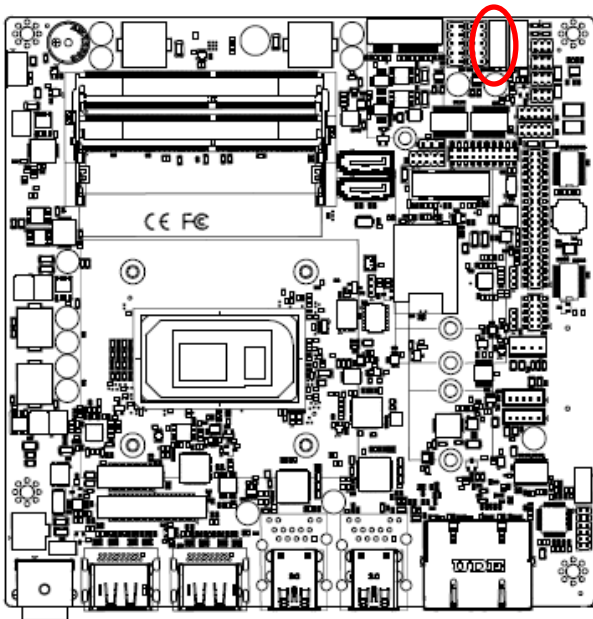

Signal	PIN	PIN	Signal
		9	NC
GND	8	7	Speaker-
BLK_DN	6	5	NC
BLK_UP	4	3	NC
BLK_VR(10K)	2	1	Speaker+

2.4.26 LPC connector (JLPC1)

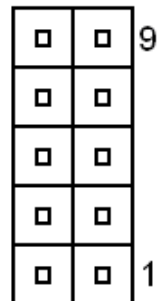
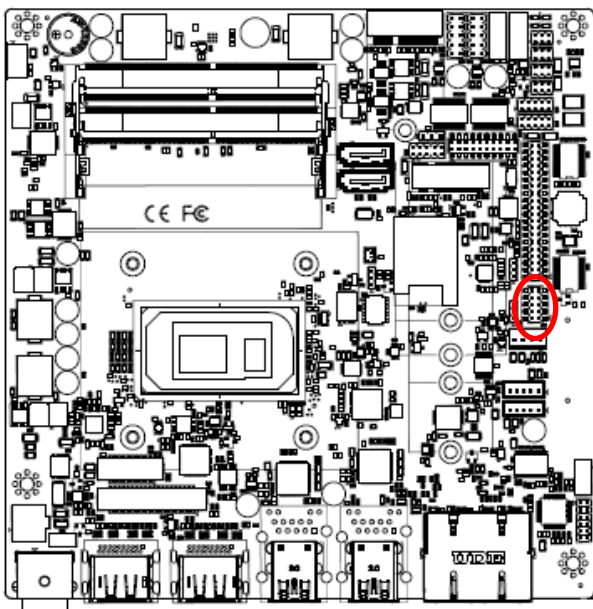

Signal	PIN	PIN	Signal
LPC_AD0	1	2	+3.3V
LPC_AD1	3	4	PLT_BUF_RST#
LPC_AD2	5	6	LPC_LFRAME#
LPC_AD3	7	8	CLK_24M_80
LPC_SERIRQ	9	10	GND

2.4.27 CPU fan connector (CPU_FAN1)

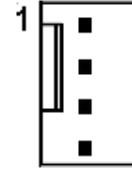
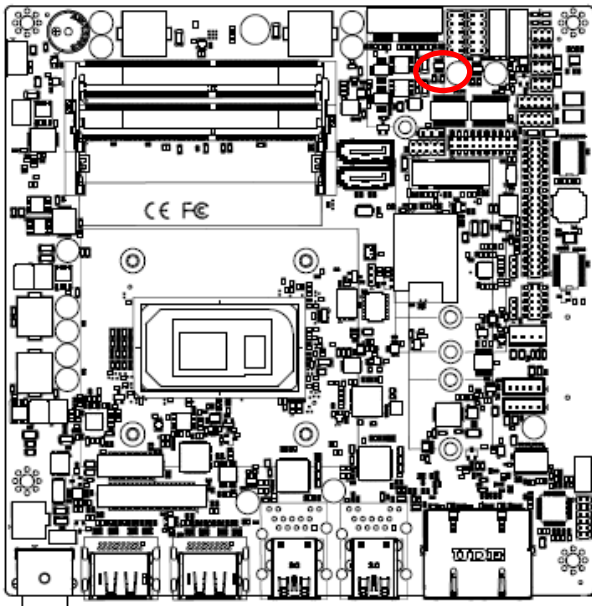

Signal	PIN
GND	1
+12V	2
CPU_FANIN	3
FAN_PWM0	4

3. BIOS Setup

3.1 Introduction

The BIOS setup program allows users to modify the basic system configuration. In this following chapter will describe how to access the BIOS setup program and the configuration options that may be changed.

3.2 Starting Setup

The AMI BIOS™ is immediately activated when you first power on the computer. The BIOS reads the system information contained in the NVRAM and begins the process of checking out the system and configuring it. When it finishes, the BIOS will seek an operating system on one of the disks and then launch and turn control over to the operating system.

While the BIOS is in control, the Setup program can be activated in one of two ways:

By pressing or <F2> immediately after switching the system on, or

By pressing the or <F2> key when the following message appears briefly at the left-top of the screen during the POST (Power On Self Test).

Press or <F2> to enter SETUP

If the message disappears before you respond and you still wish to enter Setup, restart the system to try again by turning it OFF then ON or pressing the "RESET" button on the system case. You may also restart by simultaneously pressing <Ctrl>, <Alt>, and <Delete> keys. If you do not press the keys at the correct time and the system does not boot, an error message will be displayed and you will again be asked to.

Press F1 to Continue, DEL to enter SETUP

3.3 Using Setup

In general, you use the arrow keys to highlight items, press <Enter> to select, use the PageUp and PageDown keys to change entries, press <F1> for help and press <Esc> to quit. The following table provides more detail about how to navigate in the Setup program using the keyboard.

Button	Description
↑↓→←	Move
Enter	Select
+/-	Value
Esc	Exit
F1	General Help
F2	Previous Values
F3	Optimized Defaults
F4	Save & Exit Setup
<K>	Scroll help area upwards
<M>	Scroll help area downwards

- **Navigating Through The Menu Bar**

Use the left and right arrow keys to choose the menu you want to be in.



Note: Some of the navigation keys differ from one screen to another.

- **To Display a Sub Menu**

Use the arrow keys to move the cursor to the sub menu you want. Then press <Enter>. A “>” pointer marks all sub menus.

3.4 Getting Help

Press F1 to pop up a small help window that describes the appropriate keys to use and the possible selections for the highlighted item. To exit the Help Window press <Esc> or <Enter> key.

3.5 In Case of Problems

If, after making and saving system changes with Setup, you discover that your computer no longer is able to boot, the AMI BIOS supports an override to the NVRAM settings which resets your system to its defaults.

The best advice is to only alter settings which you thoroughly understand. To this end, we strongly recommend that you avoid making any changes to the chipset defaults. These defaults have been carefully chosen by both BIOS Vendor and your systems manufacturer to provide the absolute maximum performance and reliability. Even a seemingly small change to the chipset setup has the potential for causing you to use the override.

3.6 BIOS setup

Once you enter the Aptio Setup Utility, the Main Menu will appear on the screen. The Main Menu allows you to select from several setup functions and exit choices. Use the arrow keys to select among the items and press <Enter> to accept and enter the sub-menu.

3.6.1 Main Menu

This section allows you to record some basic hardware configurations in your computer and set the system clock.

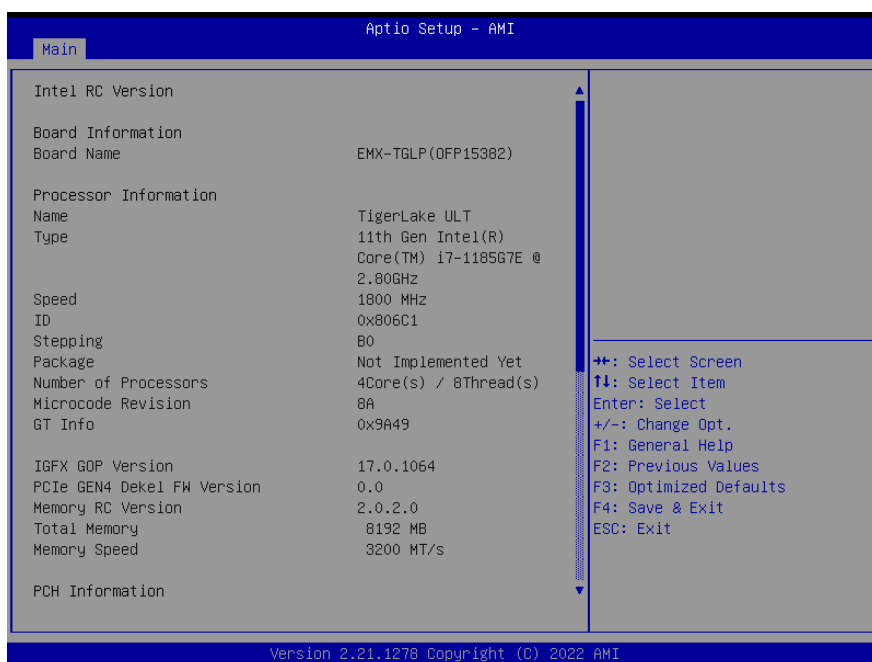
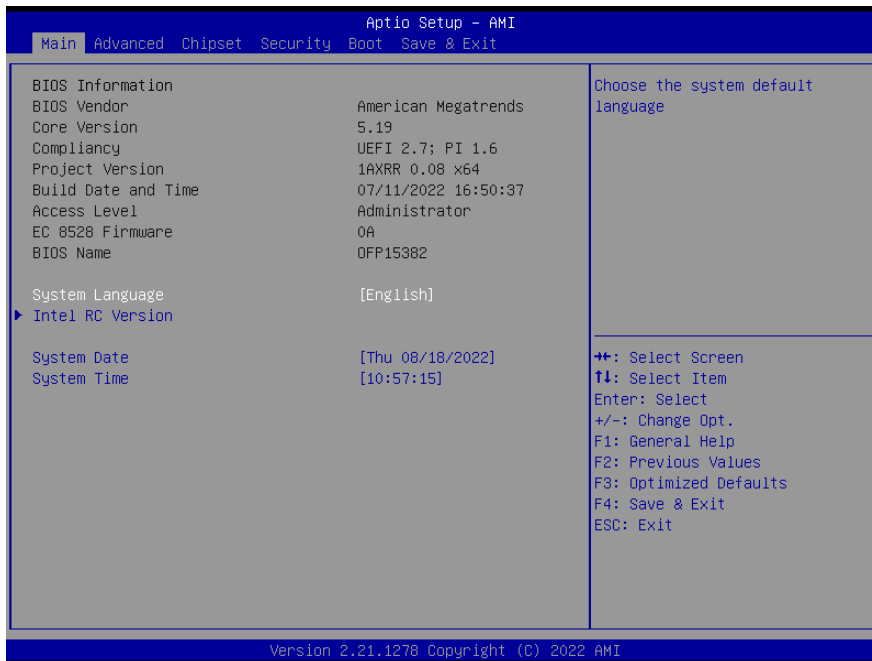

3.6.1.1 System Language

This option allows choosing the system default language.

3.6.1.2 System Date

Use the system date option to set the system date. Manually enter the day, month and year.

3.6.1.3 System Time

Use the system time option to set the system time. Manually enter the hours, minutes and seconds.



Note: The BIOS setup screens shown in this chapter are for reference purposes only, and may not exactly match what you see on your screen. Visit the Avalue website (www.avalue.com.tw) to download the latest product and BIOS information.

3.6.2 Advanced Menu

This section allows you to configure your CPU and other system devices for basic operation through the following sub-menus.

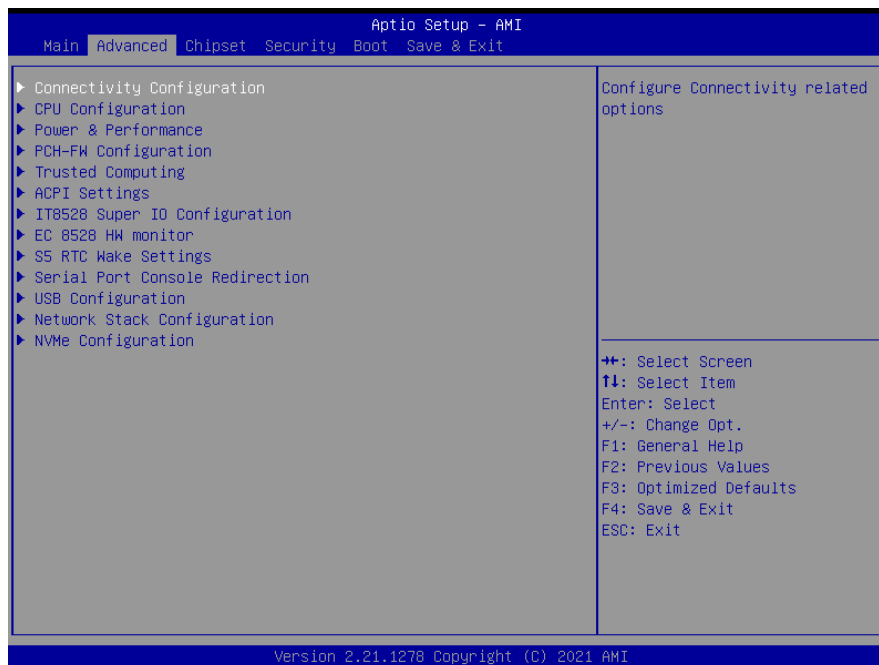

3.6.2.1 Connectivity Configuration



Item	Options	Description
CNVi Mode	Disable Integrated[Default] Auto Detection	This option configures Connectivity. [Auto Detection] means that if Discrete solution is discovered it will be enabled by default. Otherwise Integrated solution (CNVi) will be enabled; [Disable Integrated] disables Integrated Solution. NOTE: When CNVi is present, the GPIO pins that are used for radio

3.6.2.2 CPU Configuration



Item	Options	Description
Intel (VMX) Virtualization Technology	Disabled Enabled[Default],	When enabled, a VMM can utilize the additional hardware capabilities provided by Vanderpool Technology.
Active Processor Cores	All[Default], 1 2 3	Number of cores to enable in each processor package.

3.6.2.3 Power & Performance

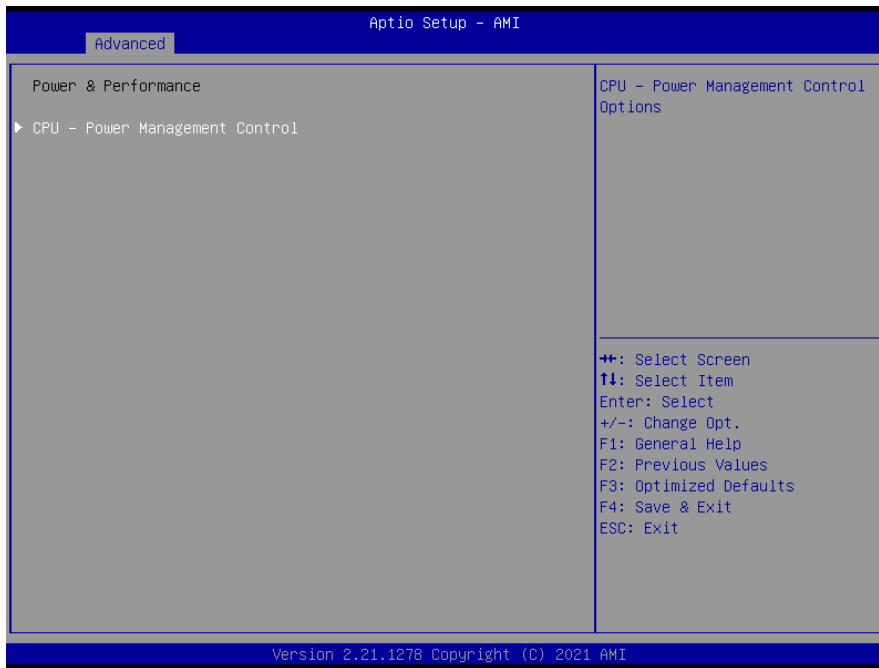

3.6.2.3.1 CPU - Power Management Control

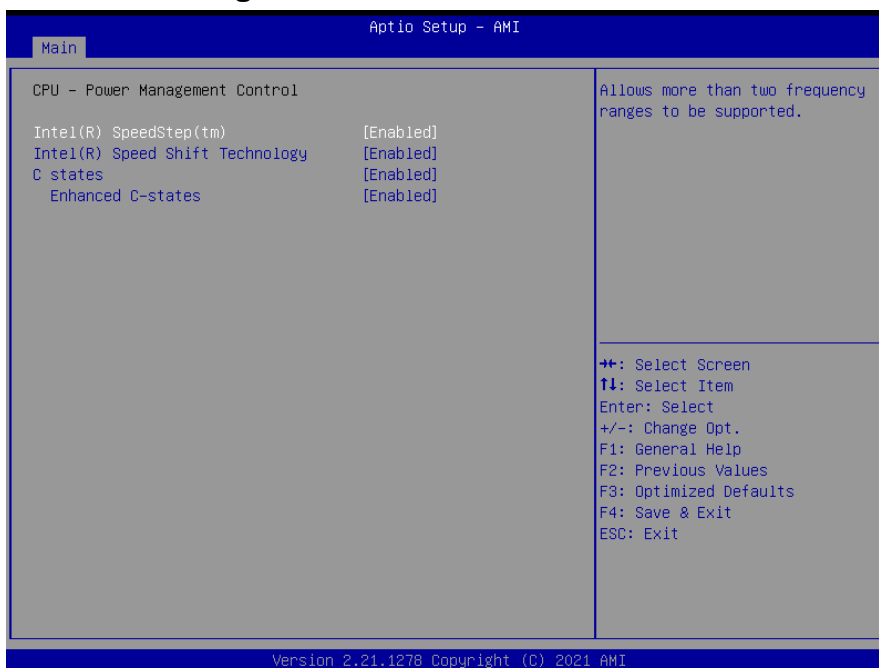

Item	Options	Description
Intel(R) SpeedStep(tm)	Disabled Enabled[Default],	Allows more than two frequency ranges to be supported.
Intel(R) Speed Shift Technology	Disabled Enabled[Default],	Enable/Disable Intel(R) Speed Shift Technology support. Enabling will expose the CPPC v2 interface to allow for hardware controlled P-states.
C states	Disabled Enabled[Default],	Enable/Disable CPU Power Management. Allows CPU to go to C states when it's not 100% utilized.
Enhanced C-states	Disabled Enabled[Default],	Enable/Disable C1E. When enabled, CPU will switch to minimum speed when all cores enter C-State.

3.6.2.4 PCH-FW Configuration

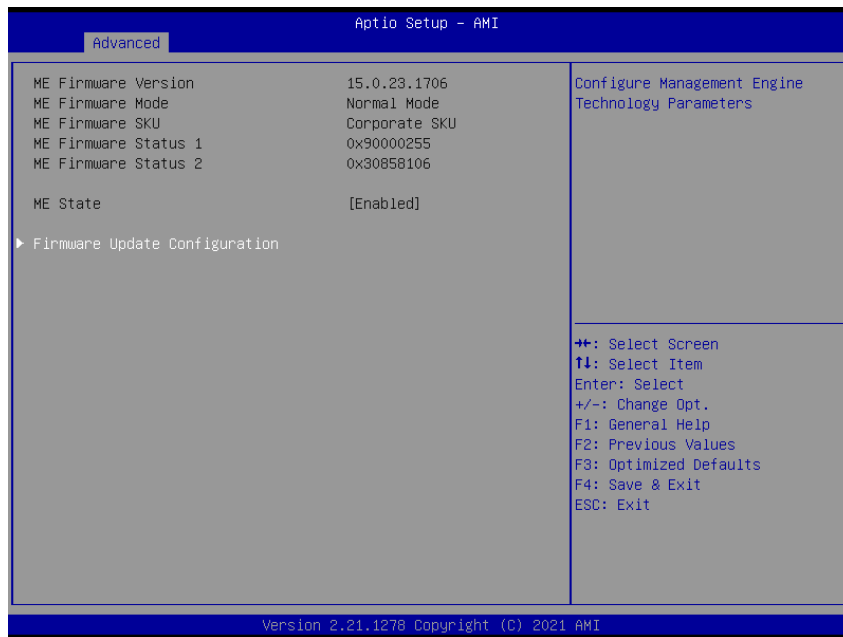

3.6.2.4.1 Firmware Update Configuration



Item	Options	Description
Me FW Image Re-Flash	Disabled[Default], Enabled	Enable/Disable Me FW Image Re-Flash function.

3.6.2.5 Trusted Computing



Item	Options	Description
Security Device Support	Disabled Enabled[Default],	Enables or Disables BIOS support for security device. O.S. will not show Security Device. TCG EFI protocol and INT1A interface will not be available.

3.6.2.6 ACPI Settings

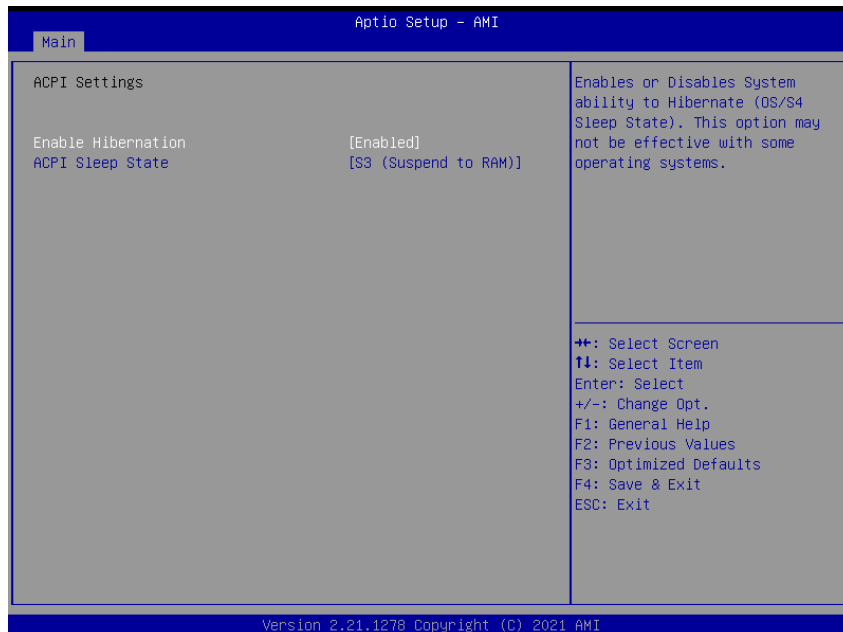

Item	Options	Description
Enable Hibernation	Disabled Enabled[Default],	Enables or Disables System ability to Hibernate (OS/S4 Sleep State). This option may be not effective with some OS.
ACPI Sleep State	Suspend Disabled, S3 (Suspend to RAM)[Default]	Select the highest ACPI sleep state the system will enter when the SUSPEDN button is pressed.

3.6.2.7 IT8528 Super IO Configuration

You can use this item to set up or change the IT8528 Super IO configuration for serial ports. Please refer to 3.6.2.7.1~ 3.6.2.7.5 for more information.



Item	Description
Serial Port 1 Configuration	Set Parameters of Serial Port 1 (COMA).
Serial Port 2 Configuration	Set Parameters of Serial Port 2 (COMB).
Serial Port 3 Configuration	Set Parameters of Serial Port 3 (COMC).
Serial Port 4 Configuration	Set Parameters of Serial Port 4 (COMD).
Serial Port 5 Configuration	Set Parameters of Serial Port 5 (COME).

3.6.2.7.1 Serial Port 1 Configuration

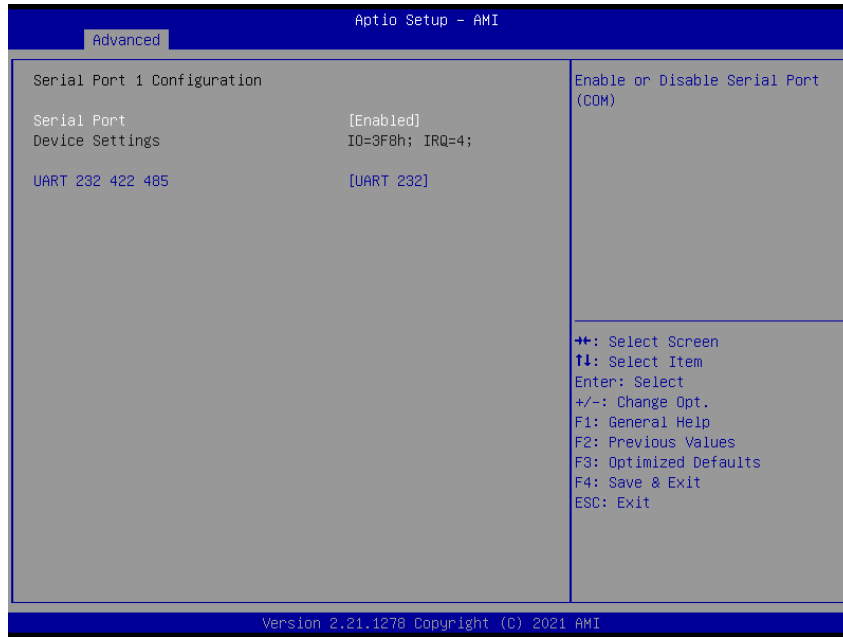

Item	Option	Description
Serial Port	Disabled Enabled[Default],	Enable or Disable Serial Port (COM).
UART 232 422 485	UART 232[Default], UART 422, UART 485	Change the Serial Port as RS232/422/485.

3.6.2.7.2 Serial Port 2 Configuration

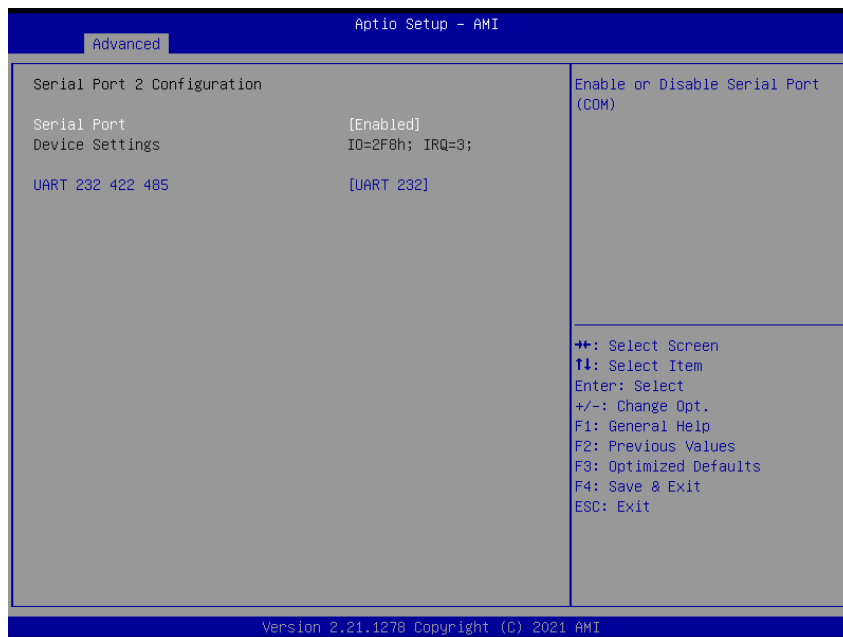

Item	Option	Description
Serial Port	Disabled Enabled[Default],	Enable or Disable Serial Port (COM).
UART 232 422 485	UART 232[Default], UART 422, UART 485	Change the Serial Port as RS232/422/485.

3.6.2.7.3 Serial Port 3 Configuration

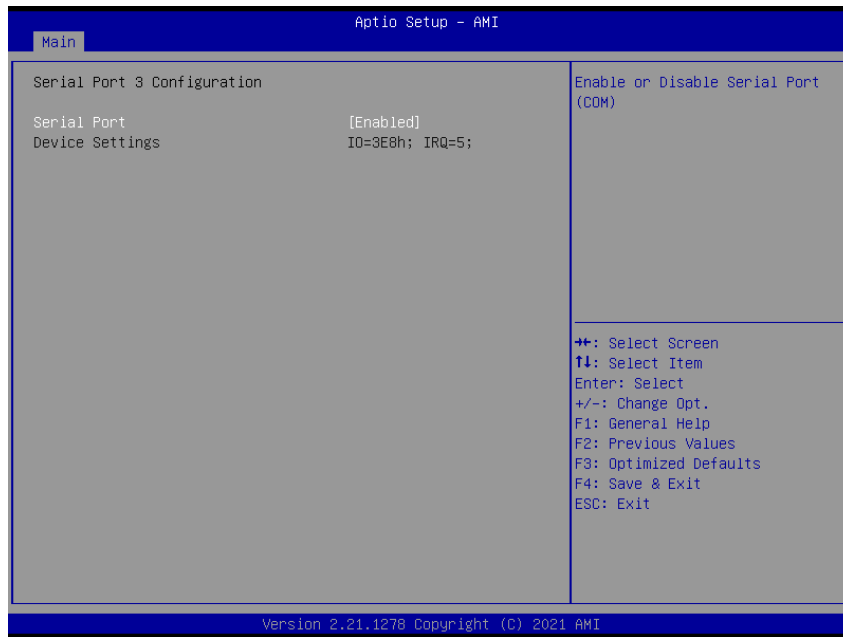

Item	Option	Description
Serial Port	Enabled[Default], Disabled	Enable or Disable Serial Port (COM).

3.6.2.7.4 Serial Port 4 Configuration



OFP-15W38

Item	Option	Description
Serial Port	Enabled[Default], Disabled	Enable or Disable Serial Port (COM).

3.6.2.7.5 Serial Port 5 Configuration

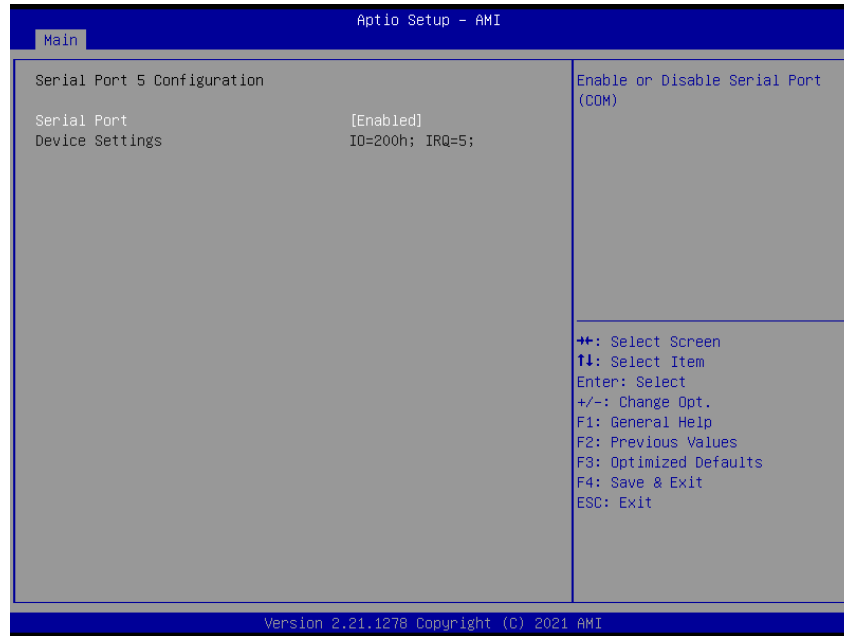

Item	Option	Description
Serial Port	Enabled[Default], Disabled	Enable or Disable Serial Port (COM).

3.6.2.8 EC 8528 H/W monitor

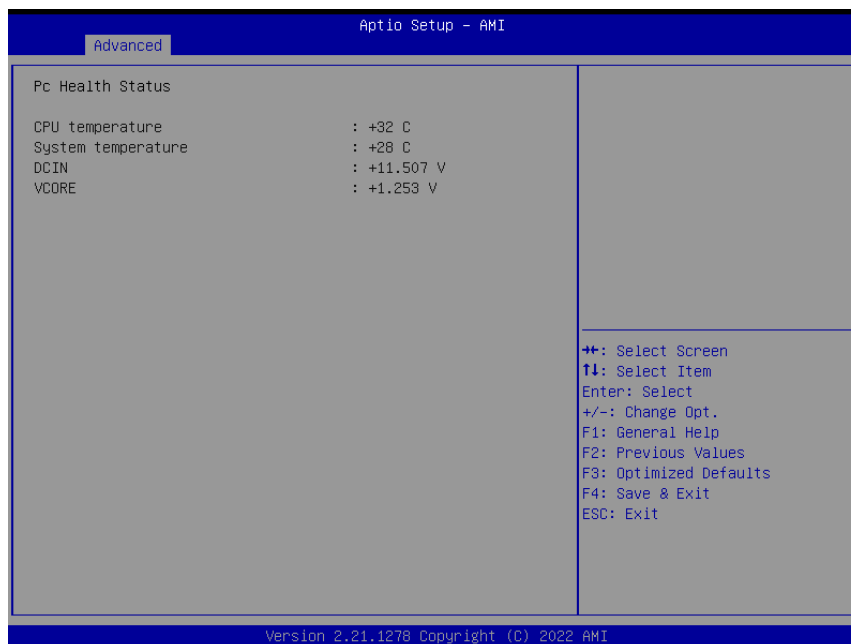

3.6.2.9 S5 RTC Wake Settings



Item	Options	Description
Wake system from S5	Disabled[Default], Fixed Time Dynamic Time	Enable or disable System wake on alarm event. Select FixedTime, system will wake on the hr::min::sec specified. Select DynamicTime, System will wake on the current time + Increase minutes(s).

3.6.2.10 Serial Port Console Redirection



Item	Options	Description
Console Redirection	Disabled[Default], Enabled	Console Redirection Enable or Disable.

Console Redirection EMS	Disabled[Default], Enabled	Console Redirection Enable or Disable.
--------------------------------	-------------------------------	--

3.6.2.10.1 Legacy Console Redirection Settings

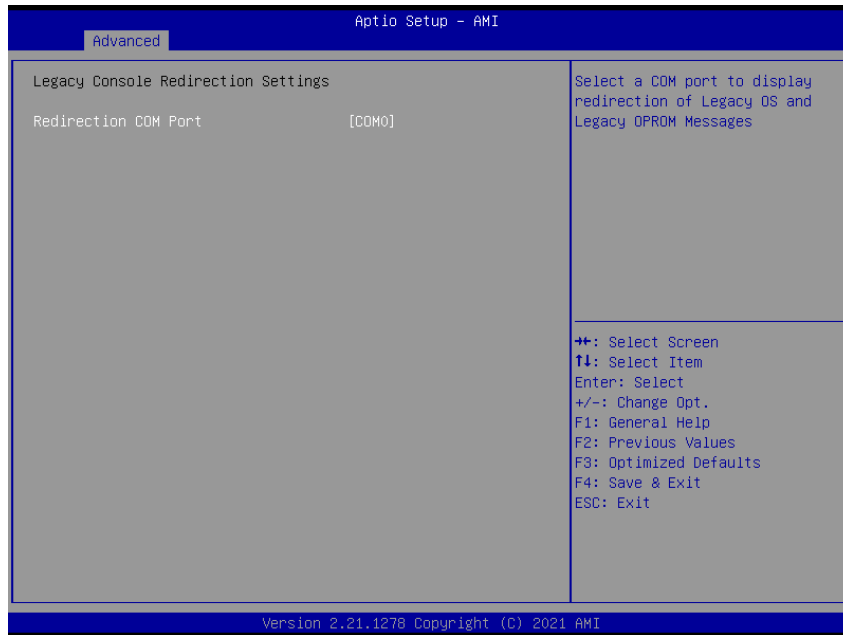

Item	Options	Description
Redirection COM Port	COM0	Select a COM port to display redirection of Legacy OS and Legacy OPROM Messages

3.6.2.11 USB Configuration

The USB Configuration menu helps read USB information and configures USB settings.

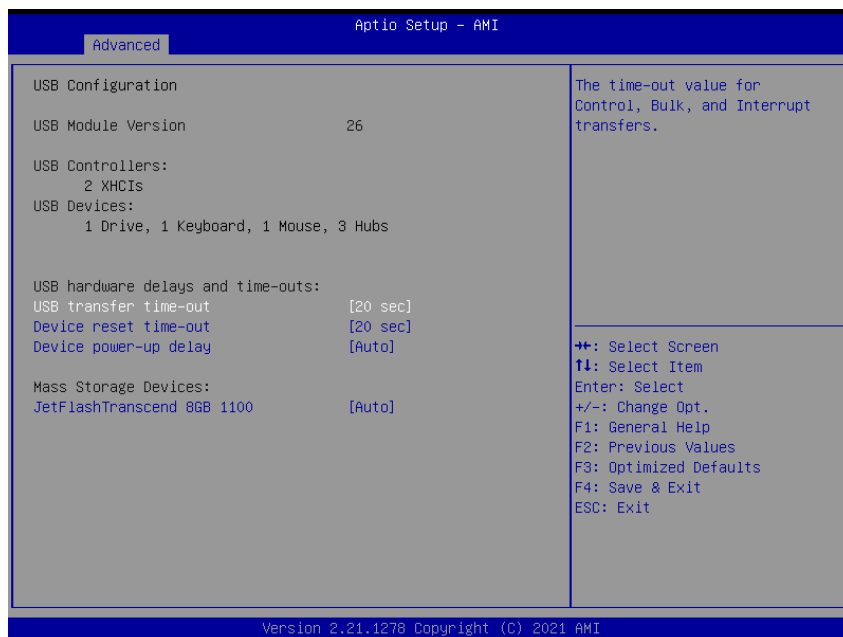

Item	Options	Description
USB transfer time-out	1 sec 5 sec 10 sec	The time-out value for Control, Bulk, and Interrupt transfers.

	20 sec[Default]	
Device reset time-out	10 sec 20 sec[Default] 30 sec 40 sec	USB mass storage device Start Unit command time-out.
Device power-up delay	Auto[Default] Manual	Maximum time the device will take before it properly reports itself to the Host Controller. 'Auto' uses default value: for a Root port it is 100ms, for a Hub port the delay is taken form Hub descriptor.
Mass Storage Devices	Auto[Default] Floppy Forced FDD Hard Disk CD-ROM	Mass storage device emulation type. 'AUTO' enumerates devices according to their media format. Optical drives are emulated as 'CDROM', drives with no media will be emulated according to a drive type.

3.6.2.12 Network Stack Configuration



Item	Options	Description
Network Stack	Enabled Disabled[Default]	Enable/Disable UEFI Network Stack.

3.6.2.13 NVMe Configuration

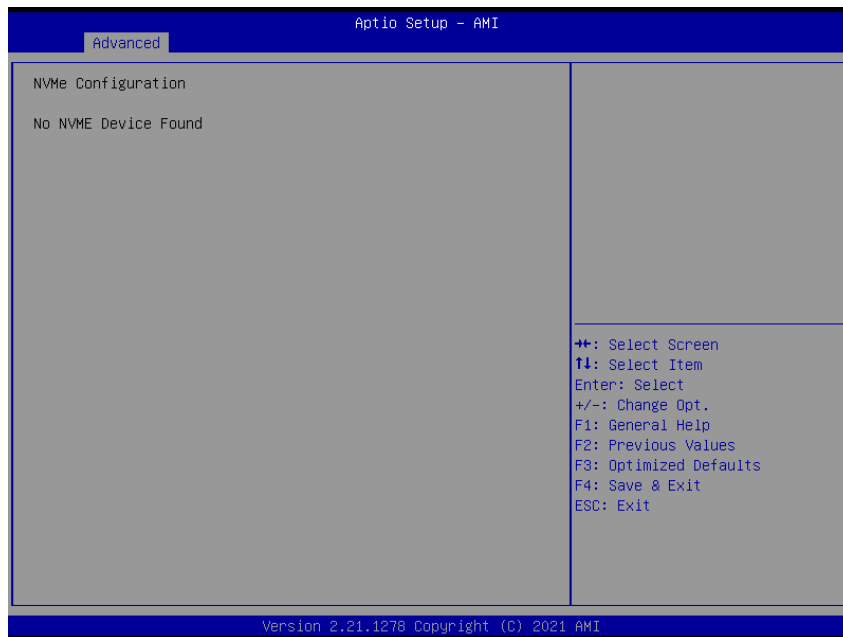

3.6.3 Chipset

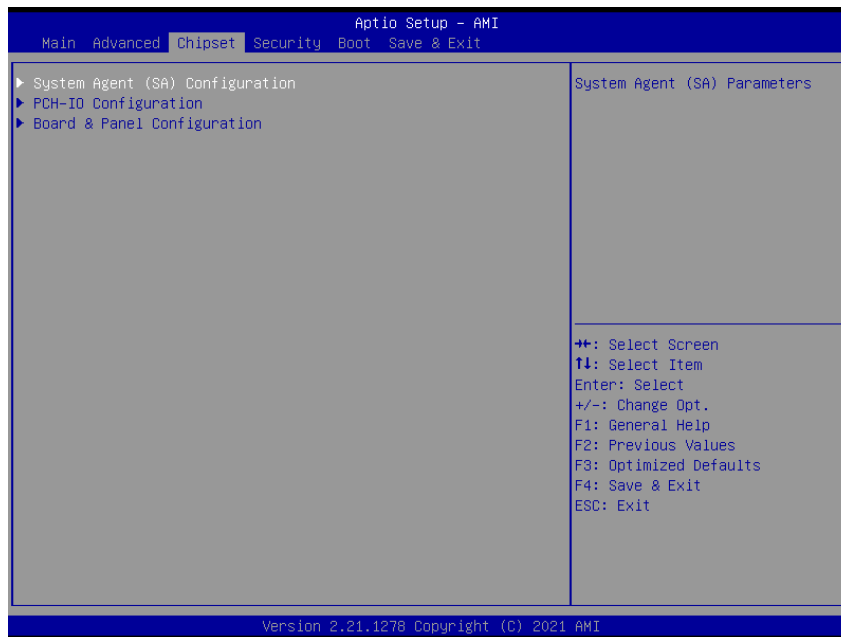

3.6.3.1 System Agent (SA) Configuration

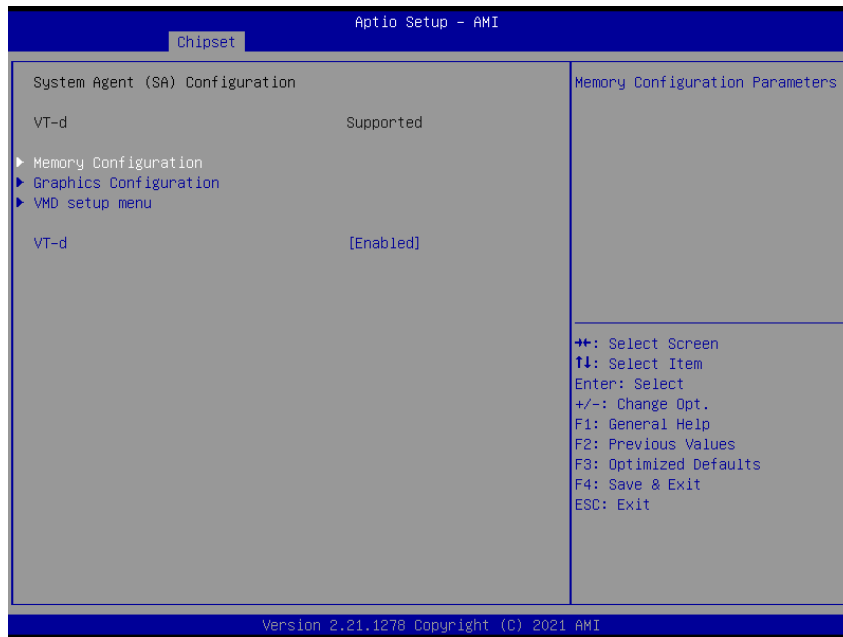

Item	Option	Description
VT-d	Disabled Enabled[Default]	VT-d capability.

3.6.3.1.1 Memory Configuration

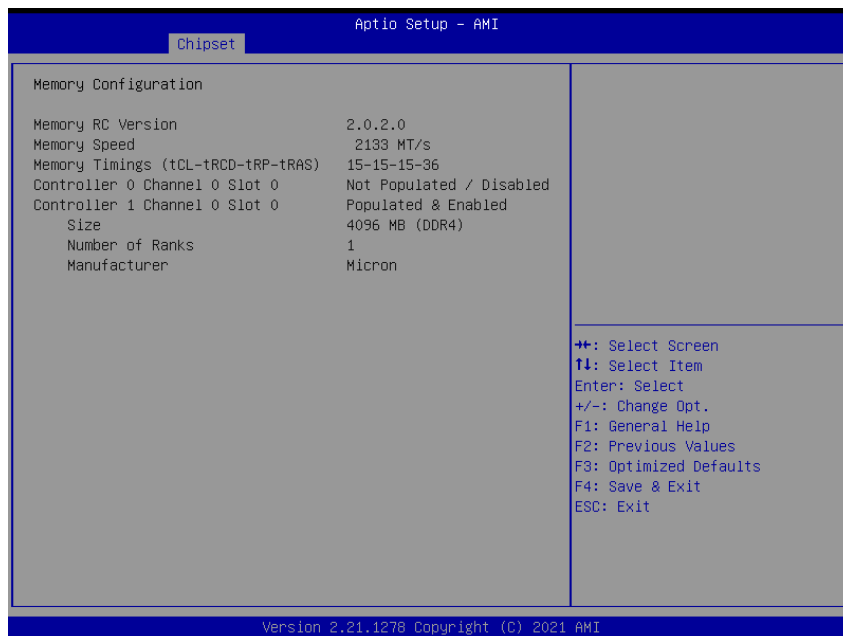

3.6.3.1.2 Graphics Configuration

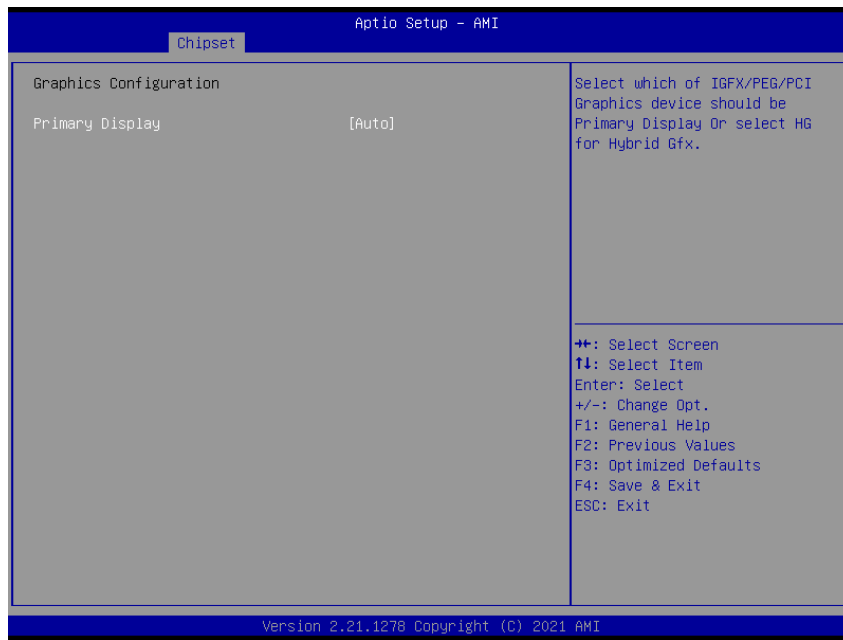

Item	Option	Description
Primary Display	Auto[Default] IGFX	Select which of IGFX/PEG/PCI Graphics device should be Primary Display Or select HG for Hybrid Gfx.

3.6.3.1.3 VMD Configuration

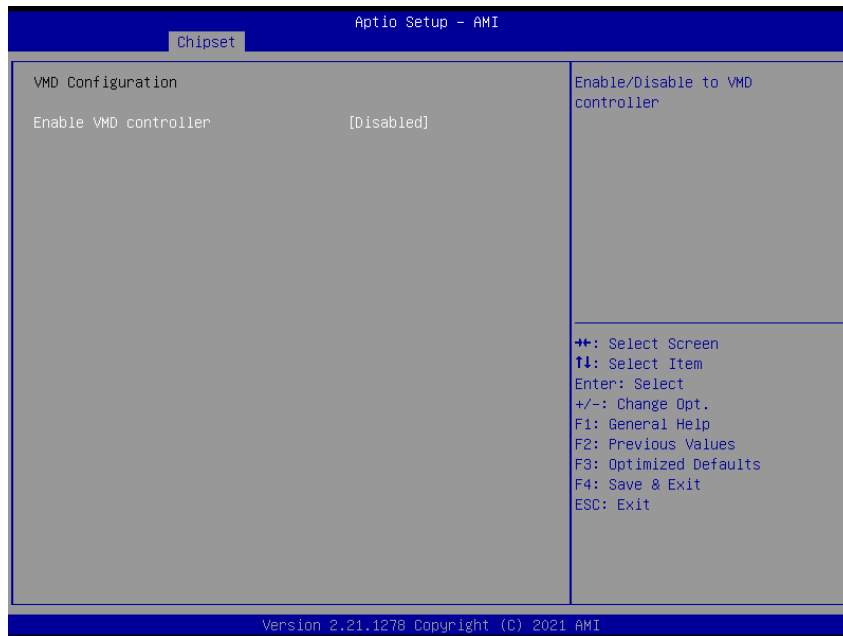

Item	Option	Description
Enable VMD controller	Disabled[Default] Enabled	Enable/Disable to VMD controller

3.6.3.2 PCH-IO Configuration



Item	Option	Description
PCH LAN Controller	Enabled[Default] Disabled	Enable/Disable onboard NIC.

3.6.3.2.1 PCI Express Configuration

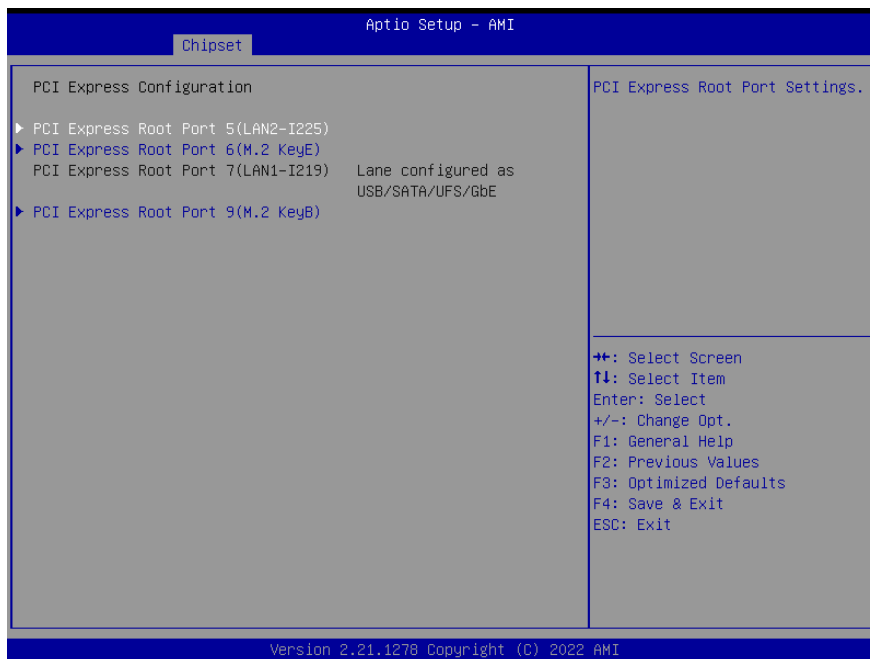

3.6.3.2.1.1 PCI Express Root Port 5(LAN2-I225)

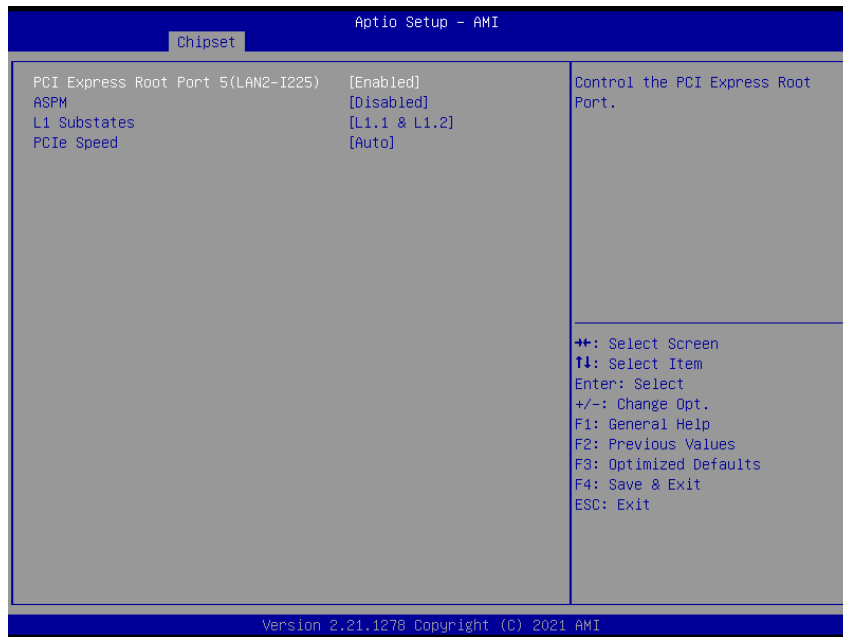

Item	Option	Description
PCI Express Root Port 5(LAN2-I225)	Disabled Enabled [Default] ,	Control the PCI Express Root Port.
ASPM	Disabled [Default] L0s L1 L0sL1 Auto	Set the ASPM Level: Force L0s – Force all links to L0s State AUTO – BIOS auto configure DISABLE – Disables ASPM.
L1 Substates	Disabled L1.1 L1.1 & L1.2 [Default] ,	PCI Express L1 Substates settings.
PCIe Speed	Auto [Default] Gen1 Gen2 Gen3	Select PCIe speed.

3.6.3.2.1.2 PCI Express Root Port 6(M.2 KeyE)

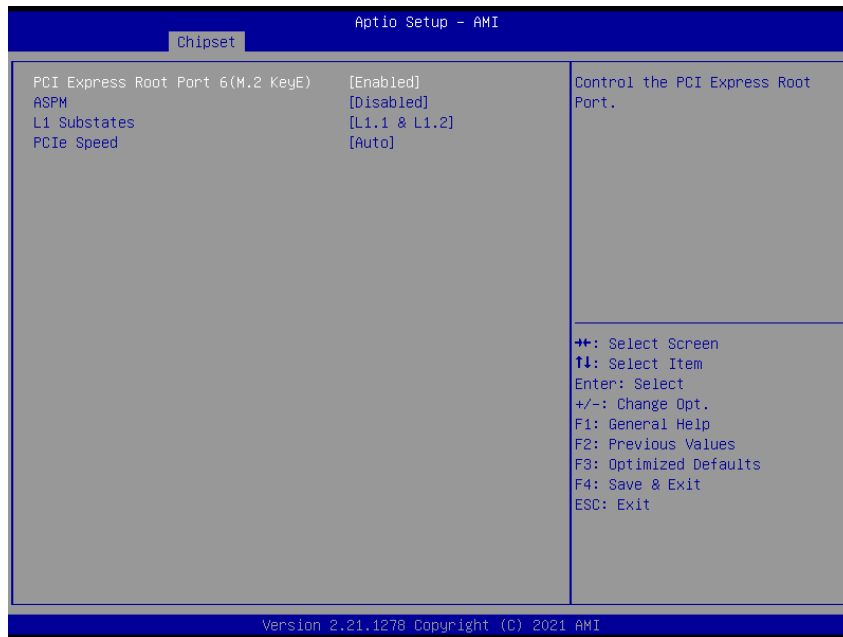

Item	Option	Description
PCI Express Root Port 6(M.2 KeyE)	Disabled Enabled [Default] ,	Control the PCI Express Root Port.
ASPM	Disabled [Default] L0s L1 L0sL1 Auto	Set the ASPM Level: Force L0s – Force all links to L0s State AUTO – BIOS auto configure DISABLE – Disables ASPM.
L1 Substates	Disabled L1.1 L1.1 & L1.2 [Default] ,	PCI Express L1 Substates settings.
PCIe Speed	Auto [Default] Gen1 Gen2 Gen3	Select PCIe speed.

3.6.3.2.1.3 PCI Express Root Port 9(M.2 KeyB)



Item	Option	Description
PCI Express Root Port 9 (M.2 KeyB)	Disabled Enabled [Default] ,	Control the PCI Express Root Port.
ASPM	Disabled [Default] L0s L1 L0sL1 Auto	Set the ASPM Level: Force L0s – Force all links to L0s State AUTO – BIOS auto configure DISABLE – Disables ASPM.
L1 Substates	Disabled L1.1 L1.1 & L1.2 [Default] ,	PCI Express L1 Substates settings.
PCIe Speed	Auto [Default] Gen1 Gen2 Gen3	Select PCIe speed.

3.6.3.2.2 SATA And RST Configuration

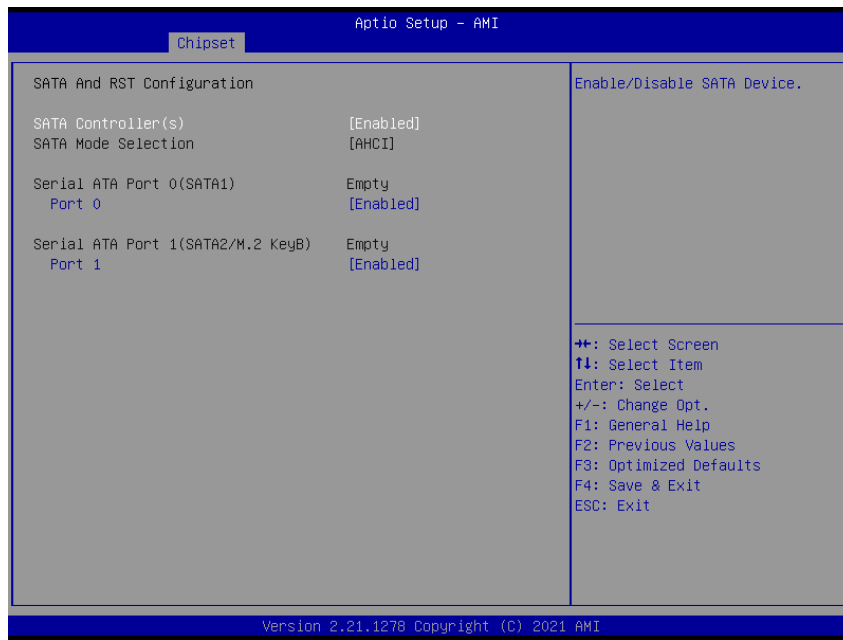

Item	Option	Description
SATA Controller(s)	Disabled Enabled[Default],	Enable/Disable SATA Device.
Port 0	Disabled Enabled[Default],	Enable or Disable SATA Port
Port 1	Disabled Enabled[Default],	Enable or Disable SATA Port

3.6.3.2.3 HD Audio Configuration



Item	Option	Description
HD Audio	Disabled Enabled[Default],	Control Detection of the HD-Audio device. Disable = HDA will be unconditionally disabled Enabled = HDA will be unconditionally enabled.

3.6.3.3 Board & Panel Configuration

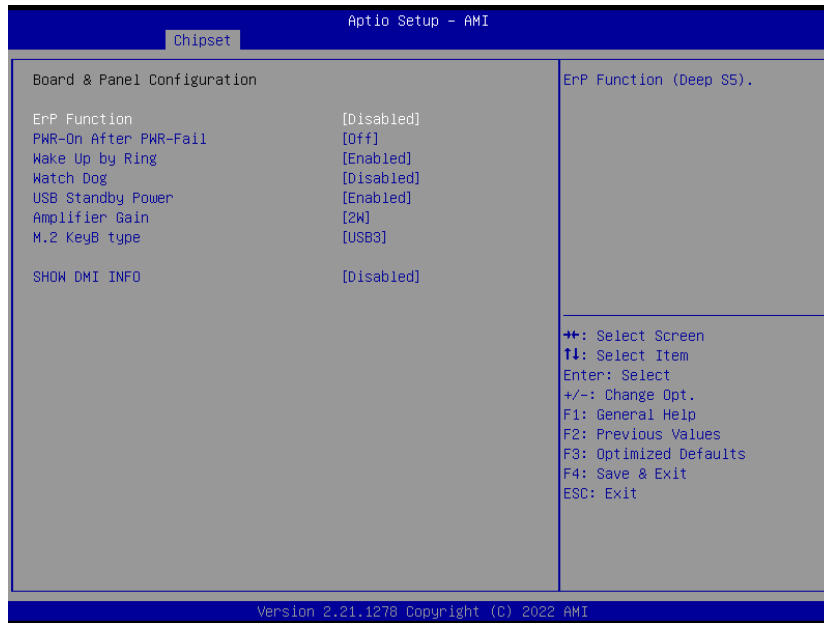

Item	Option	Description
ErP Function	Disabled[Default], Enabled	ErP Function (Deep S5).
PWR-On After PWR-Fail	Off[Default], On Last State	AC loss resume.
Wake Up by Ring	Disabled Enabled[Default],	Wake Up by Ring from S3/S4/S5
Watch Dog	Disabled[Default], 30 sec 40 sec 50 sec 1 min 2 min 10 min 30 min	Select WatchDog.
USB Standby Power	Disabled Enabled[Default],	Enabled/Disabled USB Standby Power during S3/S4/S5
Amplifier Gain	2W[Default], 6W	Amplifier Gain
M.2 KeyB type	USB3[Default], PCIE	M.2 KeyB type
SHOW DMI INFO	Disabled[Default], Enabled	SHOW DMI INFO

3.6.4 Security

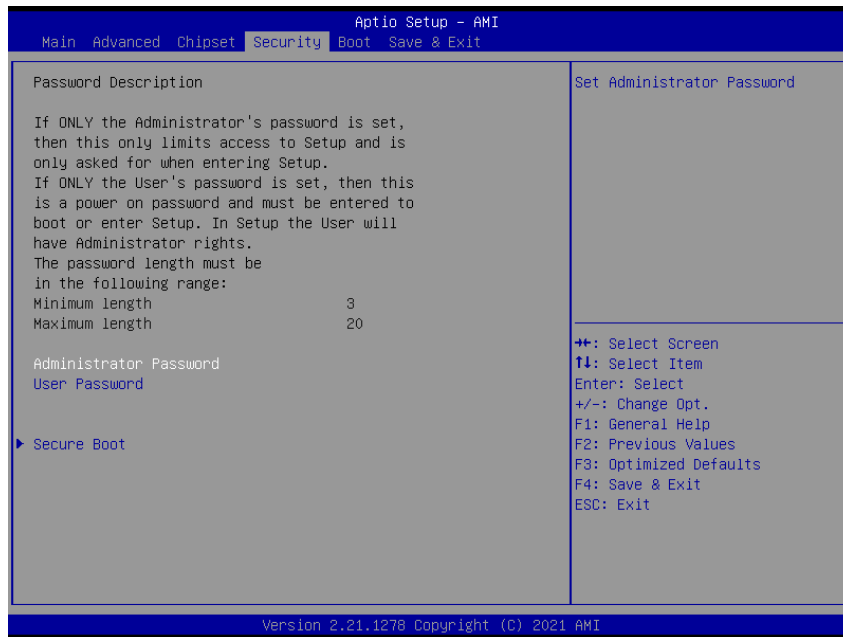

- **Administrator Password**

Set setup Administrator Password

- **User Password**

Set User Password

3.6.4.1 Secure Boot menu



Item	Option	Description
Secure Boot	Disabled Enabled[Default]	Secure Boot feature is Active if Secure Boot is Enabled, Platform Key(PK) is enrolled and the System is in User mode. The mode change requires platform reset
Secure Boot Mode	Standard[Default] Custom	Secure Boot mode options: Standard or Custom. In Custom mode, Secure Boot Policy variables can be configured by a physically present user without full authentication

3.6.5 Boot

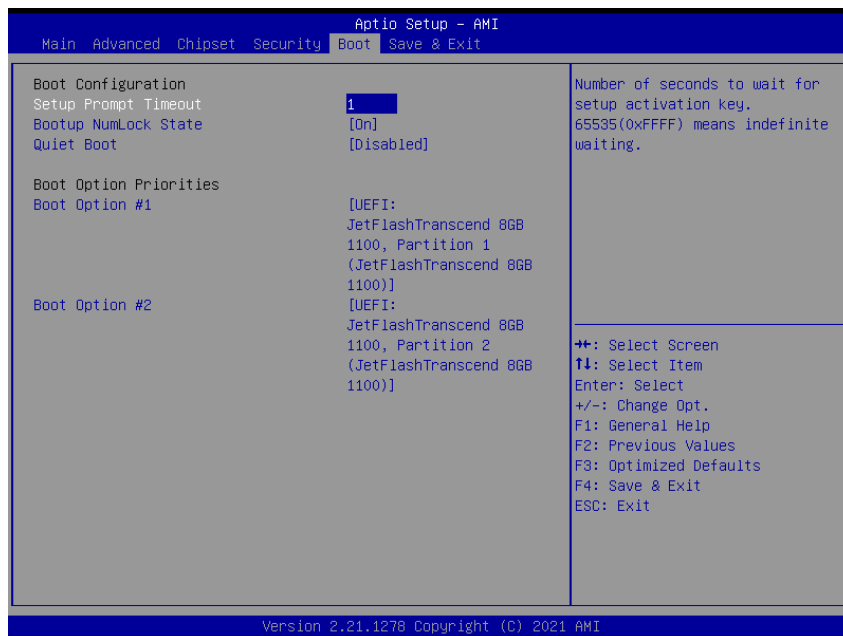

Item	Option	Description
Setup Prompt Timeout	1	Number of seconds to wait for setup activation key. 65535(0xFFFF) means indefinite waiting.
Bootup NumLock State	On[Default] Off	Select the Keyboard NumLock state
Quiet Boot	Disabled[Default] Enabled	Enables or disables Quiet Boot option
Boot Option #1	Set the system boot order.	
Boot Option #2	Set the system boot order.	

3.6.6 Save and exit

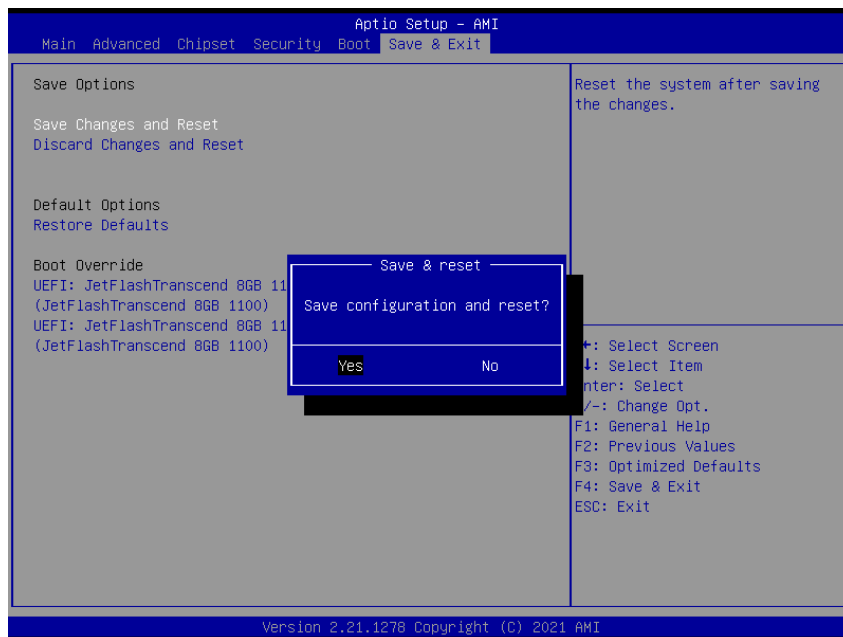
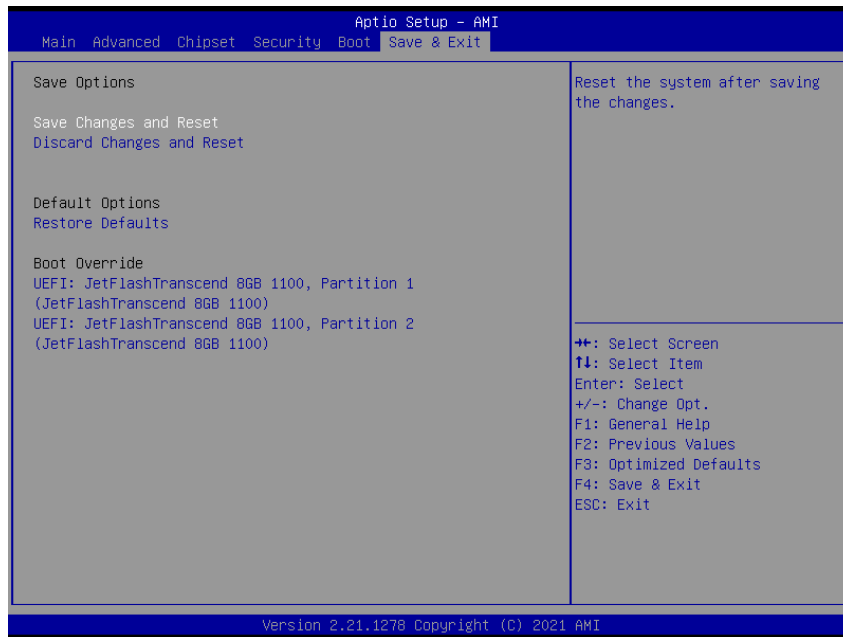

3.6.6.1 Save Changes and Reset

Reset the system after saving the changes.

3.6.6.2 Discard Changes and Reset

Reset system setup without saving any changes.

OFP-15W38

3.6.6.3 *Restore Defaults*

Restore/Load Default values for all the setup options.

3.6.6.4 *Launch EFI Shell from filesystem device*

Attempts to Launch EFI Shell application (Shell.efi) from one of the available filesystem devices.

4. Drivers Installation



Note: Installation procedures and screen shots in this section are for your reference and may not be exactly the same as shown on your screen.

4.1 Install Chipset Driver

All drivers can be found on the Avalue Official Website:

<http://www.avalu.com.tw>.



Note: The installation procedures and screen shots in this section are based on Windows 10 operation system. If the warning message appears while the installation process, click Continue to go on.

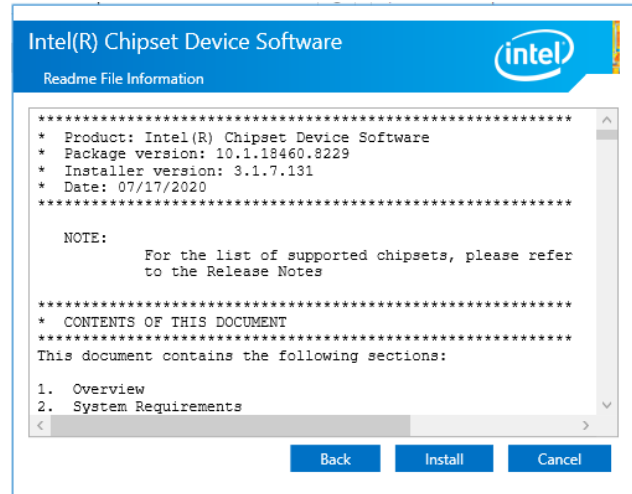

Step 3. Click Install.

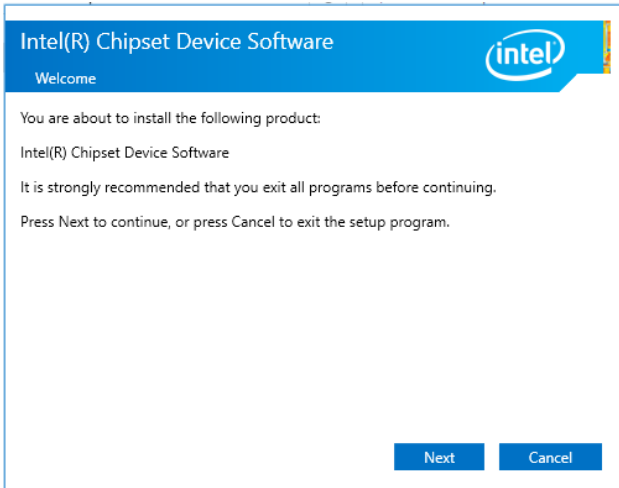

Step1. Click Next.

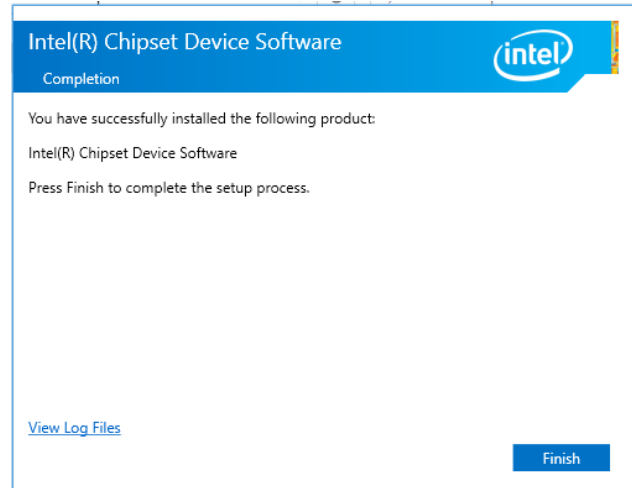

Step 4. Complete setup.



Step 2. Click Accept.

4.2 Install VGA Driver

All drivers can be found on the Avalue Official Website:

<http://www.avalue.com.tw>.



Note: The installation procedures and screen shots in this section are based on Windows 10 operation system. If the warning message appears while the installation process, click Continue to go on.

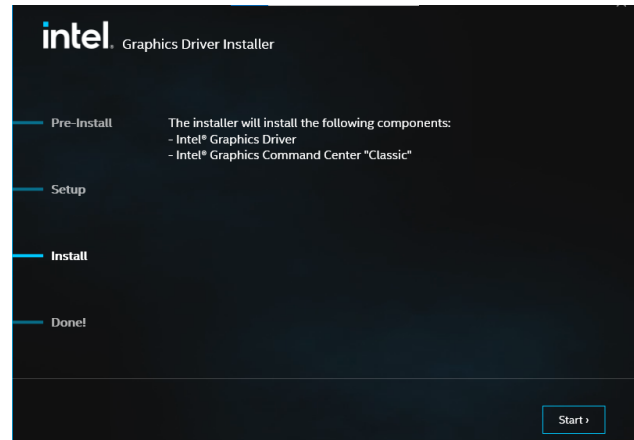

Step 3. Click Start.



Step 1. Click Begin installation.

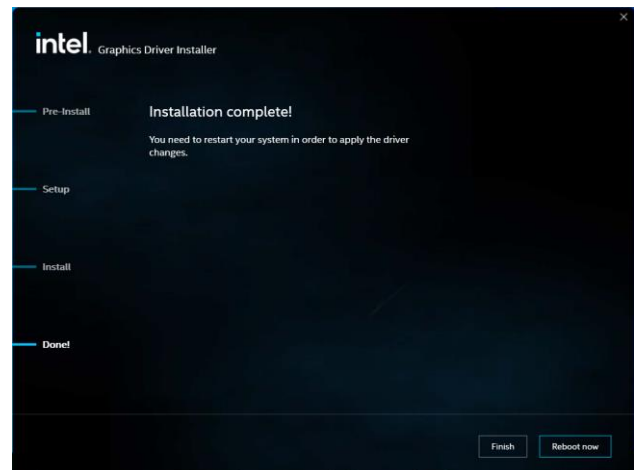

Step 4. Click Reboot now.

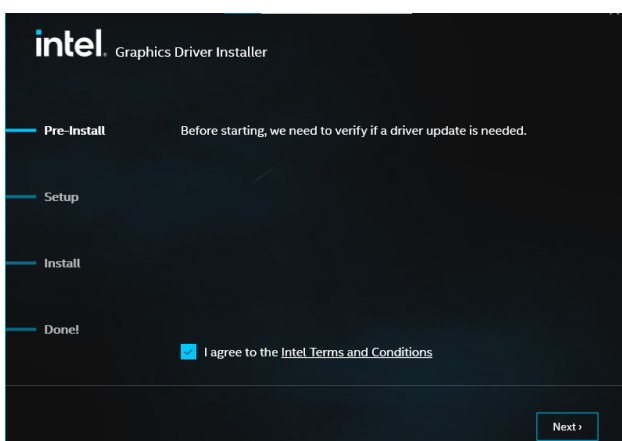

Step 2.

Click **Next** to accept license agreement.

4.3 Install ME Driver

All drivers can be found on the Avalue Official Website:

<http://www.avalue.com.tw>.



Note: The installation procedures and screen shots in this section are based on Windows 10 operation system. If the warning message appears while the installation process, click Continue to go on.

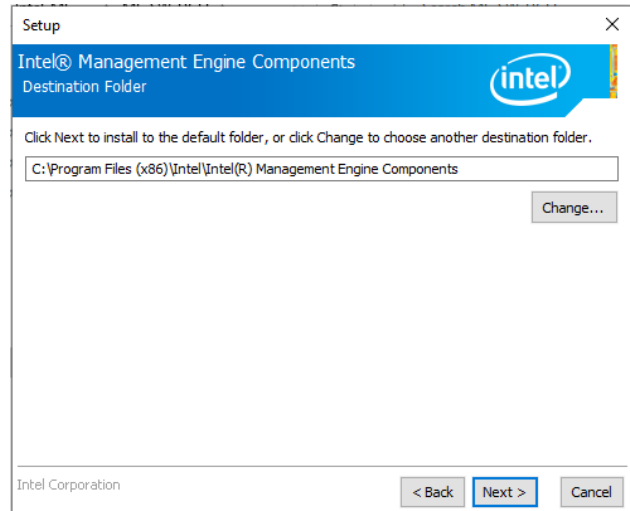

Step 3. Click Next.

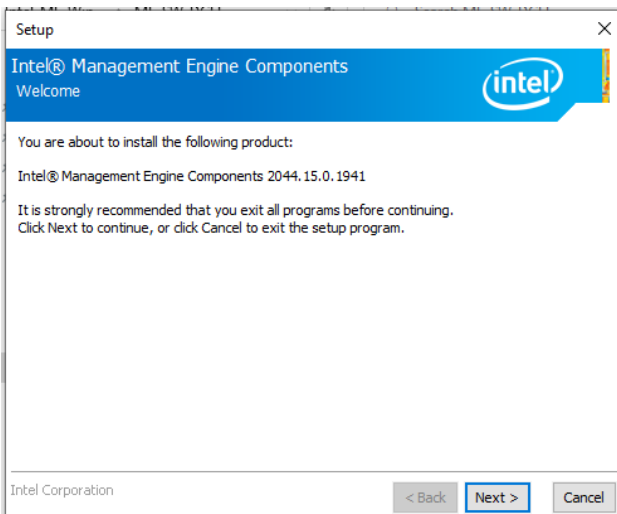

Step 1. Click Next to continue setup.

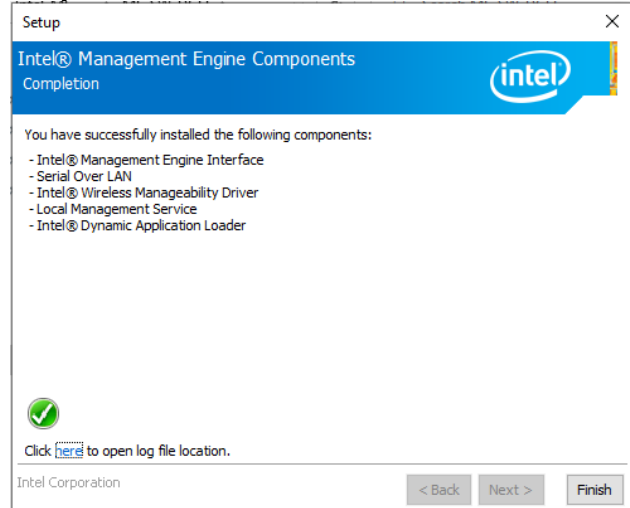

Step 4. Click Finish to complete setup.

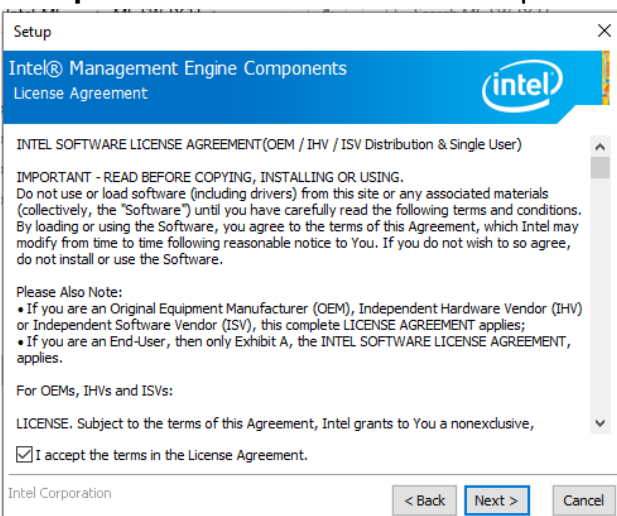

Step 2. Click Next.

4.4 Install Audio Driver (For Realtek ALC897 and ALC888S HD Audio)

All drivers can be found on the Avalue Official Website:

<http://www.avalue.com.tw>.



Note: The installation procedures and screen shots in this section are based on Windows 10 operation system. If the warning message appears while the installation process, click Continue to go on.

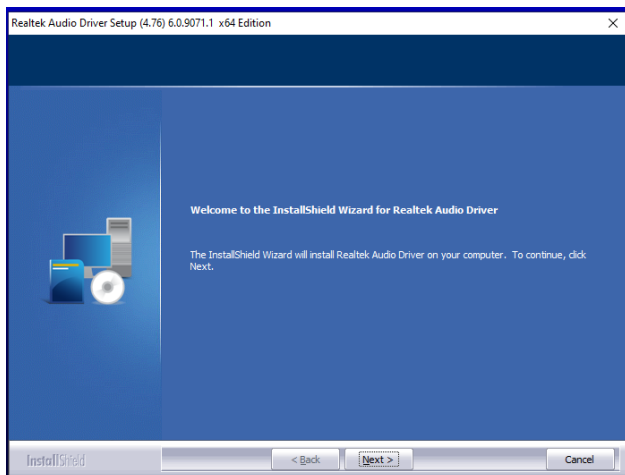

Step1. Click **Next** to Install.

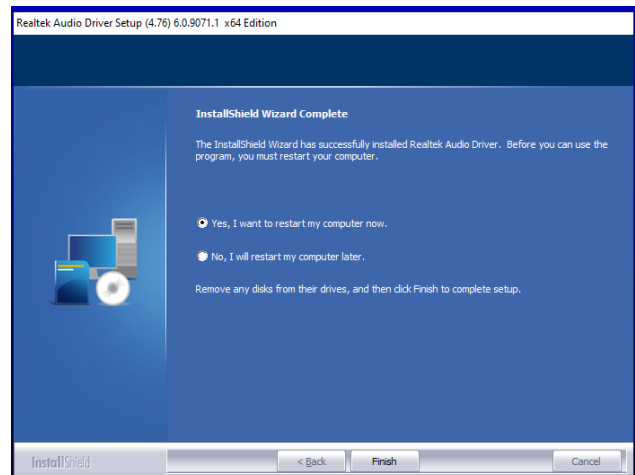

Step 2. Click **Finish** to complete setup.

4.5 Install LAN Driver

All drivers can be found on the Avalue Official Website:
<http://www.avalu.com.tw>.



Note: The installation procedures and screen shots in this section are based on Windows 10 operation system. If the warning message appears while the installation process, click Continue to go on.

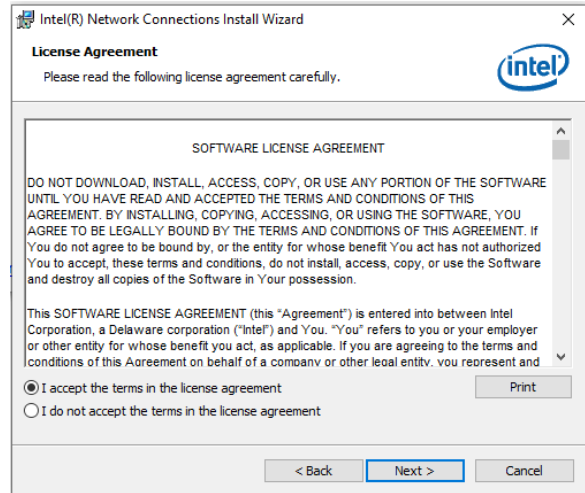

Step 3. Click Next.

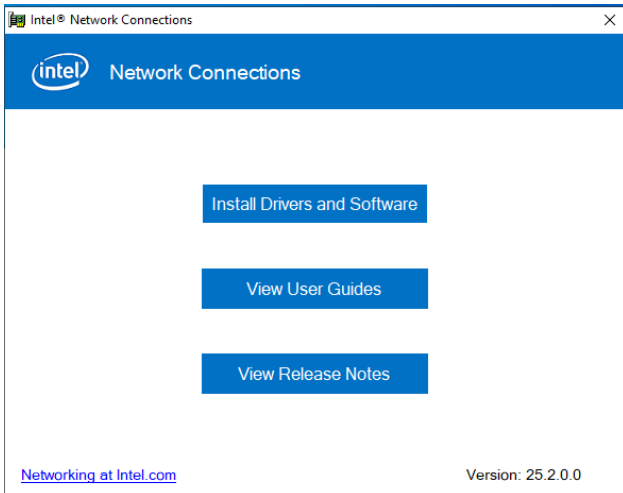

Step 1. Click Next to continue installation.

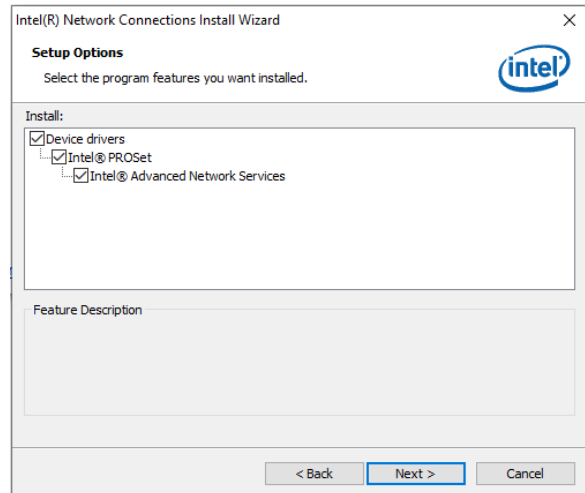

Step 4. Click Yes.

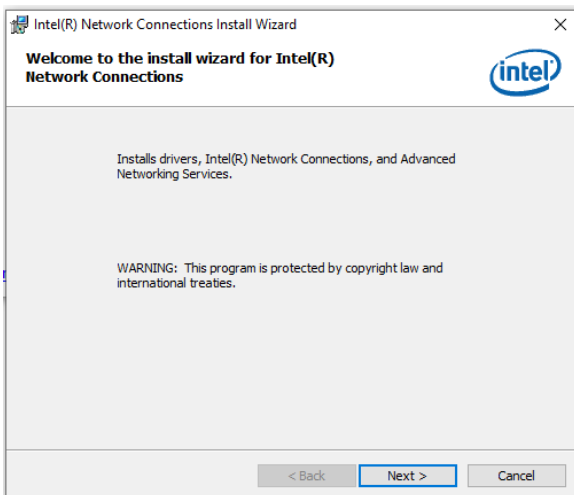

Step 2. Click Next.

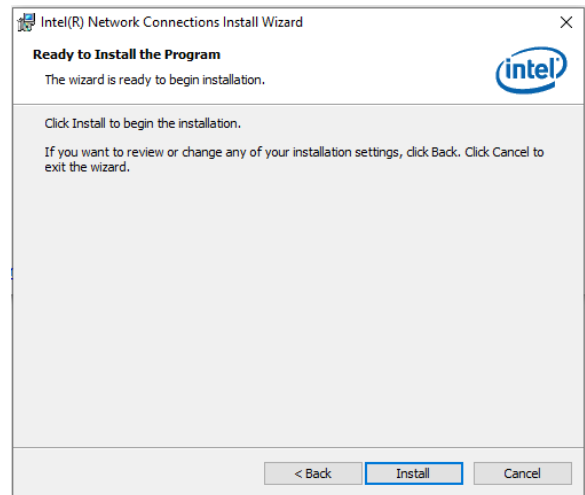

Step 5. Click Install.

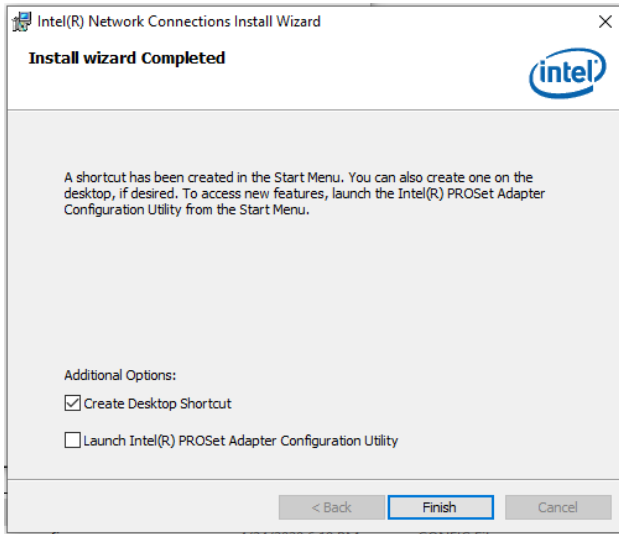

Step 6. Click **Finish** to complete setup.

4.6 Install RST for RAID Driver

All drivers can be found on the Avalue Official Website:

<http://www.avalu.com.tw>.



Note: The installation procedures and screen shots in this section are based on Windows 10 operation system. If the warning message appears while the installation process, click Continue to go on.

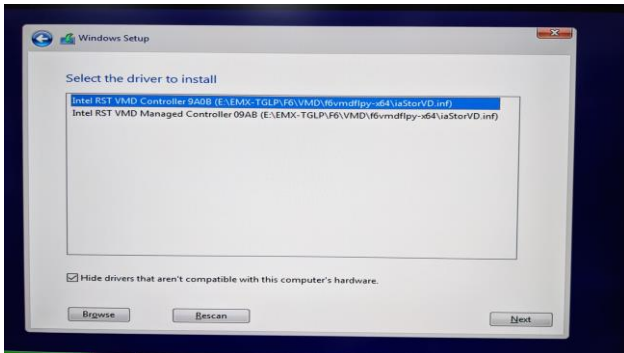

Step 1. Click **Next** to continue installation.



Step 2. Click **Next**.

4.7 Ascending Network Adapter

All drivers can be found on the Avalue Official Website:

<http://www.avalue.com.tw>.



Note: The installation procedures and screen shots in this section are based on Windows 10 operation system. If the warning message appears while the installation process, click Continue to go on.

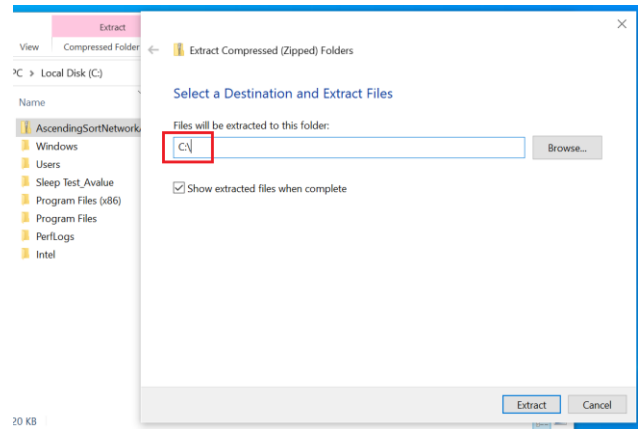

Step 3.

change path to **C:** and execute the file

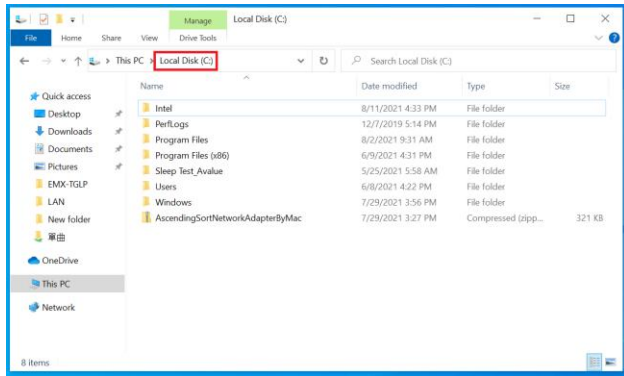

Step 1. Copy file:

“AscendingSortNetworkAdapterByMac.zip”
to C:\

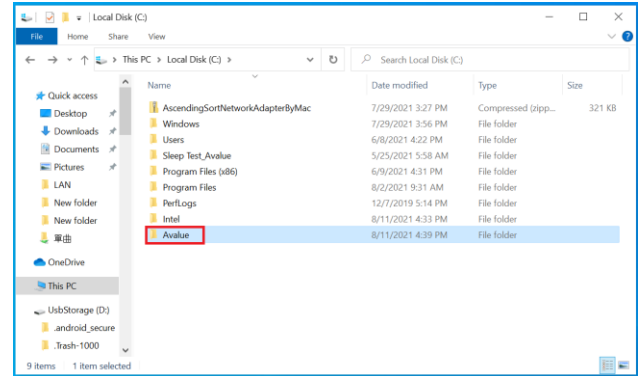

Step 4. it will generate **Avalue** folder.

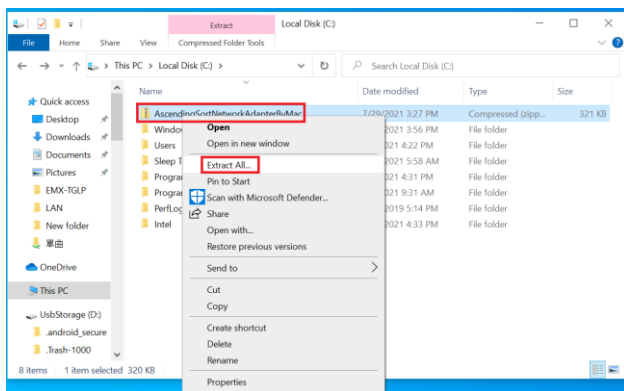

Step 2. Unzip file:

“AscendingSortNetworkAdapterByMac.zip”

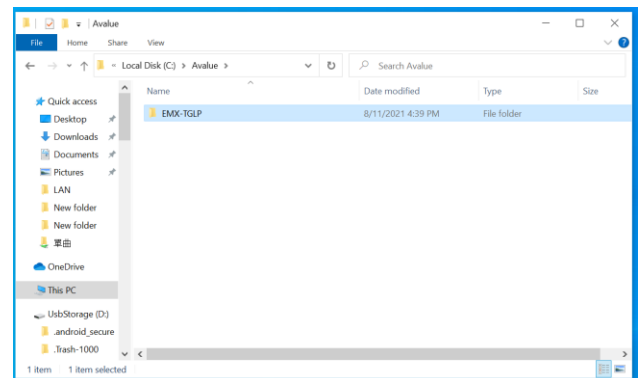

Step 5.

Click and enter C:\Avalue\EMX-TGLP folder ,
execute administrator mode
“ExecuteAscendingSortNetworkAdaptersX64.bat”.

OFP-15W38

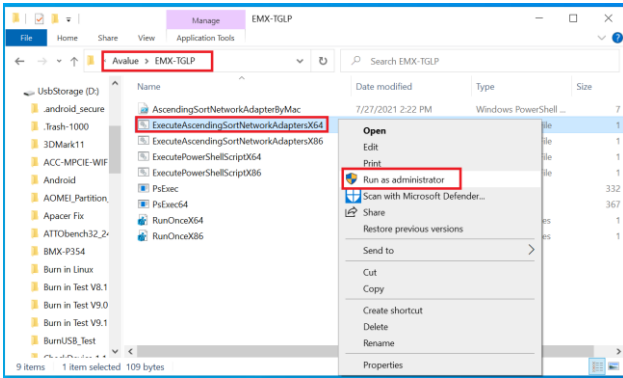

Step 6. After execute “ExecuteAscendingSortNetworkAdaptersX64.bat”, it will auto Restart.

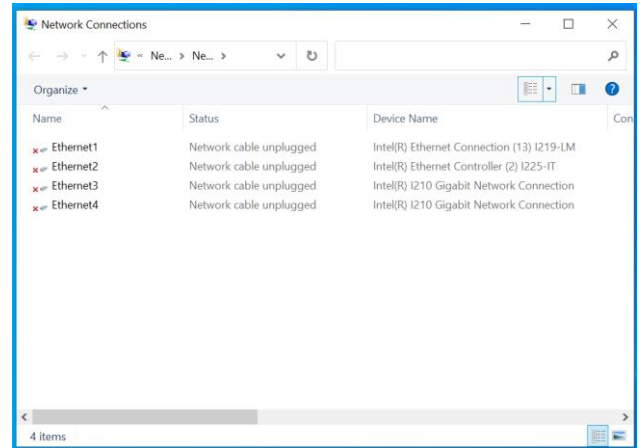

Step 7.
 Ethernet1=>INTEL I219LM
 Ethernet2=>INTEL I225IT
 Ethernet3=>INTEL I210
 Ethernet4=>INTEL I210



Note:

If customer would like to patch LAN order sequence, please refer to Avalue website for EMX-TGLP Sort Network Adapter By Mac Address.



Other

No.	Release Date	Model	Description	Download
1	2021-08-12	EMX-TGLP	SortNetwork Tool Device:Other	

5. Development Resource

Here you can find development resource for OFP-15W38

Datasheet

[LCD Datasheet\(eDP\)](#)

[Touch Screen Datasheet](#)

[Adapter Datasheet](#)

[CE/FCC test Report](#) (Product Design Verification Report)

Here you can find information for Software development

[How to flash Android image file](#)



Note: If you need more information, please visit our website:

<http://www.avalue.com.tw>