

# Vehicle Mounted Computer

Qualcomm Snapdragon™ 660 octa-core, 2.2 GHz



## FM10Q

---

## Product Reference Guide



# Table of Contents

<b>Preface</b> .....	<b>4</b>
<b>Chapter 1: Introduction</b> .....	<b>10</b>
1.1 About This Guide .....	10
1.2 Package Contents .....	11
1.3 Optional Accessories .....	11
1.4 Components .....	12
<b>Chapter 2: Hardware</b> .....	<b>15</b>
2.1 System Hardware .....	15
2.2 Central Processing Unit .....	15
2.3 Input and Output Connectors .....	15
2.4 System Memory .....	16
2.5 Audio Interface .....	16
2.6 Memory Card .....	16
2.7 WWAN .....	16
2.8 Power .....	16
2.8.1 Vehicle DC Power Supply .....	16
2.8.2 External AC Power Supply (Optional) .....	16
2.9 Power Management Modes .....	17
2.9.1 Turn On .....	17
2.9.2 Suspend .....	17
2.9.3 Wake Up .....	18
2.9.4 Turn Off .....	18
2.10 Power Control .....	18
2.10.1 Power Switch .....	18
2.10.2 Power Button .....	18
2.11 Ignition Control .....	19
2.12 Battery .....	19
2.12.1 UPS Battery .....	20
2.12.2 Backup Battery .....	20
2.13 External Connectors .....	21
2.13.1 Connector Pin Assignment .....	22
2.14 CANBus Cable Installation Reference .....	29
2.15 Antenna Connections .....	29
2.16 External/ Vehicle Remote Antenna .....	29
2.17 Keyboard Options .....	31
2.17.1 Integrated Keypad .....	31
2.17.2 USB Keyboard/ Mouse .....	31
2.18 LED Function .....	31
2.18.1 Connection and UPS battery LEDs .....	32
2.18.2 System LEDs .....	32
2.18.3 Power LED .....	32
2.19 Display .....	33
2.19.1 Touch Screen .....	33
2.19.2 Display Backlight Control .....	33
<b>Chapter 3: Software</b> .....	<b>34</b>
3.1 Introduction .....	34
3.1.1 Operating System .....	34
3.1.2 About Android 9.0 .....	34
3.2 Setting up the Device .....	34
3.2.1 Home Screen .....	34

3.2.2 Quick Settings .....	35
3.3 Status and Notification Icons .....	37
3.3.1 Status Icons.....	37
3.3.2 Notification Icons .....	37
3.4 Control Panel.....	38
3.4.1 Using the Touch Screen .....	38
3.4.2 System Settings.....	39
3.5 Ethernet.....	45
3.5.1 Configuring Ethernet Settings.....	46
3.5.2 Checking the Ethernet Settings .....	47
3.6 Winset.....	47
3.6.1 Winset Application .....	47
3.6.2 Ignition Control .....	48
3.6.3 Screen Blanking .....	49
3.6.4 Function Buttons.....	50
3.6.5 Defroster (If Equipped) .....	52
3.7 Winmate® Home Manager (WHM) .....	54
3.7.1 How to Lock Applications .....	54
3.7.2 How to Reset WHM Settings .....	57
3.7.3 How to Change WHM Password .....	58
3.8 WDC .....	59
3.9 BT.....	60
3.10 Connecting to WLAN Networks .....	62
3.11 WWAN.....	65
3.12 Camera Features.....	66
3.12.1 Taking Pictures.....	66
3.12.2 Making Videos .....	67
3.12.3 Camera Settings.....	68
3.13 Software Update .....	68
3.13.1 Image Tool Download.....	69
3.13.2 OTA Update Guide .....	69
3.13.3 OS Image Update Guide .....	73
3.14 Transfer Files via USB.....	74
3.15 Changing Touchscreen Modes.....	78
<b>Chapter 4: Accessories Installation .....</b>	<b>80</b>
4.1 Installing a SIM Card .....	80
4.2 Installing a MicroSD Card .....	81
4.3 Installing a Stylus with the holder.....	82
<b>Chapter 5: Vehicle Mounting.....</b>	<b>83</b>
5.1 Introduction.....	83
5.2 Vehicle Mount Instruction .....	83
5.3 RAM Mount Installation.....	84
5.3.1 Mounting Kit 1 – No Drill Solution .....	84
5.3.2 Mounting Kit 2 – Drill Solution.....	85
5.3.3 RAM Mount Assembly .....	86
5.3.4 Mounting Kit 3 – Keyboard Mounting Installation.....	87
5.3.5 Keyboard Assembly.....	88
5.4 Docking and Undocking the Device .....	90
5.5 Power Cable Installation .....	91
5.5.1 Wiring the Power Cable.....	91
5.5.2 Connecting the Power Cable for Testing .....	91
5.5.3 Connecting the Power Cable for Installation on the Vehicle .....	92
5.4.4 Power Cable Routing.....	94

<b>Appendix.....</b>	<b>95</b>
Appendix A: Product Specifications .....	95
Appendix B: Order Information .....	97

## Preface

### Copyright

No part of this manual may be reproduced, copied, translated, or transmitted in any form or any means, electronic or mechanical, for any purpose, without the written permission of Winmate Inc.

### Trademarks

Brand and product names are trademarks or registered trademarks of their respective owners.



**Note:** Display images shown may vary slightly from actual display. Information in this manual is subject to change without prior notification.



**Note:** FM10Q Computer has to be used together with the docking station. Use the device when located at least 20 cm (7.9 inches) away from the human body.

### Disclaimer

Winmate Inc. reserves the right to make any product changes without notice, including circuits and/or software described or contained in this manual in order to improve design and/or performance. Winmate Inc. assumes no responsibility or liability for the use of the described product (s), conveys no license or title under any patent, copyright, or masks work rights to these products, and makes no representations or warranties that these products are free from patent, copyright, or mask work right infringement, unless otherwise specified. Applications that are described in this guide are for illustration purposes only. Winmate Inc. makes no representation or warranty that such application will be suitable for the specified use without further testing or modification.

### Warranty

Winmate Inc. warrants that each of its products is free from material and workmanship defect for a period of one year starting from the invoice date. If the customer discovers a defect, Winmate Inc. will, at its option, repair or replace the defective product at no charge to the customer, provided it is returned during the warranty period, with transportation charges prepaid. The returned product must be properly packaged in its original packaging to obtain warranty service.

## Advisory Conventions

Four types of advisories are used throughout the user manual to provide helpful information or to alert you to the potential for hardware damage or personal injury. These are Notes, Important, Cautions, and Warnings. The following is an example of each type of advisory.



**Note:** A note is used to emphasize helpful information



**Important:** An important note indicates information that is important for you to know.



**Caution** A Caution alert indicates potential damage to hardware and explains how to avoid the potential problem.

**Attention** Une alerte d'attention indique un dommage possible à l'équipement et explique comment éviter le problème potentiel.



**Warning!** An Electrical Shock Warning indicates the potential harm from electrical hazards and how to avoid the potential problem.

**Avertissement!** Un Avertissement de Choc Électrique indique le potentiel de chocs sur des emplacements électriques et comment éviter ces problèmes.

## FCC Regulations

This device complies with part 15 of the FCC Rules. Operation is subject to the following two conditions: (1) This device may not cause harmful interference, and (2) this device must accept any interference received, including interference that may cause undesired operation.

This device has been tested and found to comply with the limits for a Class B digital device, pursuant to Part 15 of the FCC Rules. These limits are designed to provide reasonable protection against harmful interference in residential installation. This equipment generates uses and can radiate radio frequency energy and, if not installed and used in accordance with the instructions, may cause harmful interference to radio communications. However, there is no guarantee that interference will not occur in a particular installation. If this equipment does cause harmful interference to radio or television reception, which can be determined by turning the equipment off and on, the user is encouraged to try to correct the interference by one or more of the following measures:

- Reorient or relocate the receiving antenna.
- Increase the separation between the equipment and receiver.
- Connect the equipment into an outlet on a circuit different from that to which the receiver is connected.
- Consult the dealer or an experienced technician for help.

Changes or modifications not expressly approved by the party responsible for compliance could void the user's authority to operate the equipment.

Operation on the 5.15-5.25GHz frequency band is restricted to indoor use only. The FCC requires indoor use for the 5.15-5.25GHz band to reduce the potential for harmful interference to co-channel Mobile Satellite Systems. Therefore, it will only transmit on the 5.25-5.35 GHz, 5.47-5.725 GHz and 5.725 –5.850 GHz band when associated with an access point (AP).

## CE Notice (European Union)

This device has been tested and found to conform to the limits set for a Class B product.

- EN 55022 — “Limits and Methods of Measurement of Radio Interference Characteristics of Information Technology Equipment”
- EN 55024 — “Information technology equipment - Immunity characteristics - Limits and methods of measurement”
- EN 61000-3-2 — “Electromagnetic compatibility (EMC) - Part 3: Limits - Section 2”
- EN 61000-3-3 — “Electromagnetic compatibility (EMC) - Part 3: Limits - Section 3”
- EN 60950 — “Safety of Information Technology Equipment”.
- EN 55022 Emissions requirements

## RF Exposure Information (SAR)

This device is compliance with SAR for general population /uncontrolled exposure limits in ANSI/IEEE C95.1-1999 and had been tested in accordance with the measurement methods and procedures specified in OET Bulletin 65 Supplement C.

This equipment complies with FCC RF radiation exposure limits set forth for an uncontrolled environment. This device was tested for operations with the device contacted directly to the human body to the back side of the EUT. To maintain compliance with FCC RF exposure compliance requirements, avoid direct contact to the transmitted antenna during transmitting.

## IC Regulations

Le présent appareil est conforme aux CNR d'Industrie Canada applicables aux appareils radio exempts de licence. L'exploitation est autorisée aux deux conditions suivantes:

- (1)l'appareil ne doit pas produire de brouillage, et
- (2)l'utilisateur de l'appareil doit accepter tout brouillage radioélectrique subi, même si le brouillage est susceptible d'en compromettre le fonctionnement.”

This device complies with Industry Canada license-exempt RSS standard(s). Operation is subject to the following two conditions:

- (1)This device may not cause interference, and
- (2)This device must accept any interference, including interference that may cause undesired operation of the Device.

## This Class B digital apparatus complies with Canadian ICES-003

Cet appareil numérique de la classe B est conforme à la norme NMB-003 du Canada.

The device could automatically discontinue transmission in case of absence of information to transmit, or operational failure. Note that this is not intended to prohibit transmission of control or signaling information or the use of repetitive codes where required by the technology.

The device for the band 5150-5250 MHz is only for indoor usage to reduce potential for harmful interference to co- channel mobile satellite systems; the maximum antenna gain permitted (for devices in the bands 5250-5350 MHz and 5470-5725 MHz) to comply with the e.i.r.p. limit; and The maximum antenna gain permitted (for devices in the band 5725-5850 MHz) to comply with the e.i.r.p. limits specified for point-to-point and non-point-to-point operation as appropriate, as stated in section A9.2(3). In addition, High-power radars are allocated as primary users (meaning they have priority) of the band 5250-5350 MHz and this radar could cause interference and/or damage to LE-LAN devices.



The County Code Selection feature is disabled for products marketed in the US/Canada. For product available in the USA/ Canada markets, only channel 1~11 can be operated. Selection of other channels is not possible.

## IC Radiation Exposure Statement

This EUT is compliance with SAR for general population/uncontrolled exposure limits in IC RSS-102 and had been tested in accordance with the measurement methods and procedures specified in IEEE 1528.

## Read Me First



**Attention:** Pour réduire le risque d'incendie ou de choc électrique ne pas exposer l'appareil à la pluie ou à l'humidité. VERIFIER que le cordon électrique est la prise murale pour un delai d'inactivite prolongé. Pour arrêter complètement l'alimentation de l'appareil, débranchez le cordon d'alimentation de la prise AC. N'enlever ni le capot arrière ni les pièces internes de l'appareil. Contactez un personnel qualifié si nécessaire.



SA1965

### Electrique Avertissement

Utilisé pour les instructions destinés à alerter l'utilisateur d'un CHOC ÉLECTRIQUE mortel ou de blessure grave en cas d'utilisation incorrecte de l'unité.



SA1966

**Avertissement** Utilisé pour les instructions destinés à alerter l'utilisateur d'un risque mortel ou de blessure grave en cas d'utilisation incorrecte de l'unité.



**Attention:** Pour réduire le risque d'incendie ou de choc électrique ne pas exposer l'appareil à la pluie ou à l'humidité FAIRE le cordon électrique est DÉBRANCHÉ DE LA PRISE MURALE DANS UN DELAI DE PROLONGER INACTIVITÉ. De se désengager totalement LE POUVOIR DE L'UNITE, S'IL VOUS PLAÎT DEBRANCHER LE CORDON D'ALIMENTATION DE LA PRISE AC. NE PAS Romove le capot arrière, pas de PIÈCES À L'INTÉRIEUR. Contactez un personnel qualifié S'il faut le réparer.



SA1965

### Electrique Avertissement

Sert aux instructions destin es alerter l'utilisateur d'un CHOC ÉLECTRIQUE mortel ou de blessure grave en cas d'utilisation incorrecte de l'unit.



SA1966

**Avertissement** Sert aux instructions destin es alerter l'utilisateur d'un risque mortel ou de blessure grave en cas d'utilisation incorrecte de l'unit .

## Informations de sécurité (FR)

Suivez et respectez tous les avertissements et instructions figurant sur l'écran. Pour votre sécurité, s'il vous plaît lire toutes les consignes de sécurité et de fonctionnement avant d'utiliser le device. Gardez ce manuel pour référence future.

1. Lire avec attention toutes les recommandations et précautions d'emploi avant d'utiliser ce produit.
2. Veuillez conserver ces recommandations et précautions pour référence future.
3. Lire et comprendre tous les avertissements énumérés dans les précautions d'emploi.
4. Suivre toutes les précautions d'emploi pour utiliser ce produit.
5. Utiliser exclusivement un chiffon sec pour nettoyer ce produit.
6. Ne pas placer le produit près de toute source de chaleur telle que radiateurs, arrivées d'air chaud, fourneaux ou autres appareils générant de la chaleur (incluant les amplificateurs producteurs de chaleur) .
7. Ne pas négliger la sécurité que procure un branchement polarisé ou avec raccordement à la terre, Un branchement polarisé comprend deux fiches dont l'une est plus large que l'autre. Un branchement à la terre comprend deux fiches plus une troisième reliée à la terre. Si la fiche secteur fournie ne s'insère pas dans votre prise de courant. consulter un 'électricien afin de remplacer votre prise obsolète.
8. Protéger le cordon d'alimentation de tout écrasement ou pincement, particulièrement au niveau des fiches, des réceptacles utilisés et à l'endroit de sortie de l'appareil. Ne pas casser la fiche de terre du cordon d'alimentation.
9. Utiliser uniquement les accessoires spécifiés par le constructeur.
10. Utilisez seulement des accessoires spécifiés par le fabricant ou vendus avec le produit.
11. Débrancher cet appareil lors d'orages ou s'il n'est pas utilisé pendant une longue période.
12. Faire exécuter le service par du personnel qualifié. Une intervention technique est requise lorsque l'appareil a été endommagé ou n'opère pas normalement.



## Safety Information (EN)

Follow and adhere to all warnings and instructions on the screen. For your safety, please read all safety and operating instructions before using the device. Keep this manual for future reference.

1. Carefully read all recommendations and precautions for use before using this product.
2. Retain all recommendations and precautions for future reference as necessary.
3. Read and be sure to understand all warnings listed in the precautions.
4. Follow all operating precautions when using this product.
5. Use only a dry cloth to clean this product.
6. Do not place the product near any heat sources such as radiators, warm air intakes, stoves or other heat- generating devices (including amplifiers or other heat producing equipment).
7. Do not disregard the safety that a polarized or grounded connection can provide. A polarized connection consists of two plugs, one of which is larger than the other. A grounded connection has two blades and a third one that is grounded. If the main plug provided cannot be inserted into your outlet, consult an electrician to replace your obsolete outlet.
8. Protect the power cord from being crushed or pinched, particularly in the area of the plugs, any receptacles used, and the point of exit from the apparatus. Do not break off the ground pin of the power cord.
9. Use only accessories specified by the manufacturer.
10. Use only with accessories specified by the manufacturer or sold with the product.
11. Unplug this apparatus during lightning storms or when it is not being used for long periods.
12. Refer all servicing to qualified service personnel. A technical intervention is required when the apparatus has been damaged in any way or does not operate normally.



## About the Adapter

- Use only the supplied AC adapter (Rating: Input DC 10-60V DC). Use of another type of AC adapter will result in malfunction and/or danger.
- Do not use the adapter in a high moisture environment. Never touch the adapter when your hands or feet are wet.
- Allow adequate ventilation around the adapter when using it to operate the device or charge the battery. Do not cover the AC adapter with paper or other objects that will reduce cooling. Do not use the AC adapter while it is inside a carrying case.
- Connect the adapter to a proper power source. The voltage requirements are found on the product case and/or packaging.
- Do not use the adapter if the cord becomes damaged.
- Do not attempt to service the unit. There are no serviceable parts inside. Replace the unit if it is damaged or exposed to excess moisture.

## Li-Ion Battery

Your device has UPS battery. When disposing UPS battery, follow local rules and regulations.



**Warning!** Do not dispose the battery with general waste materials.  
**Avertissement!** Ne jetez pas la batterie avec les déchets ordinaires.

The following precautions on battery recycling should be observed:

- The battery should be disposed properly according to local regulations;
- The battery should not be damaged or crushed;
- The battery should not be heated or exposed to direct sunlight.

If you are not aware of local regulations on disposing the battery pack, contact our Service Center or sales representatives for more information.



**Important:** This hot-swap battery is soft-packed. It may have up to 8% inflation in dimensions under the usage in normal conditions. The mechanical design of the device reserves the space for this normal inflation.



**Warning!** If you observe the internal hot-swap battery has been inflated more than normal condition (or the blotch of panel and touch caused by inflated battery), contact our Service Center or sales representative for replacing the battery immediately.

**Avertissement!** Si vous constatez que la batterie interne remplaçable à chaud a été gonflée plus que dans des conditions normales (ou la tache du panneau et le toucher causés par une batterie gonflée), contactez notre centre de service ou notre représentant commercial pour remplacer la batterie immédiatement.



**Important:** The battery is consumable part. Therefore, it is recommended to replace the battery pack every two years with a new one recommended by Winmate. Contact our Service Center or sales representatives for more information on replacing the battery pack.

## General Guideline

It is recommended to reboot the device when some functions are defect or inactive. If it still can't solve the problems, please contact your dealer or agent.

## Chapter 1: Introduction

The FM10Q is an Android-based rugged vehicle-mounted computer that ships with a high-performance Qualcomm Snapdragon™ 660 octa-core 2.2 GHz CPU. The computer showcases enterprise mobility in a VMC form factor thanks to its rich I/O ports, versatile wireless connectivity options, as well as the high flexibility brought by the design of the dock with a one-click top latch, which allows for easy removal of the device. Engineered to fit seamlessly into forklifts and other warehouse vehicles with its wide range of power input with power isolation, the FM10Q will help minimize errors, streamline inventory management, and improve operational efficiencies.

This vehicle-mount computer is built to endure the rigors of the warehouse, and designed to fit seamlessly into forklifts and other warehouse vehicles.

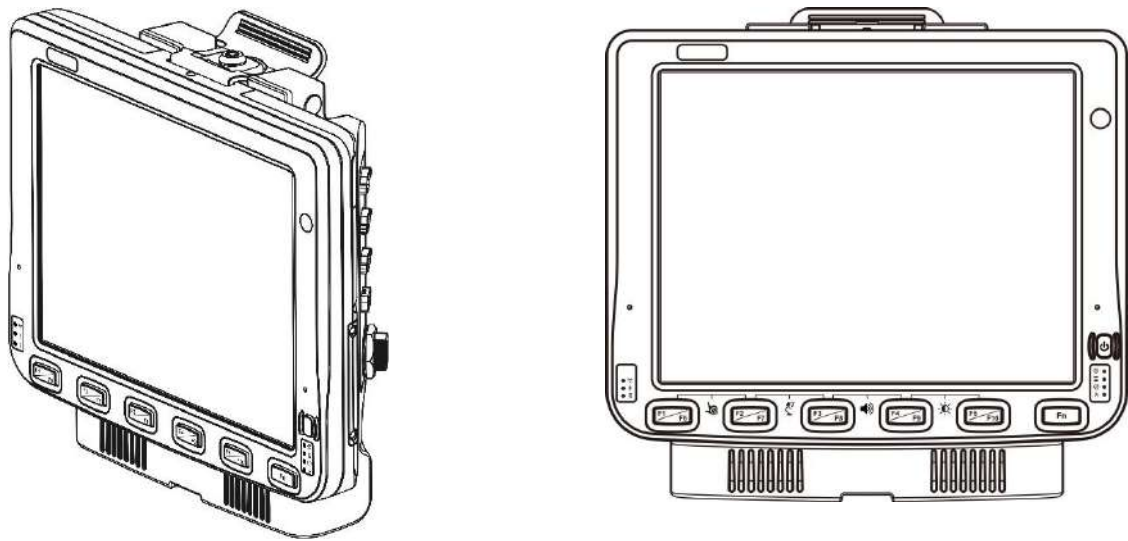

**Note:**

Contact our technical support for information on the latest firmware upgrade for your device.

### 1.1 About This Guide

This Product Reference Guide provides instruction for the system administrator to follow when configuring and using the FM10Q Vehicle Mount Computer. This Product Reference Guide has been developed for a FM10Q with Android 9.0 operating system.

## 1.2 Package Contents

Before using this device, make sure that all the items listed below are included in your package:



- VMC Computer FM10Q

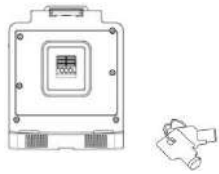

- Dock + Latch Locking Key

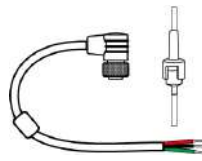

- Power Cable with Fuse

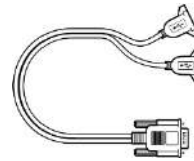

- USB Cable

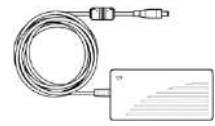

- 84W Adapter with Power Cable



- Quick Start Guide

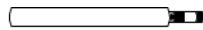

- WLAN Antenna



- Power Converter Cable



- External Antenna Fixing Bracket



- Power Cord

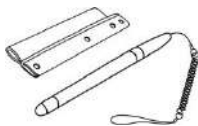

- Stylus Kit

**Note:** Two WLAN antennas are included in the standard package.

**Note:** Please order one bracket for one antenna. For example, if you plan to use two antennas, please order two brackets.

## 1.3 Optional Accessories

Your package may include the following items based on your order:

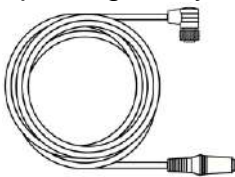

- DC Jack Power Cable

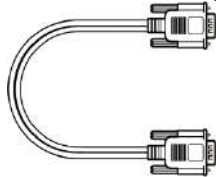

- RS232 Cable

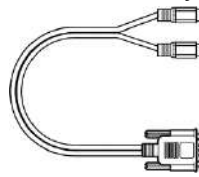

- Audio Cable



- LAN Cable

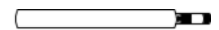

- WWAN Antenna



- Fuse Kit

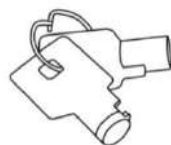

- Spare Key for Vehicle Dock

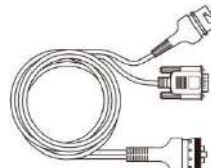

- CANBus Cable

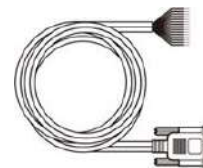

- CANBus cable (w/o DIDO)





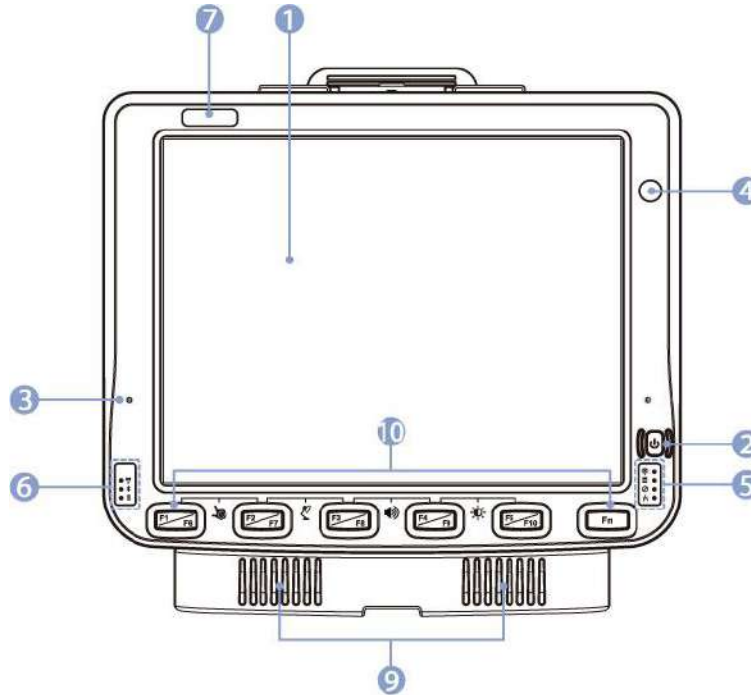

**Note:** Notice that only one antenna is included in the package. If you plan to use WWAN function please order two WWAN antennas.

**Note:** Notice that in order to have sound; you have to plug in the audio cable first than connect to docking.

## 1.4 Components

### Front View



No	Item	Description
1	<b>10.4" Touch Screen</b>	Acts as one of the inputs for the device
2	<b>Power Button</b>	Press and hold the button for 3 second to turn on the device
	<b>Power Indicator</b>	 Power Indicator
3	<b>Digital Microphone</b>	For voice communication and voice recording
4	<b>Camera</b>	2 Megapixel front camera
5	<b>LED indicators</b>	 Light Sensor (No function)
		 Blanking Indicator
		 Defroster Indicator, default no function (Defroster is a customized feature available by request)
6	<b>LED indicators</b>	 WLAN Indicator
		 BT Indicator
		 UPS Battery Indicator
7	<b>Label</b>	Space to print the label or company logo
8	<b>Speaker</b>	Emits Sound
9	<b>Function button</b>	Programmable Function key that can be configured by using the Win-Set Utility



## Rear View with Vehicle Dock

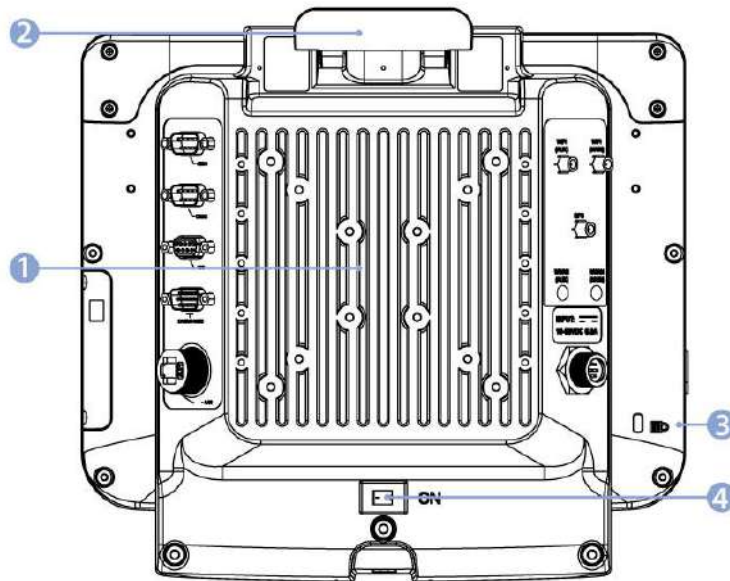

No	Item	Description
1	<b>VESA Mount Hole</b>	VESA 75, 100, and RAM Mount
2	<b>Release Latch</b>	Press to release the device and the docking
3	<b>Kensington Lock</b>	Connect to a security lock, protecting your device from being stolen
4	<b>Power switch</b>	Set the switch to on (I) to provide the supply power to the device and it will automatically connect to the ignition system of the vehicle

## Top and Bottom View

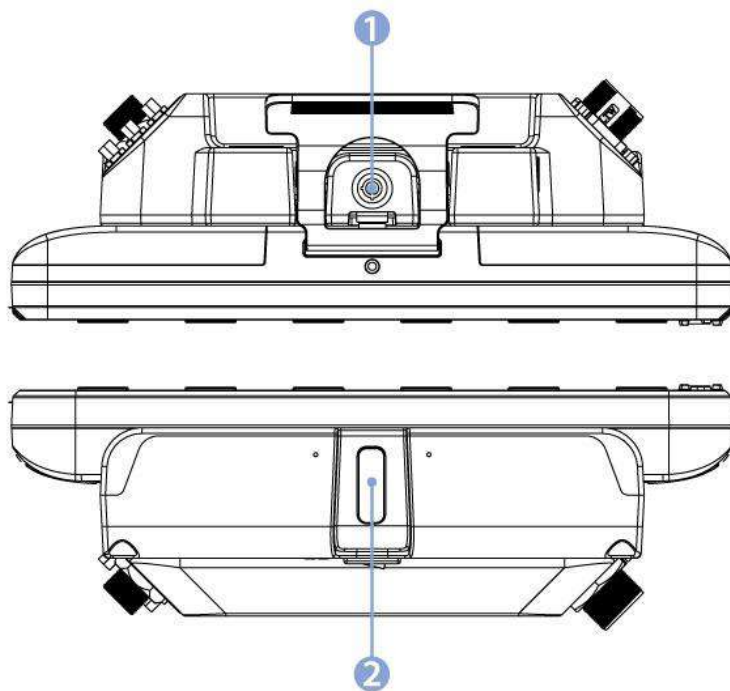

No	Item	Description
1	<b>Lock</b>	Lock the tablet in place
2	<b>Reading Light</b>	Use to provide illumination in dark environment

## Side View with Vehicle Dock

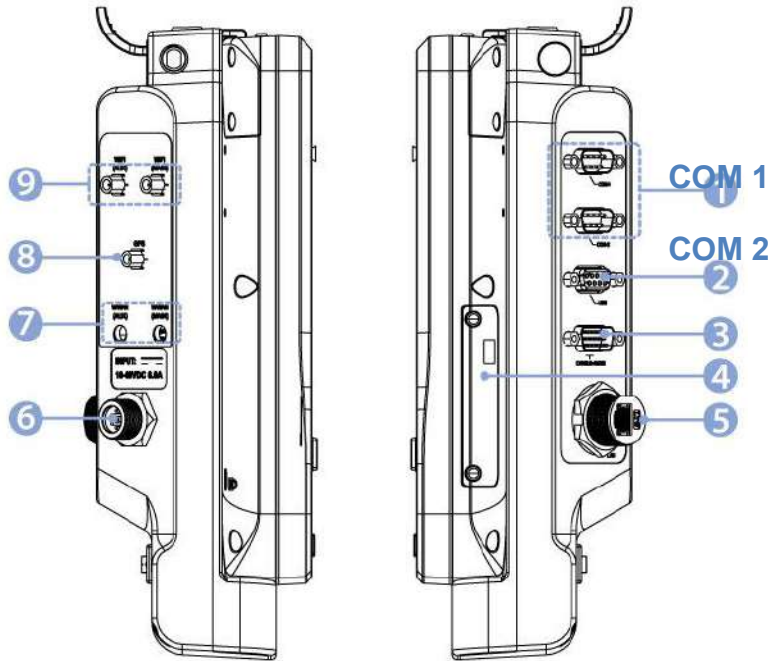

No	Item	Description
1	<b>COM1 and COM2</b>	Connects a peripheral device such as a printer or scanner with serial port <b>COM1 Node:</b> persist.sys.dock.com1 <b>COM2 Node:</b> persist.sys.dock.com2
2	<b>USB 2.0 x 2</b>	Connects USB peripheral devices such as USB Flash drive, mouse, keyboard, printer, etc.
3	<b>1 x CANBus or 1 x Audio (In and out)</b>	Connects to a vehicle, allowing access to wide range of vehicle data/ Connects headphone or other audio output devices
4	<b>Service Window</b>	To protect I/O ports
5	<b>LAN Port</b>	Connects to a local area network (LAN) using an Ethernet cable and provide optional POE with 48V
6	<b>Wide Range Power Input</b>	Connects a 10-60V DC IN wide range power input
7	<b>WWAN Antenna Connector</b>	Connects a WWAN external antenna and allows the device to be remotely mounted on the vehicle
8	<b>GPS Antenna Connector</b>	Connects a GPS external antenna and allows the device to be remotely mounted on the vehicle
9	<b>WLAN Antenna Connector</b>	Connects a WLAN external antenna and allows the device to be remotely mounted on the vehicle

**Note:** Service window covers SD Card Slot/ SIM Card Slot, USB Type-C and DC in power input jack.

**Note:** For the defroster function please connect a device to a power supply.



## Chapter 2: Hardware

### 2.1 System Hardware

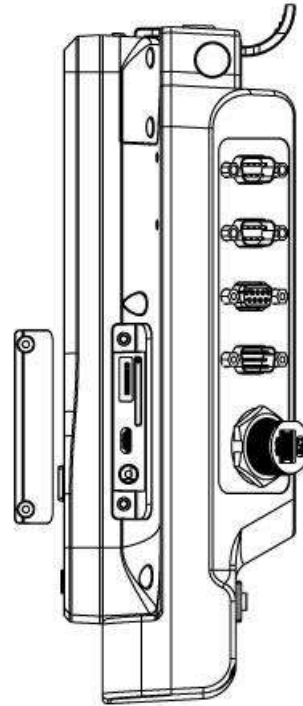
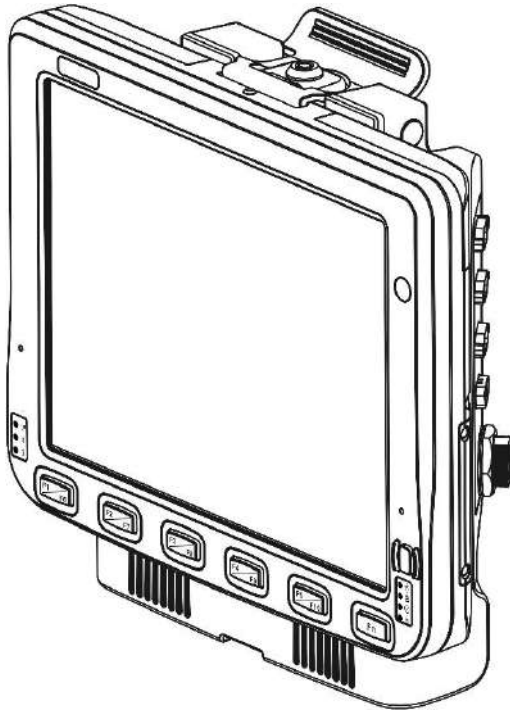

### 2.2 Central Processing Unit

The FM10Q is running on Qualcomm Snapdragon™ 660 octa-core 2.2 GHz CPU, and Android 9.0 operating system.

### 2.3 Input and Output Connectors

The FM10Q device supports the following I/O connectors:

- 1 x Dual-Nano SIM Card Slot
- 1 x Micro SD Card Slot
- 1 x USB 3.0 Type C (OTG)
- 1 x 12 V DC in power input jack



**Note:**

Only Sierra Module can support dual SIM single standby function.

The Vehicle Dock of the FM10Q device supports the following I/O connectors:

- 2 x COM
- 1 x DB9 Connector for 2 x USB 2.0 Port
- 1 x CANBus or 1 x Audio (In and Out)
- 1 x Gigabit LAN port
- 1 x Power connector
- 5 x SMA Connectors (female) for external antennas
- ( WLAN, GPS, WWAN)

## 2.4 System Memory

The main system memory is 3 GB LPDDR4.

## 2.5 Audio Interface

Your device is equipped with two speakers which are located on the bottom of the vehicle dock. A microphone is also available for voice communication and voice recording.

As an alternative, you can use a headset adapter cable that provides a connection for headset operation. When headset is plugged in to the adapter cable, the main speakers or internal microphone will be disabled.

## 2.6 Memory Card

Your device has a memory card slot which accepts an SD memory card. The memory card is hot swappable. Your device has an 802.11 a/b/g/n/ac network card that can be used with internal or external antennas.

## 2.7 WWAN

Using a SIM card for network connection, your device supports Wireless Wide Area Networking (WWAN).

## 2.8 Power

### 2.8.1 Vehicle DC Power Supply

The Power input voltage range for the vehicle dock is between 10 to 60V DC, without the need to perform any manual operation within the vehicle dock.

This dock provides conditioned power output for the device. By using a specified DC to DC adapter, the input voltage of 100-240 V DC nominal can be accepted.

### 2.8.2 External AC Power Supply (Optional)

If the DC power is not available, you can use an optional external UPS (Universal Input Power Supply) to convert AC power to an appropriate DC level.



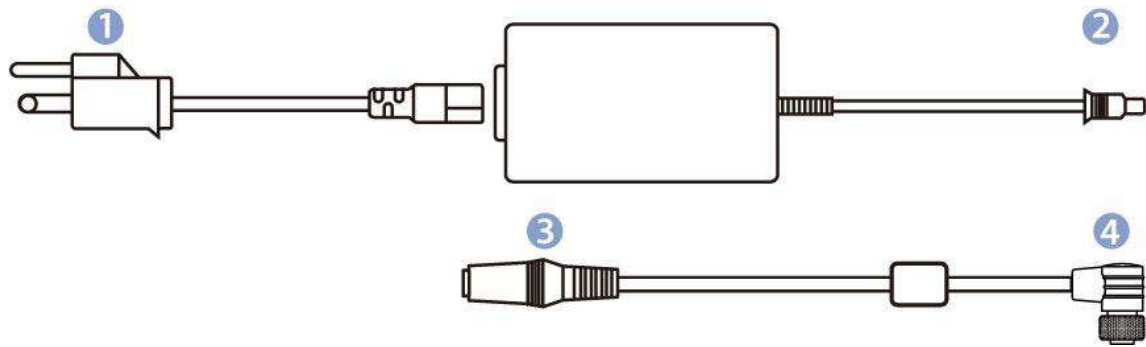

Using an external UPS and adapter cable, the AC to DC power input for the device is transferred to the vehicle dock. To perform the connection, simply plug one end of the adapter cable to the dock and then plug the other end of the adapter cable to the DC output cable from adapter. For Details, refer to the connection diagram shown below:



No	Item
1	AC Input Cable
2	DC Output Cable
3	To DC Output Cable
4	To FM10Q

## 2.9 Power Management Modes

The FM10Q has four power modes: Turn On, Suspend, Wake up, and Turn Off.

Action	Button	LED Indicator
Turn On	 Press the On button for “3 seconds” until the blanking indicator located on the right side On (solid red), and then release the button.	 On
Suspend	 Press the On button for “1 seconds” until the screen On and then release the button. The battery indicator will Off after the screen is Off, the system is already in the standby / sleep mode.	Off
Wake Up	 Press the On button for “1 second” until the screen On and then release the button.	Off
Turn Off	 Press the On button for “2 second” until the system is turns Off and then releases the button.	Off

### 2.9.1 Turn On

When the FM10Q is attached to either vehicle power or an external power supply, or it is operating from the UPS battery and the power button is pressed, the device is in the “ON” mode. In this mode, the keypad, touch screen and any attached peripherals will function normally. The display remains ON until the display, standby or suspend timer expires. When the device is in ON mode, the power LED indicators is off.

### 2.9.2 Suspend

When the device is in Suspend Mode, all LEDs are off. Press the power button to wake up the device back to ON mode.

### 2.9.3 Wake Up

When the device is in Wake Up Mode, all LEDs are off.

### 2.9.4 Turn Off

By default, the FM10Q turns off if the user turns off the device through the system or presses the power button for 10 seconds with a critical shut down. The FM10Q will also be off when there is no connection to a power source or the UPS battery is depleted. However, the internal RTC will keep maintaining the date and time while the device is off.

## **2.10 Power Control**

### 2.10.1 Power Switch

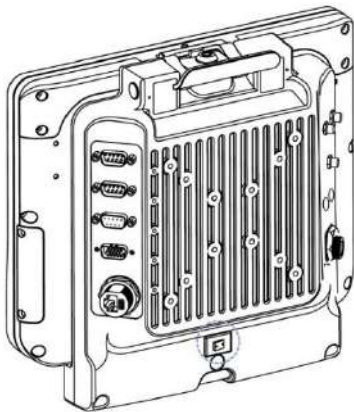

Power switch is located on the rear side of the vehicle dock. When the dock is connected to the external power and the power switch is ON, the dock delivers power to the FM10Q and the device can be powered on.

### 2.10.2 Power Button



Power button is located at the lower right side of the FM10Q. If the device is OFF, pressing the power button will start the power up sequence.



#### **Note:**

- The FM10Q has to be docked in a powered vehicle docking station or UPS battery has to have a sufficient charge to power the device.
- If no external power available and the UPS battery do not have enough charge, pressing the power button will cause no action.

## 2.11 Ignition Control

The FM10Q Vehicle Mount Computer has ignition control feature that enabled by software. For more details please refer to [Winset, Ignition Control](#) section of this user guide.

## 2.12 Battery

Follow all the instructions in this user manual to prolong the battery life-cycle.



**Warning!** Recharge the battery pack according to the instructions in this user manual.  
Avertissement! Rechargez la batterie conformément aux instructions de ce manuel d'utilisation.



**Warning!** There is a risk of an explosion caused by incorrect installation or misapplication of the battery pack.

To avoid possible injury:

- Use only the type of the battery recommended by Winmate.
- Follow battery pack installation instructions in this user manual.
- Keep the battery away from fire.
- Store in a cool dry place.
- Do not expose to heat, water and rain.

**Avertissement!** Il existe un risque d'explosion causé par une installation incorrecte ou une mauvaise utilisation de la batterie.

Pour éviter d'éventuelles blessures:

- Utilisez uniquement le type de batterie recommandé par Winmate.
- Suivez les instructions d'installation de la batterie dans ce manuel d'utilisation.
- Gardez la batterie à l'écart du feu.
- À conserver dans un endroit frais et sec.
- Ne l'exposez pas à la chaleur, à l'eau et à la pluie.



**Warning!** Do not drop, puncture, and crush the battery unit. If you notice any damages on the battery, stop using the battery and replace it.

**Avertissement!** Ne laissez pas tomber, ne percez pas et n'écrasez pas la batterie. Si vous remarquez des dommages sur la batterie, arrêtez d'utiliser la batterie et remplacez-la.



**Important:** When the battery level reaches 0%, the FM10Q will automatically shut down.

### 2.12.1 UPS Battery

Your device has UPS battery. This UPS battery is automatically charged when the device is placed on a powered dock. The charging time takes approximately 3 hours. During full loading operations without external power attached, the device uses UPS battery to operate.

When running on the UPS battery power, the power timeouts maybe different than when vehicle power is applied. Using the UPS battery power, it allows the device to continue operation even when the device is not mounted in a dock. The UPS battery is designed to supply power to your device for a minimum of 30 minutes.



**Important:** If the UPS battery power becomes critically low, the device will automatically hibernate to prevent damage to the UPS battery; To turn on the device using the UPS battery power, make sure the UPS battery has at least 10% charge. If you cannot turn on the device, charge the UPS battery immediately; The internal UPS battery status LED and the UPS battery control panel can be used to monitor the status of the UPS battery.



**Important:** Charge the hot-swap battery together with main battery whenever your device is not being used/ charged for three months. Connect the device to the source of power for 1.5 hours to charge.



**Warning!** If you leave the device without charging for more than three months, the risk of the battery inflation increases.

**Avertissement!** Si vous laissez l'appareil sans charge pendant plus de trois mois, le risque de gonflement de la batterie augmente.

### 2.12.2 Backup Battery

Your device has a backup battery to maintain time, date, and CMOS setup information.



**Important:** The battery is consumable part. Therefore, it is recommended to replace the battery pack every two years with a new one recommended by Winmate. Contact our Service Center or sales representatives for more information on replacing the battery pack.



**Warning!** The backup battery should be replaced only by authorized service personnel.

**Avertissement!** La batterie de secours doit être remplacée uniquement par du personnel de service autorisé.

## 2.13 External Connectors

Power OFF the FM10Q before connecting cables to any port. Most of the external connectors for the FM10Q are located on the vehicle dock.

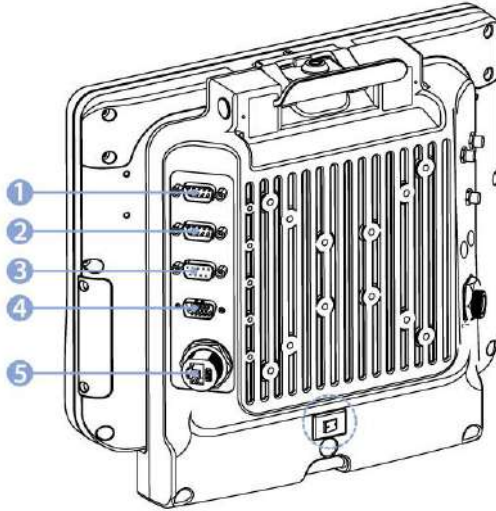

1. COM1 connects to a device such as printer or scanner.
2. COM2 connects to a device such as printer or scanner.
3. USB connects to USB devices such as USB flash drive, mouse, keyboard, printer etc. this USB also accept a dongle cable with a USB host port and a USB Client port.
4. CAN Bus / Audio allows direct linking into vehicle, enable access to wide range of vehicle data and Audio connects to a stereo headset, external speakers or audio recording device.
5. LAN port connects to on access point that provides connection to network.



## 2.13.1 Connector Pin Assignment

### 2.13.1.1 Serial Connector (COM1, COM2)

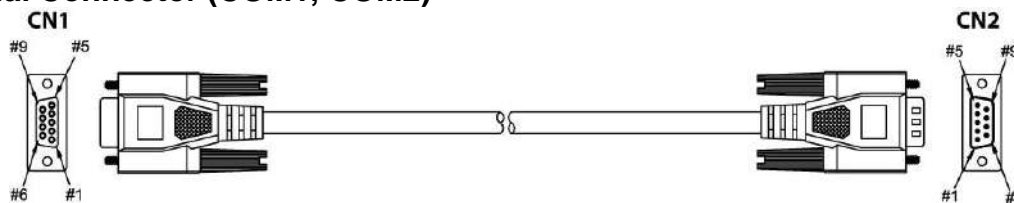

#### CN1

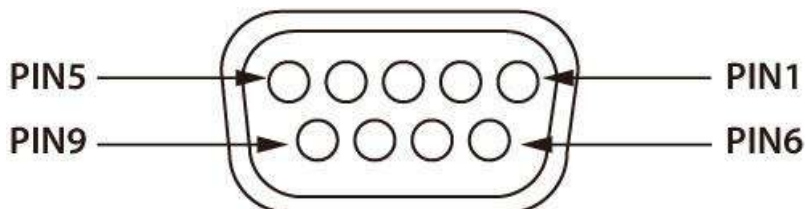

Pin	Signal	Description
CN1-1	DCD	Data Carrier Detect – Input
CN1-2	RXD	Receive Data – Input
CN1-3	TXD	Transmit Data – Output
CN1-4	DTR	Data Terminal Ready – Output
CN1-5	GND	Signal / Power Ground
CN1-6	DSR	Data Set Ready – Input
CN1-7	RTS	Request to send – Output
CN1-8	CTS	Clear to send – Input
CN1-9	5V	Power

#### CN2

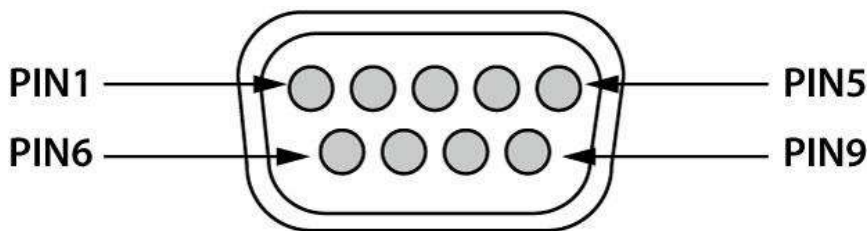

Pin	Signal	Description
CN2-1	DCD	Data Carrier Detect – Input
CN2-2	RXD	Receive Data – Input
CN2-3	TXD	Transmit Data – Output
CN2-4	DTR	Data Terminal Ready – Output
CN2-5	GND	Signal / Power Ground
CN2-6	DSR	Data Set Ready – Input
CN2-7	RTS	Request to send – Output
CN2-8	CTS	Clear to send – Input
CN2-9	5V	Power



### 2.13.1.2 USB 2.0 (DB9 Male) Connector CN1

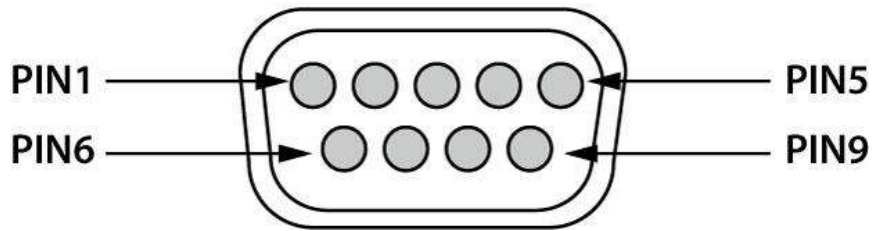
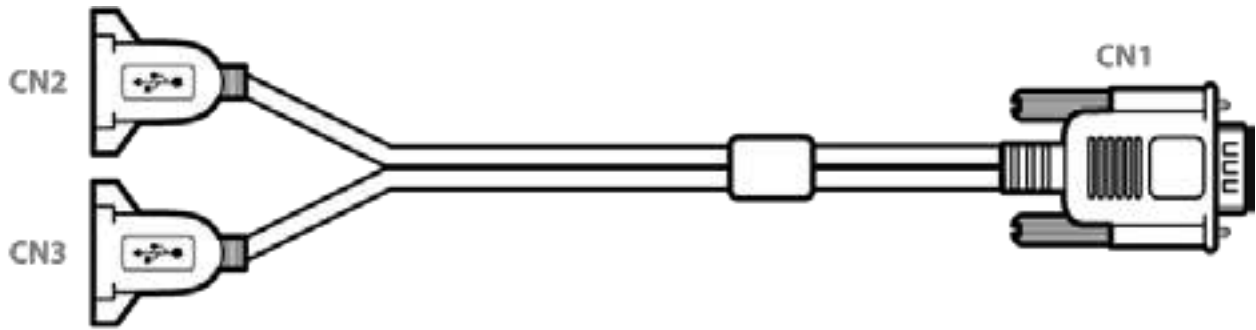

Pin	Signal
CN1-1	GND
CN1-2	USB1_D+
CN1-3	USB1_D-
CN1-4	USB1_VCC
CN1-5	GND
CN1-6	GND
CN1-7	USB2_D+
CN1-8	USB2_D-
CN1-9	USB2_VCC

### CN2, CN3



Pin	Signal	Description
CN2-1	USBVCC1	Red
CN2-2	USB1_DM	White
CN2-3	USB1_DP	Green
CN2-4	GND	Black

### 2.13.1.3 USB 2.0 (DB9 Male) to Serial Port (COM3) & USB Type A Cable

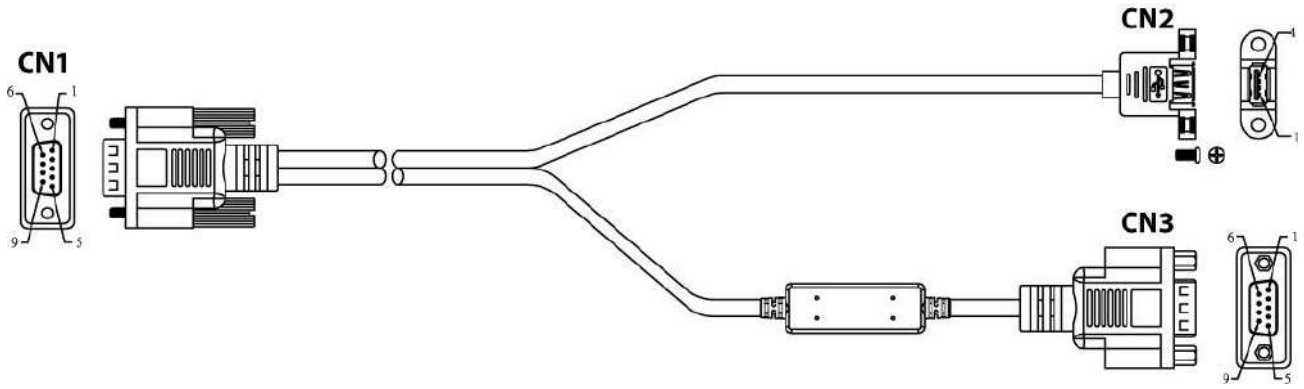

#### CN1

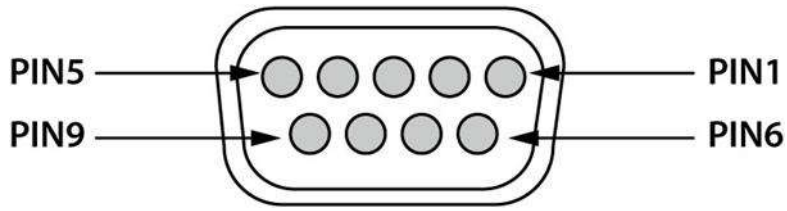

Pin	Signal
CN1-1	GND
CN1-2	USB1_D+
CN1-3	USB1_D-
CN1-4	USB1_VCC
CN1-5	GND
CN1-6	GND
CN1-7	USB2_D+
CN1-8	USB2_D-
CN1-9	USB2_VCC

## CN2



Pin	Signal	Description
CN2-1	USBVCC1	Red
CN2-2	USB1_DM	White
CN2-3	USB1_DP	Green
CN2-4	GND	Black
CN3-1	USBVCC2	Red
CN3-2	USB2_DM	White
CN3-3	USB2_DP	Green
CN3-4	GND	Black

## CN3

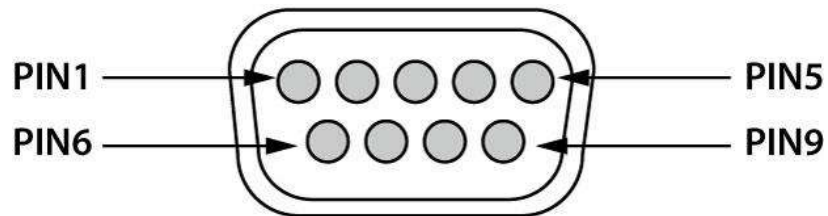

Pin	Signal
CN3-1	GND
CN3-2	USB1_D+
CN3-3	USB1_D-
CN3-4	USB1_VCC
CN3-5	GND
CN3-6	GND
CN3-7	USB2_D+
CN3-8	USB2_D-
CN3-9	USB2_VCC

2.13.1.4 CANBus / Audio Connector

CAN Bus Cable

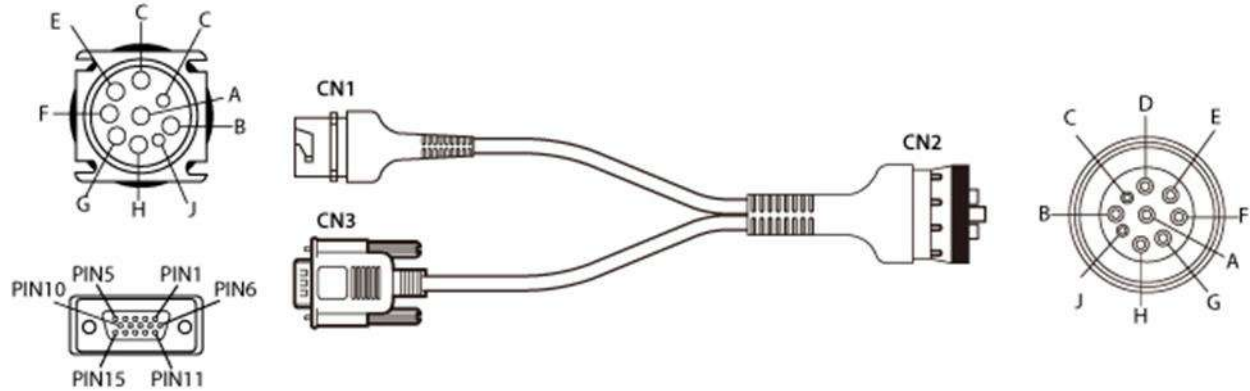

Pin No.	Signal	Pin No.	Signal
CN1-A	CAN_GND	CN3-3	CAN_GND
CN2-A	CAN_GND	CAN3-15	5V
CN1-B	CAN_V+		
CN2-B	CAN_V+	CN3-13	CAN_H
CN1-C	CAN_H		
CN2-C	CAN_H	CN3-2	CAN_L
CN1-D	CAN_L		
CN2-D	CAN_L	CN3-12	CAN_SHLD
CN1-E	CAN_SHLD		
CN2-E	CAN_SHLD	CN3-5	GND
CN3 SHELL			

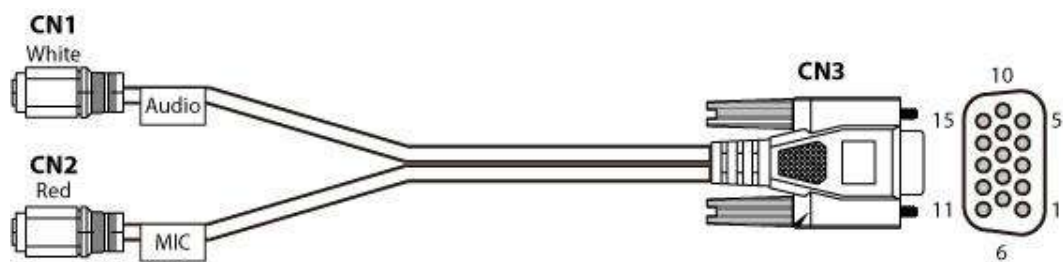

Pin No.	Symbols	Pin No.	Symbols
CN2-3	MIC	CN3-8	MIC_L
CN2-1	GND	CN3-9	AUGND
CN1-1	GND	CN3-1	HP_JD
CN1-2	Right	CN3-7	AUGND
CN1-3	Left	CN3-6	HP_R
		CN3-10	HP_L

### 2.13.1.5 LAN Connector

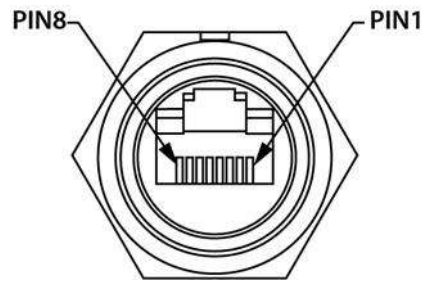

Pin No.	Symbols
1	TX_D1+
2	TX_D1-
3	RX_D2+
4	BI_D3+
5	BI_D3-
6	RX_D2-
7	BI_D4+
8	BI_D4-

### 2.13.1.6 Power Connector

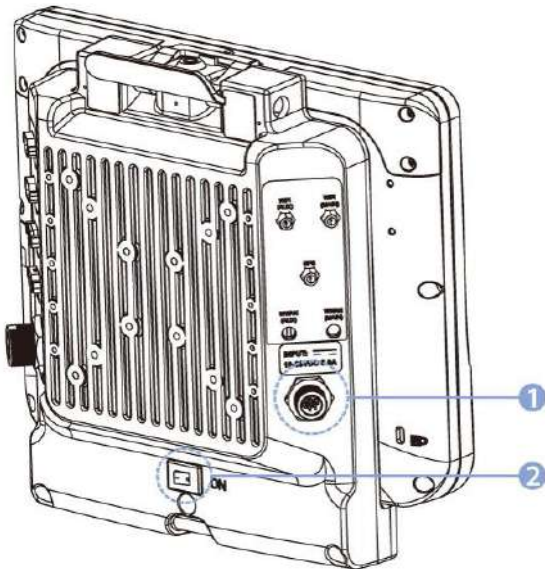

1. Power Connector
2. Power Switch

**Power Connector**

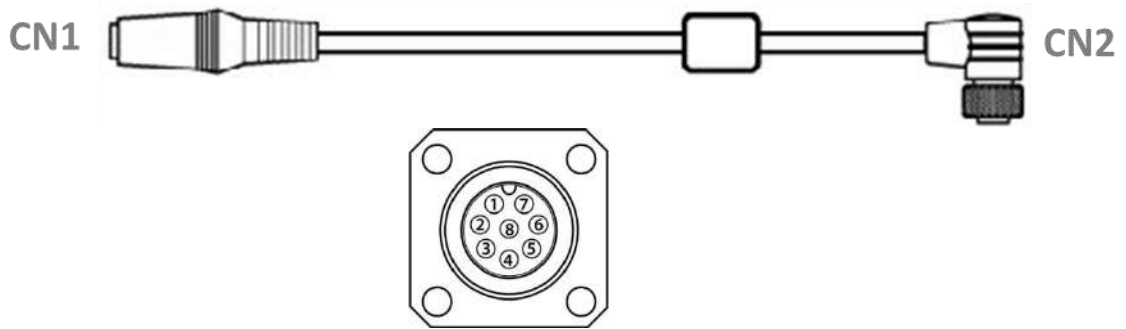

Pin No.	SYMBOL
CN2-1	VIN +
CN2-2	VIN +
CN2-3	VIN -
CN2-4	VIN -
CN2-5	Earth_GND
CN2-6	VIN +
CN2-7	VIN +
CN2-8	Ignition

Pin No.	SYMBOL	Pin No.	SYMBOL
CN1-2	VIN -	CN2-3	VIN -
		CN2-4	VIN -
		CN2-5	VIN -
CN1-1	VIN +	CN2-1	VIN +
		CN2-2	VIN +
		CN2-6	VIN +
		CN2-7	VIN +
		CN2-8	IGN_ISO

## 2.14 CANBus Cable Installation Reference

After connecting the CAN Bus cable to the FM10Q, please open software utility to check settings.

		COM1	COM2	COM3*	USB	CAN Bus	Audio
Disable Bus	CAN	V	V	V	V	X	V
Enable Bus	CAN	X	X	V	V	V	V

**Note:** COM3 is located on the external cable (supplied with the FM10Q).

## 2.15 Antenna Connections

The FM10Q equipped with internal antennas on the Computer side as well as external antennas on the Vehicle Dock side. When the FM10Q Computer is on the Vehicle Dock, it will by default use the external antennas on the Dock that are attached through the SMA Connectors for better signal strength. Only when the FM10Q computer is removed from the dock will it use the internal antennas. GPS and WWAN are optional on the device and require external remote mount antennas.

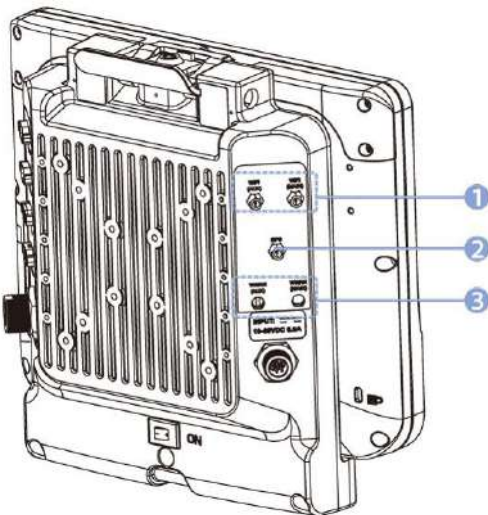

1. WLAN Main External Antenna Connector (Default)  
WLAN Auxiliary External Antenna Connector (Default)
2. GPS External Antenna Connector (Optional)
3. WWAN External Antenna Connector (Optional)

## 2.16 External/ Vehicle Remote Antenna

The FM10Q vehicle dock is equipped with SMA Connector for additional external antenna (WLAN or optional WWAN), to install the antenna please perform the following:

1. Remove the rubber cap on the SMA connector before installing the antenna.
2. Align the antenna with the SMA connector and fasten it as following picture.

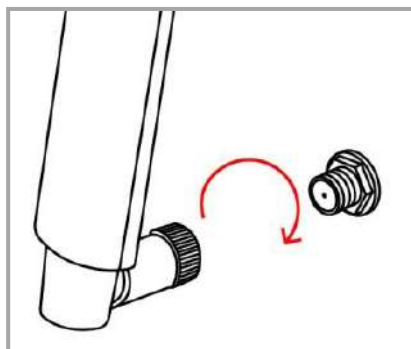

3. Adjust the position of external antennas.

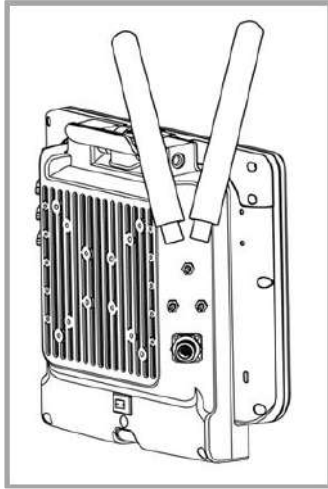

• **WLAN Antenna Installation**

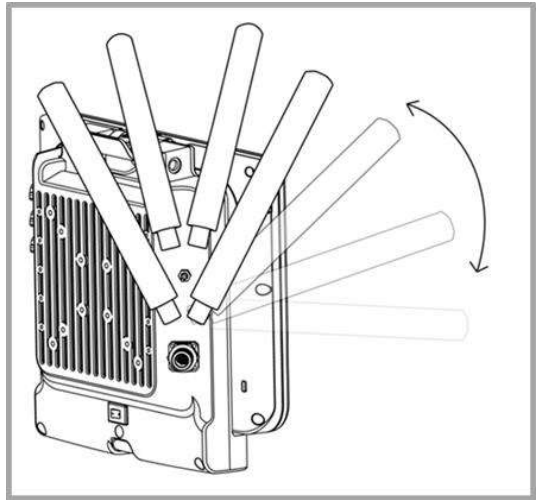

• **WLAN and WWAN Antenna Installation**

4. Attach plastic fixing bracket to fix the position of each antenna.

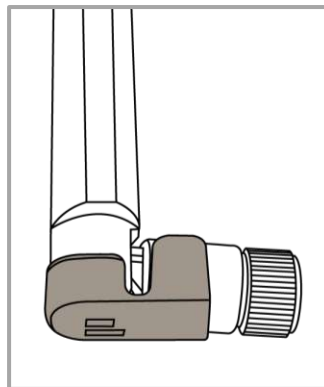
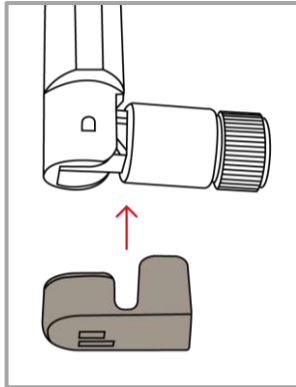



## 2.17 Keyboard Options

### 2.17.1 Integrated Keypad

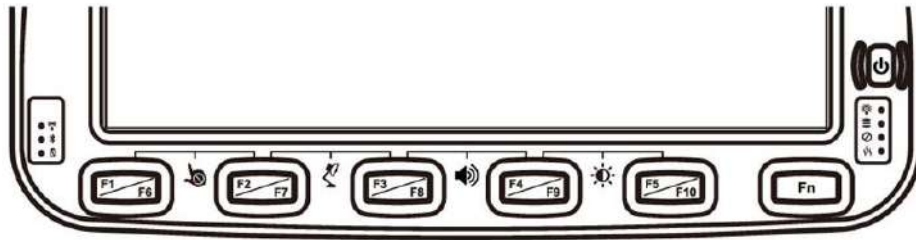

The integrated keypad contains ten programmable keys, F1~ F10 are user programmable keys. Key Mapping is configured via the Hot Tab application on the control panel. See Programmable key to remap these keys.

The default values for these keys are:

Function Key	Default Key Value
F1 + F2	Touch Keypad Lock/ Unlock
F2 + F3	Lamp On/Off
F3 + F4	Volume adjustment
F4 + F5	Brightness adjustment
Long Press F5	Camera
Press Fn, and then press F6~F10	Function key form F6~F10

**Note:** Sign plus “+” means that you have to press both function keys at the same time.

### 2.17.2 USB Keyboard/ Mouse

A standard USB keyboard or mouse can be attached to the FM10Q using the appropriate adapter cable. The cable attached to the device and provides USB connector.



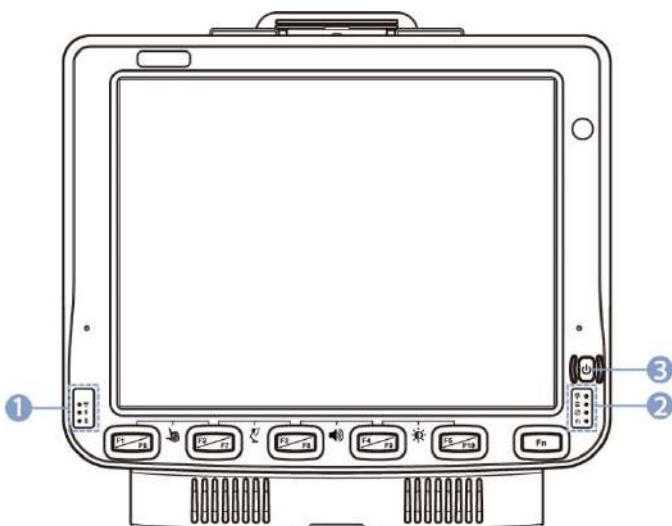

## 2.18 LED Function

LED indicators are located on the front panel with the left and right sides.





1. Connection and UPS battery LEDs
2. System LEDs
3. Power LED

### 2.18.1 Connection and UPS battery LEDs

Indicator Type	LED Behavior	System State
 Power	Solid Red	System off and in suspend mode
	Off	System On
 WLAN	ON	The Device has detected a network and is connecting
	Off	No Network connection
 BT	ON	The devices are successfully connected and active.
	Off	The BT function is disabled
 UPS Battery	Orange	The external power is plugged in and the UPS battery is being charged.
	Green	The UPS battery is in use and its power level is more than 40%
	Red	The UPS battery is in use and its power level is less than 40% and more than 10%
	Blinking Red	The UPS battery is low (<15%)
	OFF	The external power is plugged in and the UPS battery is fully charged The device is mounted on the vehicle dock and the UPS battery is fully charged

### 2.18.2 System LEDs

Indicator Type	LED Behavior	System State
 (No function)	-	-
 Blanking Indicator	Solid Red	Blanking function is ON
	OFF	Blanking function is OFF
 Defroster Indicator	Solid Red	The Defroster is ON
	OFF	The Defroster is OFF

**Note:** Defroster is a customized feature available by request.

**Note:** For the defroster function, please connect a device to a power supply.

### 2.18.3 Power LED

Power LED is located on the power button. Power LED behavior is shown at the table below.

Indicator Type	LED Behavior	System State
 Power	Solid Red	System off and in suspend mode
	OFF	System On

## 2.19 Display

The FM10Q display measures 10.4-inches diagonally, have display resolution of 1024 x 768 pixels and bonded with Projected Capacitive (P-CAP) multi-touch.

### 2.19.1 Touch Screen

The touch screen is a Projected Capacitive (PCAP) multi-touch; the technology offers a fast and sensitive response and professional-grade reliability combined with a stylish, sleek design. P-CAP multi-touch offers fast and sensitive touch response, excellent optical clarity and long-term stability over temperature.



**Note:**

Always use the tip of the stylus for tapping or making strokes  
Do not use any sharp objects for tapping, touching, or making strokes

### 2.19.2 Display Backlight Control

This device is equipped with automatic brightness adjustment that controls the screen brightness according to the lighting environment. To enable automatic brightness adjustments go to **Settings > Display > Brightness > Tap Auto**.

## Chapter 3: Software

### 3.1 Introduction

This section includes the software and hardware installation, the FM10Q configuration, the wireless communication, and some other optional features. Since this FM10Q is bundled with several software and utility programs for its configurations and operations, the examples describe in this section are to be used as a guideline only; therefore, the function configuration of the device might vary.

#### 3.1.1 Operating System

The operating system of the FM10Q is Android 9.0.

#### 3.1.2 About Android 9.0



We assume you are very familiar with various features and options of Android OS. Therefore, this section will describe the specific software and utility programs that related to the device usage and the Android OS.

### 3.2 Setting up the Device

When you first turn on your device, you'll see a **Welcome screen**. Choose the language you want and touch **Start** or the Start icon. When prompted, you can sign in with your Google Account or create one at that time. You can also choose to skip this step and create one later.

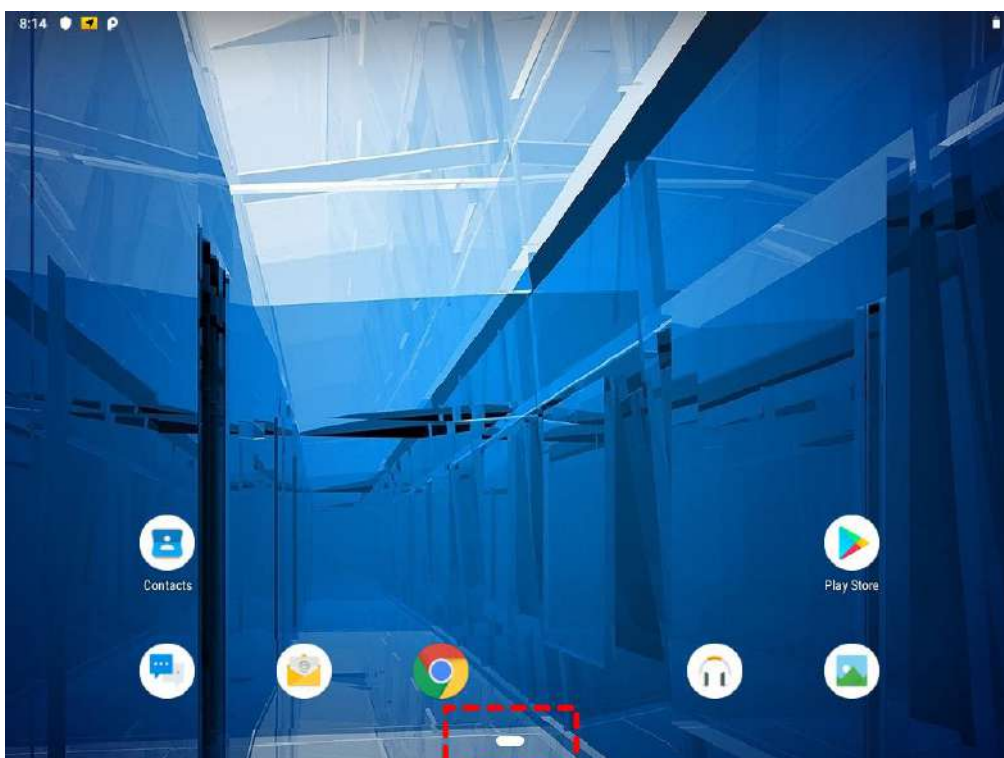
#### 3.2.1 Home Screen



Icon	Description
	<b>Back</b> Opens the previous screen you were working in, even if it was in a different app. Once you back up to the Home screen, you can't go back any further.
	<b>Home</b> Returns to the Home screen. To get suggestions based on the screen you're currently viewing, touch & hold this button.

Some apps hide these buttons temporarily, or fade them to small dots in the same position. To bring them back, touch the dots, touch the screen in the middle, or swipe up from the bottom.

Many screens in apps and Settings include a **menu**  icon at the top right of the screen. Touch it to explore additional options, including Help & feedback.

*To add an app to a Home screen:*

1. Go to the Home screen where you want to place the app.
2. Swipe up.
3. Swipe up and down to find the app you want.
4. Touch & hold the app until the Home screen appears, slide it into place, and lift your finger.

*To remove an app icon from the Home screen without removing it permanently from your device, touch & hold it, slide your finger toward the top of the screen, and drop the app over Remove in the top left.*

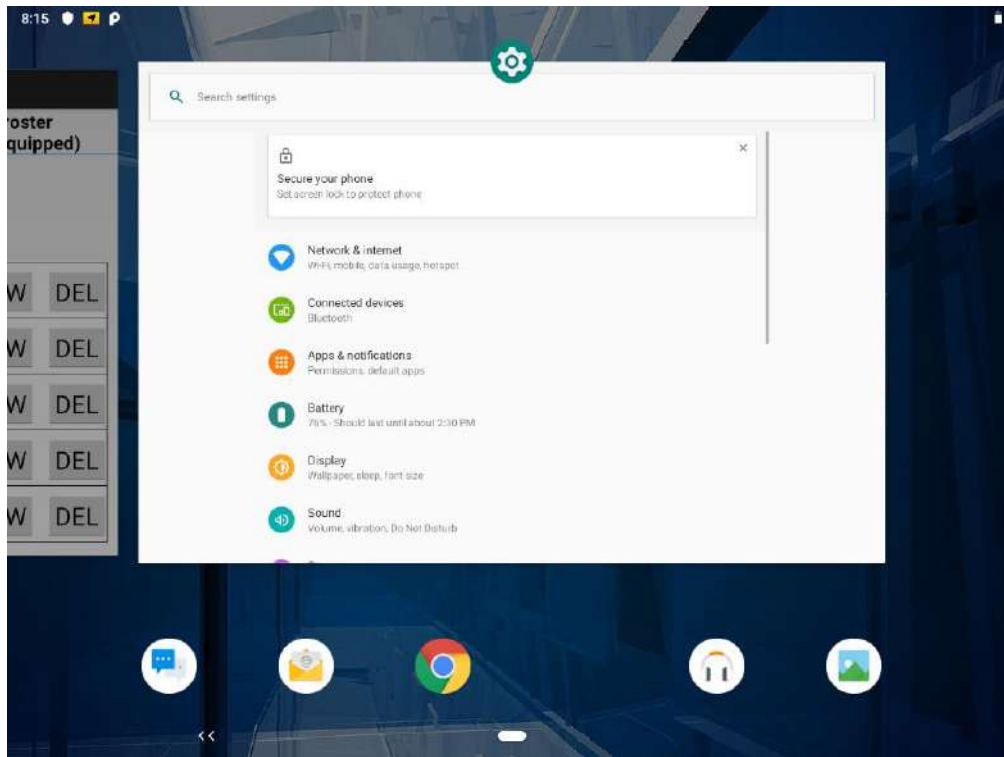



### **3.2.2 Quick Settings**

You can open your device's Settings app from the All Apps screen or from Quick Settings.

For example, to change notification sounds, and volume go to Settings  > Device > Sound to change the volume.

Use Quick Settings to easily change frequently used settings, like turning on WLAN. To open Quick Settings, swipe down from the top of the screen with two fingers. To change a setting, just touch the icon:

- **Display brightness:** Slide  to lower or increase the brightness of your screen.
- **WLAN network:** Turn Wi-Fi  on or off or open the Wi-Fi settings menu.
- **BT settings:** Turn Bluetooth  on or off or open the Bluetooth settings menu.

**Auto-rotate:** Lock your device's orientation  in portrait or landscape mode.

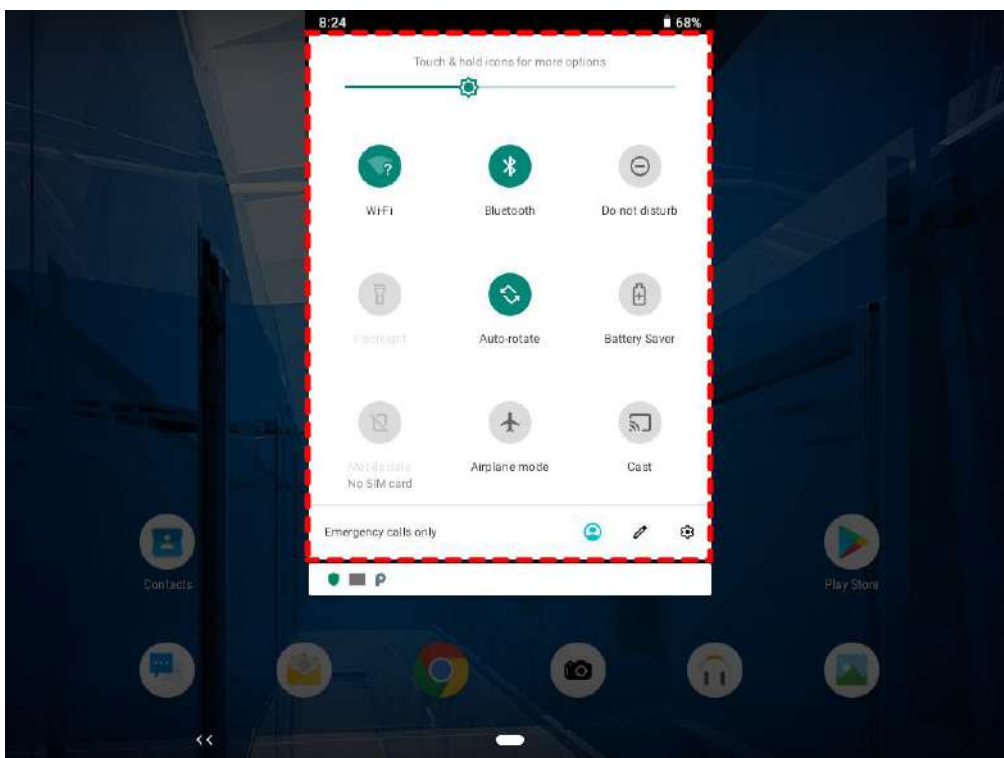
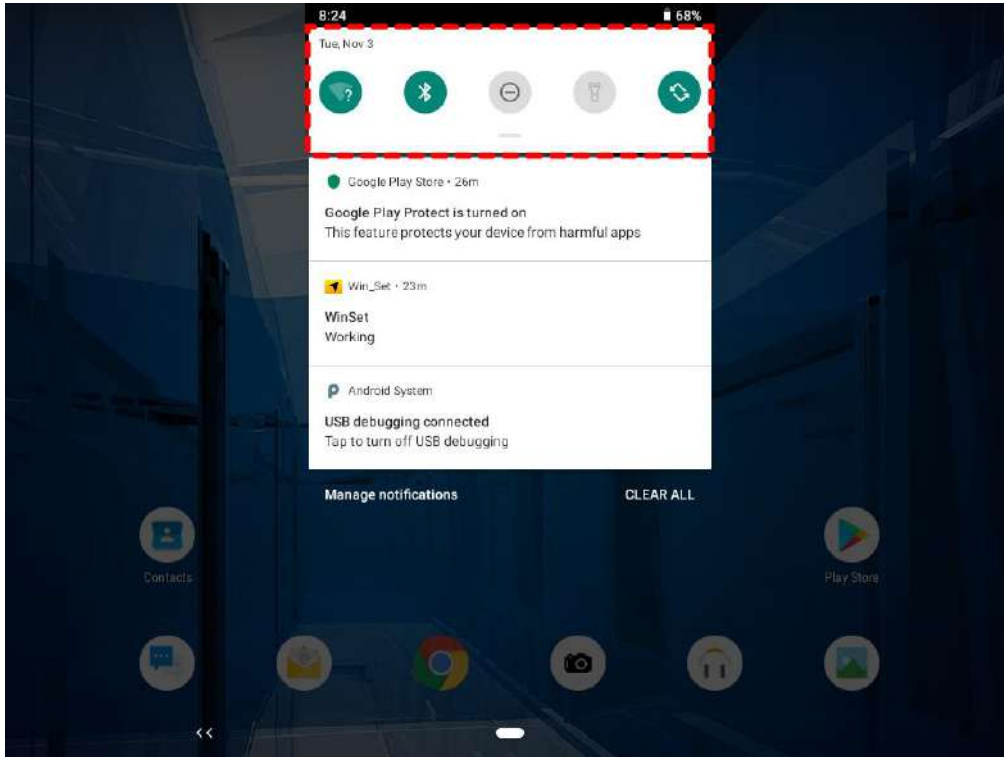

Touch **Settings**  icon to open the main Settings menu.



### 3.3 Status and Notification Icons

To open the status bar appears at the top of every screen. On the left are notification icons and on the right are status icons, along with the current time.



Notification icons

Status icons

#### 3.3.1 Status Icons

Pull down from the right top of the screen to get the notifications area. The following icons indicate the status of your device, for example if users are connected to a WLAN network that is not connected to the internet, the network icons are appears in white color.

Status icons that appear in the status bar are as follows:

	Connected to GPRS mobile network		Bluetooth is on
	Connected to 1xRTT mobile network		Connected to a Bluetooth device
	Connected to EDGE mobile network		No SIM card installed
	Connected to 3G mobile network		Vibrate mode
	Connected to 4G mobile network		Ringer is silenced
	Mobile network signal strength		Battery is very low
	Searching for a network signal		Battery is low
	No signal		Battery is partially drained
	Connected to a Wi-Fi network		Battery is full
	Roaming		Battery is charging
	Airplane mode		Receiving location data from GPS

#### 3.3.2 Notification Icons

Pull down from the left top of the screen to get the notifications area. The following icons indicate that you have received notification

	New email message		Incoming call
	New text or multimedia message		Missed call
	Alarm is set		Speakerphone is activated
	Upcoming event		Phone microphone is muted
	Data is syncing		Downloading data
	Problem with sign-in or sync		Phone is connected via USB cable
	A screenshot is captured		

## 3.4 Control Panel

### 3.4.1 Using the Touch Screen

The touch screen is a touch-sensitive device that allows you to control and make selections on the device by controlling the location of the pointer on the screen.



**Note:**

Do not use sharp or pointed objects on the touch screen. These objects may scratch the screen. Use only the stylus pen or the tip of your finger.

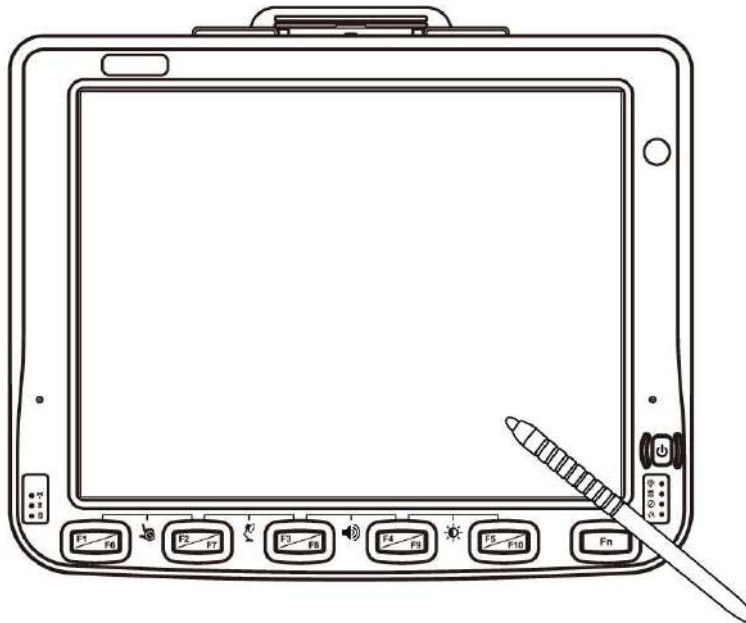

The touchpad supports the core gestures for Android.

Gesture	Action	Description
Single Touch		To select or activate something
Double-touch		Tap quickly twice on a webpage, screen, or App to zoom
Touch and hold		Touch and hold an item on the screen by touching it and not lifting your finger until it respond
Swipe or slide		Quickly move the finger across the surface of the screen. i.e. slide a lock screen to open the lock



## 3.4.2 System Settings

### 3.4.2.1 Display

In the Android 8.1 user can adjust the screen brightness. Pull down from the top of the screen to get the notifications area. You can also access display settings in settings:

To adjust the brightness of the screen:

1. **Settings**  > **Display**  > **Brightness Level**

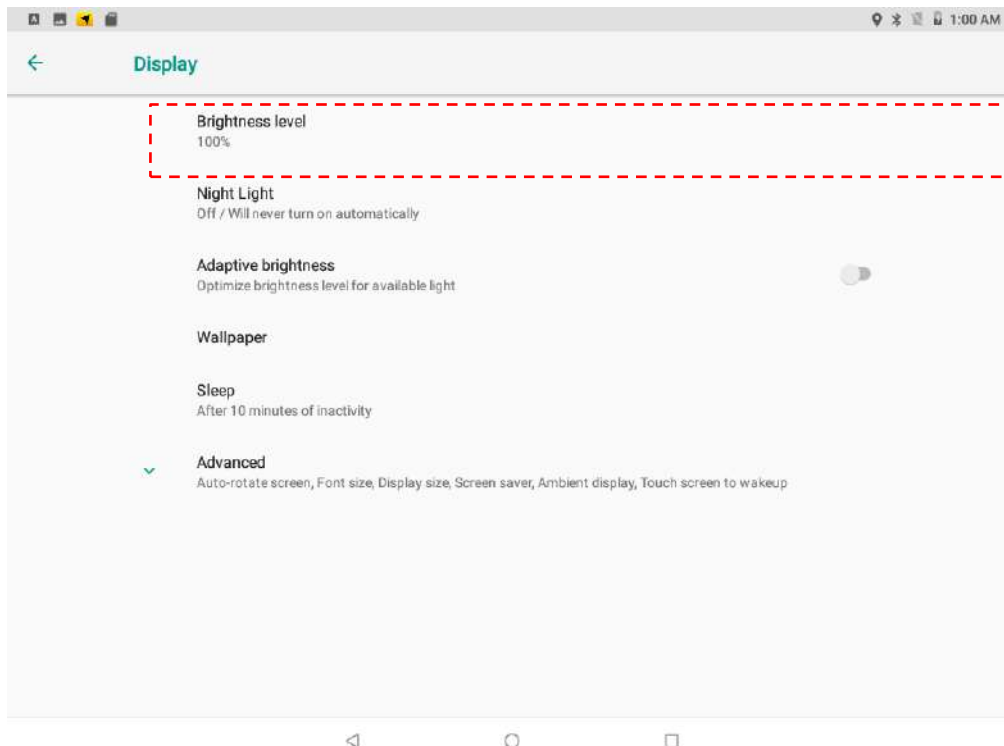
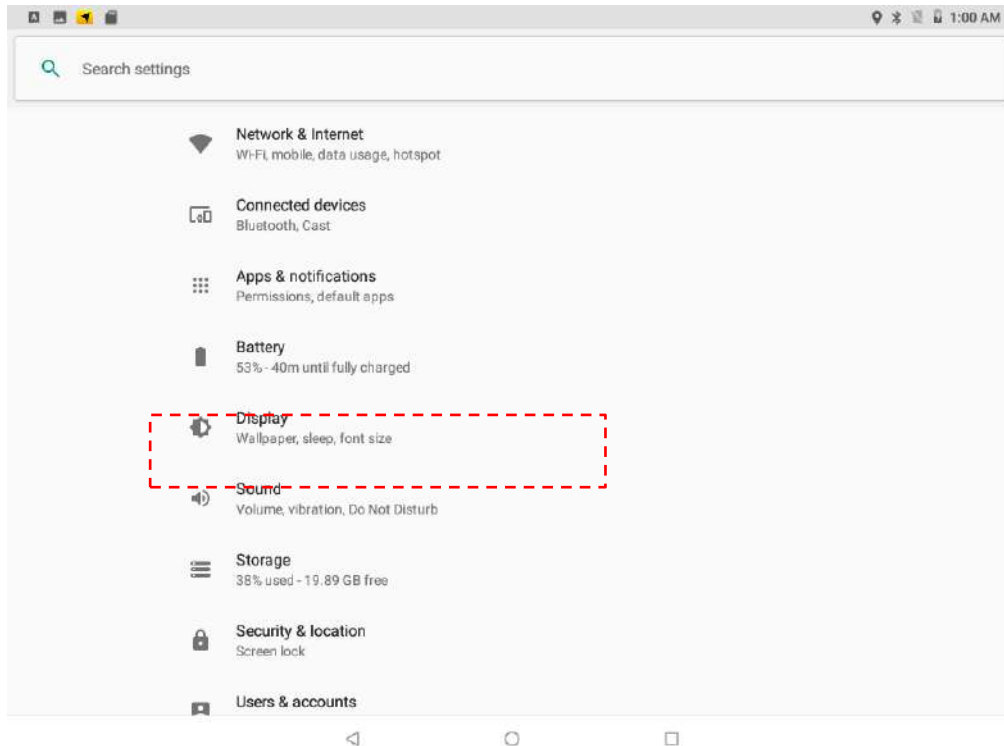

Tap the cursor to the left to reduce the screen brightness.  
Tap the cursor to the right to increase the screen brightness

### 3.4.2.2 Region and Language

The instruction for installing, changing and uninstalling language in this section are applicable to FM10Q with Android OS.

To access region and language settings, perform the following:

**Settings**  > **System**  > **Language & Input**  > **Languages** 

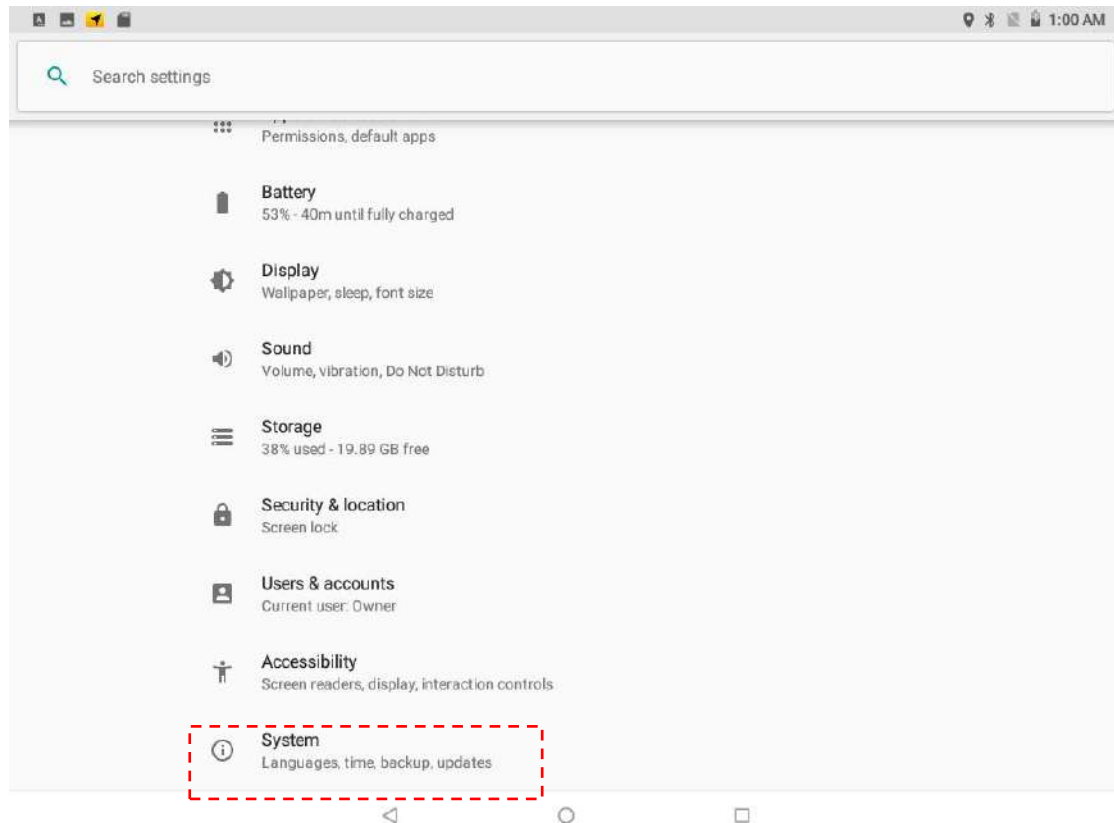

The FM10Q is shipped with English language settings by default.

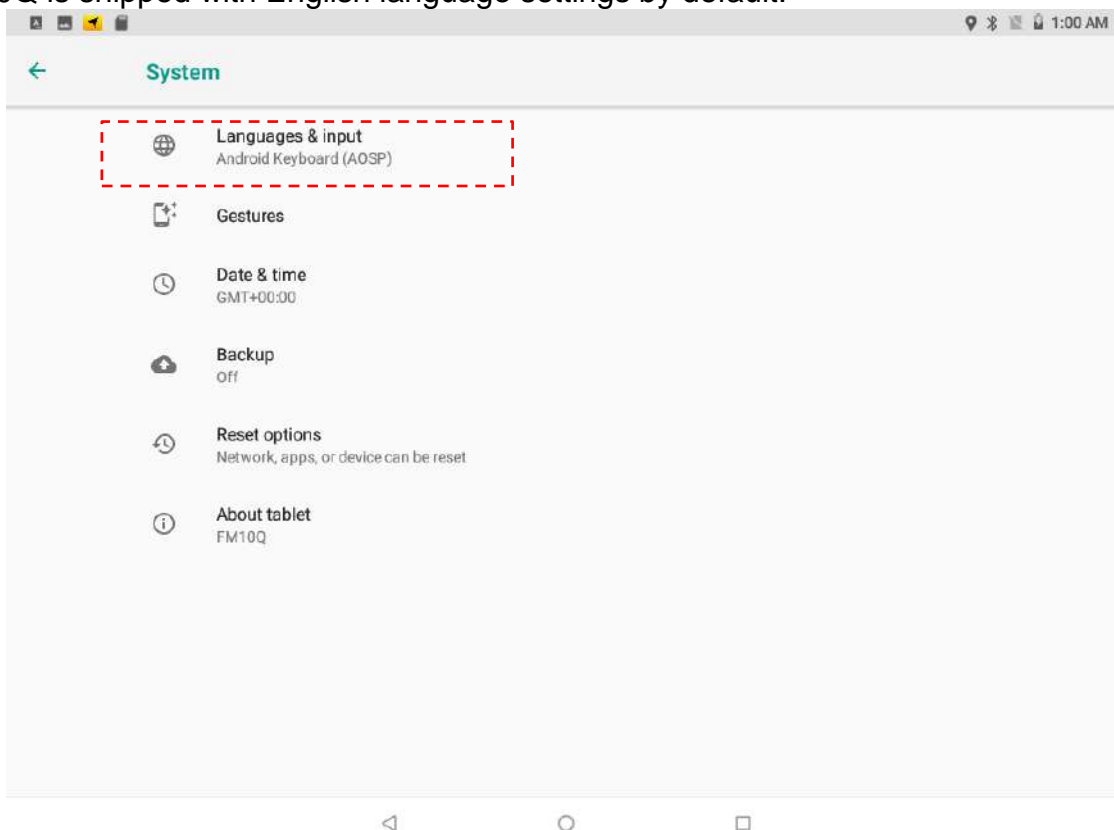

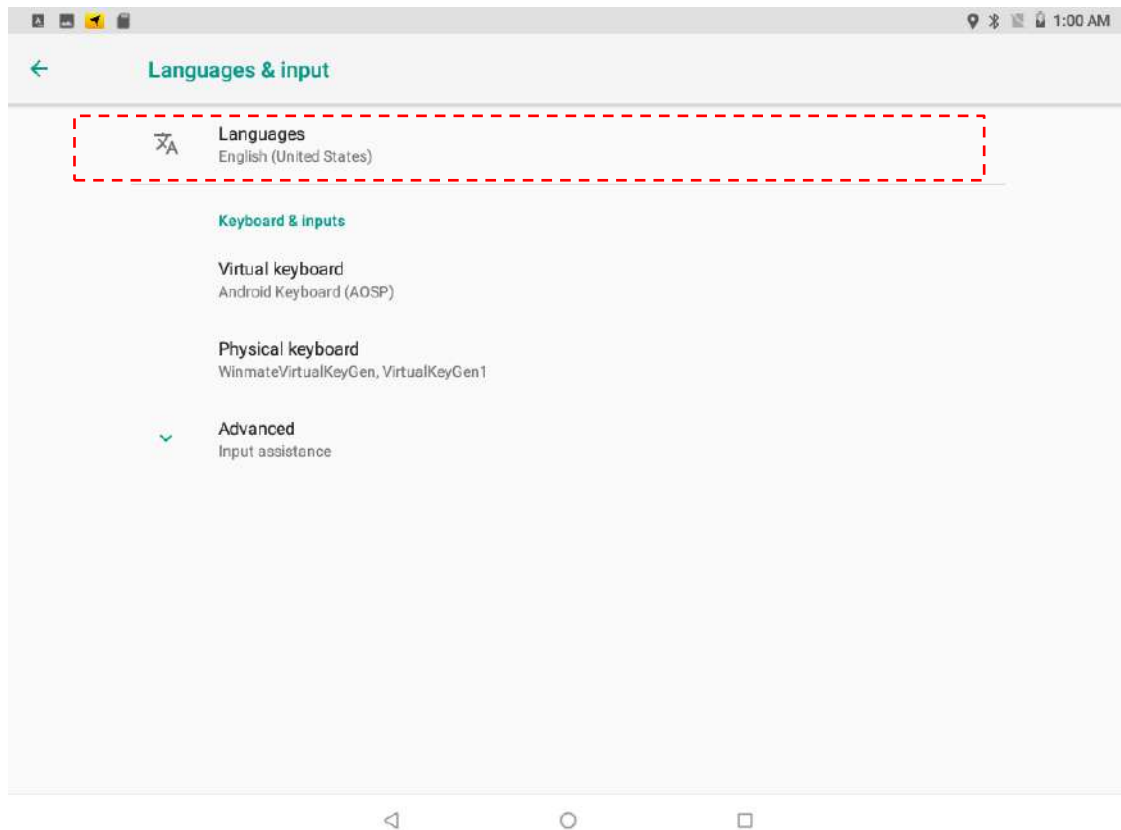

### 3.4.2.3 Sound

To access sound settings, perform the following:

**Settings**  > **Sound**

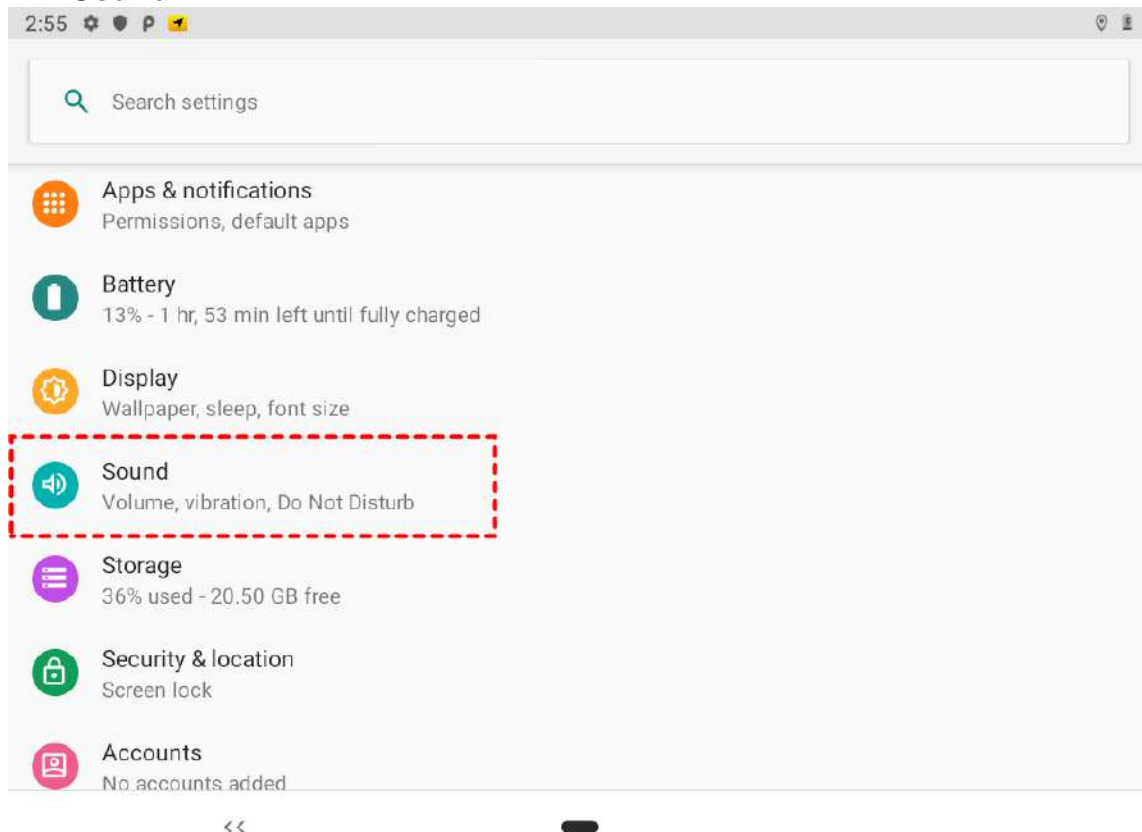

In this option you can adjust volume, change phone ringtone, and other volume settings.

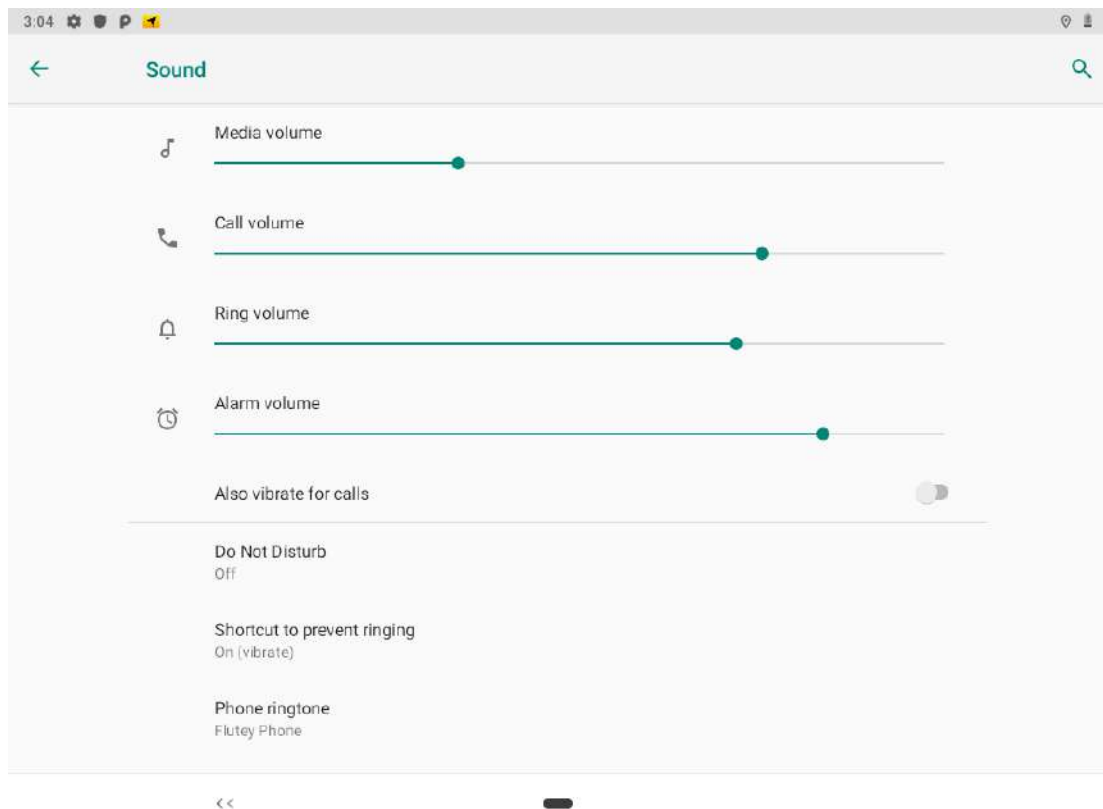

#### 3.4.2.4 Touch Lock

Press **F1** and **F2** simultaneously to perform touch lock. While the touch is locked, all function keys and touch will not be able to work, until you slide the bar to unlock the touch lock.

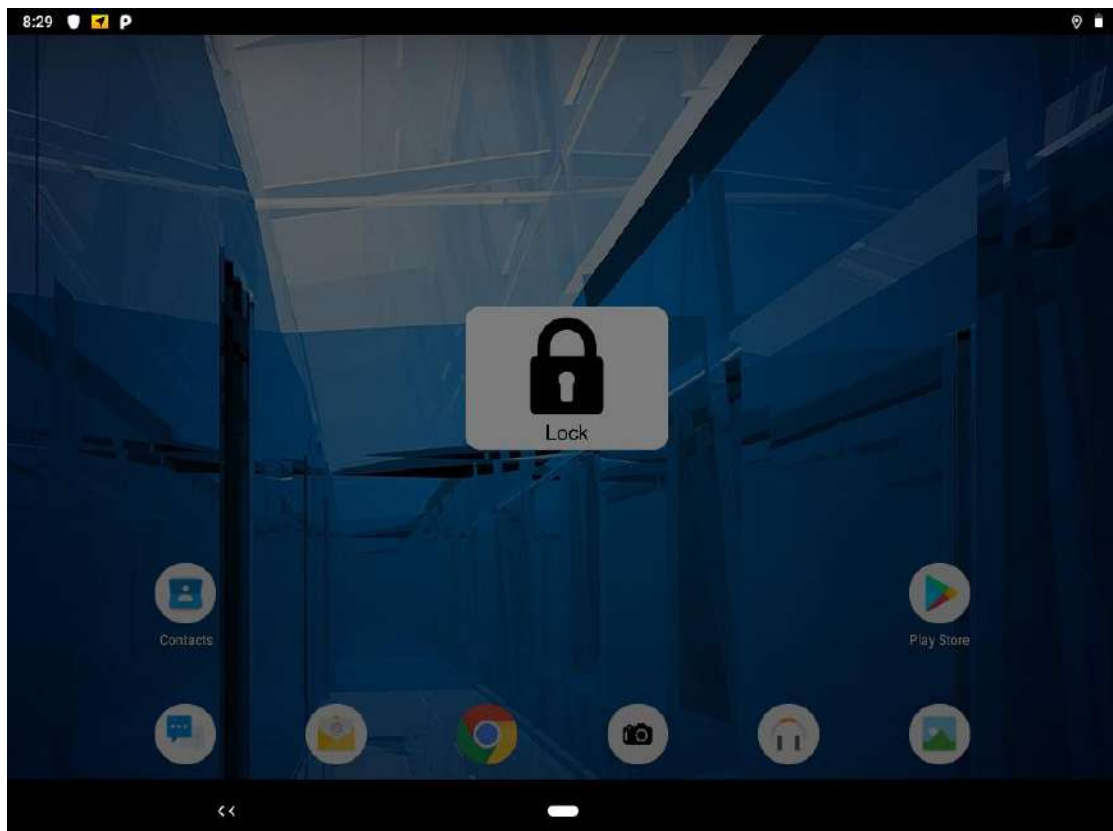

Press **F1** and **F2** simultaneously one more time to perform unlock touch function, or you can slide the bar to unlock the touch lock.

### 3.4.2.5 Reading Lamp

Press **F2** and **F3** button simultaneously to turn On/Off a reading lamp located at the bottom of the dock. This lamp is to provide illumination for user to read in the dark environment.

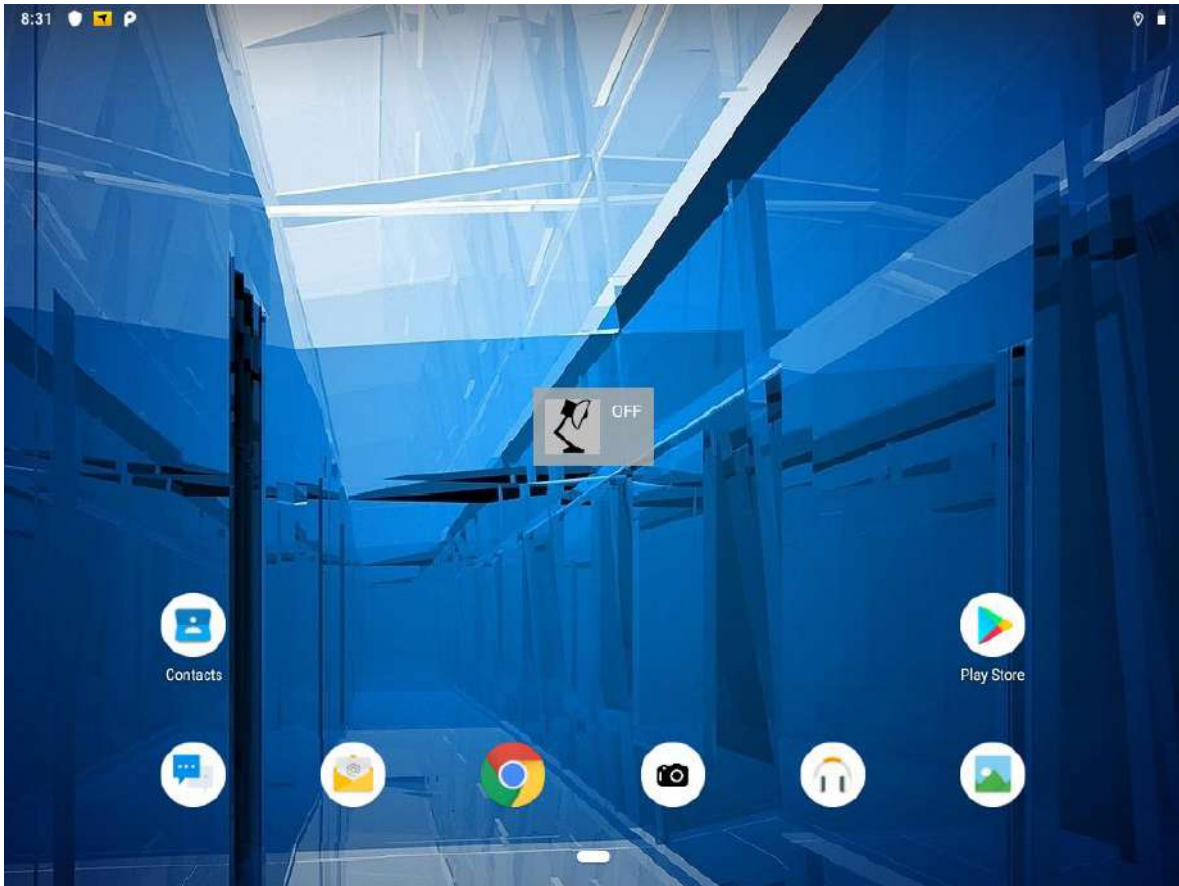

Lamp Off

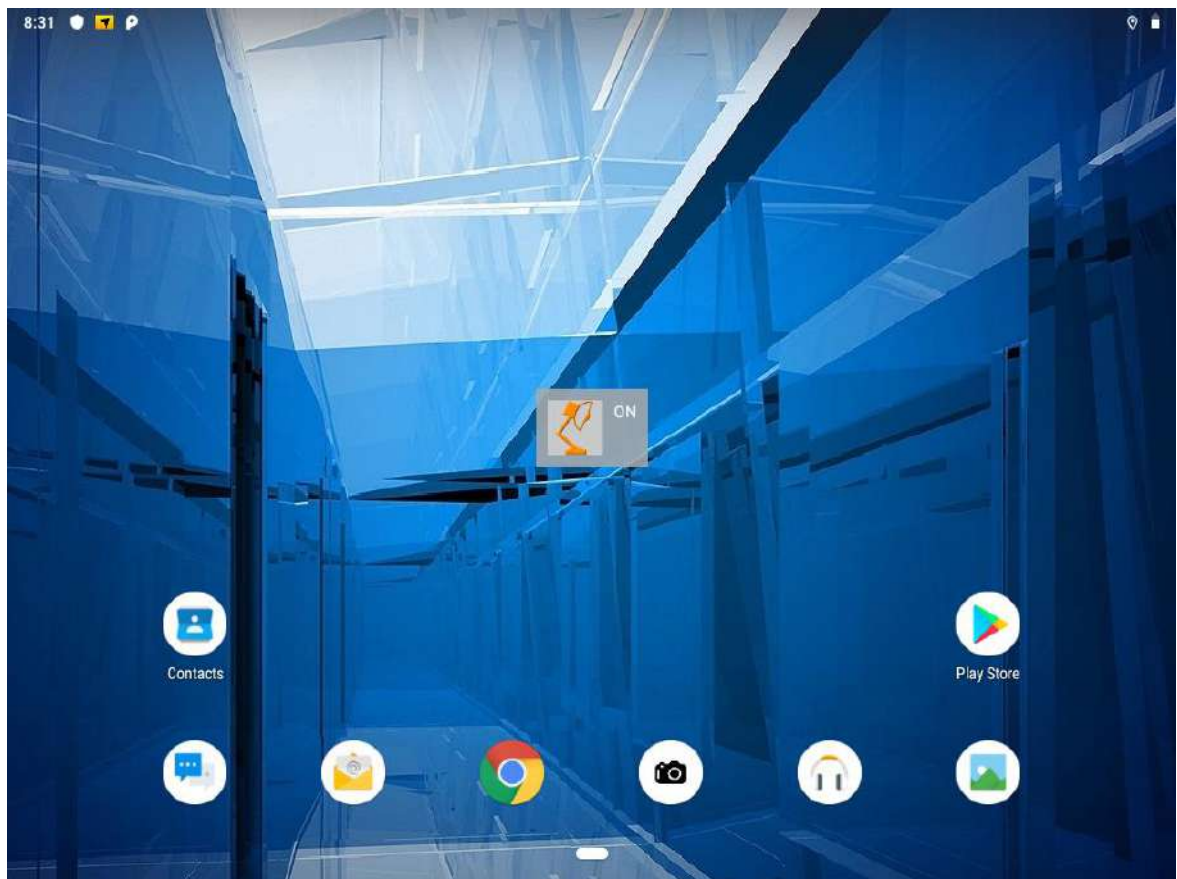

Lamp On



### 3.4.2.6 Volume Adjustment

Press **F3 and F4** simultaneously to perform volume adjustment. The adjustment slide bar will appear on the right side of the screen. Slide to the right side to increase the volume and slide to the left side to decrease the volume.

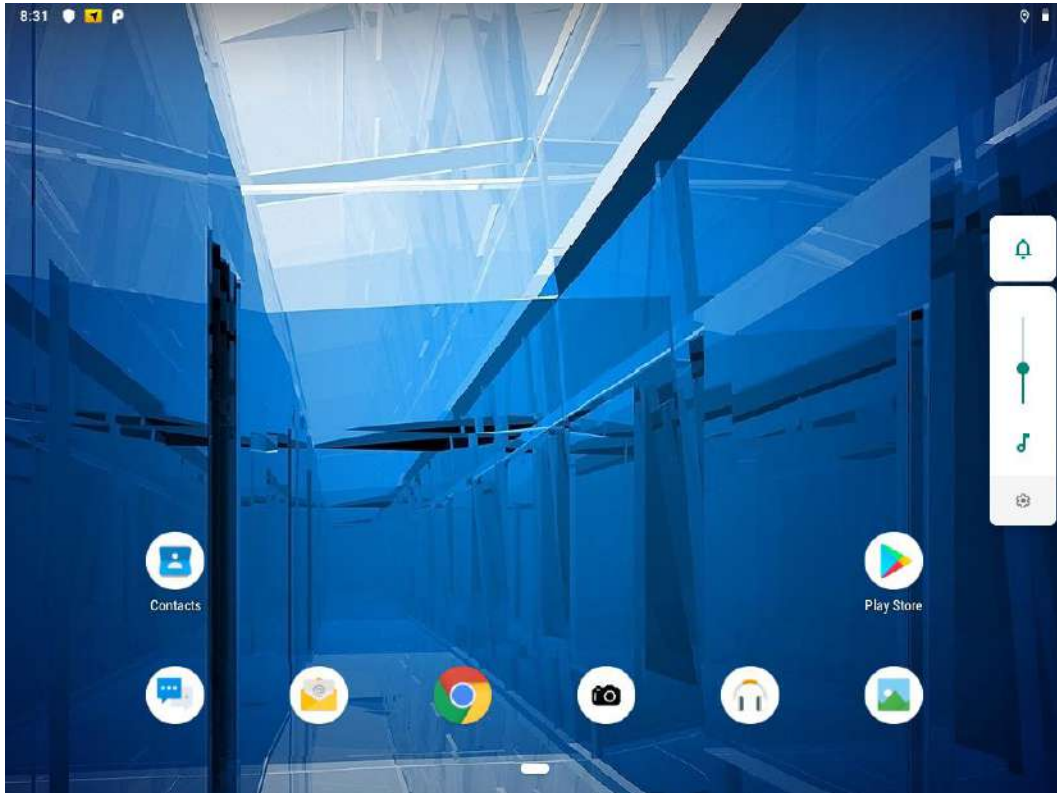

### 3.4.2.7 Brightness

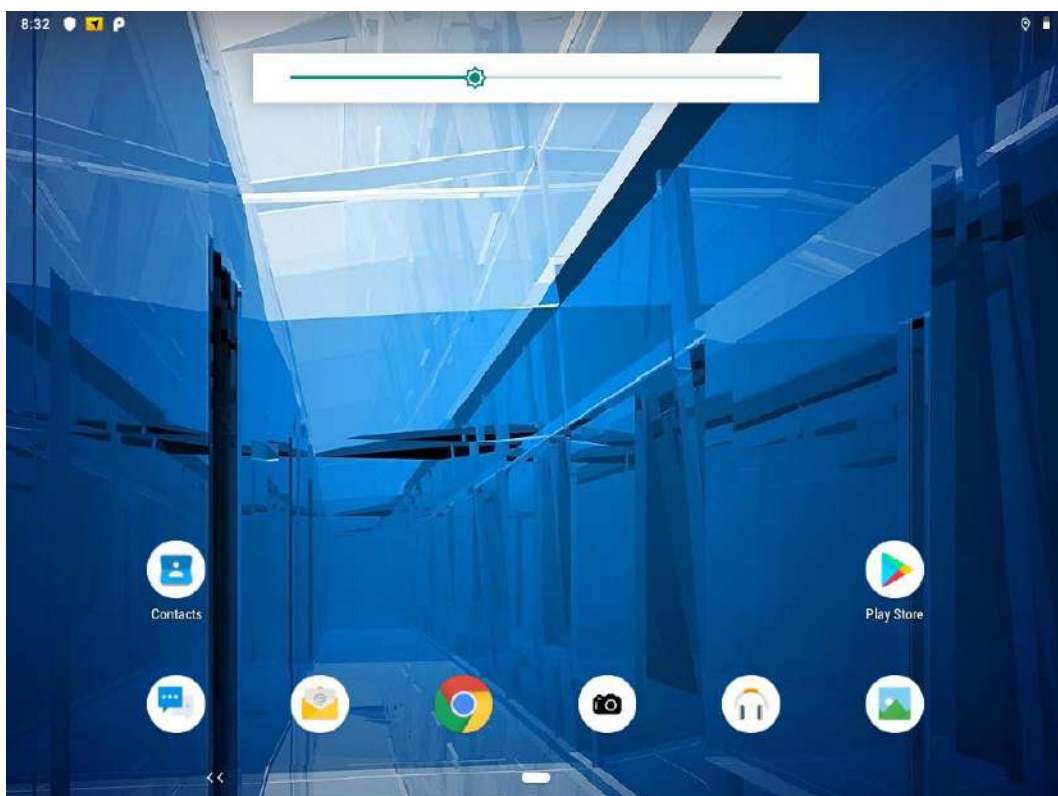

Press **F4 and F5** simultaneously to perform brightness adjustment. The adjustment slide bar will appear on the right side of the screen. Slide to the right side to increase the volume and slide to the left side to decrease the brightness.



## 3.5 Ethernet

Vehicle computer supports Ethernet LAN. To use the Ethernet LAN feature to connect to the network, perform the following procedure:

**Step 1** Connect Ethernet Cable to the FM10Q device.

**Step 2** Touch **All APPS**  icon, and the open **Ethernet**  application.

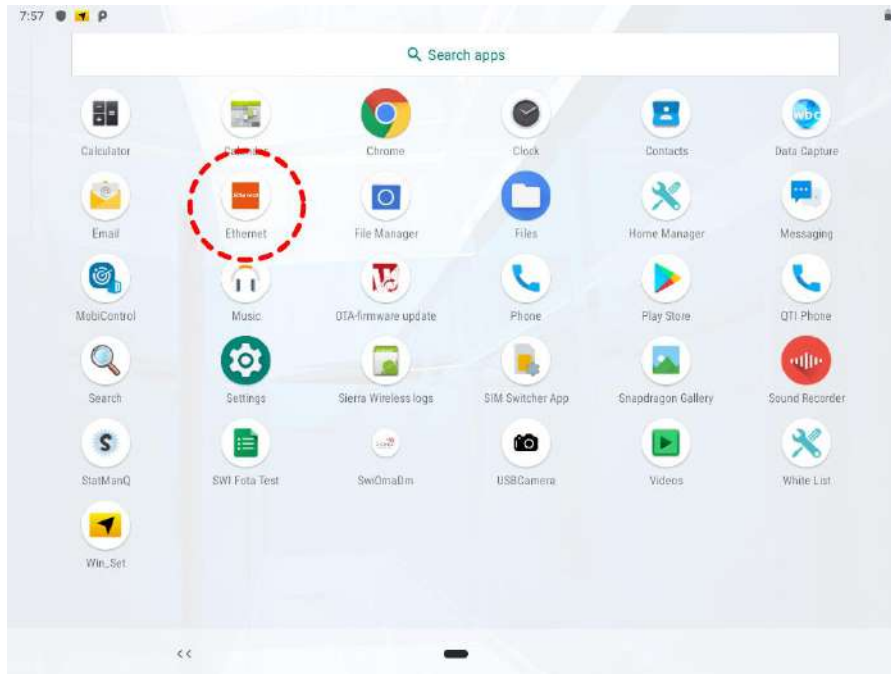

**Step 3** Ethernet APP main menu appears

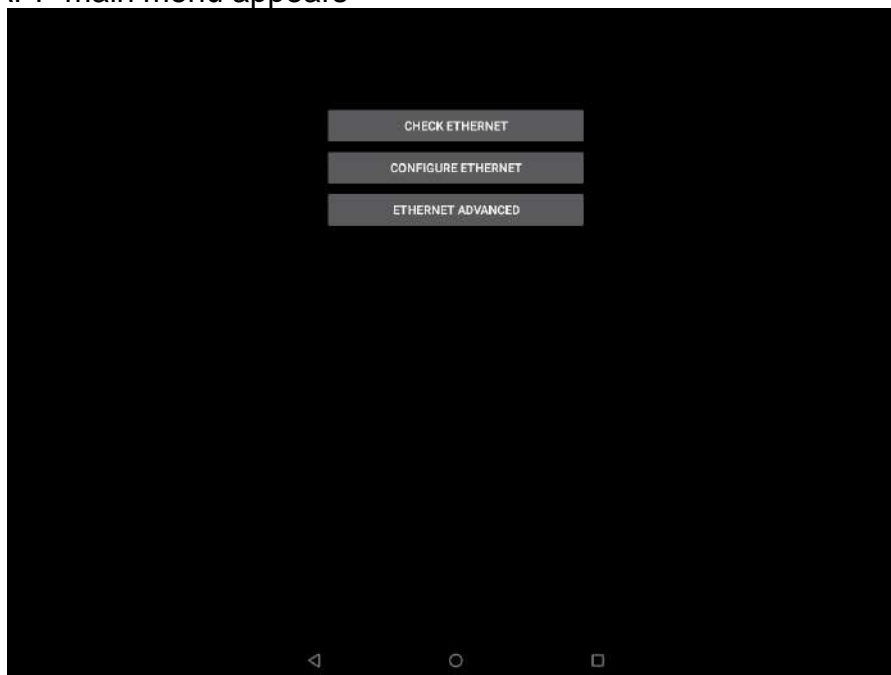

Setting	Description
Check Ethernet	Check Ethernet connection parameters: IP mode, IP address, DNS address and others
Configure Ethernet	Enable Ethernet connection and configure its such as connection type
Advanced Settings	Configure advanced parameters of the Ethernet

### 3.5.1 Configuring Ethernet Settings

Go to All Apps  > Ethernet  > Configure Ethernet

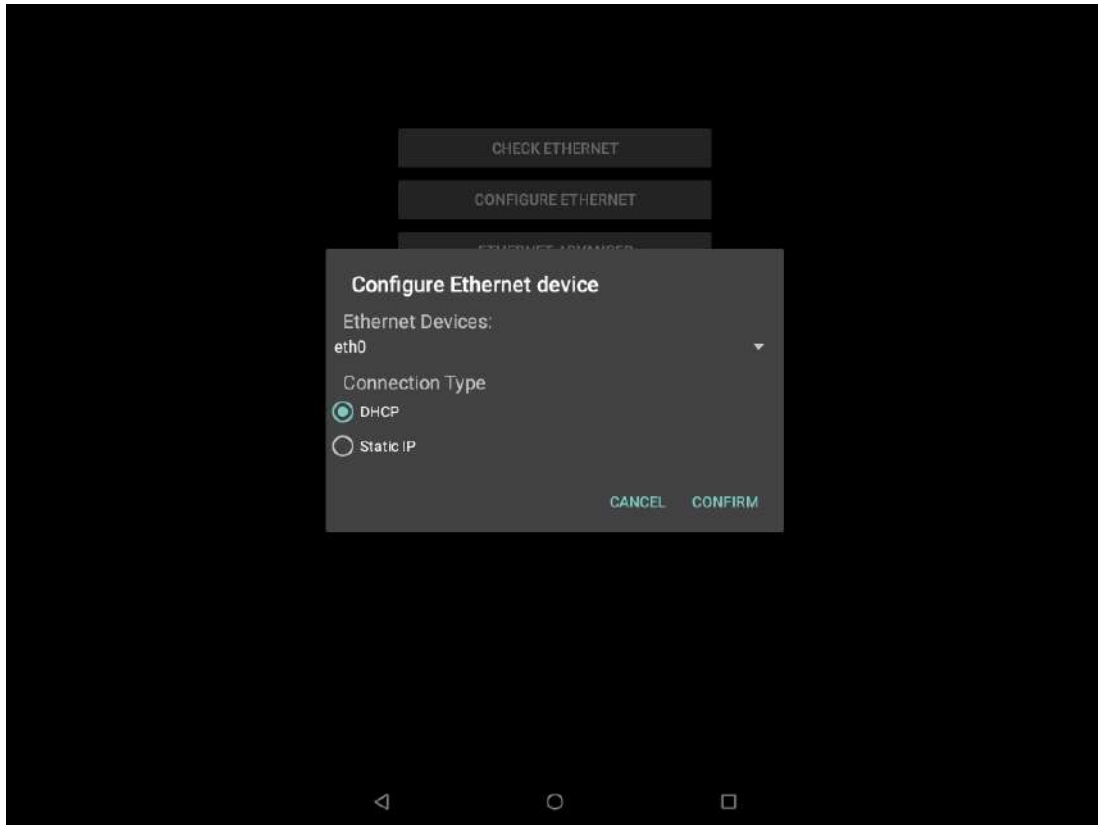

#### Connection Type

Setting	Description
DHCP (default)	The device automatically capture IP-address from the router
Static IP	Allows to manually set up IP-address, DNS, Network and Gateway



## 3.5.2 Checking the Ethernet Settings

To check Ethernet settings:

Go to All Apps  > Ethernet  > Check Ethernet

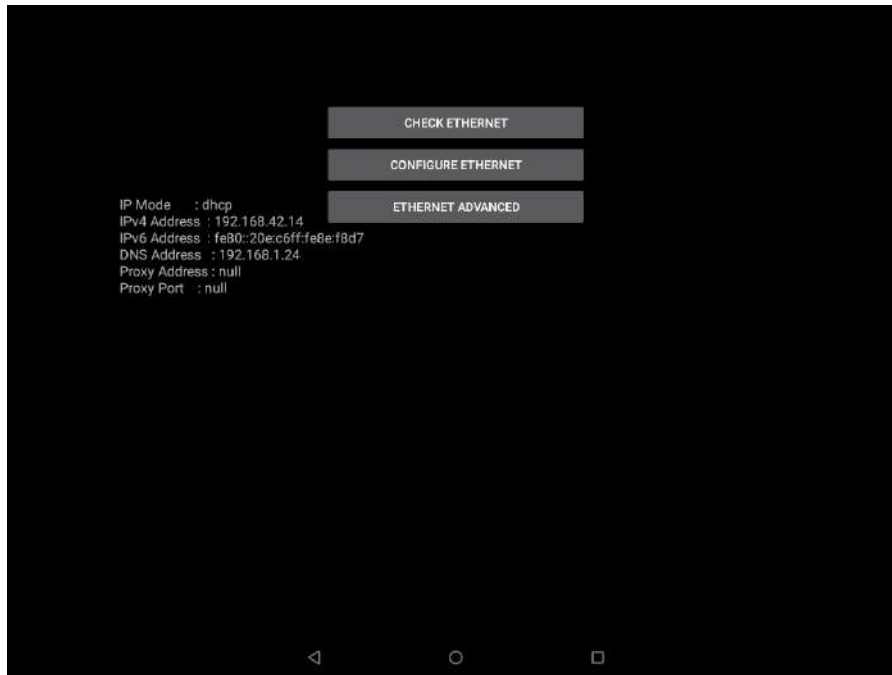

Ethernet settings menu appears on the top right side of the desktop.

## 3.6 Winset

### 3.6.1 Winset Application

Open Winset application .

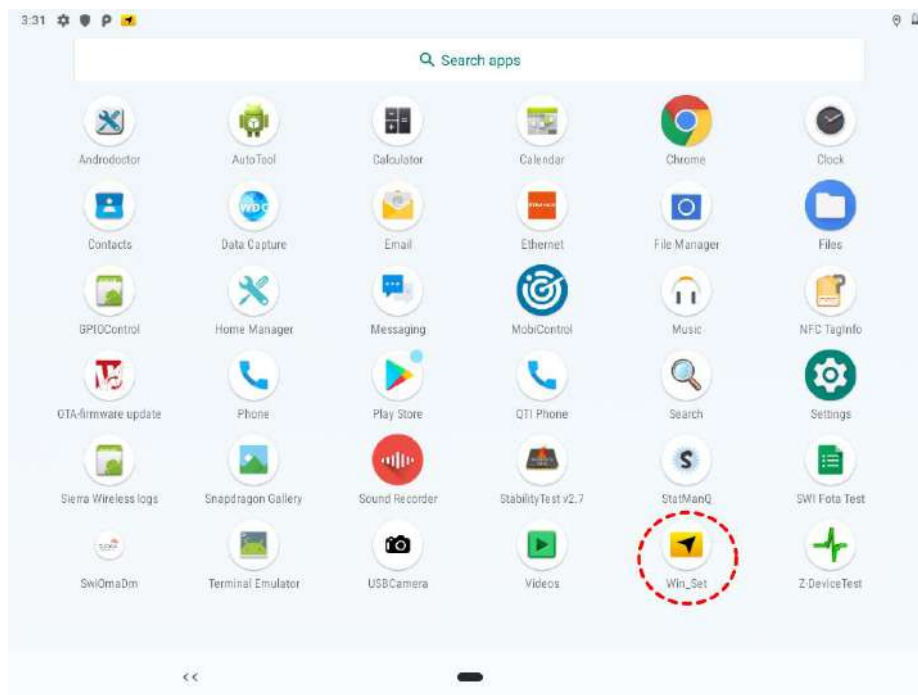

### 3.6.2 Ignition Control

Winmate provides Ignition Control feature in Winset  application to control the timing of delay. You can select 1 to 120 seconds for each period of timing delay.

Go to **APPS > Winset**  **> Ignition Control**

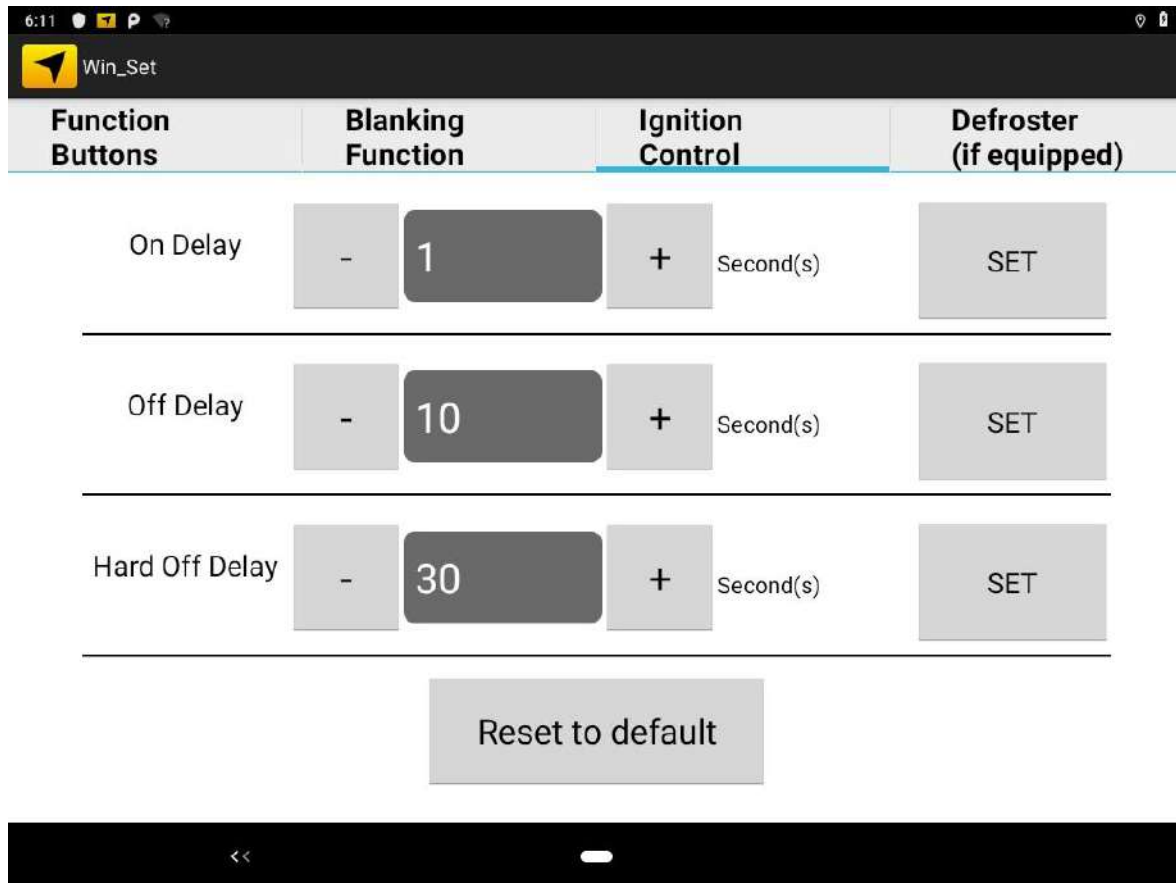

Setting	Default Setting	Description
<b>On Delay</b>	1 second	When the system is powered on via ignition key, the system will delay 1 second to power on.
<b>Off Delay</b>	10 seconds	When the system is powered off via ignition key, the system will delay 10 seconds to shut down.
<b>Hard Off Delay</b>	30 seconds	When the system is powered off via ignition key, the device will cut off power after 30 seconds.
<b>Reset to default</b>	-	Resets the ignition settings back to the default.



**Note:** If you don't plan to use the ignition feature connect the green wire to the vehicle's positive power source.

### 3.6.3 Screen Blanking

Winmate® FM10Q has screen blanking function. Once activated, it will lock the screen display to prevent or restrict the use of the in-vehicle computer. This application allows setting the threshold to perform preset actions while device is moving. When enabled Blanking function reduces visual, cognitive, and physical distractions by limiting device functionality while the vehicle is in motion.

To set up threshold actions

Go to **APPS > Winset**  **> Blanking Function**

**Step 1** Choose both of these conditions or either one to set up the threshold.

**Step 2** Select what action you want to perform while the threshold had been triggered.

**Step 3** Press **Set**.

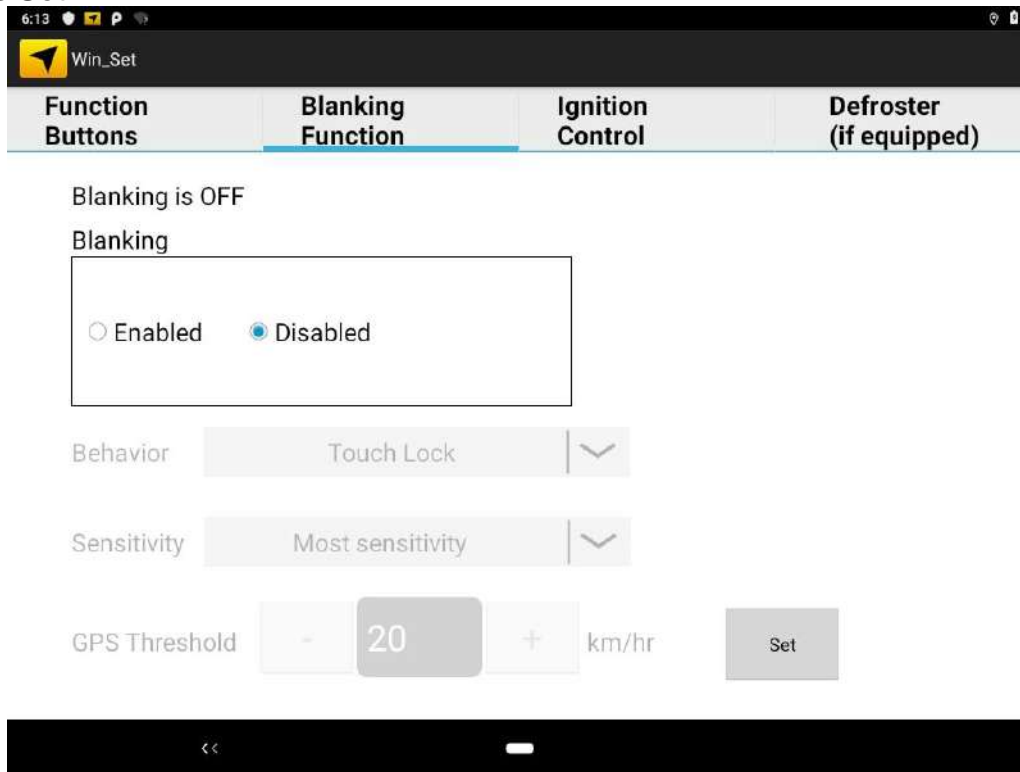

Setting	Setting Options	Description
<b>Blanking ON/ OFF</b>	-	Enable or disable screen blanking function.
<b>Behavior</b>	Touch Lock	Locks touch function.
	Blank Screen	Screen is going blank.
	Lock and Blank Screen	Locks touch function and screen is going blank.
	Show Dialog	Warning “Moving too fast” appears on the screen each time G-Sensor Threshold Level / GPS Threshold level exceeds preset parameters.
<b>Sensitivity</b>	Mode 1	Most sensitivity
	Mode 2	High sensitivity
	Mode 3	Medium sensitivity
	Mode 4	Low sensitivity
<b>GPS Threshold</b>	0 km/ hr ~ 20 km/ hr	When the speed reaches GPS threshold settings, screen blanking function will be activated in 2 seconds

### 3.6.4 Function Buttons

Winmate® FM10Q Vehicle Mounted Computer comes with preinstalled APP called Winmate® Key Mapping (WKM) which let users to assign functions of function keys F1 ~ F10.

To set function keys open **Winset** ,

You can set the application which the favorite you want as a shortcut in corresponding key.

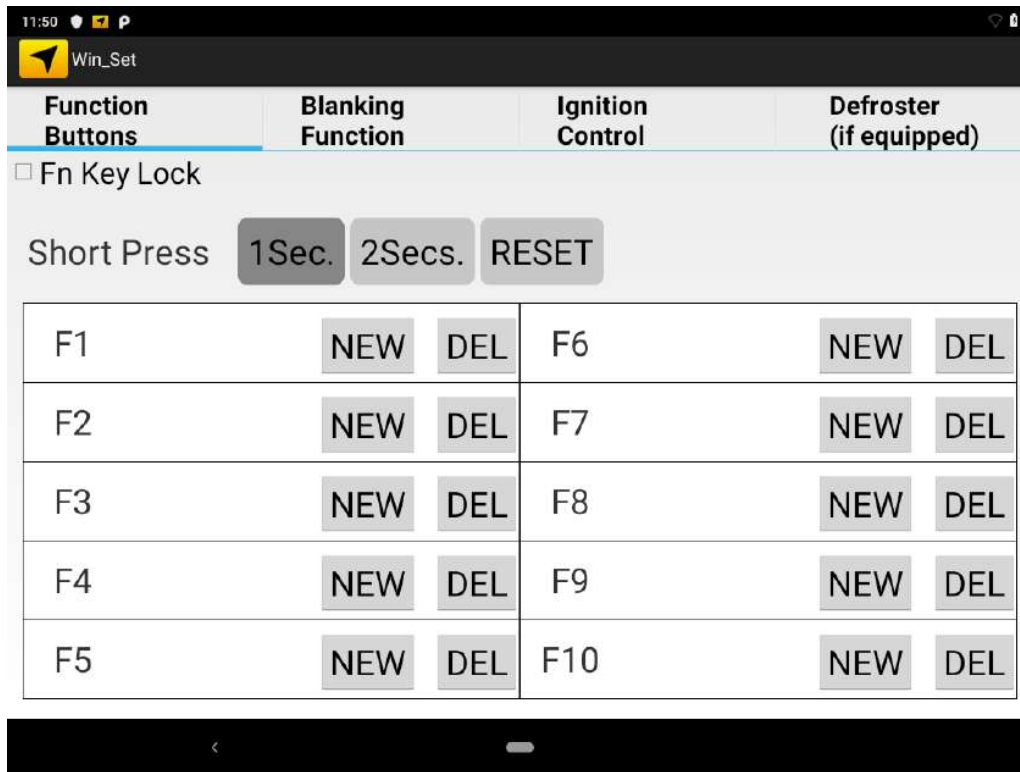

Default Settings:

Function Key	Description
F1 + F2	Touch Keypad Lock/ Unlock
F2 + F3	Lamp On/Off
F3 + F4	Volume adjustment
F4 + F5	Brightness adjustment
F5	Camera

In **Function Buttons** window of the **F1** click **NEW** to open the drop-down menu of function keys. In this example, we have selected to set up functions for **F1** function key.

Choose the function key and then select a **Default application** that will be opened by pressing on the function key you've selected. Press **DEL** to reset the function key to previous settings.

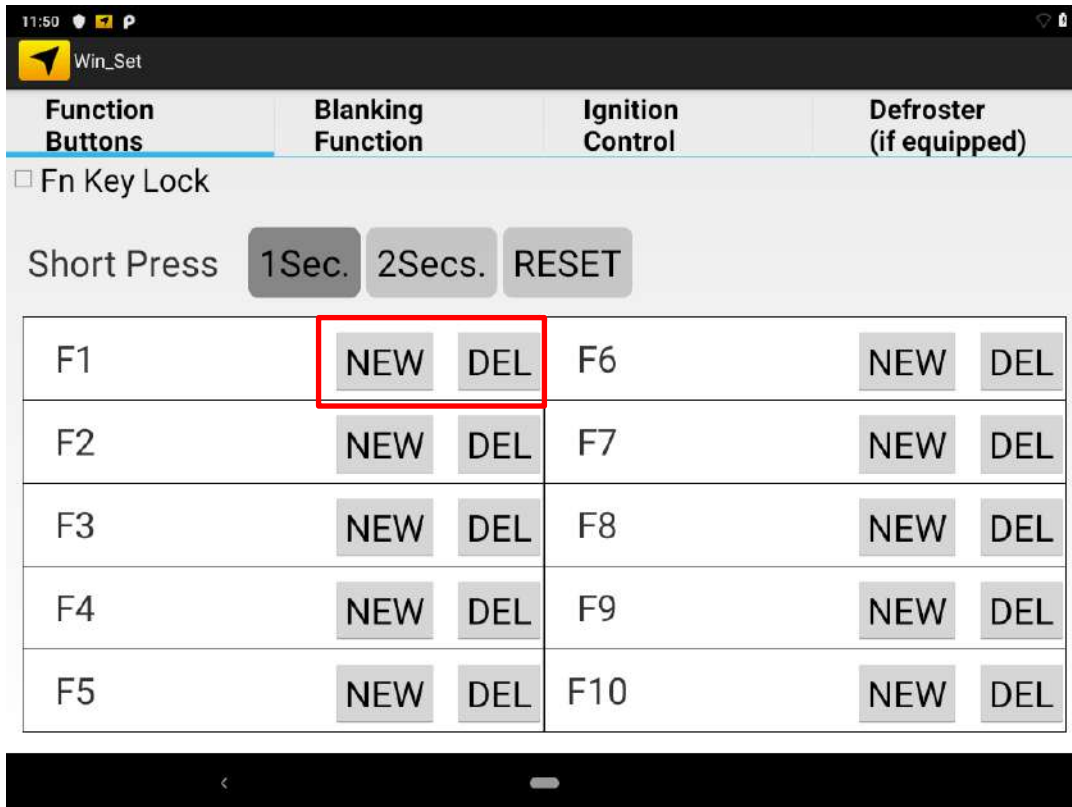

Tick the **Fn Key Lock** option to disable the function key.

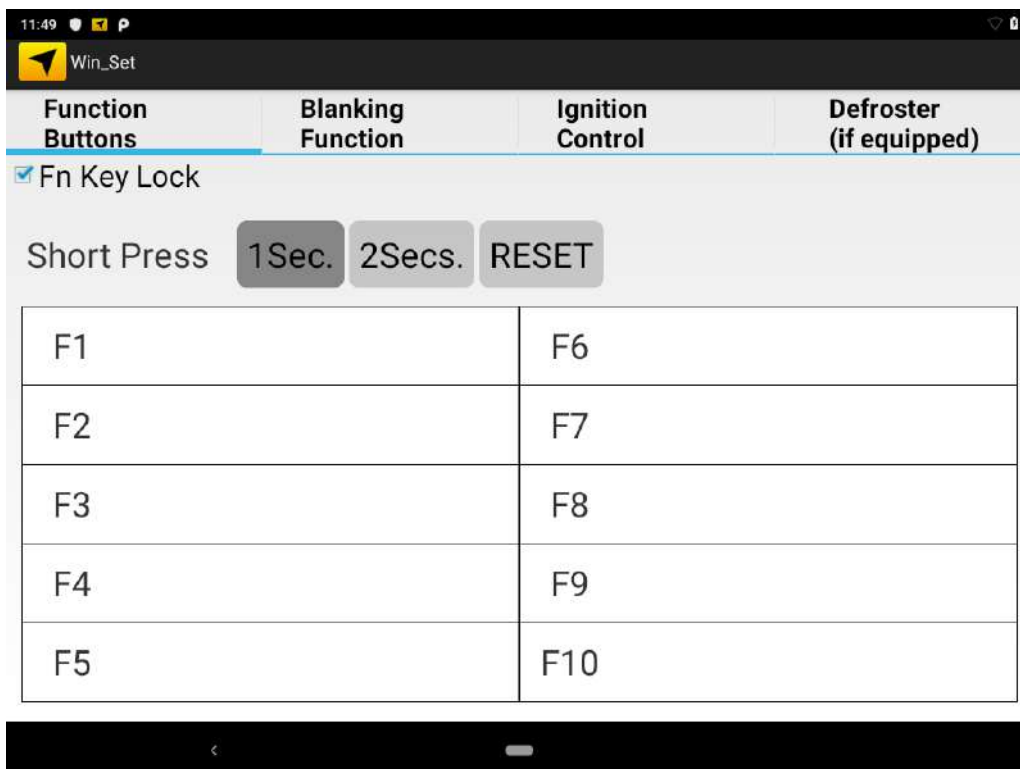

### 3.6.5 Defroster (If Equipped)

Notice that defroster is an optional feature and may not be presented in your device.



**Warning!** The defroster is always disabled when the device is operating from UPS battery power.

**Avertissement!** Le dégivreur est toujours désactivé lorsque l'appareil fonctionne à partir d'une alimentation par batterie UPS.

To use a defroster, please connect a device to power supply.

1. To show the defroster open **Winset** , and this screen below shows the information about the defroster.

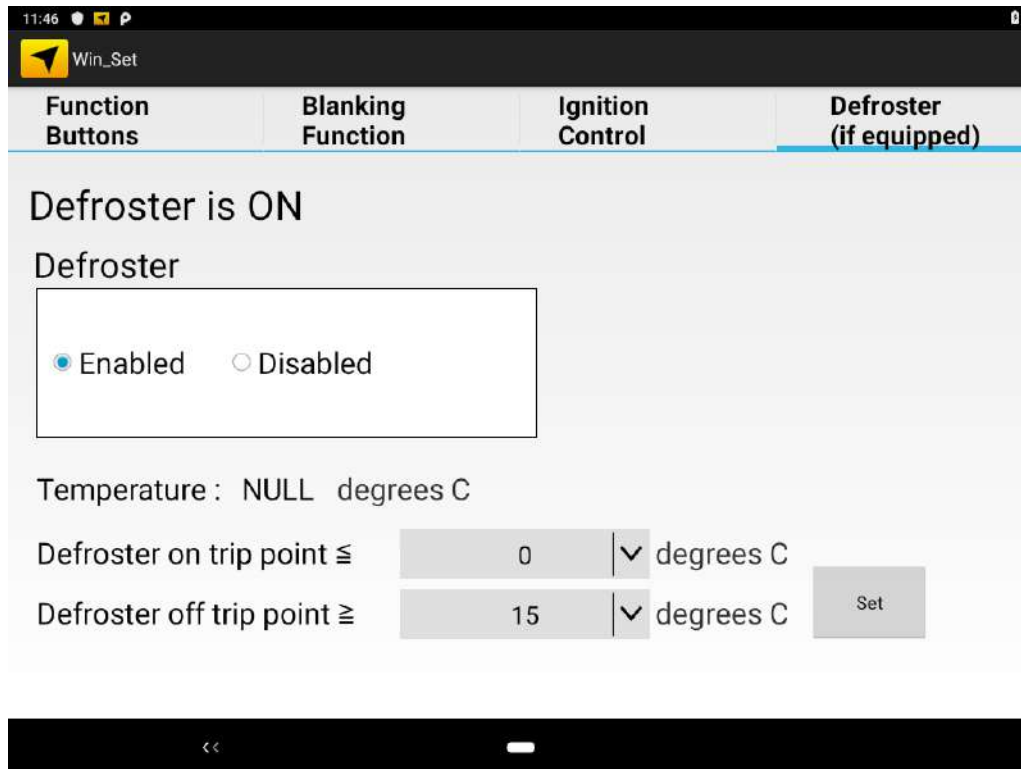

#### Default Settings:

Function Key	Description
On trip point	0°C
Off trip point	15°C

**Note:** To complete setting press the Set button every time you change the setting.

2. Depending on the defroster trip point, to trigger the Defroster ON, the defroster on trip point needs to be lower than 0°C. The defroster on trip point is configurable as follow:

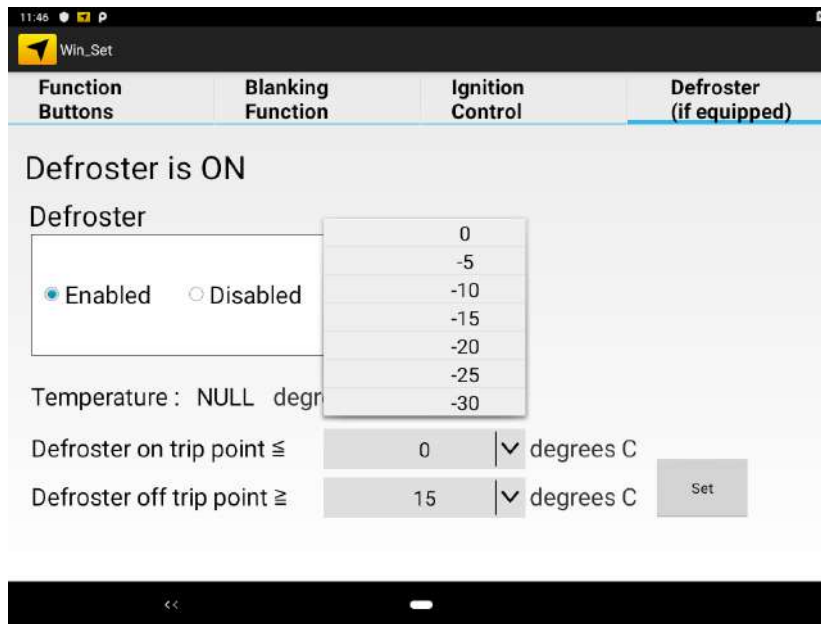

When the Defroster is ON, a defroster indicator in the lower right corner of the device will show Red Color.



**Example:** In this example “0° C” is selected as Defroster trip on point meaning that the Defroster will be activated when the temperature drops down to 0°C.

3. To trigger the Defroster OFF, the Defroster off trip point needs to be set higher than the set temperature. The defroster off trip point is configurable as follow:

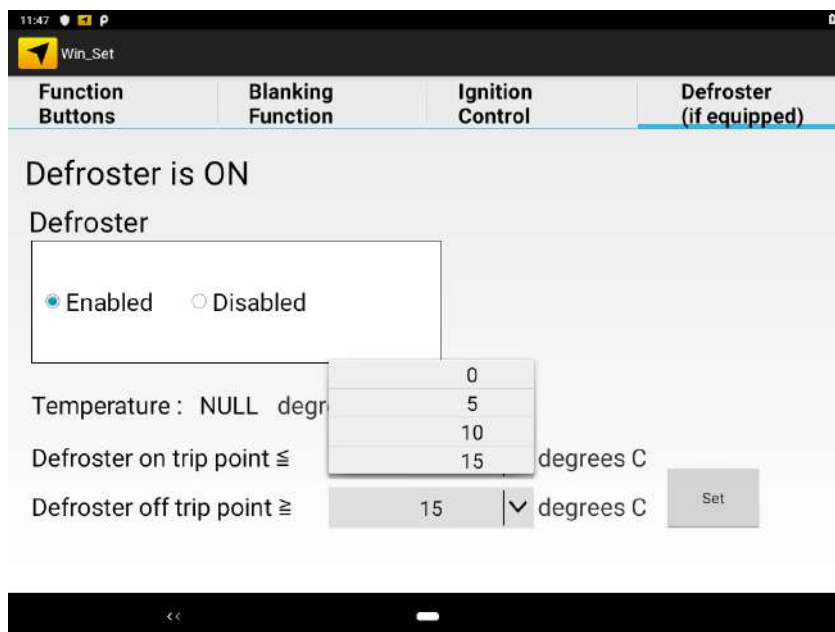

When the Defroster is OFF, a defroster indicator in the lower right corner of the device will Turn off



**Example:** In this example “15°C” is selected as Defroster trip off point meaning that the Defroster will be deactivated when the temperature reaches 15° C.

4. To disable or turn off the defroster, tap the disabled button, and then press the set button to complete the setting. This will keep the defroster Off in any condition.

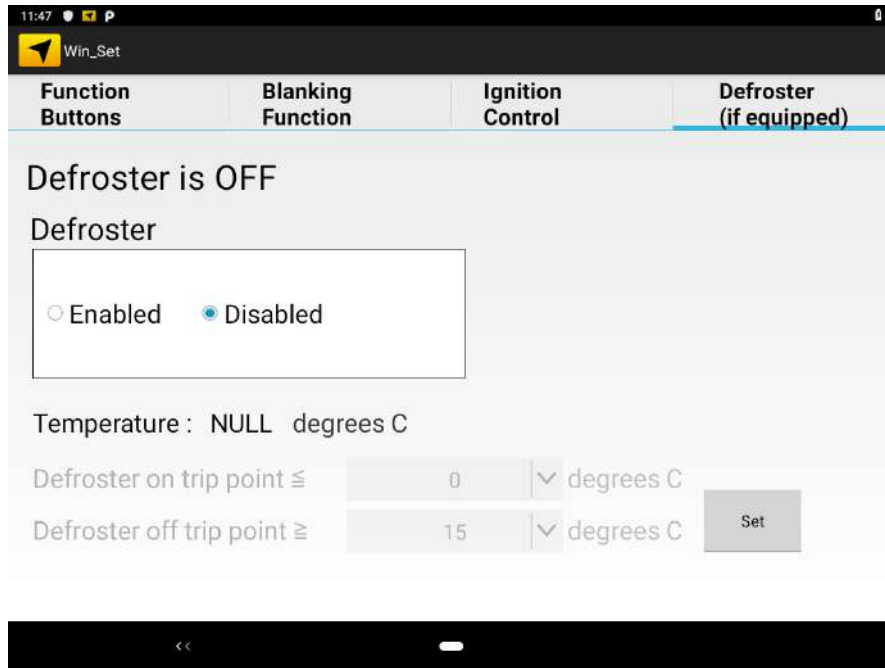

When the Defroster is OFF, a defroster indicator in the lower right corner of the device is Turn off



### 3.7 Winmate® Home Manager (WHM)

Winmate® FM10Q Vehicle Mounted Computer comes with preinstalled APP called Winmate® Home Manager (WHM) which let the device manager to lock the launcher then the user can only use one application assigned by the device manager.

#### 3.7.1 How to Lock Applications

1. In the main APPS window, select the Home Manager  APP and tap it to open.

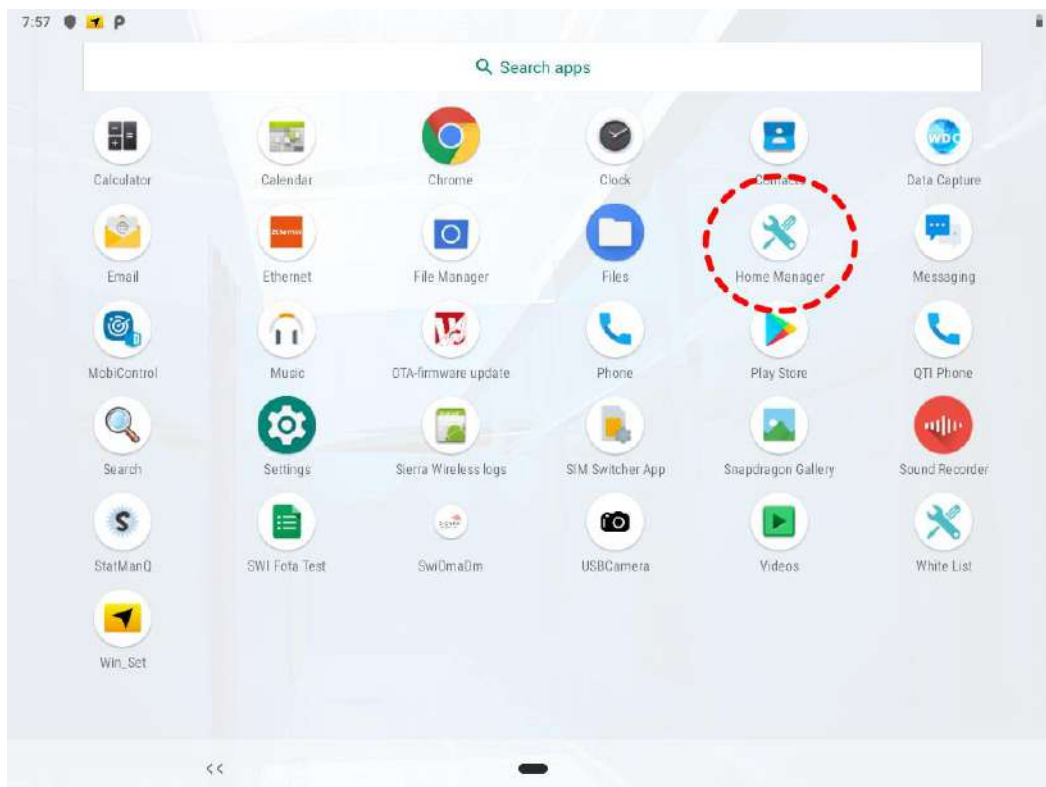



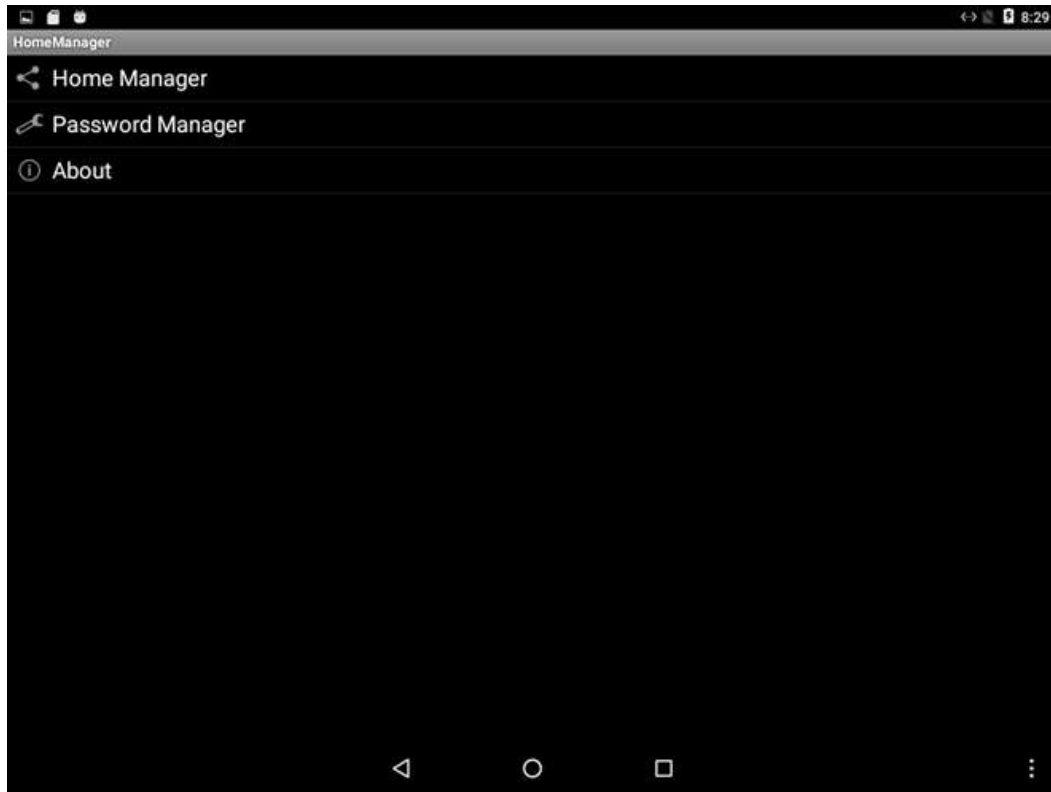

Item	Description
Home Manager	User can set which app to run up automatically after booting.
Password Manager	User can set WHM password. Default password is "0000".
About	In this menu user can check information about WHM

- Go to "**Application Selector**", and chose the app which you want to run up automatically after booting.

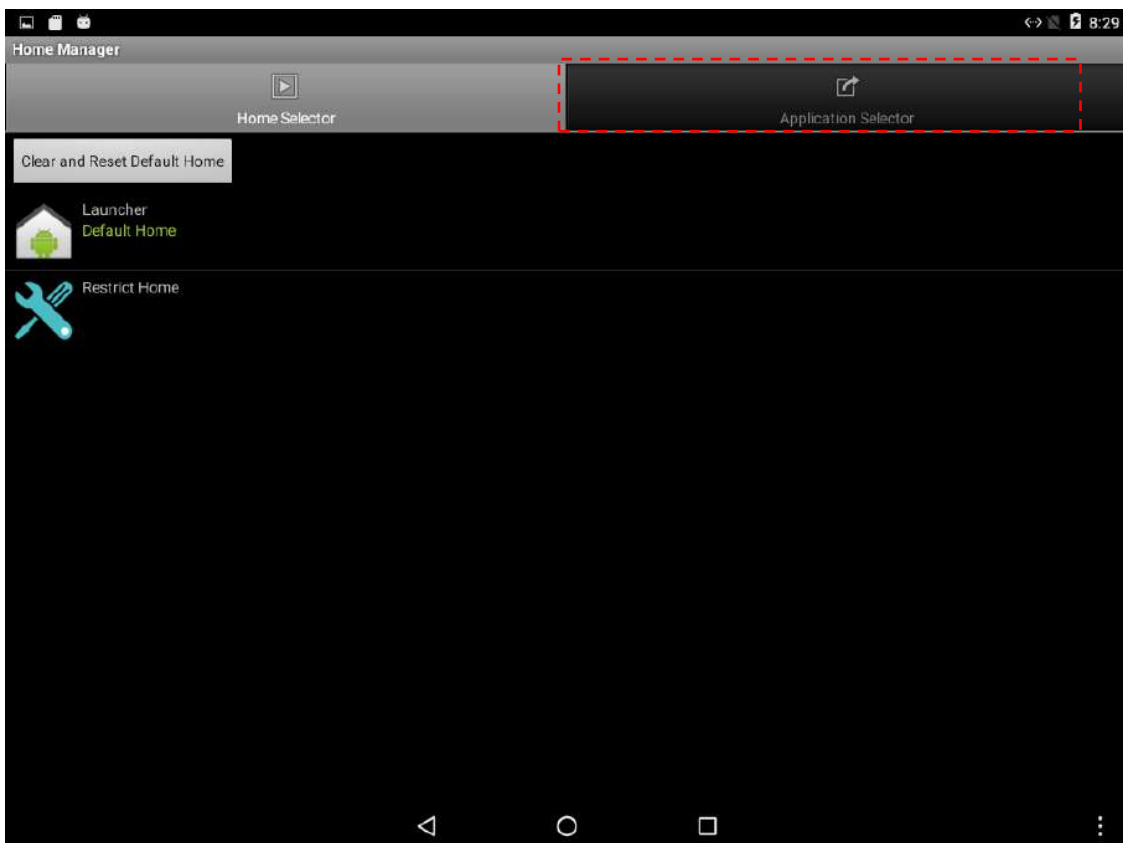

3. Go back to “**Home Selector**” and press “**Clear and Reset Default Home**”.

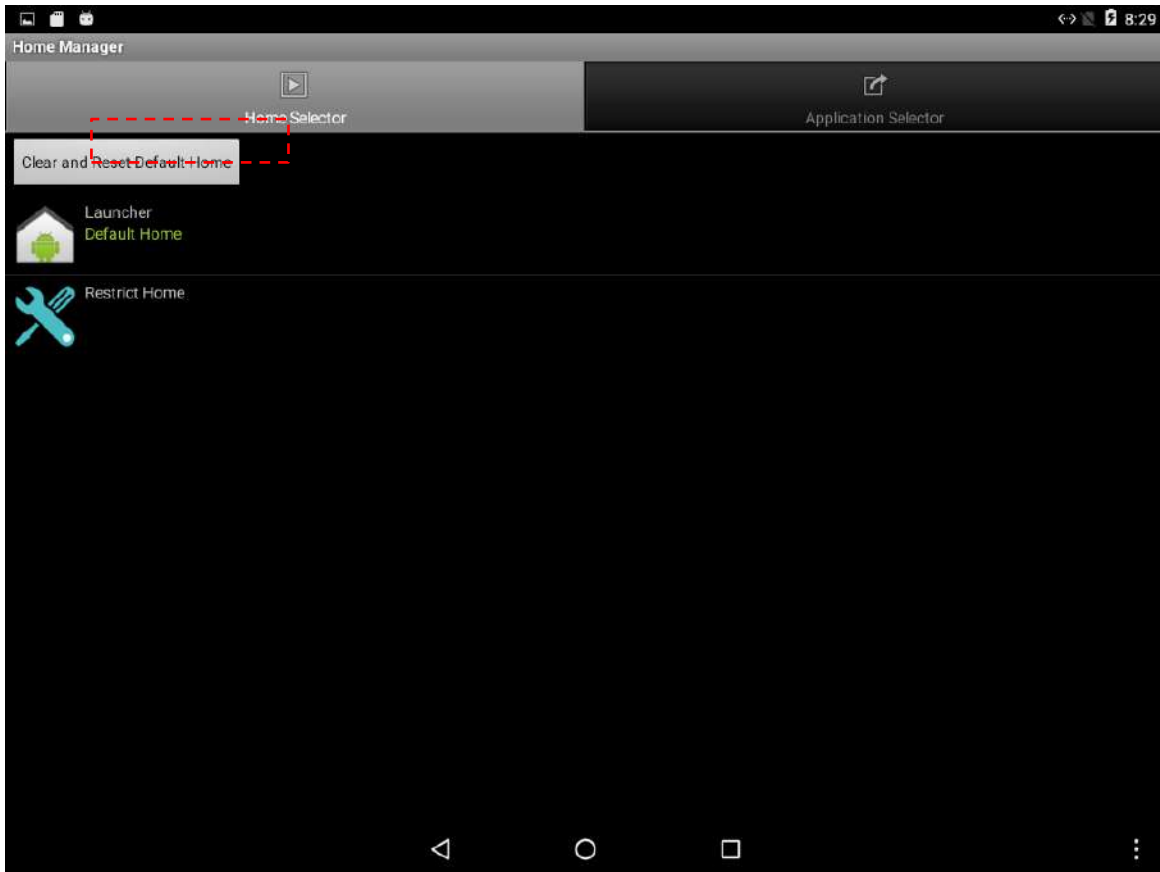

4. Select “**Restrict Home**” and “**Always**”, and then restart the computer to enable these settings.

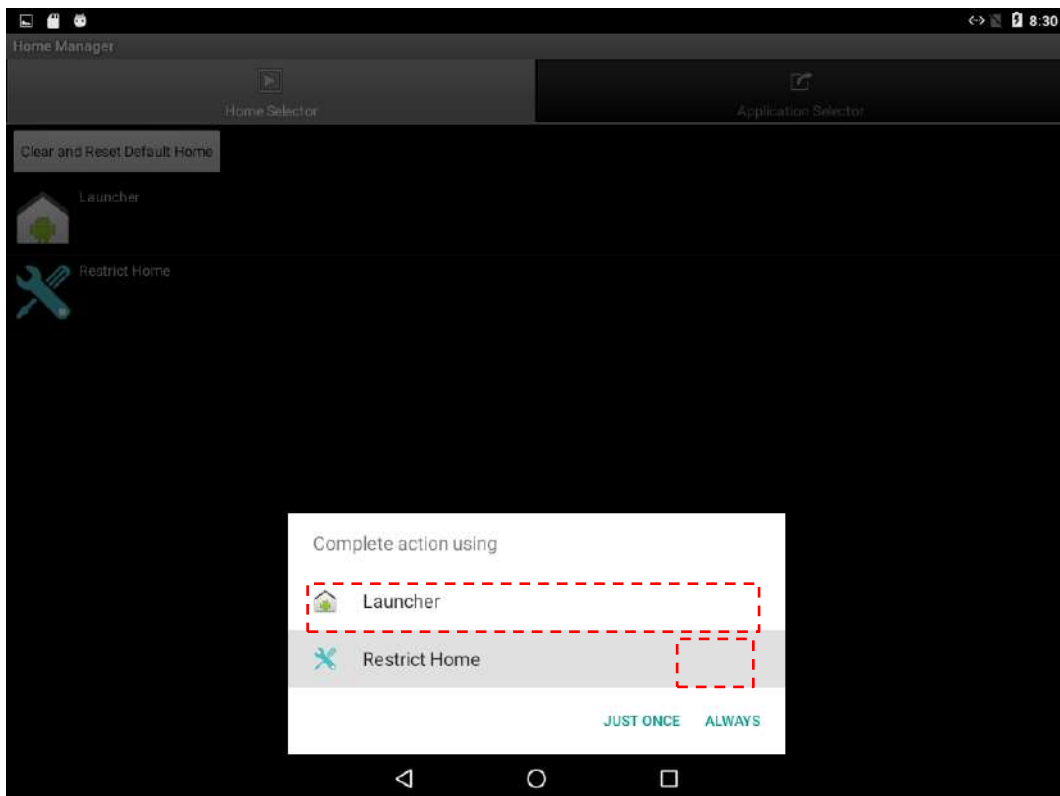

The system will automatically start the application which you selected and lock it. Any time user presses home key or back key, the system will go back to the same application which you have selected.

### 3.7.2 How to Reset WHM Settings

1. If you want to reset the home manager settings, pull down the left side to open the status bar and open **HomeManager** service.

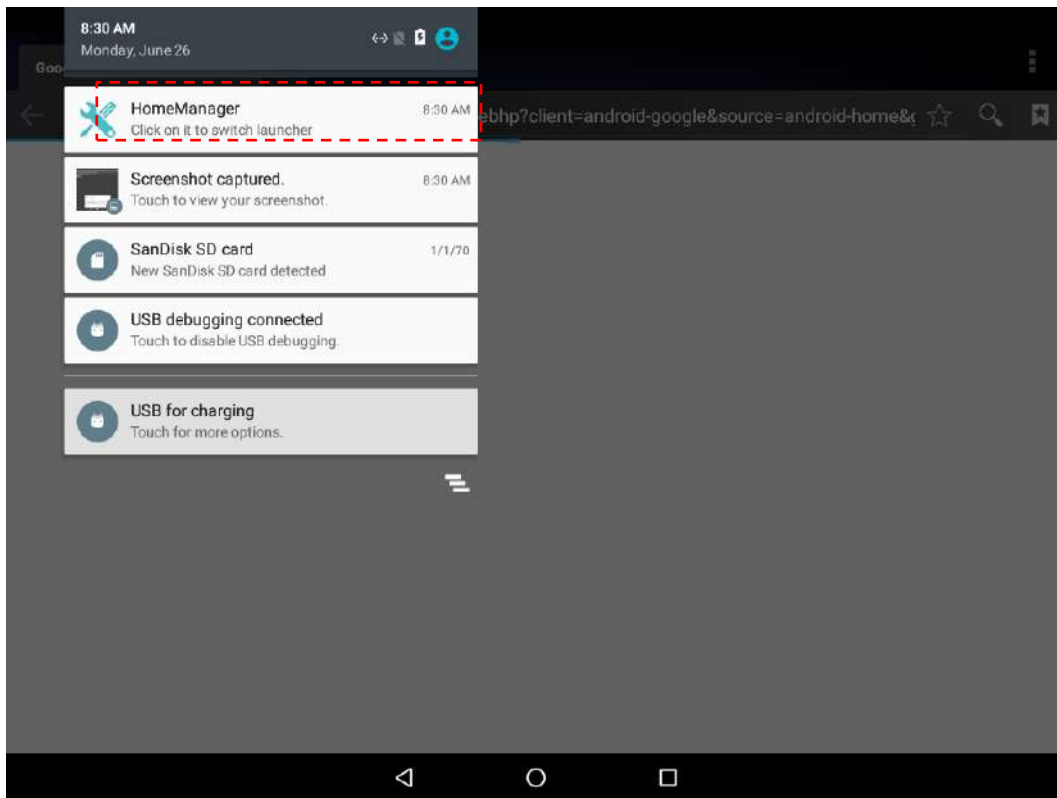

2. System will request the password to login.

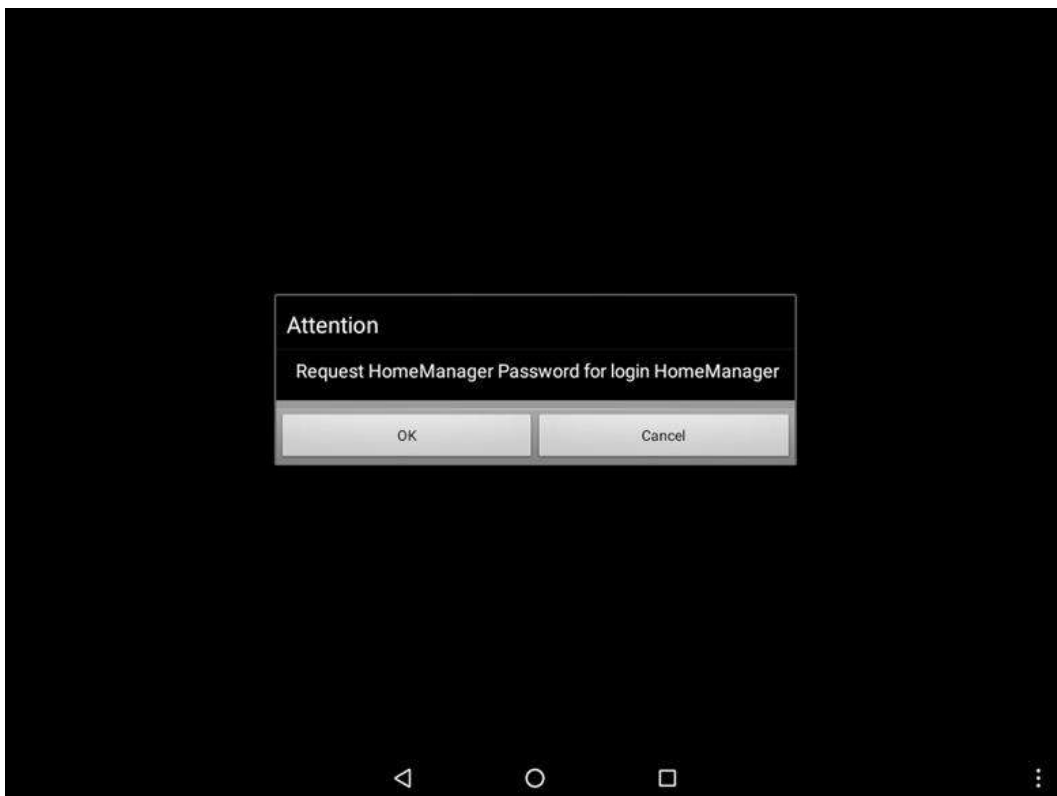

Default password is "0000".

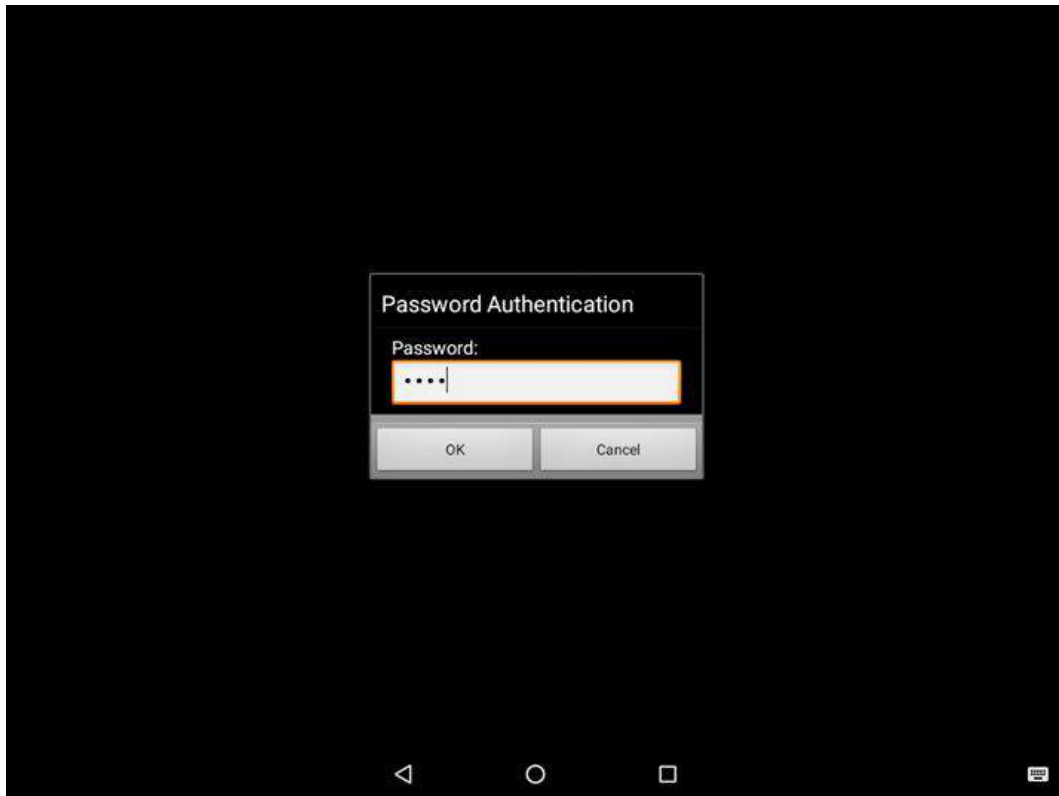

3. Restart the system and you will go back to the normal Launcher.
4. In the **Home manager->Home Selector Tab->** click the **“Clear and Rest Default Home”**. Specify the **“Launcher 3”** and **“Always”**, it would go back to the origin launcher.

### 3.7.3 How to Change WHM Password

1. Go to **Password Manager** and set your own password for this APP.

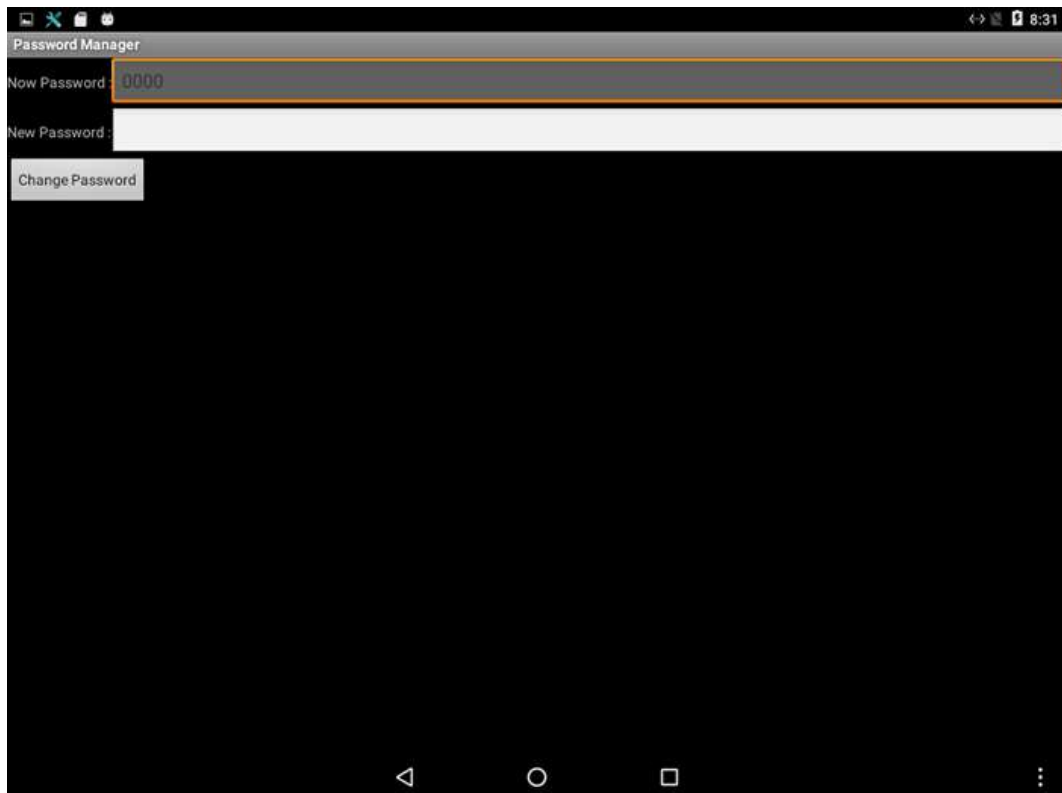

2. The default password is “0000”. Enter a new password in **New Password** field, and then tap **Change Password**.

## 3.8 WDC

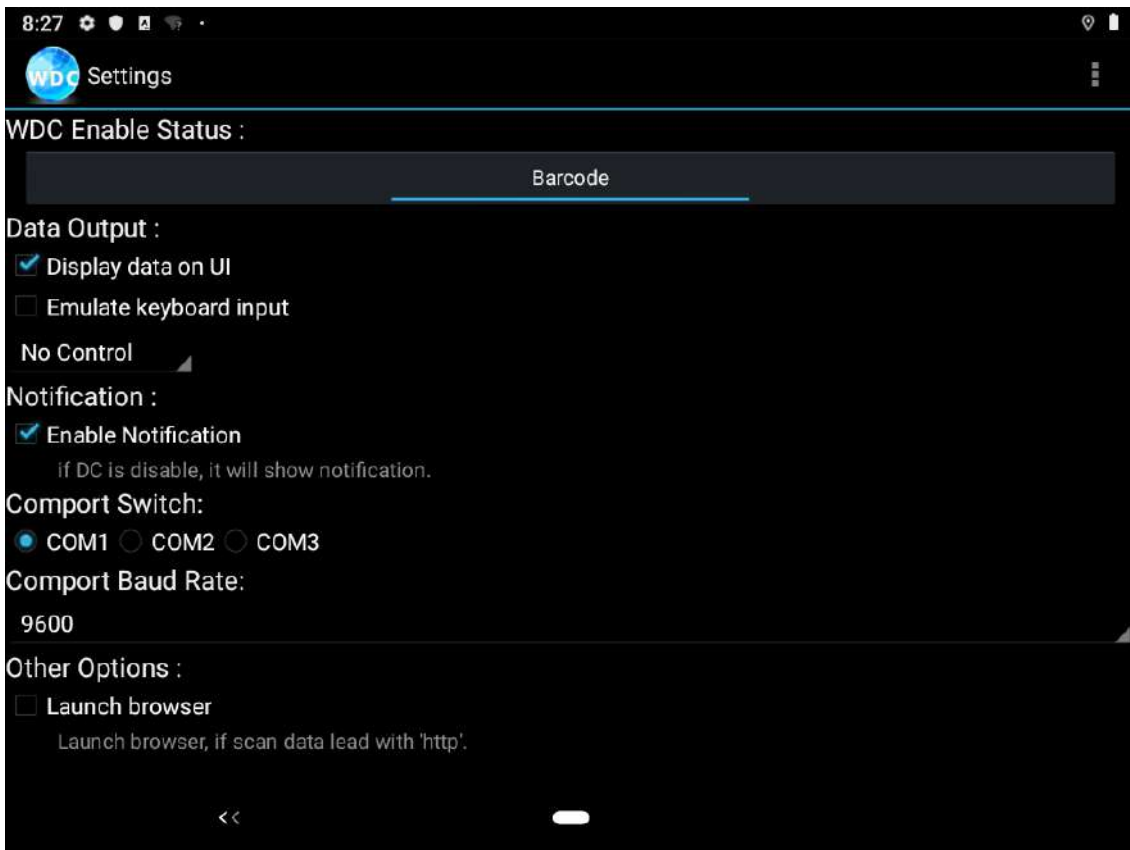

Item	Description
<b>WDC Enable Status</b>	Close the entire WDC, and when you open the APP again, you will be asked if you want to start it.
<b>Data output</b>	1. Paste the scanned barcode to anywhere you can enter text. 2. Enter the barcode by typing, the following options can choose the input speed.
<b>Notification</b>	Notifications will show up after shutting down WDC.
<b>Comport Switch</b>	Select the jack corresponding to the device
<b>Comport Baud Rate</b>	Adjust Baud Rate
<b>Other Options</b>	When scanning to the beginning of the barcode is "http", it will open the browser to enter the webpage.

### 3.9 BT

Your device has integrated BT capabilities for short-range wireless communication between BT-enabled devices. You can transfer files, playback audio, configure virtual serial ports, and share network connection via BT.

By default, the BT feature is enabled as indicated by the BT icon on the taskbar.

#### To Enable the BT:

1. Pull down from the top right of the screen to open the status area.

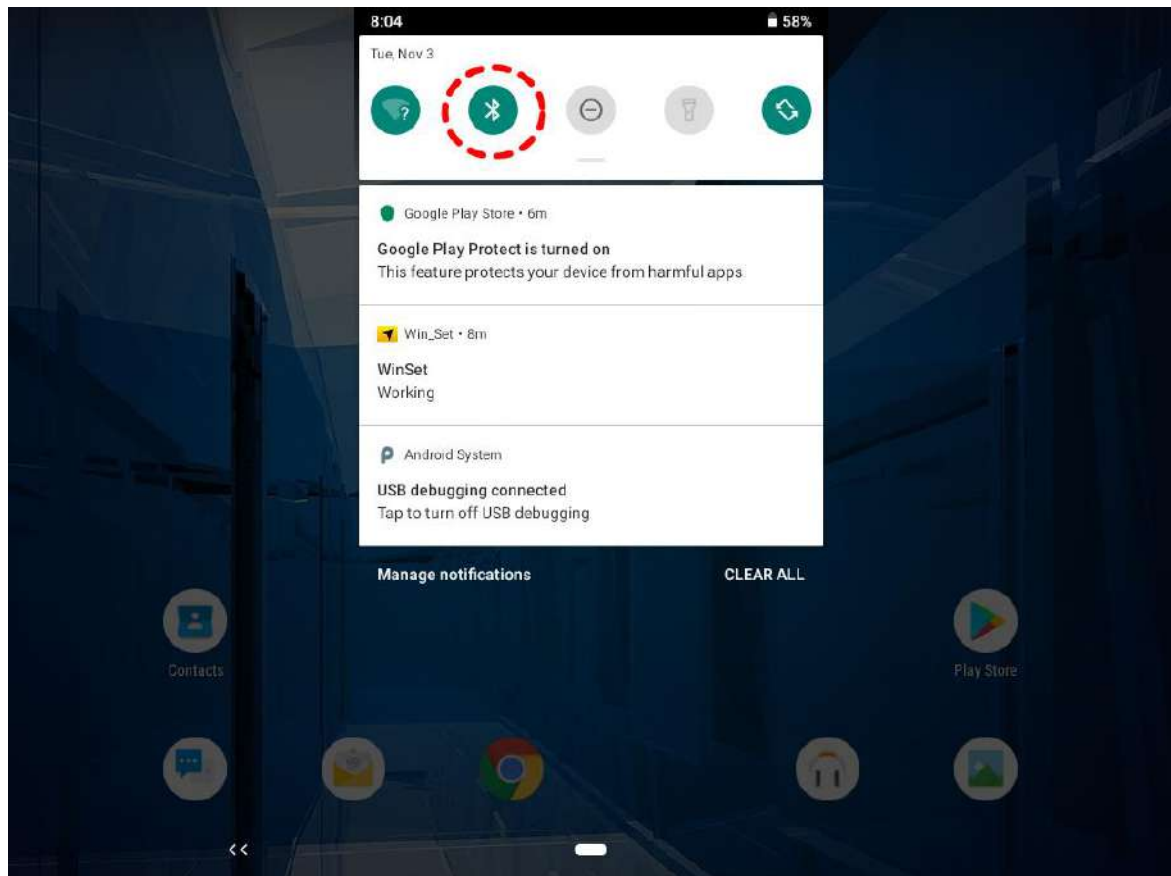

2. Check the status of the BT Icon.
3. To turn the BT on or off, tap Bluetooth. A check mark indicates the BT adapter is turned on.
4. Click the BT icon in the windows notification area, a contextual menu for BT is displayed.



**Note:** When FM10Q is connected to other devices by BT, the flash light will be ON.

**To add a device:**

1. Go to **Settings**  > **Connected Devices**  > **Pair new devices**.

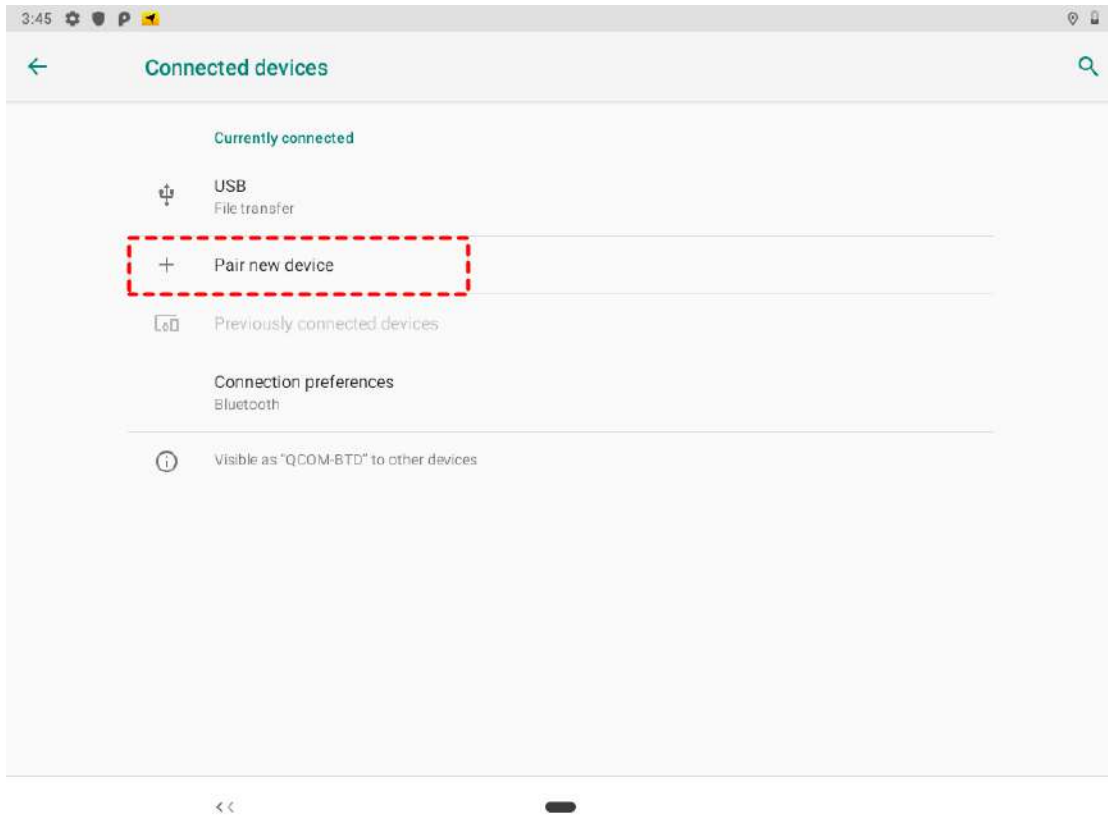

2. Choose the BT device that you want to connect and follow onscreen prompt to continue pairing and using the BT device.

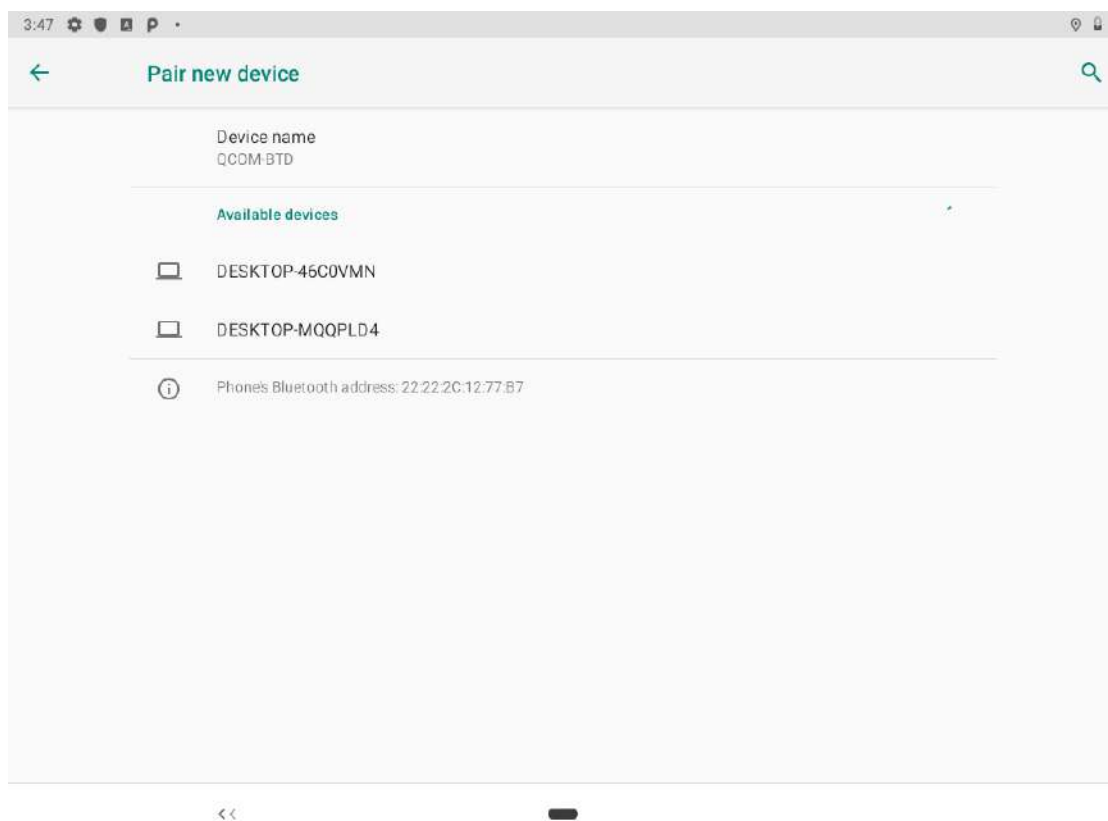

## 3.10 Connecting to WLAN Networks

### Turn On WLAN and Connect to WLAN Network

1. Pull down from the right top of the screen to open the status area.
2. Check the status of **Wi-Fi**.

The device scans for available WLAN networks and displays the list of it. Secured networks are indicated with a lock icon. If the device finds a network that you have connected previously, it connects to it automatically.

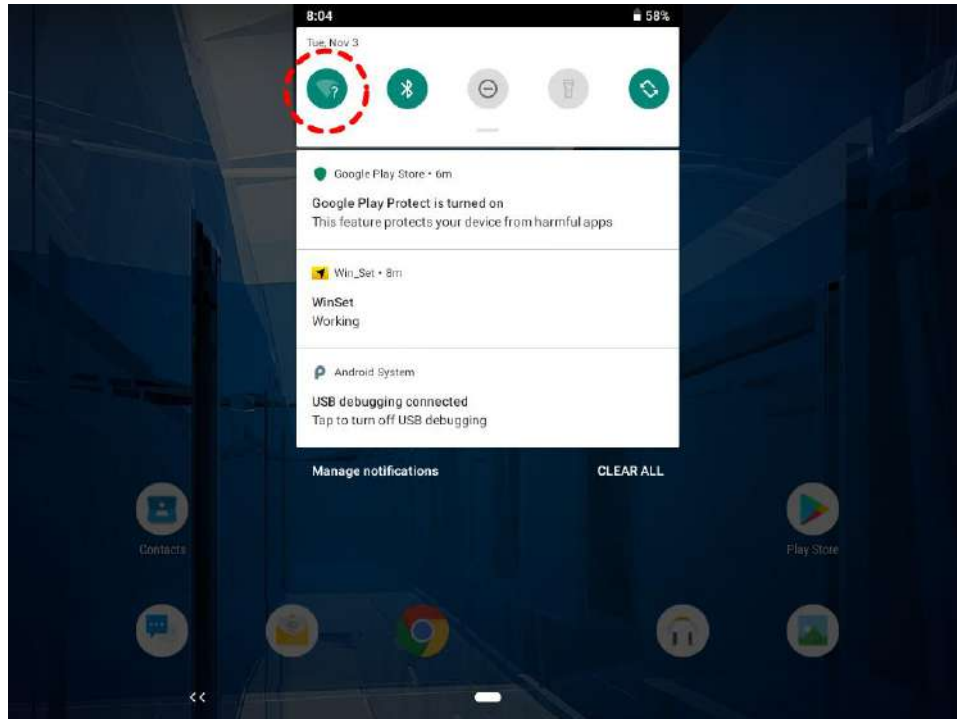

3. Tap a network to connect to it:
  - If the network is open, you are prompted to confirm that you want to connect it by tapping **Connect**
  - If the network is secured, users are prompted to enter a password or other credentials

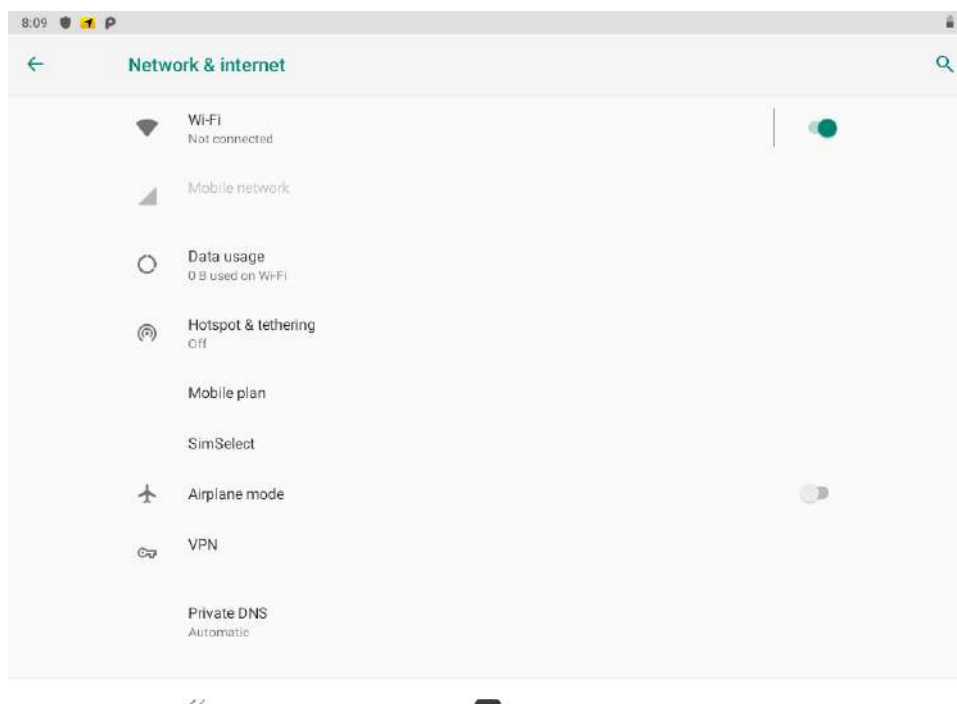



- To check the details about the speed, security, address and related settings, tap its name in the Wi-Fi settings screen.

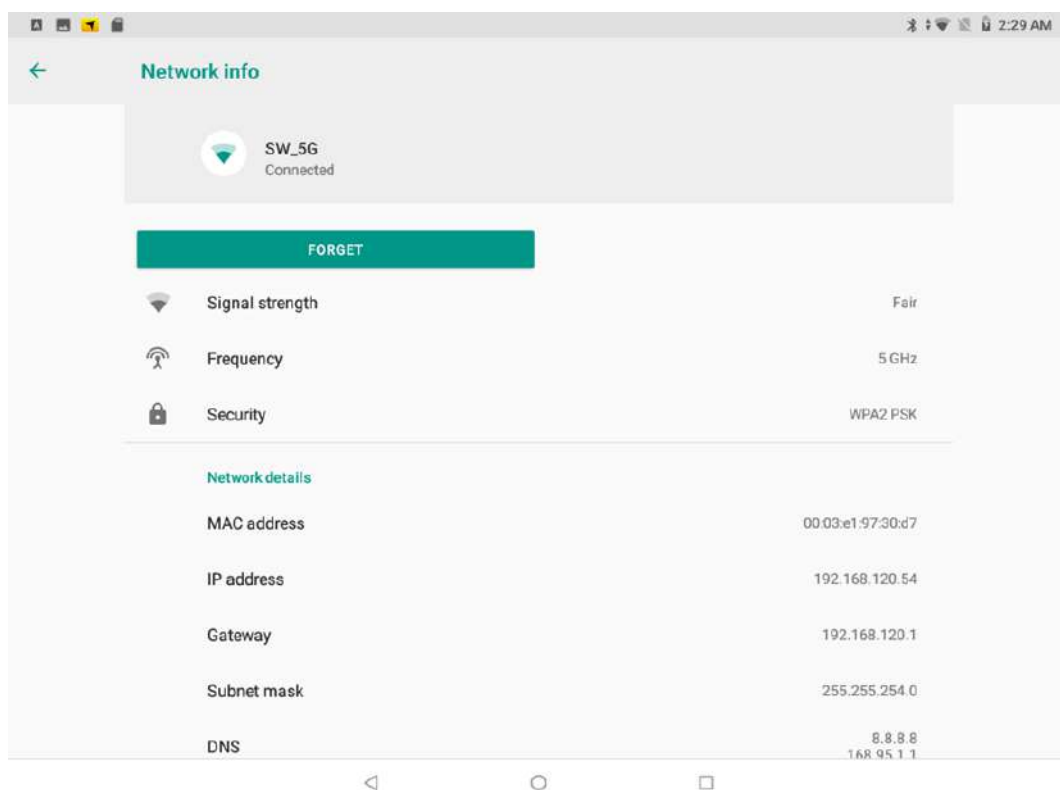
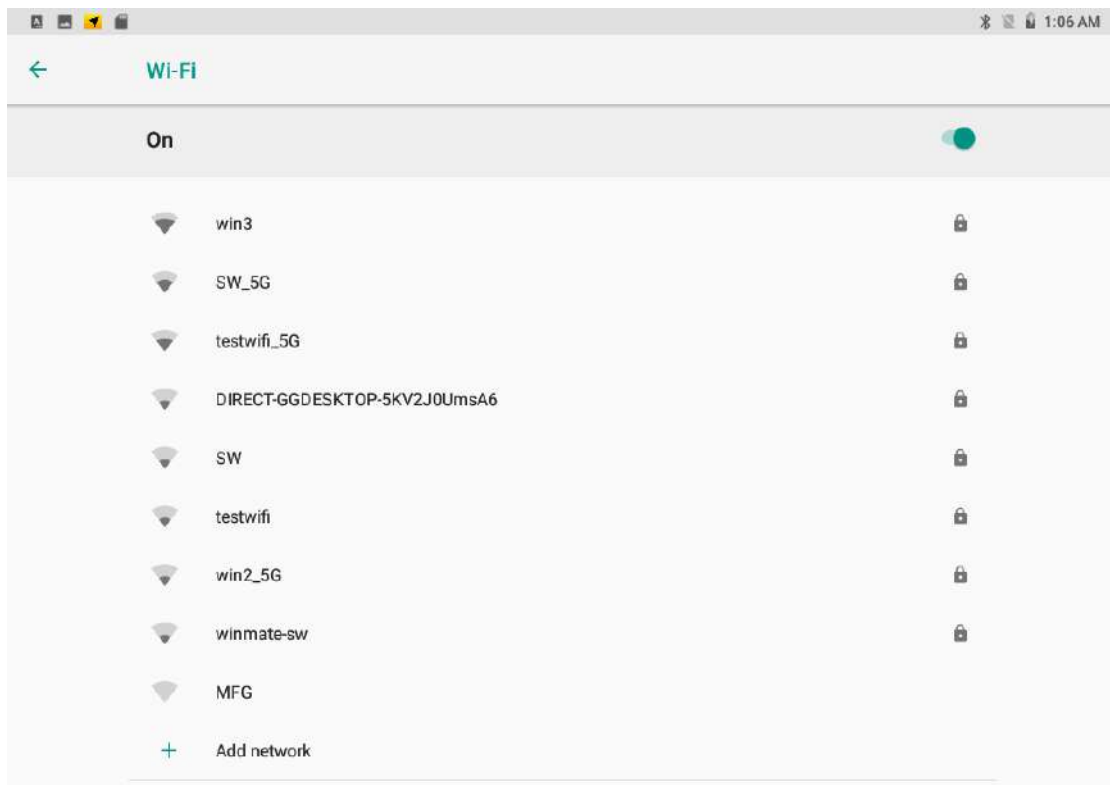

## Adding WLAN Network

1. Turn on Wi-Fi, in the Wi-Fi settings screen, tap + icon (at the bottom right of the list of discovered networks)
2. Input the SSID (name) of the network, if the network is secured, tap the security menu and then tap the type of security deployed on the network.
3. Enter any required security credentials.
4. Tap **Save**.

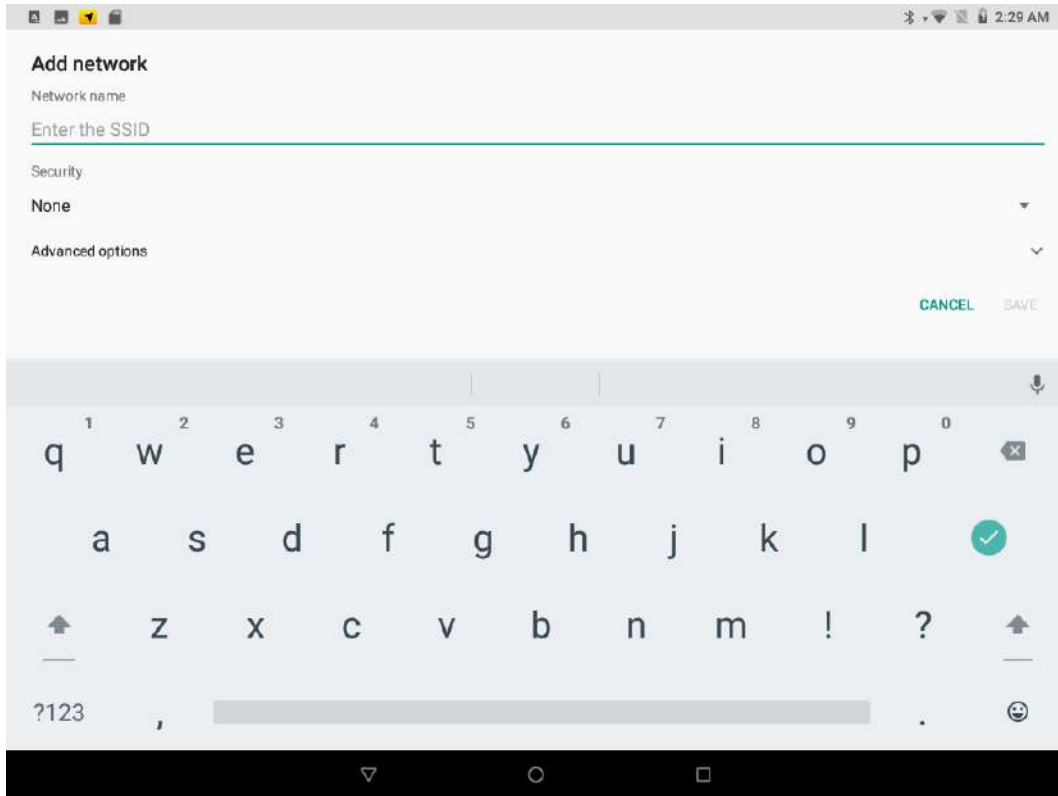

**Note:** When FM10Q is connected to other devices by WLAN, the flash light will be ON.

## 3.11 WWAN

For vehicle computers equipped with wireless WAN (3G or 4G/LTE) card, to use the wireless WAN feature to connect to the network, perform the following procedure:

1. Go to **Settings** > **Networks and Internet** > **Mobile Network**

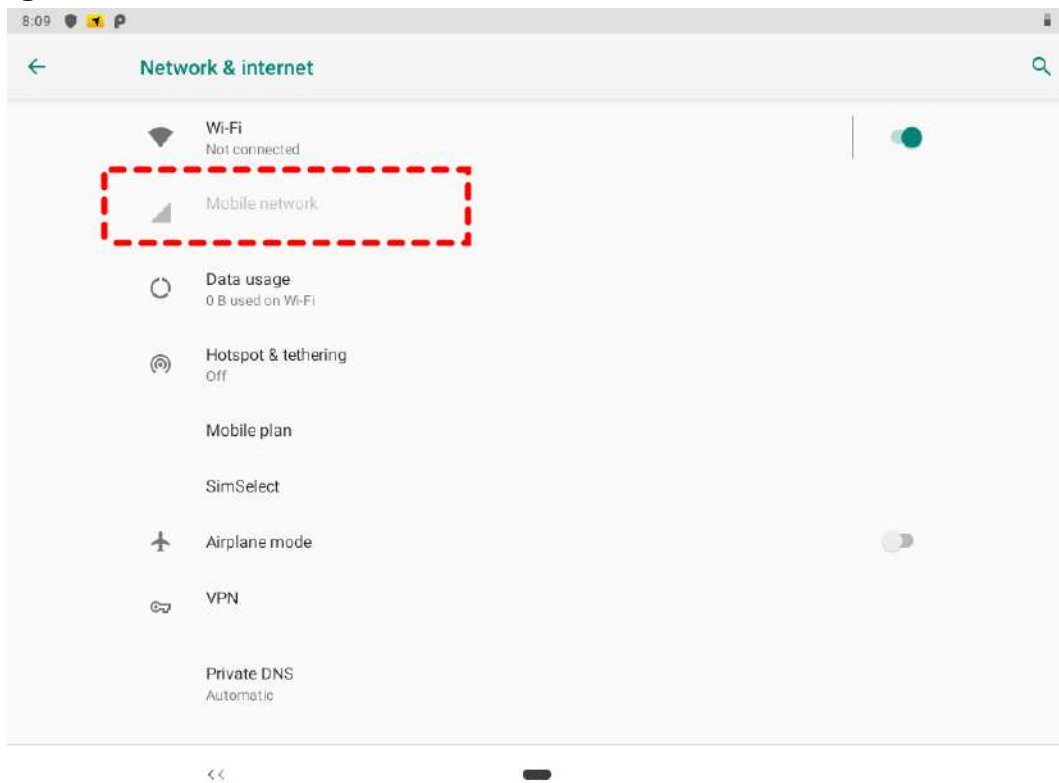

You can check the wireless WWAN connection status through the wireless network connection status icon in the status area. Pull down from the right top of the screen to get the notifications area. The more bars encompassed, the better the signal is.

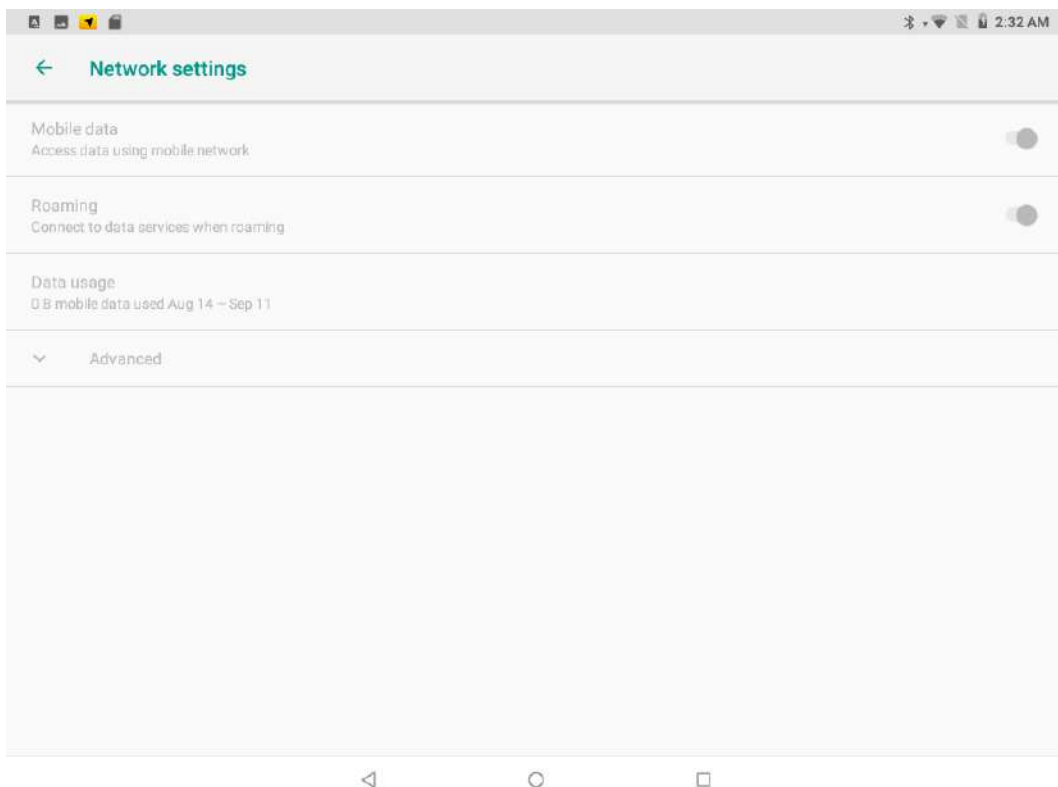



## 3.12 Camera Features

Your device has a built in 2 MP front camera.

### 3.12.1 Taking Pictures

To open Camera:

1. From the lock screen, touch **Camera**  and swipe away from the camera icon in the bottom right corner.
2. From the Home screen, touch **Camera** .

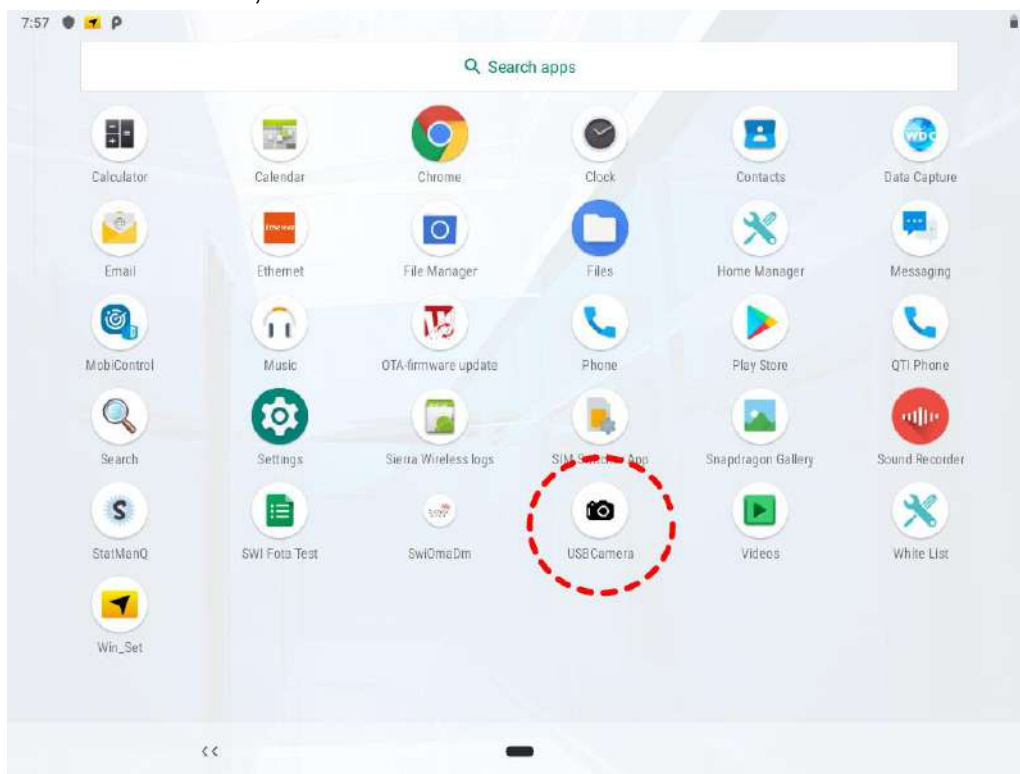

When you open Camera, you can choose from several different camera modes, in a USB Camera pop-up window press **Ok**.

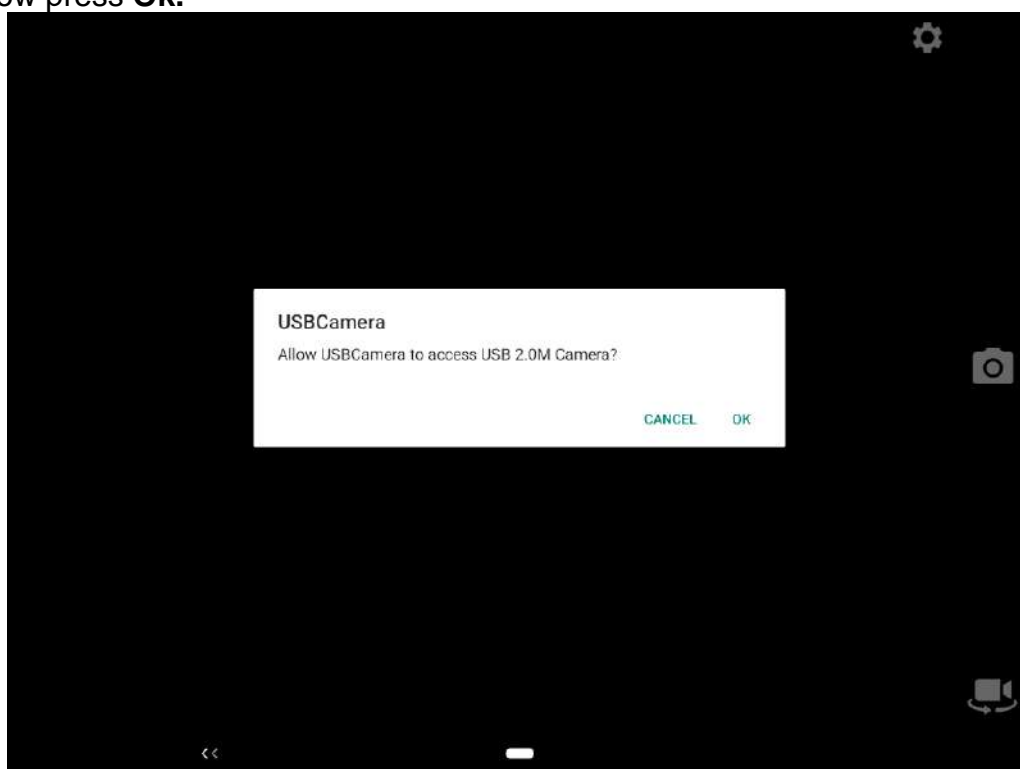

Tap camera icon  to make a photo.

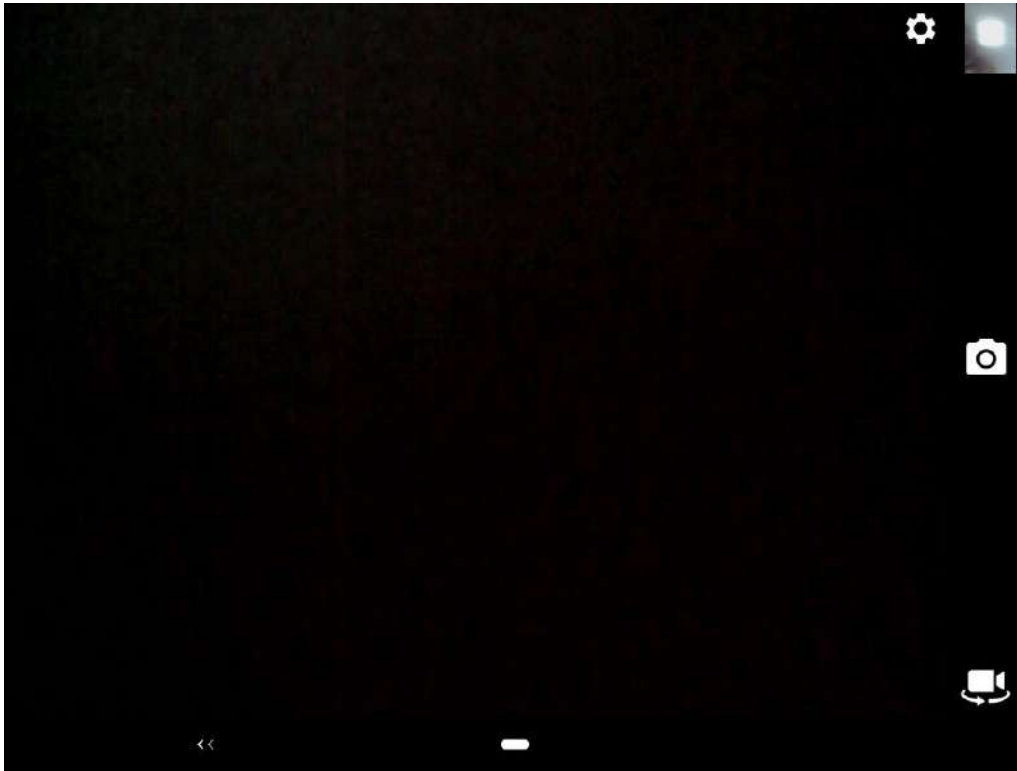

### 3.12.2 Making Videos

Press change to video icon  to change to a video recording mode.

To start recording a video, touch the video icon . Touch the same icon  to stop recording.

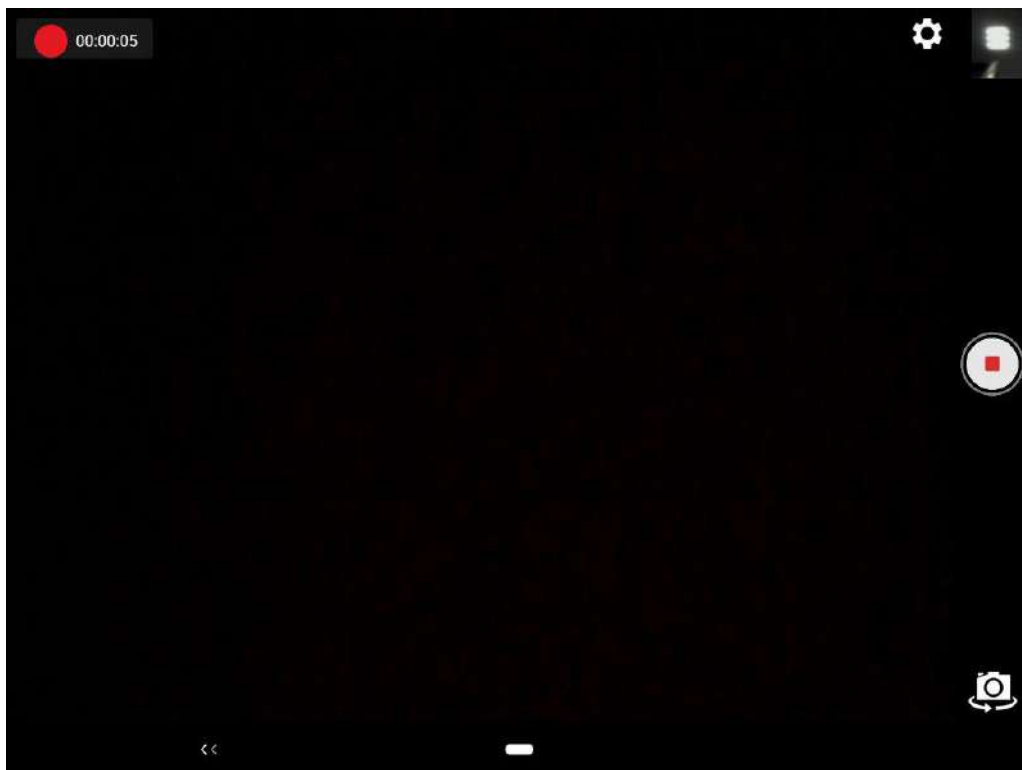

### 3.12.3 Camera Settings

You can change camera setting such as resolution & quality, save location, etc. in settings. To enter camera settings, touch setting icon  in camera app.

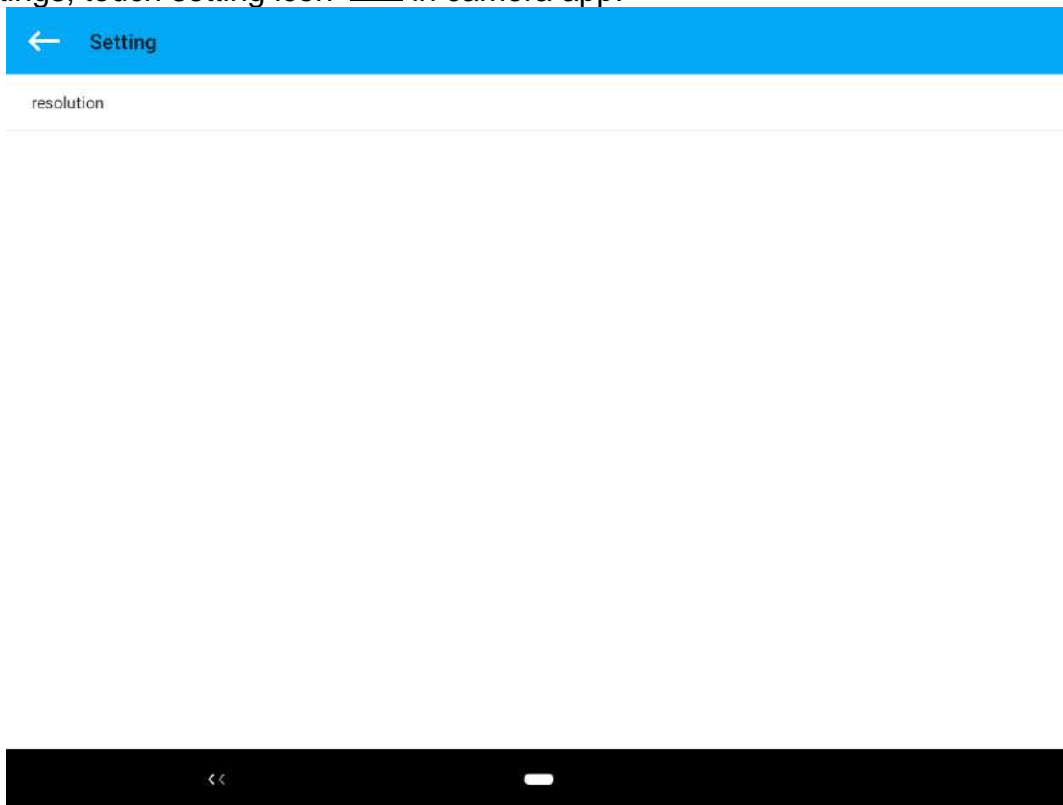

### 3.13 Software Update

Follow the software update guide to update the software. All the programming guides can be found in Winmate Download Center.

You need to download the software to the SD card. Insert SD card to the FM10Q device to perform OTA Updates.

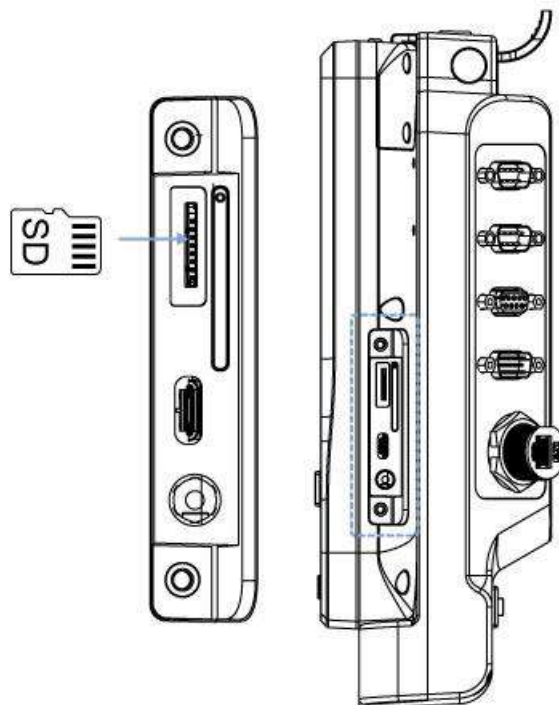

### 3.13.1 Image Tool Download

Download OS Image Tool update guide from Winmate Download Center.

<https://www.winmate.com/> > Support > Download Center

### 3.13.2 OTA Update Guide

OTA is a tool which can help you to update OS image. To receive Android OS image file contact our sales representatives. Once you get the image file follow the guideline below.

1. Copy image files **ota\_FA33\_X\_X\_X\_X.zip** and **FA33\_X\_X\_X\_X.md5** and to micro SD card.
2. Insert micro SD card to the slot in the HMI device.

In the **APPS** menu tap **OTA Image Update** .

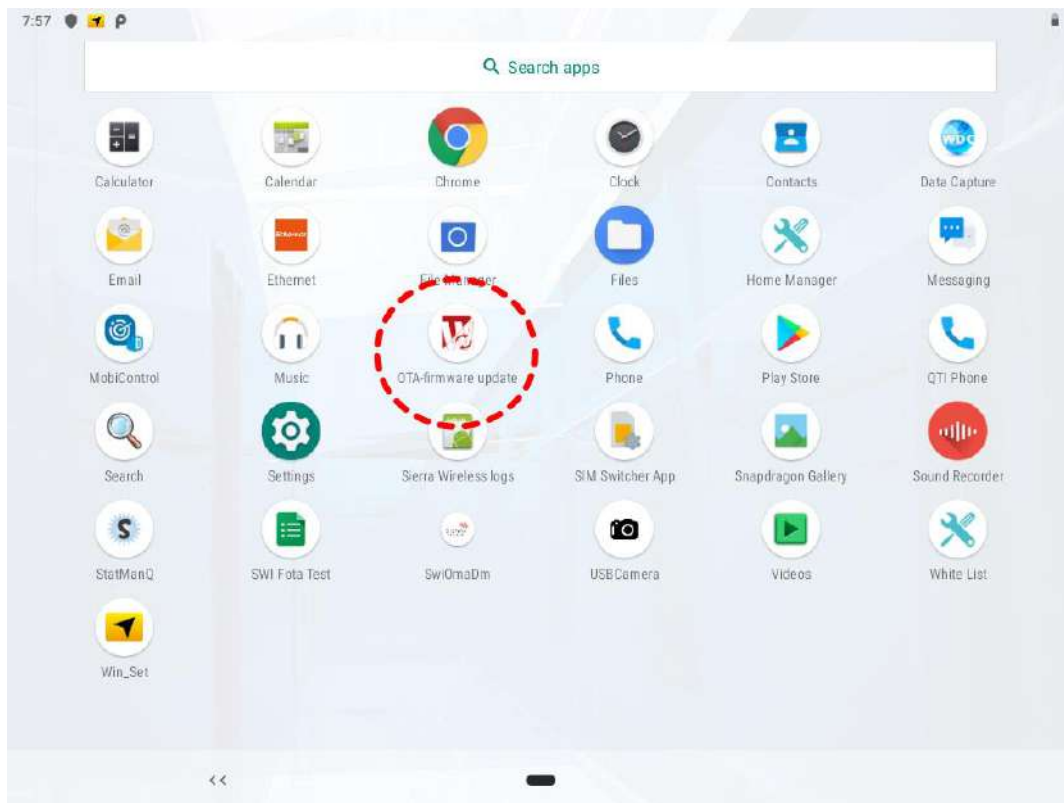

*System shows OTA firmware related information.*



3. Click **Manual Update**. The system is checking OTA File. It may take some time.

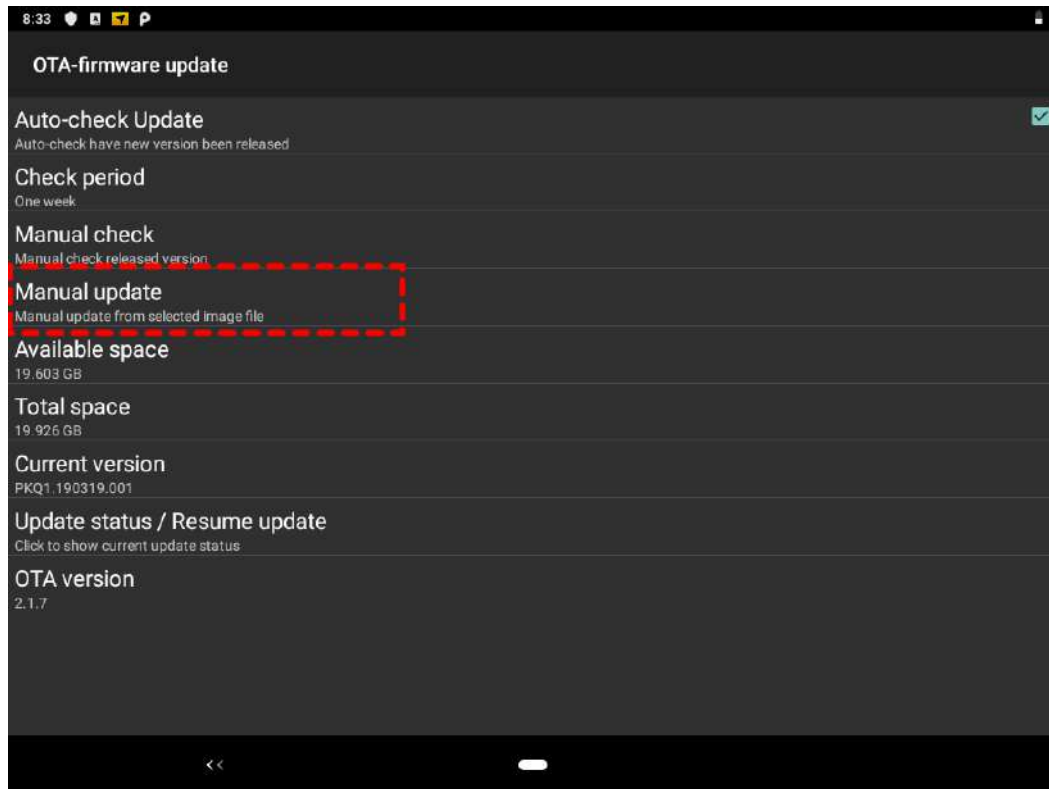

4. Click **"Update Image"** and choose the file that needs to be updated.

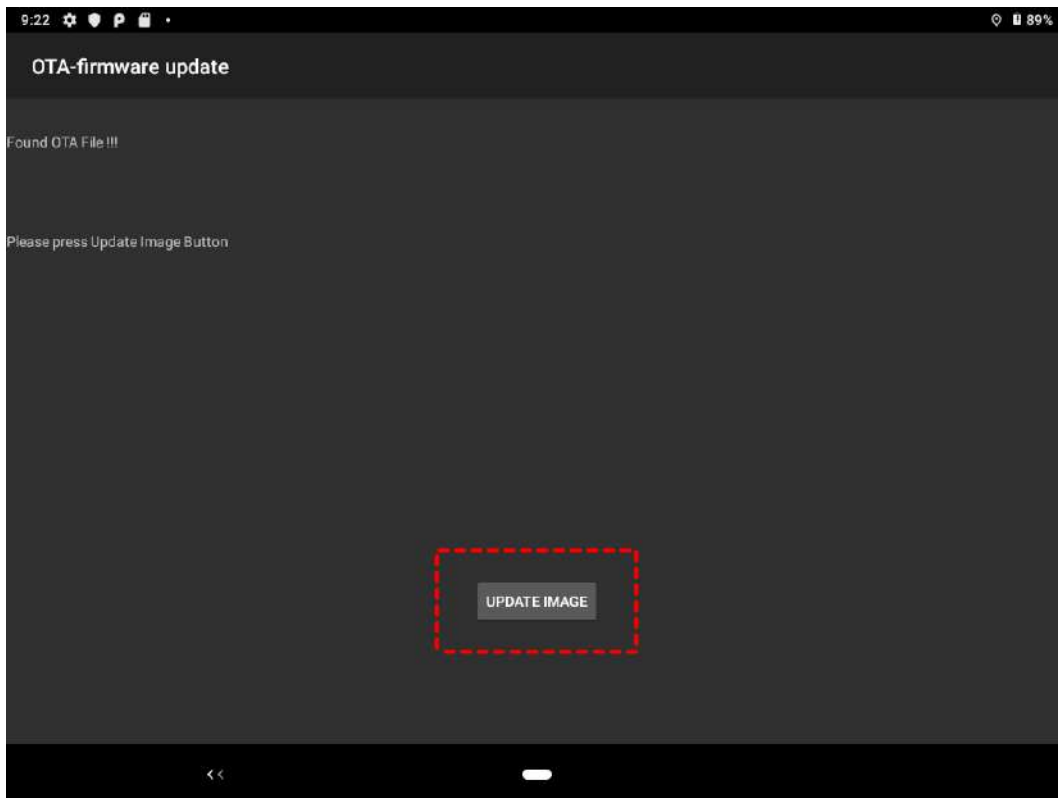

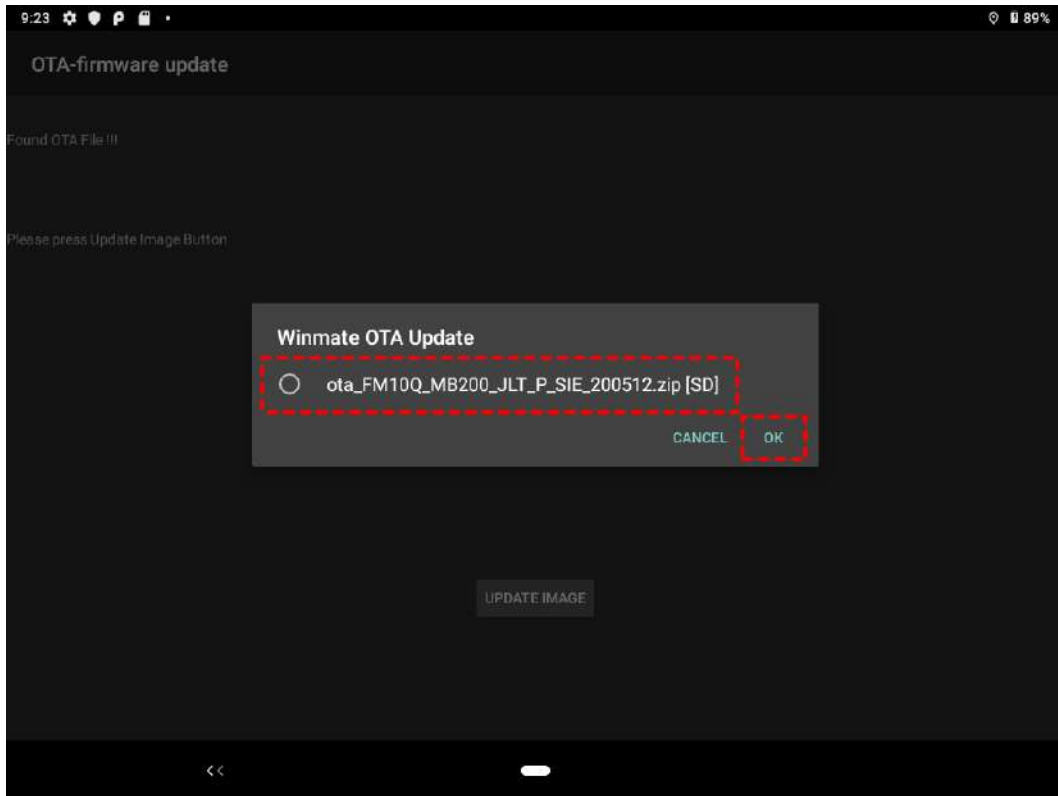

5. Wait for download finish it will take some time.

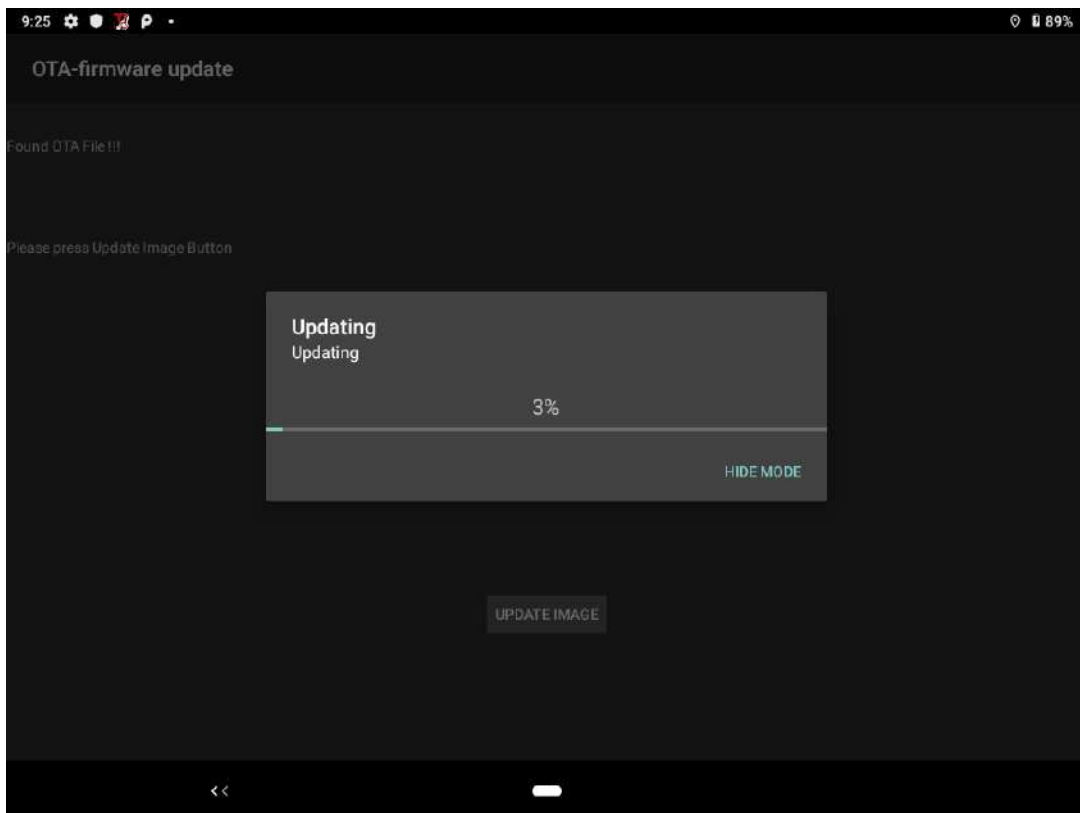

6. Click "REBOOT NOW".

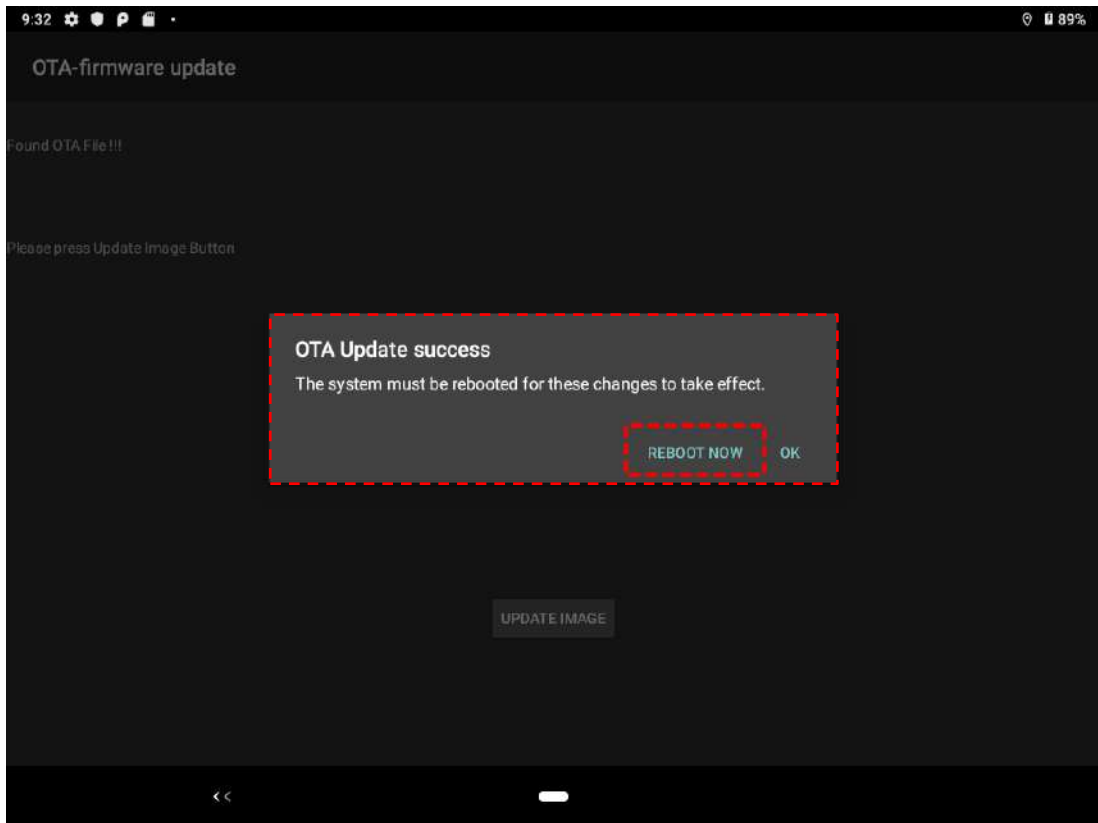

7. Wait for OTA to update.



**Important:** Do not disconnect the power source! Do not remove the battery!

8. When Update finish, the computer opens desk screen.

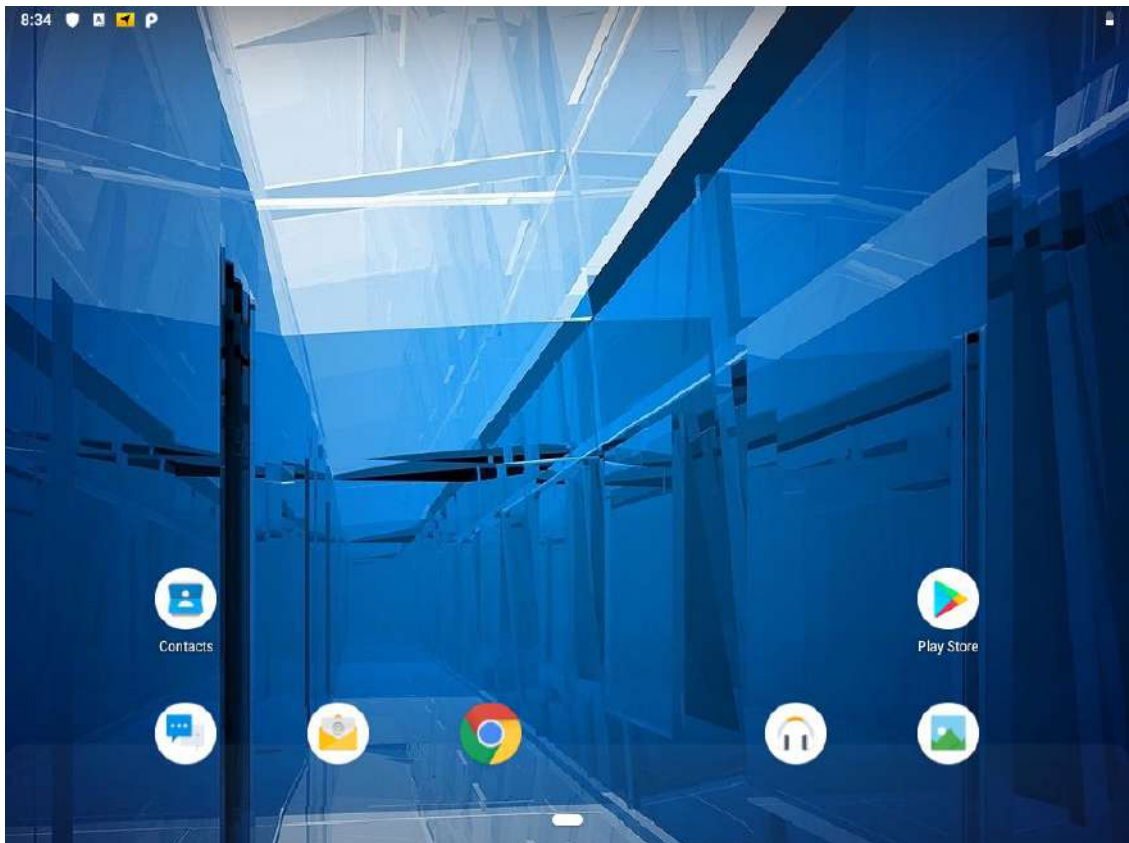

### 3.13.3 OS Image Update Guide

1. Please make sure that the device is in the shutdown state.
2. Press power button to power on device.
3. And release power button then press volume down button around 5 seconds, the device will go into fastboot mode and screen is lock in bootloader.



4. When the device enters the burning mode, please click the downloaded image file. There is a **flashall.bat** in the file. Click twice to start burning.

```
erasing 'userdata'...
OKAY [ 0.435s]
finished. total time: 0.435s
target reported max download size of 536870912 bytes
erasing 'userdata'...
OKAY [ 0.065s]
sending 'userdata' (148916 KB)...
OKAY [ 3.967s]
writing 'userdata'...
OKAY [ 0.088s]
finished. total time: 4.033s
erasing 'persist'...
OKAY [ 0.049s]
finished. total time: 0.049s
target reported max download size of 536870912 bytes
sending 'persist' (4634 KB)...
OKAY [ 0.140s]
writing 'persist'...
OKAY [ 0.001s]
finished. total time: 0.141s
erasing 'vendor'...
OKAY [ 0.141s]
finished. total time: 0.141s
target reported max download size of 536870912 bytes
sending sparse 'vendor' 1/2 (521670 KB)...
OKAY [ 13.629s]
writing 'vendor' 1/2...
OKAY [ 0.008s]
sending sparse 'vendor' 2/2 (30960 KB)...
OKAY [ 0.000s]
writing 'vendor' 2/2...
OKAY [ 0.000s]
finished. total time: 30.179s
rebooting...

finished. total time: 0.050s
Booting the Board
```

## 3.14 Transfer Files via USB

To transfer files via USB follow the procedure below.

1. Open **Settings** .

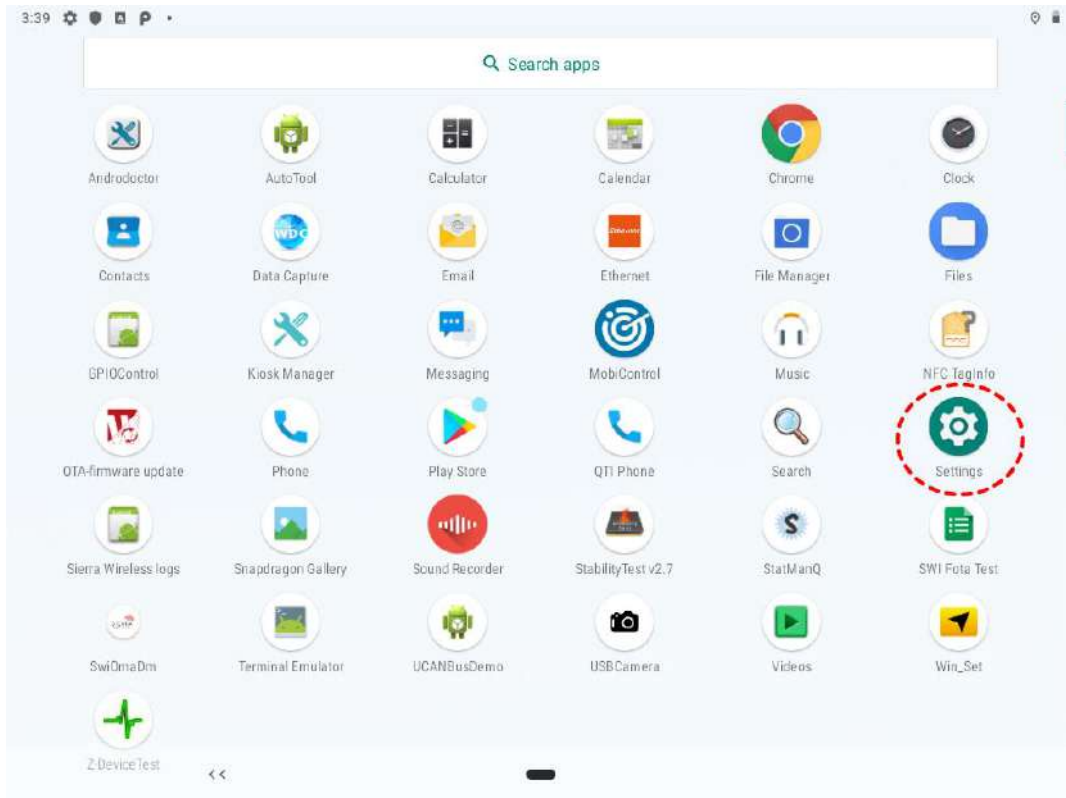

2. Click **About Phone**.

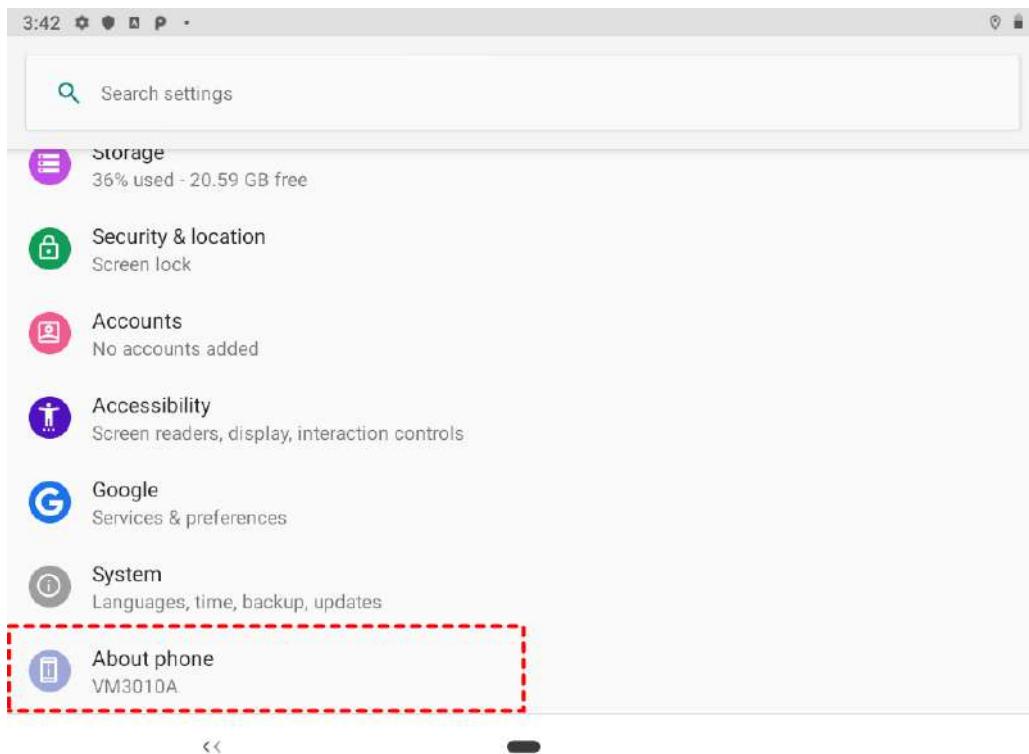

- Continuously click **Build number** until **Developer** is turned on.

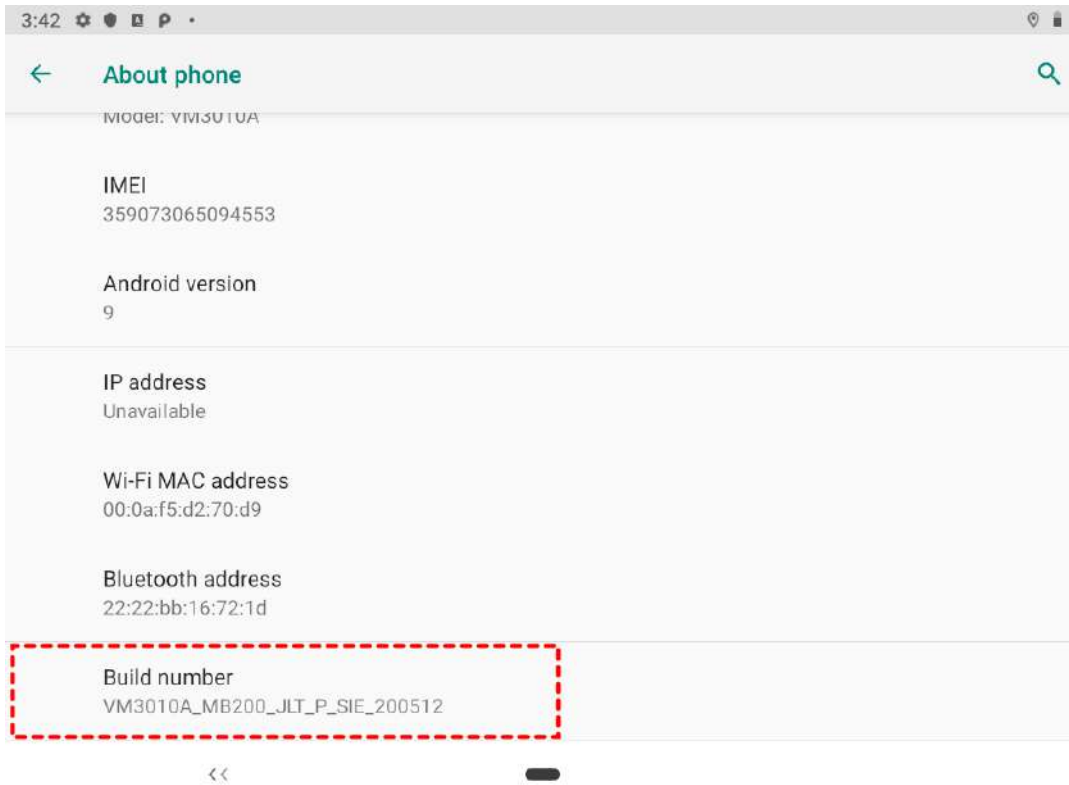

- Go back to **Settings** > **About Phone** > **System**

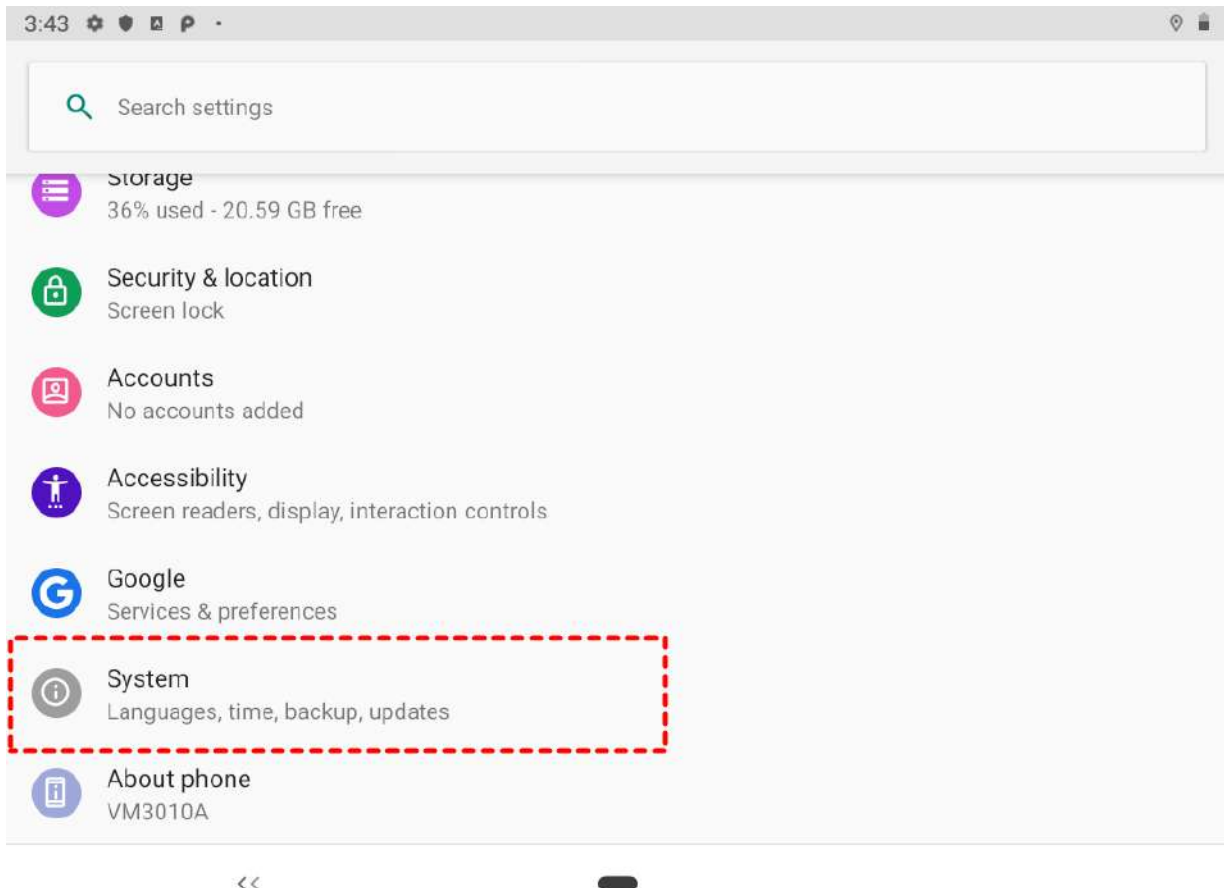

5. Click **Advanced**.

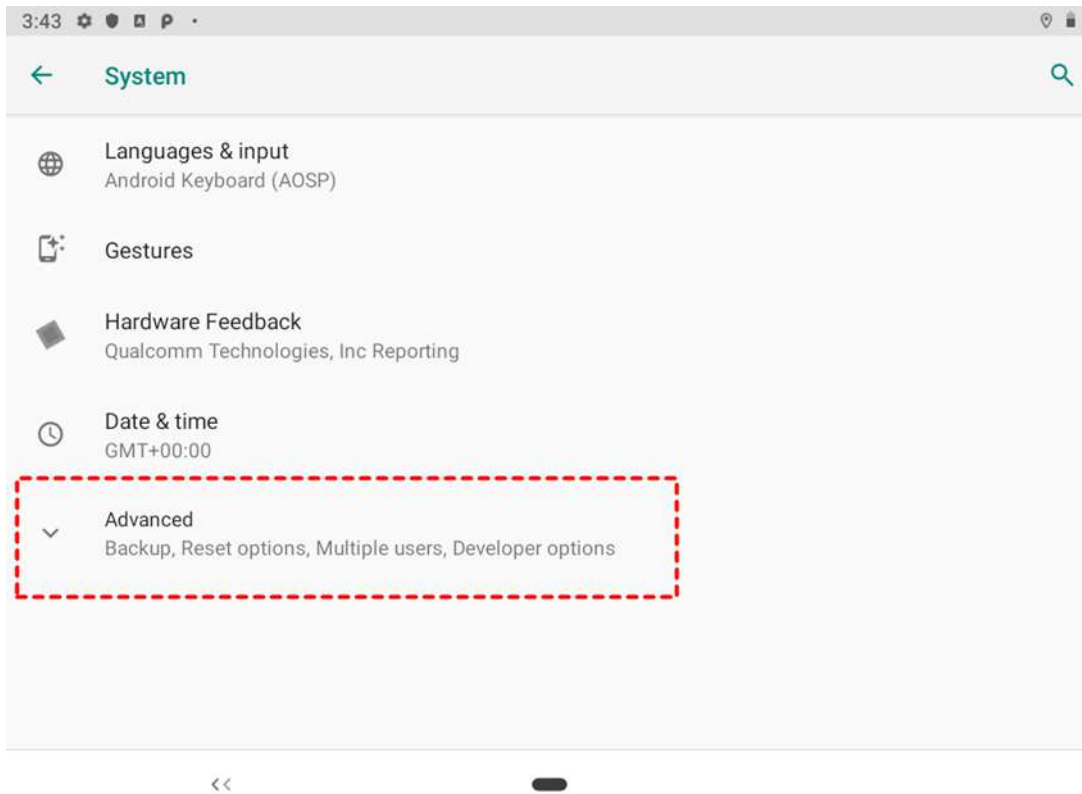

6. Click **Developer options**.

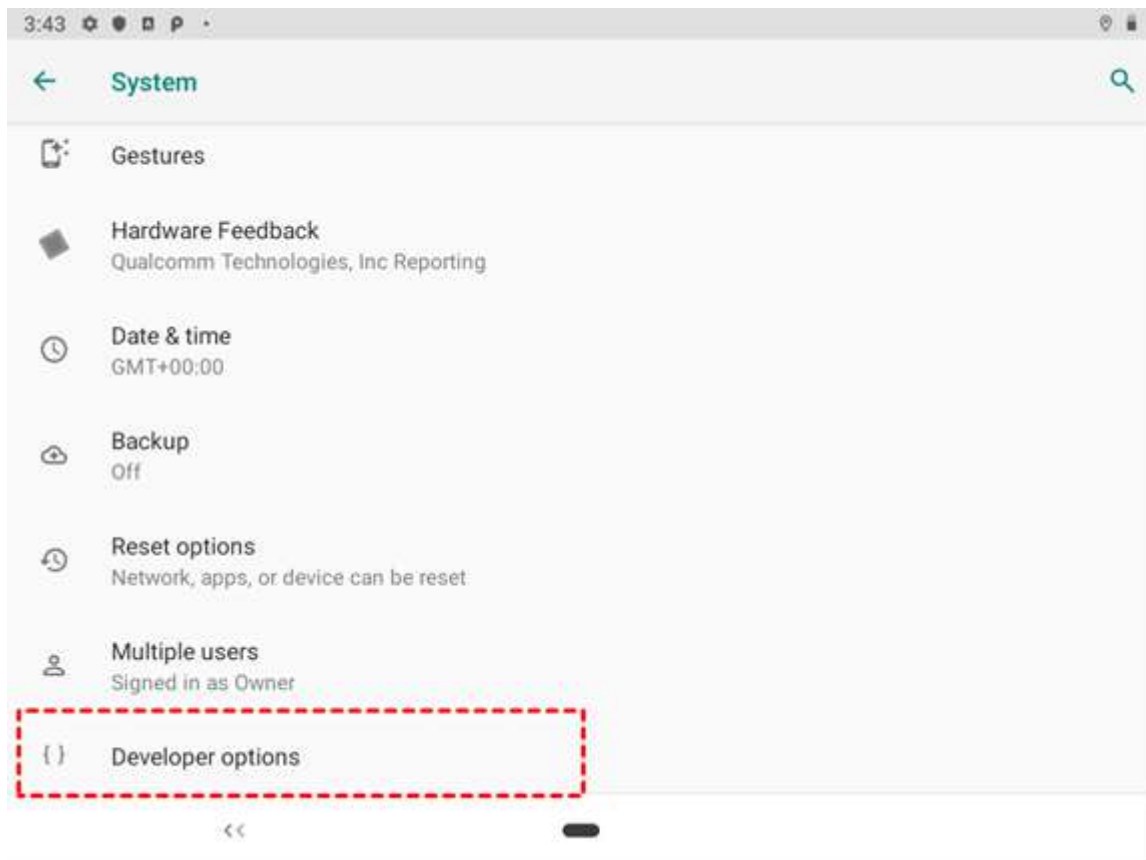

## 7. Click **Default USB configuration**.

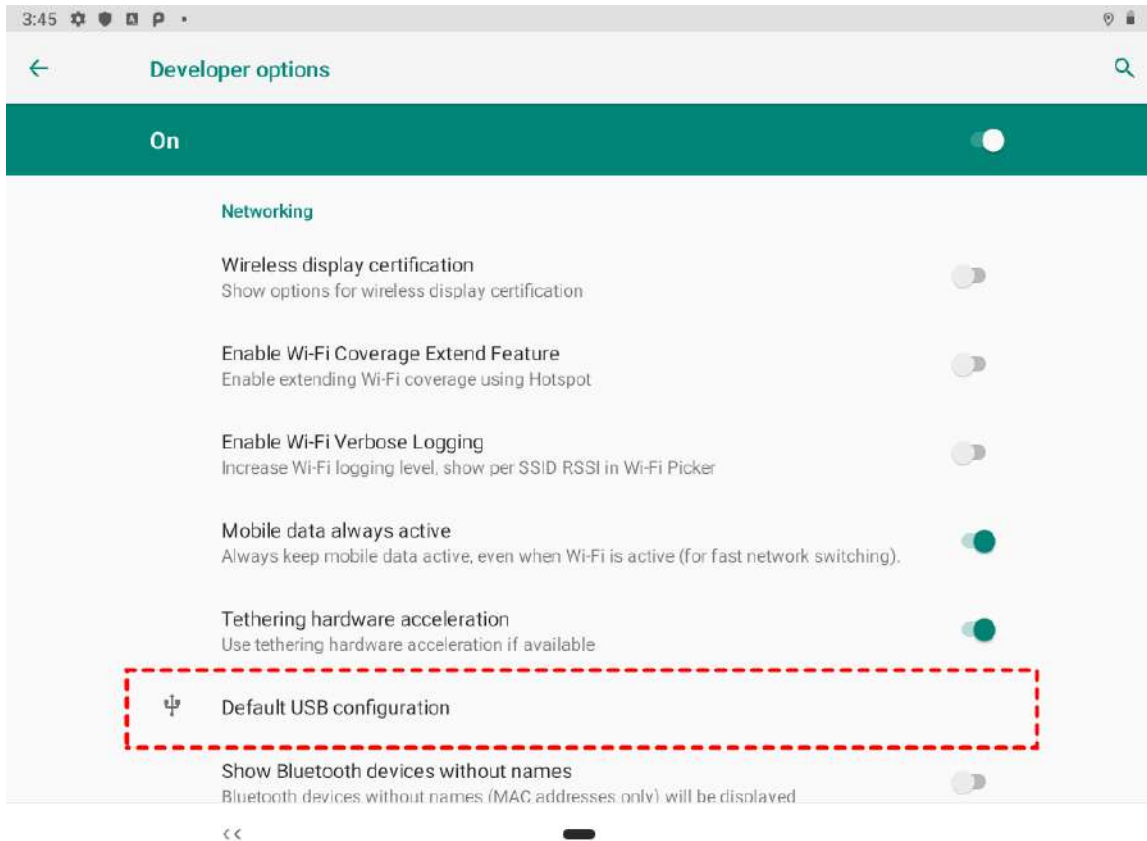

## 8. Select **File Transfer**.

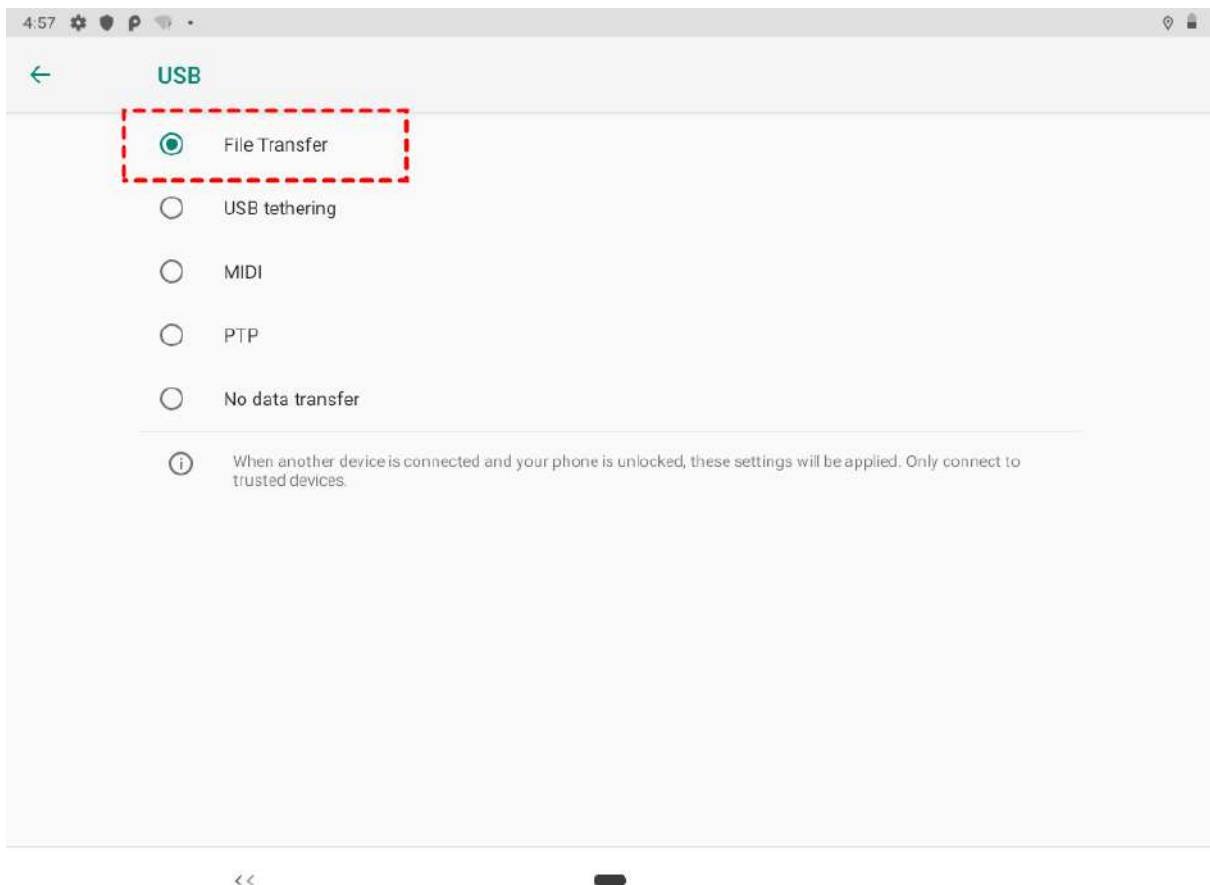



### 3.15 Changing Touchscreen Modes

The touch screen of the FM10Q Series Rugged Tablet supports hand, stylus, glove and water resistant modes. You can change the touch mode in Accessibility settings.

Mode	Description
<b>Hand Mode (Default)</b>	In <i>Hand</i> mode, the touchscreen supports inputs from the bare fingertips and rubber tip passive stylus (shipped with tablet). This is a default mode setting. <i>Supports input by:</i> <ul style="list-style-type: none"> <li>• <i>Rubber tip passive stylus</i></li> <li>• <i>Bare fingertips</i></li> </ul>
<b>Stylus Mode</b>	In <i>Stylus</i> mode, the touchscreen supports inputs from the fine-tip passive capacitive stylus (shipped with tablet). <i>Support input by:</i> <ul style="list-style-type: none"> <li>• <i>Fine-tip passive stylus with palm rejection</i></li> <li>• <i>Rubber tip passive stylus</i></li> <li>• <i>Bare fingertips</i></li> </ul>
<b>Glove Mode</b>	In <i>Glove</i> mode, the touchscreen supports inputs while the user is operating the touchscreen with gloves on. <i>Supports input by:</i> <ul style="list-style-type: none"> <li>• <i>Glove</i></li> <li>• <i>Rubber tip passive stylus</i></li> <li>• <i>Bare fingertips</i></li> </ul>
<b>Water Resistant Mode</b>	In <i>Water Resistant</i> mode, the touchscreen may reject false inputs from liquid drops. To continue using the touchscreen, please clear any remaining liquid droplets away from the touchscreen and wait 3 seconds before using the touchscreen again. <i>Supports input by:</i> <ul style="list-style-type: none"> <li>• <i>Rubber tip passive stylus</i></li> <li>• <i>Bare fingertips</i></li> </ul>

To change touch mode:

1. Open **Settings>Accessibility > Touch Mode**.

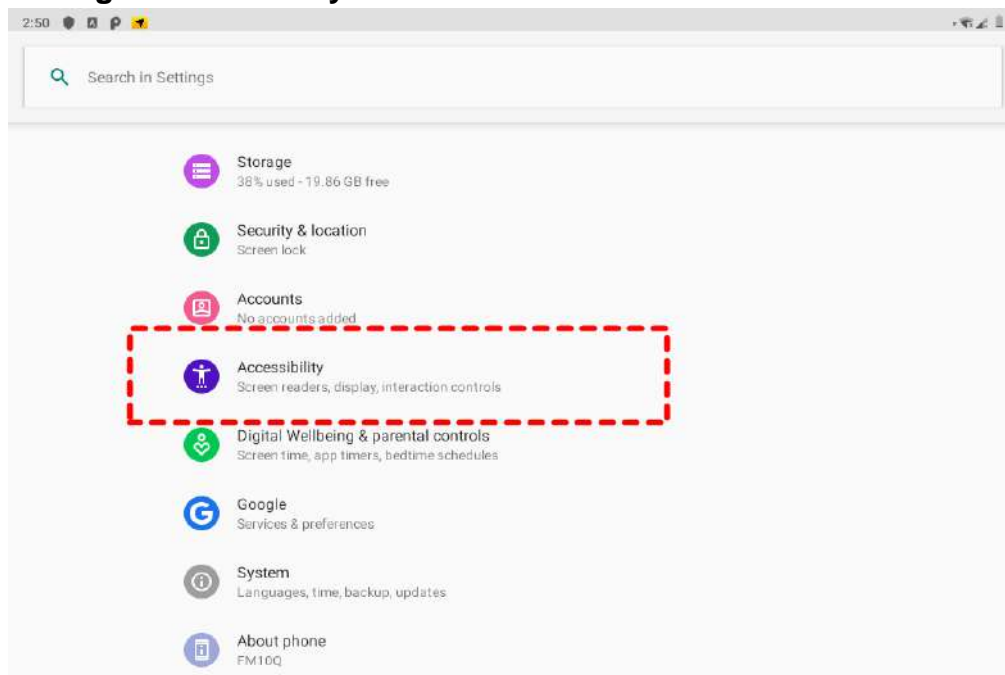

2. Select touch mode. Follow the table below for more information about each touch mode.

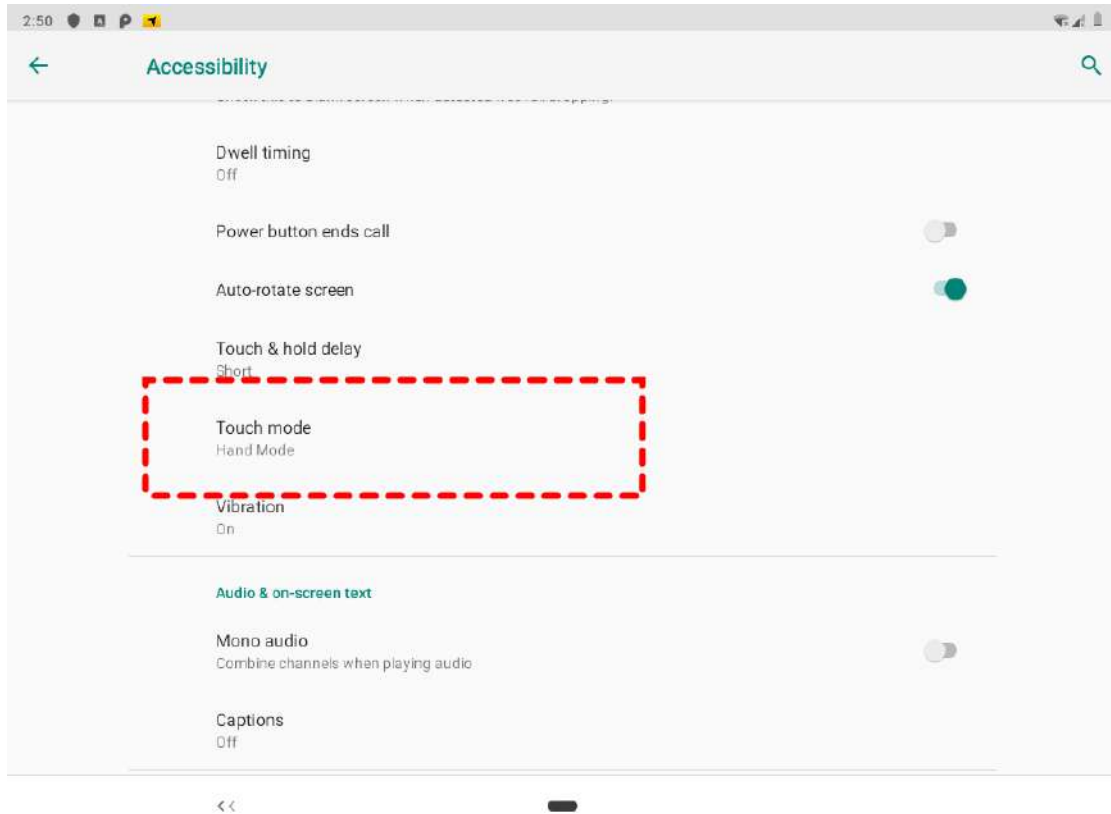

3. Select the touch mode and leave the Touch Mode settings.

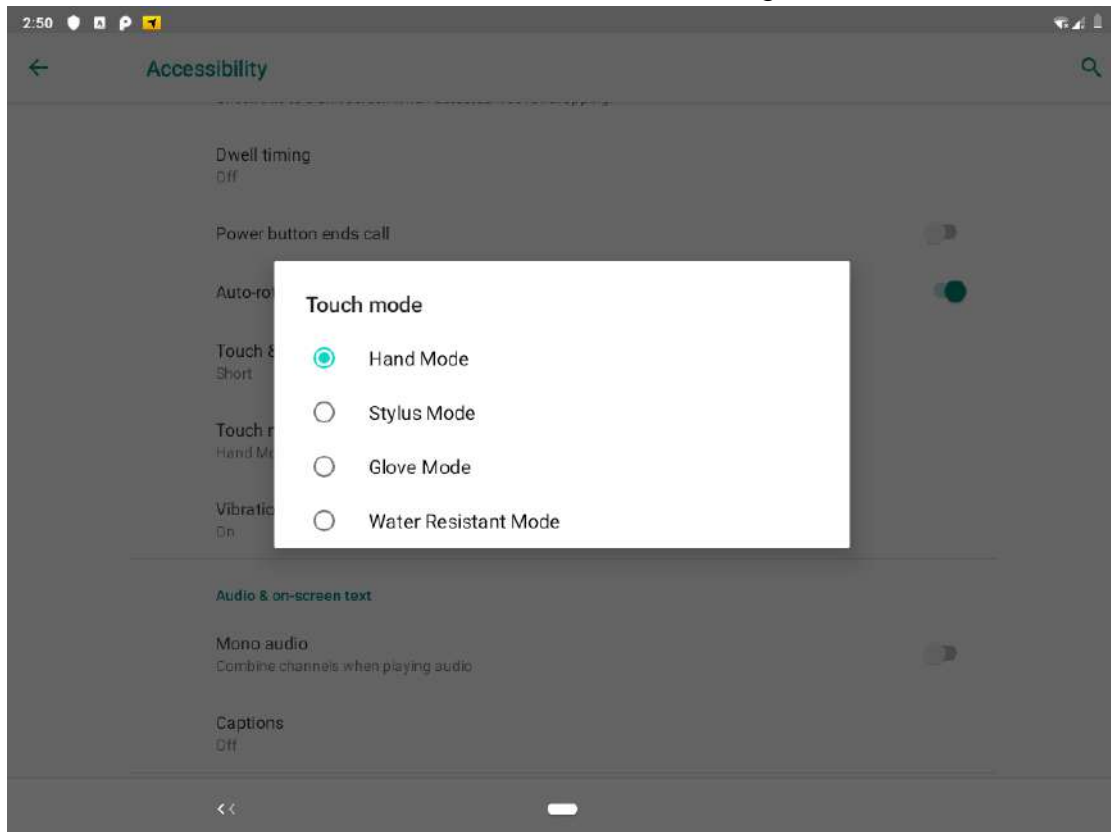

## Chapter 4: Accessories Installation

### 4.1 Installing a SIM Card

The Vehicle mounted computer supports data connection using 4G LTE SIM cards and fits up to two Nano-SIM cards. (Note: 4G LTE feature is optional). Perform the following to install the SIM card to your vehicle mounted computer:

1. Remove the service window in the right side of the device by unscrewing two screws.
2. Remove the screw that is securing the service window, carefully lift the cover up.
3. Locate the SIM card slot and then insert it (the IC contact patch side of the SIM Card faces toward the front side of the device).
4. Make sure the SIM Card IC contact patch is facing the right direction (as shown in the picture below).

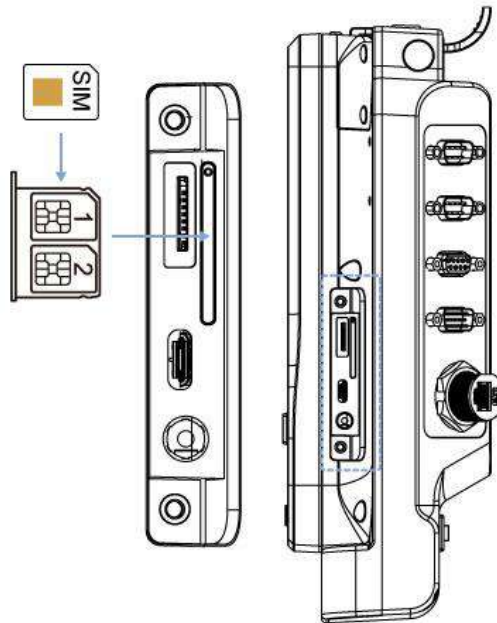

## 4.2 Installing a MicroSD Card

MicroSD card can be used to store files in the vehicle mounted computer, user can copy / download / upload files to and from the VMC. Perform the following to install the SIM card to your device.

1. Remove the service windows in right side of the device by unscrewing two screws.
2. Remove the screw that is securing the service window, carefully lift the cover up.
3. Locate the MicroSD Card slot and then insert it, the label side of the Micro SD card faces toward the back of the device.
4. Make sure the MicroSD card is faced the right direction (as shown in the picture below).

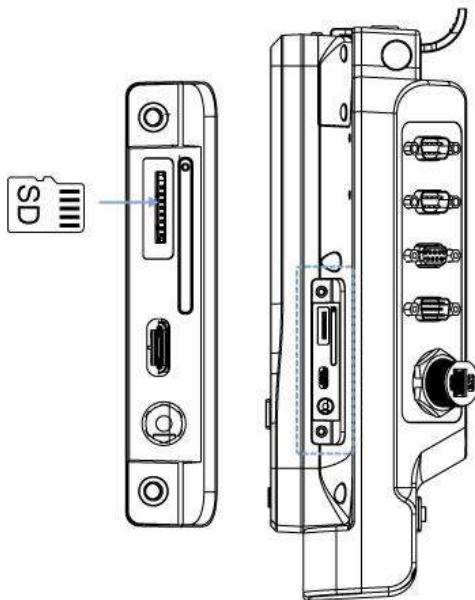

5. Reposition the removed service window and then screw to secure the service window

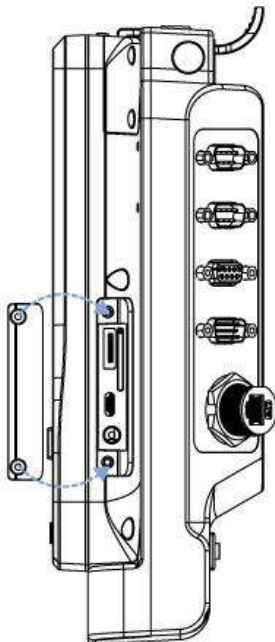

### 4.3 Installing a Stylus with the holder

Perform the following to dock the device

1. Align the screw hole between the stylus holder and the rear side of device, fasten it with the given screw.
2. Make sure the direction is correct as following picture.

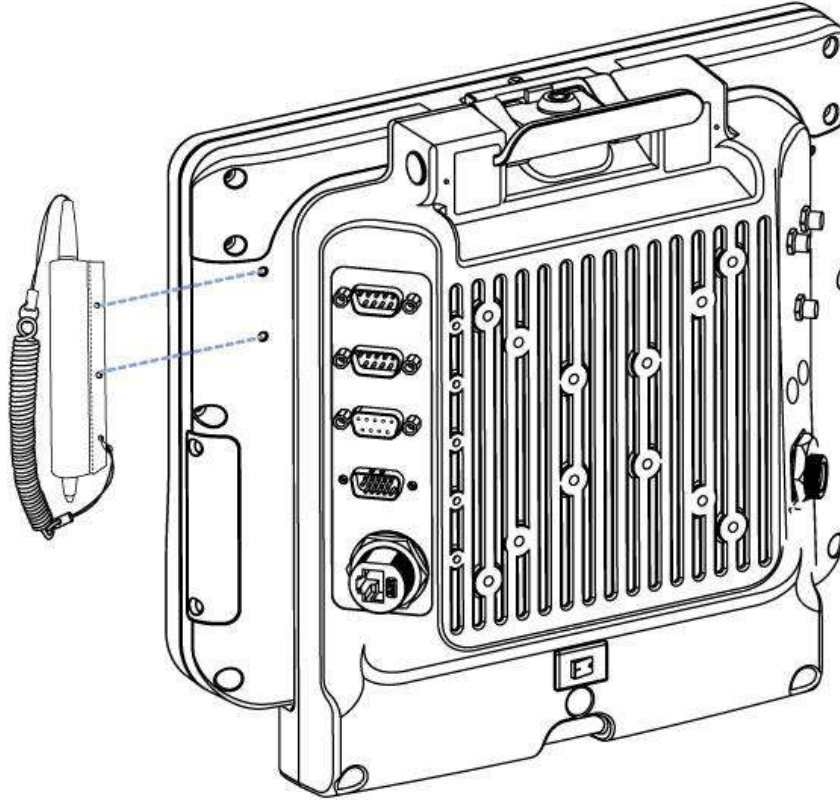

## Chapter 5: Vehicle Mounting

### 5.1 Introduction

The FM10Q is designed to be mounted to a docking station on the vehicle with RAM mount. The vehicle mount holds the dock and FM10Q attaches to the dock. The FM10Q can operate on another vehicle equipped with the docking station without the need to mount the device again. The vehicle dock has a latch located on the top side that allows removing FM10Q from the dock. The FM10Q has UPS battery that is designed to supply power to FM10Q for a minimum of 30 minutes when the unit is not attached to the dock.

Rear Side of the FM10Q

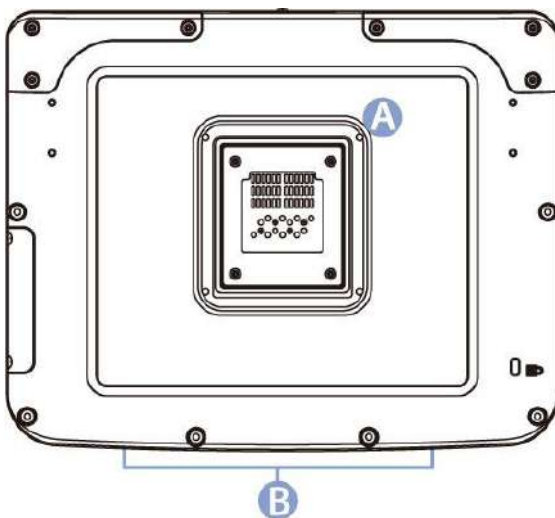

- A. Golden Connector
- B. Guide Pin Holes

Front Side of the Vehicle Dock

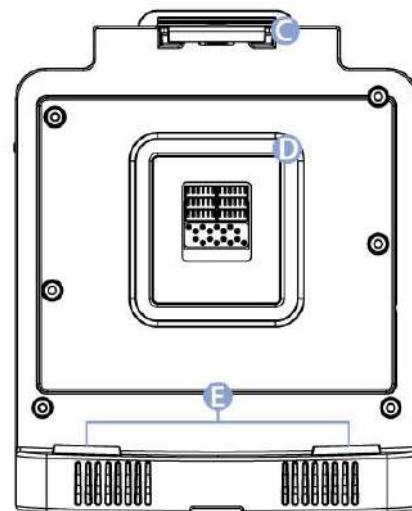

- C. Release Latch
- D. Golden Connector
- F. Guide Pin

### 5.2 Vehicle Mount Instruction

Make sure that the FM10Q does not obstruct the driver's vision and ensures safe driving.

The general steps to mount the device on the vehicle are as follows:

1. Install RAM mount to the vehicle.
2. Place FM10Q to the docking station.
3. Secure the keyboard (optional).
4. Adjust the viewing angle of the FM10Q.
5. Install antennas if necessary.
6. Connect peripheral devices and cables.
7. Connect vehicle power.
8. Secure all cables.

Refer to "[RAM Mount Installation](#)" section of this User Manual for RAM mount and keyboard installation instructions.

## 5.3 RAM Mount Installation

The docking of this device is designed to be mounted to RAM Mount solutions, which provides various mount types to fit any industrial use or vehicle. Notice that RAM Mount kits are not standard accessory of Winmate. We recommend ordering RAM Mount accessories from RAM Mount.

### 5.3.1 Mounting Kit 1 – No Drill Solution

The docking of this device is designed to be mounted to RAM Mount solutions, which provides various types of mount types to fit any industrial use or vehicle. Each mounting kit consists of:

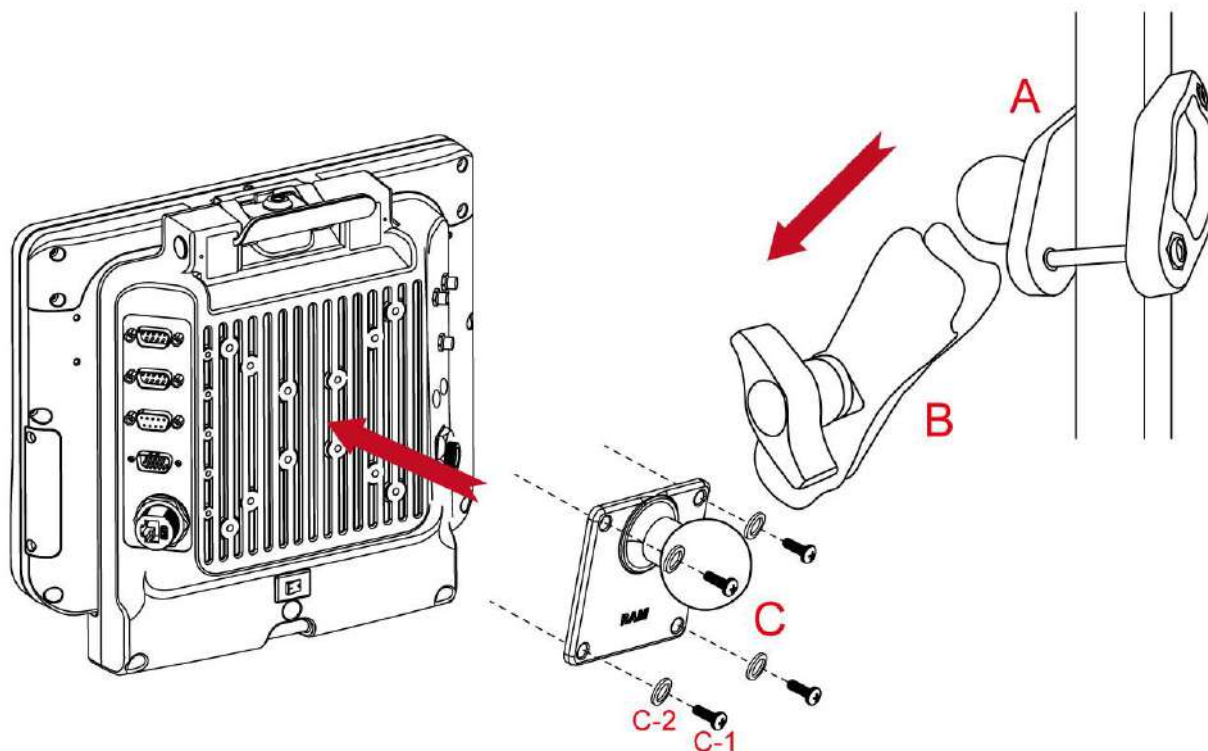

No	Component	RAM Mount Part Number	Description	QTY
A	RAM Clamp Mounts - on the forklift	RAM-D-247U-4	Clamp base with 2.25" Ball	1
B	RAM Arm	RAM-D-201U	Arm for 2.25" Ball(L:8.375")	1
C	RAM Ball on the device side	RAM-D-2461U	75x75mm VESA with 2.25" Ball	1
C-1	Screw	-	SUS304 M5 x 12mm Screw	5
C-2	Washer	-	M5 Washer	5



### 5.3.2 Mounting Kit 2 – Drill Solution

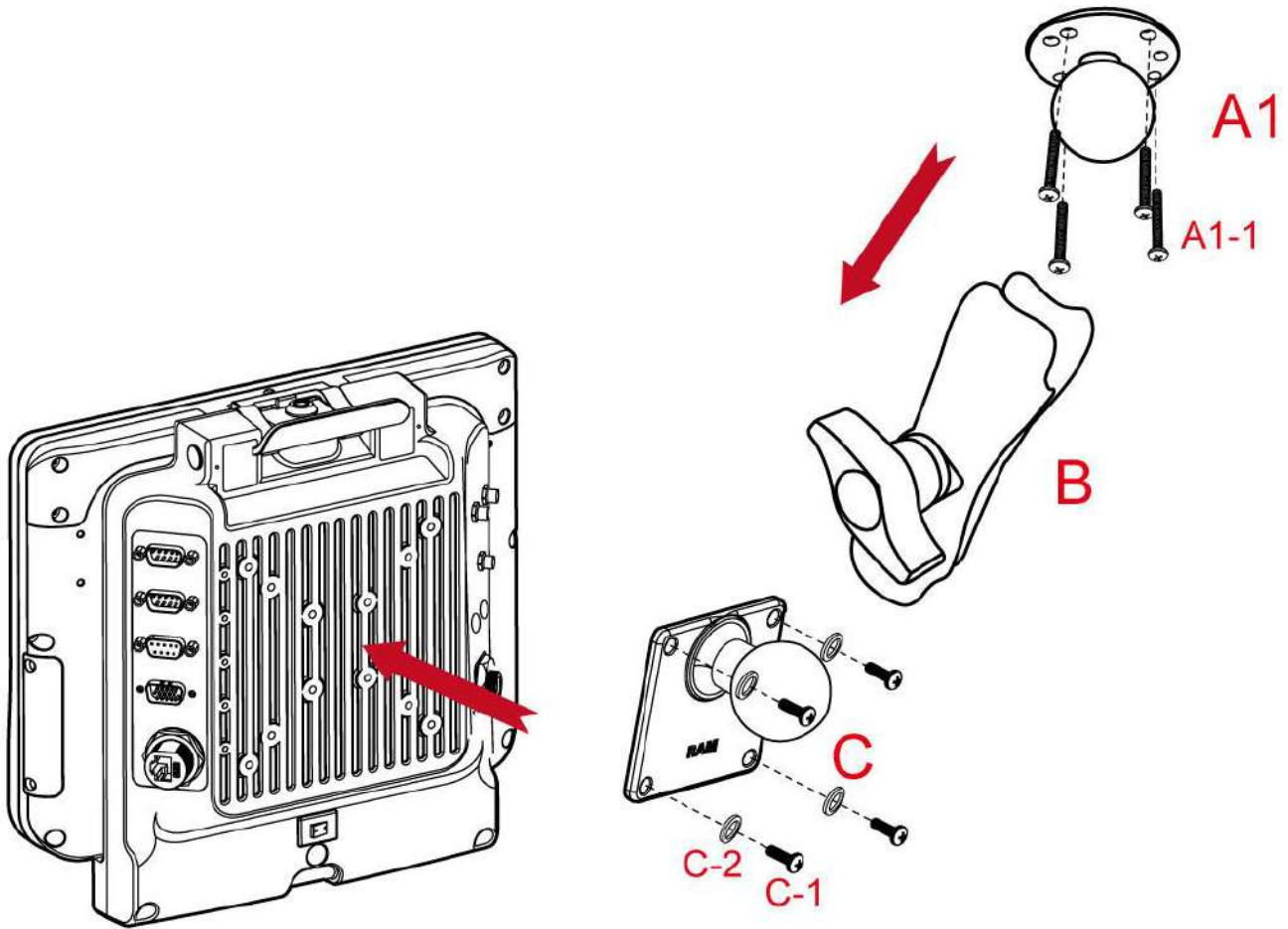

No	Component	RAM Mount Part Number	Description	QTY
A1	RAM round base mounts - on the forklift	RAM-D-202U	3.68" Round Base with 2.25" Ball	1
A1-1	Screw	-	SUS304 M8 x 40mm Screw	5
B	RAM Arm	RAM-D-201U	Arm for 2.25" Ball (Length:8.375")	1
C	RAM Ball on the device side	RAM-D-2461U	75x75mm VESA with 2.25" Ball	1
C-1	Screw	-	SUS304 M5 x 12mm Screw	5
C-2	Washer	-	M5 Washer	5



### **5.3.3 RAM Mount Assembly**

#### **Step 1** Install RAM Clamp to vehicle or forklift

- 1.1 Determine the position for mounting the RAM clamp mount according to RAM Mounts installation guide and specification.
- 1.2 Place the upper clamp with ball on the beam, insert the bolt.
- 1.3 Place the lower clamp below the beam. Align the bolts with the holes in the lower clamp.
- 1.4 Place the nuts and then tighten it.

#### **Step 2** Install RAM Ball base to vehicle dashboard/ another surface.

- 2.1 Please make sure that the surface is flat and rigid.
- 2.2 Attach the RAM ball base to the vehicle and fix it using bolt or fasteners.

#### **Step 3** Attach RAM Mount Ball to the device docking.

- 3.1 Turn the device off before installing the RAM mount ball.
- 3.2 Locate the VESA mount holes on the back of the device and align it with the holes from RAM Ball base. Fix with four M5 screws.

#### **Step 4** Attach the device to RAM arm.

- 4.1 Insert the RAM arm over the ball on the vehicle RAM mount (shown here).
- 4.2 Insert the ball on the dock into the RAM arm and tighten the knob.

### 5.3.4 Mounting Kit 3 – Keyboard Mounting Installation

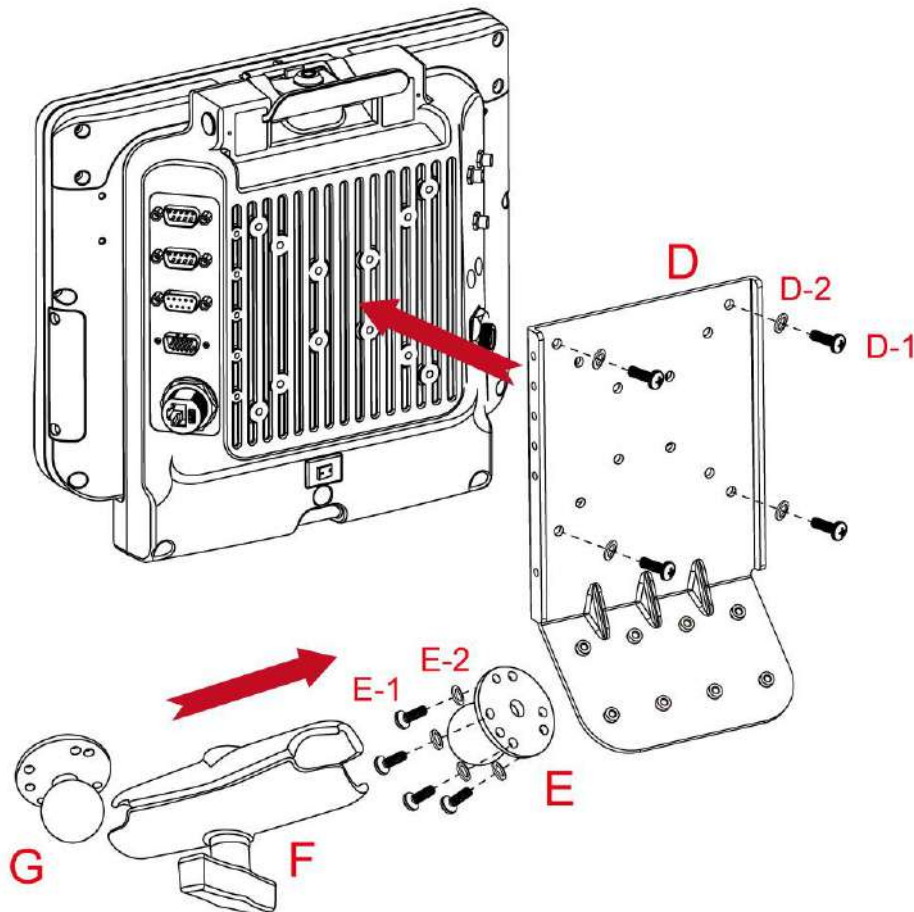

No	Component	RAM Mount Part Number	Description	QTY
D	Winmate Keyboard Adapter Plate (designed by Winmate)	-	4 VESA Holes on the plate to device and 4 AMPS holes to RAM Ball	1
D-1	Screw	-	SUS304 M5 x 20mm Screw	5
D-2	Washer	-	M5 WASHER	5
E	RAM Ball on the sloped part of the keyboard adapter plate	RAM-202U	2.5" Round Base with 1.5" Ball	1
E-1	Screw	-	SUS304 M4 x 14mm Screw	5
E-2	Washer	-	M4 WASHER	5
F	RAM Arm	RAM-201U	Arm for 1.5" Ball (Length:5.6")	1
G	RAM Ball on the sloped part of the keyboard adapter plate	RAM-202U	2.5" Round Base with 1.5" Ball	1

### **5.3.5 Keyboard Assembly**

This part shows the steps to install the keyboard.

1. Fasten all four screws on the RAM mount ball on the back of the keyboard.

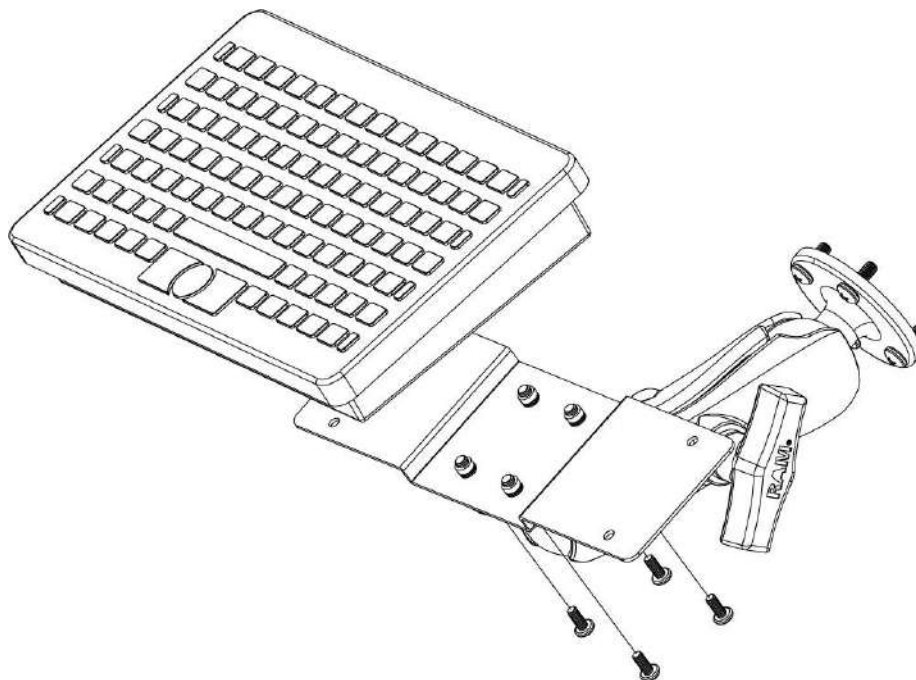

2. Fasten the keyboard adapter on the other end of the RAM mount ball.

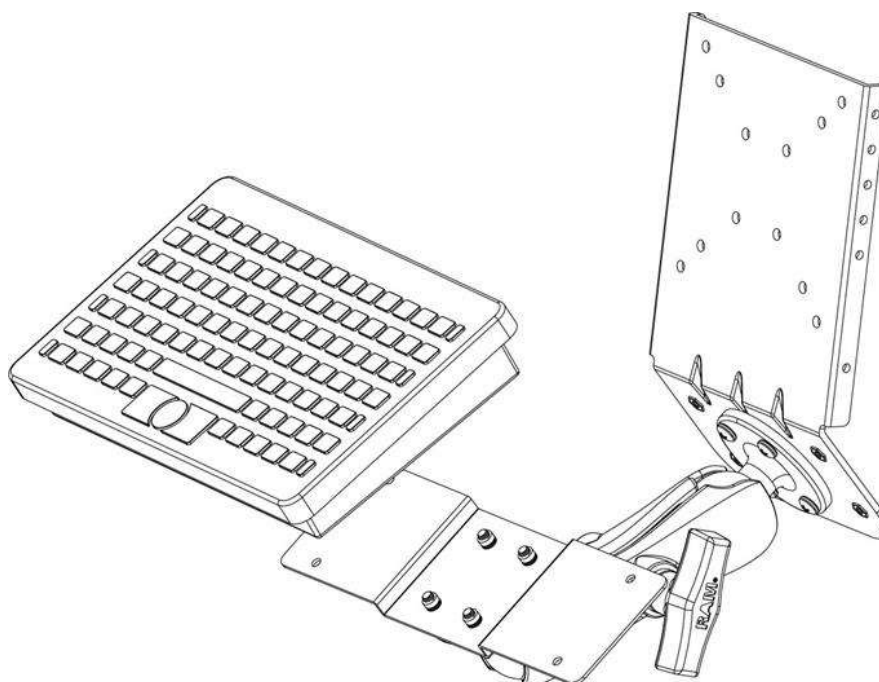

3. Fasten the RAM mount ball screws on the back of the device, so all mounting parts are fastening together.

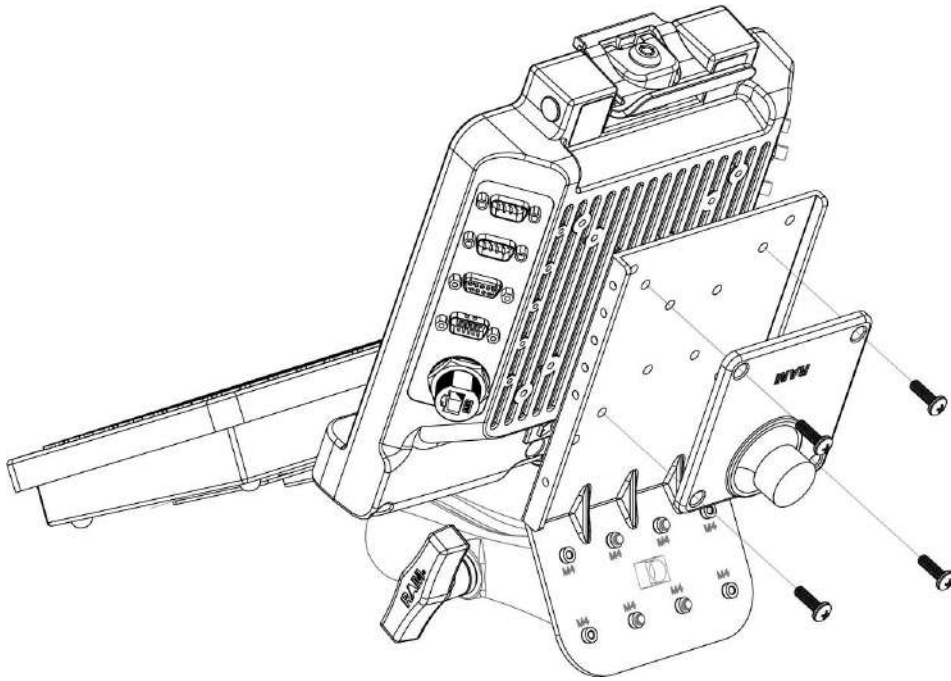

## 5.4 Docking and Undocking the Device

Perform the following to dock the device:

1. Align the golden connector and guide pin holes on the device with the golden connector and guide pins on the docking station
2. Insert the device into the guide pin holes on the docking station
3. Slightly push the upper part of the device towards the docking station until you hear the "click" sound, including the device is fixed on the docking station.

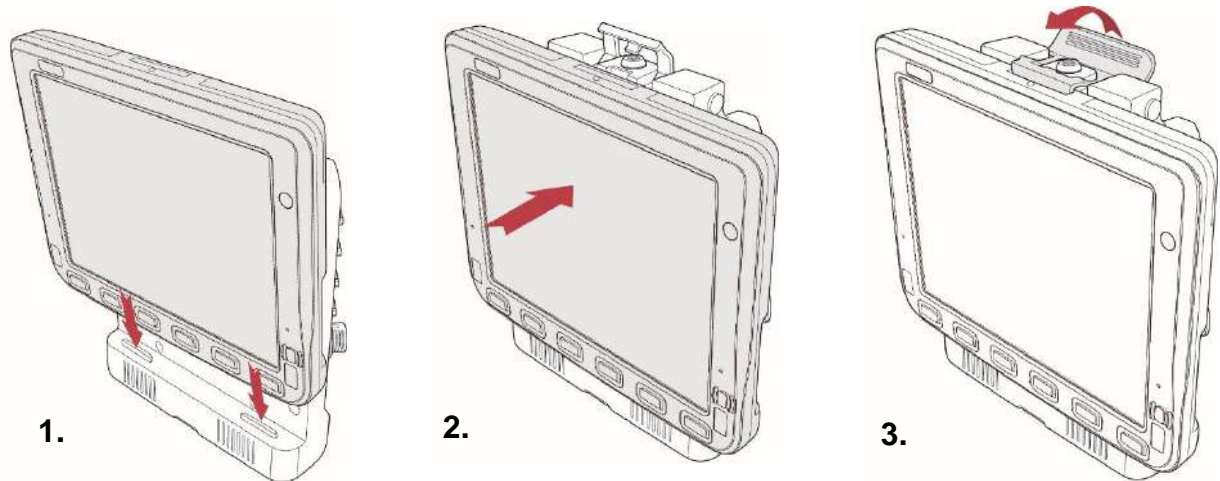

	Condition	Result
 <p><b>Note</b></p>	If the battery is full and power is connected to the dock.	The battery indicator is off.
	If the battery is low and power is connected to the dock.	The battery indicator is orange.

Perform the following to undock the device:

While holding the device, push the release latch on the docking station and then lift the device to un-dock it.





## 5.5 Power Cable Installation

### 5.5.1 Wiring the Power Cable



**Warning!** This procedure requires a trained service personnel only, improper installation can cause serious damage to the vehicle or the device.

**Avertissement!** Cette procédure nécessite un personnel de maintenance qualifié uniquement, une mauvaise installation peut causer des dommages importants au véhicule ou le dispositif.

### 5.5.2 Connecting the Power Cable for Testing



**Important:**

It is highly recommended to purchase the power cable for testing purpose.

#### Wiring Instruction

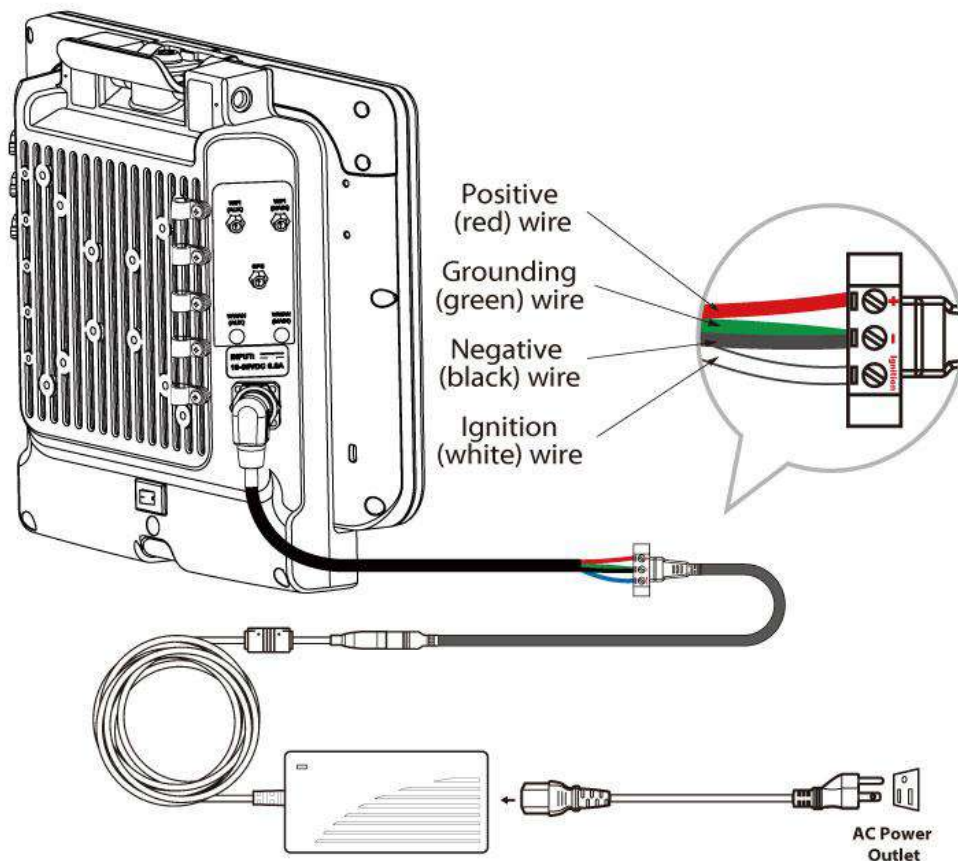

1. Place the device on the vehicle dock and make sure the device is Off.
2. Connect the CN2 to the FM10Q vehicle dock by aligning the connector pins and then push it, twist to fasten the connection.
3. Connect the AC plug to the electrical outlet.
4. Switch the power switch On, located on the back of the vehicle dock.
5. Press the On button, the device is ready for testing.

### 5.5.3 Connecting the Power Cable for Installation on the Vehicle



**Warning!** This power cable should only be used on the 24, 36, or 48 Volt forklifts. Note that, this power cable cannot work for 12 Volt forklifts.

**Avertissement!** Ce câble d'alimentation ne doit être utilisé sur les 24, 36, ou 48 chariots élévateurs Volt. Notez que, ce câble d'alimentation ne peut pas travailler pour 12 chariots élévateurs Volt.



**Warning!** Select a mounting location and make sure it is not located on the outside the vehicle.

**Avertissement!** Sélectionnez un emplacement de montage et assurez-vous qu'il ne se trouve pas à l'extérieur du véhicule.



**Warning!** Do not perform the installation on a moving or live electric forklift.

**Avertissement!** Ne pas effectuer l'installation sur un mobile ou un chariot élévateur électrique sous tension.

#### Wiring Instruction

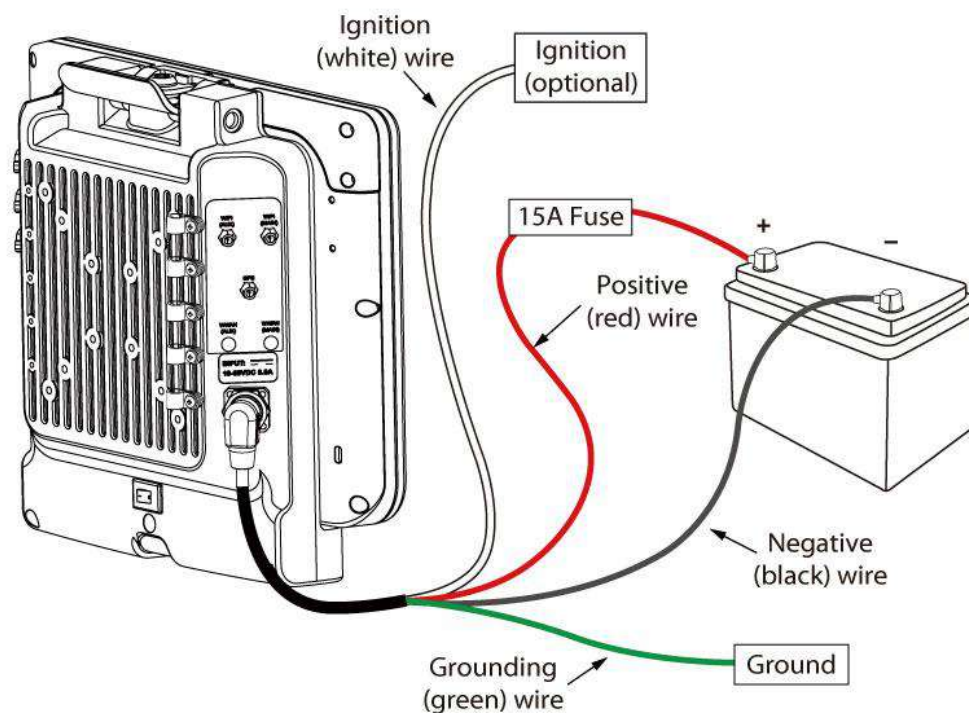

1. Remove the vehicle battery before connecting the power cable
2. Connect the **Green** Wire (Ground) to the vehicle's chassis (grounding), which can also be negative pole of the battery
3. Place the fuse and fuse holder in-line of the **Red** (VCC +) and **White** (ignition) wires as shown below.

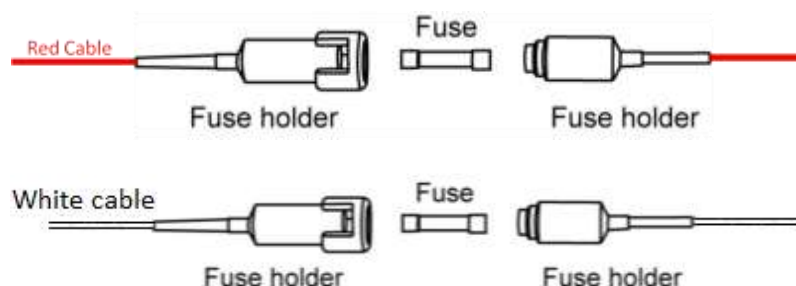

#### Fuse Specification :

Two Fuses , 15A, 250Volt, UDA Type Fuses



**Warning!** All power wiring must use the supplied power cable.

**Avertissement!** Tout le câblage électrique doit utiliser le câble d'alimentation fourni.

4. Slide tubing over wires, remove the wires and insert it to the fuse holder, crimp it.
5. Connect the **red** wire to the vehicle's positive power source. Connect the black wire to the vehicle's negative power source.
6. Connect the white wire to the vehicle's ignition switch for the ignition function, if the requirement is connected to vehicle without ignition, please connect ignition pin to battery V+.



**Warning!** When power is on, ignition pin connects to battery V+ will cause the power consumption even ignition is off.

**Avertissement!** Lorsque l'alimentation est allumée, la broche d'allumage se connecte à la batterie V + provoquera la consommation d'énergie même si l'allumage est coupé

Power cable description:

Color	Symbol
Red	VCC+
Black	VCC-
Green	Ground
White	Ignition input (optional)

#### With Ignition Function

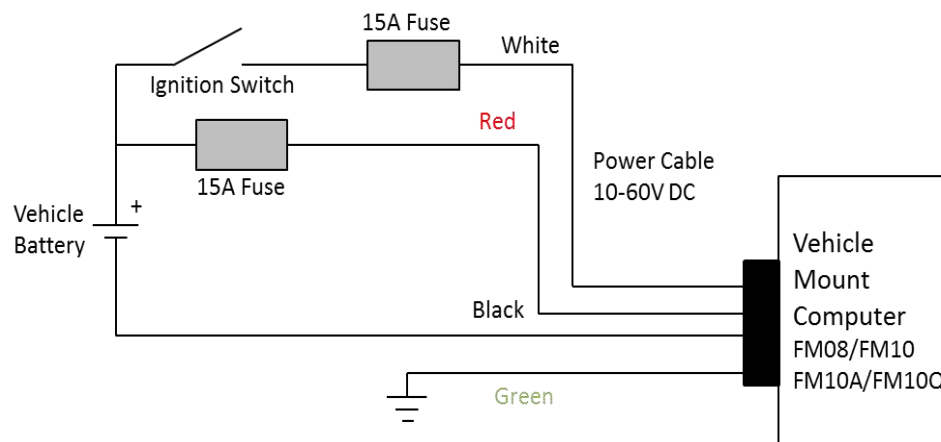

7. The ignition cable (White cable) must be connected to the battery positive if the customer does not want to have ignition function, as following.

#### Without Ignition Function

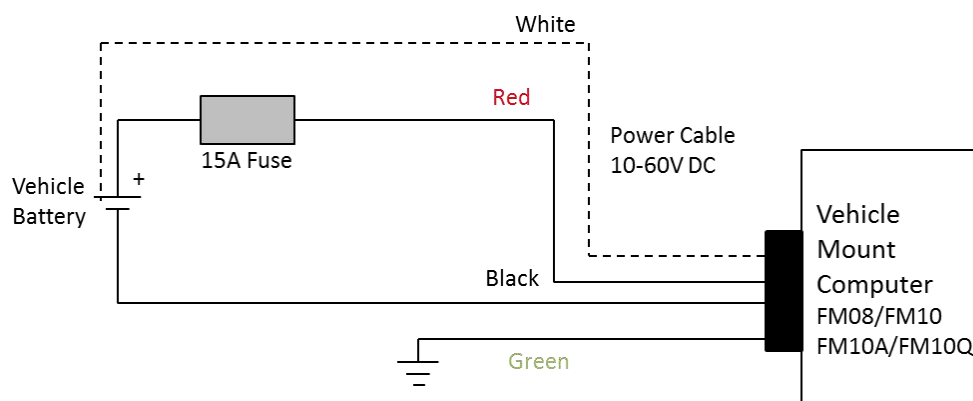



8. Secure the power cable to the device using cable clamps and place the device in the dock. See *Power cable routing*.



**Warning!** Use the proper cable clamps and do not over tighten it to prevent it from break.

**Avertissement!** Utilisez les pinces appropriées du câble et ne serrez pas pour l'empêcher de pause.

9. Press the power switch on the back of the dock See *Power switch*.  
10. Press the power button on the front of the device See *Power Button*.

		Vehicle Installation		Office Test / Evaluation	
		With Ignition	Without Ignition	AC/DC Mode	AP to switch
<b>Power Mode</b>		Ignition-On mode	AC/DC Mode	AC/DC Mode	AP to switch
<b>Auto-On</b>		Auto-On is ON	Auto-On is ON	Auto-On is OFF	BIOS switch
<b>Trigger On</b>	<b>Ignition On Signal</b>	√	√	X	
	<b>Power Button</b>	X	X	√ (press for 2 sec)	
<b>On Delay</b>		0 Second (Default) adjustable by AP			X
<b>Turn Off</b>					
<b>Trigger Off</b>	<b>Ignition Off Signal</b>	√	X	X	
	<b>Power Button</b>	√	√	√	
				<b>First time use:</b> Install all the power cables require for testing. Switch the power switch On, located on the dock and then the device will Auto On / boot up in 10 second.	

#### 5.4.4 Power Cable Routing

There are many cables available for the FM10Q including power cable, CAN Bus cable, or USB cable. To secure these cables, there are five cable clamps secured the FM10Q vehicle dock to prevent the cable strain.

To secure audio, power, and I/O cables perform the following action:

1. Determine the proper strain relief cable clamps; there are different sizes of the clamps depending on the thickness of the cable. For example, the largest clamp is designed to secure the power cable.
2. Remove the cable clamps from the vehicle dock by releasing the screw. Put the screw and save in it the secure location.
3. Slide the clamp over the cable.
4. Refasten the cable clamp to the dock, adjust the tension in the cable to allow it to be connected and disconnected when needed.
5. Repeat this step until all cables are secured to the dock.

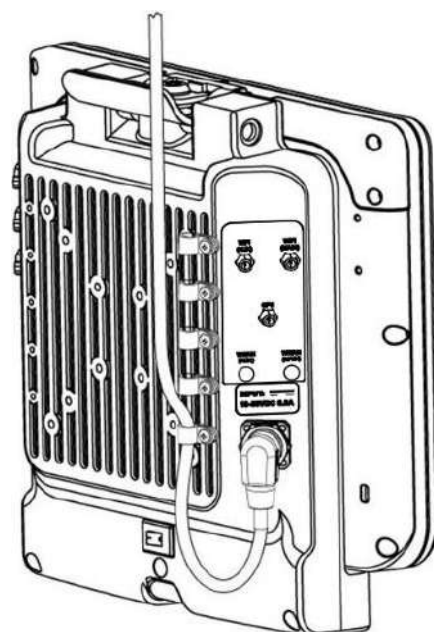

# Appendix

## Appendix A: Product Specifications

Model Name	FM10Q
<b>Display Specifications</b>	
Size / Technology	10.4" (4:3)
Resolution	1024 x 768
Brightness	400 nits (optional 800 nits)
Touch	Projected capacitive PCAP multi-touch
Contrast Ratio	1200:1
Viewing Angle	-88~88(H) ; -88~88(V)
Sensor	•G-Sensor •Temperature Sensor
<b>System Specifications</b>	
Processor	Qualcomm Snapdragon™ 660 octa-core, 2.2 GHz
System Memory	3 GB LPDDR4
Storage	32 GB eMMC, additional storage with Micro SD card slot
Operating System	Android 9.0
<b>Wireless Communications</b>	
WLAN	Support
BT	Support
GNSS	GPS module on Docking board
WWAN	Optional 4G LTE
<b>Interface</b>	
Computer	1 x Dual-Nano SIM Card Slot 1 x Micro SD Card Slot 1 x USB 3.0 Type C (OTG) 1 x 12V DC in power input jack
Docking Station	2 x COM 1 x DB9 for 2 x USB 2.0 Port 1 x CANBus or 1 x Audio (In and Out) 1 x Gigabit LAN port 1 x Power connector 5 x SMA Connectors (female) for external antennas (WLAN, GPS, WWAN)
<b>Input</b>	
Touch	10-point PCAP multi-touch
Physical Buttons	1 x power, 6 x function keys (Programmable function key configured by HotTab Utility)
<b>Status Indicators</b>	
LED Indicators	WLAN, BT, UPS battery, Screen Blanking, Defroster* <i>*Defroster is a customized feature available by request.</i>
<b>Audio</b>	
Speaker	2 x 3W, located on the docking
<b>Cameras</b>	
Front Camera	2 MP webcam, reading light
<b>Security Function</b>	
Mobile Device Management	SOTI Mobicontrol compatible
<b>Mechanical</b>	
Dimensions (W x L x H)	Computer: 268 x 214 x 35 mm (10.6" x 8.42" x 1.37")

<b>Model Name</b>	<b>FM10Q</b>
Dimensions (W x L x H)	Docking: 202 x 245 x 52 mm (7.9" x 9.6" x 2.04")
Docking Housing	Aluminum Alloy housing
Weight	Computer 1.6kg
	Docking 1.6kg
Cooling System	Fanless design
<b>Environment</b>	
Operating Temperature	-30°C to +50°C (-22°F to +122°F)
Storage Temperature	-30°C to +50°C (-22°F to +140°F)
Humidity	5% to 90% RH, non-condensing
IP Proof	IP65
Impact	Support EN62262 IK07 rating
Shock	MIL-STD-810G Method 516.6 Procedure I
Vibration	MIL-STD-810G Method 514.6 Procedure I
ESD	Compliant with EN 61000-4-2, enhanced ESD to ±8kV direct & ±15kV air
<b>Power Management</b>	
Docking Power Input	10V-60V with power isolation and ignition control
Tablet Power Input	12V DC in
Battery	Integrated Li-Ion maintenance UPS with 30-min life at 0°C (32°F)

**NOTE:**

1. Accessories and Integrated Options may vary depending on your configuration. The product shown in this document is a standard model. For diagrams that contain customized or optional I/O, please contact the Winmate Sales Team for more information.
2. All specifications are subject to change without prior notice.
3. Only Sierra Module can support dual SIM single standby function.

## Appendix B: Order Information

The FM10Q Vehicle Mount Computer available in the following configurations:

Model Number	4G	High Brightness Panel	Defroster
FM10Q	N/A	N/A	N/A
FM10Q-LA	4G LTE	N/A	N/A
FM10Q-HB	N/A	Yes	N/A
FM10Q-LAHB	4G LTE	Yes	N/A
FM10Q-T	N/A	N/A	Yes
FM10Q-LAT	4G LTE	N/A	Yes
FM10Q-HBT	N/A	Yes	Yes
FM10Q-LAHBT	4G LTE	Yes	Yes

**Note:** Brightness will be reduced if the defroster is added.

---

Winmate Inc.  
9F, No.111-6, Shing-De Rd., San-Chung District,  
New Taipei City 24158, Taiwan, R.O.C  
[www.winmate.com](http://www.winmate.com)

