

# M101BK

## Rugged Windows Tablet

Intel® Quad-Core™ N2930 Bay Trail-M

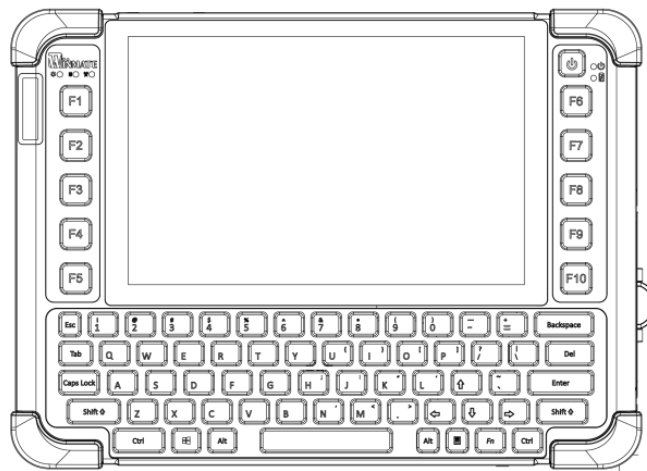

# User Guide

---

# Contents

<b>CHAPTER 1: READ ME FIRST</b> .....	<b>3</b>
1.1 ADVISORY CONVENTIONS.....	4
1.2 DECLARATION OF CONFORMITY.....	5
1.3 SAFETY INFORMATION.....	6
1.4 HANDLING AND MAINTENANCE.....	8
1.5 COPYRIGHT NOTICE.....	9
1.6 TRADEMARK ACKNOWLEDGEMENT.....	9
1.7 DISCLAIMER.....	9
<b>CHAPTER 2: GETTING STARTED</b> .....	<b>10</b>
2.1 UNPACKING.....	11
2.2 DESCRIPTION OF PARTS.....	13
2.3 HOT KEYS FOR SPECIFIC FUNCTIONS.....	15
2.4 LED INDICATORS.....	15
2.4 FIRST-TIME OPERATION.....	16
2.4.1 <i>Installing Battery</i> .....	16
2.4.2 <i>Charging Your Tablet</i> .....	16
2.4.3 <i>Starting the Tablet</i> .....	17
<b>CHAPTER 3: SETTING UP WINDOWS FOR THE FIRST TIME</b> .....	<b>18</b>
3.1 OS INTRODUCTION.....	19
3.2 SETTING UP WINDOWS 10 IOT ENTERPRISE.....	19
<b>CHAPTER 4: OPERATING THE DEVICE</b> .....	<b>22</b>
4.1 WINSET UTILITY.....	23
4.1.1 <i>System Information</i> .....	23
4.1.2 <i>WinSet Shortcut Setting</i> .....	24
4.2 USING BLUETOOTH.....	25
4.3 USING WI-FI.....	26
4.4 USING WWAN.....	27
4.5 USING BARCODE READER.....	27
4.5.1 <i>Scanning a Barcode</i> .....	27
4.5.2 <i>Barcode Trigger Settings</i> .....	28
4.5.3 <i>Settings</i> .....	29
4.5.4 <i>Setting the 1D/2D Barcode Scanner Symbolologies</i> .....	31
4.6 USING CAMERA.....	33
4.7 USING THE EXPANSION MODULE.....	34
4.7.1 <i>Expansion Module Introduction</i> .....	34
4.7.2 <i>Installing UHF RFID Module</i> .....	35
4.7.3 <i>UHF RFID Trigger Settings</i> .....	36
4.7.4 <i>UHF RFID Settings</i> .....	37
4.7.5 <i>RFID Output Setting</i> .....	39
4.8 REPLACING HOT SWAPPABLE BATTERY.....	39
4.9 DOCKING CONNECTOR PIN DEFINITION.....	40
4.10 EXPANSION PORT PIN DEFINITION.....	40
4.11 COM PORT DEFINITION.....	41
4.12 ADJUSTING LED BRIGHTNESS.....	44
<b>CHAPTER 5: FREQUENTLY USED SETTINGS</b> .....	<b>48</b>
5.1 SCREEN RESOLUTION SCALING AND SETTING.....	49
5.1.1 <i>Changing Display Scaling Setting (Recommended)</i> .....	49
5.1.2 <i>Changing Resolution</i> .....	50
5.2 PAIRING WITH A WIRELESS BLUETOOTH BARCODE SCANNER WITH BLUETOOTH SERIAL PORT PROFILE.....	52
5.2.1 <i>Setup Computer for Bluetooth Pairing</i> .....	52
5.2.2 <i>Set up the Barcode Scanner for Bluetooth Pairing</i> .....	55
5.2.3 <i>Bluetooth Pairing</i> .....	55
5.3 USING RECOVERY WIZARD TO RESTORE COMPUTER.....	57
<b>APPENDIX</b> .....	<b>59</b>
APPENDIX A: TROUBLESHOOTING.....	60

APPENDIX B: TECHNICAL SPECIFICATION ..... 62  
APPENDIX C: ORDER INFORMATION..... 64

## **Chapter 1: Read Me First**

This chapter contains important information and general safety instructions. Follow and adhere to all warnings and instructions in this manual. For your safety, please read all safety and operating instructions before using the product. Keep this manual for future reference.

---

## 1.1 Advisory Conventions

Four types of advisories are used throughout the user manual to provide helpful information or to alert you to the potential for hardware damage or personal injury. These are Notes, Important, Cautions, and Warnings. The following is an example of each type of advisory.

**Note:**

A note is used to emphasize helpful information

**Important:**

An important note indicates information that is important for you to know.

**Caution/ Attention**

A Caution alert indicates potential damage to hardware and explains how to avoid the potential problem.

Une alerte d'attention indique un dommage possible à l'équipement et explique comment éviter le problème potentiel.

**Warning! Avertissement!**

An Electrical Shock Warning indicates the potential harm from electrical hazards and how to avoid the potential problem.

Un Avertissement de Choc Électrique indique le potentiel de choc sur des emplacements électriques et comment éviter ces problèmes.

## 1.2 Declaration of Conformity

### FCC Statement



This device complies with part FCC Part 2. 1092 rules.

Operation is subject to the following two conditions:

- This device may not cause harmful interference.
- This device must accept any interference received including interference that may cause undesired operation

This equipment has been tested and found to comply with the limits for a class "B" digital device, pursuant FCC Part 2. 1092. These limits are designed to provide reasonable protection against harmful interference when the equipment is operated in a commercial environment. This equipment generates, uses, and can radiate radio frequency energy and, if not installed and used in accordance with the instruction manual, may cause harmful interference to radio communications. Operation of this equipment in a residential area is likely to cause harmful interference in which case the user will be required to correct the interference at his own expense.

### CE Notice (European Union)



Electromagnetic Compatibility Directive (2014/30/EU)

- EN55024: 2010/ A1: 2015
  - IEC61000-4-2: 2009
  - IEC61000-4-3: 2006+A1: 2007+A2: 2010
  - IEC61000-4-4: 2012
  - IEC61000-4-5: 2014
  - IEC61000-4-6: 2014
  - IEC61000-4-8: 2010
  - IEC61000-4-11: 2004
- EN55032: 2012/AC:2013
- EN61000-3-2:2014
- EN61000-3-3:2013

Low Voltage Directive (2014/35/EU)

- EN 60950-1:2006/A11:2009/A1:2010/A12:2011/ A2:2013

This equipment is in conformity with the requirement of the following EU legislations and harmonized standards. Product also complies with the Council direct.

## 1.3 Safety Information



### Precaution on Battery Pack *Précaution avec le bloc-pile*

Do Not Expose the Battery Pack to Excessive Heat, or Extreme Heat (Near Fire, in Direct Sunlight for example)

Generation of heat, ignition or rupture may result

*Ne pas exposer le bloc-pile à une Chaleur Excessive, ou une Chaleur Extrême (Près d'un feu, sous la lumière du soleil par exemple) Une production de chaleur, l'amorçage ou la rupture peuvent être occasionnés*

Do Not Disassemble, Modify, or Insert Sharp Objects Into the Battery Pack. Electrolyte leakage, generation of heat, ignition or rupture may result.

*Ne pas démonter, modifier, ou insérer des objets pointus à l'intérieur du bloc-pile. Une fuite d'électrolyte, la génération de chaleur, l'amorçage ou la rupture peuvent être occasionnés.*

Do Not Short the Positive (+) and Negative (-) Terminals of the Battery. Generation of heat, ignition or rupture may result. When carrying or storing the device, do not place the battery pack together with articles that may contact electricity.

*Ne pas court-circuiter les bornes Positive (+) et Négative (-) de la pile, la génération de chaleur, l'amorçage ou la rupture peuvent être occasionnés. Lors du transport et du rangement de l'appareil, ne pas placer le bloc-pile en même temps que des articles pouvant créer un contact électrique.*

Do Not Apply Shocks to the Battery by Dropping It or Applying Strong Pressure to It. Electrolyte leakage, generation of heat, ignition or rupture of battery may occur.

*Ne pas faire subir de choc à la pile en la laissant tomber ou en appliquant une forte pression dessus. Une fuite d'électrolyte, la génération de chaleur, l'amorçage ou la rupture peuvent être occasionnés.*

Do Not Charge the Battery Other Than Methods Those Specified In This Manual. If the battery is not charged using one of the specified methods, electrolyte leakage, generation of heat, ignition or rupture may result.

*Ne pas charger la pile par d'autres méthodes que celles spécifiées dans ce manuel. Si la pile n'est pas chargée en utilisant l'une des méthodes spécifiées, une fuite d'électrolyte, la génération de chaleur, l'amorçage ou la rupture peuvent être occasionnés.*

When the Battery Pack Has Deteriorated, Replace It with a New Battery. Continued use of a damaged battery pack may result in heat generation, ignition or battery rupture.

*Lorsque la pile est détériorée, la remplacer par une nouvelle pile. L'utilisation continue d'une pile endommagée peut occasionner une génération de chaleur, l'amorçage ou la rupture de la pile.*

Do Not Use the Battery Pack With Any Other Products. The battery pack is rechargeable and is only designed for this specific product. If it is used with a product other than the specified product, electrolyte leakage, generation of heat, ignition or rupture may result.

*Ne pas utiliser avec un autre produit La batterie est rechargeable et a été conçue pour un produit spécifique. Si elle est utilisée sur un produit différent de celui pour lequel elle a été conçue, des pertes d'électrolytes et une production de chaleur sont possibles, elle risque également de prendre feu ou de casser.*

Do Not Use This Product With Battery Other Than the One Specified.

*Ne pas utiliser ce produit avec une batterie autre que celle spécifiée*

Discontinue using device immediately if you notice the battery is swelling or looks puffy or misshapen. Do not attempt to charge or use the device. Do not handle a damaged or leaking battery. Do not let leaking battery fluid come into contact with your eyes, skin or clothing.

*Si vous remarquez une pile gonflée, élargie ou anormale, cesser l'utilisation de l'appareil immédiatement. N'essayez pas de recharger l'appareil ou de l'utiliser. Ne pas manipuler une pile qui fuit ou qui est endommagée. Ne laissez pas de liquide qui fuit entrer en contact avec vos yeux, votre peau ou vos vêtements.*



**General Product Safety**  
**Sécurité générale des produits**

This product should not be used near water such as bathtubs, sinks, swimming pools, wet basement, etc.

*Ce produit ne doit pas être utilisé près de l'eau comme les baignoires, les éviers, les piscines, les sous-sols humides, etc.*

Do not block any ventilation openings. Do not place the product against a wall or in an enclosed space as doing so might impede the flow of cooling air.

*Ne pas bloquer les ouvertures de ventilation. Ne pas placer le produit contre un mur ou dans un espace clos de façon à entraver la circulation de l'air de refroidissement.*

Do not place the product near any heat sources such as radiators, warm air intakes, stoves or other heat-generating devices (including amplifiers or other heat producing equipment).

*Ne pas placer le produit près d'une source de chaleur comme des radiateurs, les arrivées d'air chaud, poêles ou autres produits générant de la chaleur (y compris les amplificateurs ou autre équipement produisant de la chaleur.)*

Protect the power cord from being crushed or pinched, particularly in the area of the plugs, any receptacles used, and the point of exit from the apparatus. Do not break off the ground pin of the power cord.

*Empêcher le cordon d'alimentation d'être écrasé ou pincé, en particulier dans les zones de prises, des containers utilisés, et du point de sortie de l'appareil. Ne pas casser la broche de terre du cordon d'alimentation.*

Do not disregard the safety that a polarized or grounded connection can provide. A polarized connection consists of two plugs, one of which is larger than the other. A grounded connection has two blades and a third one that is grounded. If the main plug provided cannot be inserted into your outlet, consult an electrician to replace your obsolete outlet.

*Ne pas ignorer la sécurité qu'une prise polarisée ou une prise de terre peut prévoir. Une prise polarisée se compose de deux fiches, dont l'une est plus large que l'autre. Une prise de terre possède deux lames et une troisième qui est la terre. Si la fiche principale fournie ne peut être insérée dans votre prise, consultez un électricien pour remplacer votre prise obsolète.*

Use only accessories specified by the manufacturer.

*Utiliser uniquement les accessoires spécifiés par le fabricant.*

Use only with its transport carriage, stand, tripod, console or table specified by the manufacturer or sold with the product. When using a carriage, move the carriage assembly with the product carefully to avoid damage from falling over.

*Utiliser uniquement avec son chariot de transport, support, trépied, console ou table spécifiés par le fabricant ou vendu avec le produit. Lors de l'utilisation d'un charriot, déplacez l'ensemble chariot avec le produit avec soin pour éviter tout dommage de chute.*

Unplug this apparatus during lightning storms or when it is not being used for long periods.

*Débrancher cet appareil durant les orages ou lorsqu'il n'est pas utilisé pendant de longues périodes.*

Refer all servicing to qualified service personnel. A technical intervention is required when the apparatus has been damaged in any way, for example if the power cord or plug is damaged, liquid has been spilled or objects have fallen inside the unit, if the product has been exposed to rain or moisture, if it does not operate normally or if it has been dropped.

*Confier toute réparation à du personnel qualifié. Une intervention technique est nécessaire lorsque l'appareil a été endommagé de quelque façon, par exemple si le cordon d'alimentation ou la fiche est endommagé, du liquide a été renversé ou des objets sont tombés à l'intérieur de l'unité, si le produit a été exposé à la pluie ou à l'humidité, s'il ne fonctionne pas normalement ou s'il a été jeté.*



**General Guideline**  
**Directive générale**

It is recommended to reboot the device when some functions are defect or inactive. If it still can't solve the problems please contact your dealer or agent.

*Il est recommandé de redémarrer l'appareil lorsque certaines fonctions sont défectueuses ou inactives. Si le problème persiste, veuillez contacter votre revendeur ou votre agent.*



## 1.4 Handling and Maintenance



### General Guideline Guide Général

Keep the product at least 13 cm (5 inches) away from electrical appliances that can generate a strong magnetic field such as TV, refrigerator, motor, or a large audio speaker.  
*Garder le produit au moins à 13 cm (5 pouces) de distance des appareils électriques qui peuvent générer un fort champ magnétique comme une télévision, un réfrigérateur, un moteur, ou un important haut-parleur.*

Do not place heavy objects on top of the tablet computer as this may damage the display.  
*Ne pas placer d'objets lourds sur le dessus de l'ordinateur tablette cela peut endommager l'écran.*

The screen surface can be easily scratched. Use with care. Do not use paper towels to clean the display but use the included cleaning cloth. Avoid touching it with a pen or pencil.  
*La surface de l'écran peut être facilement rayée. Utiliser avec précaution. Ne pas utiliser de serviette en papier pour nettoyer l'écran mais utiliser le chiffon de nettoyage inclus. Éviter de toucher avec un stylo ou un crayon.*

To maximize the life of the backlight in the display, allow backlight to automatically turn off as a result of power management. Avoid using a screen saver or other software that prevents the power management from working.  
*Pour maximiser la durée de vie du rétroéclairage de l'écran, autoriser le rétroéclairage résultant de la gestion de l'alimentation. Éviter d'utiliser un économiseur d'écran ou un autre logiciel empêchant la gestion de l'alimentation de fonctionner.*



### Cleaning Guideline Guide de nettoyage

Use a soft cloth moistened with water or a non-alkaline detergent to wipe the exterior of the product.  
*Utiliser un chiffon doux humidifié avec de l'eau ou un détergeant non alcalin pour essuyer l'extérieur du produit.*

Gently wipe the display with a soft, lint-free cloth. Do not use alcohol or detergent on the product.  
*Essuyer délicatement l'écran avec un chiffon doux non pelucheux. Ne pas utiliser d'alcool ou un détergent sur le produit.*



### Touchscreen Guideline Guide de l'écran tactile

Use your finger or the stylus on the display. Using sharp or metallic object may cause scratches and damage the display, thereby causing errors.  
*Utiliser votre doigt ou le stylet sur l'écran. L'utilisation d'un objet pointu ou métallique peut provoquer des rayures.*

Use a soft cloth to remove dirt on the display. The touchscreen surface has a special protective coating that prevents dirt from sticking to it. Not using a soft cloth may cause damage to the special protective coating on the touchscreen surface. To clean off hard to remove dirt, blow some steam on the particular area and gently wipe away using a soft cloth.  
*Utiliser un chiffon doux pour enlever la poussière sur l'écran. La surface de l'écran tactile a un revêtement protecteur spécial empêchant la saleté de se coller à lui. Ne pas utiliser un chiffon doux peut endommager le revêtement spécial sur la surface de l'écran tactile. Pour nettoyer les saletés plus difficiles à enlever, souffler de la buée sur la zone particulière et essuyer doucement avec un chiffon doux.*

Do not use excessive force on the display. Avoid placing objects on top of the display as this may cause the glass to break.  
*Ne pas utiliser une force excessive sur l'écran. Éviter de placer des objets au dessus de l'écran cela pourrait provoquer une cassure du verre.*

When there is a noticeable discrepancy in the operation of the touchscreen function (your touch does not correlate to the proper location on the screen), recalibrate the touchscreen display.  
*Lorsqu'il y a un écart sensible dans le fonctionnement de l'écran tactile (votre contact ne correspond pas à la bonne position sur l'écran), recalibrer l'écran tactile.*

## **1.5 Copyright Notice**

No part of this document may be reproduced, copied, translated, or transmitted in any form or by any means, electronic or mechanical, for any purpose, without the prior written permission of the original manufacturer.

## **1.6 Trademark Acknowledgement**

Brand and product names are trademarks or registered trademarks of their respective owners.

## **1.7 Disclaimer**

Winmate Inc. reserve the right to make changes, without notice, to any product, including circuits and/or software described or contained in this manual in order to improve design and/or performance. We assume no responsibility or liability for the use of the described product(s) conveys no license or title under any patent, copyright, or masks work rights to these products, and make no representations or warranties that these products are free from patent, copyright, or mask work right infringement, unless otherwise specified. Applications that are described in this manual are for illustration purposes only. We make no representation or guarantee that such application will be suitable for the specified use without further testing or modification.

## Chapter 2: Getting Started

This chapter tells you step by step how to get the Tablet Computer up and running. You will find instructions for the following procedures:

- Unpacking
  - Description of Parts
  - First Time Operations
  - Powering On/Off
-

## 2.1 Unpacking

Thank you for purchasing the M101BK Rugged Windows Tablet Computer. The rugged design allows you to use it in harsh outdoor environments.

Check and identify the supplied accessories:



- **Tablet Computer**



- **User Guide**



- **Standard Battery BS101**  
Part No. 98K000A000AC

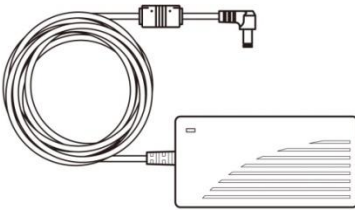

- **AC Adapter**  
Part No. 922D065W19V1

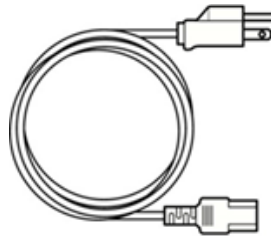

- **Power Cord and Plugs**

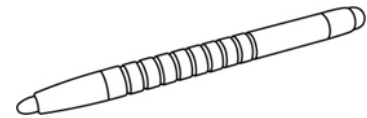

- **Capacitive Touch Stylus**  
Part No. 9B0000000415

Your package may include other optional accessories based on your order.

### High Capacity Battery

- Capacity: 7.4V min. 10280 mAh, (2S2P) typ.  
Li-Polymer Battery

**Part No. 98K000A000AH**

### Mobile Printer MX30

- For Windows Tablet PC
- Easy setup and convenient connectivity

**Part No. 9B000000007A**

### Carry Bag

- Protects tablet PC from scratches
- Fast access design
- Adjustable shoulder strap

**Part No. 9B000000003J**

### Vehicle Docking

- VESA Mounting support
- USB 2.0 x 4 (Rear x2, Bottom x2)
- LAN (10/100) / RS232
- GPS ANT SMA x 1

**Part No. 98D000A0000R**

### Hand Strap

- Fixed with screws
- Adjustable for both battery sizes

**Part No. 98K000A0003J**

### LAN Cable

- For LAN from 30 pin extension port
- Length:10cm
- RJ45, female
- Gigabit Ethernet

**Part No. 94I0080300K1**

### Vehicle Charger

- 11~32V DC IN
- 19V/ 3.42A DC OUT

**Part No. 9226065W19V0**

### Smart Card Reader

- Compliant to ISO 7816 part 1,2 and 3
- Support ISO 7816 T=0, T=1 smart card
- LED Indicator for Card Reader status
- Easy to install and operate
- Dimensions: 107.97 x 80.39 x 12.40 mm

**Part No. 98K000A0003U**

### VESA Mount Kit

**Part No. 98KT00A0001H**

### Shoulder Strap SS-M101

- Fixed with screws
- Adjustable cross-body strap (85-165cm) with pad
- Weight: 67g

**Part No. 98K000A0003Q**

### Battery Charger BC-M101

- 6-pack
- Dual-bay charging dock
- Power level LED indicators
- Buzzer to indicate battery is inserted
- Supports up to 3 set of dock interconnected

**Part No. 98KT00A0000F**

### Desk Docking

- USB 2.0 x 4 (Rear x2, Side x2)
- LAN (10/100) / VGA / RS232
- 12-19V DC IN

**Part No. 98DT00A0000E**

### UHF RFID Reader

- With ThingMagic M6e-Micro module
- Support 865-868 MHz and 902-928 MHz
- Power trans. up to +30 dBm (1 Watt)
- Read-Range 3+ Meters

**Part No. 98K000A0004J**

### Micro HDMI Cable

- Micro HDMI (Male) to HDMI (Male)
- Length: 1.8M

**Part No. 9491191190K1**

### RS232 Cable

- For RS232 from 30 pin extension port
- Length:10 cm
- DB9 Serial RS232 Cable, female

**Part No. 94G3090300K0**

### Vehicle Cradle VC-M101BK

- Keeps the tablet securely fastened on moving vehicles
- Anti-theft design with key lockable cradle
- Wide power voltage input (9~36V DC-in)
- IP52 design (Rain proof)
- VESA standard for various standard fixtures

**Part No. 98DT00A0000Z**

## 2.2 Description of Parts

Front:

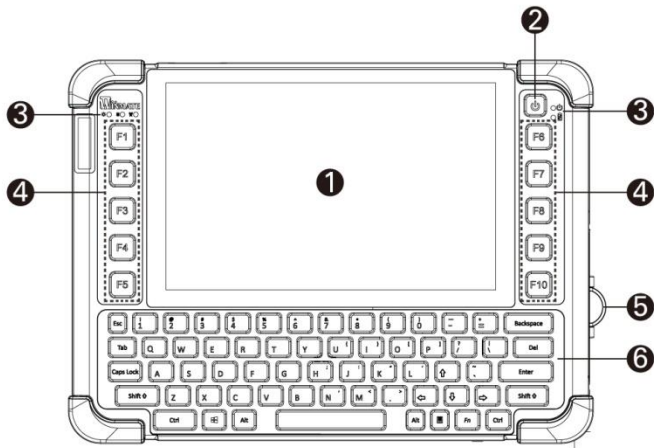

Right:

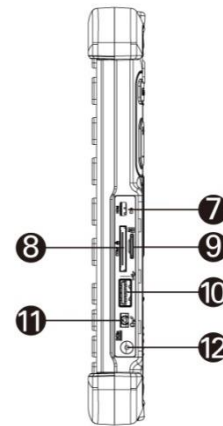

No	Item	Description
1	Touch Screen	Displays and acts as one of the inputs for the computer.
2	Power Button	Power on/off computer.
3	LED Indicators:	Shows the current status of the computer.
4	Function Buttons	Programmable function keys configured by Winset utility.
5	I/O Cover	Protects I/O ports.
6	QWERTY Keypad	Input characters using the QWERTY keypad.

No	Item	Description
7	Micro HDMI	HDMI output to external display.
8	LAN/RS232	Adapter port for LAN/RS232 connector.
9	MicroSD Card Reader	Memory card reader port for MicroSD Card
10	USB 3.0	High speed USB port connects to USB devices, such as USB flash drive, mouse, keyboard, printer, etc.
11	Mic In/Line Out	Headset or headphone can be connected (Mic is only supported with 3.5mm 4-pin headset).
12	Power Jack	DC-IN power input jack.

### Front LED Indicators Details:

Left side



Right side

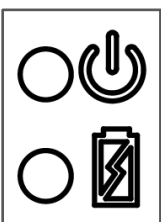

## Rear:

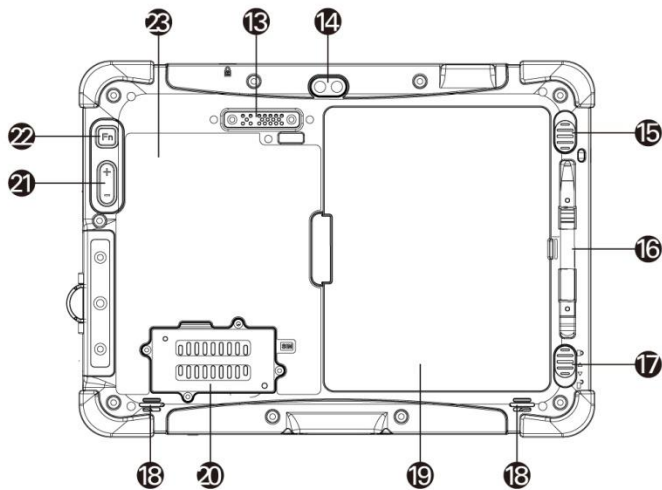

No	Item	Description
13	Expansion Port	Provide optional connectivity to custom modules for special application (USB2.0 x 1, RS232 x 1).
14	Rear Camera	5MP Autofocus Camera. Captures photos and videos.
15	Battery Release Slider	Spring-loaded slider that latches the battery in.
16	Touch Pen Slot	Pen holder slot to store touch pen.
17	Battery Lock Latch	Latch to lock the battery in place once battery is inserted. Not spring-loaded.
18	Speakers	Emit sounds.
19	Battery	7.4V, typ. 5140 mAh Li-Polymer Battery (2S1P). 7.4V, typ. 10280 mAh Li-Polymer Battery (2S2P, optional).
20	LTE Module / SIM card slot	Service window to insert Micro SIM card. Also provide access to LTE Module.
21	Volume Buttons	Volume Control. (+) Raise volume, (-) Lower volume.
22	Fn2 Button	Toggles Barcode Scanner
23	Optional HF RFID Reader	Scans HF RFID tags.

## Top:



## Bottom:

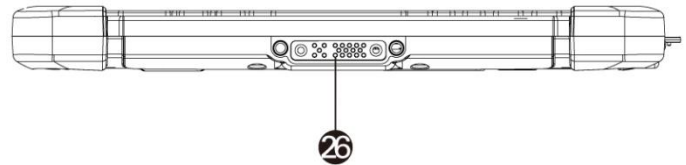

No	Item	Description
24	Optional Barcode Reader	Barcode Scanner for reading of 1D/2D barcode.
25	Kensington Lock Port	Provides lock access for Kensington Lock.
26	Docking Connector	Port to docking solutions such as vehicle docking to provide power and external antenna

## 2.3 Hot Keys for Specific Functions

For the physical buttons on the tablet computer, in addition to its dedicated functions detailed in the previous section, it can also be used to emulate commonly used keyboard key strokes. Under different scenario, a single physical button or a combination of physical buttons provide different keyboard key strokes, which are specified below:





### In POST (before Windows boots up):

Buttons	Keystroke
F7	Enters BIOS Setup Screen.
Fn2	ESC
Volume Up (+)	Up
Volume Down (-)	Down

### In Windows:

Buttons	Keystroke
Fn + F1	Opens Winset application
Fn + F4	RF Power (Wifi/BT/WWAN/GPS Ant.)
Fn + F5	Camera(Call Winset Cam)
Fn + F7	Zoom +
Fn + F8	Zoom -
Fn + F10	Increase size of on-screen keyboard
Volume Up (+)	Brightness or Volume (Default Brightness)
Volume Down (-)	Brightness or Volume (Default Brightness)
Fn2	Default: Barcode Scan (Configurable)

## 2.4 LED Indicators

Item	Description
Power Indicator	 <b>Blue</b> – Tablet is ON <b>No light</b> – Tablet is OFF
Battery Status	 <b>Orange</b> –AC adapter is plugged in and charging <b>Green</b> –AC adapter is plugged in and battery is full charged <b>Solid Red</b> - Low battery (<10%) <b>Blinking Red</b> – Battery is being hot swapped. <b>No light</b> – Battery is in use and more than 10%
Light Sensor	 Light sensor automatically adjusts the panel brightness based on the light settings.
Disk Activity Indicator	 Green - Disk Activity No light - Disk Idling
RF Communications	 Green - WiFi/BT/WWAN/GPS ON No light - WiFi/BT/WWAN/GPS are all OFF



## 2.4 First-Time Operation

To get started:

1. Install the battery.
2. Charge your tablet.
3. Start the tablet.

### 2.4.1 Installing Battery

*To install the battery pack:*

1. Disconnect any cords connected to the tablet computer.
2. Turn the tablet over, back facing up.
3. Locate the Battery Lock Latch and push it to the “Unlocked” position.
4. Locate the Battery Release Slider that is spring-loaded. Pull back and hold.
5. Insert the battery with the connector-pins side first, and then lower the battery into the battery compartment. Continue to hold the Battery Release Slider until the battery is fully inserted.
6. Make sure the battery is completely lowered into the compartment before letting go of the Battery Release Slider. Battery will be flat against the housing once fully inserted.

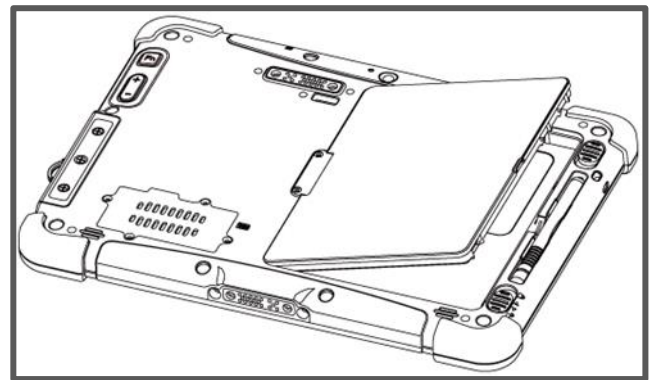
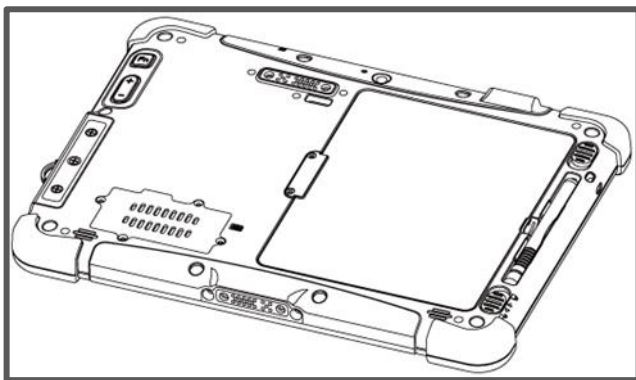

*To remove the battery pack:*

1. Shut down the tablet (or put into sleep mode). Disconnect any cords connected to the computer.
2. Turn the tablet computer over, back facing up.
3. Locate the Battery Lock Latch and push it to the “Unlocked” position.
4. Locate the Battery Release Slider that is spring-loaded. Pull back and hold.
5. Lift the battery out using the opening on the side of battery compartment.

### 2.4.2 Charging Your Tablet

The Tablet operates either on external AC power or internal battery power. It is recommended to use AC power when you start up the Tablet for the first time.



**Caution:** Use only the AC adapter included with your Tablet Computer. Using other AC adapters may damage the Tablet Computer and the Battery.

*To connect a tablet to AC power:*

1. Open I/O protective cover by pulling out the latch.
2. Plug the DC cord of the AC adapter into the power jack of the tablet computer.
3. Plug the AC power cord into the AC adapter.
4. Plug the AC power cord into the electrical outlet.

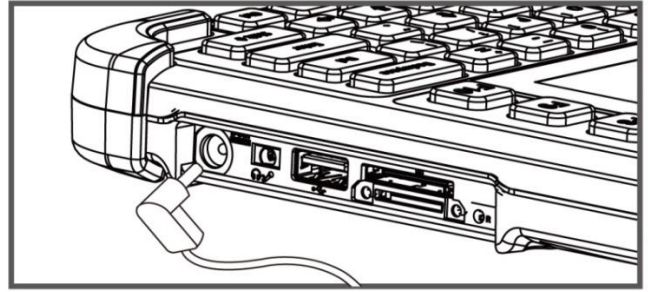
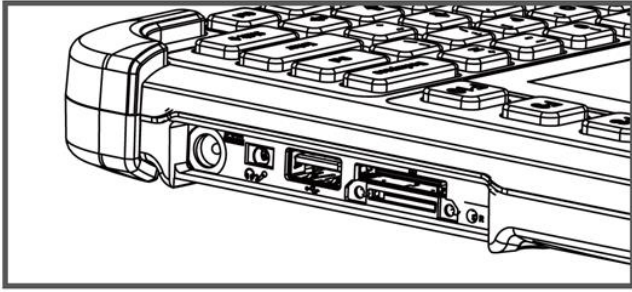

The battery LED indicator shows different battery states:

**Orange** - AC adapter is plugged in and battery is charging.

**Green** - AC adapter is plugged in and battery is fully charged.

**Solid Red** - Low battery level (<10%).

**No light** – Battery is in use and charged (>10%).

Item	Hours
<b>Battery Life</b>	
<b>Standard Battery (BS101)</b>	6 Hours
<b>High Capacity Battery (BL101)</b>	12 Hours

Item	Hours
<b>Battery Charging Time</b>	
<b>Standard Battery (BS101)</b>	2.5 Hours
<b>High Capacity Battery (BL101)</b>	4.5 Hours

### 2.4.3 Starting the Tablet



**Important:** When powering on the device for the first time, please make sure there's no interruption during the Windows setting up process, for example, accidentally powering off. If it happened, please access the recovery menu by pressing **F6** button on the front bezel to initiate recovery process.

Press and hold the power button for **3 seconds** until the blue LED power indicator light up.



**Note:** Do not press the power button repeatedly.

Do not perform the following operations until the Disk Activity Indicator off

- Connecting or disconnecting the AC adapter
- Pressing the power button
- Touching the tablet buttons, screen, or external keyboard/mouse

To power off the Tablet Computer:

1. Make sure you have closed any programs that are open on the Desktop. Start Screen apps don't need to be closed.
2. Tap on the **Settings** charm.
3. Tap on **Power**.
4. Tap on **Shut Down**.
5. Wait for Tablet Computer to power off.



**Note:** The computer will forcibly be powered off if the power button is pressed and held for **6 seconds or longer**.

## **Chapter 3: Setting Up Windows for the First Time**

This chapter details how to setup the Windows that may be installed on the tablet for the first time.

---

## 3.1 OS Introduction

The M101BK Tablet Computer operates on Windows 10 IoT Enterprise operating system.



**Caution:** Make sure the battery is full charged before starting the Tablet Computer for the first time with internal battery power.

- **Public network:** Select this location if you do not recognize all the computers on the network. (For example, you are in a coffee shop or airport, or you have mobile broadband.) This is a public network and is *not* trusted. Select the location where you will most often use the computer.

## 3.2 Setting up Windows 10 IoT Enterprise

Follow the steps below to complete the Windows 10 IoT Enterprise setup process.

1. Press the power button to turn on the computer.
2. First, select your country/region, your preferred app language, your preferred keyboard layout, and your time zone, then tap **Next**.

Hi there

Let's get a few basic things out of the way.

What's your home country/region?

United States

What's your preferred app language?

English (United States)

What keyboard layout would you like to use?

US

What time zone are you in?

(UTC-08:00) Pacific Time (US & Canada)

Next

3. On the **Here's the legal stuff** screen, read through the disclosures, then tap **Accept**.

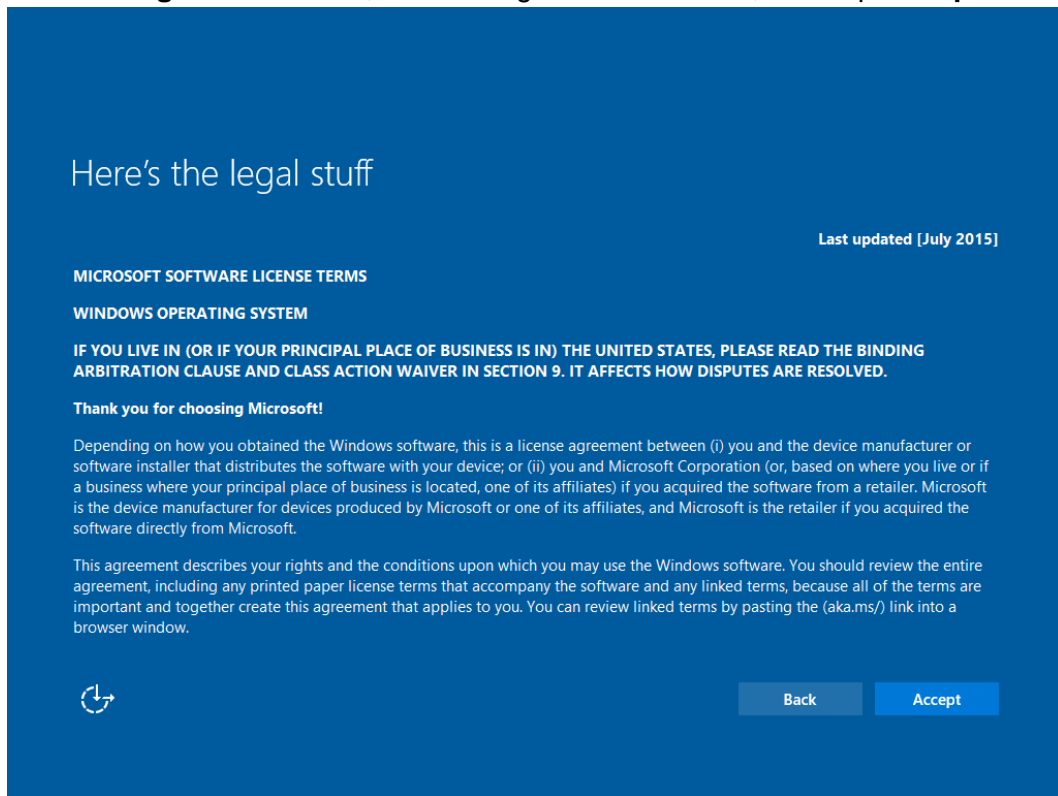

4. Windows will then try to connect to network. Tap **Skip this step** to continue without a wireless connection as you can then set up the network later.
5. On the **Get going fast** screen, click **Use Express settings** for the fastest setup. If you would like more information, tap **Learn more**, or if you would like to select your own options, click **Customize settings**.

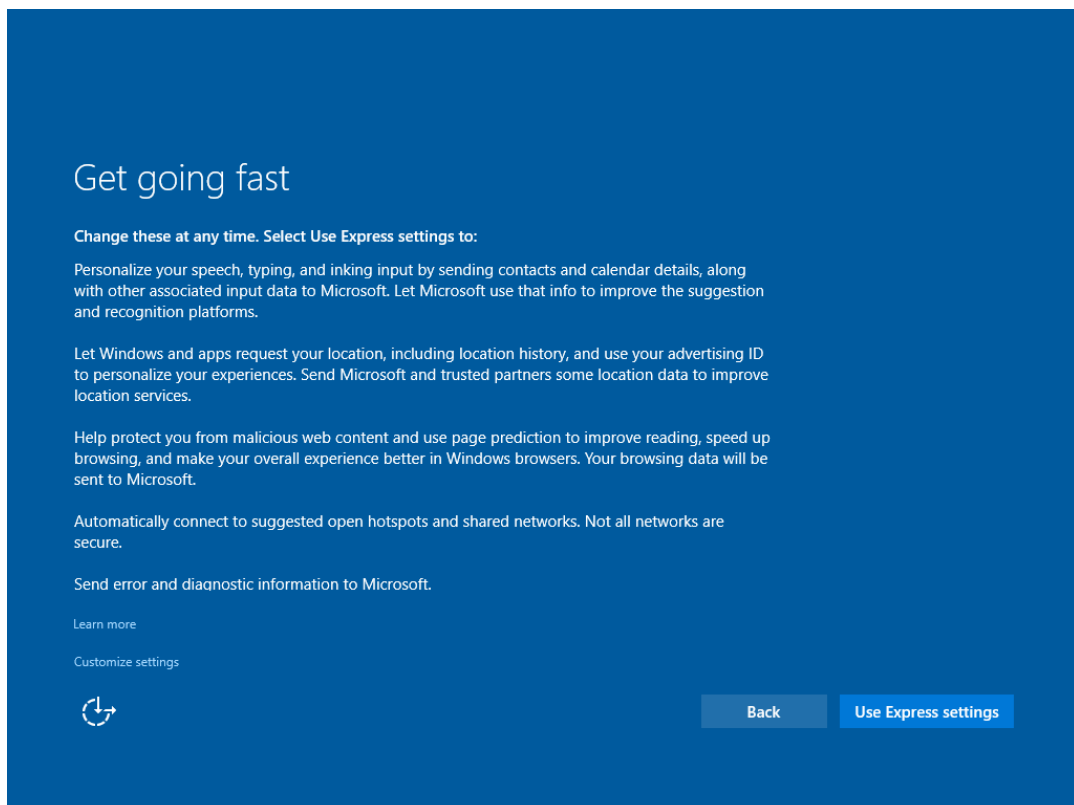

- To create a local account, type your User name, password, and Password hint in the fields provided, then tap **Next**.

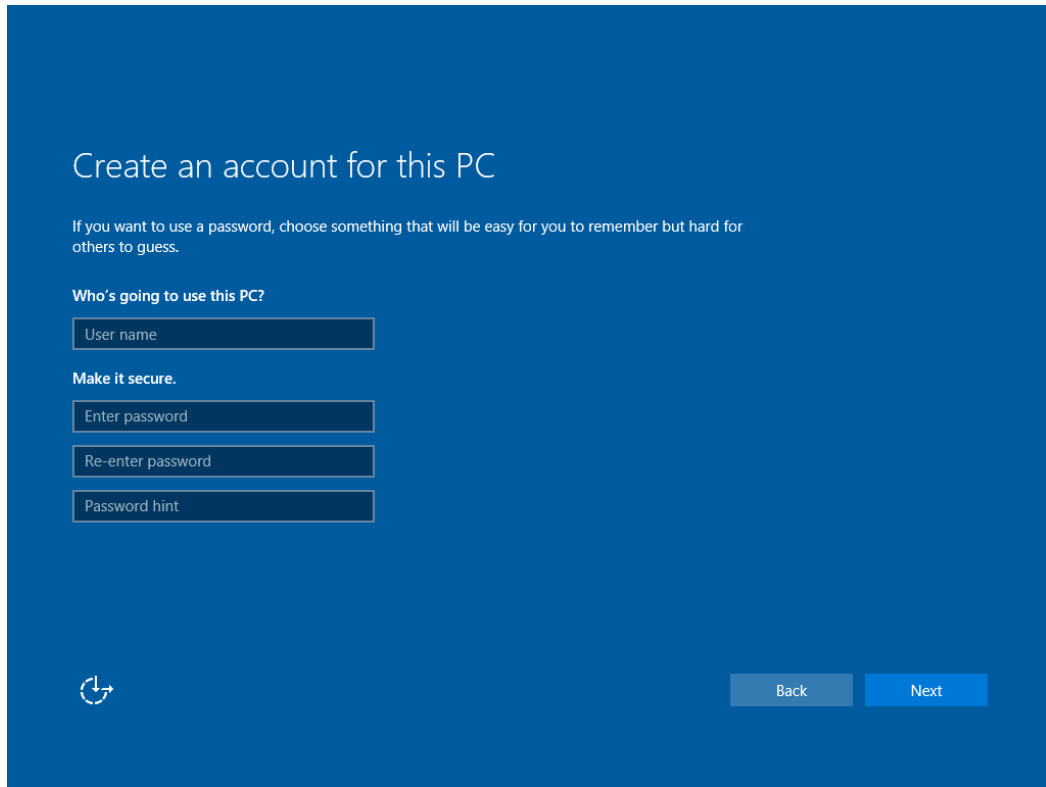

The screenshot shows a blue background with white text. At the top, it says "Create an account for this PC". Below that, a smaller line of text reads: "If you want to use a password, choose something that will be easy for you to remember but hard for others to guess." Underneath, the heading "Who's going to use this PC?" is followed by a text input field labeled "User name". Below this, the heading "Make it secure." is followed by three text input fields: "Enter password", "Re-enter password", and "Password hint". At the bottom left, there is a circular arrow icon. At the bottom right, there are two buttons: "Back" and "Next".

- The initial setup screens are complete, and the desktop is displayed.
- Read any introductory screens describing features of your computer, and tap **Next** upon completing each. You are now done with the initial setup process.



## **Chapter 4: Operating the Device**





This chapter tells you to operate the tablet, describes WinSet utility and tells you how to use Bluetooth, Wi-Fi, WWAN, Barcode Reader, and Camera.

---

## 4.1 Winset Utility

Winset® is a program to control the main functions of the M101BK. In Winset®, users can check system information, control function button settings, and configure blanking function, scanner wedge and settings.

Long-press **Fn**  + **F1** function key to open Winset®. You can open Winset® by double-clicking on the Winset icon  on the desktop.

The Fn key     is located on the bottom right of the keypad

### 4.1.1 System Information

System information menu displays main information about this computer.

System Information	Function Buttons	Device Control	Exit
<b>PC Information</b>			
BIOS Version	009		
EC Version	009		
Win-Set Version	4.1.4		
OS Version	95Z0000002C4_180601		
Serial Number	1W1860005105		
Model Name	M101BK for IEC		
Battery Health	Good		
<input checked="" type="checkbox"/> Check for update	Your software is up to date.		



## 4.1.2 WinSet Shortcut Setting

Long-press **Fn**  + **F1** function key to open Winset. In Function Buttons, submenu users can set up functions of the function keys F1~F10.

System Information		Function Buttons		Device Control		Exit	
<b>Short Press</b> 1Sec. RESET							
F1	Empty	NEW	DEL	F6	Empty	NEW	DEL
F2	Empty	NEW	DEL	F7	Empty	NEW	DEL
F3	Empty	NEW	DEL	F8	Empty	NEW	DEL
F4	Empty	NEW	DEL	F9	Empty	NEW	DEL
F5	Empty	NEW	DEL	F10	Empty	NEW	DEL
Fn1	Empty	NEW	DEL	<b>Arrow Keys</b> <input checked="" type="radio"/> Brightness <input type="radio"/> Volume			

Press the  button next to F1; user will see the window show up just like the below picture. Then choose a program to be opened by just pressing F1 next ti

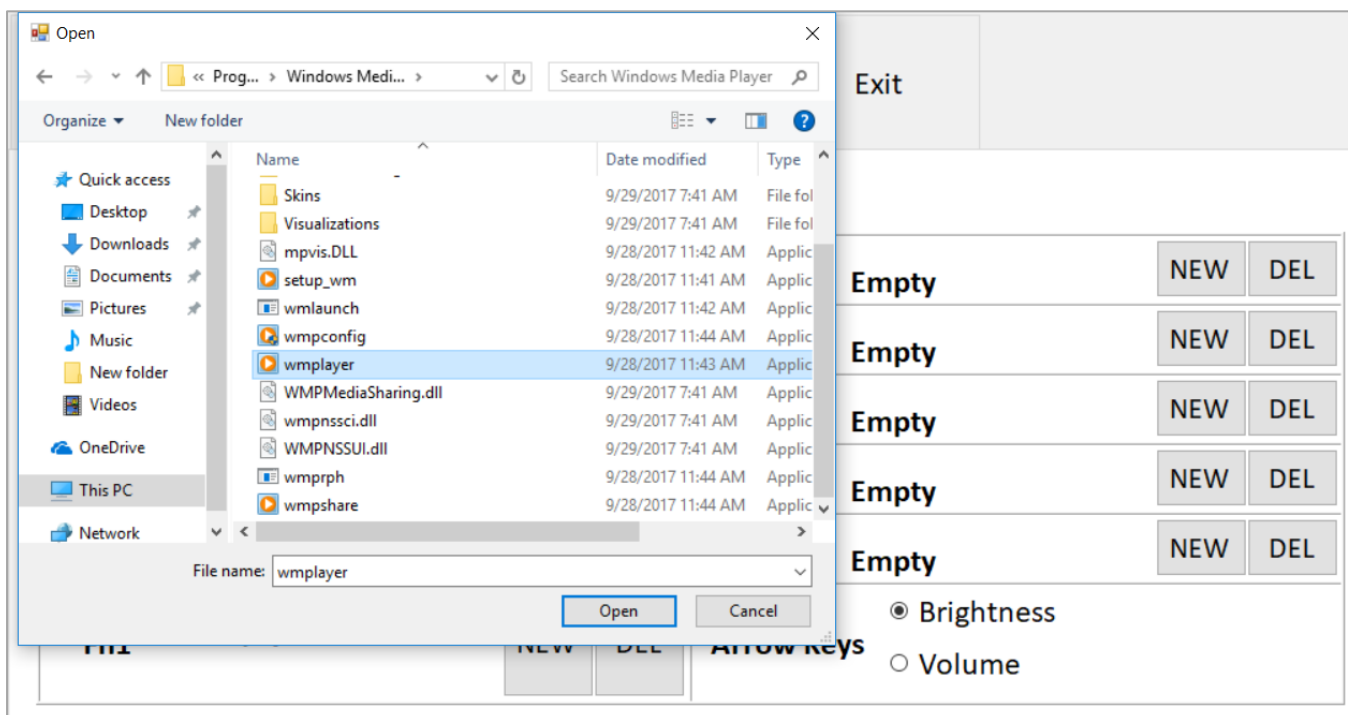

## 4.2 Using Bluetooth

Your device has integrated Bluetooth capabilities for short-range wireless communication between Bluetooth-enabled devices. You can transfer files, playback audio, configure virtual serial ports, and share network connection via Bluetooth.

By default, the Bluetooth feature is enabled as indicated by the Bluetooth icon on the taskbar.

*To Enable the Wireless Bluetooth:*

1. Click the Bluetooth icon in the windows notification area, a contextual menu for Bluetooth is displayed.
2. To add a device, tap on Add a Bluetooth Device, Windows will search any Bluetooth device automatically.
3. Choose the Bluetooth device that user wants to connect and follow onscreen prompt to continue the pair procedure and use the Bluetooth device.

*Opening My Bluetooth:*

1. In the notification area in the Taskbar, click to open the Action Center button.
2. From the Quick actions area, tap the **Add a Bluetooth Devices**.



3. Then all the enabled devices will appear in the list; click on the device, and it should pair automatically.

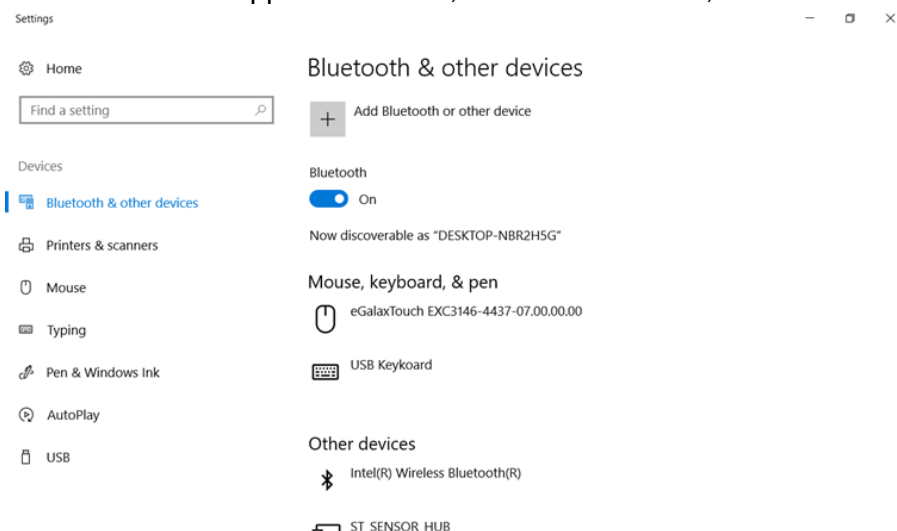

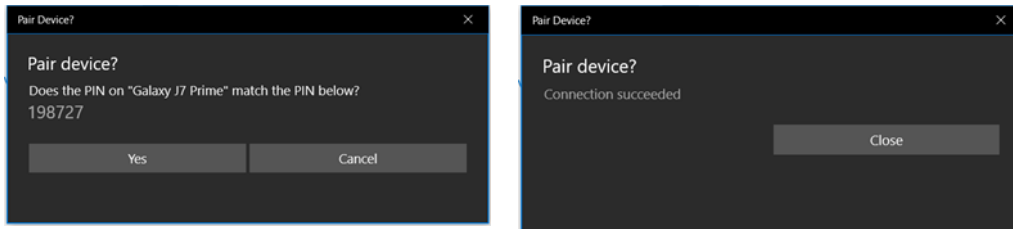



### 4.3 Using Wi-Fi

By default, the wireless antenna is turned on.

*To turn on the wireless antenna:*

1. Click the wireless network connection status icon in the Windows notification area. A list of available wireless networks is displayed.
2. Double-click a network to connect to it. Provide required authentication information if needed.
3. To check the connection status, observe wireless network connection status icon in the Windows notification area. The more bars the icon shows, the better the wireless LAN connection strength is.
4. Now wireless LAN connection is setup, try connection to the network with an internet browser such as Internet Explorer.

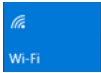
*Perform the following to connect to a wireless network:*

1. Make sure that the wireless power is “on” (The Wi-Fi LED indicator is green and the Wireless network icon on the taskbar shows).
2. Tap the Wireless Network icon .
3. In the list of available networks, tap a Wi-Fi network .
4. Tap Connect.
5. If the network requires authentication, enter the security key or passphrase.



Personal information and files on your wireless network can sometimes be seen by people who pick up your network signal. This can lead to identity theft and other malicious acts. A network security key or passphrase can help protect your wireless network from this type of unauthorized access.

## 4.4 Using WWAN

The M101BK supports data connection with LTE modules and supports Micro-SIM cards. (Note: LTE feature is optional).

To enable WWAN:

1. Please insert the Micro-SIM card into your Tablet Computer.
2. Check the wireless WAN connection status through the Cellular status icon  in Windows notification area. The more bars encompassed, the better the signal is.
3. Click on the network title to see more details about the connection settings.

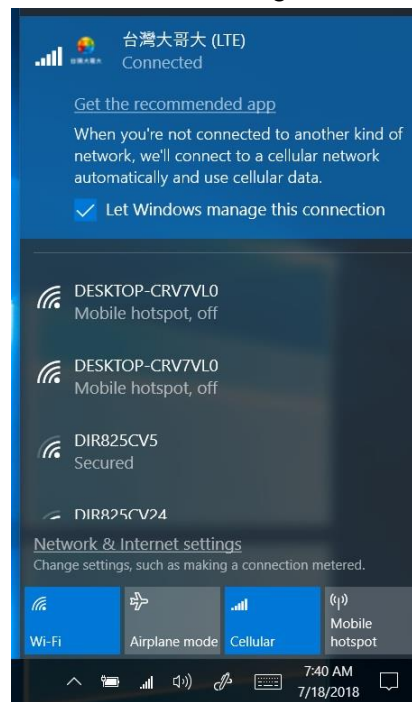
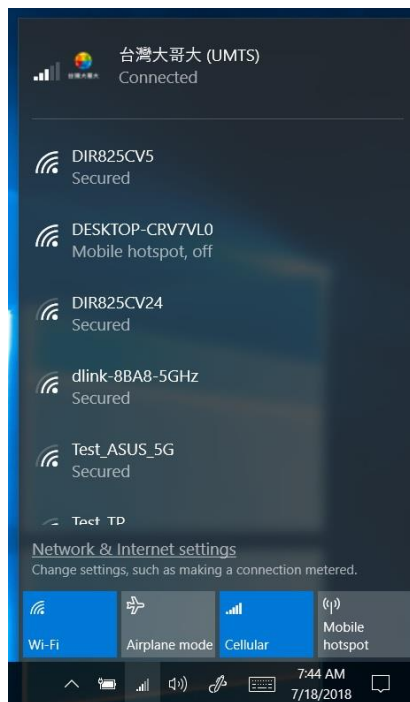

## 4.5 Using Barcode Reader

Notice that Barcode Reader is an optional feature for M101BK Tablet and may not be present in your device.

### 4.5.1 Scanning a Barcode

To enable the Barcode Reader:

1. Long-press **Fn**  + **F1** function key to open Winset. Users also can open Winset ® by double-clicking on the Winset icon on the desktop
2. Click on the Device Control tab under the Winset utility and open the Barcode Scanner Wedge Settings.

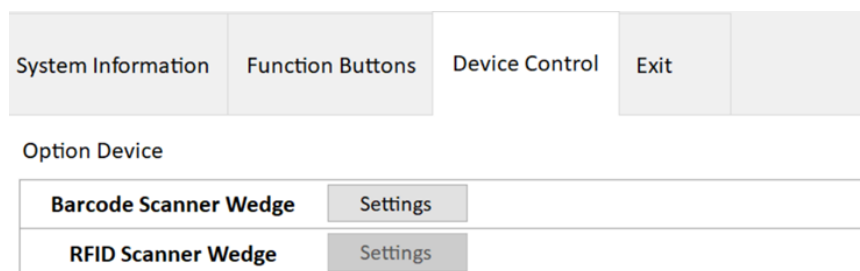

3. Choose "Device ON/OFF" and click on "Barcode", and the setting utility will show up as below:

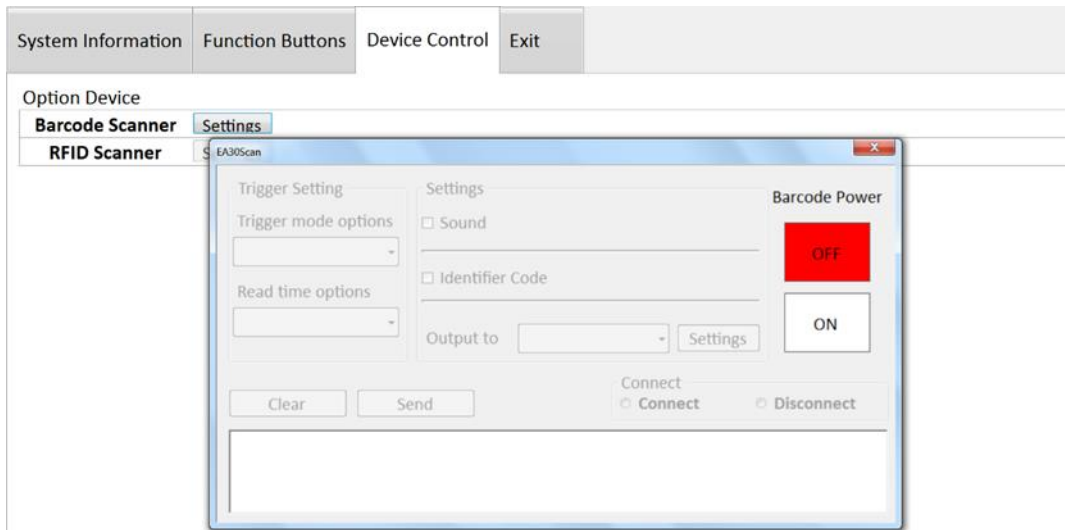

4. Tap on the **ON** button.

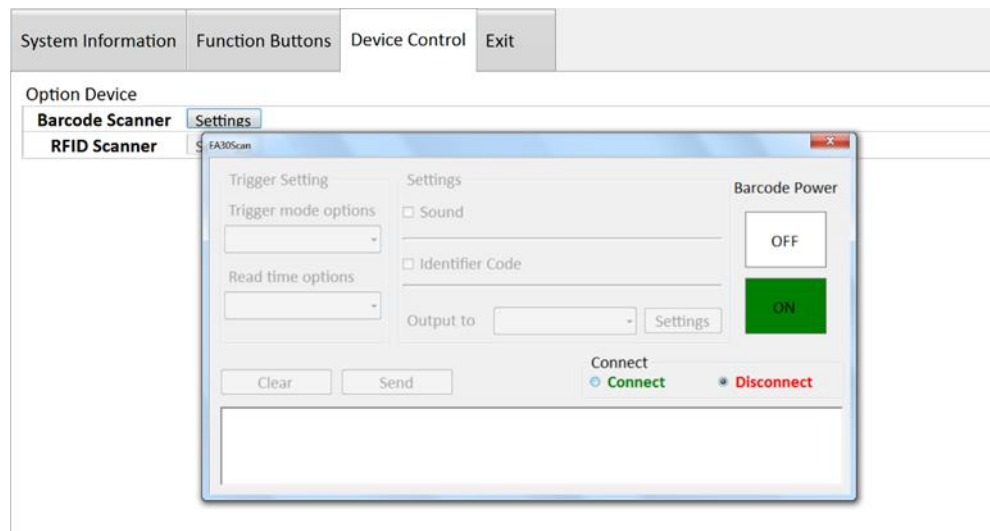

5. Open the application where barcode reader will be displaying the scanned barcode. Trigger the barcode reader by pressing **Fn2** function key on the back of M101BK.

## 4.5.2 Barcode Trigger Settings

You can define the barcode scanner trigger mode from Trigger mode options drop-down menu shown as below.

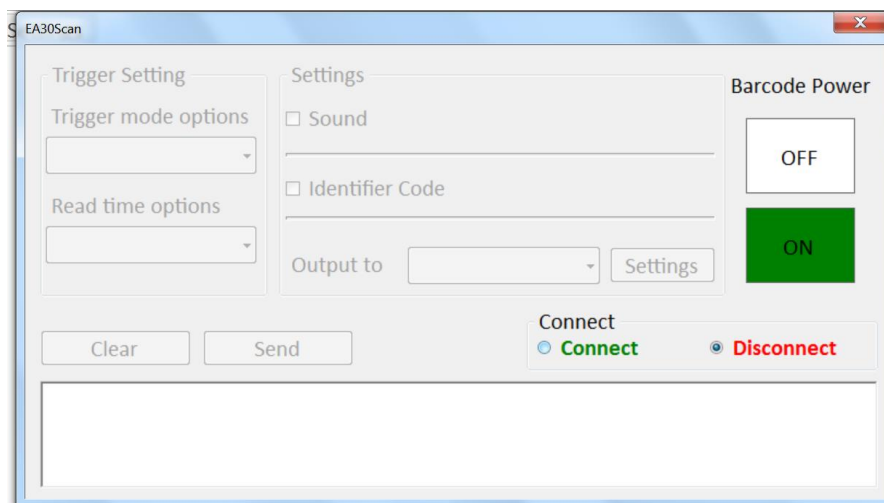

Item	Description
<b>Continuous</b>	In Continuous mode, the barcode scanner processes auto-scan continuously. The scanning light and pattern will be always on.
<b>Level</b>	In Level mode, the barcode scanner follows trigger button behavior. The scanning light will be on when the Fn2 button is triggered, and off when the barcode is successfully read or the Fn2 button is released.
<b>Pulse</b>	In Pulse mode, you can define the scanning time after each trigger. The scanning light will be on when the Fn2 button is triggered, and off when the barcode is successfully read or the defined read time ends. To set up the scanning time, tap on the Read time options drop-down menu and choose a preferred time frame (options from 1 second to 9 seconds).
<b>Flashing</b>	In Flashing mode, the scanning light is flashing, and the barcode scanner processes auto-scan with the same frequency.

### 4.5.3 Settings

Item	Description
<b>Sound</b>	The <b>Sound</b> check box defines whether a beep sound will come with the data scan.
<b>Identifier Code</b>	The <b>Identifier Code</b> check box defines whether to filter Application Identifiers from the scanned data. Some barcode types, such as EAN-128, use Application Identifiers to include additional data. User can disable <b>Identifier Code</b> check box to ignore specific characters.
<b>Output to</b>	<p>This setting defines the output type of the scanned data. Here are the options available:</p>  <p><b>Keyboard Wedge</b></p> <p>Under this setting, the data scanned is sent like keyboard data. The scanned data can be output directly to the demo area below this window, or user can also open other utility, such as Office Word or Notepad files, for data input.</p> <p><b>Note:</b> notice that the input method should support the scanned character.</p> <p><b>SDK</b></p> <p>For users following SDK for software porting, the scanned data can also be output with the format needed.</p> <p><b>Note:</b></p> <p>User can download the SDK from Winmate Download center webs &gt;&gt; M101BK&gt;&gt; Development Kit or check the Driver CD which shipped with the tablet. <a href="http://www.winmate.com/DownCenter/DownLoadCenter.asp?DowYContent">http://www.winmate.com/DownCenter/DownLoadCenter.asp?DowYContent</a></p> <p><b>Virtual COM</b></p> <p>User can also choose Virtual COM to transfer scanned data to the defined COM port.</p>
<b>Disconnect</b>	User can tap on the <b>Disconnect</b> button to stop the connection with Barcode Reader. <i>To recover the connection, please tap on the button again to re-connect with Barcode Reader.</i>

### More Settings

Tap on the **Settings** button for further details settings.

The screenshot shows the 'Keyboard Wedge Configuration' dialog box. It contains the following elements:

- Prefix**: A text input field.
- Suffix**: A text input field.
- Append Enter**: A checkbox.
- Append TAB**: A checkbox.
- Regex Filter**: A text input field with a 'Presets...' button to its right.
- Replace**: A section containing:
  - Regex Substitution**: A text input field.
  - Replace With**: A text input field.
  - A vertical button with a question mark '?'.
- Reset to default**: A button at the bottom left.
- OK**: A button at the bottom center.
- Cancel**: A button at the bottom right.

Item	Description
Prefix	User can type in this field to define the characters BEFORE the data scanned.
Suffix	User can type in this field to define the characters AFTER the data scanned.
Append Enter	The check box user can defines to append an “Enter” which is followed by the characters.
Append TAB	The check box user can defines to append an “TAB” which is followed by the characters.
Regex Filter	<p>Press on “Presets...” button, user can define how many characters to show after the data scanned.</p> <p>The screenshot shows the 'Regular Expression Presets' dialog box with the following options:</p> <ul style="list-style-type: none"> <li><b>All characters</b>: A button labeled 'Use this rule'.</li> <li><b>Keep first</b>: A text input field followed by 'characters' and a button labeled 'Use this rule'.</li> <li><b>Keep last</b>: A text input field followed by 'characters' and a button labeled 'Use this rule'.</li> <li><b>Close</b>: A button at the bottom center.</li> </ul>
Replace	User can define specific characters to be replaced with preferred characters automatically. When the characters defined in <b>Regex Substitution</b> is scanned, the data will be replaced with the one filled in <b>Replace with</b> .
Reset to default	User can remove all the set up and back to default mode.

#### 4.5.4 Setting the 1D/2D Barcode Scanner Symbologies

The barcode scanner is shipped with default settings shown below. If the default setting suits the usage requirement, setting symbologies is not necessary.

	Symbologies	Default Setting
1D	UPC-A	Enable
	UPC-E	Enable
	EAN-8	Enable
	EAN-13	Enable
	UPC-E1	Disable
	GS1 DataBar Omni-Directional	Disable
	GS1 DataBar Limited	Disable
	GS1 DataBar Expanded	Disable
	Code 39	Enable
	Code 128	Enable
	ISBT 128	Disable
	GS1-128	Enable
	Interleaved 2 of 5	Disable
	Matrix 2 of 5	Disable
	Standard 2 of 5	Disable
	Codabar	Disable
	Code 93	Disable
	Code 11	Disable
	MSI	Disable
	Plessey	Disable
	Telepen	Disable
	Australian Post	Disable
	BPO	Disable
	Canada Post	Disable
	Dutch Post	Disable
	Japan Post	Disable
PostNet	Disable	
Sweden Post	Disable	
2D	Data Matrix	Enable
	PDF 417	Enable
	Micro PDF 417	Disable
	Codablock A	Disable
	Codablock F	Disable
	Maxicode	Disable
	QR Code	Enable
	Aztec	Disable
	GS1 Composite A/B	Disable
	GS1 Composite C	Disable



If you want to change the default setting of symbologies or other advanced setting, please

- 1) **Disconnect** the Barcode Reader from Winset.
- 2) Download “**Easyset**” barcode scanner configuration application from Intermec website, and execute the application.

When “**Easyset**” application launches, a “**Select product**” on-screen prompt will show up. Select “**Scan engines**” and pick “**ED40**”. Make sure the “**Online setup**” option is checked, and select “**OK**” as shown in the screen capture below:

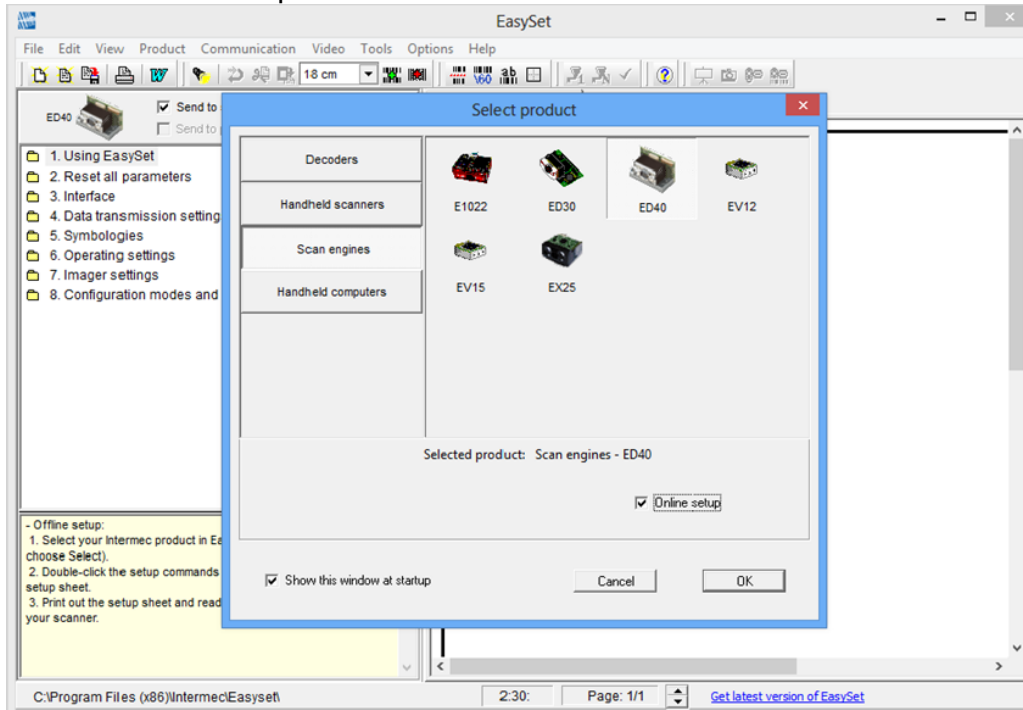

- 3) Another “**Device Selection**” on-screen prompt will show up. Select “**Communications Port (COM15)**” and select “**OK**” as shown in the screen capture below:

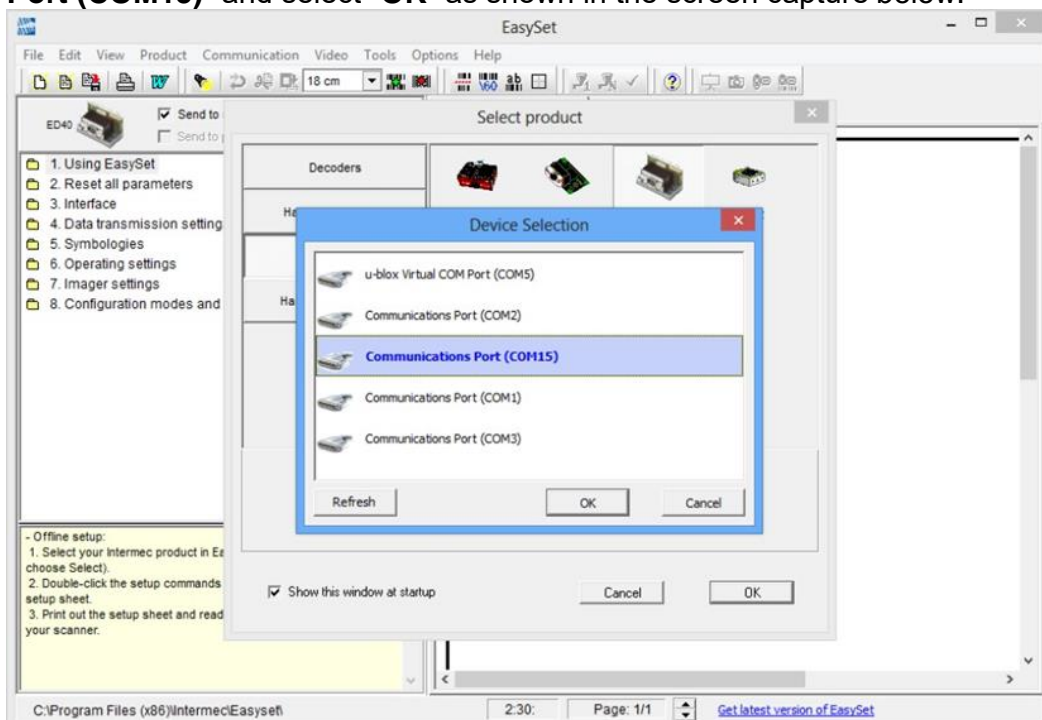

- 4) User can select Barcode code type of interest by pressing “**5. Symbologies**”. in the navigation pane, and it will show its configuration options.







For more information on how to use the “**EasySet**” application, please refer to the complete *EasySet User Guide*.

## 4.6 Using Camera

This Winset Cam utility allows users take a picture or record a video.

1. Press the **Fn**  **+F5** hotkey located on the front panel to open camera utility.



No	Item		Description
1	Review		Review
2	Settings		Opens Camera settings page. Available Settings: Picture Save: modify/inspect saved location for pictures. Video Save Folder: modify/inspect saved location for video recordings. Picture Quality: Picture compression quality.
3	Flash Control		Enables/ Disables LED Flash when taking picture.
4	Video Record		Tap to Start, and press again to stop recording.
5	Shutter Camera		Camera Shutter Button. Tap to take picture.
6	Exit		Exits the Camera and hide Winset Utility.

## 4.7 Using the Expansion Module

The Expansion Module allows users to add optional Data Readers through the expansion port, either UHF RFID Reader or Smart Card Reader.

### 4.7.1 Expansion Module Introduction



#### Important:

The Expansion Port is optional for M101BK Tablet PC and is not re-workable by the end user. To work with the Add-on module, please make sure the tablet PC has a built-in expansion port before use or contact our sales contact window for more details.

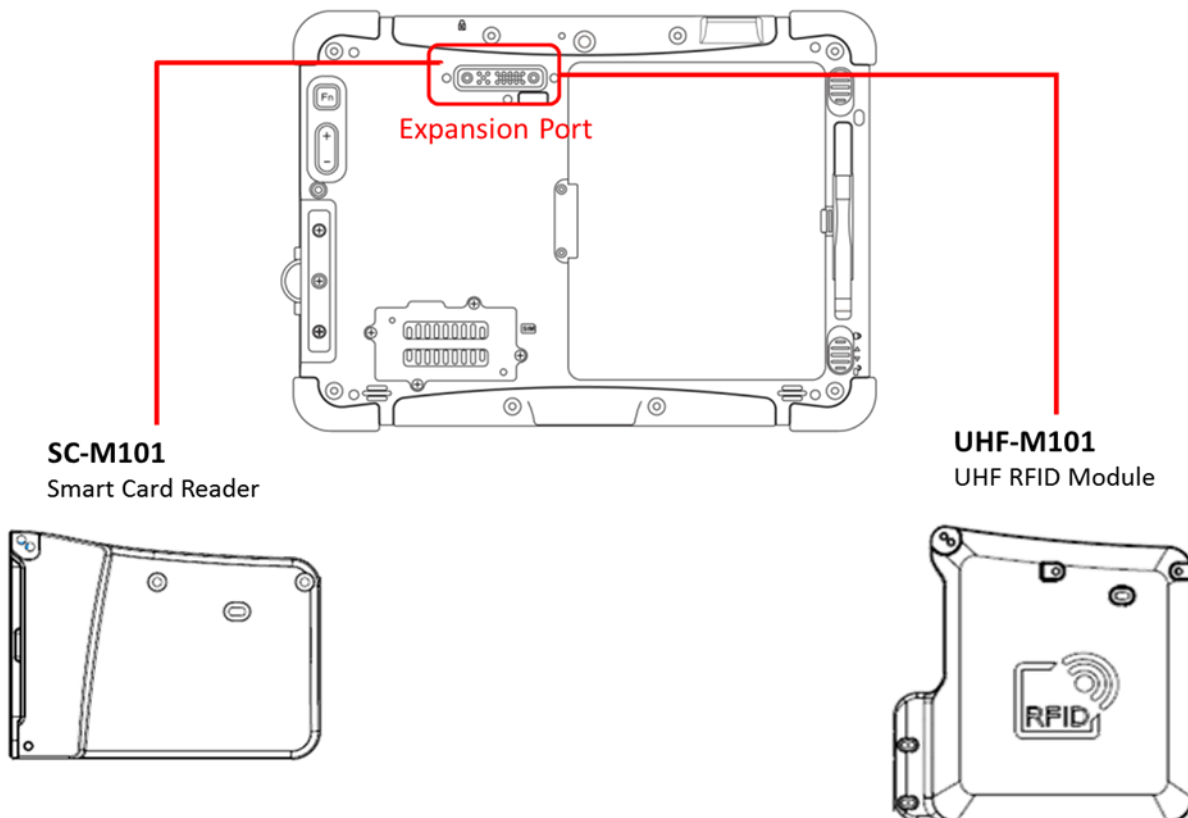

#### Caution/ Attention

Do not open when the cover when expansion port is not being used.

Ne pas ouvrir lorsque le couvercle lorsque le port d'extension n'est pas utilisé.

Item	Status Color	Description
 Ext. Module	Orange	Expansion Module is enabled.
	White	Expansion Module is disabled.

## 4.7.2 Installing UHF RFID Module

### How to Install:

1. Remove expansion port cover from the rear side of Tablet PC.
2. Remove the top two screws of the I/O cover.
3. Align the pogo pin on UHF RFID module to the expansion port of Tablet PC; screw to fix the module on tablet.

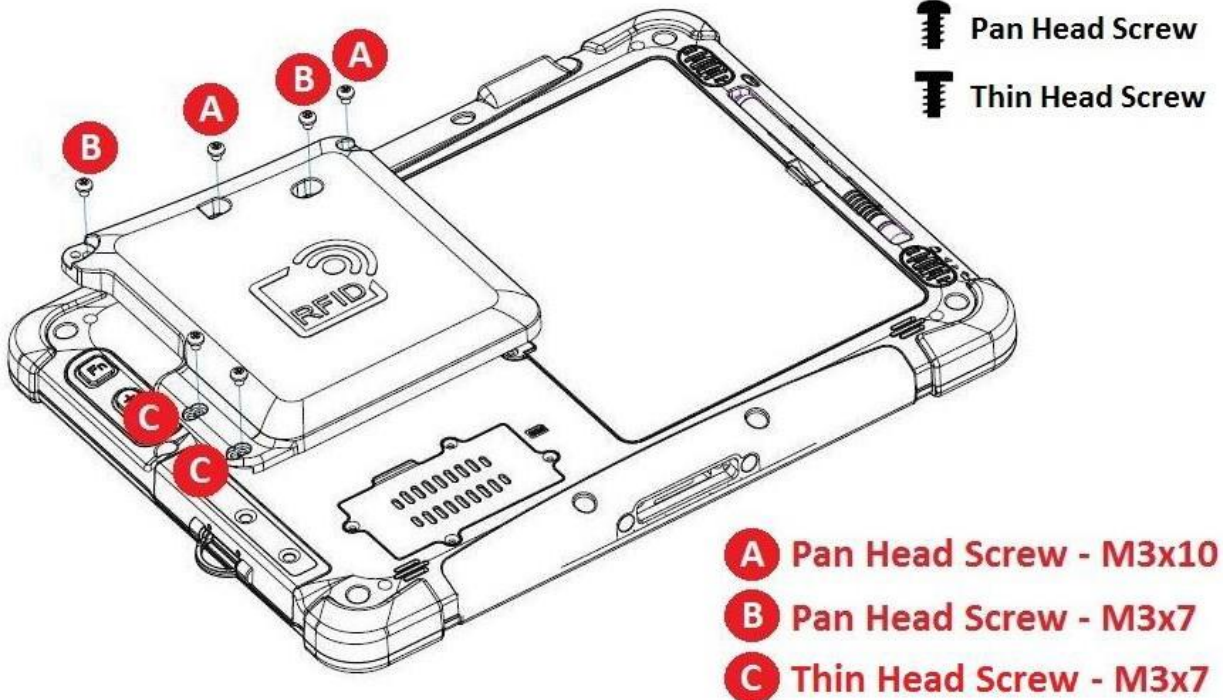

### How to Use:

1. Long-press Fn + F1 function key to open Winset. Users also can open Winset by double-clicking on the Winset icon on the desktop.
2. Click on the Device Control tab under the Winset utility and open the RFID Scanner Settings.
3. Choose “**Device ON/OFF**” and click on “**Ext. Module**”, and the setting utility will show up as below:

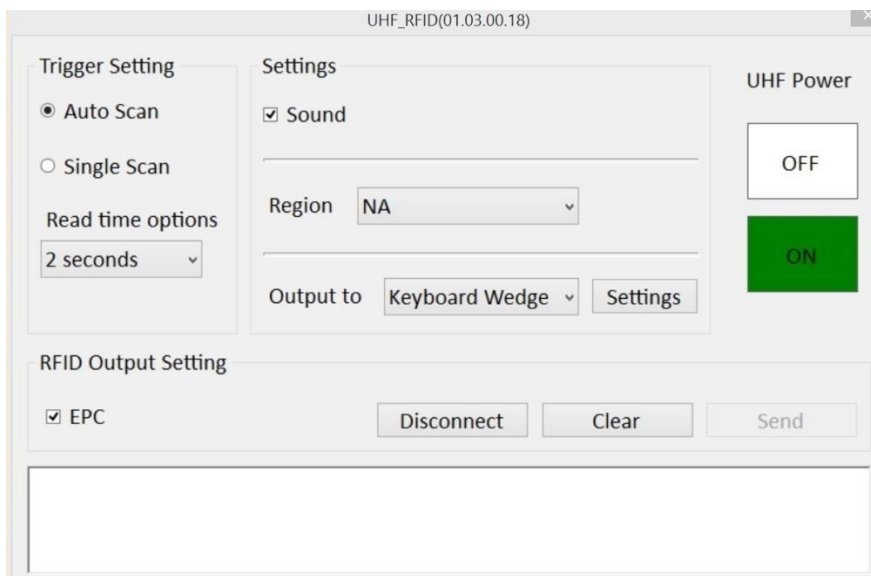

4. Tap on the **ON** button.
5. Check the status color of the ON icon is green.

### 4.7.3 UHF RFID Trigger Settings

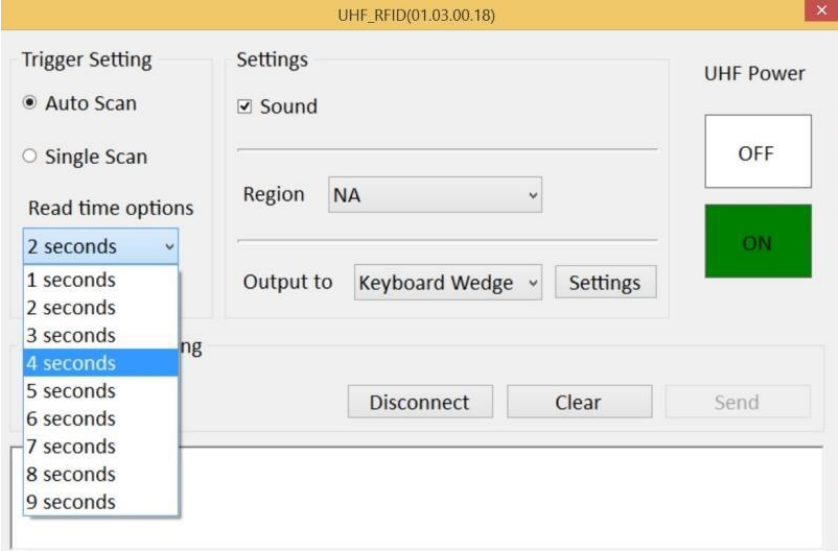
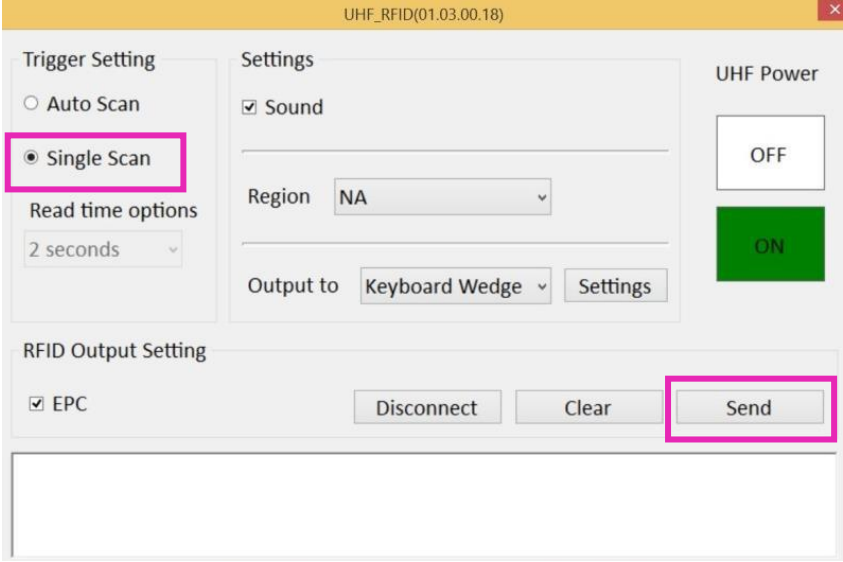
Item	Description
Auto Scan	<p>The default setting for UHF RFID trigger is Auto Scan. Under this setting, the UHF RFID Reader will always be ready to scan tags.</p> <ul style="list-style-type: none"> <li>When the UHF RFID tag is detected, the data will be read automatically.</li> <li>User can define the UHF RFID scanning frequency from the drop-down menu shown as below. The frequency can be from 1 second to 9 seconds.</li> </ul> 
Single Scan	<p>User can also define the UHF RFID Reader scanning as SINGLE SCAN. Under this setting, the UHF RFID Reader will be triggered only when user click on “Send”.</p> 

## 4.7.4 UHF RFID Settings

You can define the UHF RFID settings.

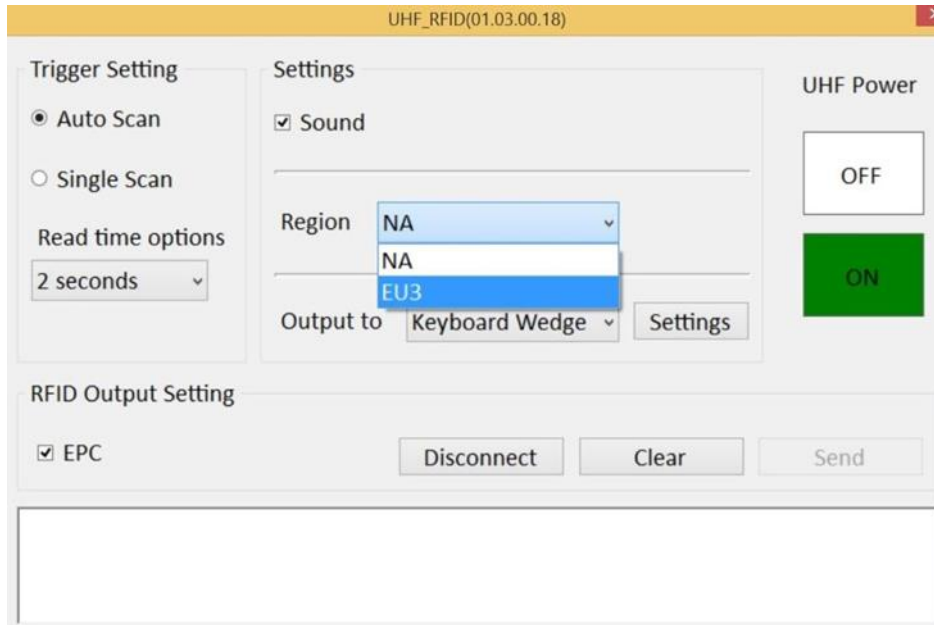

Item	Description
<b>Sound</b>	The Sound check box defines whether a beep sound will come with the data scanning.
<b>Region</b>	Basing on different regional regulations about UHF RFID frequencies, user can switch frequency to NA (North America, 902-928 MHz) or EU3 (Europe, 865-868 MHz) from the drop-down menu shown as below.
<b>Output to</b>	This setting defines the output type of the scanned data. Two options are available: Keyboard Wedge, SDK

### UHF RFID Output

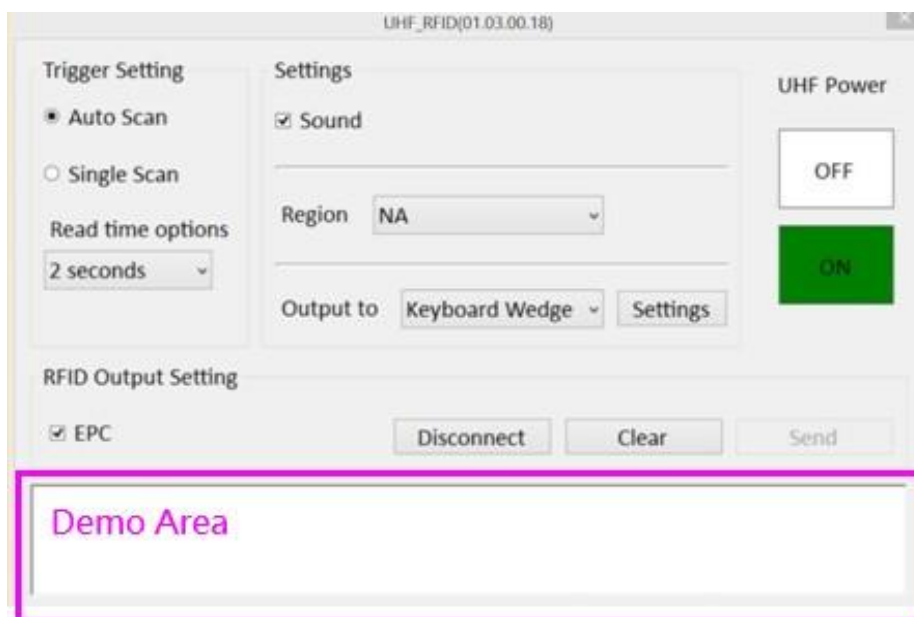

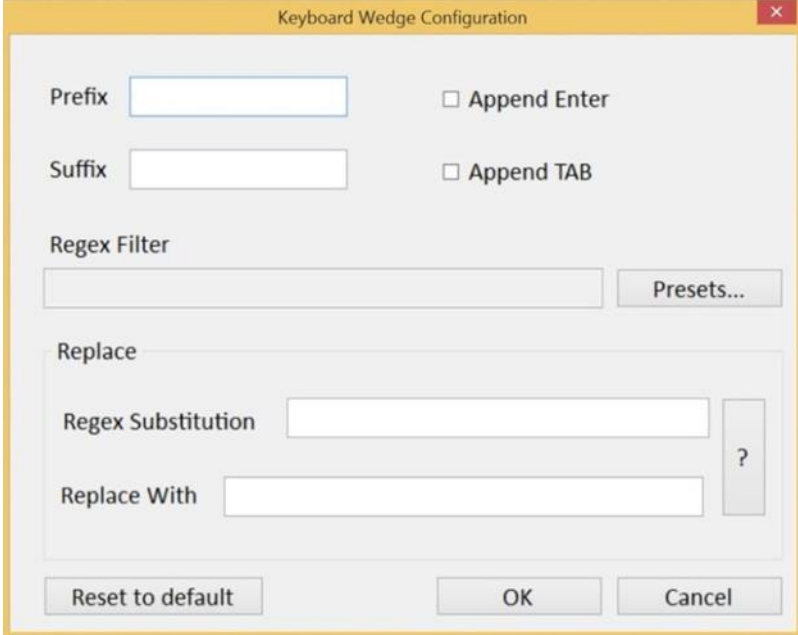
Item	Description
Keyboard Wedge	<p>Under this setting, the data scanned is sent like keyboard data. The scanned data can be output directly to the demo area below this window, or user can also open other utility, such as Office Word or Notepad files, for data input.</p> <p><b>Warning:</b> Please notice that the input method should support the scanned character. You can also tap on the Settings button for further details settings.</p>  <p><b>Prefix:</b> Type in this field to define the characters BEFORE the data scanned.</p> <p><b>Suffix:</b> Type in this field to define the characters AFTER the data scanned.</p> <p><b>Regex Filter:</b> Press on “Presets...” button, user can define how many characters to show after the data scanned.</p> <p><b>Append Enter:</b> The check box user can defines to append an “Enter” which is followed by the characters.</p> <p><b>Append TAB:</b> The check box user can defines to append an “TAB” which is followed by the characters.</p>
SDK	<p>For users following SDK for software porting, the scanned data can also be output with the format needed.</p> <p><b>Note:</b> Please download the SDK from <a href="#">Winmate Download Center</a> &gt;&gt; M101BK &gt;&gt; Development Kit or check the Driver CD which is shipped with the tablet.</p>

## 4.7.5 RFID Output Setting

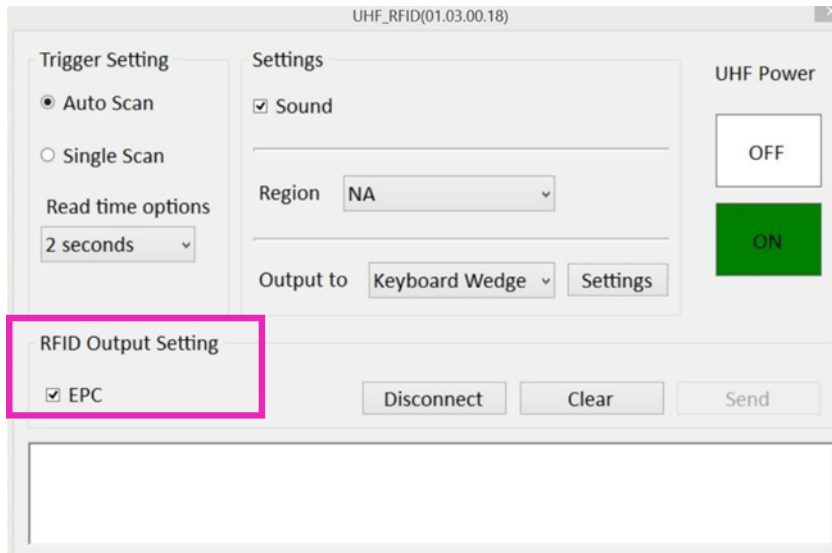

Item	Description
<b>EPC</b>	<p>The EPC check box defines whether to show the complete information of EPC (Electronic Product Code), including</p> <ol style="list-style-type: none"> <li>1. The identifiers of the object(s) or other entities that are the subject of the event.</li> <li>2. The date and time when the event took place, and the local time zone in effect.</li> <li>3. The identifier of the location at which the event occurred.</li> <li>4. The Information about the business context</li> </ol>
<b>Disconnect / Connect</b>	<p>User can tap on the <b>Disconnect</b> button to stop the connection with UHF RFID Reader.</p> <p>*To recover the connection, please turn off the module from setting UI and then turn on the module again.</p>

For more information on setting, please download “Universal Reader Assistant” UHF module configuration application from **Thing Magic** website at [www.thingmagic.com](http://www.thingmagic.com) .

## 4.8 Replacing Hot Swappable Battery

The tablet computer supports hot-swapping of batteries, meaning the tablet doesn’t need to be powered off in order to replace the main battery. To support such mechanism, there is a backup battery inside the tablet that is charged up with the main battery. This backup battery cannot be removed and needs to have adequate power for hot swapping of main battery to be done without issue. When the backup battery is fully charged, it can sustain up to 5 minutes of runtime to allow for battery hot-swapping.

*Perform the following to hot swap the batteries:*

1. While the tablet is powered on, go to the Winset application to check on the power level of the Backup battery.
2. If the Backup battery level is at “Low”, please charge the tablet with AC Power until the Backup battery level is at “Medium” or “High”, and do not remove the main battery.
3. If the Backup battery level is at “Medium” or “High”, continue to remove the main battery.



4. Insert a new charged up removable battery into the battery compartment.
5. Go to the Winset application to check if the Main battery level can be correctly read. If not, check if the new removable battery is inserted properly.
6. If Main battery level can be read, continue to use the tablet computer.



### Caution/ Attention

To keep battery health and prevent possible issues from battery over-discharged, please charge the tablet built-in back-up battery once for every 2 months.

Pour préserver la santé de la batterie et éviter les problèmes de batterie déchargée, veuillez recharger la batterie de sauvegarde intégrée de la tablette une fois tous les 2 mois.

## 4.9 Docking Connector Pin Definition

M101BK Tablet Computer supports one 19-pin docking connector at the bottom side. The pin definition is listed as the following table.

*Bottom Side:*

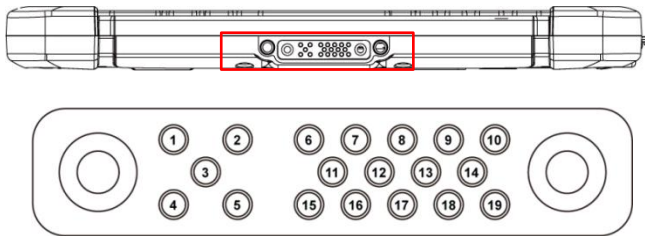

### 19 Pin Docking Connector

Pin No.	Description	Pin No.	Description
1	RF_GND	11	NC
2	DOCK_DET #	12	NC
3	GPS ANT	13	GND
4	RF_GND	14	Power
5	RF_GND	15	USB+
6	NC	16	USB-
7	NC	17	GND
8	DETECT+	18	GND
9	Power	19	DETECT-
10	Power		

## 4.10 Expansion Port Pin Definition

M101BK Tablet Computer supports one optional 19-pin expansion port at the rear side. The pin definition is listed as the following table

*Rear Side:*

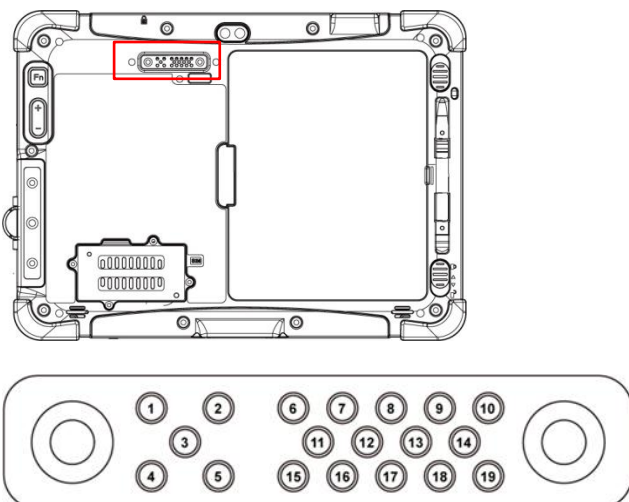

### 19 Pin Expansion Port

Pin No.	Description	Pin No.	Description
1	NC	11	RIB#
2	NC	12	RTSB#
3	NC	13	DTRB#
4	NC	14	RXDB
5	NC	15	DM4_R
6	CTSB#	16	DP4_R
7	DSRB#	17	VEXT
8	TXDB	18	GND
9	DCDB#	19	GND
10	GND		



### Caution/ Attention

Do not open when the expansion port is not used.

Ne pas ouvrir lorsque le port d'extension n'est pas utilisé.

## 4.11 COM Port Definition

M101BK tablet computer uses Winset utility for built-in peripherals control. All the COM port numbers have been defined in the OS image coming with the package.

COM Port	Device
COM 1	RS232 at I/O
COM 2	RS232 of Expansion Port (Optional)
COM 3	HF RFID (Optional)
COM 4	Bluetooth Auto Pairing
COM 9	GPS
COM 11	RS232 at Docking (Optional)
COM 15	Barcode Reader (Optional)
COM 20	UHF RFID (Optional)

For some special applications, user might re-install OS and lose the COM port settings. To make sure the features works properly with Winset utility, please follow the procedure below to re-define the COM port numbers:

1. Go to **Windows Setting**→**Devices** →**Device Manager**, right click on the COM number need to be changed, and tap on "Properties" to open the setting page.

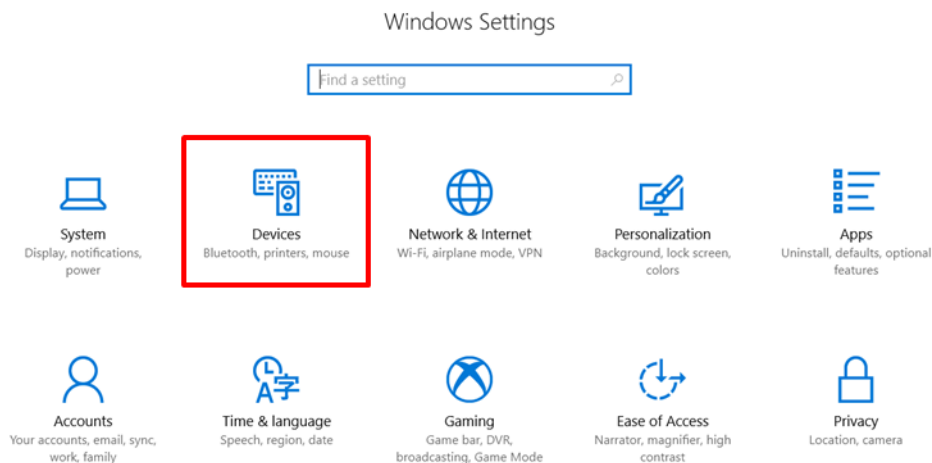

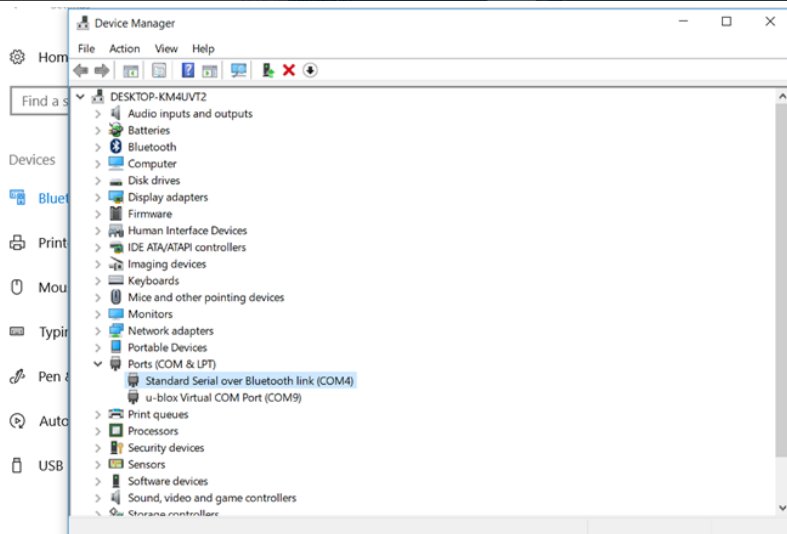
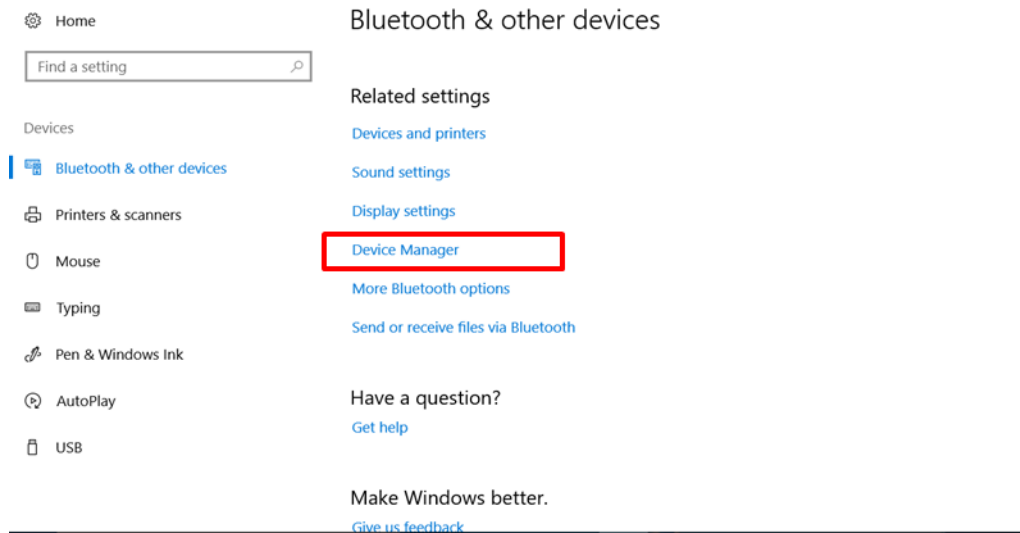

2. Tap on "**Port Setting**" tab and click on "**Advanced**" button.

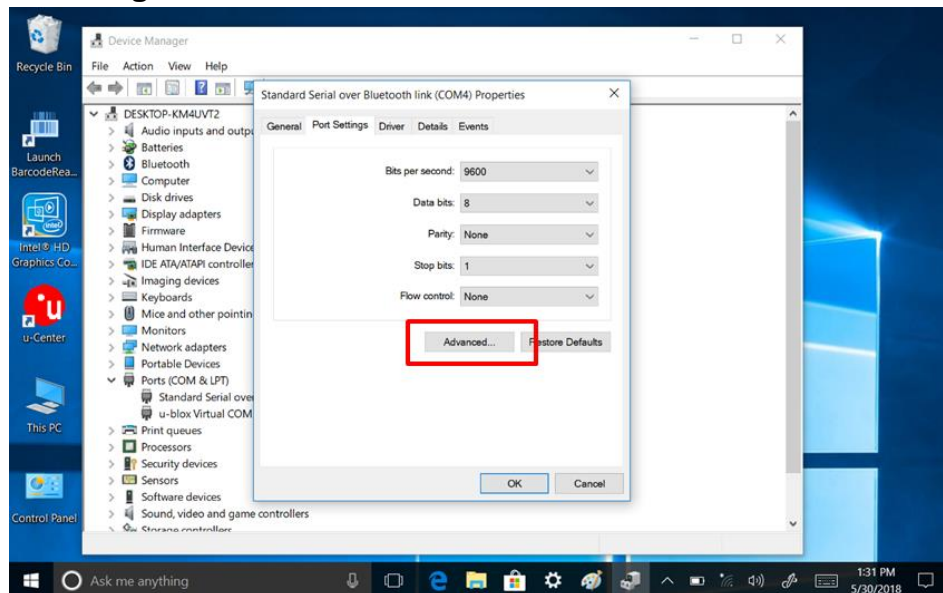

3. Tap on the dropdown list and choose the correct COM Port (refer to the COM Port Definition Table), and click "**OK**".

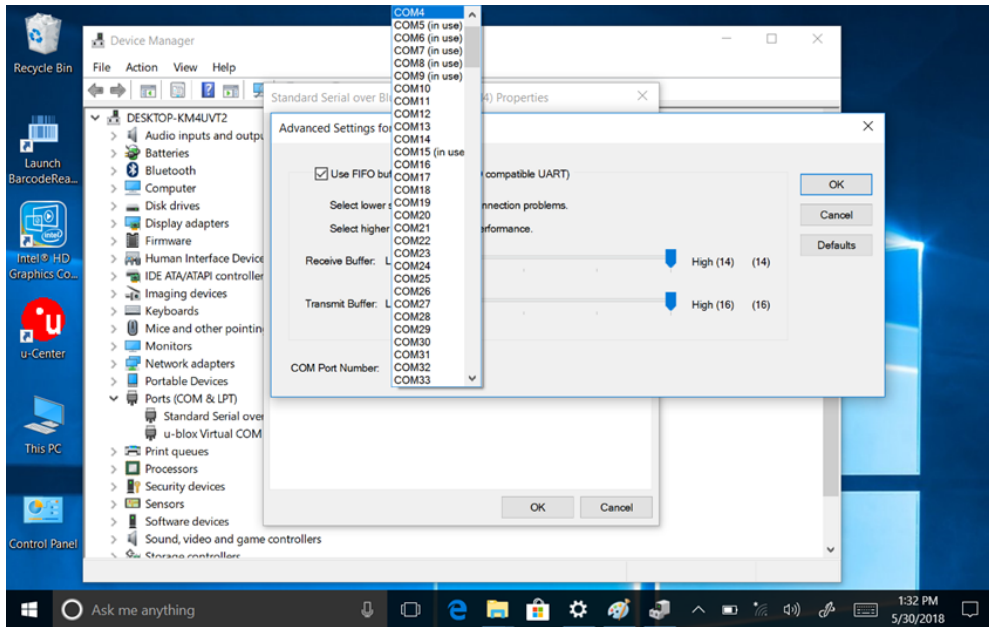

4. Double check "Device Manager" to make sure the COM Port number has been re-defined successfully, and then restart the system.

## 4.12 Adjusting LED Brightness

### 1. Open EZConfig-Scanning V4\_IE Icon

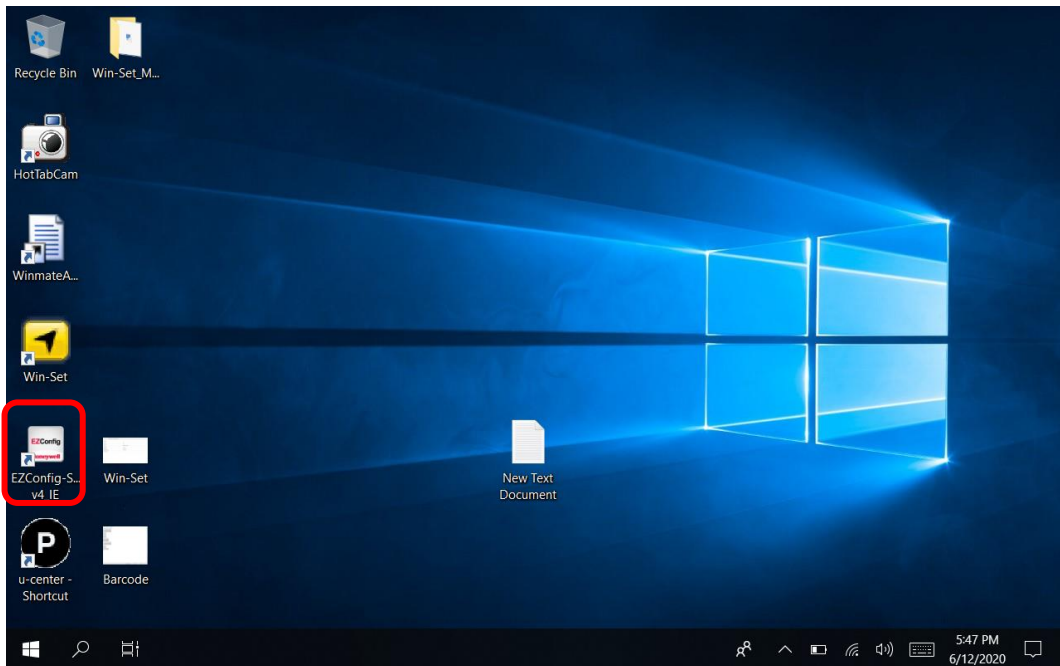

### 2. Open Connected Device

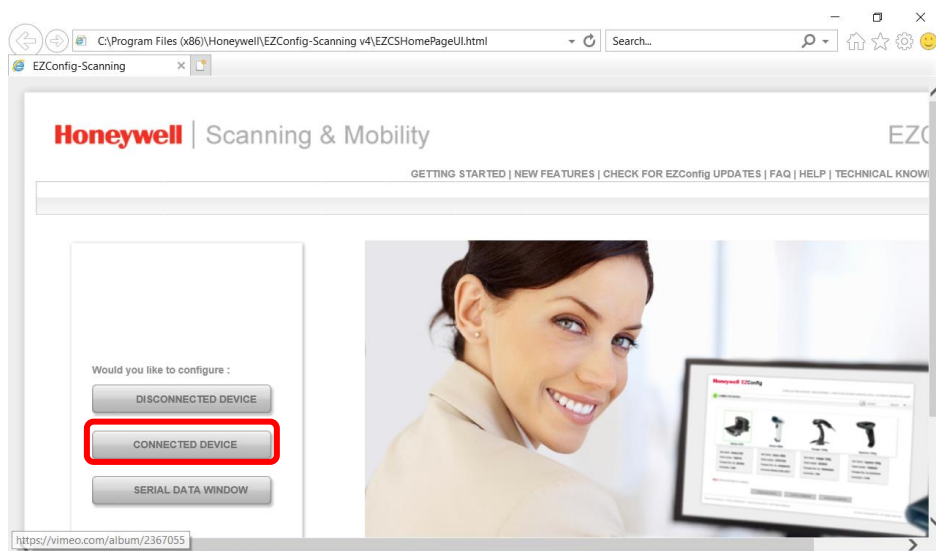

### 3. Open Connected Device

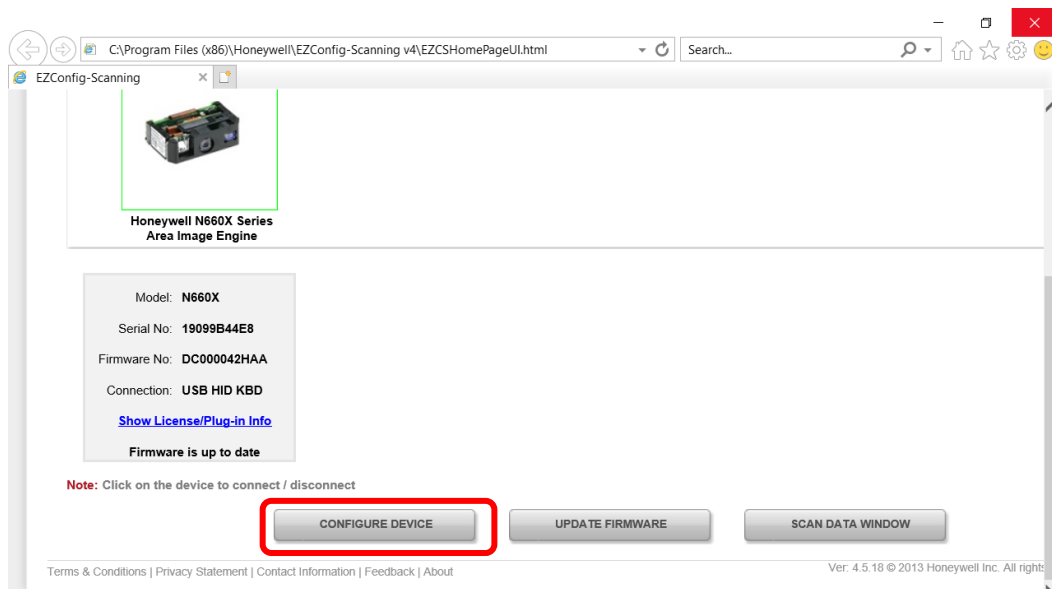

4. Open Settings → Device Settings → LED illumination - Manual Trigger **Setting change 120**

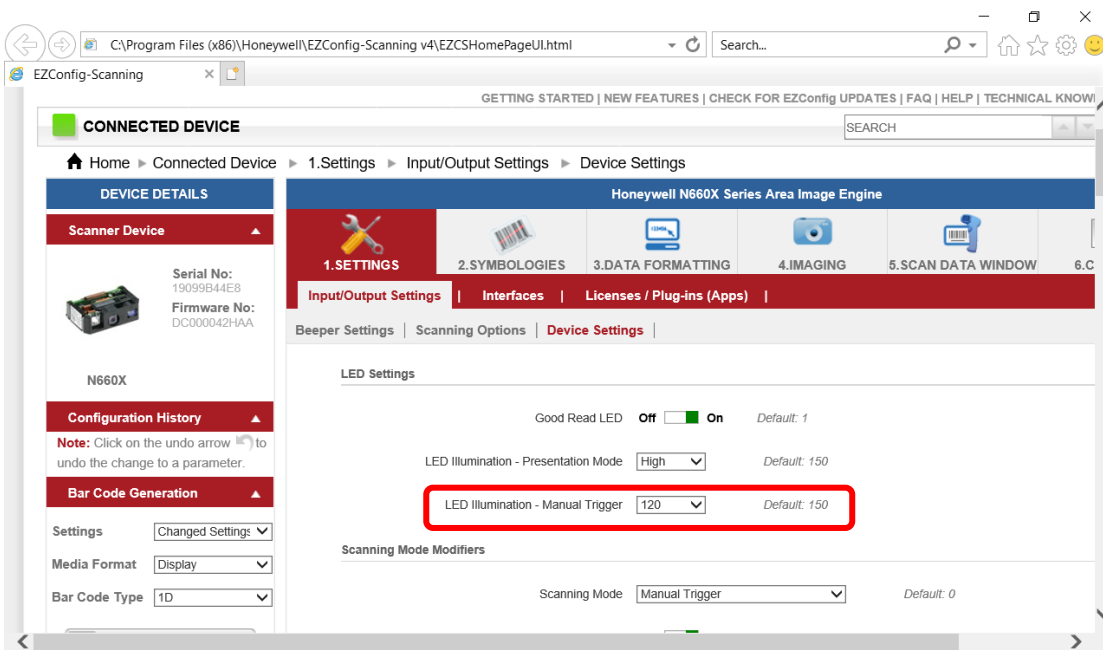

5. Save To Device

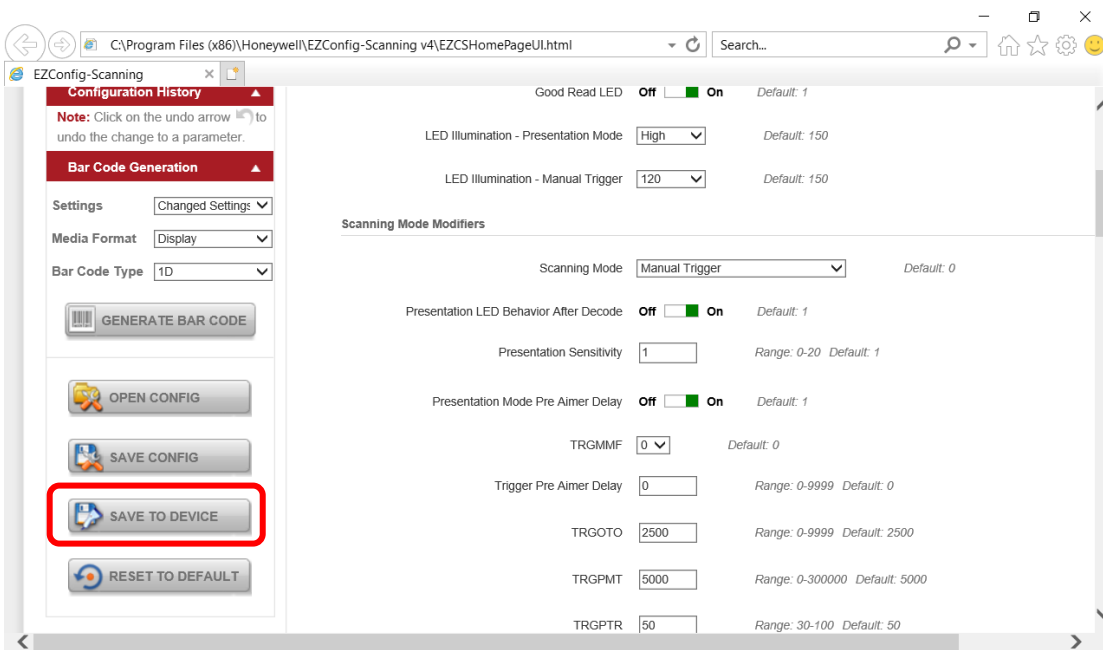

## 6. Open Win-Set Icon

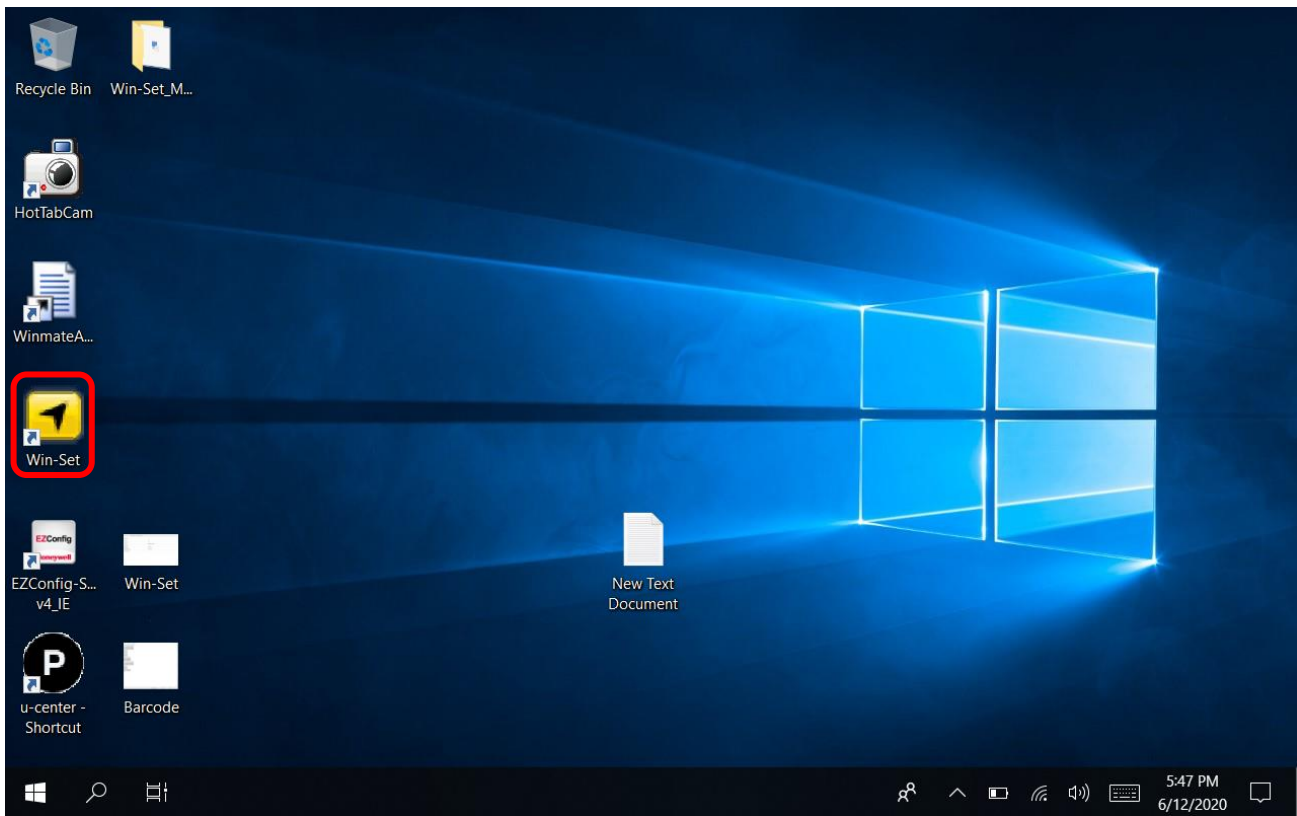

## 7. Barcode Scanner Wedge turns OFF

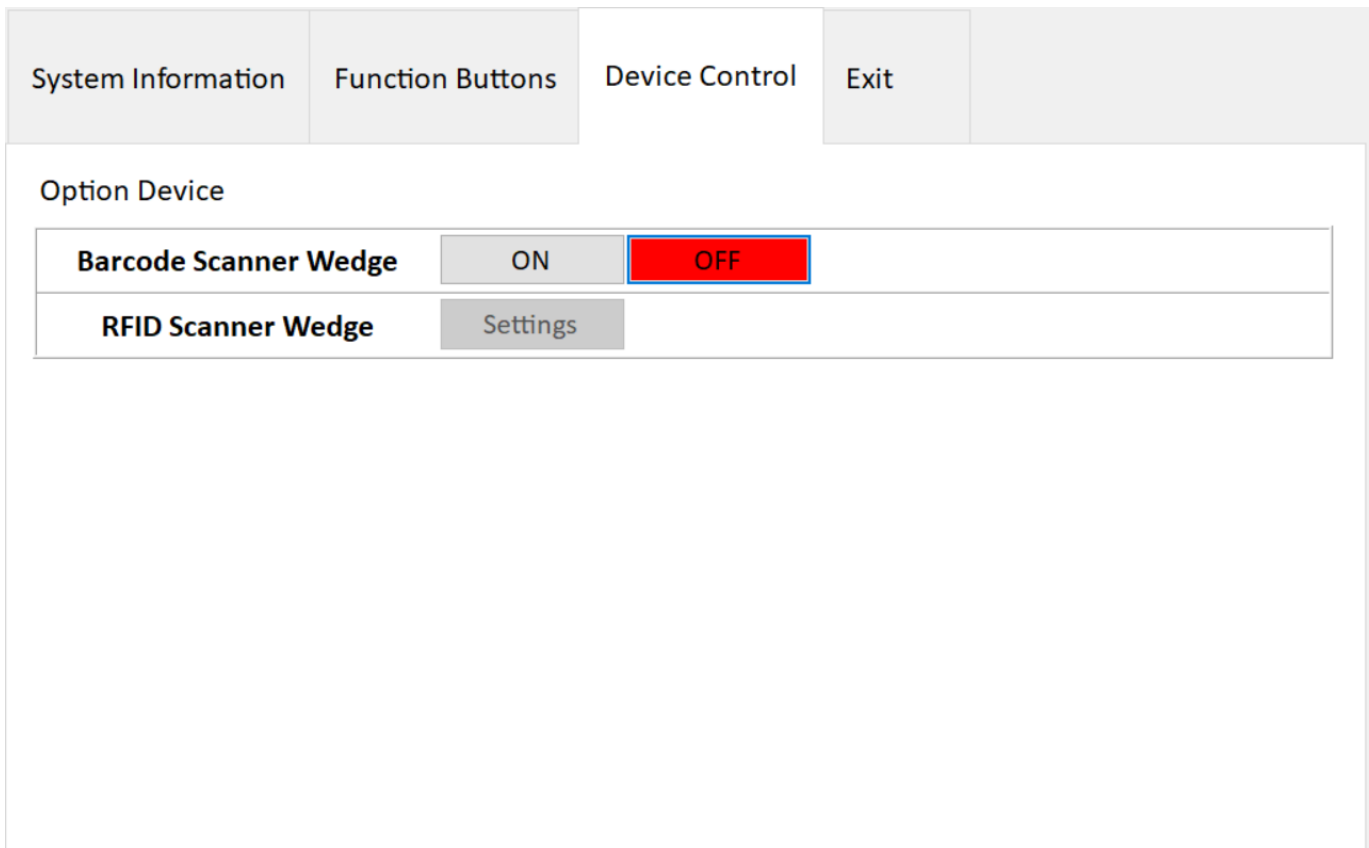

## 8. Barcode Scanner Wedge turns On

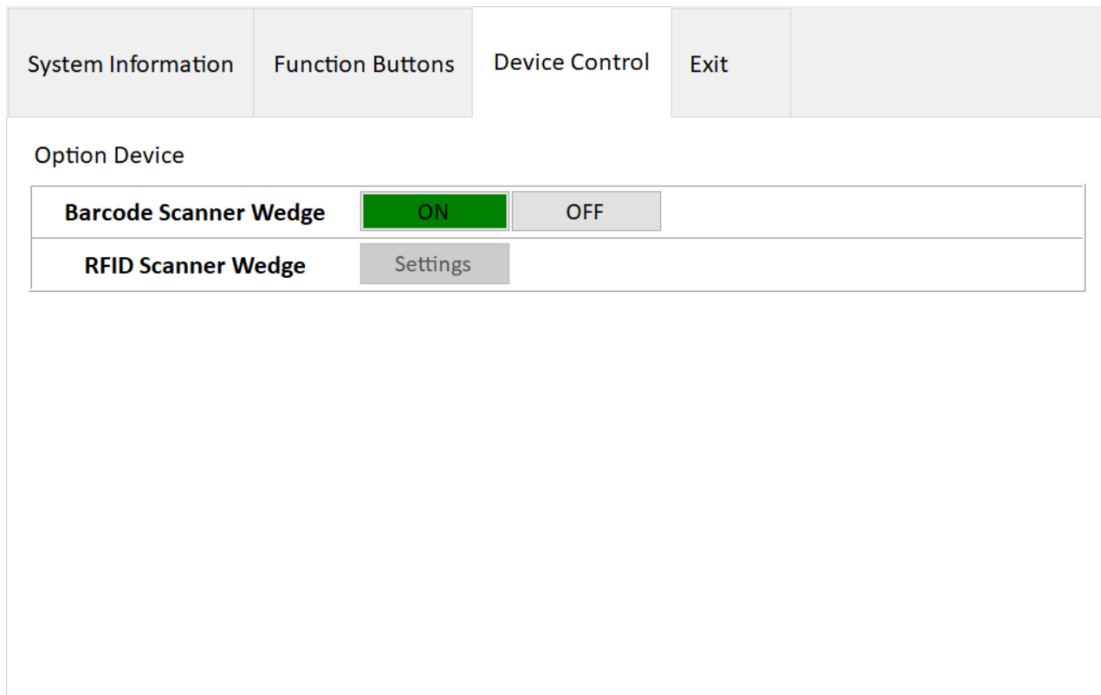

## 9. Scanner Barcode

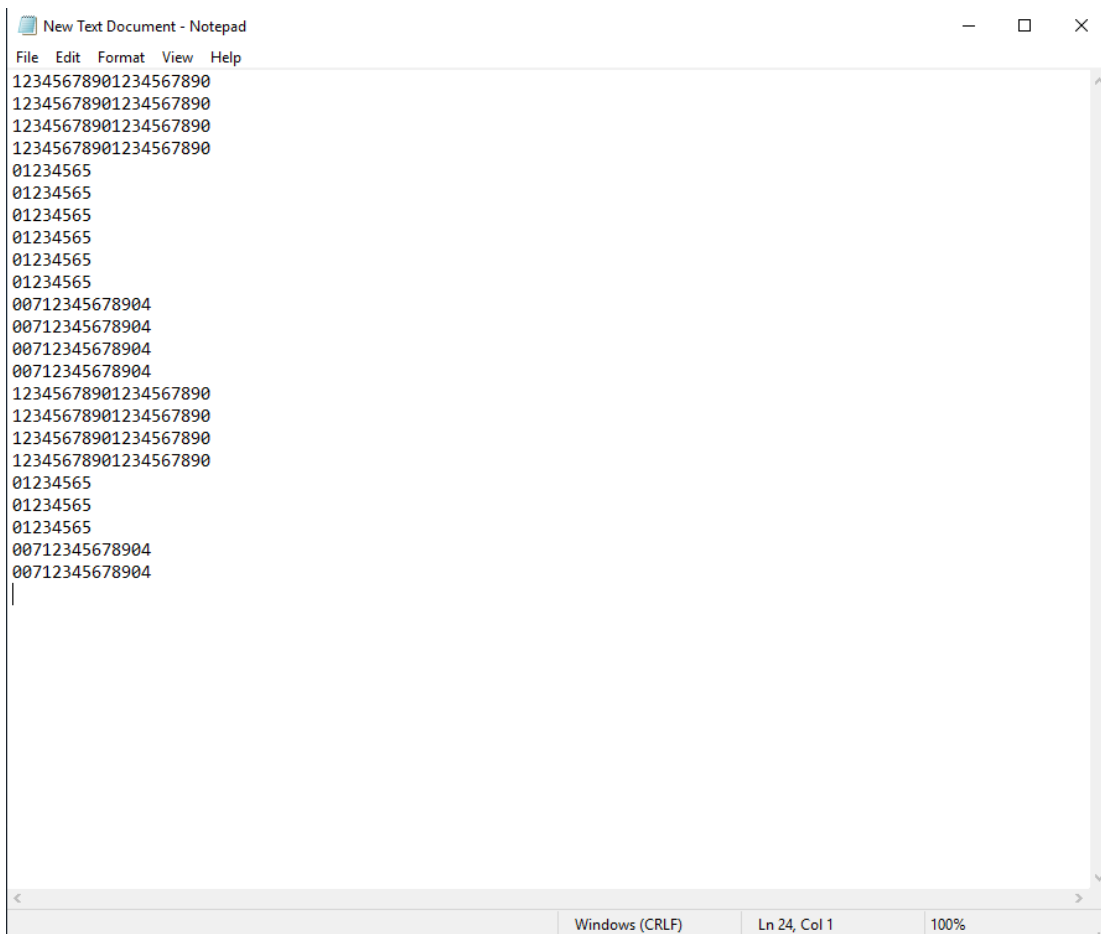



## Chapter 5: Frequently Used Settings

This chapter lists frequently used and recommended settings of your tablet.

---

## 5.1 Screen Resolution Scaling and Setting

The M101BK has a high resolution 1280 x 800 display which is perfect for viewing image, video, or other applications, however, Windows user interface (icons, buttons, and other user interface elements) may be too small to read and operate at the default Windows settings.

By changing the display scaling or the display resolution setting of the device, you can adjust the size of the text and other items on the desktop for optimal viewing. Display scaling is the recommended method because it has the effect of adjusting user interface element without having to move away from the optimal resolution setting at 1280 x 800. This section will explain how you can adjust the built-in windows display scaling setting and resolution setting.



### Note:

- The Tablet computer is shipped with display scaling set at **Larger - 150%**. We recommend the users set the scaling to this setting for optimal text and image viewing.
- Before proceeding to change the scaling option, make sure any opened document is saved and close, and all running applications are closed before proceeding to change the display scaling, because this procedure requires users to log out of their account to apply display scaling change.

### 5.1.1 Changing Display Scaling Setting (Recommended)

Perform the following to change display scaling setting:

1. Tap and hold anywhere on the desktop for 3 seconds and release to bring up the context menu, and select "Display settings" option as shown below:

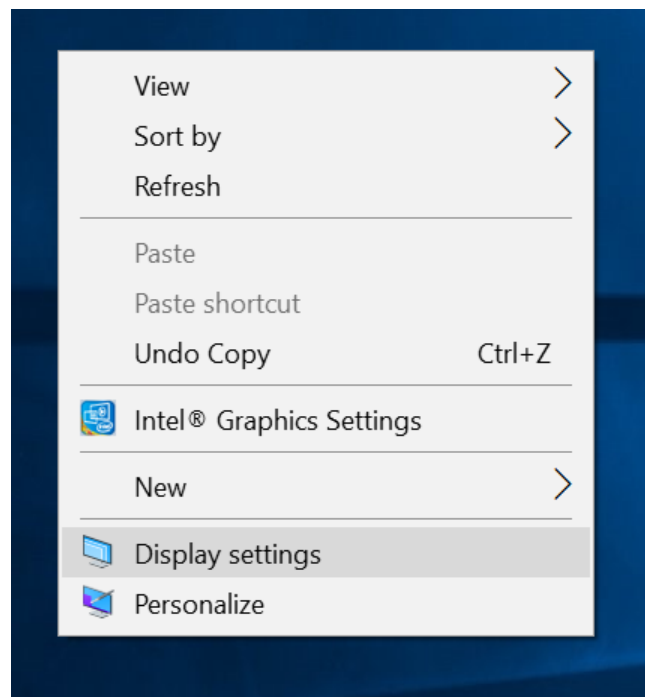

2. A “Display” Window will show up. Click on the dropdown option under the “**Scale and layout**” section and change the scaling option to “**150% (Recommended)**” or any other desired display scaling.

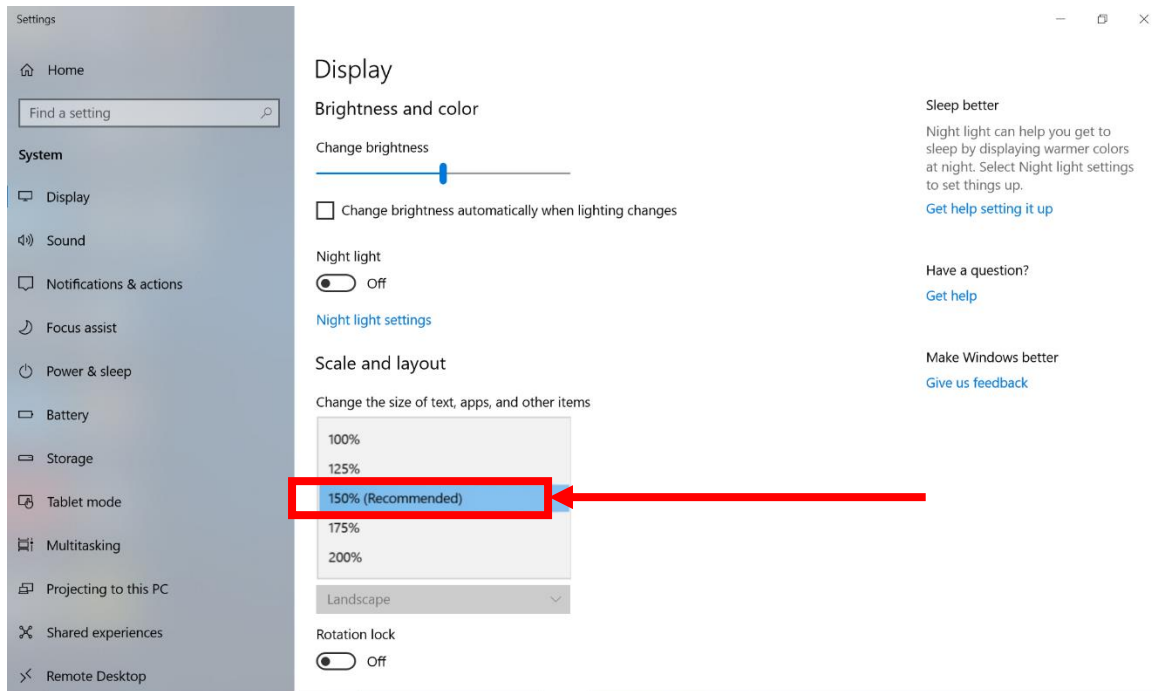

### 5.1.2 Changing Resolution

Alternatively, instead of changing the display scaling setting, user may choose to change the overall resolution setting to make screen elements bigger.

1. Tap and hold anywhere on the desktop for 3 seconds and release to bring up the context menu, and select “**Display settings**” option as shown below:

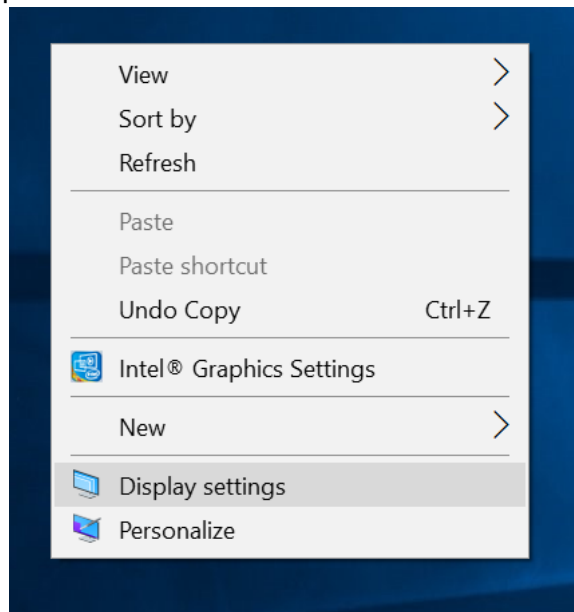

- Click on the dropdown option next to “**Resolution**” and select the desired resolution by tapping on the scale:

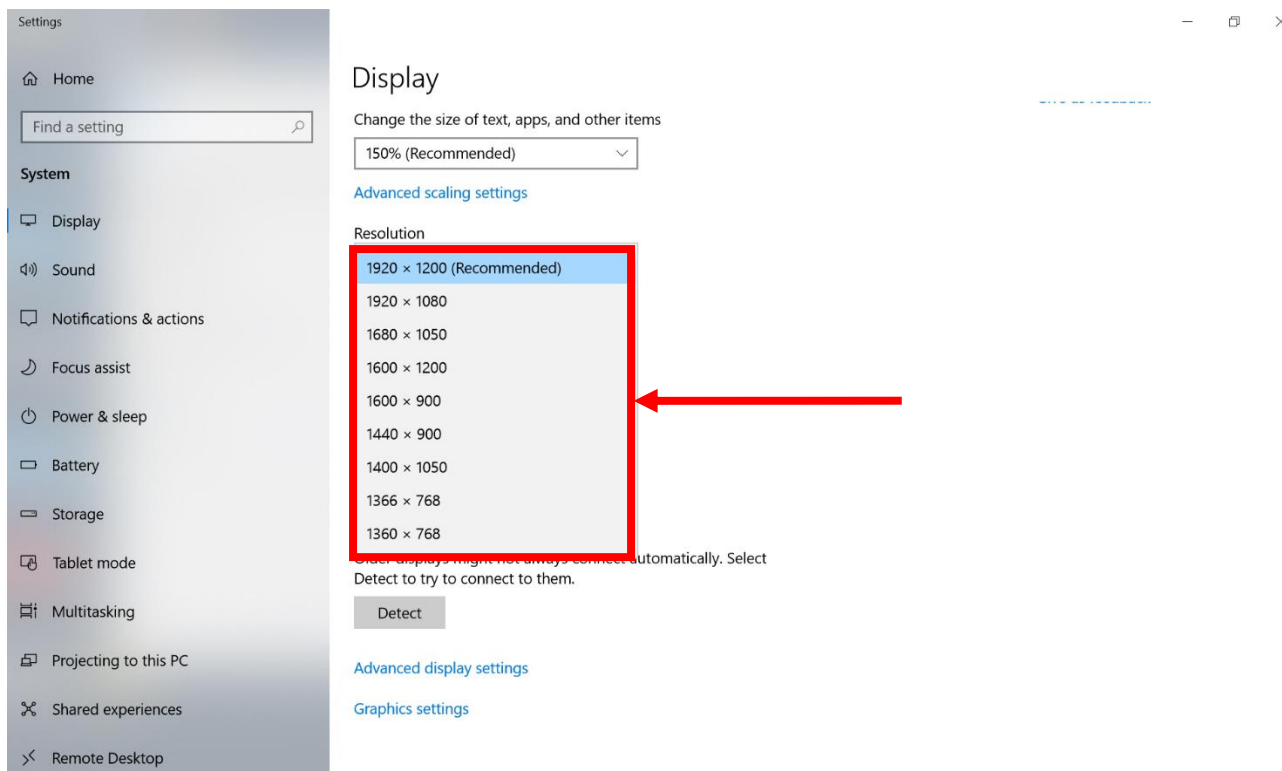

- Hit “**Apply**”. A prompt “**Display Settings**” prompt will show up to ask the user if the applied resolution is usable.
- If the new resolution is the desired display setting hit “**Keep changes**” and continue to next step. If the new resolution is not desirable, hit “**Revert**” and select a different resolution to change to, and start again from step 2.
- The user may now use the device with the new resolution setting.

## 5.2 Pairing with a Wireless Bluetooth Barcode Scanner with Bluetooth Serial Port Profile

The computer is affixed with a Bluetooth MAC (Media Access Control) address barcode label that enables wireless Bluetooth Barcode Scanner to quickly establish Bluetooth connection with the computer. It is encoded with leading characters to instruct the wireless Bluetooth barcode scanner to initial Bluetooth Serial Port Profile pairing request.

### 5.2.1 Setup Computer for Bluetooth Pairing

To start the pairing process, first perform the following steps to ensure the computer is properly setup for pairing:

1. Locate the **Bluetooth** icon  in the Notification Area.



2. Bring up the Contextual Menu by performing long press on the icon with touchscreen or right-click on the icon with a mouse, and select **Open Settings**.

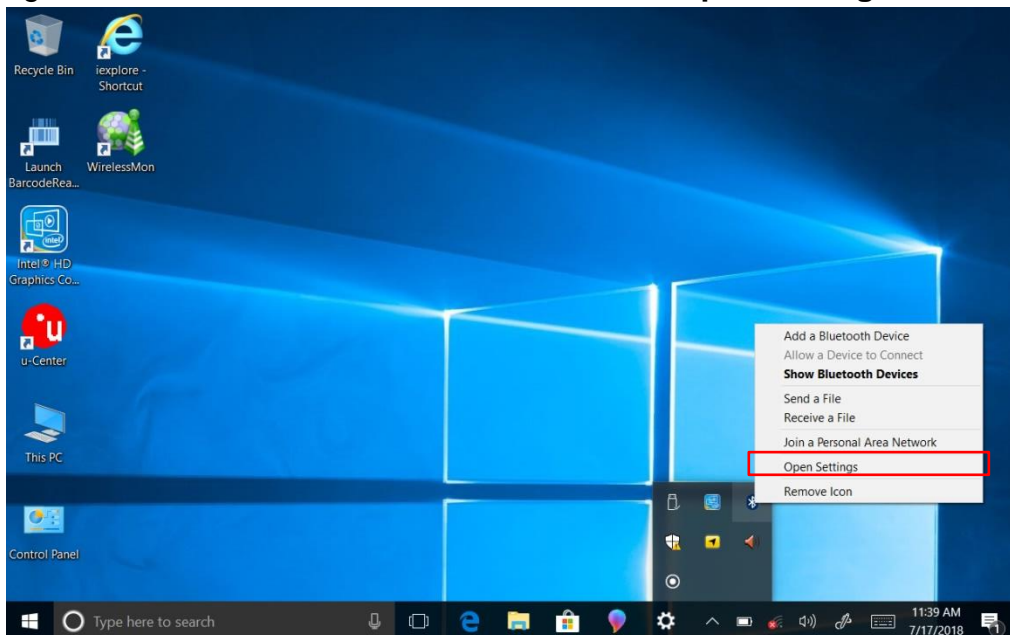

- Once the **Bluetooth and Other Devices** Menu appears, scroll down to **“More Bluetooth Options”** tab, and make sure that the computer is set to **“Allow Bluetooth devices to find this PC”**, as shown below:

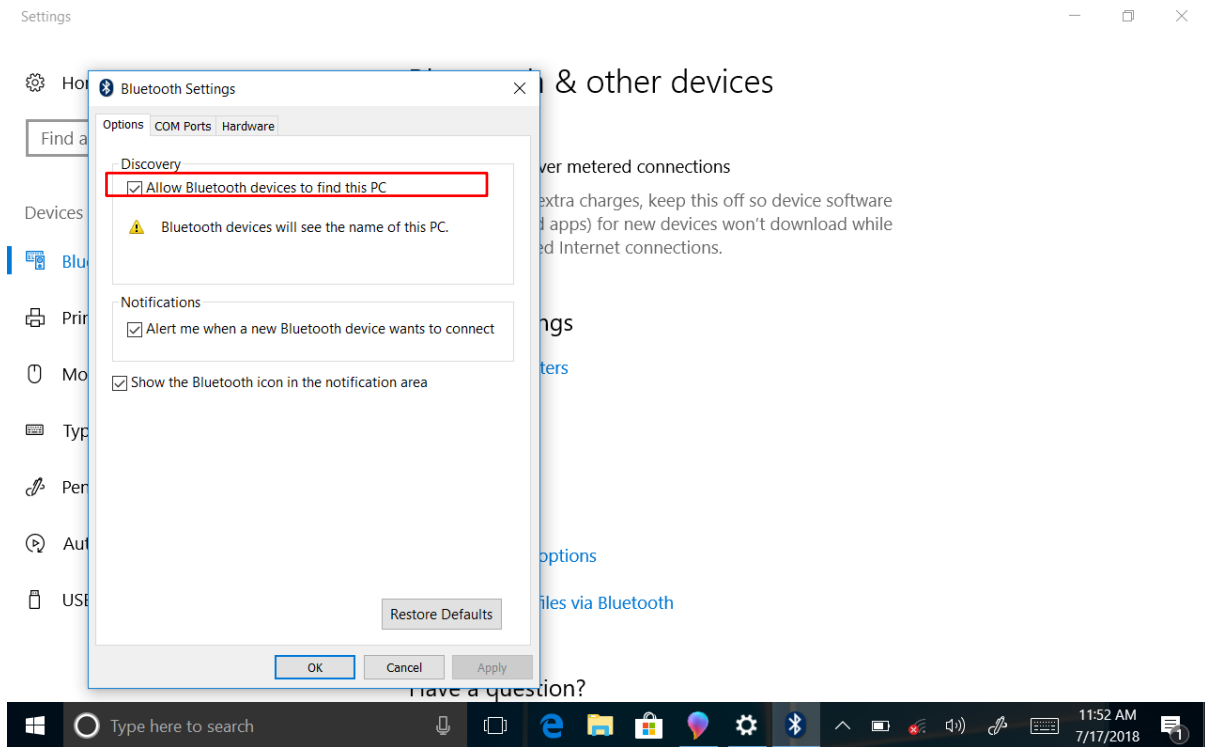

Click **OK** to continue.

- In the **Bluetooth Settings** menu, go to **“COM Ports”** tab. COM port has to be setup for the wireless Bluetooth Barcode Scanner to communicate via the Bluetooth Serial Port Profile. Click on the **“Add...”** button.

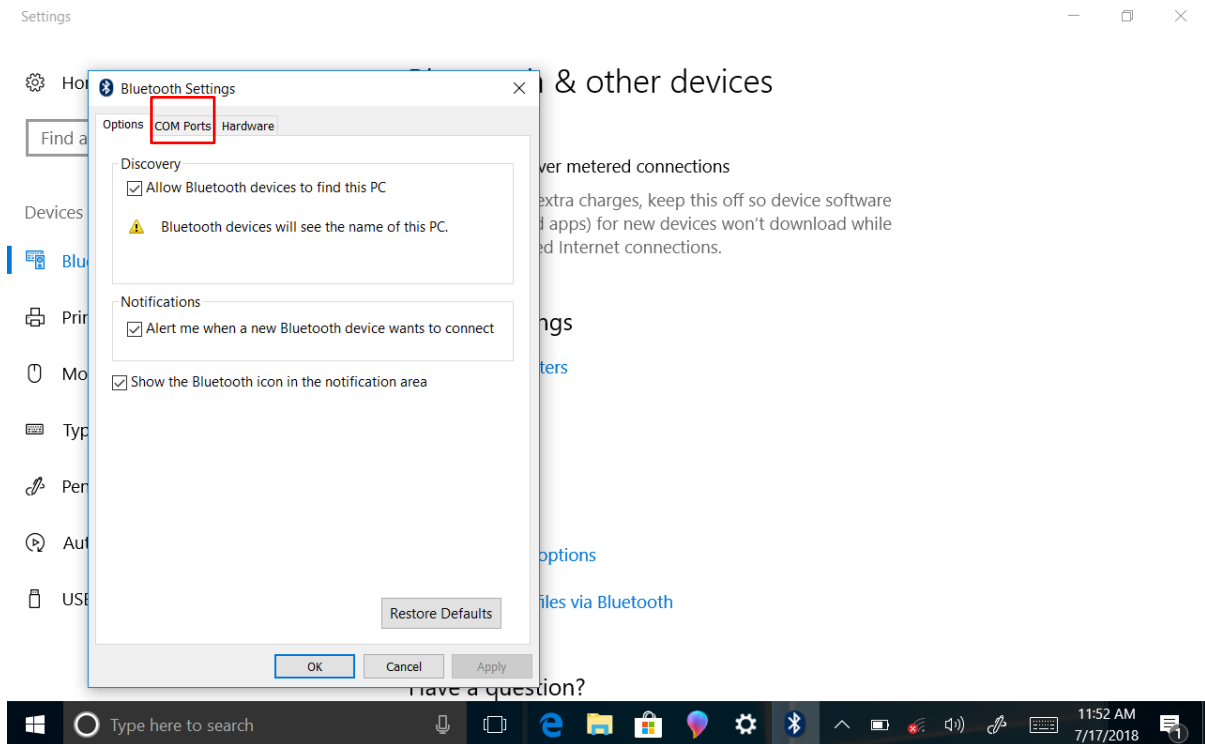

5. You are in “Add COM Port” window. Choose “Incoming (device initiates the connection)”, and click “OK”.

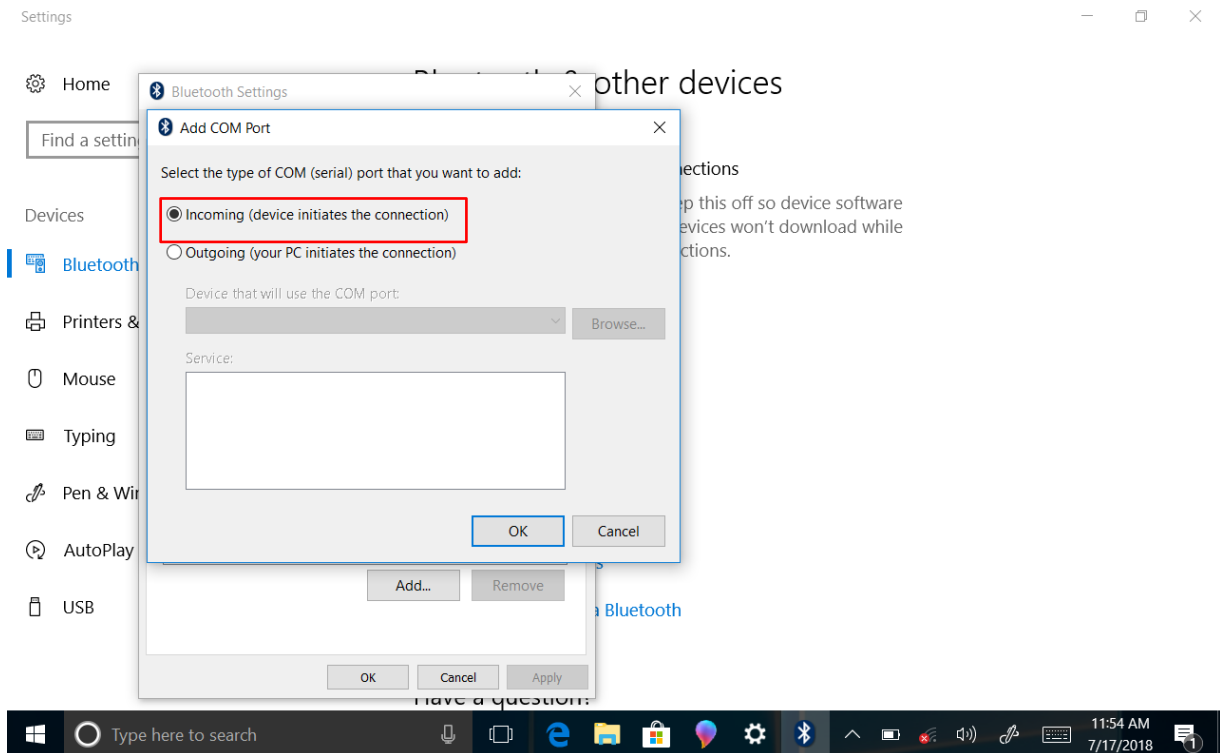

6. The computer will automatically assign COM Port to the Bluetooth connection. In the screenshot below, **COM4** is allocated.

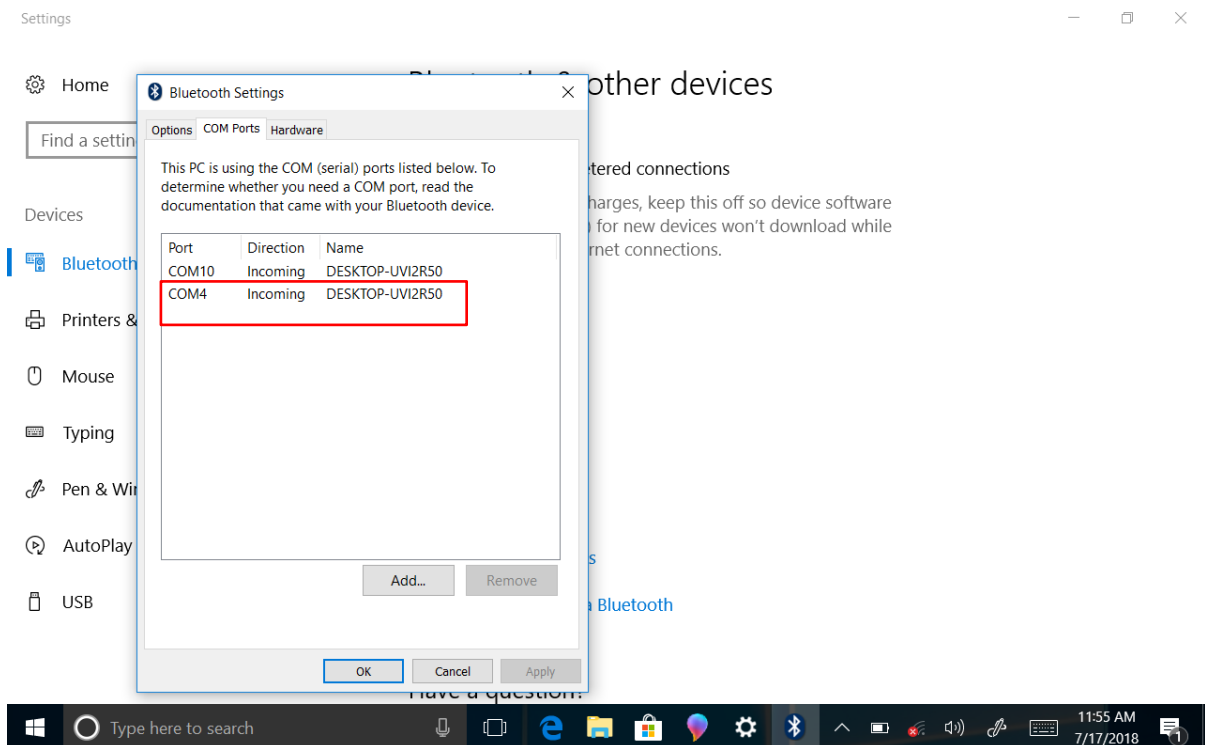

Click **OK** to continue.

- Next, the user has to configure the application that is used to accept the scanned data from the wireless Bluetooth Barcode Scanner. The application has to be configured to accept the same COM Port that has been assigned for the Bluetooth Serial Port Profile in the previous step.

**Important:**

Make sure the application stays open while pairing.

- Now the computer is ready to start pairing process.

## 5.2.2 Set up the Barcode Scanner for Bluetooth Pairing

**Important:**

The wireless Bluetooth Barcode Scanner has to be configured as Bluetooth Serial Port Profile Master device to establish connection via Bluetooth MAC address barcode label. For a more detailed instruction, please refer to the User Guide for the wireless Bluetooth Barcode Scanner you are using for pairing.

Now the Barcode Scanner is ready for pairing process to start.

## 5.2.3 Bluetooth Pairing

After you finish setting up both the Computer and Barcode Scanner you are ready to start pairing.

- Open a program that is used for pairing.
- Perform scanning procedures. A Bluetooth notification window pops-up on the right-hand side of the desktop. **Left click** on the mouse to enter the Add a device menu.
- Locate the **Bluetooth** icon  in the Notification Area.





#### 4. Click **Add a Bluetooth Device**.

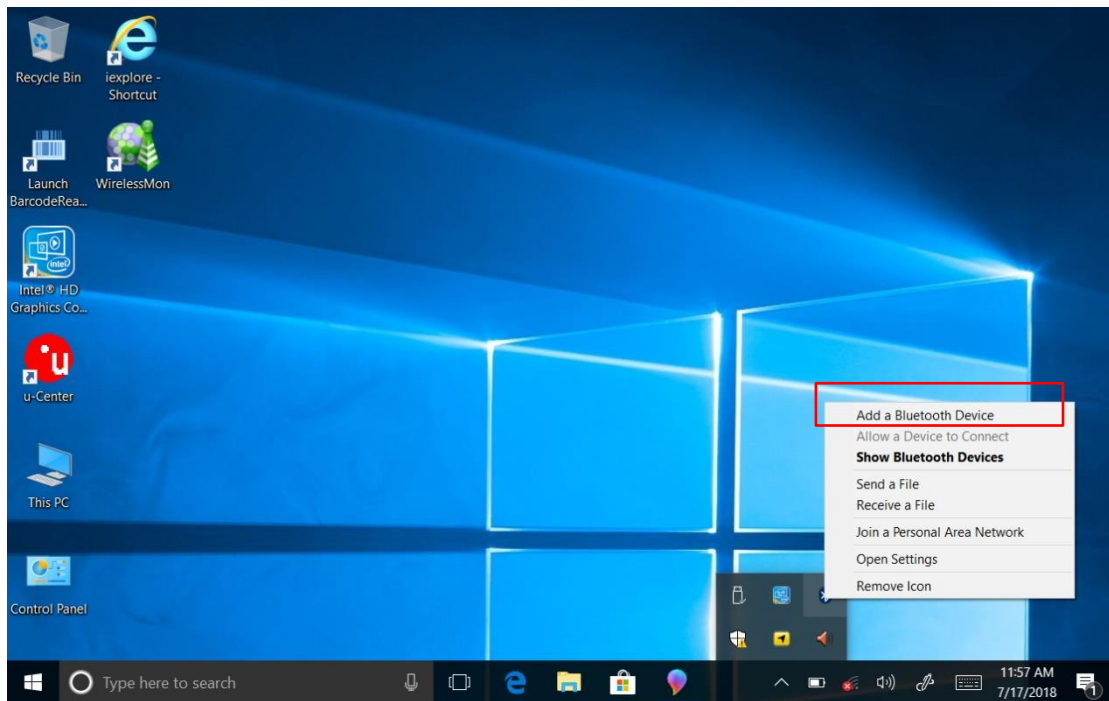

#### 5. In **Add a Bluetooth Device** window, click **Next** to connect the Barcode Scanner to the Computer.

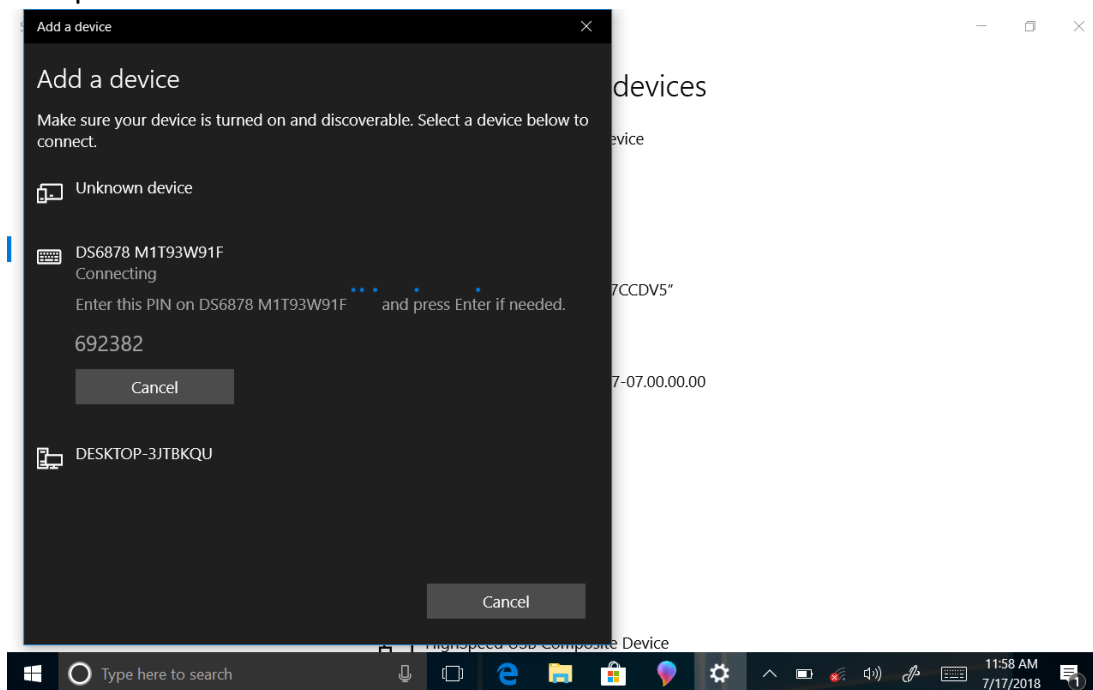

#### 6. The Barcode Scanner has successfully been added to this computer. Click **Close** to exit “Add a device” menu.

In order to make sure that Bluetooth Device is successfully paired to the Computer, follow the steps below:

1. Locate the **Bluetooth** icon in the Notification Area. Select **Show Bluetooth Devices**.

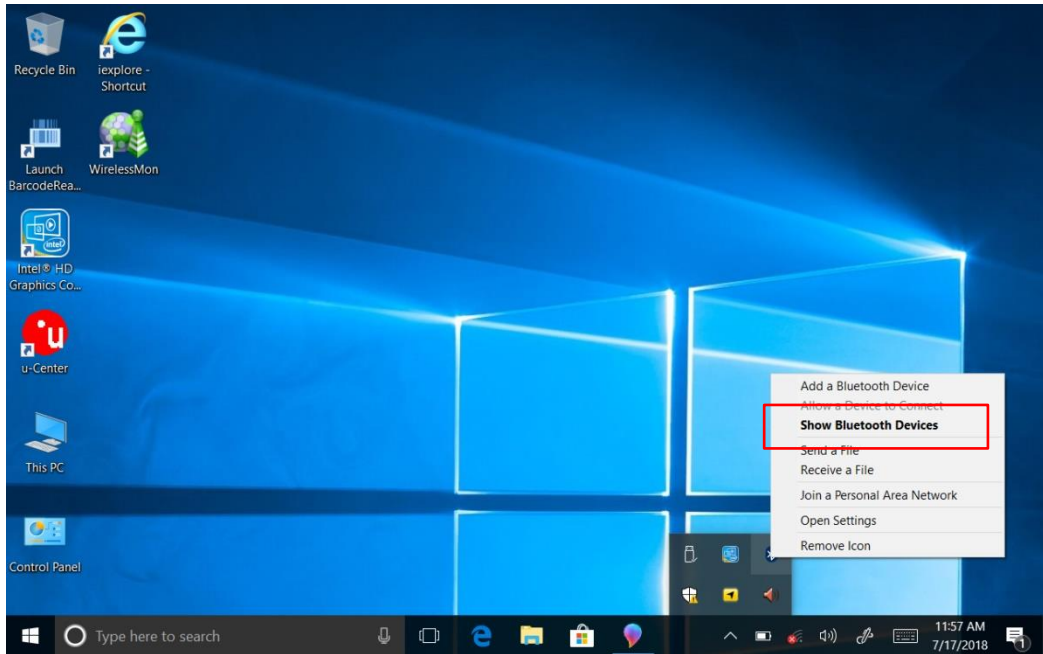

You can access this menu in the Control Panel:

Windows  → Control Panel → Devices and Printers → Bluetooth Devices

2. Make sure your device is connected to the Computer.

### 5.3 Using Recovery Wizard to Restore Computer

M101BK tablet computer has a dedicated recovery partition stored on the hard drive of the tablet to enable quick one-key recovery process. This partition occupies about 11GB of the storage space, and comes built-in to each M101BK tablet computer.



#### **Important:**

Before starting the recovery process, be sure to backup all user data, as all data will be lost after the recovery process.

Follow the procedure below to enable quick one-key recovery procedure:

1. Plug-in the AC adapter to M101BK tablet computer. Make sure the M101BK tablet computer stays plugged in to power source during the recovery process.
2. Power on the tablet computer, and when the boot screen shows up, press the **F6** button (Recovery Key) on the front bezel OSD button OR press **F6** when using an external USB keyboard to initiate the Recovery Wizard.
3. The following screen shows the Recovery Wizard. Click on "Recovery" button to continue.



4. A warning message about data loss will show up. Make sure data is backed up before recovery, and click on “Yes” to continue.



5. Wait till the recovery process to complete. During the recovery process, a command prompt will show up to indicate the percent of recovery process.

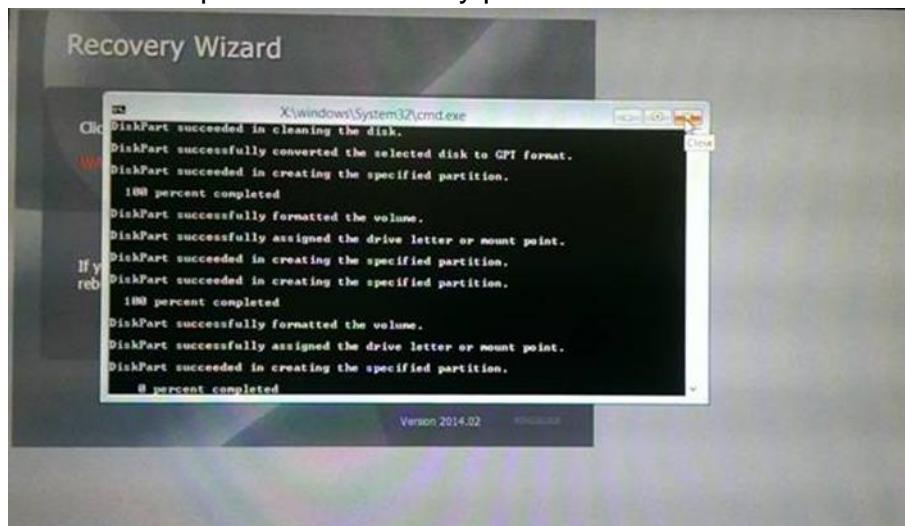

6. After recovery is completed, please press any key to continue, and the tablet computer will restart automatically.

## **Appendix**

This section contains additional product information.



## Appendix A: Troubleshooting

Problem	Solution
The removable battery is not charging.	<ul style="list-style-type: none"> <li>• Make sure the AC adapter is properly connected, and that the removable battery is properly inserted.</li> </ul>
Nothing appears on the screen.	<ul style="list-style-type: none"> <li>• The tablet computer may be in sleep mode. Press the power button to wake up the display.</li> <li>• The brightness level may be too low. Increase brightness.</li> </ul>
The screen suddenly turns blank and the power indicator goes off.	<ul style="list-style-type: none"> <li>• Make sure that LED indicator is not powered off in Winset.</li> <li>• Make sure the AC adapter is properly connected.</li> <li>• If running on battery power, the battery may be depleted, charge the battery.</li> </ul>
Wireless LAN signal quality is poor.	<ul style="list-style-type: none"> <li>• The tablet computer may be out of range. Move the tablet computer closer to the access point or another wireless LAN device associated with it.</li> <li>• Check if your surroundings have interferences, such as microwave ovens, cordless phones. Move the tablet computer away from objects causing interference.</li> </ul>
I cannot connect to another wireless LAN device.	<ul style="list-style-type: none"> <li>• Make sure that wireless LAN feature is powered on.</li> <li>• Make sure that the SSID setting is the same for every wireless LAN device in the network.</li> <li>• Restart the tablet computer</li> <li>• Make sure the IP address or subnet mask setting is correct.</li> </ul>
I cannot connect to another device with Bluetooth.	<ul style="list-style-type: none"> <li>• Make sure that both devices have Bluetooth powered on (For the Tablet Computer, check Winset to see if Bluetooth is powered on).</li> <li>• Make sure that the distance between the two devices is within 10 meters and there are no walls or large obstructions between the devices.</li> <li>• Make sure the both devices are powered on and configured to be discoverable.</li> <li>• Make sure that both devices are compatible.</li> </ul>
The GPS application cannot find my location.	<ul style="list-style-type: none"> <li>• Make sure that GPS is powered on in Winset.</li> <li>• Make sure that GPS receiver and the location sensor are enabled in Control Panel.</li> <li>• The tablet computer may be out of coverage area. Move your tablet computer outdoors or closer to a window.</li> <li>• Check if your surroundings have interferences, such as microwave ovens, cordless phones. Move the tablet computer away from objects causing interference.</li> </ul>
No sound is produced.	<ul style="list-style-type: none"> <li>• Adjust volume of the tablet computer by pressing on the volume rocker.</li> <li>• If using an external audio device, make sure that the cable is properly connected.</li> </ul>

Problem	Solution
<b>I cannot project the tablet computer display to another monitor.</b>	<ul style="list-style-type: none"> <li>• Make sure the VGA driver is installed.</li> <li>• Make sure the output setting selected is correct.</li> </ul>
<b>Barcode scanner does not emit laser beam and does not seem to work.</b>	<ul style="list-style-type: none"> <li>• Make sure the Barcode scanner device is enabled in Winset utility.</li> <li>• Make sure under Windows, the Barcode Reader is set to COM 15 port, so that Winset can trigger the Barcode Reader hardware.</li> </ul>
<b>Barcode Scanner emits laser beam but does not read barcode presented to it.</b>	<ul style="list-style-type: none"> <li>• Adjust the distance between barcode scanner of the device and the barcode being scanned.</li> <li>• Make sure the barcode code type is enabled in the tablet. To enable/disable a specific barcode code type, go through the "Barcode Scanner Configuration" section.</li> </ul>
<b>I am having GPS accuracy issue</b>	<ul style="list-style-type: none"> <li>• When utilizing the GPS function, we recommend disabling the Barcode Reader in Winset to reduce interference.</li> </ul>
<b>RFID scanner does not seem to work.</b>	<ul style="list-style-type: none"> <li>• Make sure under Windows, the RFID hardware is set to COM 3 port.</li> </ul>
<b>Battery leaking or swollen</b>	<ul style="list-style-type: none"> <li>• The lithium battery used in this tablet may swell after being charged/ discharged many times, but there is no problem regarding safety.</li> <li>• Continued use in such a state may result in the battery getting jammed, so please stop using the battery, and purchase a new one.</li> </ul>

## Appendix B: Technical Specification

<b>Model Name</b>		<b>M101BK</b>
<b>System Specifications</b>		
Processor	Intel® Quad-Core™ N2930 Bay Trail-M, 1.83GHz	
System Memory	4GB SODIMM DDR3L-1600 (up to 8GB)	
Storage	64GB M.2 SATA SSD (up to 256 GB)	
Operating System	Windows® 10 IoT Enterprise	
<b>Display Specifications</b>		
Size / Technology	8-inch LED backlight	
Resolution	1280 x 800	
Brightness	500 nits with optical bonding	
Contrast Ratio	800:1	
Number of Colors	24 bit RGB	
Touch	Multi-Touch Projective Capacitive, withstand repetitive typing, and scratch resistant throughout the life span	
<b>Wireless Communications</b>		
WLAN	802.11 a/b/g/n/ac	
Bluetooth	Bluetooth 4.0 Dual Mode	
GPS	GPS, Galileo	
WWAN	Optional 4G/ LTE	
<b>System I/O, Buttons and Indicator</b>		
Speaker	2 x Stereo Speaker (80dB output)	
Ethernet	Compliant with the 1 Gb/s Ethernet 802.3 specifications	
External I/O	1 x 30-pin Combo Conn for Giga-LAN or RS232, 1 x USB 3.0, 1 x 3.5 mm Audio Combo Conn. (Mic in or Line Out), 1 x Micro SD Card Slot, 1 x Micro HDMI, 1 x Power Jack	
Physical Keyboard	ISO/IEC 9995-3 QWERTY Keypad , IP65 water and dust proof, with LED backlight (keypad dimensions : min. 10x10mm)	
Physical Buttons	1 x Power, 10 x Function Keys	
LED Indicators	Power, Battery, HDD, RF	
<b>Data Capture</b>		
Camera	5MP Auto-Focus Camera with LED Flash at rear	
Barcode Reader	Optional short range 1D/2D Barcode Reader	
HF RFID	Optional HF RFID Reader	
UHF RFID	Optional UHF RFID Reader	

<b>Model Name</b>		<b>M101BK</b>
<b>Security Function</b>		
Security	Password security for user and hard disk lock Trusted Platform Module (TPM) V2.0 Kensington lock slot	
<b>Mechanical Specifications</b>		
Dimensions (W x L x H)	271.8 x 198.2 x 22 mm (10.7 x 7.80 x 0.87 inches)	
Weight	1.35 kg (3 lbs)	
<b>Environment Considerations</b>		
Operating Temperature	AC Mode: -20°C to 60°C (-4°F to 140°F), Battery Mode: -10°C to 50°C (32°F to 122°F), MIL-STD 810G Method 501.5 Procedure II, Method 502.5 Procedure II	
Storage Temperature	-30°C to 70°C (-22°F to 158°F), MIL-STD 810G Method 501.5 Procedure I, Method 502.5 Procedure I	
Humidity	10% to 90% RH, non-condensing, MIL-STD 810G Method 507.5 Procedure I	
IP Proof	P65, dustproof and waterproof	
Shock	MIL-STD-810G Method 516.6 Procedure I	
Vibration	MIL-STD-810G Method 514.6 Procedure I	
Drop	MIL-STD-810G Method 516.6 Procedure IV, 4 ft to concrete	
<b>Standards and Certifications</b>		
Safety	CE, FCC Part 2. 1092	
<b>Power Management</b>		
Power Input	19V DC	
Battery	7.4V, typ. 5140 mAh Li-Polymer Battery (2S1P) 7.4V, typ. 10280 mAh Li-Polymer Battery (2S2P, optional)	
Battery Operating Time	Operating Time Std. Battery: 6 hours High Capacity Battery: 12 hours (tested with MobileMark 2007)	
AC Adapter	100-240V, 50-60Hz / 19V DC	
AC Adapter Certificate	Compliant with the BS546, BS 546A, SANS 164-1, SABS 164-1 and IA16A3 standards	
Power Plug Type	BS 546 A Type M plug, 2 POLE-3 WIRE GROUNDING (2P+E), Power Rating: 15A - 16A 250	

1. Total usable memory will be less depending upon actual system configuration.
2. 1D/2D Barcode Reader and HF RFID Reader are mutually exclusive options.
3. Length measurements do not include protrusions. Weight varies with options.
4. The drop test with high-capacity battery must come with hand strap.
5. Measured at dimming LCD brightness. Varies depending on the usage conditions, or when an external device is attached.



## Appendix C: Order Information

M101BK is available in the following configurations:

Order Information					
	4G	1D/2D Barcode Reader	HF RFID	UHF RFID	Smart Card Reader
M101BK	N/A	N/A	N/A	N/A	N/A
M101BK-LE	4G/LTE for Europe	Optional	Optional	Optional	N/A
M101BK-LA	4G/LTE for North America	Optional	Optional	Optional	N/A
M101BK-BH	Optional	Default	N/A	N/A	N/A
M101BK-BT	Optional	Optional	N/A	N/A	Default
M101BK-HF	Optional	N/A	Default	N/A	N/A
M101BK-UF	Optional	N/A	N/A	Default	N/A

*\*Barcode and RFID are mutually exclusive options.*





