

EPS-KBLHE

Fanless Intel® 7th Generation Core™ i7/ i5/ i3 Rugged
Embedded System with Intel® QM175 Chipset

Quick Reference Guide

3rd Ed – 03 October 2018

Copyright Notice

Copyright © 2018 Avalue Technology Inc., ALL RIGHTS RESERVED.

Part No. E2017DAJ0A2R

FCC Statement



THIS DEVICE COMPLIES WITH PART 15 FCC RULES. OPERATION IS SUBJECT TO THE FOLLOWING TWO CONDITIONS:

(1) THIS DEVICE MAY NOT CAUSE HARMFUL INTERFERENCE.

(2) THIS DEVICE MUST ACCEPT ANY INTERFERENCE RECEIVED INCLUDING INTERFERENCE THAT MAY CAUSE UNDESIRE OPERATION.

THIS EQUIPMENT HAS BEEN TESTED AND FOUND TO COMPLY WITH THE LIMITS FOR A CLASS "A" DIGITAL DEVICE, PURSUANT TO PART 15 OF THE FCC RULES.

THESE LIMITS ARE DESIGNED TO PROVIDE REASONABLE PROTECTION AGAINST HARMFUL INTERFERENCE WHEN THE EQUIPMENT IS OPERATED IN A COMMERCIAL ENVIRONMENT. THIS EQUIPMENT GENERATES, USES, AND CAN RADIATE RADIO FREQUENCY ENERGY AND, IF NOT INSTALLED AND USED IN ACCORDANCE WITH THE INSTRUCTION MANUAL, MAY CAUSE HARMFUL INTERFERENCE TO RADIO COMMUNICATIONS.

OPERATION OF THIS EQUIPMENT IN A RESIDENTIAL AREA IS LIKELY TO CAUSE HARMFUL INTERFERENCE IN WHICH CASE THE USER WILL BE REQUIRED TO CORRECT THE INTERFERENCE AT HIS OWN EXPENSE.

A Message to the Customer

Avalue Customer Services

Each and every Avalue's product is built to the most exacting specifications to ensure reliable performance in the harsh and demanding conditions typical of industrial environments. Whether your new Avalue device is destined for the laboratory or the factory floor, you can be assured that your product will provide the reliability and ease of operation for which the name Avalue has come to be known.

Your satisfaction is our primary concern. Here is a guide to Avalue's customer services. To ensure you get the full benefit of our services, please follow the instructions below carefully.

Technical Support

We want you to get the maximum performance from your products. So if you run into technical difficulties, we are here to help. For the most frequently asked questions, you can easily find answers in your product documentation. These answers are normally a lot more detailed than the ones we can give over the phone. So please consult the user's manual first.

To receive the latest version of the user's manual; please visit our Web site at:

<http://www.avalue.com.tw/>

Content

1.	Getting Started.....	6
1.1	Safety Precautions	6
1.2	EPS-KBLHE Packing List	6
1.3	ECM-KBLH Packing List.....	7
1.3	EPS-KBLHE System Specifications	8
1.4	ECM-KBLH System Specifications	10
1.5	System Overview.....	12
1.5.1	Front View	12
1.5.2	Rear View.....	12
1.6	System Dimensions.....	14
1.6.1	Front & Top view	14
2.	Hardware Configuration.....	15
2.1	EPS-KBLHE connector mapping	16
2.1.1	Serial Port 1 connector (COM1).....	16
2.1.2	Serial Port 2 connector (COM2).....	16
2.2	ECM-KBLH Overviews	17
2.3	ECM-KBLHE Jumper & Connector list	19
2.4	ECM-KBLH Jumpers & Connectors settings	21
2.4.1	Clear CMOS (JCMOS).....	21
2.4.2	Serial port 1 pin9 signal select (JRI)	21
2.4.3	AT/ATX Input power select (JAT)	22
2.4.4	LCD backlight brightness adjustment (JVR)	22
2.4.5	LCD Inverter connector (JBKL).....	23
2.4.6	CPU fan connector (CPU_FAN)	23
2.4.7	System fan connector (SYS_FAN)	24
2.4.8	Serial port 2 connector (JCOM2)	24
2.4.9	Serial port 2 in RS-422/485 mode (J422_485)	25
2.4.10	General purpose I/O connector (JDIO).....	25
2.4.11	SATA Power connector 1/2 (SATAPW1/2)	26
2.4.12	Power connector (PWR).....	26
2.4.13	On-board header for USB2.0 (JUSB).....	27
2.4.14	LPC connector (JLPC).....	27
2.4.15	LVDS connector (JLVDS).....	28
2.4.16	Miscellaneous setting connector (JFP)	29
2.4.17	SPI connector (JSPI)	29

EPS-KBLHE

2.4.18	Battery connector (JBAT)	30
2.4.19	Audio connector (JAUDIO)	30
2.4.19.1	Signal Description – Audio connector (JAUDIO).....	30
2.5	Installing Hard Disk (EPS-KBLHE)	31
3	BIOS Setup.....	32
3.1	Introduction.....	33
3.2	Starting Setup.....	33
3.3	Using Setup	34
3.4	Getting Help.....	35
3.5	In Case of Problems	35
3.6	BIOS setup	36
3.6.1	Main Menu	36
3.6.1.1	System Language.....	37
3.6.1.2	System Date	37
3.6.1.3	System Time.....	37
3.6.2	Advanced Menu	38
3.6.2.1	CPU Configuration	38
3.6.2.2	Power & Performance.....	39
3.6.2.2.1	CPU – Power Management Control.....	39
3.6.2.2.1.1	View/Configure Turbo Options.....	40
3.6.2.2.2	GT – Power Management Control	42
3.6.2.3	PCH-FW Configuration	43
3.6.2.3.1	AMT Configuration	43
3.6.2.3.1.1	CIRA Configuration.....	44
3.6.2.3.1.2	ASF Configuration	44
3.6.2.3.1.3	Secure Erase Configuration	45
3.6.2.3.1.4	OEM Flags Settings.....	46
3.6.2.3.1.5	MEBx Resolution Settings	47
3.6.2.3.2	Firmware Update Configuration	48
3.6.2.3.3	PTT Configuration.....	48
3.6.2.4	Trusted Computing	49
3.6.2.5	APCI Settings	50
3.6.2.6	IT8528 Super IO Configuration	51
3.6.2.6.1	Serial Port 1 Configuration.....	52
3.6.2.6.2	Serial Port 2 Configuration.....	52
3.6.2.7	HW Monitor.....	53
3.6.2.7.1	Smart Fan Mode Configuration	53
3.6.2.8	S5 RTC Wake Settings	54
3.6.2.9	Serial Port Console Redirection	56
3.6.2.9.1	Legacy Console Redirection Settings	57

4 EPS-KBLHE Quick Reference Guide

3.6.2.9.2	Console Redirection Settings.....	57
3.6.2.10	Intel TXT Configuration	58
3.6.2.11	Network Stack Configuration	59
3.6.2.12	CSM Configuration.....	60
3.6.2.13	NVMe Configuration.....	62
3.6.2.14	USB Configuration	62
3.6.3	Chipset	64
3.6.3.1	System Agent (SA) Configuration	64
3.6.3.1.1	Graphics Configuration	65
3.6.3.1.1.1	LCD Control.....	65
3.6.3.2	PCH-IO Configuration	66
3.6.3.2.1	PCI Express Configuration.....	67
3.6.3.2.1.1	PCI Express Root Port 6	67
3.6.3.2.1.2	PCI Express Root Port 15	68
3.6.3.2.1.3	PCI Express Root Port 16	69
3.6.3.2.2	SATA And RST Configuration.....	70
3.6.3.2.3	USB Configuration	72
3.6.3.2.4	HD Audio Configuration	72
3.6.4	Security	73
3.6.4.1	Secure Boot.....	74
3.6.4.1.1	Key Management.....	74
3.6.5	Boot.....	75
3.6.6	Save and exit	76
3.6.6.1	Save Changes and Reset.....	76
3.6.6.2	Discard Changes and Reset.....	76
3.6.6.3	Restore Defaults	76
3.6.6.4	Launch EFI Shell from filesystem device	76
4.	Drivers Installation	77
4.1	Install Chipset Driver	78
4.2	Install Display Driver.....	79
4.3	Install LAN Driver (For Intel I219LM)	80
4.4	Install ME Driver.....	81
4.5	Install Serial IO Driver	82
4.6	Install Audio Driver (For Realtek ALC233)	83

1. Getting Started

1.1 Safety Precautions

Warning!



Always completely disconnect the power cord from your chassis whenever you work with the hardware. Do not make connections while the power is on. Sensitive electronic components can be damaged by sudden power surges. Only experienced electronics personnel should open the PC chassis.

Caution!



Always ground yourself to remove any static charge before touching the CPU card. Modern electronic devices are very sensitive to static electric charges. As a safety precaution, use a grounding wrist strap at all times. Place all electronic components in a static-dissipative surface or static-shielded bag when they are not in the chassis.

1.2 EPS-KBLHE Packing List

- 1 x EPS-KBLHE Fanless Intel® 7th Generation Core™ i7/ i5/ i3 Rugged Embedded System with Intel® QM175 Chipset
- 1 x DVD-ROM contains the followings:
 - QRG in PDF file
 - Ethernet driver and utilities
 - Video drivers and utilities
 - Audio drivers and utilities
 - Chipset drivers and utilities
- Other major components include the followings:
 - Screw kit
 - Adapter
 - Power Cord
 - Wall Mount Kit



If any of the above items is damaged or missing, contact your retailer.

1.3 ECM-KBLH Packing List

- 1 x 3.5" ECM-KBLH Micro Module
- 1 x DVD-ROM contains the followings:
 - User's Manual (this manual in PDF file)
 - Ethernet driver and utilities
 - Video drivers and utilities
 - Audio drivers and utilities
- 1 x Cable set contains the followings:
 - 1 x Audio cable (12pin, 2.0 pitch)
 - 1 x USB 2.0 cable (10P/2.0mm-10P/2.0mm)
 - 1 x Serial ATA cable (7-pin, standard)
 - 1 x Wire SATA power cable (15-pin, 4P/2.5mm)
 - 1 x Flat Cable 9P(M)-PHD (10P/2.0mm)
- 3M foam (VHB-4622 10mm*20mm*1.1mm)



If any of the above items is damaged or missing, contact your retailer.

1.3 EPS-KBLHE System Specifications

System	
CPU	Onboard 7th generation Intel® Kabylake H Processor 45W/35W
BIOS	AMI uEFI BIOS, 128 Mbit SPI Flash ROM iAMT supported
System Chipset	Intel® Skylake PCH (SPT) QM175 Corp
I/O Chipset	EC ITE IT8528E
System Memory	1 x 260-Pin DDR4 2400MTs SO-DIMM
Watchdog Timer	H/W Reset, 1sec. – 65535sec./min. 1sec. step
Battery	Wide Temperature RTC Battery
Expansion	1 x mini PCIe socket(with mSATA supported), 1 x M.2 B-Key (SSD Only)
Storage	
Combination	2 x 2.5" Drive Bay 1 x M.2(B-Key) 1 x mSATA
Front I/O	
USB Port	2 x USB 2.0
Rear I/O	
Serial Port	2 x COM (1 x RS-232, 1 x RS-232/422/485, 485 supports auto-flow)
USB Port	4 x USB 3.0
Others	2 x Knockouts for Antenna Mounting
Display	
Chipset	Intel® Kabylake Processor integrated Graphics
Resolution	2 x HDMI1.4 : 4096 x 2160@24Hz
Multiple Display	Dual display
Ethernet	
Chipset	1 x Intel I210AT GbE controller 1 x Intel I219LM Gigabit Ethernet PHY
Ethernet Interface	10/100/1000 Base-Tx compatible
Lan Port	2 x RJ45 w/LED
Audio	
Chipset	Realtek ALC233 HD codec Supports 2.1-CH Audio
Audio Interface	Line-Out ,Line-In, Mic-In
Audio Amp.	Internal 2W AMP.
Mechanical & Environmental	
Power Connector	Lockable DC Jack

Quick Reference Guide

Power Requirement	DC +12V(Default), DC +9 ~ 36V with Phonix head(Factory option)
Power Type	AT/ATX (ATX is default)
ACPI	Single power ATX Support S0, S3, S4, S5 ACPI 5.0 Compliant
Dimension	240 x 230 x 72 mm
Weight	TBD KG
Color	Black & Blue
Mounting Kit	Wall mount kit is the standard accessory
Reliability	
Vibration Test	With SSD/mSATA : 5Grms, IEC 60068-2-64, Random, 10 ~ 500Hz, 1hr/axis With HDD : 0.5Grms, IEC 60068-2-64, Random, 10 ~ 500Hz, 1hr/axis
Mechanical Shock Test	With SSD/mSATA : 50G, IEC 60068-2-27, Half Sine, 11ms With HDD : 10G, IEC 60068-2-27, Half Sine, 11ms
Drop Test	Avalue Standard Test Criteria
Operating Temperature	-10°C ~ 50°C (w/SSD, mSATA) ambient w/ air flow(i7/i5) -10°C ~ 60°C (w/SSD, mSATA) ambient w/ air flow(i3)
Operating Humidity	5% ~ 90% relative humidity, non-condensing
Weight	4.5Kg
Storage Temperature	-40°C ~ 75°C
Certification	CE, FCC Class B
OS Supported	Win 10



Note: Specifications are subject to change without notice.

1.4 ECM-KBLH System Specifications

System	
CPU	Onboard 7th generation Intel® Kabylake H Processor 45W/35W/25W
BIOS	AMI uEFO BIOS, 128 Mbit SPI Flash ROM iAMT supported
System Chipset	Intel® Skylake PCH (SPT) QM175 Corp
I/O Chip	EC(IT8528E)
System Memory	1 x 260-Pin DDR4 2400MTs SO-DIMM
SSD	1 x M.2(2242) SSD (B key) mSATA from MiniPCIe
Watchdog Timer	H/W Reset, 1sec. - 65535sec./min. 1sec. or 1min. step
H/W Status Monitor	Monitoring System Temperature, Voltage and FAN Status with Auto Throttling Control
Expansion	1 x Full-Size Mini PCI Express Mini Card with mSATA supported
Built-in Touch screen (optional)	EETI ETP-CP-MER4485XRU With 5-pin 2.0mm Box Header (Can be Selected to Support 4/ 5Wire Touch Screen)
I/O	
MIO	2 x SATA III, 1 x RS232 (COM1) 1 x RS232/422/485 COM2, LPC, SPI
USB	4 x USB3.0(dual deck USB connector for 2 USB3.0 port) , 2 x USB 2.0(Wafer)
GPIO	8-bit GPIO
Display	
Chipset	Intel® Kabylake Processor integrated Graphics
Resolution	LVDS: 1920 x 1200@60Hz 2 x HDMI: 4096 x 2160@24Hz
Multiple Display	Triple display
HDMI	HDMI 1.4
LCD Interface	Dual channel 18/24-bit LVDS (via 7511B)
Audio	
AC97 Codec	Realtek ALC233 HD codec Supports 2.1-CH Audio
Audio Amp	Internal 2W AMP.
Ethernet	
LAN Chip	1 x Intel I210AT GbE controller 1 x Intel I219LM Gigabit Ethernet PHY
Ethernet Interface	10/100/1000 Base-Tx compatible

Internal I/O Connectors	
CMOS Battery	CR2032
Audio	Line in ,Line-Out, Mic in
COM	1 x RS232 (COM1) /1 x RS232/422/485 (COM2)
Rear I/O Connectors	
USB	4 x USB3.0
LAN	2 x Ethernet
HDMI	2 x HDMI
LED	Front Panel LED Connector (for system use)
Mechanical & Environmental	
Power Requirement	+12V
ACPI	Single power ATX Support S0, S3, S4, S5 ACPI 5.0 Compliant
Power Type	AT/ATX
Operating Temp.	0°C ~ 60°C
Storage Temp.	-40°C ~ 75°C
Operating Humidity	0% ~ 90% relative humidity, non-condensing
Size (L x W)	5.7" x 4" (146mm x 101mm)
Weight	0.44 lbs (0.2 Kg)
OS Support	Win 10 / Linux



Note: Specifications are subject to change without notice.

1.5 System Overview

1.5.1 Front View

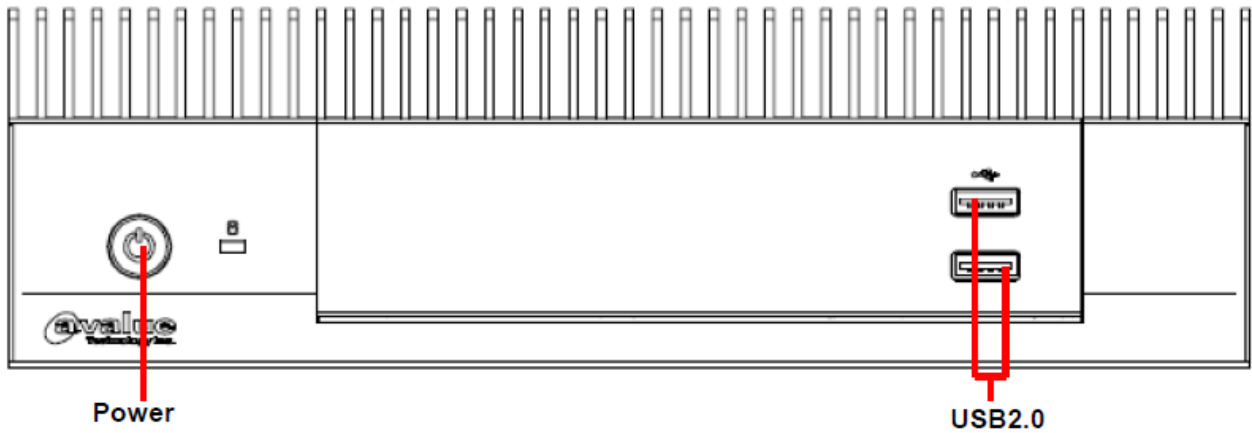

1.5.2 Rear View

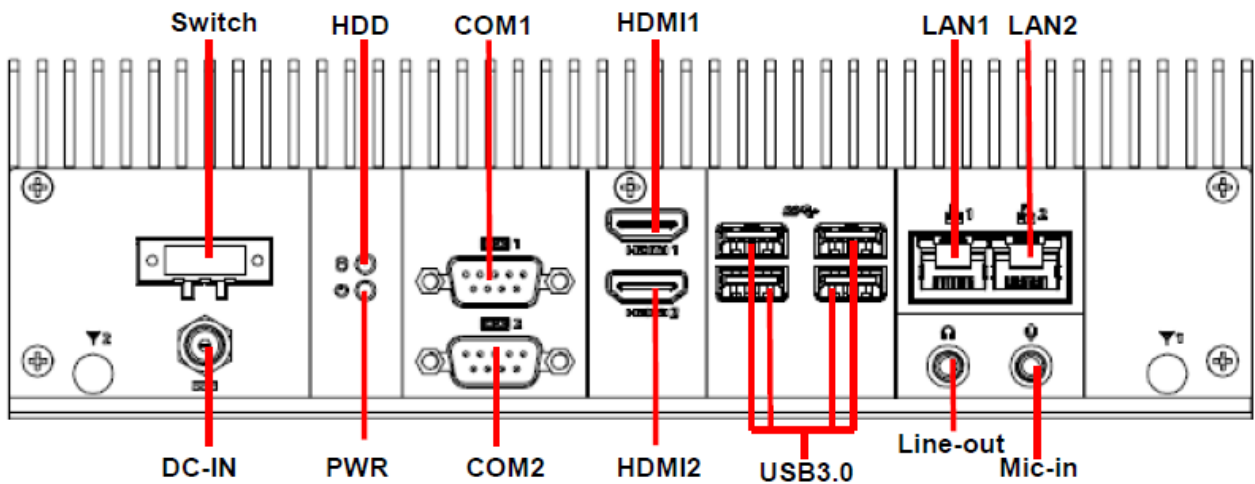

Connectors

Label	Function	Note
Power	Power on button	
USB2.0	USB 2.0 connector x 2	
USB3.0	USB 3.0 connector x 4	
COM1/2	Serial port 1/2 connector	
DC-IN	DC power-in connector	
LAN1/2	RJ-45 Ethernet 1/2	
HDMI1/2	HDMI connector 1/2	
DC-IN	DC Power-in connector	

HDD	HDD indicator
PWR	System power indicator
Switch	Power switch
Mic-in	Mic-in audio jack
Line-out	Line-out audio jack

1.6 System Dimensions

1.6.1 Front & Top view

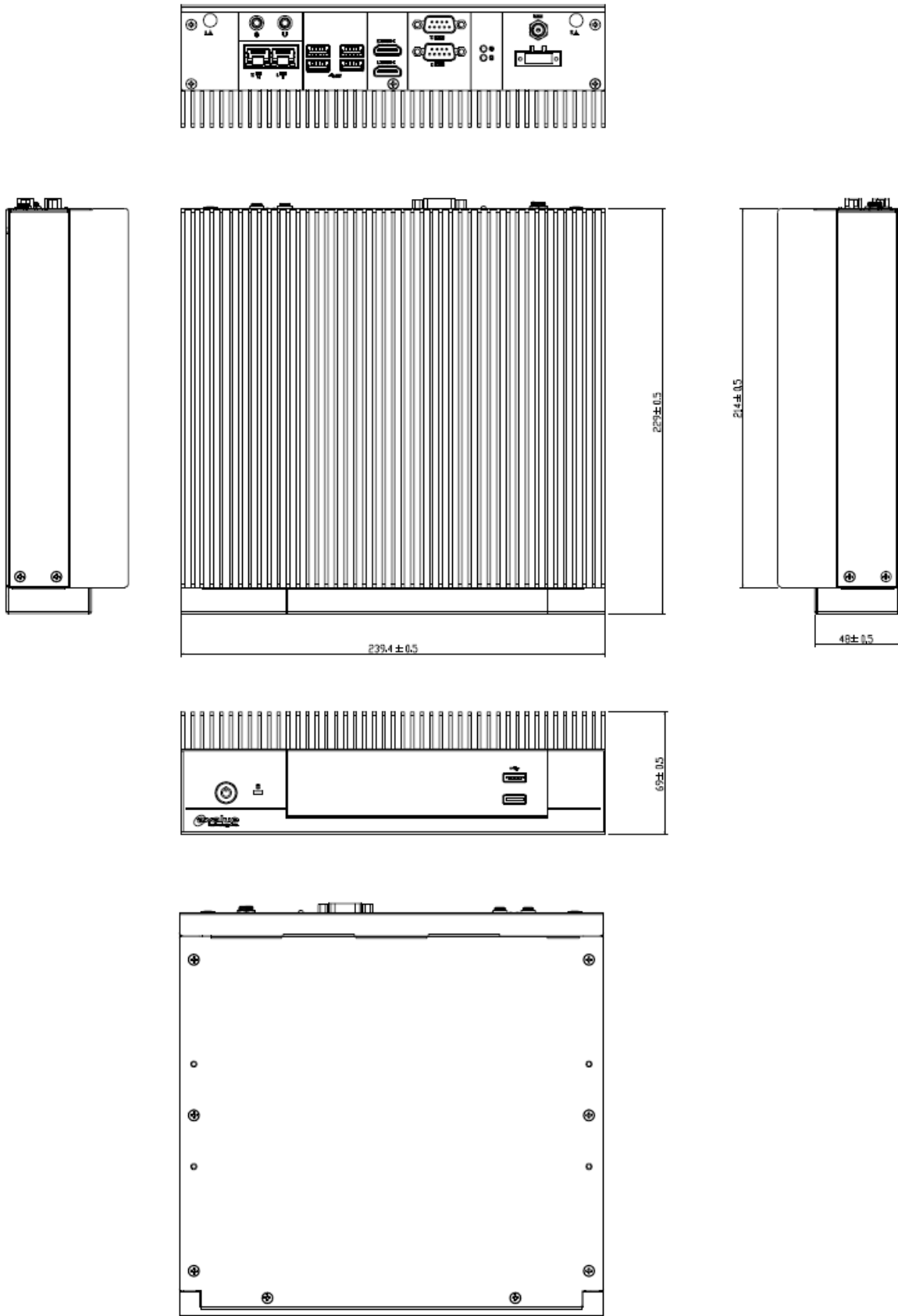

(Unit: mm)

2. Hardware Configuration

Jumper and Connector Setting, Driver and BIOS Installing

For advanced information, please refer to:

- 1- ECM-KBLH included in this manual.



Note: If you need more information, please visit our website:

<http://www.avalue.com.tw>

2.1 EPS-KBLHE connector mapping

2.1.1 Serial Port 1 connector (COM1)

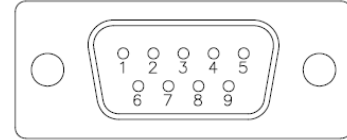
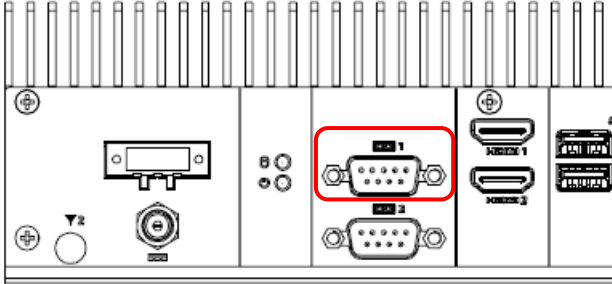

Signal	PIN	PIN	Signal
DCD#	1	6	DSR#
RXD	2	7	RTS#
TXD	3	8	CTS#
DTR#	4	9	RI#
GND	5		

2.1.2 Serial Port 2 connector (COM2)

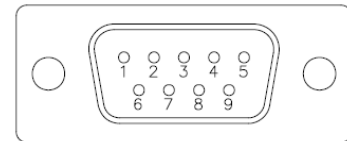
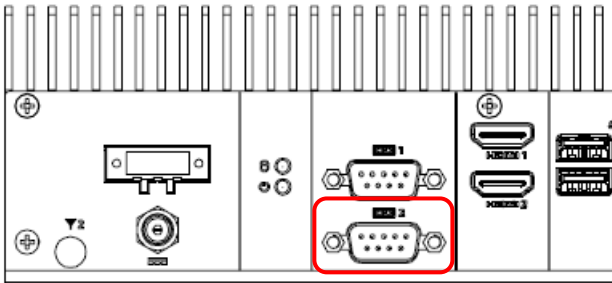

RS-485

Signal	PIN	PIN	Signal
485_Tx-	1	6	NC
485_Tx+	2	7	NC
NC	3	8	NC
NC	4	9	NC
GND	5		

RS-232

Signal	PIN	PIN	Signal
DCD#	1	6	DSR#
RXD	2	7	RTS#
TXD	3	8	CTS#
DTR#	4	9	RI#
GND	5		

RS-422

Signal	PIN	PIN	Signal
422_Tx-	1	6	NC
422_Tx+	2	7	NC
422_Rx+	3	8	NC
422_Rx-	4	9	NC
GND	5		

2.2 ECM-KBLH Overviews

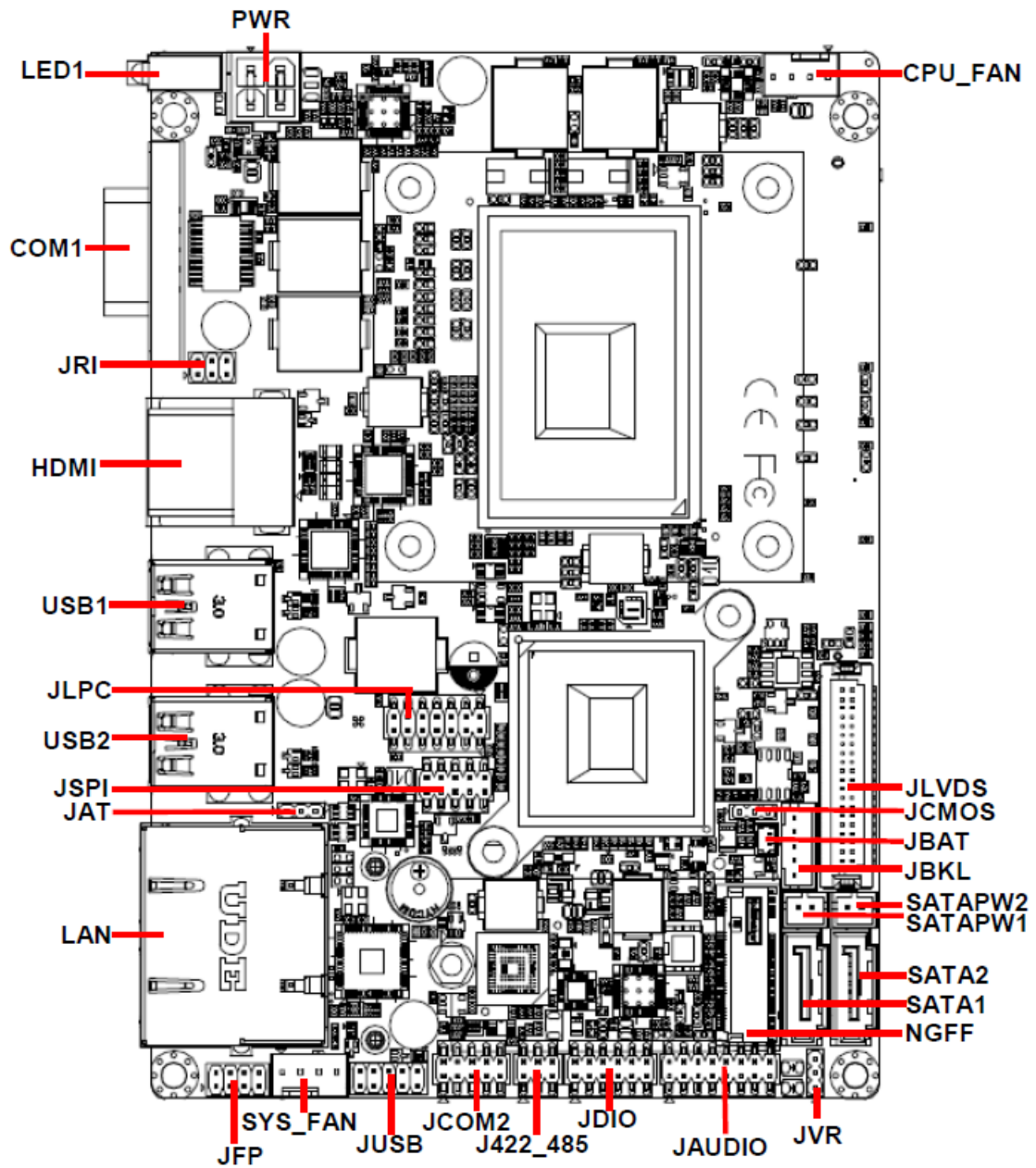

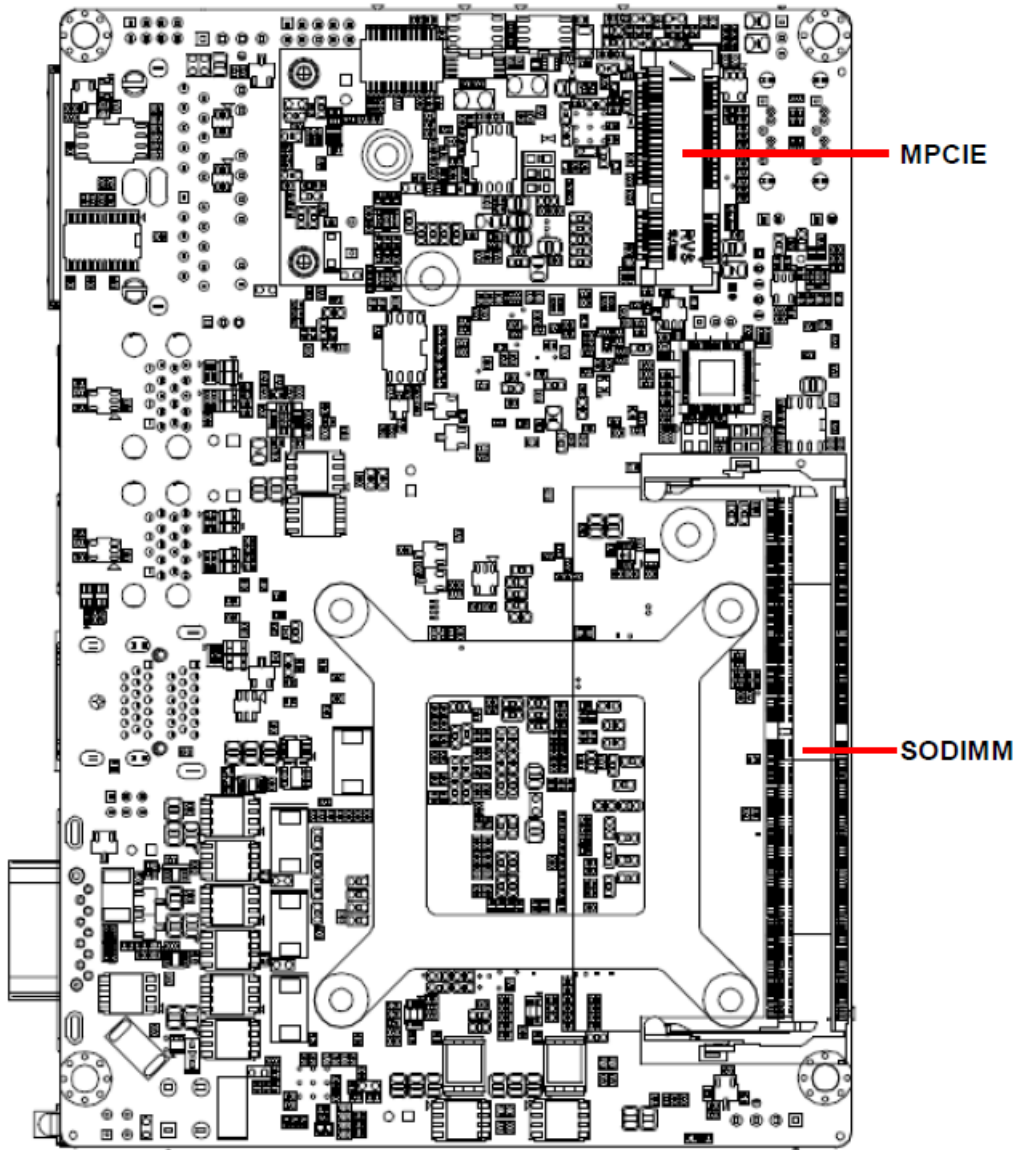

2.3 ECM-KBLHE Jumper & Connector list

Jumpers

Label	Function	Note
JCMOS	Clear CMOS	3 x 1 header, pitch 2.54mm
JRI	Serial port 1 pin9 signal select	3 x 2 header, pitch 2.00 mm
JAT	AT/ATX Input power select	3 x 1 header, pitch 2.00 mm
JVR	LCD backlight brightness adjustment	3 x 1 header, pitch 2.00 mm

Connectors

Label	Function	Note
JBAT	Battery connector	2 x 1 wafer, pitch 1.25 mm
CPU_FAN	CPU fan connector	4 x 1 wafer, pitch 2.54 mm
SYS_FAN	System fan connector	4 x 1 wafer, pitch 2.54mm
JAUDIO	Audio connector	8 x 2 header, pitch 2.00 mm
JBKL	LCD inverter connector	5 x 1 wafer, pitch 2.00 mm Matching Connector: JST PHR-5
J422_485	Serial port 2 in RS-422/485 mode	3 x 2 header, pitch 2.00 mm
COM1	Serial port 1 connector	D-sub 9-pin, male
JCOM2	Serial port 2 connector	5 x 2 header, pitch 2.00 mm
JDIO	General purpose I/O connector	6 x 2 header, pitch 2.00 mm
JFP	Miscellaneous setting connector	4 x 2 header, pitch 2.00 mm
JLPC	LPC connector	7 x 2 header, pitch 2.00 mm
JLVDS	LVDS connector	20 x 2 header, pitch 1.25 mm Matching Connector: Hirose DF13-40DS-1.25C
JSPI	SPI connector	5 x 2 header, pitch 2.00mm
USB1/2	On-board connector for USB3.0 x 4	
JUSB	On-board header for USB2.0	5 x 2 header, pitch 2.00 mm
HDMI	DUAL HDMI connector	
LAN	RJ-45 Ethernet x 2	
LED1	HDD/Power LED indicator	
PWR	Power connector	2 x 2 wafer, pitch 4.20 mm
SATAPW1/2	SATA power connector 1/2	2 x 1 wafer, pitch 2.00 mm
SATA1/2	Serial ATA connector 1/2	

EPS-KBLHE

NGFF	M.2 KEY-B 2242 connector
MPCIE	Full size Mini-PCI-e connector
SODIMM	DDR4 SODIMM socket

2.4 ECM-KBLH Jumpers & Connectors settings

2.4.1 Clear CMOS (JCMOS)

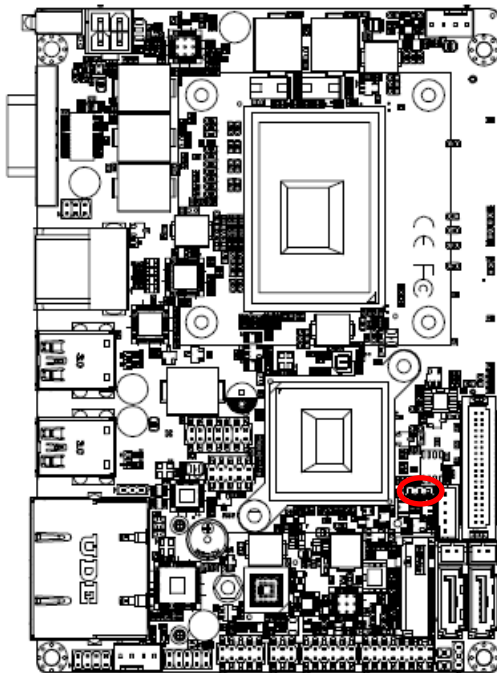

Protect*

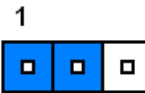

Clear CMOS

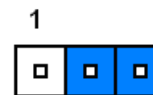

* Default

2.4.2 Serial port 1 pin9 signal select (JRI)

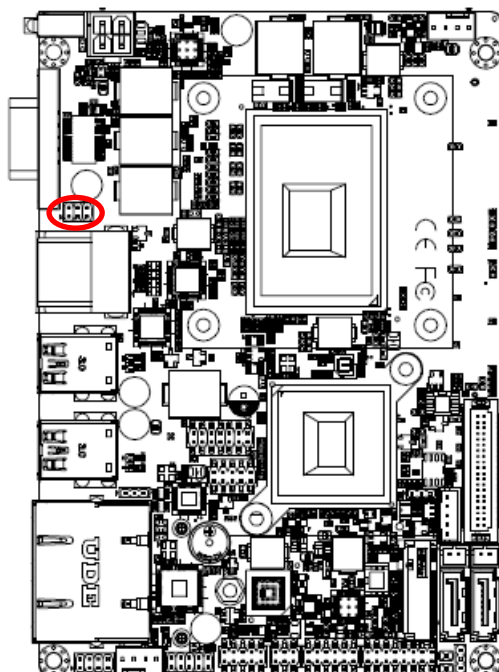

Ring*

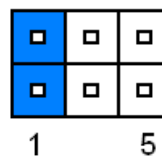

+5V

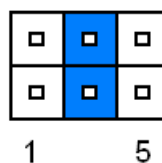

+12V

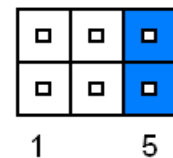

* Default

2.4.3 AT/ATX Input power select (JAT)

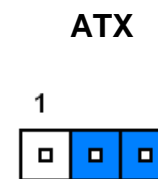
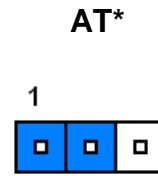
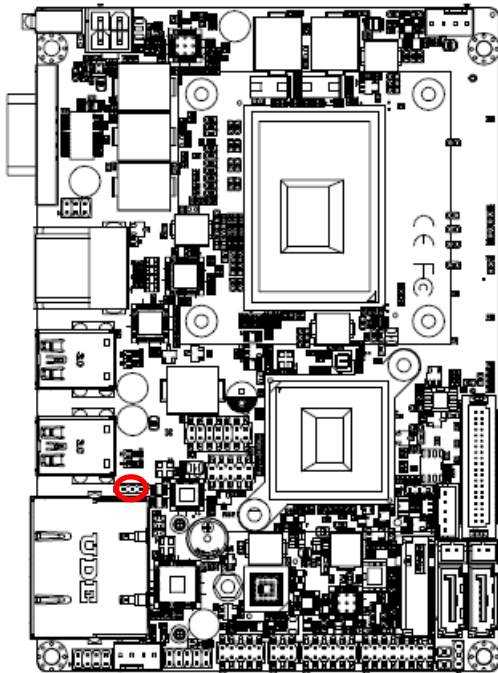

2.4.4 LCD backlight brightness adjustment (JVR)

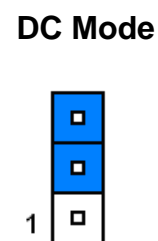
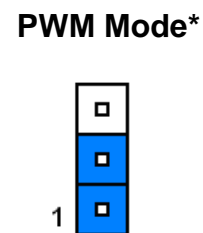
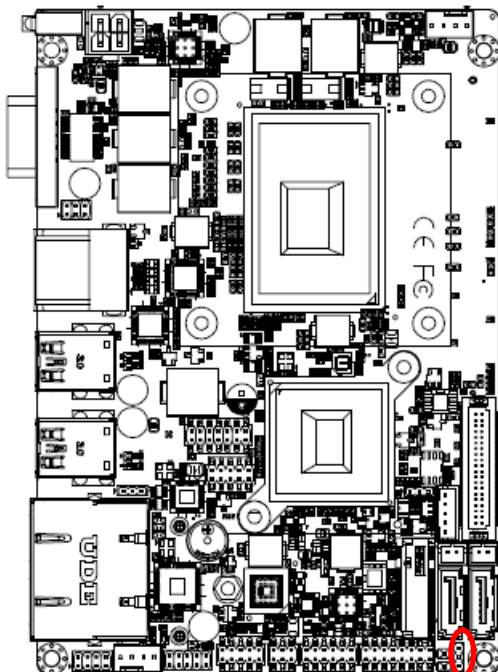

* Default

2.4.5 LCD Inverter connector (JBKL)

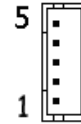
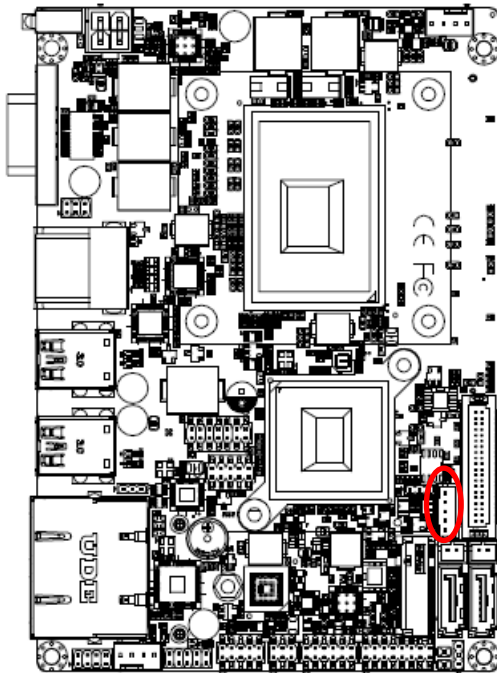

Signal	PIN
+5V	5
VBRIGHT	4
BKLEN	3
GND	2
+12V	1

2.4.6 CPU fan connector (CPU_FAN)

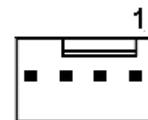
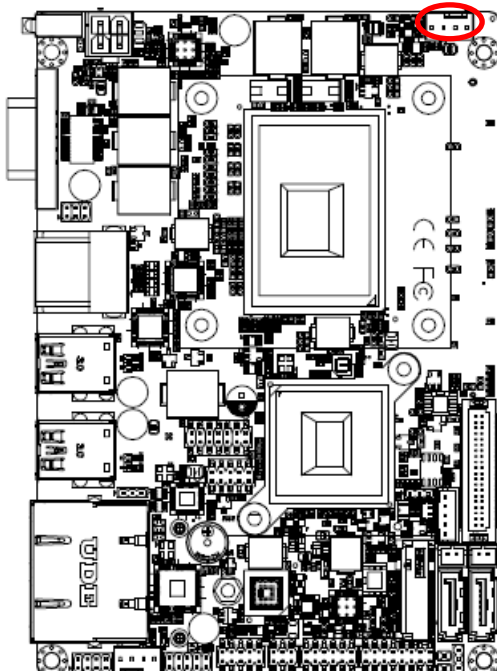

Signal	PIN
GND	1
+12V	2
EC_TACH0	3
FAN_PWM0	4

2.4.7 System fan connector (SYS_FAN)

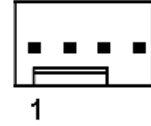
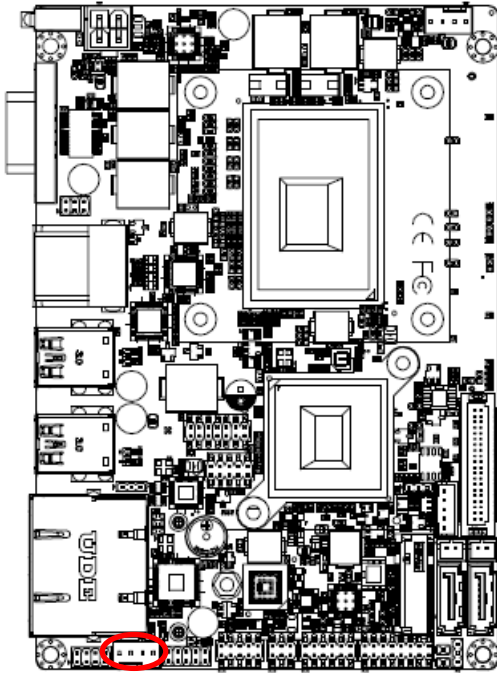

Signal	PIN
GND	1
+12V	2
EC_TACH1	3
FAN_PWM1	4

2.4.8 Serial port 2 connector (JCOM2)

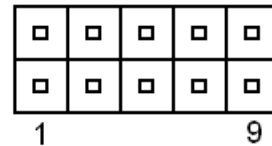
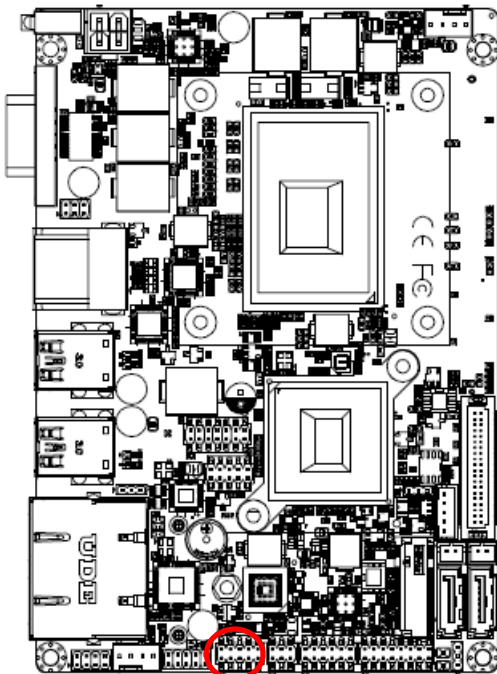

Signal	PIN	PIN	Signal
COM_DCD#_1	1	2	COM_RXD#_1
COM_TXD_1	3	4	COM_DTR#_1
GND	5	6	COM_DSR#_1
COM_RTS#_1	7	8	COM_CTS#_1
COM_RI#_1	9	10	NC

2.4.9 Serial port 2 in RS-422/485 mode (J422_485)

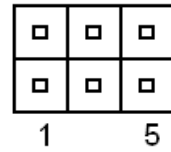
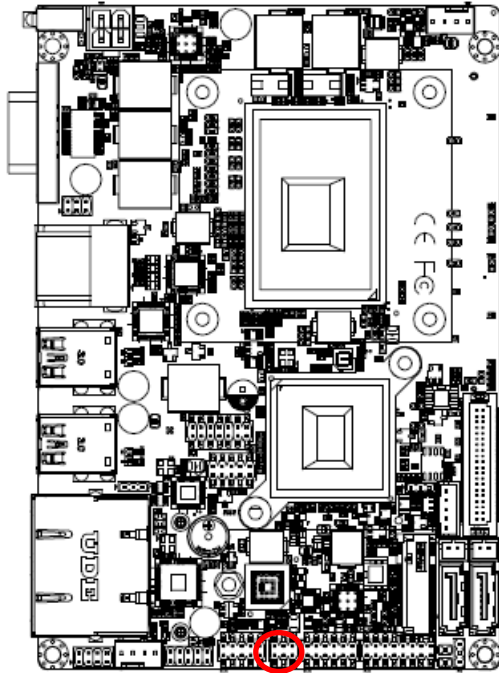

Signal	PIN	PIN	Signal
485-422_TXDN	1	2	422_RXDN
485-422_TXDP	3	4	422_RXDP
+5V	5	6	GND

2.4.10 General purpose I/O connector (JDIO)

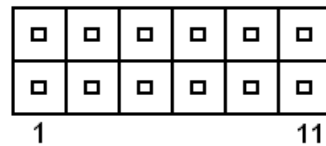
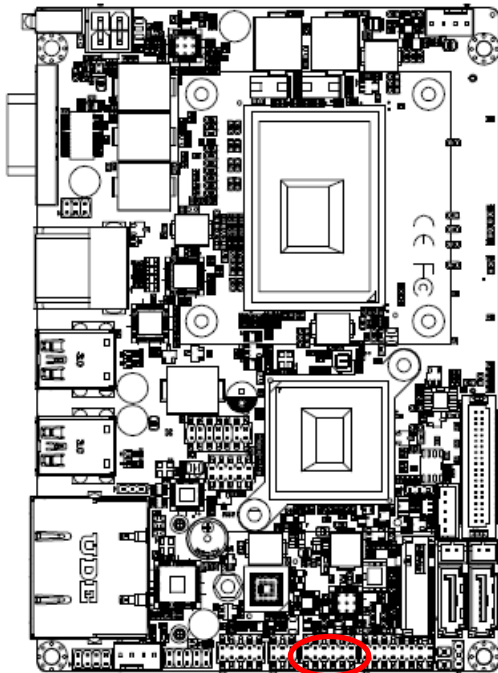

Signal	PIN	PIN	Signal
DIO_GP10	1	2	DIO_GP20
DIO_GP11	3	4	DIO_GP21
DIO_GP12	5	6	DIO_GP22
DIO_GP13	7	8	DIO_GP23
SMB_CLK_VCC	9	10	SMB_DATA_VCC
GND	11	12	+5V

2.4.11 SATA Power connector 1/2 (SATAPW1/2)

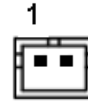
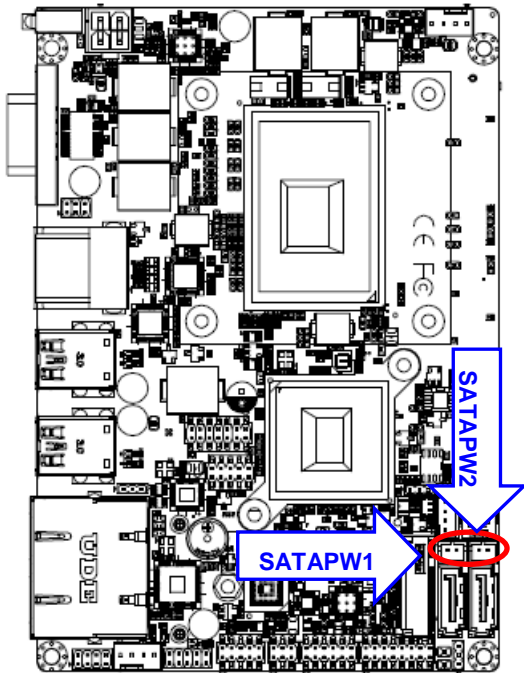

Signal	PIN
GND	1
SATA_PWR1	2

2.4.12 Power connector (PWR)

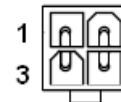
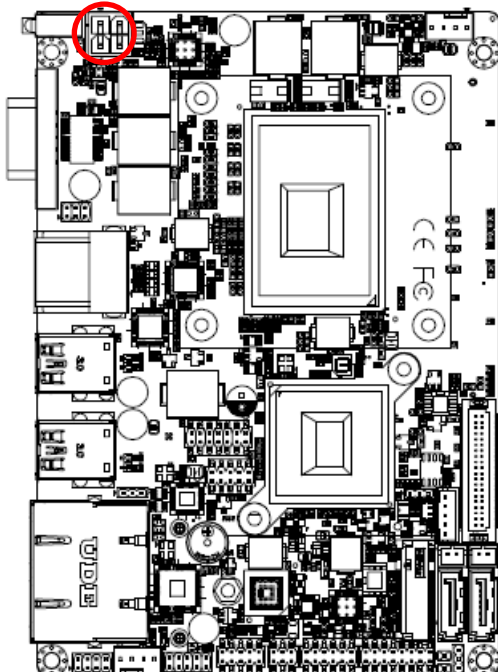

Signal	PIN	PIN	Signal
GND	1	2	GND
+12V	3	4	+12V

2.4.13 On-board header for USB2.0 (JUSB)

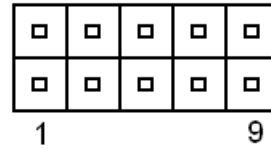
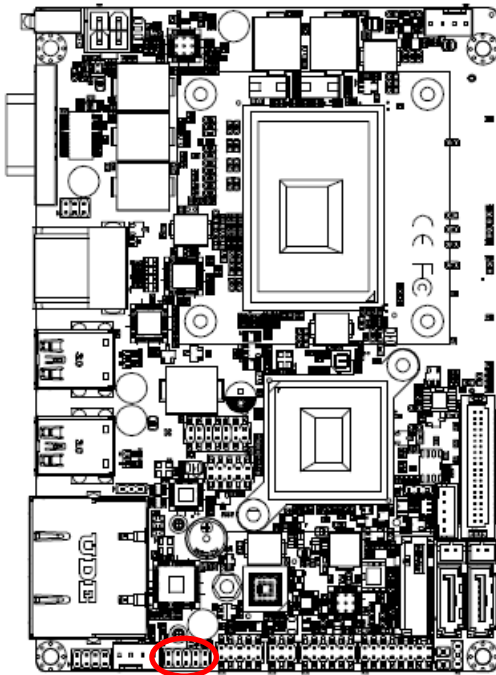

Signal	PIN	PIN	Signal
+5VSB	1	2	GND
USB_DN4	3	4	GND
USB_DP4	5	6	USB_DP5
GND	7	8	USB_DN5
GND	9	10	+5VSB

2.4.14 LPC connector (JLPC)

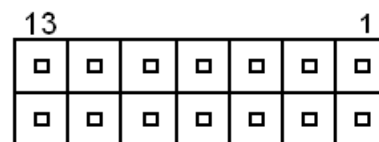
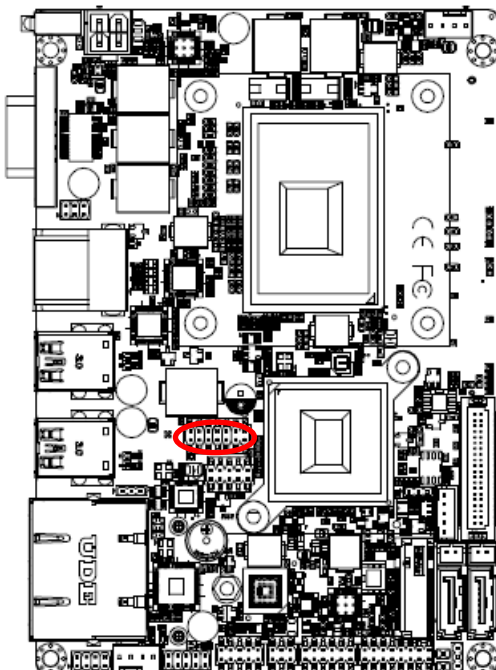

Signal	PIN	PIN	Signal
LPC_AD0	1	2	+3.3V
LPC_AD1	3	4	PLTRST#
LPC_AD	5	6	LPC_LFRAME#
LPC_AD03	7	8	CLK_PCI_JLPC
SERIRQ	9	10	GND
+5V	11	12	GND
+5VSB	13	14	GND

2.4.15 LVDS connector (JLVDS)

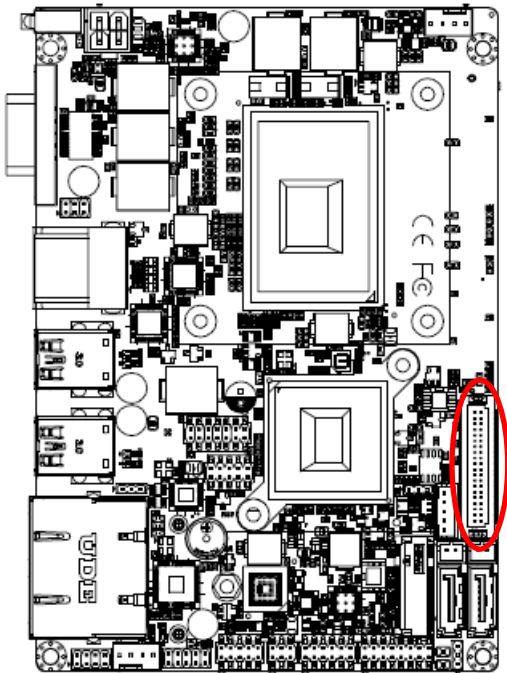

Signal	PIN	PIN	Signal
+12V	39	40	+12V
GND	37	38	GND
LVDS_CLK2_N	35	36	LVDS_CLK1_N
LVDS_CLK2_P	33	34	LVDS_CLK1_P
GND	31	32	GND
LVDS_DATA7_N	29	30	LVDS_DATA6_N
LVDS_DATA7_P	27	28	LVDS_DATA6_P
GND	25	26	GND
LVDS_DATA5_N	23	24	LVDS_DATA4_N
LVDS_DATA5_P	21	22	LVDS_DATA4_P
GND	19	20	GND
LVDS_DATA3_N	17	18	LVDS_DATA2_N
LVDS_DATA3_P	15	16	LVDS_DATA2_P
GND	13	14	GND
LVDS_DATA1_N	11	12	LVDS_DATA0_N
LVDS_DATA1_P	9	10	LVDS_DATA0_P
GND	7	8	GND
LVDS_DDC_CLK	5	6	LVDS_DDC_DATA
+3.3V	3	4	+5V
+3.3V	1	2	+5V

2.4.16 Miscellaneous setting connector (JFP)

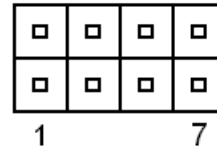
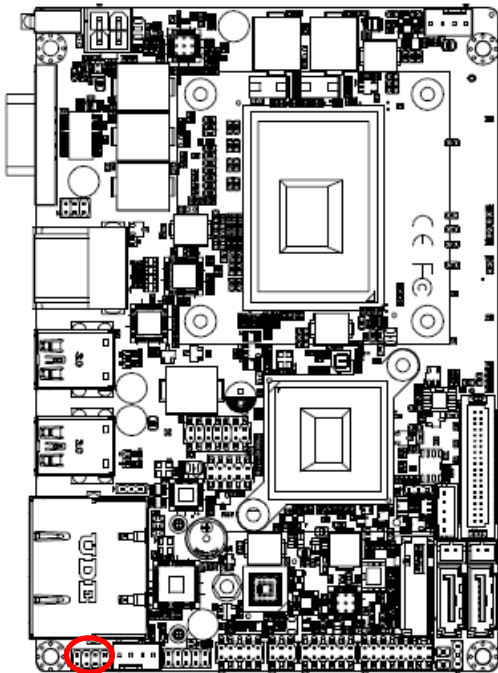

Signal	PIN	PIN	Signal
PWR_BTN_IN_EC#	1	2	GND
RESET_BT	3	4	GND
+5VSB	5	6	PWR_LED-
HDD_LED#	7	8	+5V

2.4.17 SPI connector (JSPI)

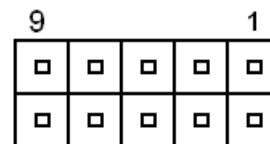
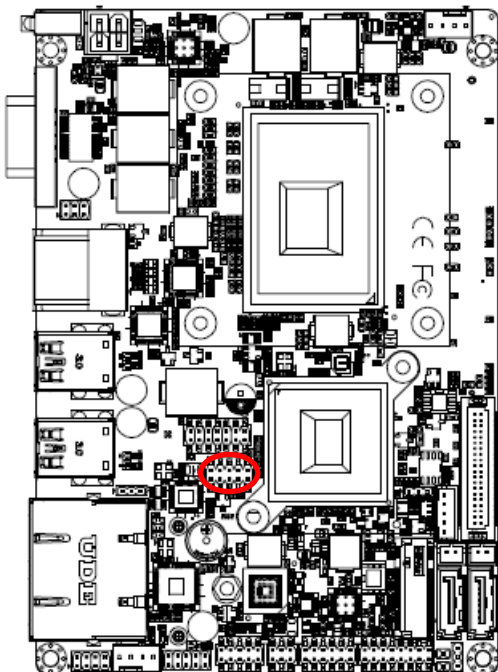

Signal	PIN	PIN	Signal
+3.3VSB	1	2	GND
SPI_CS0#	3	4	SPI_CLK
SPI_SO	5	6	SPI_SI
HOLD#	7	8	NC
EC_SMCLK_DEBUG	9	10	EC_SMDAT_DEBUG

EPS-KBLHE

2.4.18 Battery connector (JBAT)

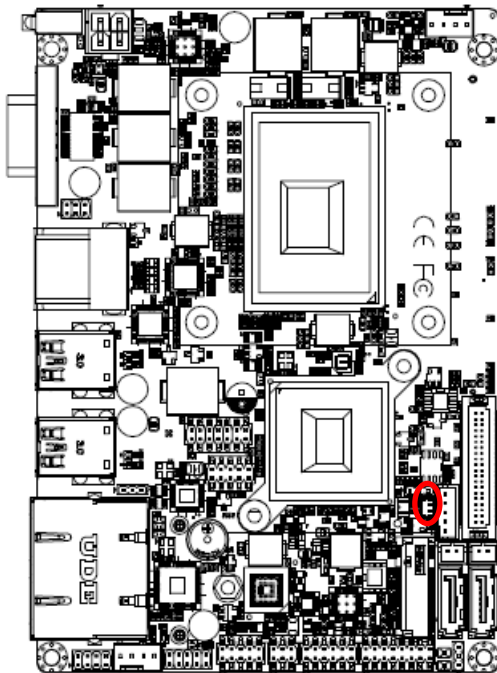

Signal	PIN
GND	2
+3.3V	1

2.4.19 Audio connector (JAUDIO)

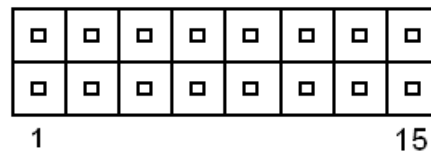
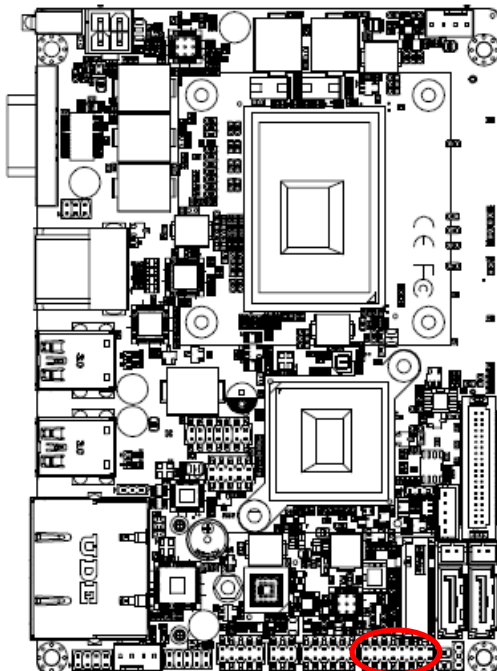

Signal	PIN	PIN	Signal
FRONT-R-OUT	1	2	FRONT-L-OUT
HD_AGND	3	4	HD_AGND
LINE1-R-IN	5	6	LIN1-L-IN
MIC1-R-IN	7	8	MIC1-L-IN
FRONT-JD	9	10	LINE1-JD
MIC1-JD	11	12	HD_AGND
SPK_L+	13	14	SPK_R+
SPK_L-	15	16	SPK_R-

2.4.19.1 Signal Description – Audio connector (JAUDIO)

Signal	Signal Description
LINE1-JD	AUDIO IN (LINE_RIN/LIN)sense pin
FRONT-JD	AUDIO Out(ROUT/LOUT) sense pin
MIC1-JD	MIC IN (MIC_RIN/LIN) sense pin

2.5 Installing Hard Disk (EPS-KBLHE)

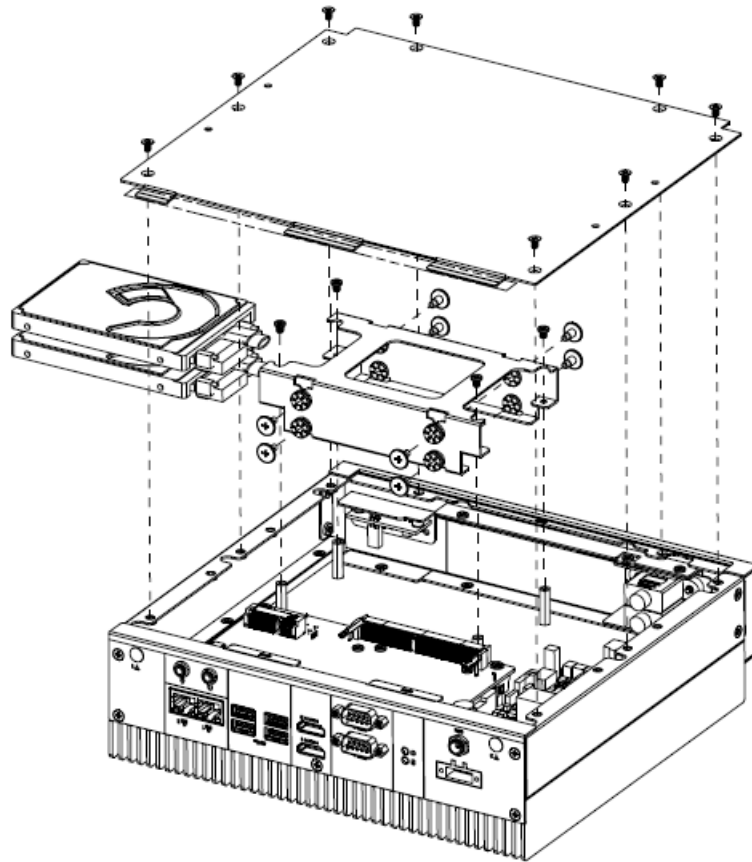

Step1. For HDD installation, please remove 8 screws to detach top cover, HDD enclosure from board & system assembly.

Step2. Fix HDD using the 12 screws in the Accessory Kit.

Step3. Re-assemble your system back through previous steps to complete the installation.

3. BIOS Setup

3.1 Introduction

The BIOS setup program allows users to modify the basic system configuration. In this following chapter will describe how to access the BIOS setup program and the configuration options that may be changed.

3.2 Starting Setup

AMI BIOS™ is immediately activated when you first power on the computer. The BIOS reads the system information contained in the NVRAM and begins the process of checking out the system and configuring it. When it finishes, the BIOS will seek an operating system on one of the disks and then launch and turn control over to the operating system.

While the BIOS is in control, the Setup program can be activated in one of two ways:

By pressing <F2> or immediately after switching the system on, or

By pressing the <F2> or key when the following message appears briefly at the left-top of the screen during the POST (Power On Self Test).

Press <F2> or to enter SETUP

If the message disappears before you respond and you still wish to enter Setup, restart the system to try again by turning it OFF then ON or pressing the "RESET" button on the system case. You may also restart by simultaneously pressing <Ctrl>, <Alt>, and <Delete> keys.

3.3 Using Setup

In general, you use the arrow keys to highlight items, press <Enter> to select, use the PageUp and PageDown keys to change entries, press <F1> for help and press <Esc> to quit. The following table provides more detail about how to navigate in the Setup program using the keyboard.

Button	Description
↑	Move to previous item
↓	Move to next item
←	Move to the item in the left hand
→	Move to the item in the right hand
Esc key	Main Menu -- Quit and not save changes into NVRAM Status Page Setup Menu and Option Page Setup Menu -- Exit current page and return to Main Menu
+ key	Increase the numeric value or make changes
- key	Decrease the numeric value or make changes
F1 key	General help, only for Status Page Setup Menu and Option Page Setup Menu
F2 key	Previous Values
F3 key	Optimized defaults
F4 key	Save & Exit Setup

- **Navigating Through The Menu Bar**

Use the left and right arrow keys to choose the menu you want to be in.



Note: Some of the navigation keys differ from one screen to another.

- **To Display a Sub Menu**

Use the arrow keys to move the cursor to the sub menu you want. Then press <Enter>. A “➤” pointer marks all sub menus.

3.4 Getting Help

Press F1 to pop up a small help window that describes the appropriate keys to use and the possible selections for the highlighted item. To exit the Help Window press <Esc> or the F1 key again.

3.5 In Case of Problems

If, after making and saving system changes with Setup, you discover that your computer no longer is able to boot, the BIOS supports an override to the NVRAM settings which resets your system to its defaults.

The best advice is to only alter settings which you thoroughly understand. To this end, we strongly recommend that you avoid making any changes to the chipset defaults. These defaults have been carefully chosen by both your systems manufacturer to provide the absolute maximum performance and reliability. Even a seemingly small change to the chipset setup has the potential for causing you to use the override.

3.6 BIOS setup

Once you enter the Aptio Setup Utility, the Main Menu will appear on the screen. The Main Menu allows you to select from several setup functions and exit choices. Use the arrow keys to select among the items and press <Enter> to accept and enter the sub-menu.

3.6.1 Main Menu

This section allows you to record some basic hardware configurations in your computer and set the system clock.

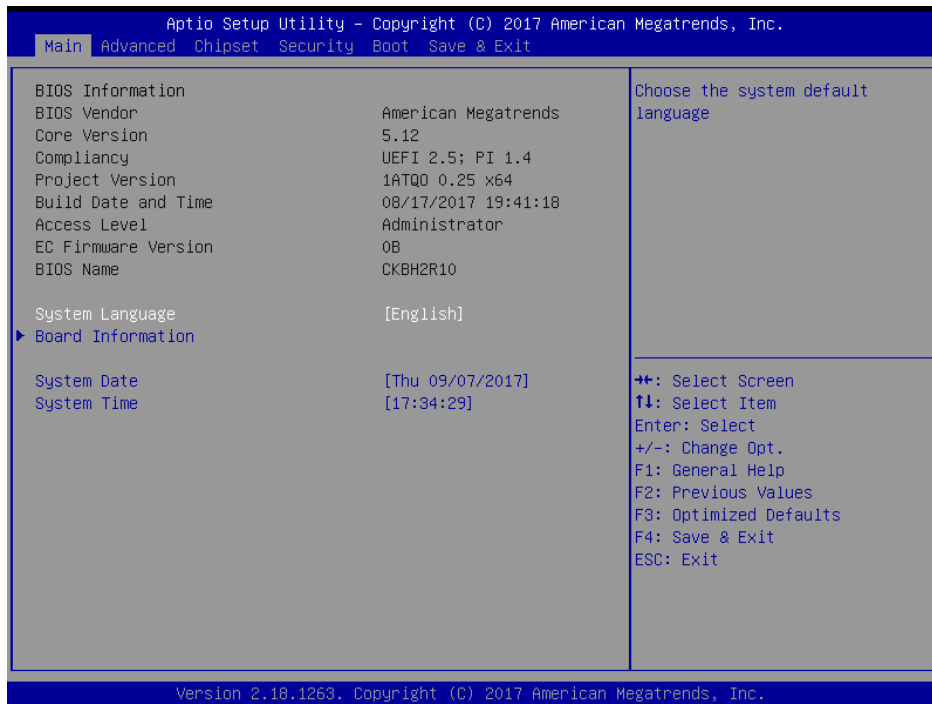

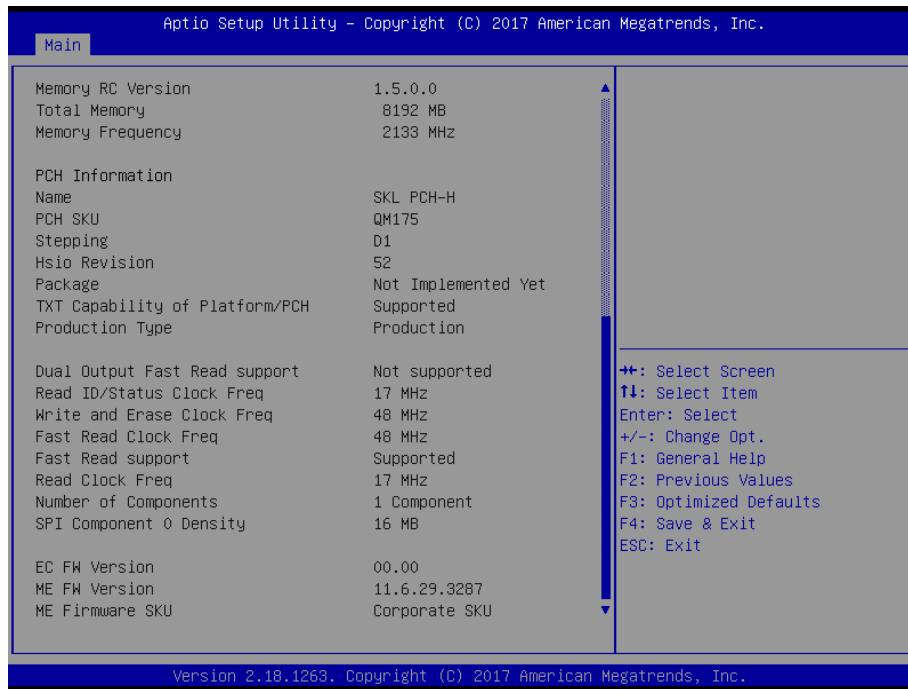

3.6.1.1 System Language

This option allows choosing the system default language.

3.6.1.2 System Date

Use the system date option to set the system date. Manually enter the day, month and year.

3.6.1.3 System Time

Use the system time option to set the system time. Manually enter the hours, minutes and seconds.



Note: The BIOS setup screens shown in this chapter are for reference purposes only, and may not exactly match what you see on your screen.

Visit the Avalue website (www.avalue.com.tw) to download the latest product and BIOS information.

3.6.2 Advanced Menu

This section allows you to configure your CPU and other system devices for basic operation through the following sub-menus.

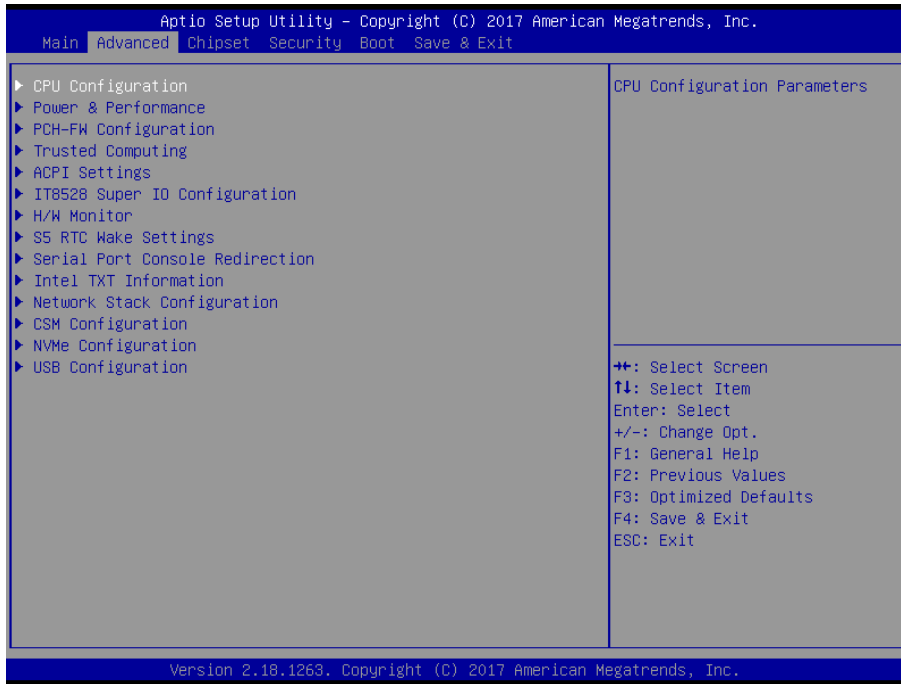

3.6.2.1 CPU Configuration

Use the CPU configuration menu to view detailed CPU specification and configure the CPU.



Item	Options	Description
Intel (VMX) Virtualization Technology	Disabled Enabled[Default]	When enabled, a VMM can utilize the additional hardware capabilities provided by Vanderpool Technology.
Active Processor Cores	All[Default] 1 2 3	Number of cores to enable in each processor package.

3.6.2.2 Power & Performance

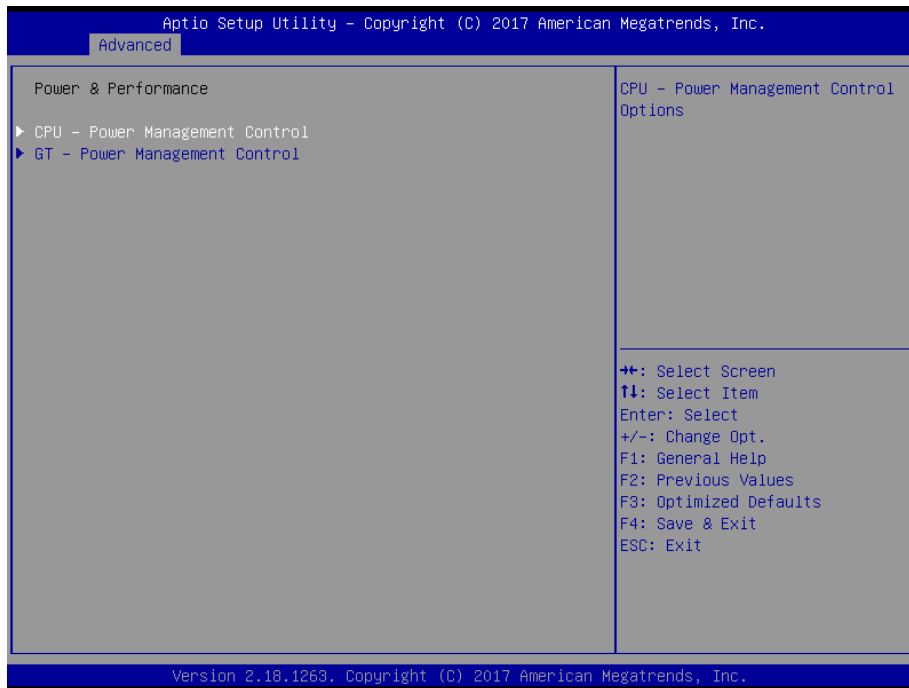

3.6.2.2.1 CPU – Power Management Control

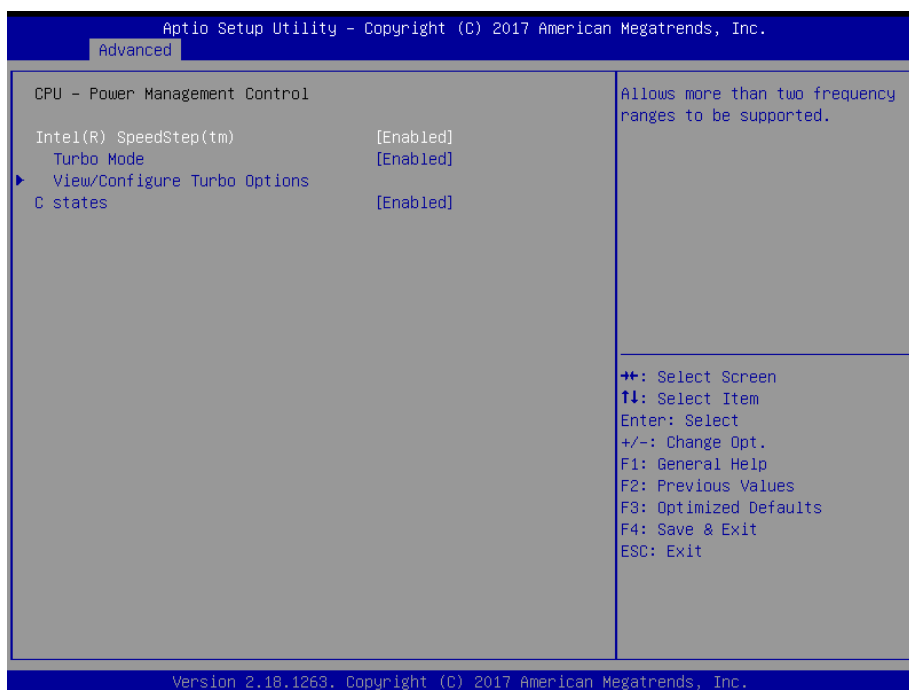

Item	Option	Description
Intel® SpeedStep™	Enabled[Default], Disabled	Allows more than two frequency ranges to be supported.
Turbo Mode	Enabled[Default], Disabled	Enable/Disable processor Turbo Mode (requires EMTTM enabled too). AUTO means enabled, unless max turbo ratio is bigger than 16 – SKL a0 W/A.
C States	Enabled[Default], Disabled	Enable/Disable CPU Power Management. Allows CPU to go to C states when it's not 100293502184tilized.

3.6.2.2.1.1 View/Configure Turbo Options

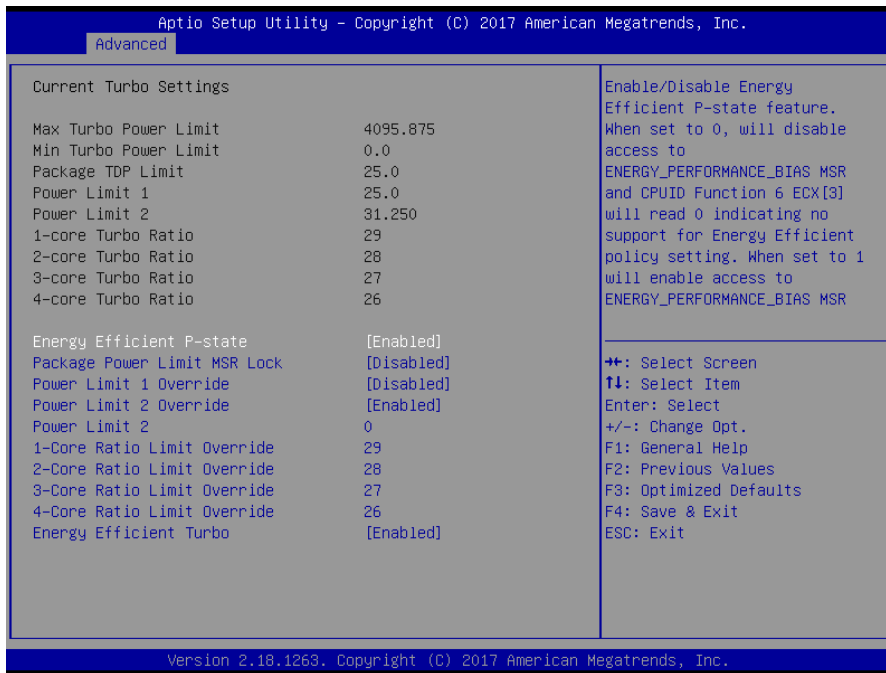

Item	Option	Description
Energy Efficient P-state	Enabled[Default], Disabled	Enable/Disable Energy Efficient P-state feature. When set to 0, will disable access to ENERGY_PERFORMANCE_BIAS MSR and CPUID Function 6 ECX[3] will read 0 indicating no support for Energy Efficient policy setting. When set to 1 will enable access to ENERGY_PERFORMANCE_BIAS MSR 1B0h and CPUID Function 6 ECX[3] will read 1 indicating Energy Efficient policy setting is.
Package Power Limit MSR Lock	Disabled[Default] Enabled	Enable/Disable locking of Package Power Limit settings. When enabled, PACKAGE_POWER_LIMIT MSR will be locked and a reset will be required to unlock the register.
Power Limit 1 Override	Disabled[Default] Enabled	Enable/Disable Power Limit 1 override. If this option is disabled, BIOS will program the

Quick Reference Guide

		default values for Power Limit 1 and Power Limit 1 Time Window.
Power Limit 2 Override	Disabled Enabled[Default]	Enable/Disable Power Limit 2 override. If this option is disabled, BIOS will program the default values for Power Limit 2.
Power Limit 2	0	Power Limit 2 value in Milli Watts. BIOS will round to the nearest 1/8W when programming. If the value is 0, BIOS will program this value as 1.25*TDP. For 12.50W, enter 12500. Processor applies control policies such that the package power does not exceed this limit.
1-Core Ratio Limit Override	0-83	1-Core Ratio Limit with range 0 to 83. The Minimum range may vary between Processors. This 1-Core Ratio Limit Must be greater than or equal to 2-Core ratio Limit, 3-Core Ratio Limit, 4-Core Ratio Limit.
2-Core Ratio Limit Override	0-83	2-Core Ratio Limit with range 0 to 83. The Minimum range may vary between Processors. This 2-Core Ratio Limit Must be Less than or equal to 1-Core Ratio Limit.
3-Core Ratio Limit Override	0-83	4-Core Ratio Limit with range 0 to 83. The Minimum range may vary between Processors. This 4-Core Ratio Limit Must be Less than or equal to 1-Core Ratio Limit.
4-Core Ratio Limit Override	0-83	1-Core Ratio Limit with range 0 to 83. The Minimum range may vary between Processors. This 1-Core Ratio Limit Must be greater than or equal to 2-Core ratio Limit, 3-Core Ratio Limit, 4-Core Ratio Limit.
Energy Efficient Turbo	Disabled, Enabled[Default]	Enable/Disable Energy Efficient Turbo Feature. This feature will opportunistically lower the turbo frequency to increase efficiency. Recommended only to disable in overclocking situations where turbo frequency must remain constant. Otherwise, leave enabled.

3.6.2.2.2 GT – Power Management Control



Item	Option	Description
RC6(Render Standby)	Enabled[Default], Disabled	Check to enable render standby support.
Maximum GT frequency	Default Max Frequency[Default] 100Mhz/150Mhz/200Mhz/250Mhz/300Mhz /350Mhz/400Mhz/450Mhz/500Mhz/550Mhz /600Mhz/650Mhz/700Mhz/750Mhz/800Mhz /850Mhz/900Mhz/950Mhz/1000Mhz/1050Mhz /1100Mhz/1150Mhz/1200Mhz	Auto Updated.

3.6.2.3 PCH-FW Configuration

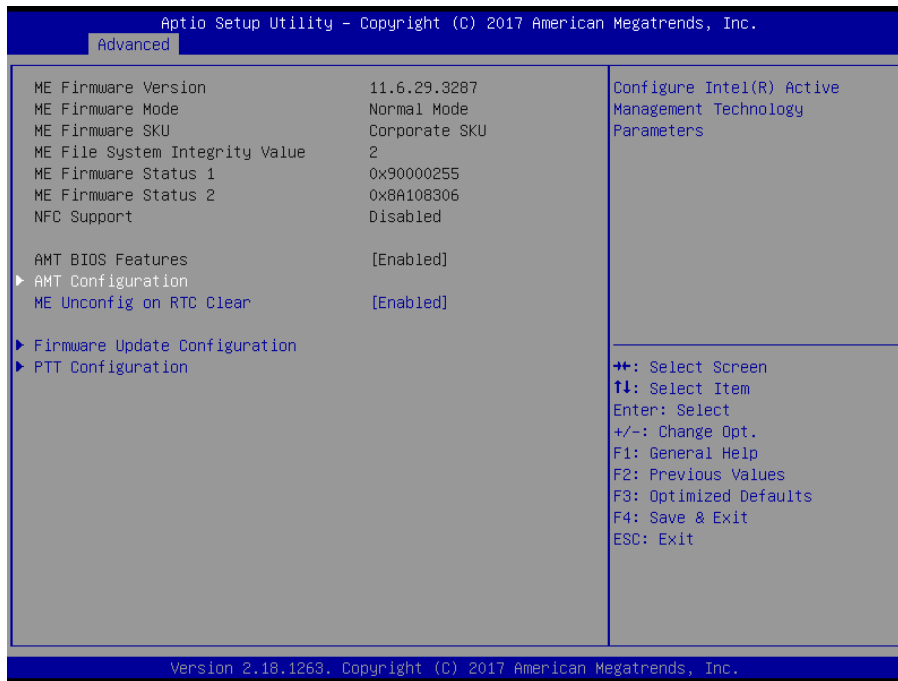

Item	Options	Description
ME Unconfig on RTC Clear	Disabled, Enabled[Default]	When Disabled ME will not be unconfigured on RTC Clear.

3.6.2.3.1 AMT Configuration



Item	Option	Description
ASF support	Disabled, Enabled[Default]	Enable/Disable Alert Standard Format support.

EPS-KBLHE

USB Provisioning of AMT	Disabled[Default], Enabled	Enable/Disable of AMT USB Provisioning.
--------------------------------	-------------------------------	---

3.6.2.3.1.1 CIRA Configuration

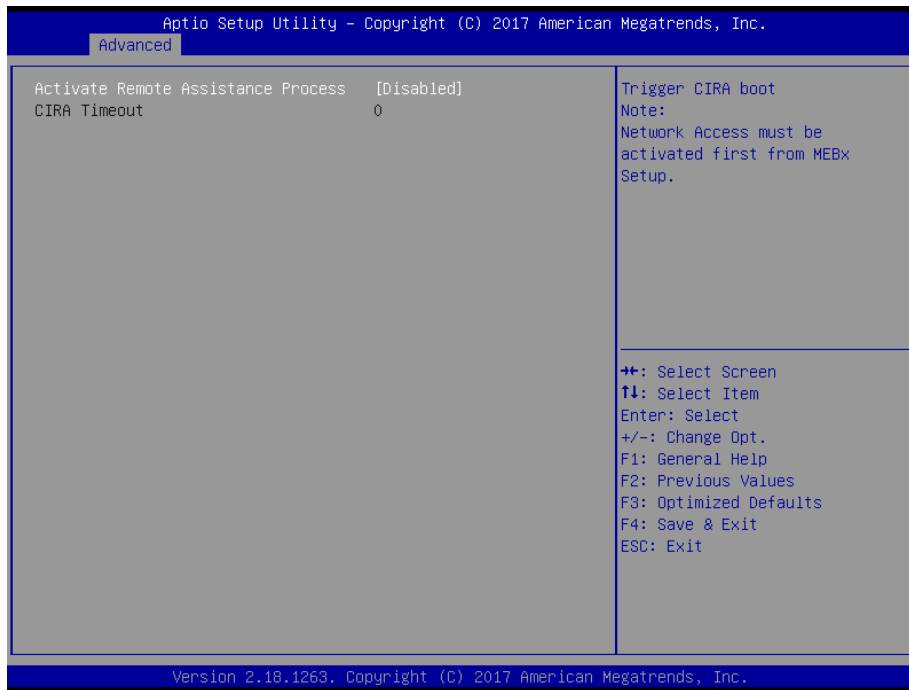

Item	Description
Activate Remote Assistance Process	Trigger CIRA boot. Note: Network Access must be activated first from MEBx Setup.

3.6.2.3.1.2 ASF Configuration

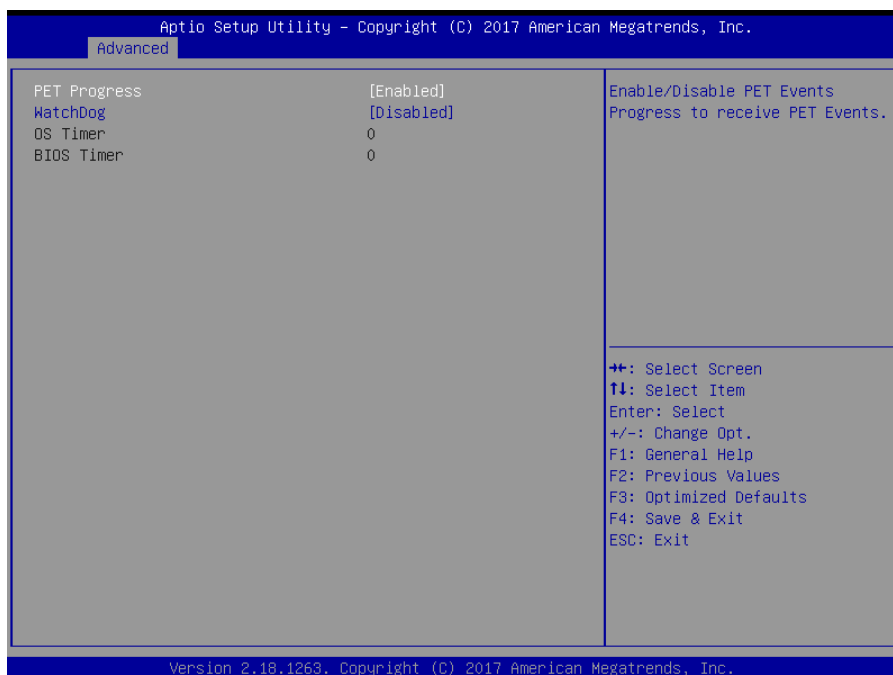

Item	Option	Description
PET Progress	Disabled, Enabled[Default]	Enable/Disable PET Events Progress to receive PET Events.
WatchDog	Disabled[Default], Enabled	Enable/Disable WatchDog Timer.

3.6.2.3.1.3 Secure Erase Configuration

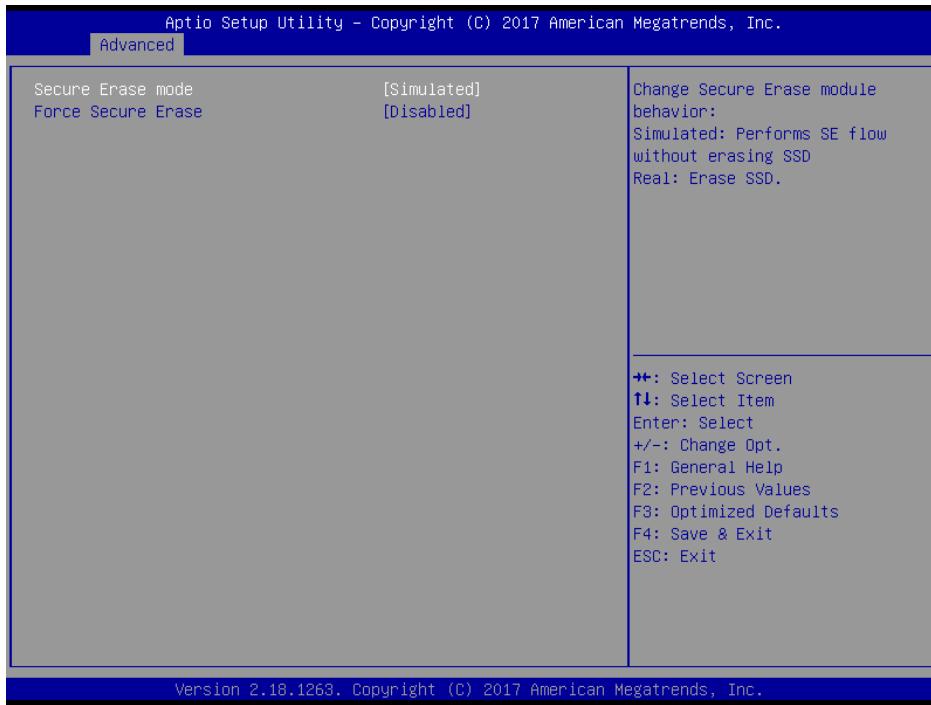

Item	Option	Description
Secure Erase mode	Simulated[Default] Real	Change Secure Erase module behavior: Simulated: Performs SE flow without erasing SSD Real: Erase SSD.
Force Secure Erase	Disabled[Default], Enabled	Force Secure Erase on next boot.

3.6.2.3.1.4 OEM Flags Settings

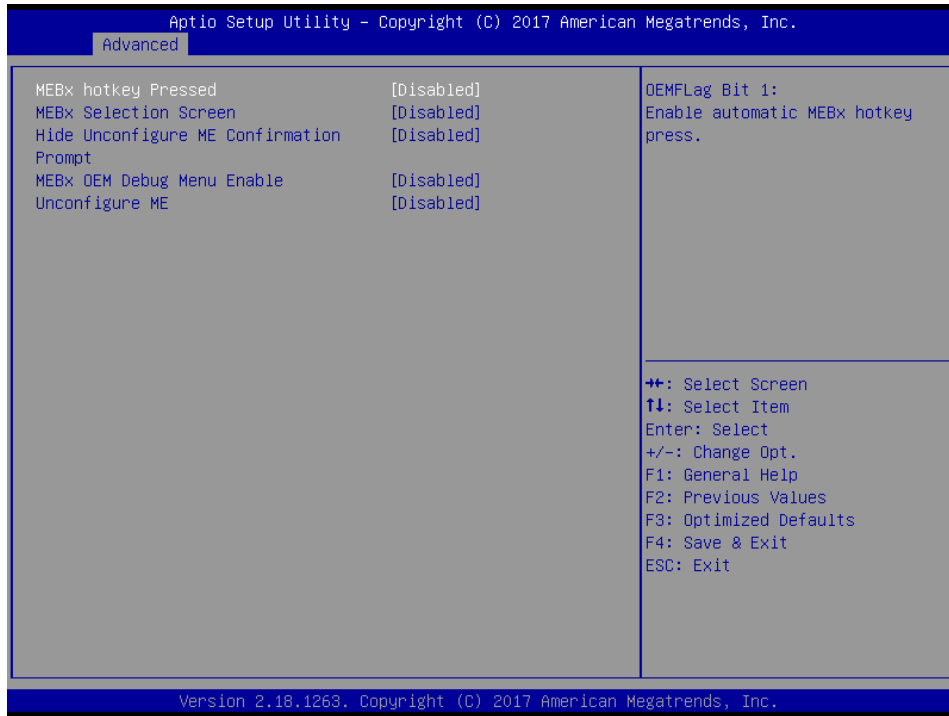

Item		Description
MEBx hotkey Pressed	Disabled[Default], Enabled	OEMFlag Bit 1: Enable automatic MEBx hotkey press.
MEBx Selection Screen	Disabled[Default], Enabled	OEMFlag Bit 2: Enable MEBx selection screen with 2 options: Press 1 to enter ME Configuration Screens Press 2 to initiate a remote connection Note: Network Access must be activated from MEBx Setup for this screen to be displayed.
Hide Unconfigure ME Confirmation	Disabled[Default], Enabled	OEMFlag Bit 6: Hide Unconfigure ME confirmation prompt when attempting ME unconfiguration.
MEBx OED Debug Menu Enable	Disabled[Default], Enabled	OEMFlag Bit 14: Enable OEM debug menu in MEBx.
Unconfigure ME	Disabled[Default], Enabled	OEMFlag Bit 15: Unconfigure ME with resetting MEBx password to default.

3.6.2.3.1.5 MEBx Resolution Settings

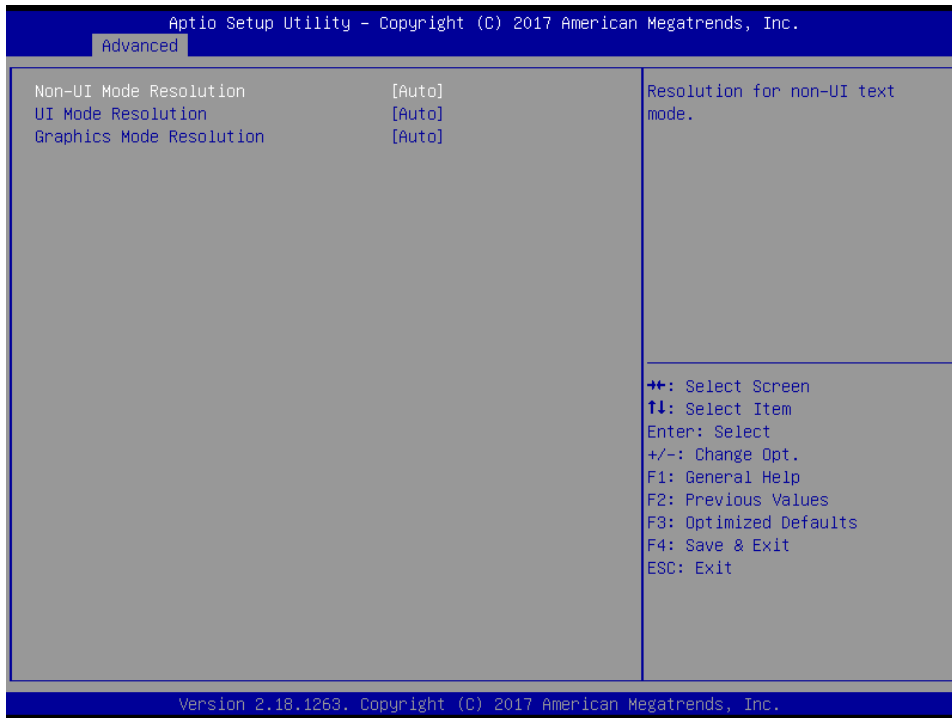

Item		Description
Non-UI Mode Resolution	Auto[Default], 80x25 100x31	Resolution for non-UI text mode.
UI Mode Resolution	Auto[Default], 80x25 100x31	Resolution for UI text mode.
Graphics Mode Resolution	Auto[Default], 640x480 800x600 1024x768	Resolution for graphics mode.

3.6.2.3.2 Firmware Update Configuration



Item	Option	Description
ME FW Image Re-Flash	Disabled [Default] , Enabled	Enable/Disable Me FW Image Re-Flash function.

3.6.2.3.3 PTT Configuration



Item	Option	Description
TPM Device Selection	dTPM[Default], PTT	Selects TPM device: PTT or dTPM. PTT – Enables PTT in SkuMgr dTPM 1.2 – Disables PTT in SkuMgr Warning! PTT/dTPM will be disabled and all data saved on it will be lost.

3.6.2.4 Trusted Computing

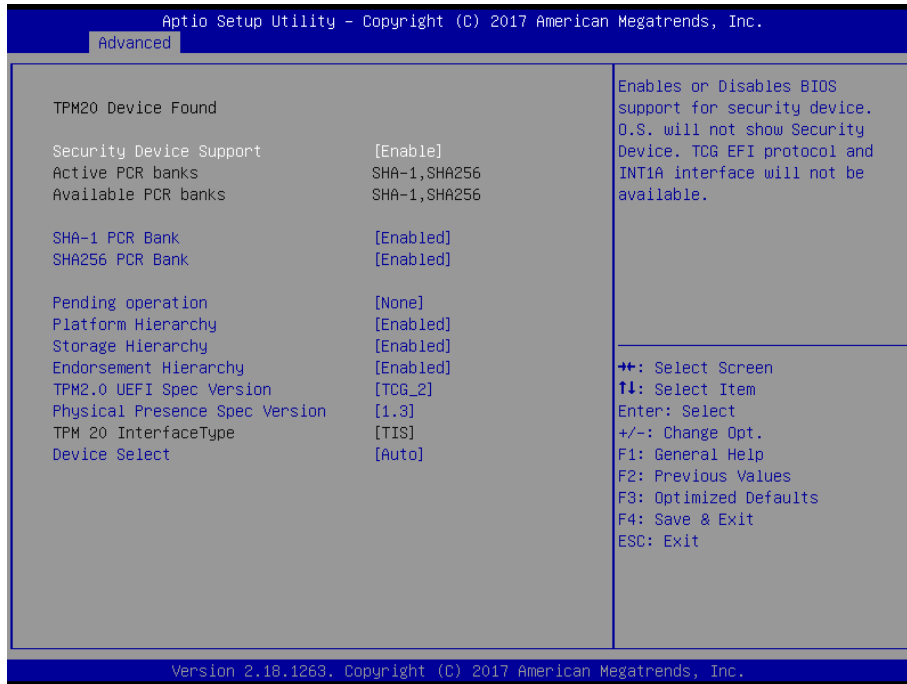

Item	Options	Description
Security Device Support	Disable, Enable[Default]	Enables or Disables BIOS support for security device. O.S. will not show Security Device. TCG EFI protocol and INT1A interface will not be available.
SHA-1 PCR Bank	Disabled Enabled[Default],	Enable or Disable SHA-1 PCR Bank.
SHA256 PCR Bank	Disabled Enabled[Default],	Enable or Disable SHA256 PCR Bank.
Pending operation	None[Default], TPM Clear	Schedule an Operation for the Security Device. NOTE: Your Computer will reboot during restart in order to change State of Security Device.
Platform Hierarchy	Disabled Enabled[Default],	Enable or Disable Platform Hierarchy.
Storage Hierarchy	Disabled Enabled[Default],	Enable or Disable Storage Hierarchy.
Endorsement Hierarchy	Disabled Enabled[Default],	Enable or Disable Endorsement Hierarchy.

EPS-KBLHE

TPM2.0 UEFI Spec Version	TCG_1_2 TCG_2[Default],	Select the TCG2 Spec Version Support, TCG_1_2: the Compatible mode for Win8/Win10, TCG_2: Support new TCG2 protocol and event format for Win10 or later.
Physical Presence Spec Version	1.2 1.3[Default],	Select to Tell O.S. to support PPI Spec Version 1.2 or 1.3. Note some HCK tests might not support 1.3.
Device Select	TPM 1.2 TPM 2.0 Auto[Default],	TPM 1.2 will restrict support to TPM 1.2 devices, TPM 2.0 will restrict support to TPM 2.0 devices, Auto will support both with the default set to TPM 2.0 devices if not found, TPM 1.2 devices will be enumerated.

3.6.2.5 APCI Settings

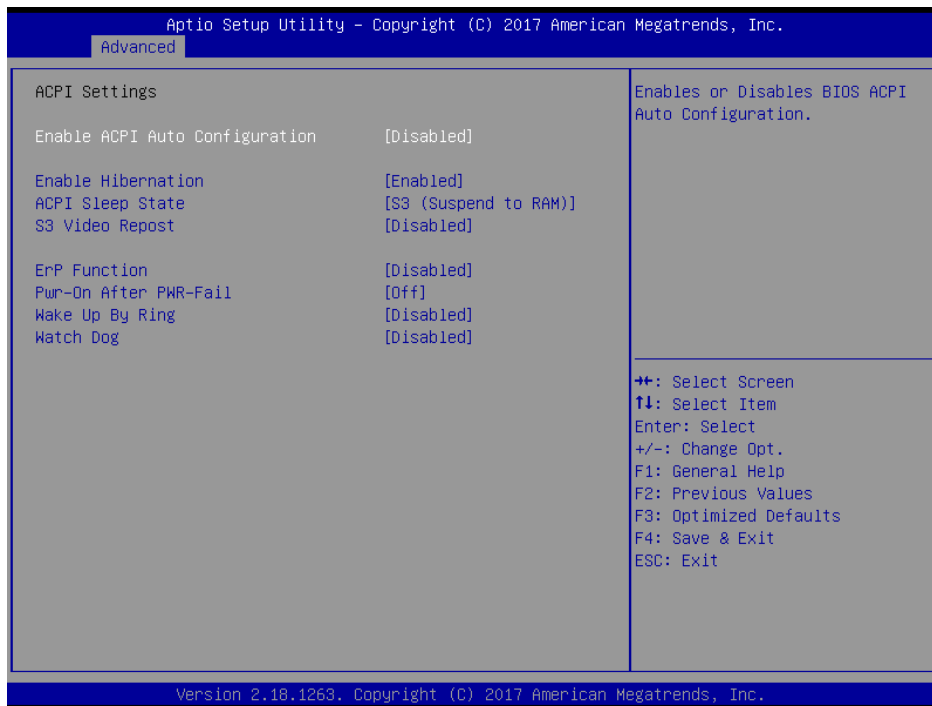

Item	Options	Description
Enable ACPI Auto Configuration	Disabled[Default], Enabled	Enables or Disables BIOS ACPI Auto Configuration.
Enable Hibernation	Disabled Enabled[Default],	Enables or Disables System ability to Hibernate (OS/S4 Sleep State). This option may not be effective with some OS.
ACPI Sleep State	Suspend Disabled, S3 (Suspend to RAM)[Default]	Select the highest ACPI sleep state the system will enter when the SUSPEND button is pressed.
S3 Video Repost	Disabled[Default], Enabled	Enable or Disable S3 Video Repost.
ErP Function	Disabled[Default], Enabled	ErP Function (Deep S5).

Pwr-On After PWR-Fail	Off[Default] On Last state	Select the power station after power failure.
Wake Up By Ring	Disabled[Default], Enabled	System wake up by ring (from S3~S5).
Watch Dog	Disabled[Default], 30 sec 40 sec 50 sec 1 min 2 min 10 min 30 min	Select Watch Dog Timer (WDT) Mode.

3.6.2.6 IT8528 Super IO Configuration

You can use this item to set up or change the IT8528 Super IO configuration for serial ports. Please refer to 3.6.2.6.1~ 3.6.2.6.2 for more information.

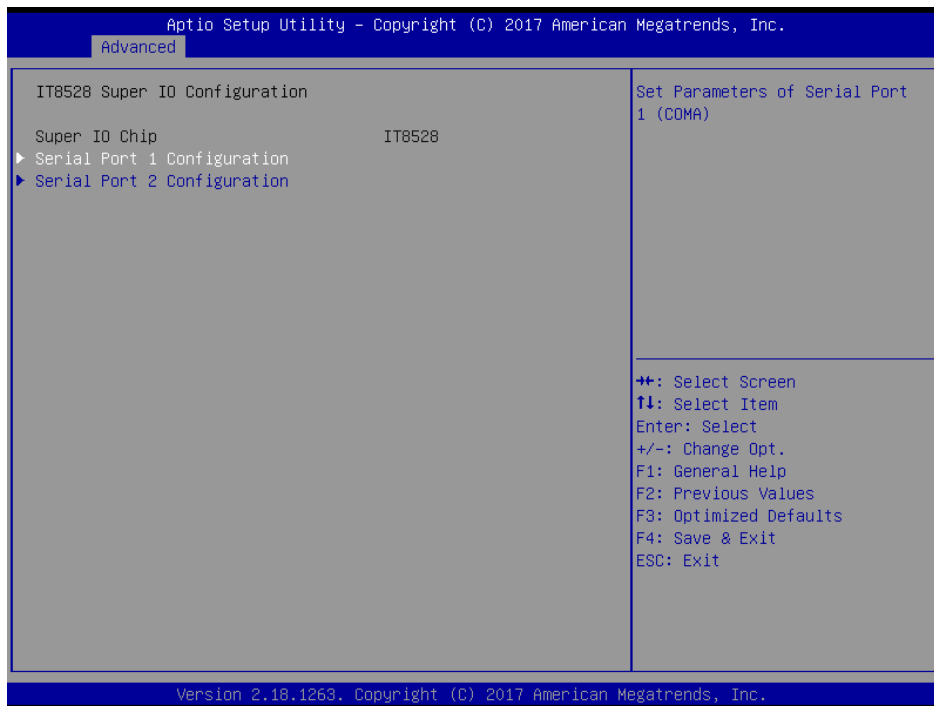

Item	Description
Serial Port 1 Configuration	Set Parameters of Serial Port 1 (COMA).
Serial Port 2 Configuration	Set Parameters of Serial Port 2 (COMB).

3.6.2.6.1 Serial Port 1 Configuration

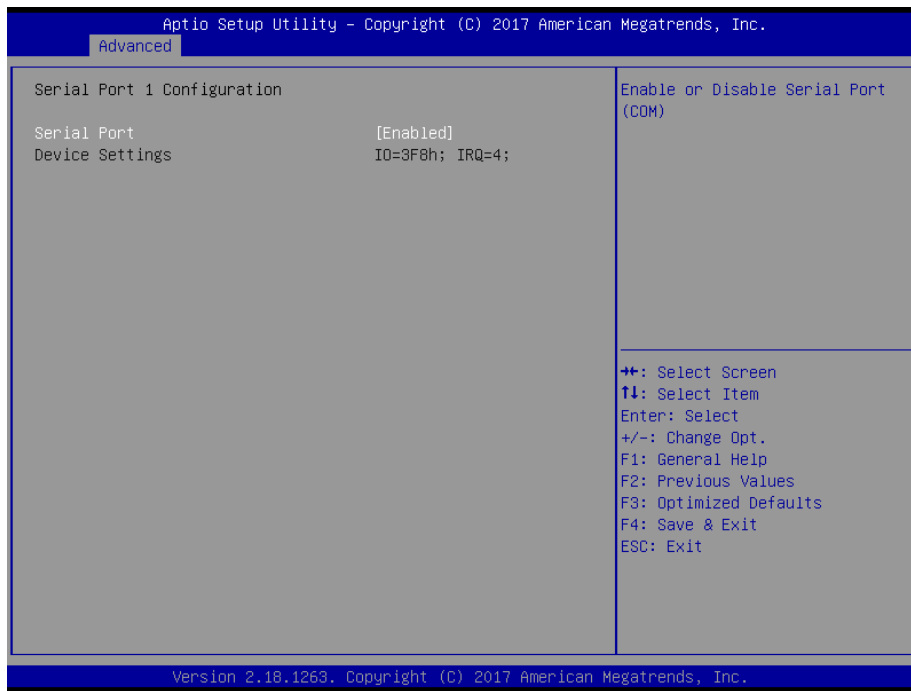

Item	Option	Description
Serial Port	Enabled[Default], Disabled	Enable or Disable Serial Port (COM).

3.6.2.6.2 Serial Port 2 Configuration

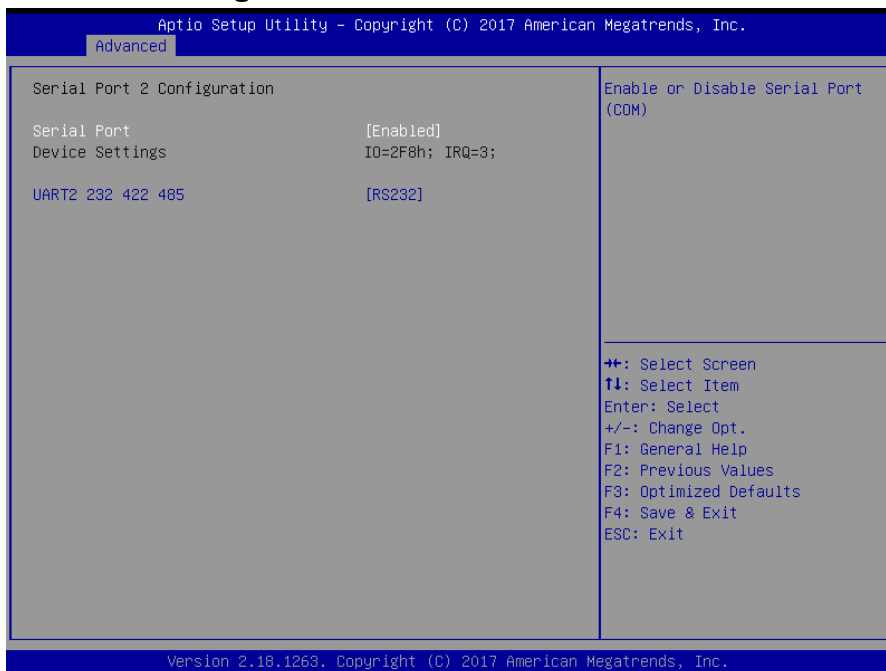

Item	Option	Description
Serial Port	Enabled[Default], Disabled	Enable or Disable Serial Port (COM).

UART 232 422 485	UART 232[Default] UART 422 UART 485	Change the Serial Port as RS232/422/485.
------------------	---	--

3.6.2.7 HW Monitor

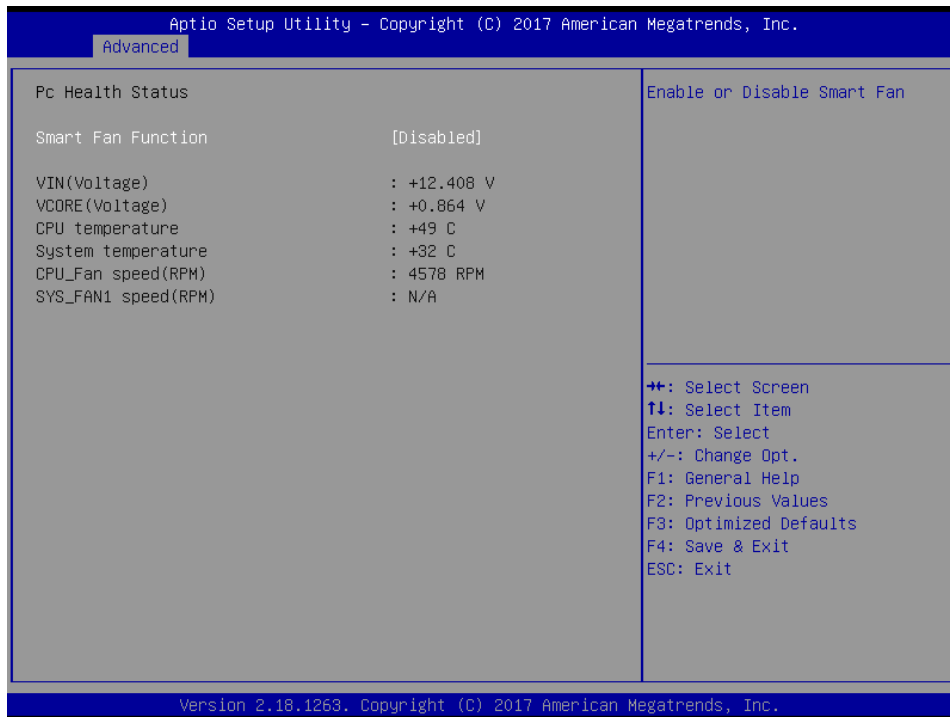

Item	Options	Description
Smart Fan Function	Enabled, Disabled[Default]	Enables or Disables Smart Fan.

3.6.2.7.1 Smart Fan Mode Configuration

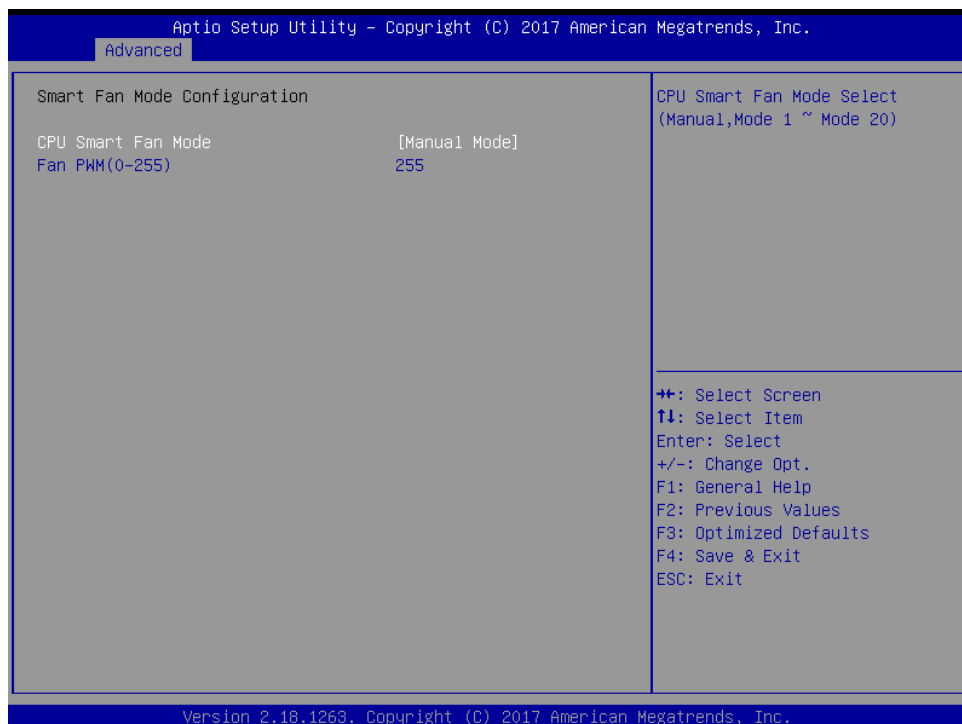

Item	Option	Description
CPU Smart Fan Mode	Manual Mode[Default]/ Mode 01/02/03/04/05 /06/07/08/09/10 /11/12/13/14/15 /16/17/18/19/20	CPU Smart Fan Mode Select (Manual, Mode 1~Mode 20).
Fan PWM (0-255)	0-255[Default]	Fan PWM duty (0-255).

3.6.2.8 S5 RTC Wake Settings

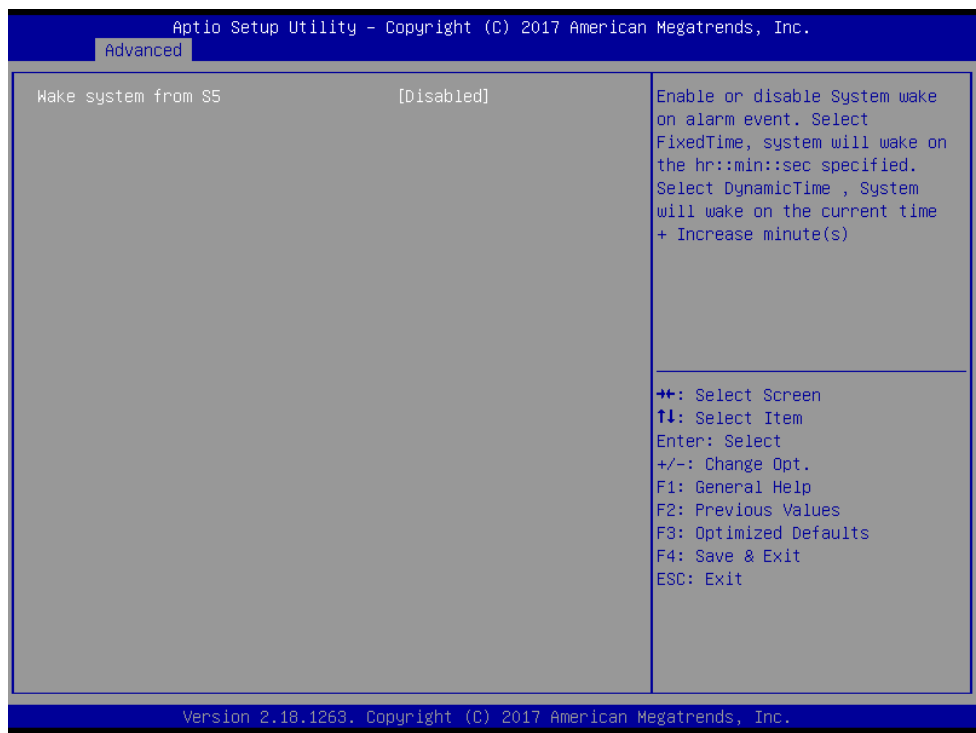

Item	Options	Description
Wake system from S5	Disabled[Default], Fixed Time Dynamic Time	Enable or disable System wake on alarm event. Select Fixed Time, system will wake on the hr::min::sec specified. Select Dynamic Time, System will wake on the current time + Increase minute(s).

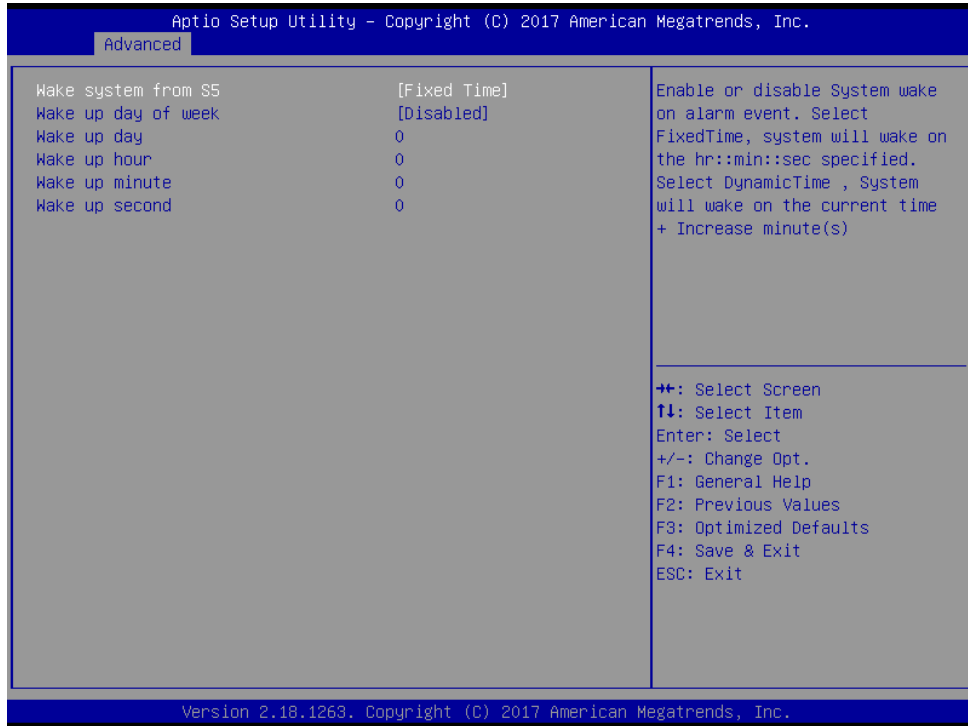

Item	Options	Description
Wake system from S5	Disabled, Fixed Time[Default] Dynamic Time	Enable or disable System wake on alarm event. Select Fixed Time, system will wake on the hr::min::sec specified. Select Dynamic Time, System will wake on the current time + Increase minute(s).
Wake up day of week	Disabled[Default] Monday-Friday Monday-Saturday	Wake up day of week. (Monday-Friday) or (Monday-Saturday).
Wake up day	1-31	Select 0 for daily system wake up 1-31 for which day of the month that you would like the system to wake up.
Wake up hour	0-23	Select 0-23 For example enter 3 for 3am and 15 for 3pm.
Wake up minute	0-23	Select 0-23 For example enter 3 for 3am and 15 for 3pm.
Wake up second	0-23	Select 0-23 For example enter 3 for 3am and 15 for 3pm.

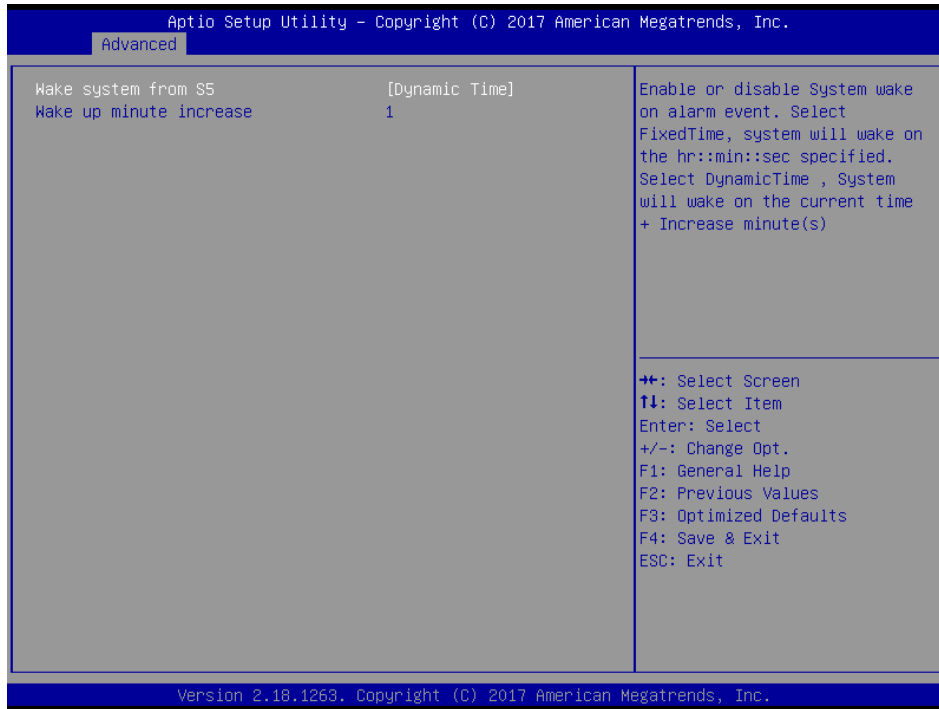

Item	Options	Description
Wake system from S5	Disabled, Fixed Time Dynamic Time[Default]	Enable or disable System wake on alarm event. Select Fixed Time, system will wake on the hr::min::sec specified. Select Dynamic Time, System will wake on the current time + Increase minute(s).
Wake up minute increase	1-5	1-5.

3.6.2.9 Serial Port Console Redirection

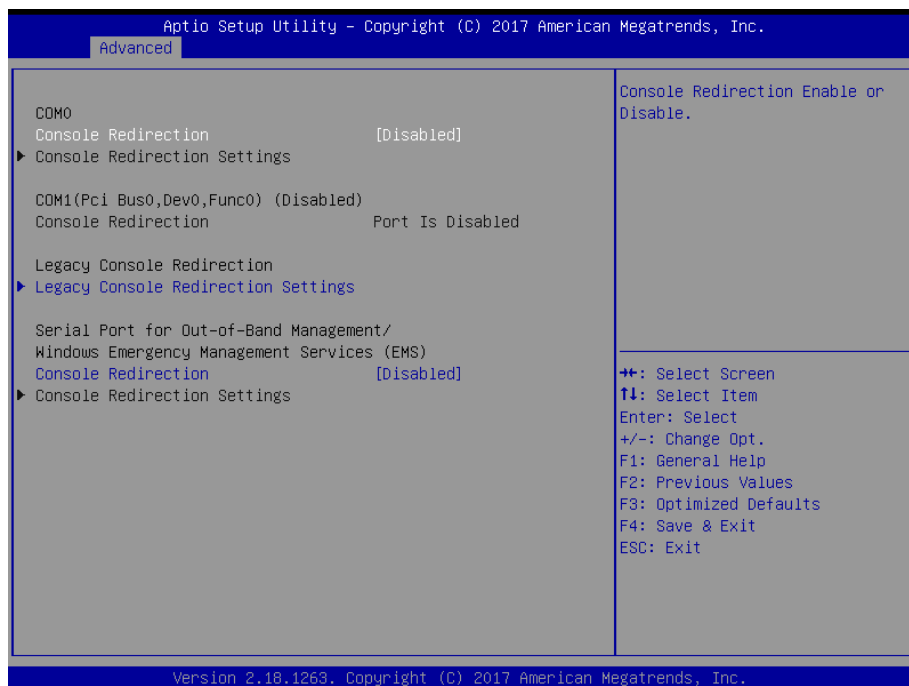

Item	Options	Description
Console Redirection	Disabled[Default], Enabled	Console Redirection Enable or Disable.

3.6.2.9.1 Legacy Console Redirection Settings



Item	Option	Description
Legacy Serial Redirection Port	COM0[Default]	Select a COM port to display redirection of Legacy OS and Legacy OPRM Messages.

3.6.2.9.2 Console Redirection Settings



Item	Option	Description
Out-of-Band Mgmt Port	COM0[Default]	Microsoft Windows Emergency Management Services (EMS) allows for remote management of a Windows Server OS through a serial port.
Terminal Type	VT100 VT100+ VT-UTF8[Default] ANSI	VT-UTF8 is the preferred terminal type for out-of-band management. The next best choice is VT100+ and then VT100. See above, in Console Redirection Settings page, for more Help with Terminal Type/Emulation.
Bits per second	9600 19200 57600 115200[Default]	Selects serial port transmission speed. The speed must be matched on the other side. Long or noisy lines may require lower speeds.
Flow Control	None[Default] Hardware RTS/CTS Software Xon/Xoff	Flow control can prevent data loss from buffer overflow. When sending data, if the receiving buffers are full, a 'stop' signal can be sent to stop the data flow. Once the buffers are empty, a 'start' signal can be sent to re-start the flow. Hardware flow control uses two wires to send start/stop signals.

3.6.2.10 Intel TXT Configuration

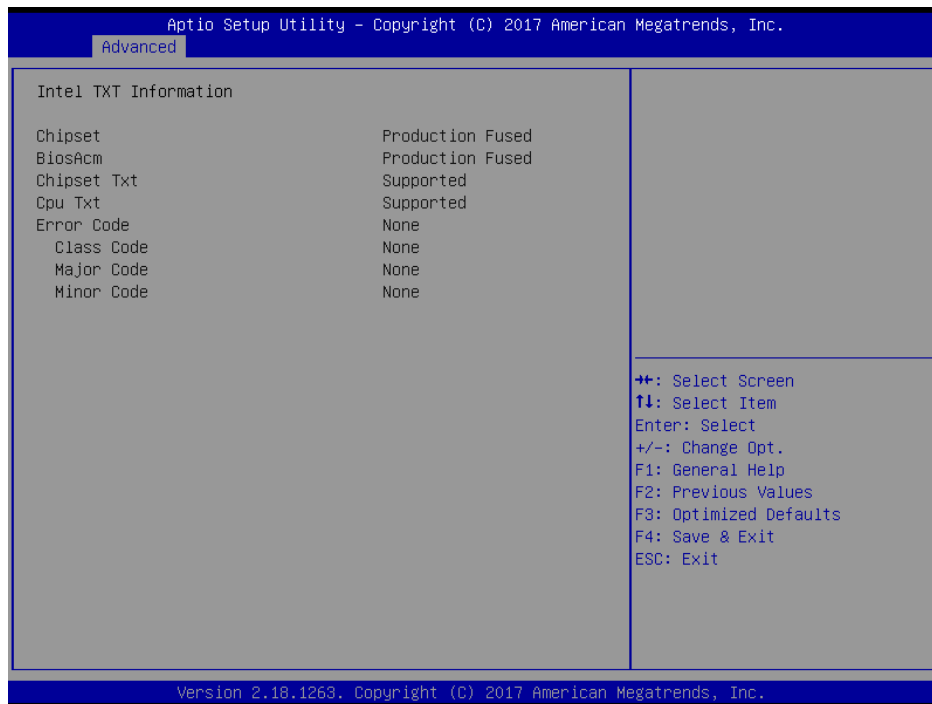

3.6.2.11 Network Stack Configuration



Item	Options	Description
Network Stack	Enabled Disabled[Default]	Enable/Disable UEFI Network Stack.

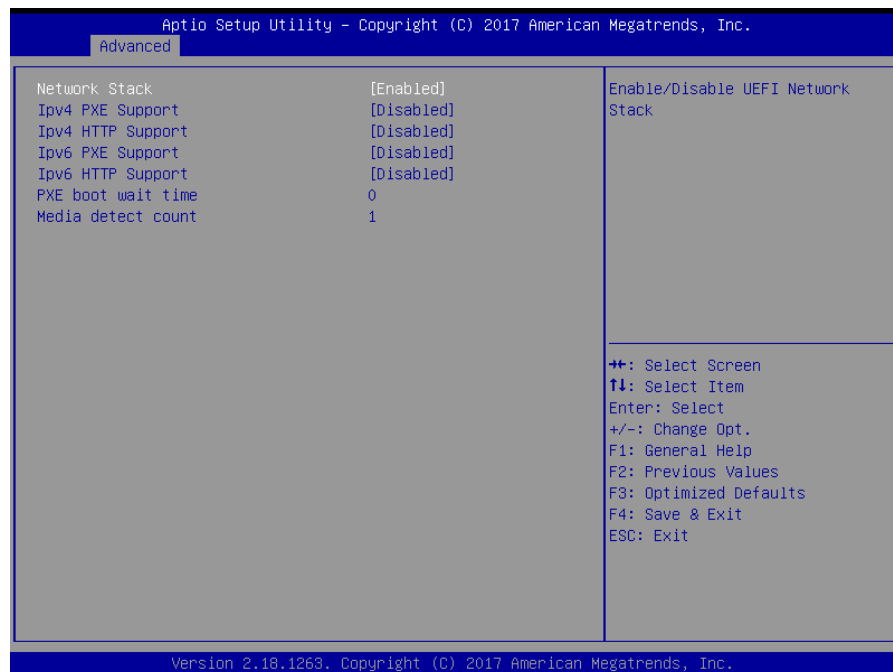

Item	Options	Description
Network Stack	Enabled[Default] Disabled	Enable/Disable UEFI Network Stack.
Ipv4 PXE Support	Enabled Disabled[Default]	Enable Ipv4 PXE Boot Support. If disabled IPV4 PXE boot option will not be created.

EPS-KBLHE

Ipv4 HTTP Support	Enabled Disabled[Default]	Enable Ipv4 HTTP Boot Support. If disabled IPV4 HTTP boot option will not be created.
Ipv6 PXE Support	Enabled Disabled[Default]	Enable Ipv6 PXE Boot Support. If disabled IPV6 PXE boot option will not be created.
Ipv6 HTTP Support	Enabled Disabled[Default]	Enable Ipv6 HTTP Boot Support. If disabled IPV6 HTTP boot option will not be created.
PXE boot wait time	0	Wait time to press ESC key to abort the PXE boot.
Media detect count	1	Number of times presence of media will be checked.

3.6.2.12 CSM Configuration

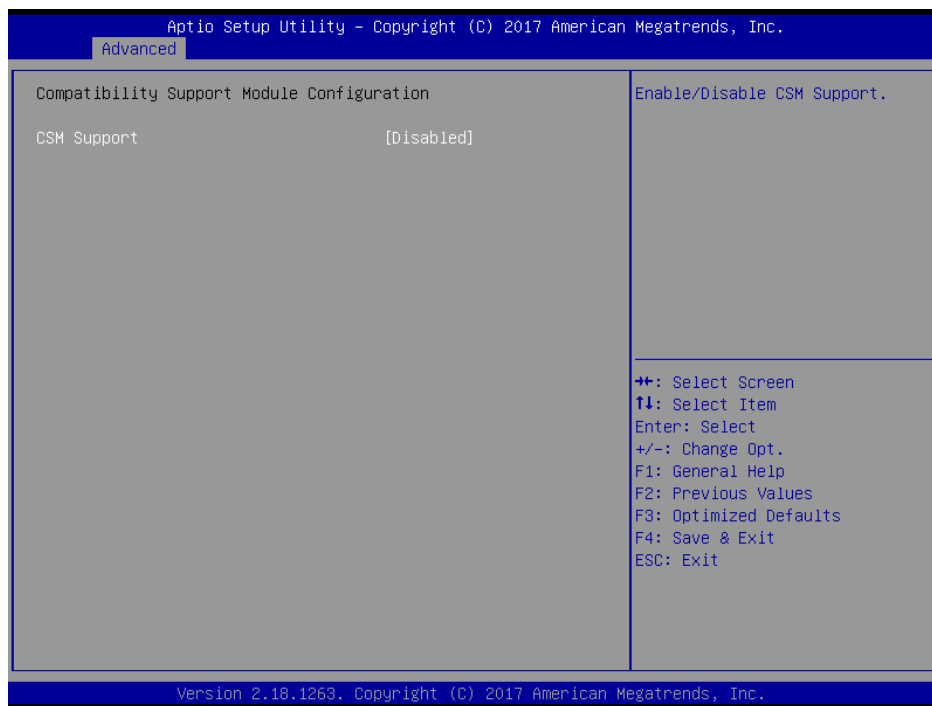

Item	Options	Description
CSM Support	Enabled Disabled[Default]	Enable/Disable CSM Support.

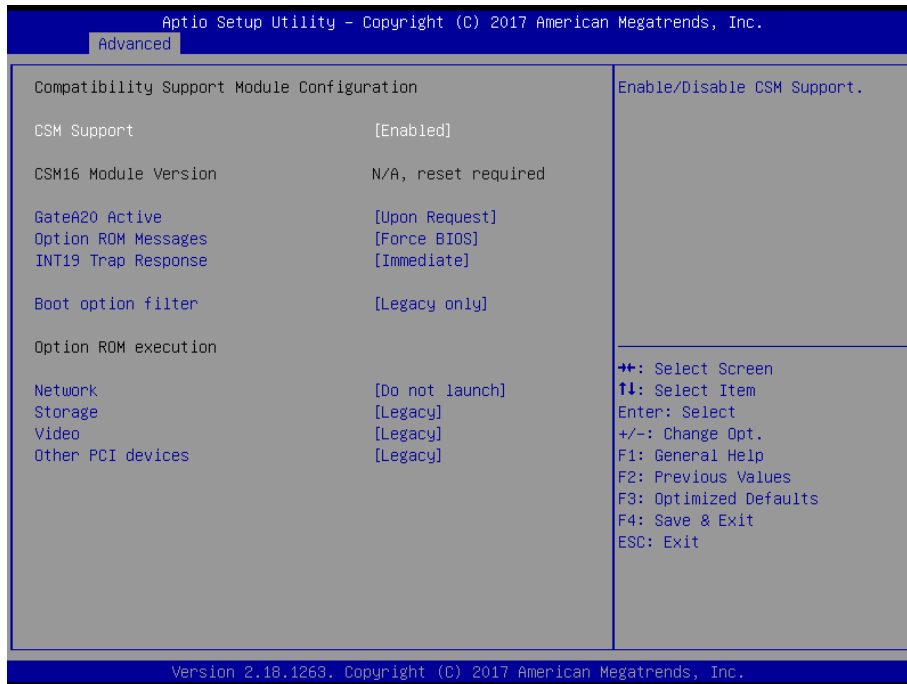

Item	Options	Description
CSM Support	Enabled[Default] Disabled	Enable/Disable CSM Support.
GateA20 Active	Upon Request[Default] Always	UPON REQUEST – GA20 can be disabled using BIOS service. ALWAYS – do not allow disabling GA20; this option is useful when any RT code is executed above 1MB.
Option ROM Messages	Force BIOS[Default] Keep Current	Set display mode for Option ROM.
INT19 Trap Response	Immediate[Default] Postponed	BIOS reaction on INT19 trapping by Option ROM: IMMEDIATE – execute the trap right away; POSTPONED – execute the trap during legacy boot.
Boot Option filter	UEFI and Legacy Legacy only[Default] UEFI only	This option controls Legacy/UEFI ROMs priority.
Network	Do not launch[Default] UEFI Legacy	Controls the execution of UEFI and Legacy PXE OpROM.
Storage	Do not launch UEFI Legacy[Default]	Controls the execution of UEFI and Legacy Storage OpROM.
Video	Do not launch UEFI Legacy[Default]	Controls the execution of UEFI and Legacy Video OpROM.
Other PCI devices	Do not launch UEFI Legacy[Default]	Determines OpROM execution policy for devices other than Network, Storage, or Vide.

3.6.2.13 NVMe Configuration

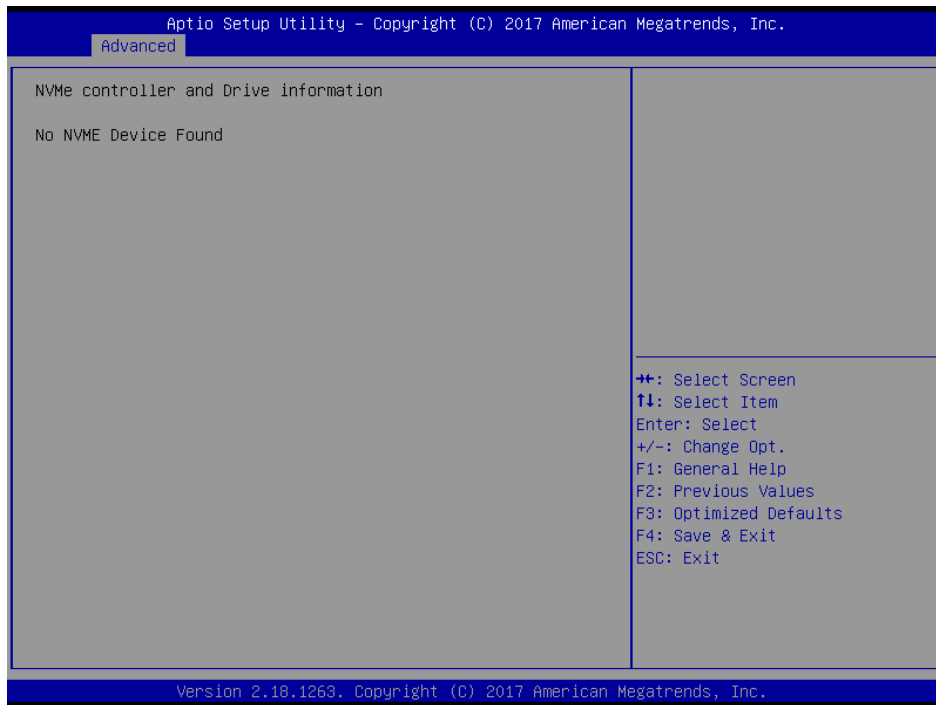

3.6.2.14 USB Configuration

The USB Configuration menu helps read USB information and configures USB settings.

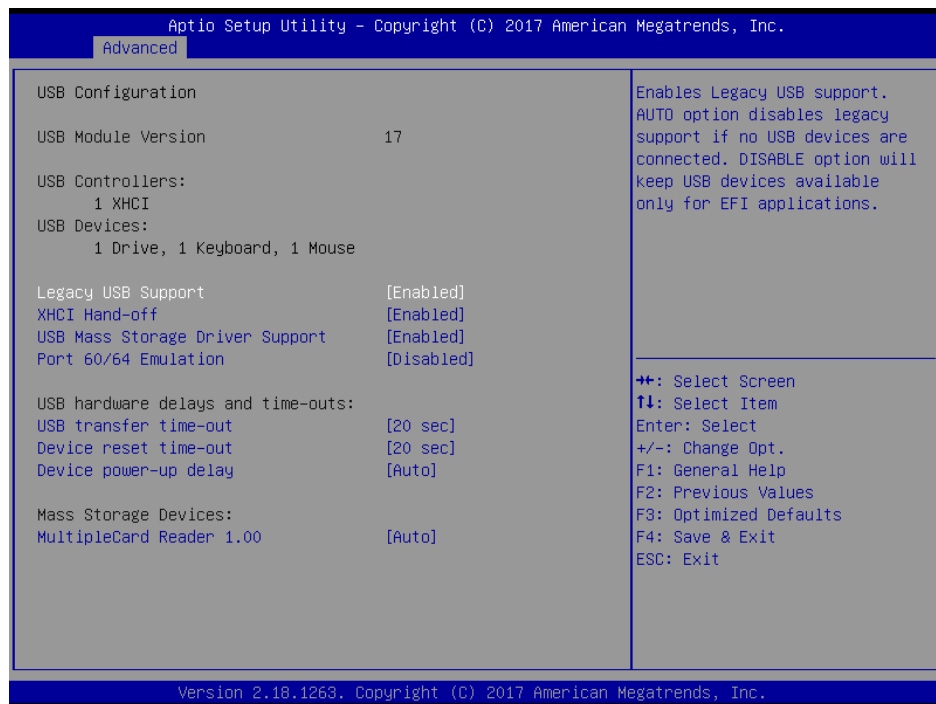

Item	Options	Description
Legacy USB Support	Enabled[Default] Disabled Auto	Enables Legacy USB support. AUTO option disables legacy support if no USB devices are connected. DISABLE option will keep SUB devices available only for EFI applications.

Quick Reference Guide

XHCI Hand-off	Enabled [Default] Disabled	This is a workaround for OSes without XHCI hand-off support. The XHCI ownership change should be claimed by XHCI driver.
USB Mass Storage Driver Support	Enabled [Default] Disabled	Enable/Disable USB Mass Storage Driver Support.
Port 60/64 Emulation	Enabled Disabled [Default]	Enable I/O port 60h/64h emulation support. This should be enabled for the complete USB keyboard legacy support for non-USB aware OSes.
USB transfer time-out	1 sec 5 sec 10 sec 20 sec [Default]	The time-out value for Control, Bulk, and Interrupt transfers.
Device reset time-out	10 sec 20 sec [Default] 30 sec 40 sec	USB mass storage device Start Unit command time-out.
Device power-up delay	Auto [Default] Manual	Maximum time the device will take before it properly reports itself to the Host Controller. 'Auto' uses default value: for a Root port it is 100ms, for a Hub port the delay is taken from Hub descriptor.
Mass Storage Devices	Auto [Default] Floppy Forced FDD Hard Disk CD-ROM	Mass storage device emulation type. 'AUTO' enumerates devices according to their media format. Optical drives are emulated as 'CDROM', drives with no media will be emulated according to a drive type.

3.6.3 Chipset

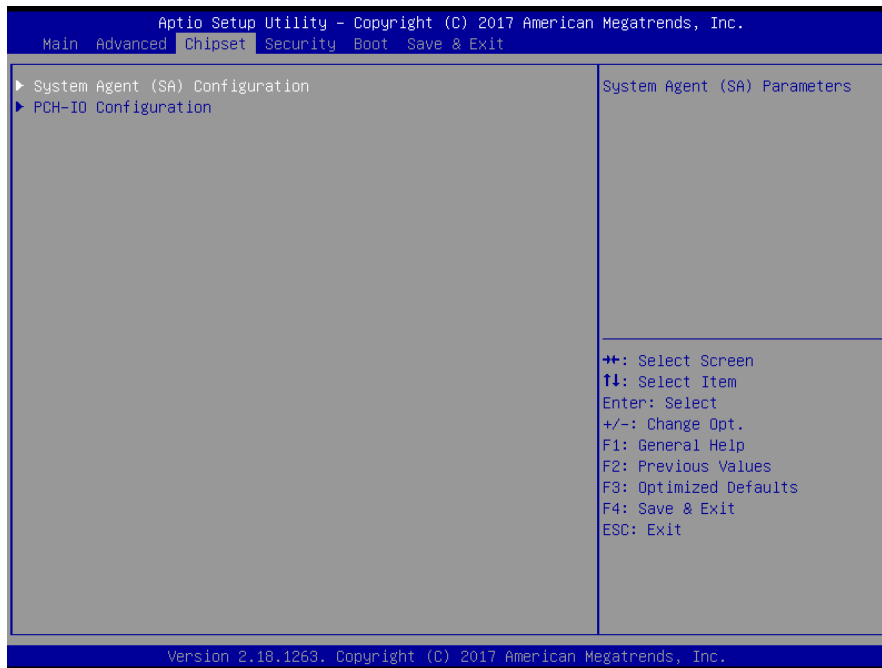

3.6.3.1 System Agent (SA) Configuration

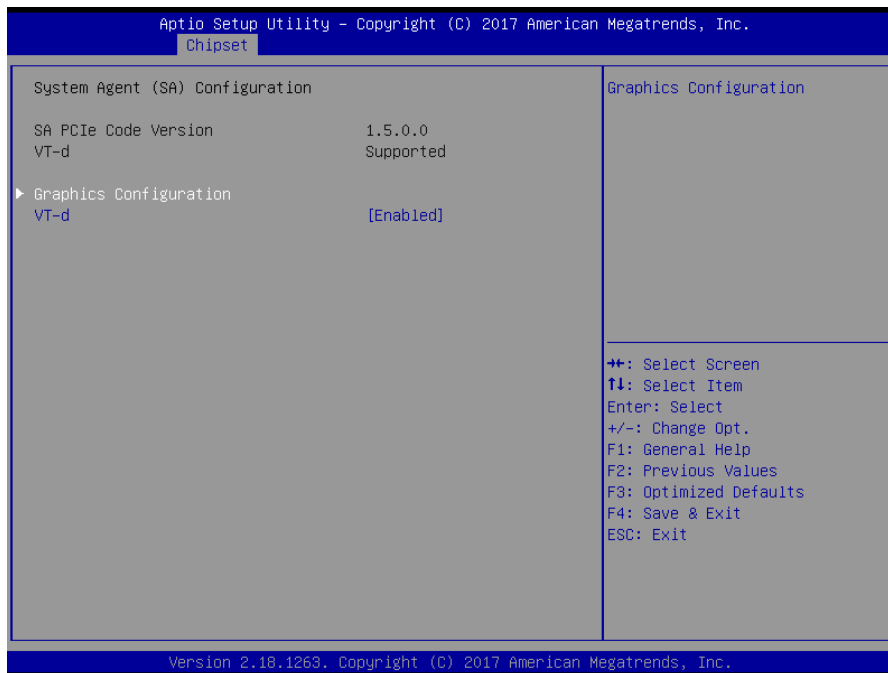

Item	Option	Description
VT-d	Enabled[Default] Disabled	VT-d capability.

3.6.3.1.1 Graphics Configuration

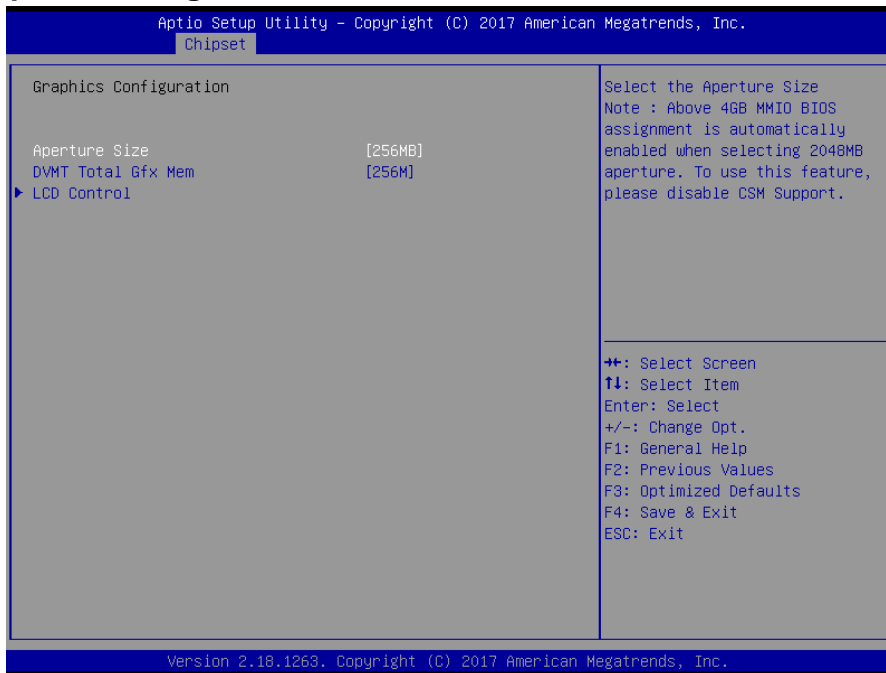

Item	Option	Description
Aperture Size	128MB	Select the Aperture Size. Note: Above 4GB MMIO BIOS assignment is automatically enabled when selecting 2048MB aperture. To use this feature, please disable CSM Support.
	256MB[Default]	
	512MB	
	1024MB	
	2048MB	
DVMT Total Gfx Mem	256M[Default]	Select DVMT 5.0 Total Graphics Memory size used by the Internal Graphics Device.
	128M	
	MAX	

3.6.3.1.1.1 LCD Control

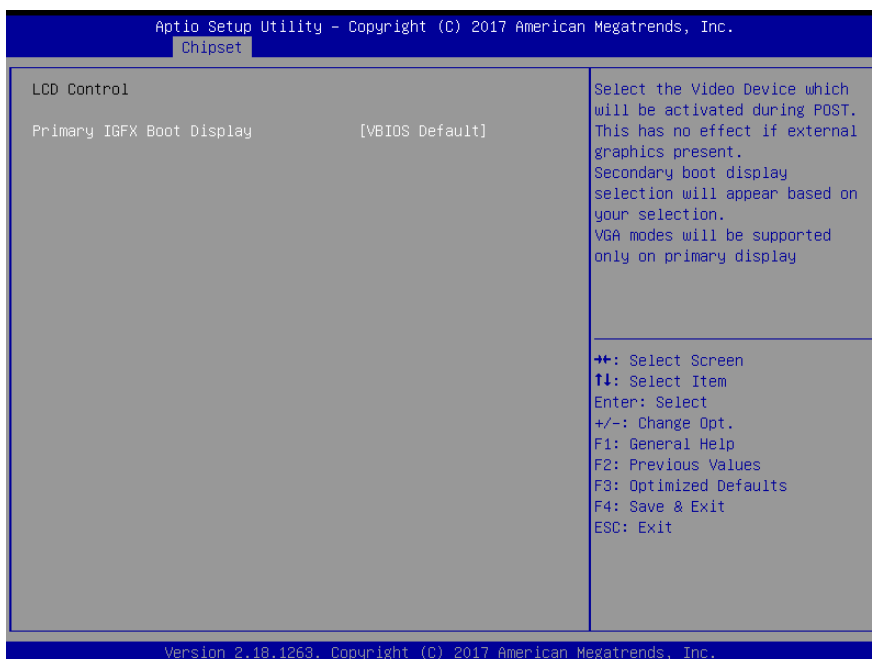

Item	Option	Description
Primary IGFX Boot Display	VBIOS Default[Default], EFP LFP EFP3 EFP2 EFP4	Select the Video Device which will be activated during POST. This has no effect if external graphics present. Secondary boot display selection will appear based on your selection. VGA modes will be supported only on primary display.

3.6.3.2 PCH-IO Configuration

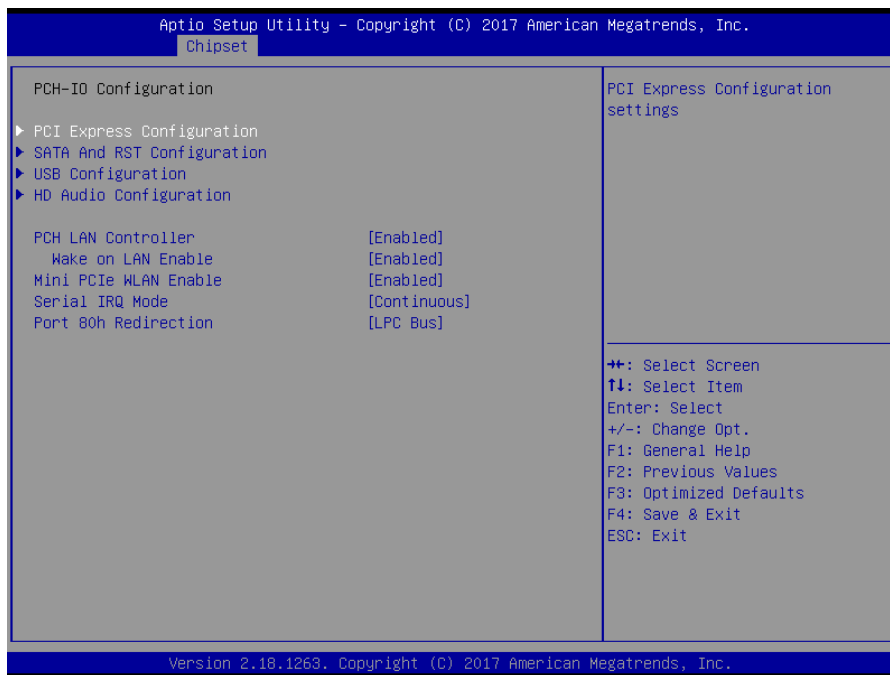

Item	Option	Description
PCH LAN Controller	Disabled Enabled[Default]	Enable or disable onboard NIC.
Wake on LAN Enable	Disabled Enabled[Default]	Enable or disable integrated LAN to wake the system.
Mini PCIe WLAN Enable	Disabled Enabled[Default]	Mini PCIe wifi RF Kill.
Serial IRQ Mode	Quiet Continuous[Default]	Configure Serial IRQ Mode.
Port 80h Redirection	LPC Bus[Default] PCIE Bus	Control where the Port 80h cycles are sent.

3.6.3.2.1 PCI Express Configuration

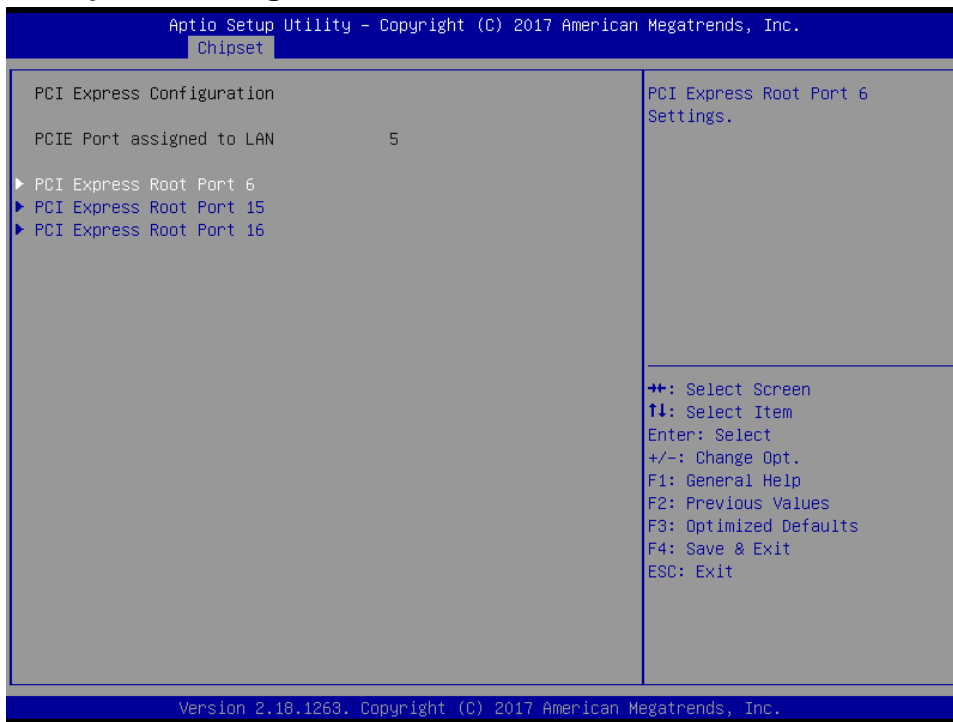

3.6.3.2.1.1 PCI Express Root Port 6

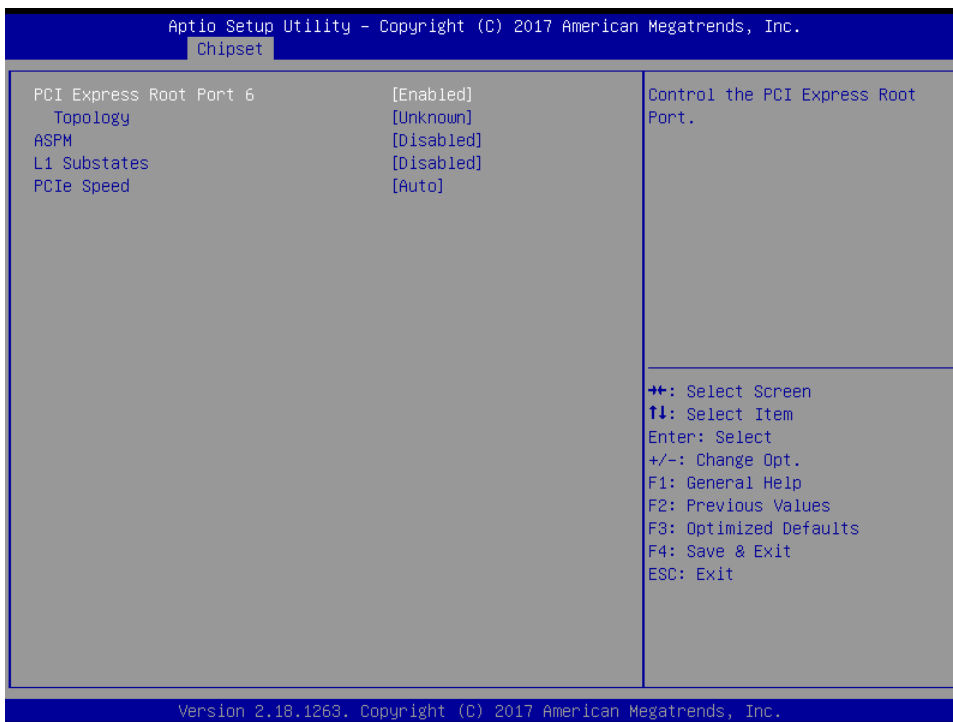

Item	Option	Description
PCI Express Root Port 6	Enabled[Default], Disabled	Control the PCI Express Root Port.
Topology	Unknown[Default] x1,	Identify the SATA Topology if it is Default or ISATA or Flex or DirectConnect or M2.

EPS-KBLHE

	x4 Sata Express M2	
ASPM	Disabled[Default], L0s L1 L0sL1 Auto	Set the ASPM Level: Force L0s – Force all links to L0s State AUTO – BIOS auto configure DISABLE – Disables ASPM.
L1 Substates	Disabled[Default], L1.1 L1.2 L1.1 & L1.2	PCI Express L1 Substates settings.
PCIe Speed	Auto[Default] Gen1 Gen2 Gen3	Configure PCIe Speed.

3.6.3.2.1.2 PCI Express Root Port 15

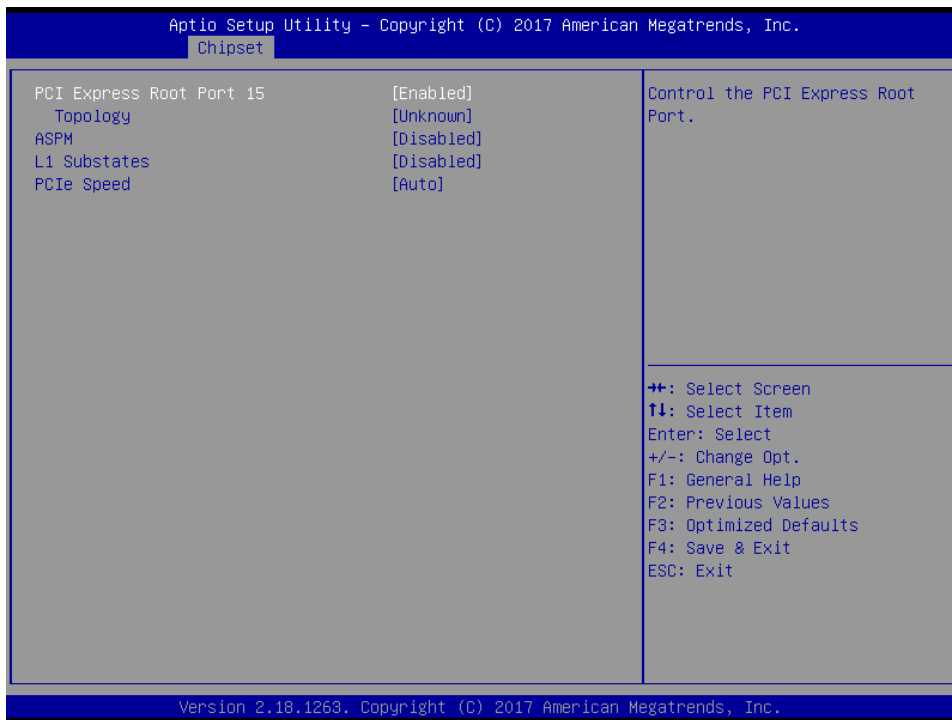

Item	Option	Description
PCI Express Root Port 15	Enabled[Default], Disabled	Control the PCI Express Root Port.
Topology	Unknown[Default] x1, x4 Sata Express M2	Identify the SATA Topology if it is Default or ISATA or Flex or DirectConnect or M2.
ASPM	Disabled[Default], L0s L1	Set the ASPM Level: Force L0s – Force all links to L0s State AUTO – BIOS auto configure DISABLE – Disables ASPM.

	L0sL1 Auto	
L1 Substates	Disabled[Default], L1.1 L1.2 L1.1 & L1.2	PCI Express L1 Substates settings.
PCIe Speed	Auto[Default] Gen1 Gen2 Gen3	Configure PCIe Speed.

3.6.3.2.1.3 PCI Express Root Port 16

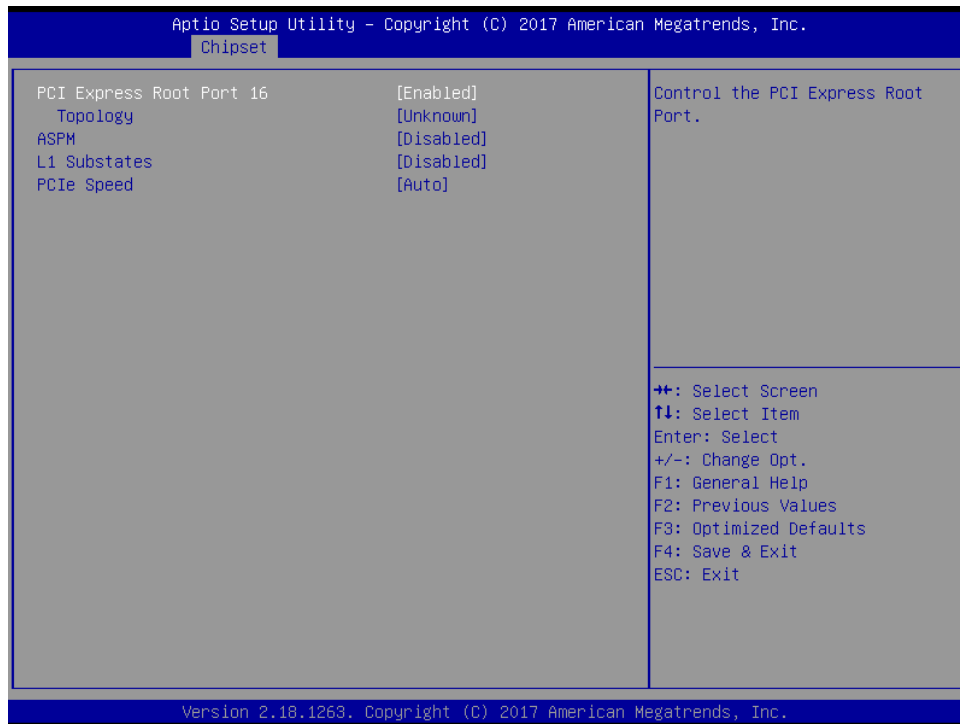

Item	Option	Description
PCI Express Root Port 16	Enabled[Default], Disabled	Control the PCI Express Root Port.
Topology	Unknown x1[Default], x4 Sata Express M2	Identify the SATA Topology if it is Default or ISATA or Flex or DirectConnect or M2.
ASPM	Disabled[Default], L0s L1 L0sL1 Auto	Set the ASPM Level: Force L0s – Force all links to L0s State AUTO – BIOS auto configure DISABLE – Disables ASPM.
L1 Substates	Disabled[Default], L1.1 L1.2	PCI Express L1 Substates settings.

EPS-KBLHE

	L1.1 & L1.2	
PCIe Speed	Auto[Default] Gen1 Gen2 Gen3	Configure PCIe Speed.
PCIE6 CLKREQ Mapping Override	Default[Default] No CLKREQ Custom number	PCIE CLKREQ Qverride for default platform mapping.

3.6.3.2.2 SATA And RST Configuration

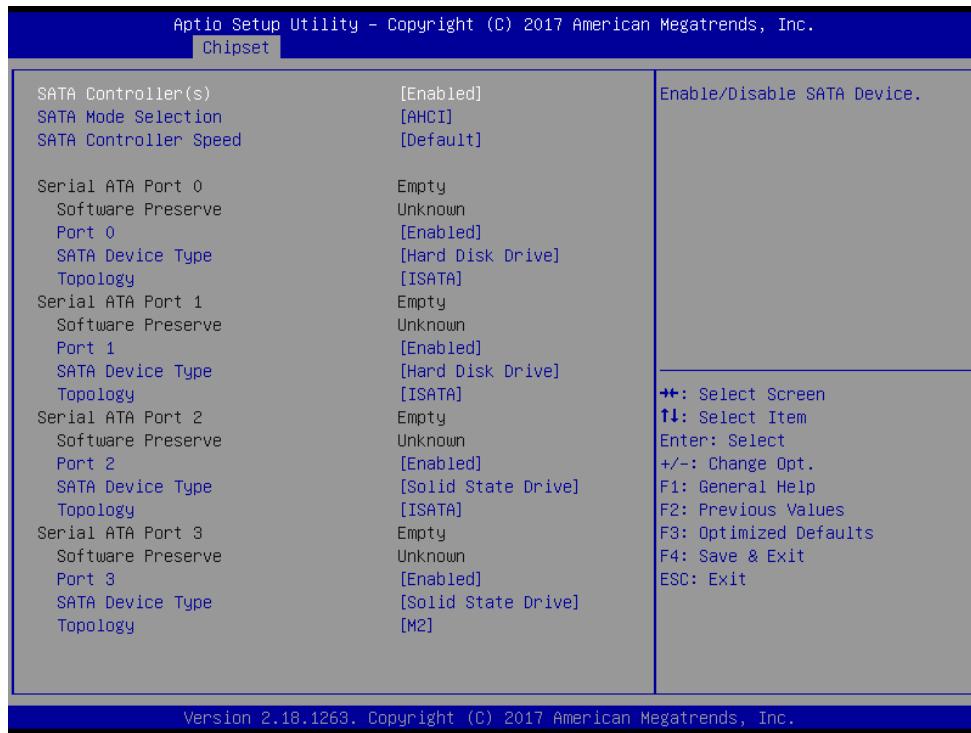

Item	Options	Description
SATA Controller(s)	Enabled[Default] Disabled,	Enable/Disable SATA Device.
SATA Mode Selection	AHCI[Default], RAID	Determines how SATA controller(s) operate.
SATA Controller Speed	Default[Default] Gen1 Gen2 Gen3	Indicates the maximum speed the SATA controller can support.
Port 0	Enabled[Default] Disabled	Enable or Disable SATA Port.
SATA Device Type	Hard Disk Drive[Default] Solid State Drive	Identify the SATA port is connected to Solid State Drive or Hard Disk Drive.
Technology	Unknown ISATA[Default] Direct Connect	Identify the SATA Topology if it is Default or ISATA or Flex or DirectConnect or M2.

Quick Reference Guide

	Flex M2	
Port 1	Enabled[Default] Disabled	Enable or Disable SATA Port.
SATA Device Type	Hard Disk Drive[Default] Solid State Drive	Identify the SATA port is connected to Solid State Drive or Hard Disk Drive.
Technology	Unknown ISATA[Default] Direct Connect Flex M2	Identify the SATA Topology if it is Default or ISATA or Flex or DirectConnect or M2.
Port 2	Enabled[Default] Disabled	Enable or Disable SATA Port.
SATA Device Type	Hard Disk Drive Solid State Drive[Default]	Identify the SATA port is connected to Solid State Drive or Hard Disk Drive.
Technology	Unknown ISATA[Default] Direct Connect Flex M2	Identify the SATA Topology if it is Default or ISATA or Flex or DirectConnect or M2.
Port 3	Enabled[Default] Disabled	Enable or Disable SATA Port.
SATA Device Type	Hard Disk Drive Solid State Drive[Default]	Identify the SATA port is connected to Solid State Drive or Hard Disk Drive.
Technology	Unknown ISATA Direct Connect Flex M2[Default]	Identify the SATA Topology if it is Default or ISATA or Flex or DirectConnect or M2.

3.6.3.2.3 USB Configuration

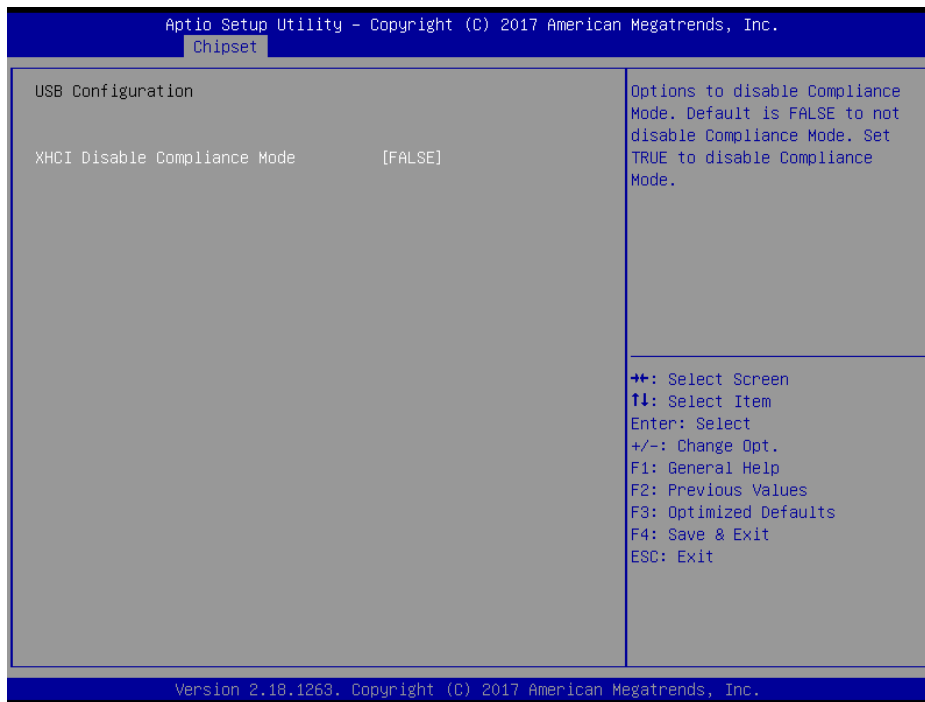

Item	Option	Description
XHCI Disable Compliance Mode	FALSE[Default], TRUE	Option to disable Compliance Mode. Default is FALSE to not disable Compliance Mode. Set TRUE to disable Compliance Mode.

3.6.3.2.4 HD Audio Configuration



Item	Option	Description
HD Audio	Disabled Enabled Auto[Default],	Control Detection of the HD-Audio device. Disable = HDA will be unconditionally disabled Enabled = HDA will be unconditionally enabled Auto = HDA will be enabled if present, disabled otherwise.

3.6.4 Security

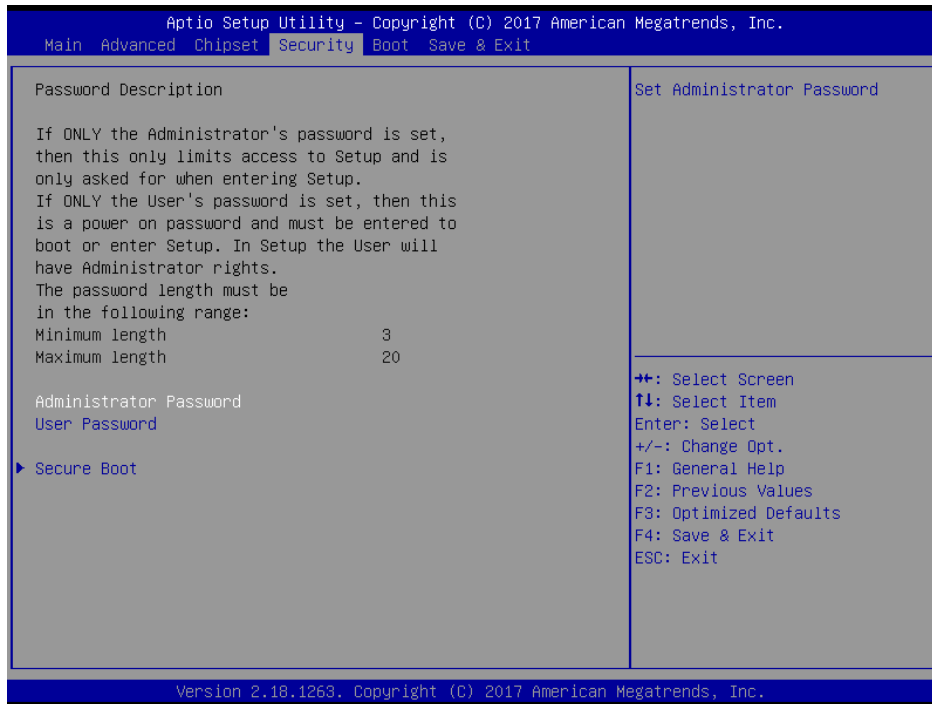

- **Administrator Password**

Set setup Administrator Password

- **User Password**

Set User Password

3.6.4.1 Secure Boot

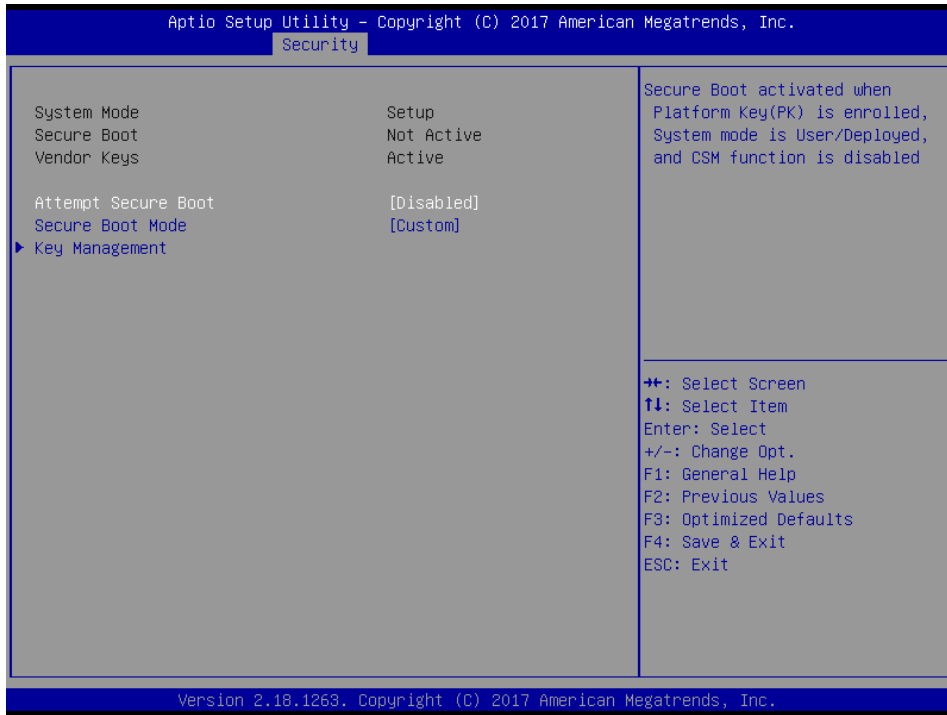

Item	Option	Description
Attempt Secure Boot	Disabled[Default] Enabled	Secure Boot can be enabled if 1.System running in User mode with enrolled Platform Key(PK) 2.CSM function is disabled.
Secure Boot Mode	Standard Custom[Default]	Secure Boot mode selector: Standard/Custom. In Custom mode Secure Boot Variables can be configured without authentication.

3.6.4.1.1 Key Management

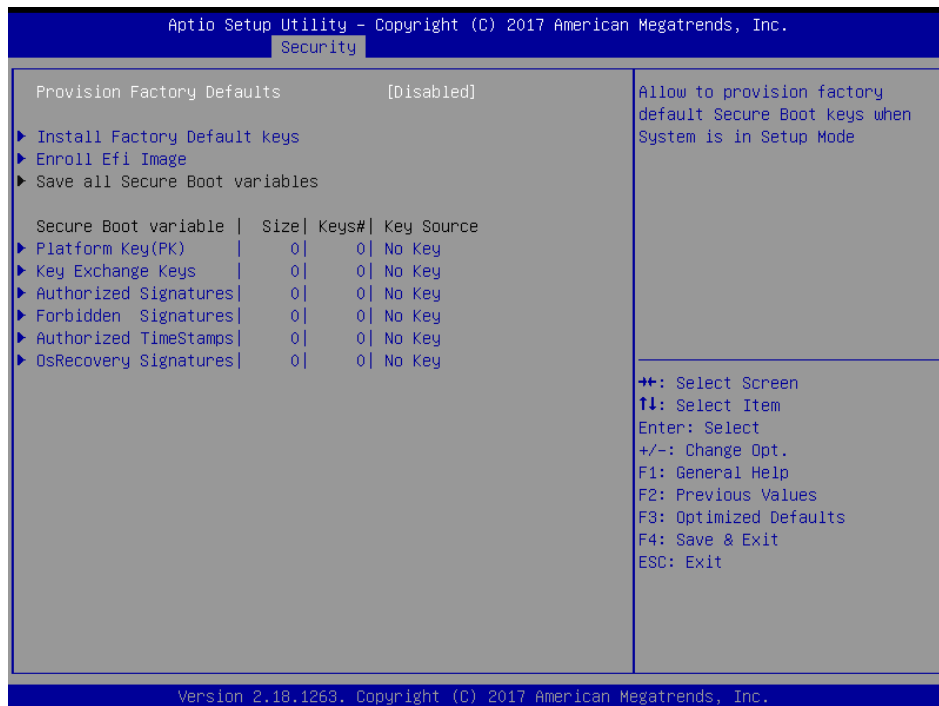

Item	Option	Description
Provision Factory Defaults	Disabled[Default] Enabled	Allow to provision factory default Secure Boot keys when System is in Setup Mode.

3.6.5 Boot

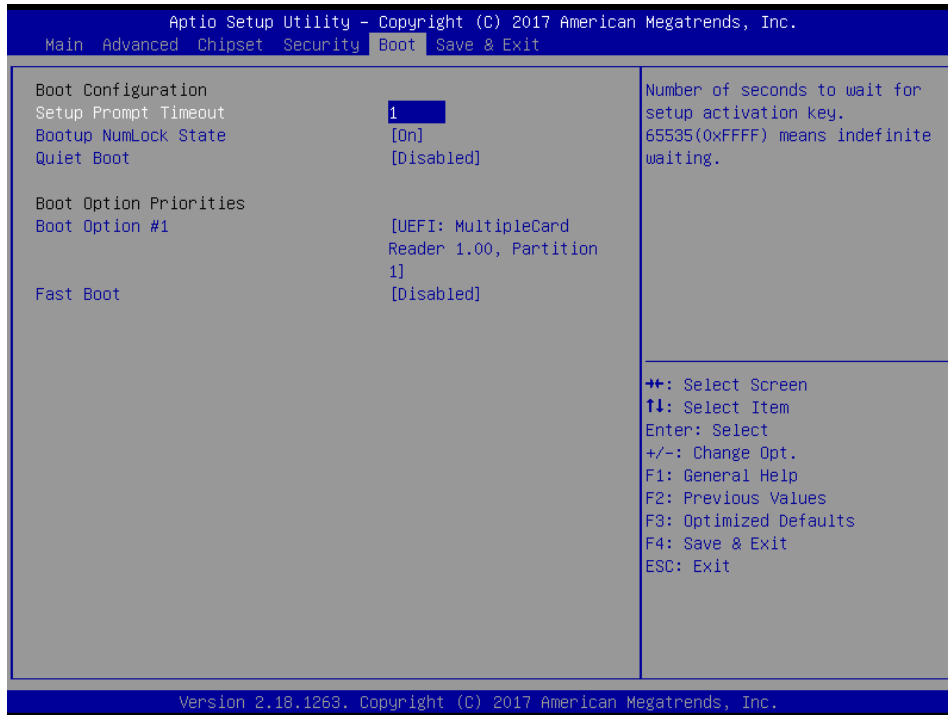

Item	Option	Description
Setup Prompt Timeout	1~ 65535	Number of seconds to wait for setup activation key. 65535(0xFFFF) means indefinite waiting.
Bootup NumLock State	On[Default] Off	Select the Keyboard NumLock state
Quiet Boot	Disabled[Default] Enabled	Enables or disables Quiet Boot option
Fast Boot	Disabled[Default] Enabled	Enables or disables boot with initialization of a minimal set of devices required to launch active boot option. Has no effect for BBS boot options.
Boot Option #1	Set the system boot order.	

3.6.6 Save and exit

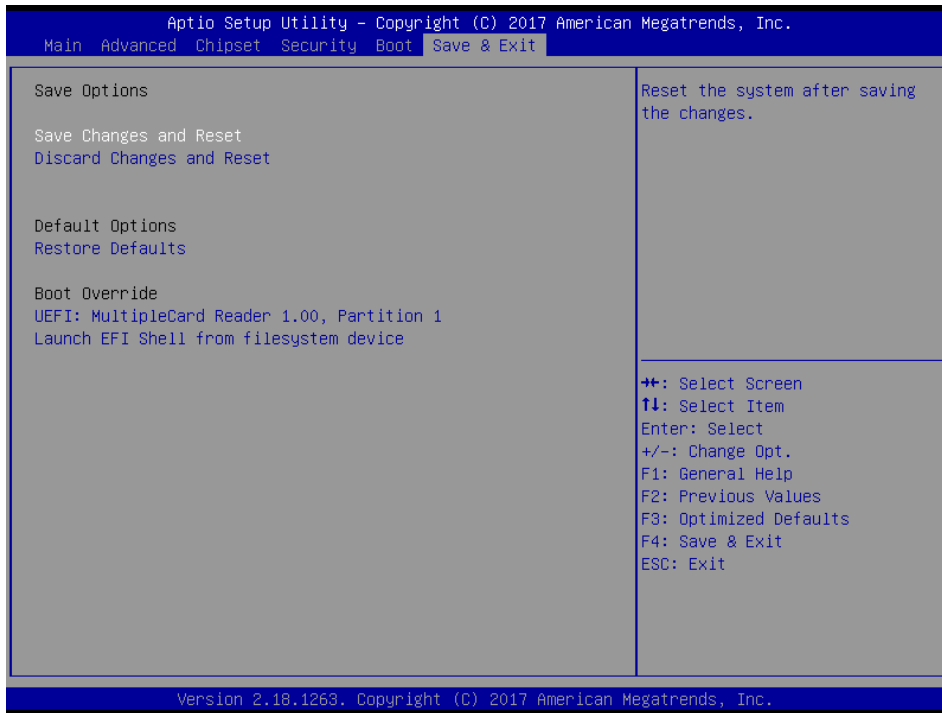

3.6.6.1 Save Changes and Reset

Reset the system after saving the changes.

3.6.6.2 Discard Changes and Reset

Any changes made to BIOS settings during this session of the BIOS setup program are discarded. The setup program then exits and reboots the controller.

3.6.6.3 Restore Defaults

This option restores all BIOS settings to the factory default. This option is useful if the controller exhibits unpredictable behavior due to an incorrect or inappropriate BIOS setting.

3.6.6.4 Launch EFI Shell from filesystem device

Attempts to Launch EFI Shell application (Shellx64.efi) from one of the available filesystem devices.

4. Drivers Installation



Note: Installation procedures and screen shots in this section are for your reference and may not be exactly the same as shown on your screen.

4.1 Install Chipset Driver

Insert the Supporting DVD-ROM to DVD-ROM drive, and it should show the index page of Avalue's products automatically. If not, locate Index.htm and choose the product from the menu left, or link to **/Driver_Chipset/Intel/ECM-KBLH**.



Note: The installation procedures and screen shots in this section are based on Windows 10 operation system. If the warning message appears while the installation process, click Continue to go on.

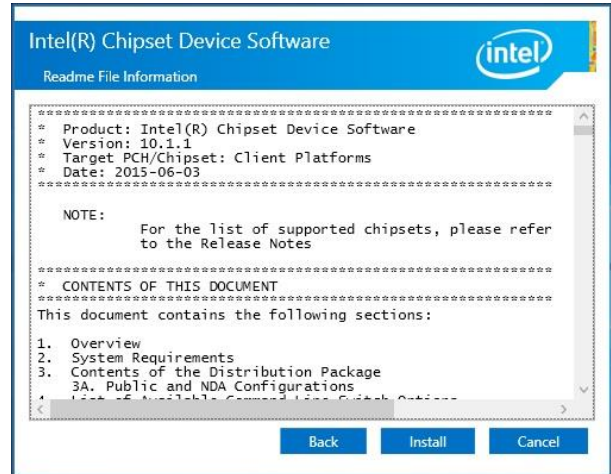

Step 3. Click Install.



Step1. Click Next.



Step 4. Complete setup.

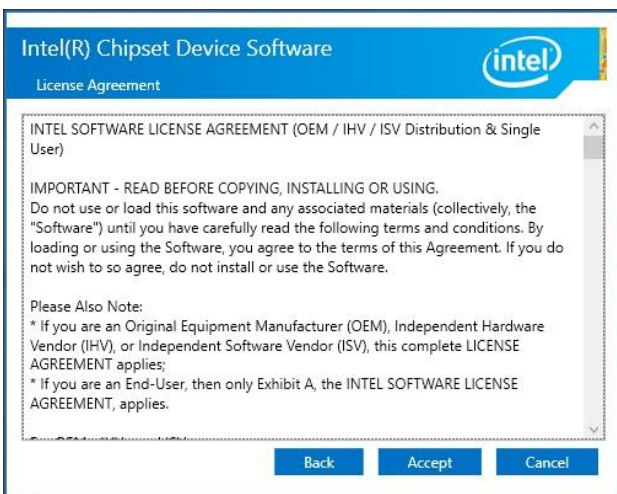

Step 2. Click Accept.

4.2 Install Display Driver

Insert the Supporting DVD-ROM to DVD-ROM drive, and it should show the index page of Avalue's products automatically. If not, locate Index.htm and choose the product from the menu left, or link to **/VGA/ECM-KBLH**.



Note: The installation procedures and screen shots in this section are based on Windows 10 operation system.

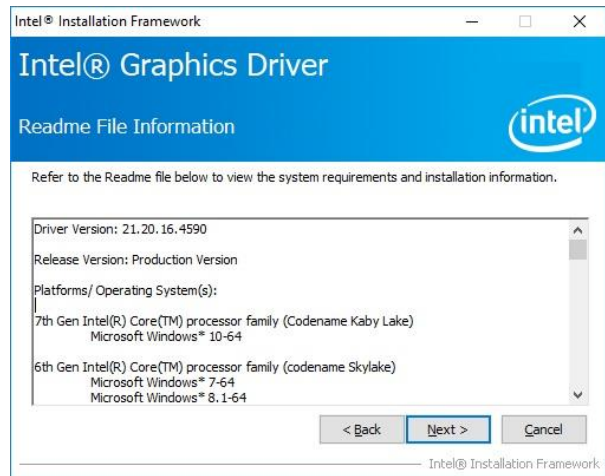

Step 3. Click Next.

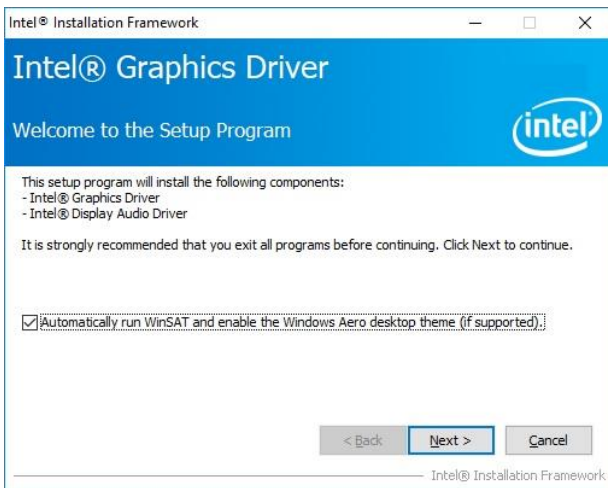

Step 1. Click Next to continue installation.

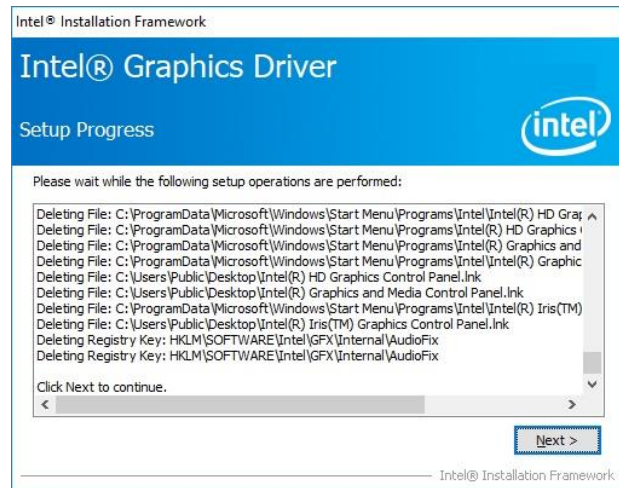

Step 4. Click Next.

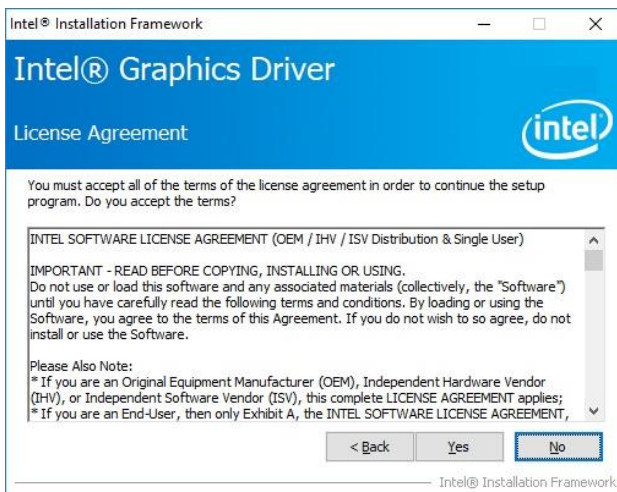

Step 2. Click Yes to accept license agreement.

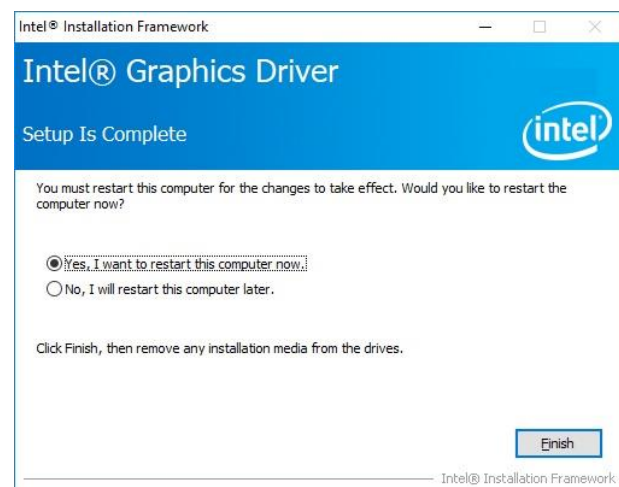

Step 5. Click Finish to complete setup.

4.3 Install LAN Driver (For Intel I219LM)

Insert the Supporting DVD-ROM to DVD-ROM drive, and it should show the index page of Avalue's products automatically. If not, locate Index.htm and choose the product from the menu left, or link to /Driver_Gigabit/Intel/I219LM/ECM-KBLH_LAN.



Note: The installation procedures and screen shots in this section are based on Windows 10 operation system.

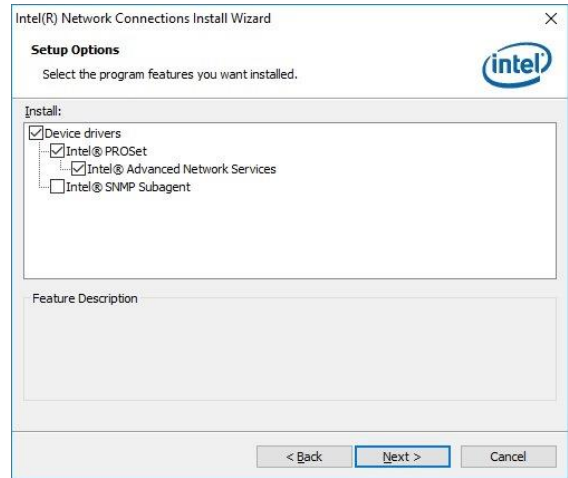

Step 3. Click Next.

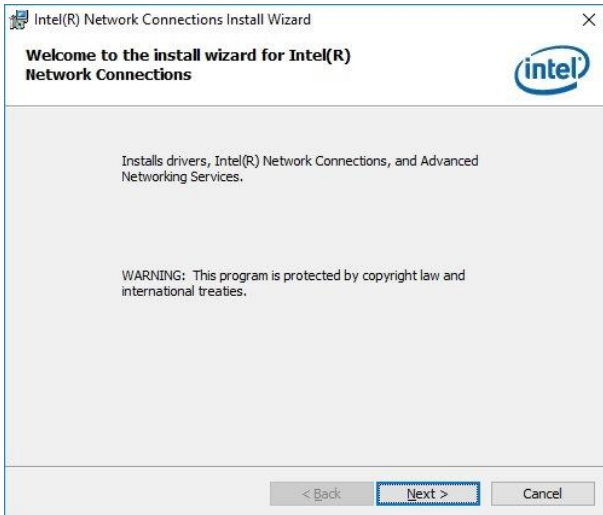

Step 1. Click Next.

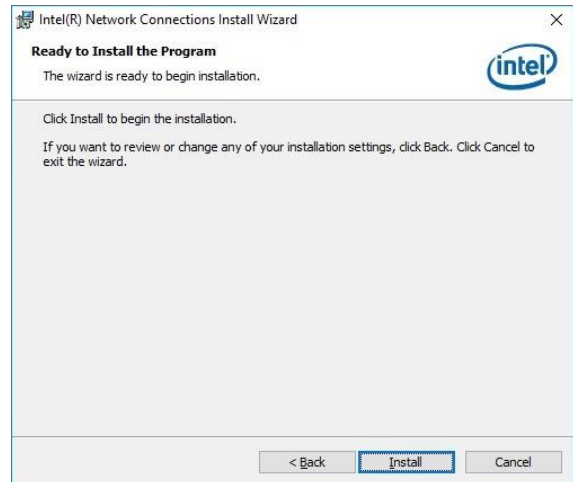

Step 4. Click Install.



Step 2. Click Next.

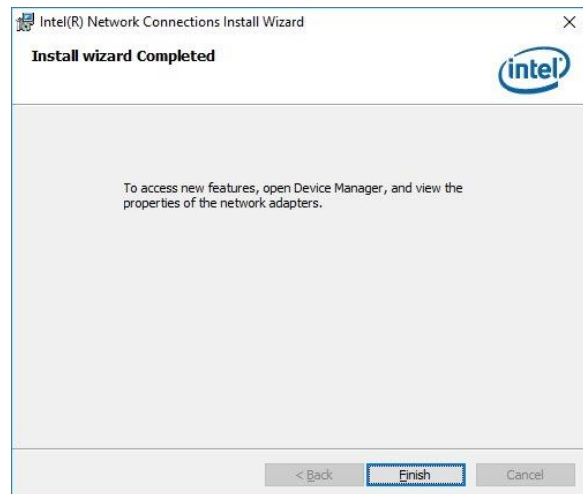

Step 5. Click Finish to complete setup.

4.4 Install ME Driver

Insert the Supporting DVD-ROM to DVD-ROM drive, and it should show the index page of Avalue's products automatically. If not, locate Index.htm and choose the product from the menu left, or link to **/Utility/ECM-KBLH_ME**.



Note: The installation procedures and screen shots in this section are based on Windows 10 operation system. If the warning message appears while the installation process, click Continue to go on.

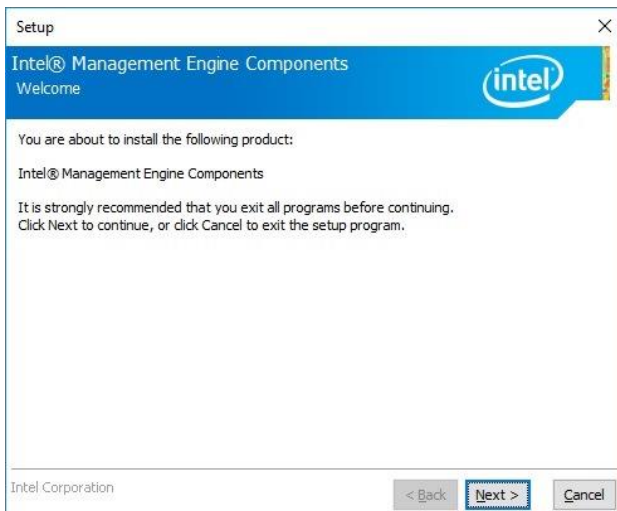

Step 1. Click **Next** to start installation.

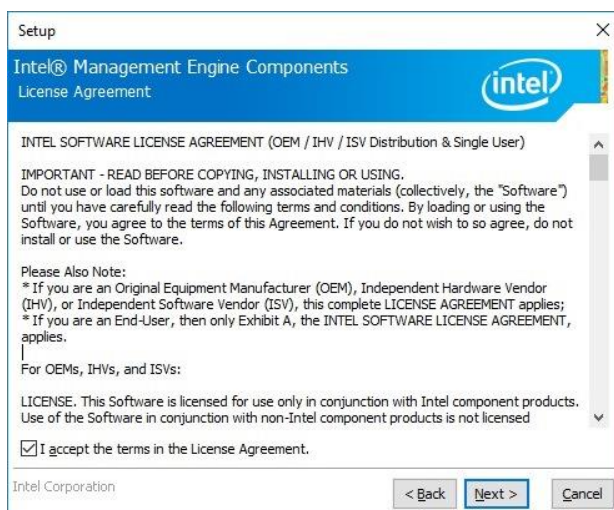

Step 2. Click **Next**.

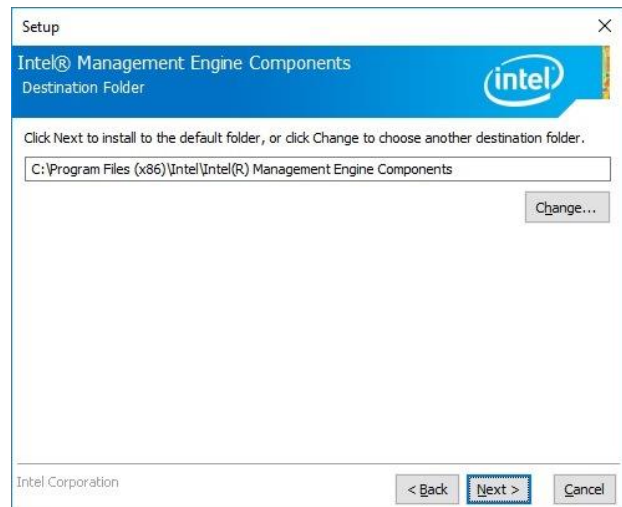

Step 3. Click **Next**.

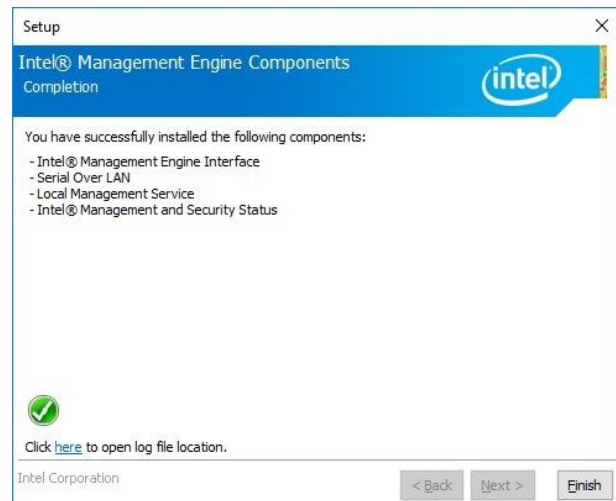

Step 4. Click **Finish** to complete setup.

4.5 Install Serial IO Driver

Insert the Supporting DVD-ROM to DVD-ROM drive, and it should show the index page of Avalue’s products automatically. If not, locate Index.htm and choose the product from the menu left, or link to **/Utility/ECM-KBLH_SerialIO**.



Note: The installation procedures and screen shots in this section are based on Windows 10 operation system.

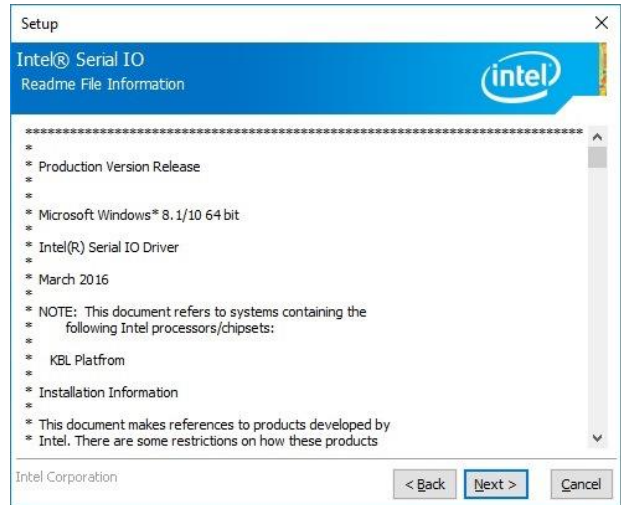

Step 3. Click Next.

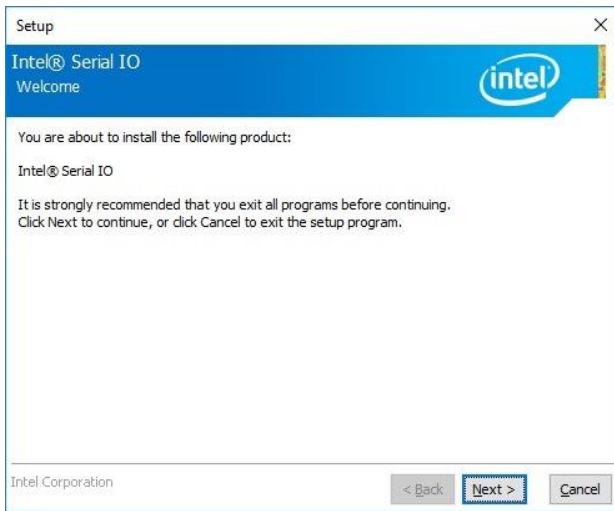

Step 1. Click Next to continue installation.

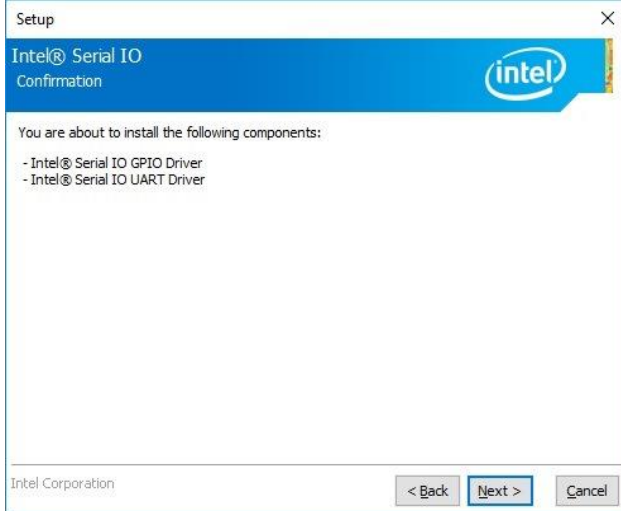

Step 4. Click Next.



Step 2. Click Next.



Step 5. Complete setup.

4.6 Install Audio Driver (For Realtek ALC233)

Insert the Supporting DVD-ROM to DVD-ROM drive, and it should show the index page of Avalue's products automatically. If not, locate Index.htm and choose the product from the menu left, or link to **/Driver_Audio/Realtek/ALC233/ECM-KBLH_Audio**.



Note: The installation procedures and screen shots in this section are based on Windows 10 operation system.

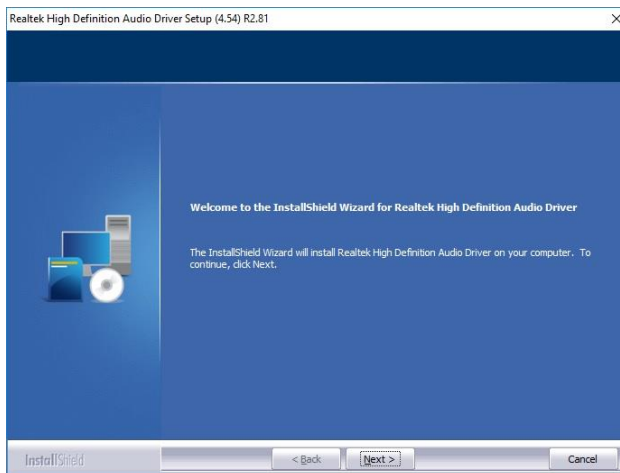

Step 1. Click **Next** to continue installation.

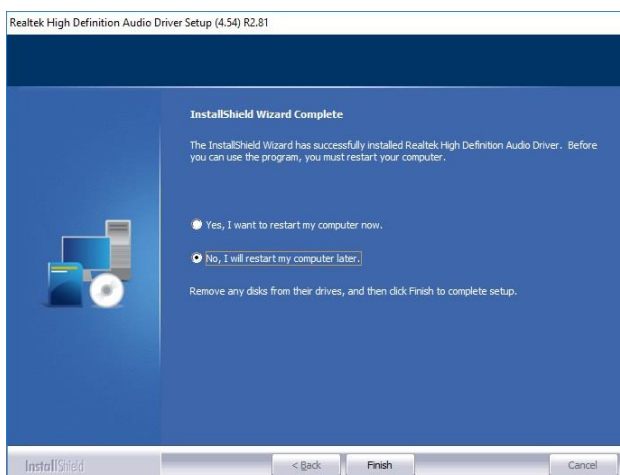

Step 2. Click **Finish** to complete setup.

