

Q8

1U Active Air Cooler

PRODUCT SPECIFICATIONS

Rev_1.0

Table of Contents

1. REVISION HISTORY.....	3
2. PRODUCT DESCRIPTION	4
3. THERMAL PERFORMANCE CHART.....	5
4. EP DRAWING	6
5. DM DRAWING	7
6. BLOWER SPECIFICATION	8-21
7. RoHS CERTIFICATE	22

Document History List

REV_0.0	INITIAL RELEASE	MAR. 18, 2022
REV_1.0	UPDATE PRODUCT PERFORMANCE CHART	AUG. 23, 2022

Q8 | Socket LGA 1700

Model Number: Q8

- Recommend for Intel® CPU as following
 - Intel® Alder Lake S Processor, Socket LGA 1700
- Active Cooler for 1U Server & Up

Overall Specification

Dimension	90.0 x 95.0 x 28 mm
Weight	450 ± 5 g
Material	Copper Heat Sink with Skiving Fins
Orientations	Switchable without On-board Component Interference
Hestsink mounting	Push-Pin mounting set included
Thermal Grease	SHIN-ETSU 7762 Pre-printed
TDP	Up to 125 Watts CPU Power Heat Dissipation

Cooling Fan Specification

Model Number	DB128015BU-PWMG
Dimension	Ø80 x 15 mm
Bearing	Double Ball
Rated Voltage	12V
Rated Speed	At Duty Cycle 0~20%: 1000±200 RPM At Duty Cycle 50%: 3500±10% RPM At Duty Cycle 100%: 7000 RPM
Rated Input Power	At Duty Cycle 0~20%: 0.60 W At Duty Cycle 50%: 3.84 W At Duty Cycle 100%: 19.2 W
Rated Airflow	At Duty Cycle 0~20%: 6.5 CFM At Duty Cycle 50%: 11.2 CFM At Duty Cycle 100%: 22.28 CFM
Rated Static Pressure	At Duty Cycle 0~20%: 2.27 mm-H2O At Duty Cycle 50%: 18.56 mm-H2O At Duty Cycle 100%: 74.18 mm-H2O
Acoustical Noise	At Duty Cycle 0~20%: 21.5 dBA At Duty Cycle 50%: 43.0 dBA At Duty Cycle 100%: 59.14 dBA
Lead Wire Pin Out	Pin#1- Black(-) Pin#2- Yellow(+) Pin#3- Green(Tachometer/ Signal Output) Pin#4- Blue (PWM)

Q8 | Socket LGA 1700

Lead Wire Pin Out Diagram :

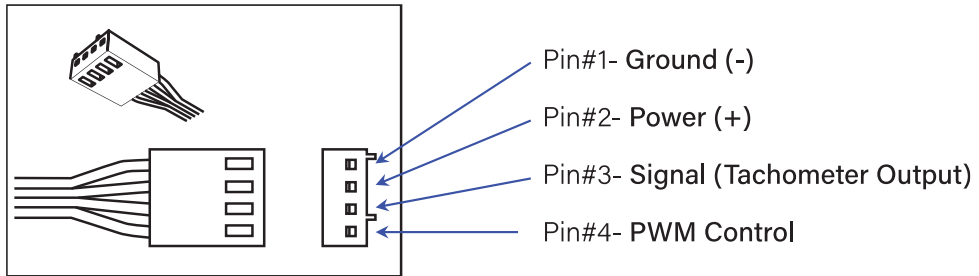

Performance Chart: Active Cooler Q8 Thermal Resistance

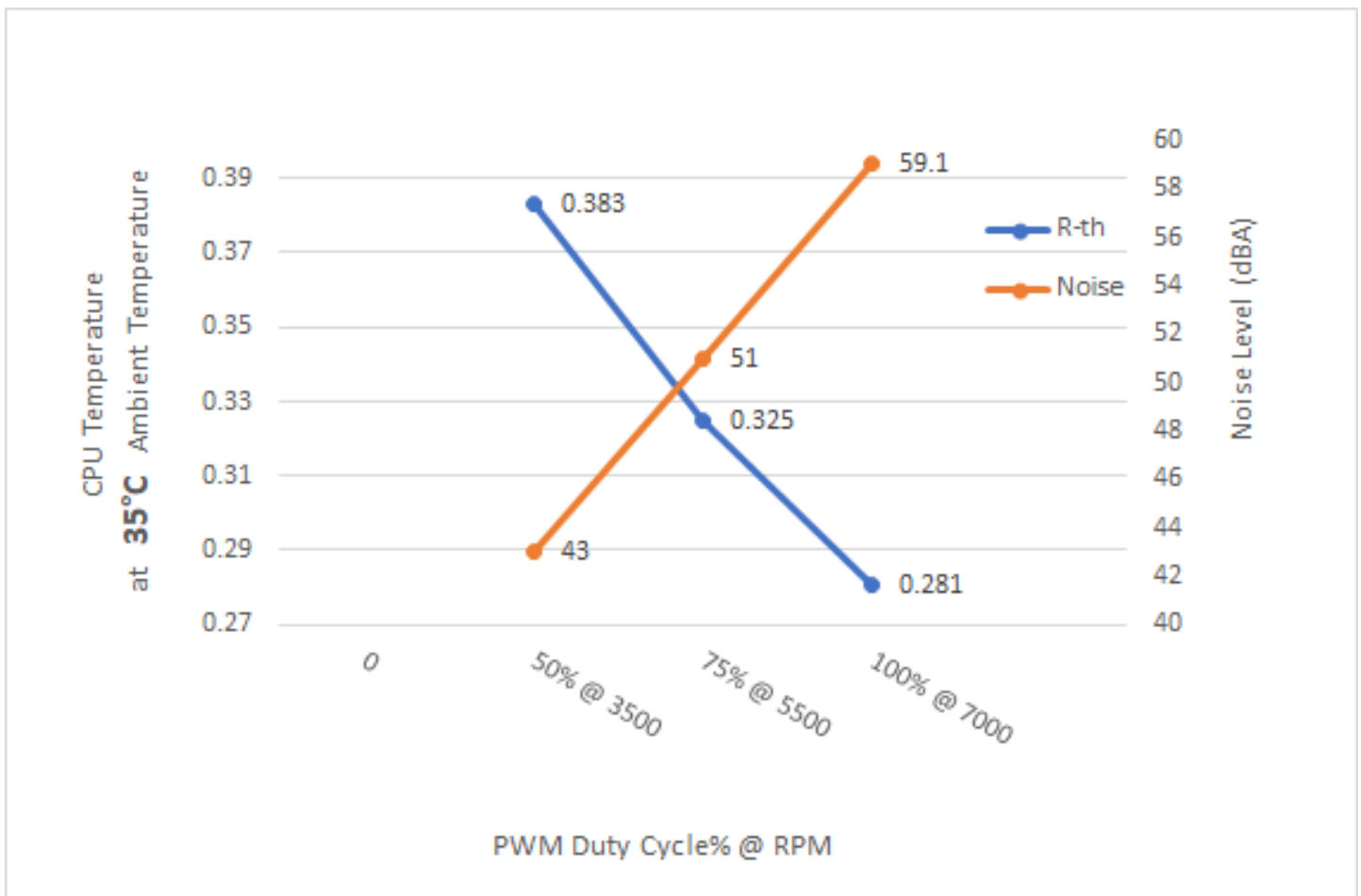

CONFIDENTIAL DOCUMENT

THIS DRAWING CONTAINS INFORMATION PROPRIETARY TO DYNATRON CORPORATION AND DYNAEON INDUSTRIAL CO., LTD. ANY REPRODUCTION, DISCLOSURE, OR USE OF THIS DRAWING IS EXPRESSLY PROHIBITED EXCEPT AS DYNATRON CORPORATION AND DYNAEON INDUSTRIAL CO., LTD. MAY OTHERWISE AGREE TO IN WRITING.

REV#	DESCRIPTION	CHECKER	DATE
0.0	INITIAL RELEASE	LANG	03/18/2022

ASSEMBLY PARTS

WHOLE SET OF HEATSINK

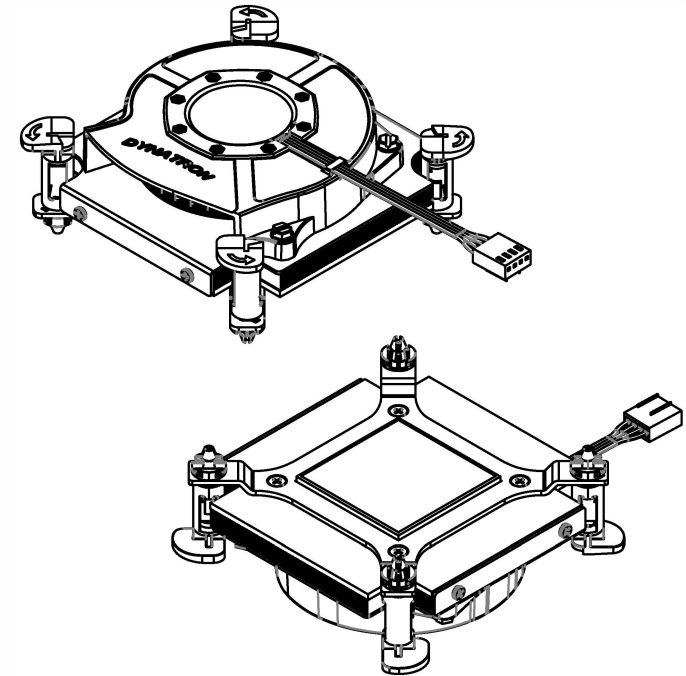
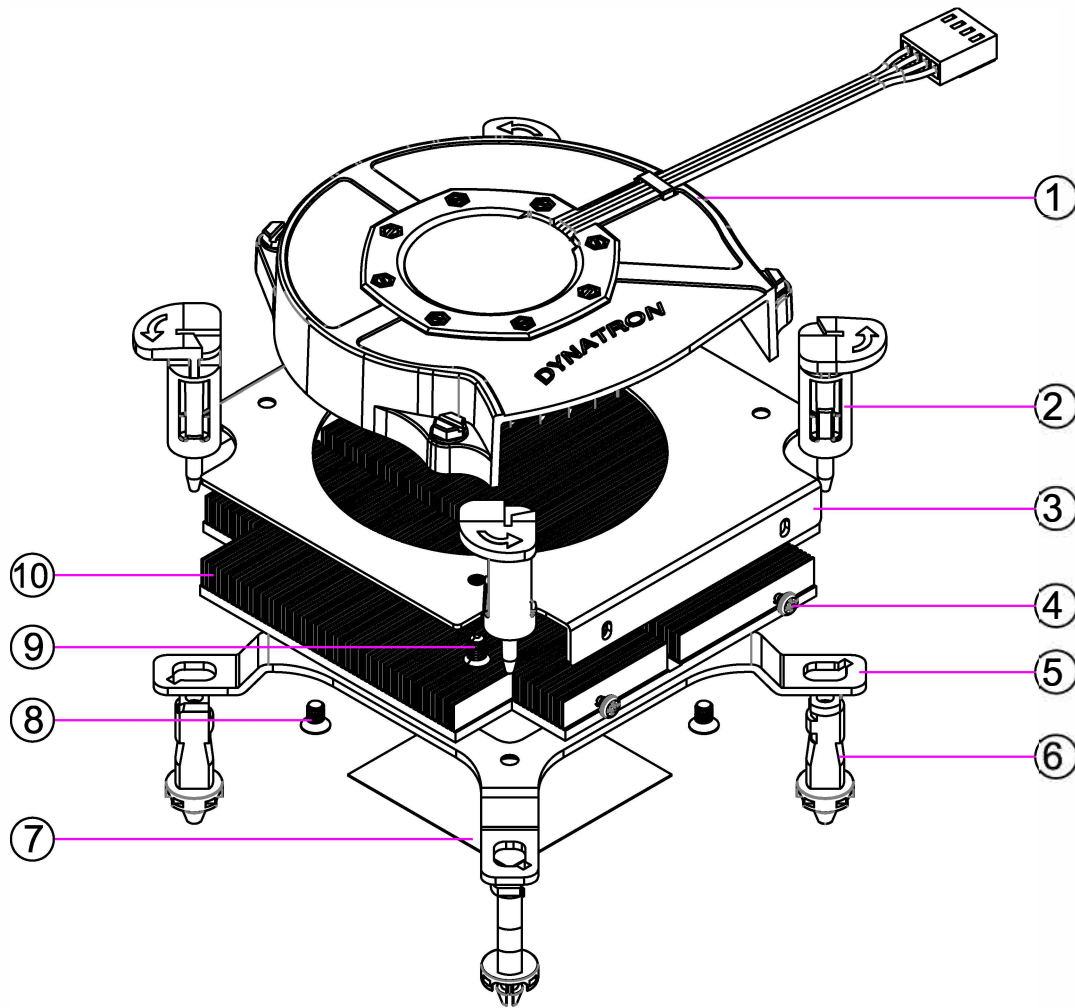

NOTES:

1. THE FIGURE IS FOR REFERENCE ONLY, AND NOT FOR SCALE
2. OVERALL DIMENSION : 95 x 90 x 28 mm
3. OVERALL WEIGHT ESTEMATED : 450 g

ITEM#	DESCRIPTION	MATERIAL	QTY.
10	HEATSINK, SKIVING FIN	COPPER 1100	1
9	SCREW, BLOWER FRAME MOUNTING, M3*0.5	STEEL	4
8	SCREW, RETENTION MOUNTING, M3*0.5	STEEL	4
7	THERMAL GREASE, PRE-PRINT	SHIN-ETSU 7762	1
6	PUSH PIN, LOWER-SIDE (WHITE COLOR)	PLASTIC	4
5	PUSH PIN RETENTION, THK 1.6 mm	SPCC	1
4	SCREW, COVER MOUNTING, Ø2 mm	STEEL	4
3	BLOWER AIRFLOW COVER	ALUMINUM	1
2	PUSH PIN, UPPER-SIDE (BLACK COLOR)	PLASTIC	4
1	BLOWER, DB128015BU-PWM, 7000 RPM	ALUMINUM FRAME	1

ITEM#	DESCRIPTION	MATERIAL	QTY.
	DATE	NAME	 DYNATRON CORPORATION TITLE: 1U Active Cooler Model Q8 BOM & Exploded Assembly Drawing
DRAWN	03/18/2022	Engr	
CHECKED	03/18/2022	LANG	
ENG. APPR.			
MFG. APPR.			
Q.A.			
COMMENTS:			DWG. No: DYN-EP-Q8
			REV 0.0

REV#	DESCRIPTION	CHECKER	DATE
0.0	INITIAL RELEASE	LANG	03/18/2022

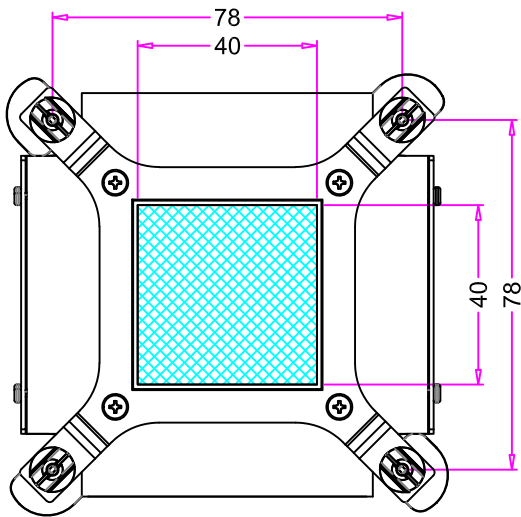
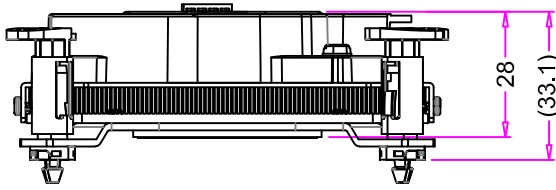
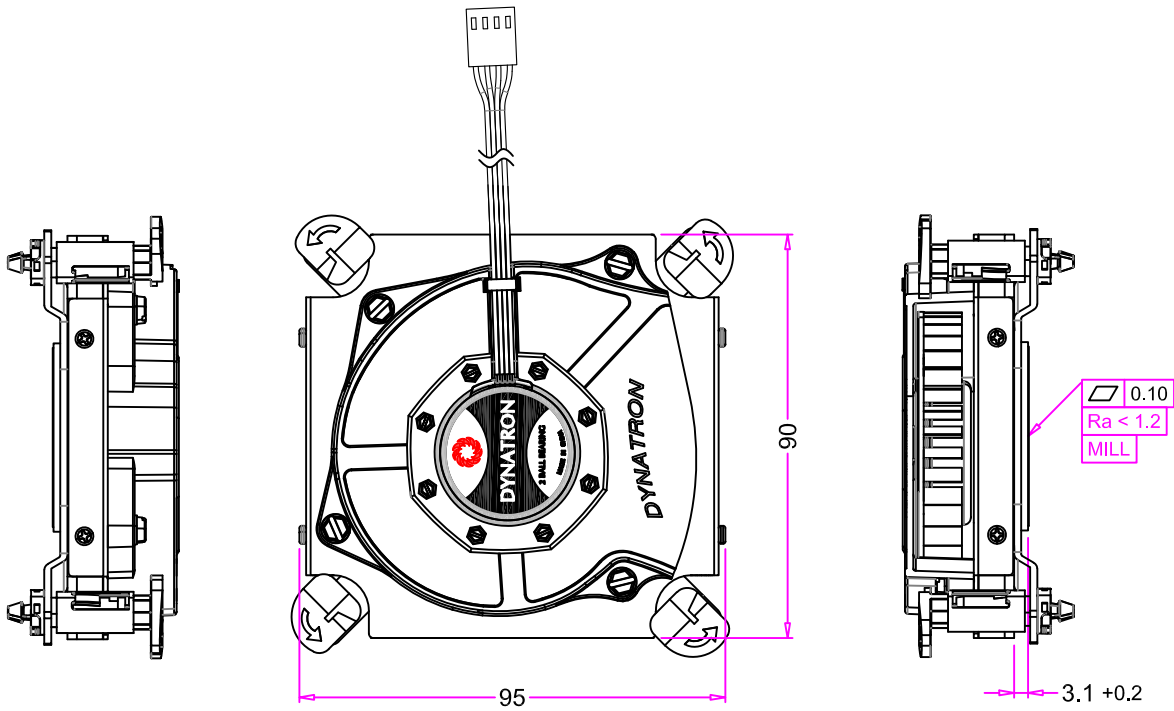
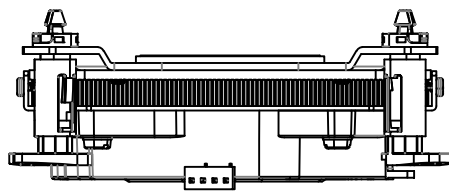

	NAME	DATE
DRAWN BY	ENGR	03/18/2022
CHECKED BY	LANG	03/18/2022
ENG.APPROVED		
MFG.APPROVED	-	-



DYNATRON CORPORATION

TOP MOTOR

TITLE: **1U Active Cooler Model Q8**
Overall Dimension Drawing

CONFIDENTIAL DOCUMENT

THIS DRAWING CONTAINS INFORMATION PROPRIETARY TO DYNATRON CORPORATION AND DYNAEON INDUSTRIAL CO., LTD. ANY REPRODUCTION, DISCLOSURE, OR USE OF THIS DRAWING IS EXPRESSLY PROHIBITED EXCEPT AS DYNATRON CORPORATION AND DYNAEON INDUSTRIAL CO., LTD. MAY OTHERWISE AGREE TO IN WRITING.

VIEW	
UNITS	MM

DWG. No: **DYN-DM-Q8**

REV. **0.0**



DYNATRON CORPORATION

TOP MOTOR TECHNOLOGY (HUIZHOU) CO, LTD

Specification for Approval

Customer:		
Model Number:	DB128015BU(80*80*15mm)	
Part Number:		
Issued Date:	Tuesday, January 17, 2017	
Version:	A	
Customer Approval		
Approval:	Check:	
Corporate Headquarters Dynatron Corporation 33200 Western Avenue Union City, CA 94587 U.S.A. Tel: 510-498-8888 Fax: 510-498-8488	<i>Taipei Office</i> <i>(Taiwan, R.O.C.)</i> 8F, No. 35,Lane:221 Gang Cian. Road, Taipei, Taiwan, R.O.C. Tel: 886-2-27995799 (Rep.) Fax: 886-2-2799-9577	Manufactory TOP MOTOR TECHNOLOGY(HUI ZHOU)CO,LTD Baishi Village,QiuchangTown, Huiyang Dist,HuizhouCity,Guangdong Province,P.R.China Tel: 86-752-822-8000 (Rep.) Fax: 86-752-822-8999
Approval:	Check:	Handler:
Simon Wang	-	Hui mei



DYNATRON CORPORATION

TOP MOTOR TECHNOLOGY (HUIZHOU) CO, LTD

	CONTENTS	Page
1.	SCOPE	3
2.	ELECTRICAL CHARACTERISTICS	3
3.	MECHANICAL CHARACTERISTICS	4
4.	ENVIRONMENTAL	4
5.	PROTECTION	5
6.	ATTACHMENTS	
	6.1. Product Dimension	6
	6.2. Frequency Generator Output.	7
	6.3. TUV Certificate	8
	6.4. UL Certificate	9-12
	6.5. Electrical specifications for PWM production	13-14



DYNATRON CORPORATION

TOP MOTOR TECHNOLOGY (HUIZHOU) CO, LTD

1. SCOPE

This specification defines the electrical and mechanical characteristics of the AC / DC Brush less (Liquid State / 2-Balls Bearing)axial flow fan, which is carefully designed and manufactured for your special needs by Dynatron Corporation.

2. ELECTRICAL CHARACTERISTICS

Items		Description		
1.	Rated Voltage	DC 12 V		
3.	PWM Frequency 25KHz	Duty Cycle D=0-20%	Duty Cycle D=50%	Duty Cycle D=100%
4.	Start Voltage	7V		
5.	Air Flow – At rated voltage zero static pressure (minimal value)	0.184 m ³ /z min (6.50CFM)	0.361m ³ /z min (12.73CFM)	0.631m ³ /z min (22.28CFM)
6.	Static Pressure – At rated voltage At zero air flow	2.27mm-H ₂ O (0.09inch-H ₂ O)	24.22mm-H ₂ O (0.954nch-H ₂ O)	74.18mm-H ₂ O (2.92inch-H ₂ O)
7.	Input Current (Max.)	0.05A	0.32A	1.60A
8.	Speed (Max.)	1000RPM ±200RPM	4000RPM ±10%	7000RPM ±10%
9.	Acoustical Noise	21.50dBA	47.00dBA	59.15dBA
10.	Input Power	0.6W	3.84W	19.2W
11.	Insulation Resistance – Between Frame and Terminal	10 M ohm at DC 500 V		
12.	Dielectric Strength – Between Frame and Terminal	5 mA (Max.) @ AC 500 V 60 Hz 1 min.		
13.	Life – Continuous operating under normal temperature (40°C or 104°F)	70,000 hours		
14.	Rotation	Anticlockwise Air Discharged		
15.	Lead Wires	UL 1061, awg 26 or Equivalent “-”: Black; “+”:Black;”s”: Black. ”PWM”: Black.		



DYNATRON CORPORATION

TOP MOTOR TECHNOLOGY (HUIZHOU) CO, LTD

3. MECHANICAL CHARACTERISTICS

Items		Description
1.	Dimension	Display as Drawing
2.	Frame	Aluminum
3.	Impeller	PBT UL94V-0 (Black GP)
4.	Bearing System	Two ball Bearing
5.	Weight	60 ±10grams

4. ENVIRONMENTAL

Items		Description
1.	Operating Temperature	- 10 °C ~ + 65 °C (65 %RH)
2.	Storage Temperature	- 30 °C ~ + 70 °C (65 %RH)
3.	Vibration Test	Displacement Amplitude: 0.75mm(Equivalent 10G) Frequency Range: 10Hz<->55Hz/30SEC. Linear Scanning 120 Cycle Endurance Timer Per Axis: 30Min. Orientation:X,Y,Z.
4.	Drop Test	Motor withstands one free body drop from 30 cm in high onto 10 mm thickness of wooden board for each of the three faces in minimum packing condition.
5.	Acoustic Noise	59.15dBA – Curve (Max59.65dBA) Measuring Condition – Under rated voltage in semi-anechoic chamber equipment sound level meter. (Figure A.)

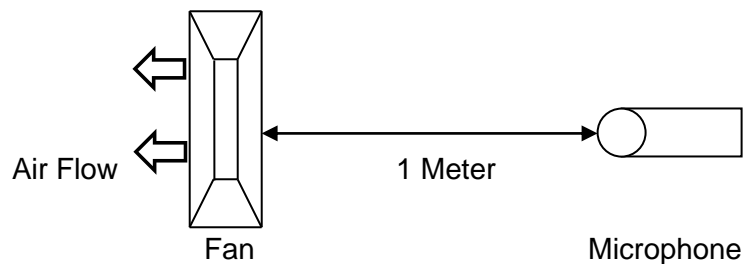

Figure A – Noise Level is measure at rated voltage in anechoic chamber in free air as above.



DYNATRON CORPORATION

TOP MOTOR TECHNOLOGY (HUIZHOU) CO, LTD

5. PROTECTION

Items		Description
1.	Polarity Protection	For polarity error connection to power, the circuit withstands reversed connection between positive and negative leads.

6. ATTACHMENTS

- 6.1. Product Dimension
- 6.2. Frequency Generator Output
- 6.3. TUV Certificate
- 6.4. UL Certificate
- 6.5. Electrical Specifications for pwm production



DYNATRON CORPORATION

TOP MOTOR TECHNOLOGY (HUIZHOU) CO, LTD

6.1. Product Dimension

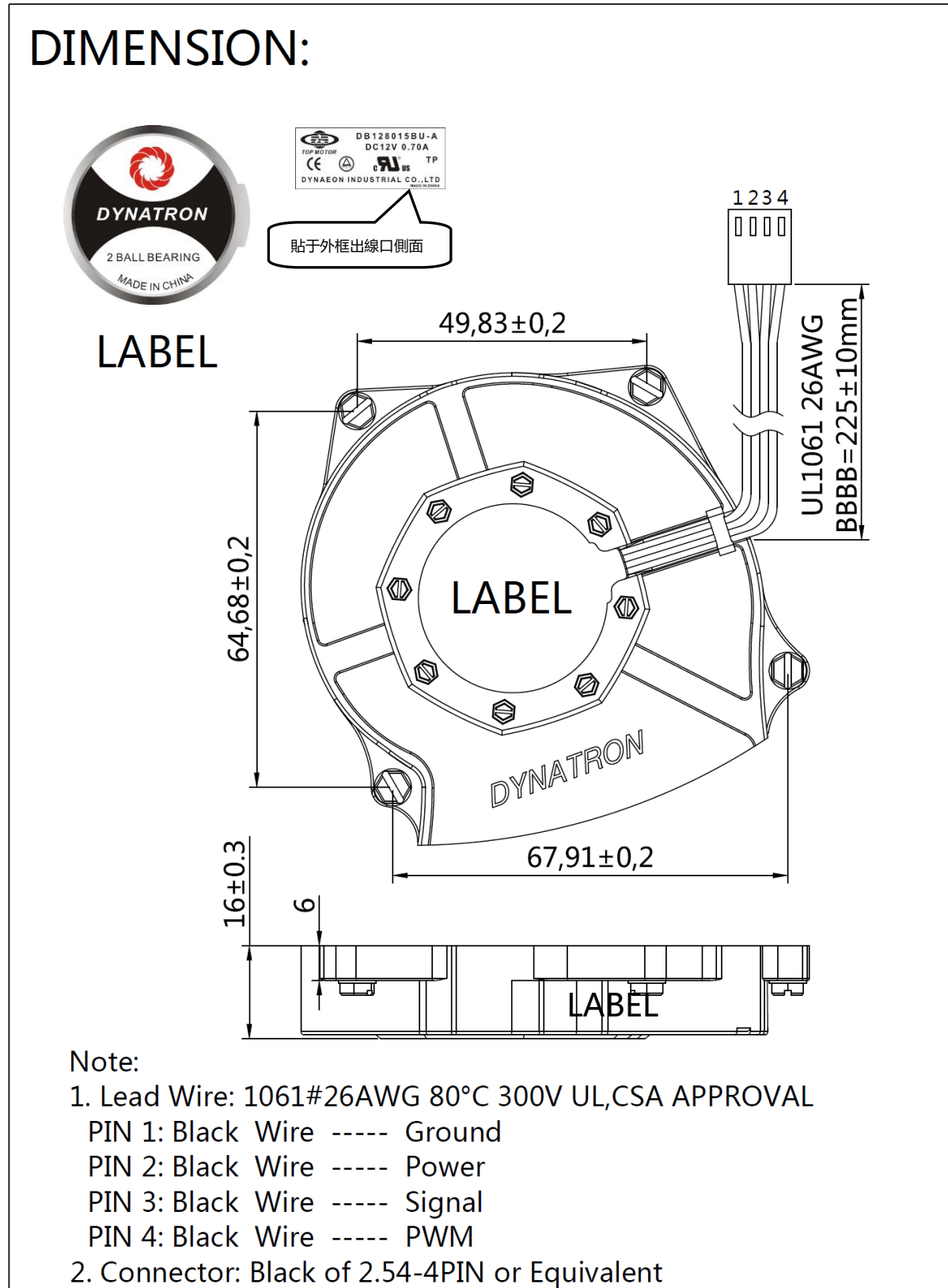



DYNATRON CORPORATION

TOP MOTOR TECHNOLOGY (HUIZHOU) CO, LTD

6.2. Frequency Generator Output

FREQUENCY GENERATOR O/P:

Frequency generator function is activated by an internal IC for customer's application.
Electrical schematic:

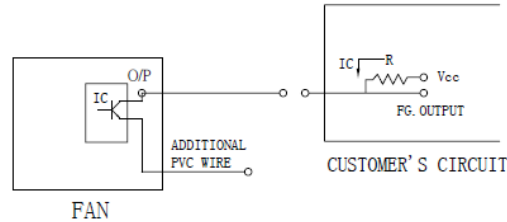

CUSTOMER'S CIRCUIT

V_{cc} = From +5 To +28 VDC (Generally using +12 or +24 VDC)
 I_c = 5 mA max.
 $R = V/I$ (Output "R" value calculation)

● SUPPLY A WAVEFORM:

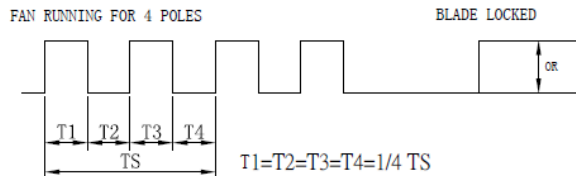

$N=R.P.M.$ (Rotation speed will be different for various models
 L/M/H/HH/VH/SH)

$$TS = 60/N \text{ (Sec)}$$

* Voltage level after blade locked

● OUTPUT LEVEL:

High = V_{cc} 10%
 Low = 0~0.5V
 I_c = 5 mA max.

● APPLICATION:

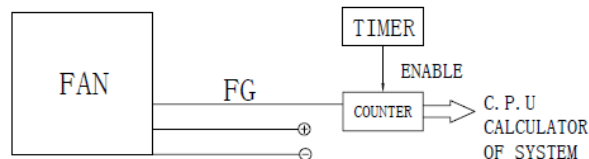

● FUNCTIONS:



- By means of waveform & customer's design, schematic can reach alarm function, either in the form of buzzing or LED flashing. Adjust rotation speed.
- When power supply output voltage level decreases, it will result in the lowering of fan rotation speed. The irregular situation will be controlled by using FG. O/P through P/S circuit to increase the output voltage and result in a stable rotation speed.



DYNATRON CORPORATION

TOP MOTOR TECHNOLOGY (HUIZHOU) CO, LTD

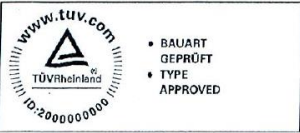
6.3. TUV Certificate

Zertifikat		Certificate			
Zertifikat Nr. Certificate No.	Blatt Page				
R 50064443	0014				
Ihr Zeichen Client Reference	Unser Zeichen Our Reference	Ausstellungsdatum	Date of Issue		
8143502687/JL030112	ZTW1-LinPa- 10013649	011 30.01.2012	(day/mo/yr)		
Genehmigungsinhaber License Holder		Fertigungsstätte Manufacturing Plant			
Dynaeon Industrial Co., Ltd.		Top Motor Technology (Huizhou)			
8F, No. 35, 37, Lane 221		Co., Ltd.			
Gang Cian Rd.		Baishi Village,			
Neihu, Taipei 114		Qiuchang Town, Huiyang District			
Taiwan, R.O.C.		Huizhou City, Guangdong			
		P.R. China			
Prüfzeichen Test Mark	Geprüft nach Tested acc. to				
	EN 60950-1:2006+A11				
Zertifiziertes Produkt (Geräteidentifikation)	Lizenzentgelte - Einheit				
Certified Product (Product Identification)	License Fee - Unit				
<u>Ventilator</u> (DC Fan)					
wie Blatt (as page) 01					
Ergänzung (Addition)					
Bezeichnung (Type Designation)	: 1) DB128015(X)(Y)-ZZZZZ-B				1
	2) DF126028(X)(Y)-ZZZZZ-A				1
	3) DB127515(X)(Y)-ZZZZZ-A				1
	4) DF129225(X)(Y)-ZZZZZ-A				1
(X) steht für (stands for)	: S, B, P, Q				1
(Y) steht für (stands for)	: 1,3,4) U, H, M, L				1
Z steht für (stands for)	: A-Z, 0-9 oder (or) freibleibend (blank)				1
Nennspannung (Rated Voltage)	: DC 12V				
Nennstrom (Rated Current)	: siehe Anlage (see appendix)				
7					
ANLAGE (Appendix): 1					
Dem Zertifikat liegt unsere Prüf- und Zertifizierungsordnung zugrunde und es bestätigt die Konformität des Produktes mit den oben genannten Standards und Prüfgrundlagen. Zusätzliche Anforderungen in Ländern, in denen das Produkt in Verkehr gebracht werden soll, müssen zusätzlich betrachtet werden. Die Herstellung des zertifizierten Produktes wird überwacht.					
This certificate is based on our Testing and Certification Regulation and states the conformity of the product with the standards and testing requirements as indicated above. Any additional requirements in countries where the product is going to be marketed have to be considered additionally. The manufacturing of the certified product is subject to surveillance.					
TÜV Rheinland LGA Products GmbH - Tillystraße 2 - 90431 Nürnberg				Zertifizierungsstelle	
Tel.: (+49/221)8 06 - 13 71 e-mail: cert-validity@de.tuv.com				 Albin Yang	
Fax: (+49/221)8 06 - 39 35 http://www.tuv.com/safety					
					



DYNATRON CORPORATION

TOP MOTOR TECHNOLOGY (HUIZHOU) CO, LTD

6.4. UL Certificate

2016/8/25

GPWV2.E157868 - Fans, Electric - Component

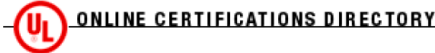

GPWV2.E157868 Fans, Electric - Component

[Page Bottom](#)

Fans, Electric - Component

[See General Information for Fans, Electric - Component](#)

DYNAEON INDUSTRIAL CO LTD
8TH FL 35 LANE 221 GANGCIAN RD
NEIHU DIST
TAIPEI, 114 TAIWAN

E157868

DC fans, Models D(F)1206(Z)(Y1)(X1), D(F)1207(Z)(Y1)(X1), where (F) may be F or C, (Z) may be SH, BH, BA, SM, BM, BB, SL, BL, BC, SD, BE, BF, SG, BI, BJ, SK, BN, BO, SP, BQ, BR, SS, BT, BU, SV, BW, BX, SY, BY or BZ, (Y1) may be "-" through 9 or A through Z, (X1) may be 0 through 9 or A through Z.

Models DF248015(S)(X)(Y)(Z)(W), DF488015(S)(X)(Y)(Z)(W), where (S) may be S, B or P, (X) may be U, H, M or L, (Y) and (Z) may be any alphanumeric character, blank, "-" or any symbol, (W) may be seven any alphanumeric character, blank, "-" or any symbol.

Models DF121225(A)(B)(C), DF121225(A)E(C), DF241225(A)(B)(C), DF128015(A)U(C), DF128015(A)(B)(C), DF128025(A)U(C), DF128025(A)(B)(C), DF128025(A)E(C), DF248025(A)U(C), DF248025(A)(B)(C), DF129225(A)(B)(C), DF129225(A)E(C), DF249225(A)U(C), DF249225(A)(B)(C), DF126010(A)(B)(C), DF246025(A)U(C), DF246025(A)(B)(C), DF126025(A)U(C), DF126025(A)(B)(C), DF126025(A)E(C), DB126015BU(C), DB126015B(B)(C), DF123010(A)(B)(C), DF053010(A)(B)(C), DF127015(A)U(C), DF127015(A)(B)(C), DF245010(A)(B)(C), where (A) may be S, B, P or Q, (B) may be H, M or L, (C) may be xxxxxxxx, where x may be A through Z, 0 through 9, "-" or blank.

Models DF122510(X)(Y2)(Z)-(M), DF124020(X)(Y2)(Z)-(M), DF244020(X)(Y1)(Z)-(M), DF126025(X)(Y3)(Z)-(M), DF246025(X)(Y3)(Z)-(M), DF121225(X)(Y1)(Z)-(M), DF124028(X)(Y3)(Z)-(M), where (X) may be S, B, P, Q, (Y1) may be H, M or L, (Y2) may be U, H, M or L, (Y3) may be U, H, M, L or E, (Z) is alphanumeric combination of five digits and/or alphabets, may be A through Z, 0 through 9 or blank, (M) may be A or B.

Models DF054010(X)(Y2)(Z1)(Z2)-A, DF054010(X)L(Z1)(Z2)-B, DF124010(X)(Y2)(Z1)(Z2)-A, DF124010(X)L(Z1)(Z2)-B, DF244010(X)(Y2)(Z1)(Z2)-A, DF125015(X)(Y1)(Z1)(Z2)-A, DF125020(X)(Y3)(Z1)(Z2)-A, DF126015(X)(Y1)(Z1)(Z2)-A, DF246015(X)M(Z1)(Z2)-A, DF246015(X)L(Z1)(Z2)-A, DF128020(X)(Y1)(Z1)(Z2)-A, DF128020(X)L(Z1)(Z2)-B, DB127015(X)(Y2)(Z)-A series, where (X) may be S, B, P, Q, (Y1) may be H, M or L, (Y2) may be U, H, M or L, (Y3) may be H, M, L or E, (Z1) may be blank or 3, (Z2) is alphanumeric combination of four digits and/or alphabets, may be A through Z, 0 through 9 or blank, (Z) is alphanumeric combination of five digits and/or alphabets, may be A through Z, 0 through 9 or blank.

Models DF125010(X)(Y)(Z)-A, DF126020(X)(Y)(Z)-A, DF246020(X)(Y)(Z)-A, DF121525(X)(Y1)(Z)-A, DF121525(X)(Y2)(Z)-B series, Where (X) may be S, B, P or Q, (Y) may be H, M or L, (Y1) may be U, H or M, (Y2) may be L or E, (Z) is alphanumeric combination of five digits and/or alphabets, may be A through Z, 0 through 9 or blank.

Models DF128025(X)(a)(Y)-A, DF121225(X)(b)(Y)-C, DF121225(X)E(Y)-C, DF127720(X)(a)(Y)-A, DF121425(X)(c)(Y)-A, DF126010(X)E(Y)-A series, where (X) may be S, B, P, Q, (a) may be H, M, L or E, (b) may be M or L, (c) may be U, H, M, L or E, (Y) is alphanumeric combination of five digits and/or alphabets, may be A through Z, 0 through 9 or blank.

Models DF054010(X)(Y1)(Z1)(Z2)-C, DF124010(X)(Y2)(Z1)(Z2)-C, DF244010(X)(Y2)(Z1)(Z2)-C, DF124020BU(Z1)(Z2)-C, DF124020(X)(Y1)(Z1)(Z2)-C, DF124028BU(Z1)(Z2)-C, DF124028(X)(Y1)(Z1)(Z2)-C, DF126025BU(Z1)(Z2)-C, DF126025(X)(Y1)(Z1)(Z2)-C, DF127015BU(Z1)(Z2)-A, DF127015(X)(Y1)(Z1)(Z2)-A, DF128025BU(Z1)(Z2)-B, DF128025(X)(Y1)(Z1)(Z2)-B, DF129225BU(Z1)(Z2)-A, DF129225(X)(Y1)(Z1)(Z2)-A, DF121225BU(Z1)(Z2)-D, DF121225(X)(Y1)(Z1)(Z2)-D, DF121425(X)(Y1)(Z1)(Z2)-B, DB127015BU(Z1)(Z2)-B, DB127015(X)(Y1)(Z1)(Z2)-B, DB058015(X)(Y3)(Z1)(Z2)-A, where (X) may be S, B, P or Q, where(Y1) may be H, M, L or E, where (Y2) may be U, H, M, L or E, where (Y3) may be M or L, where (Z1) may be blank or 3, where (Z2) may be is alphanumeric combination of four digits and/or alphabets, may be A through Z, 0 through 9 or blank.

Models DB128015(X)(Y1)-(Z)-A, DF128038(X)(Y1)-(Z)-A, DB121225(X)(Y2)-(Z)-A, DF054010(X)(Y2)-(Z)-D, DF124010(X)(Y3)-(Z)-D, DF244010(X)(Y4)-(Z)-D, DF125010(X)(Y2)-(Z)-B, DF126010(X)(Y5)-(Z)-B series, where (X) may be S, B, P, Q, (Y1) may be U, H, M, L or E, (Y2) may be H, M or L, (Y3) may be U, M, L or E, (Y4) may be U, H, M or L, (Y5) may be H, M, L or E, (Z) is alphanumeric combination of five digits and/or alphabets, may be A through Z, 0 through 9 or blank.

Series 7515: Models DB127515(X)U-ZZZZ(A), DB127515(X)H-ZZZZ(A), DB127515(X)M-ZZZZ(A), DB127515(X)L-

<http://database.ul.com/cgi-bin/XYV/template/LISEXT/1FRAME/showpage.html?name=GPWV2.E157868&ccnshorttitle=Fans,+Electric+-+Component&obji...> 1/2



DYNATRON CORPORATION

TOP MOTOR TECHNOLOGY (HUIZHOU) CO, LTD

2016/8/25

GPWV2.E157868 - Fans, Electric - Component

ZZZZZ-(A).

Series 9225: Models DF129225(X)U-ZZZZZ-(A), DF129225(X)H-ZZZZZ-(A), DF129225(X)M-ZZZZZ-(A), DF129225(X)L-ZZZZZ-(A).

Models DB128015(X)(Y)-(Z)-B and DF126028(X)(W)-(Z)-A series, where (X) may be S, B, P or Q; (Y) may be U, H, M or L; (W) may be U, H, M, L or E; (Z) stands for five variables, each may be A through Z, 0 through 9 or blank.

Model DF124028(X)(Y)-(Z)-D, where (X) may be S, B, P or Q; (Y) may be U, H, M, L, E; (Z) is alphanumeric combination of five digits and/or alphabets, may be A through Z, 0 through 9 or blank.

Electric fans, Models DC0504, -1204, -1205, -1206, DF1204, -1208, -2408, -0504, -0505, -1205, -2406 followed by "S" or "B", followed by two alphanumeric characters.

Low voltage fans, Models DB1206, DF1209, -1212, -2409, DH1204 followed by B or S, followed by two alphanumeric characters.

Models DF124056(X)(Y)-(Z)-(Z1), DF126038(X)(Y)-(Z)-(Z1), DB129015(X)(Y)-(Z)-(Z1) and DB129215(X)(Y)-(Z)-(Z1); where (X) may be S, B, P, Q; (Y) may be U, H, M, L, E; (Z) may be a through Z, 0 through 9 or blank; (Z1) may be A, B, C or D.



Marking: Company name or trademark  and model designation.

Last Updated on 2015-10-06

[Questions?](#)

[Print this page](#)

[Terms of Use](#)

[Page Top](#)

◆ 2016 UL LLC

The appearance of a company's name or product in this database does not in itself assure that products so identified have been manufactured under UL's Follow-Up Service. Only those products bearing the UL Mark should be considered to be Certified and covered under UL's Follow-Up Service. Always look for the Mark on the product.

UL permits the reproduction of the material contained in the Online Certification Directory subject to the following conditions: 1. The Guide Information, Assemblies, Constructions, Designs, Systems, and/or Certifications (files) must be presented in their entirety and in a non-misleading manner, without any manipulation of the data (or drawings). 2. The statement "Reprinted from the Online Certifications Directory with permission from UL" must appear adjacent to the extracted material. In addition, the reprinted material must include a copyright notice in the following format: "© 2016 UL LLC".



DYNATRON CORPORATION

TOP MOTOR TECHNOLOGY (HUIZHOU) CO, LTD

2016/8/25

GPWV8.E157868 - Fans, Electric Certified for Canada - Component



ONLINE CERTIFICATIONS DIRECTORY

GPWV8.E157868 Fans, Electric Certified for Canada - Component

[Page Bottom](#)

Fans, Electric Certified for Canada - Component

[See General Information for Fans, Electric Certified for Canada - Component](#)

DYNAEON INDUSTRIAL CO LTD
8TH FL 35 LANE 221 GANGCIAN RD
NEIHU DIST
TAIPEI, 114 TAIWAN

E157868

DC fans, Models D(F)1206(Z)(Y1)(X1), D(F)1207(Z)(Y1)(X1), where (F) may be F or C, (Z) may be SH, BH, BA, SM, BM, BB, SL, BL, BC, SD, BE, BF, SG, BI, BJ, SK, BN, BO, SP, BQ, BR, SS, BT, BU, SV, BW, BX, SY, BY or BZ, (Y1) may be "-", 0 through 9 or A through Z, (X1) may be 0 through 9 or A through Z.

Models DF248015(S)(X)(Y)(Z)(W), DF488015(S)(X)(Y)(Z)(W), where (S) may be S, B or P, (X) may be U, H, M or L, (Y) and (Z) may be any alphanumeric character, blank, "-" or any symbol, (W) may be seven any alphanumeric character, blank, "-" or any symbol.

Models DF121225(A)(B)(C), DF121225(A)E(C), DF241225(A)(B)(C), DF128015(A)U(C), DF128015(A)(B)(C), DF128025(A)U(C), DF128025(A)(B)(C), DF128025(A)E(C), DF248025(A)U(C), DF248025(A)(B)(C), DF129225(A)(B)(C), DF129225(A)E(C), DF249225(A)U(C), DF249225(A)(B)(C), DF126010(A)(B)(C), DF246025(A)U(C), DF246025(A)(B)(C), DF126025(A)U(C), DF126025(A)(B)(C), DF126025(A)E(C), DB126015BU(C), DB126015B(B)(C), DF123010(A)(B)(C), DF053010(A)(B)(C), DF127015(A)U(C), DF127015(A)(B)(C), DF245010(A)(B)(C), where (A) may be S, B, P or Q, (B) may be H, M or L, (C) may be xxxxxxxx, where x may be A through Z, 0 through 9, "-" or blank.

Models DF122510(X)(Y2)(Z)-(M), DF124020(X)(Y2)(Z)-(M), DF244020(X)(Y1)(Z)-(M), DF126025(X)(Y3)(Z)-(M), DF246025(X)(Y3)(Z)-(M), DF121225(X)(Y1)(Z)-(M), DF124028(X)(Y3)(Z)-(M), where (X) may be S, B, P, Q, (Y1) may be H, M or L, (Y2) may be U, H, M or L, (Y3) may be U, H, M, L or E, (Z) is alphanumeric combination of five digits and/or alphabets, may be A through Z, 0 through 9 or blank, (M) may be A or B.

Models DF054010(X)(Y2)(Z1)(Z2)-A, DF054010(X)L(Z1)(Z2)-B, DF124010(X)(Y2)(Z1)(Z2)-A, DF124010(X)L(Z1)(Z2)-B, DF244010(X)(Y2)(Z1)(Z2)-A, DF125015(X)(Y1)(Z1)(Z2)-A, DF125020(X)(Y3)(Z1)(Z2)-A, DF126015(X)(Y1)(Z1)(Z2)-A, DF246015(X)M(Z1)(Z2)-A, DF246015(X)L(Z1)(Z2)-A, DF128020(X)(Y1)(Z1)(Z2)-A, DF128020(X)L(Z1)(Z2)-B, DB127015(X)(Y2)(Z)-A series, where (X) may be S, B, P, Q, (Y1) may be H, M or L, (Y2) may be U, H, M or L, (Y3) may be H, M, L or E, (Z1) may be blank or 3, (Z2) is alphanumeric combination of four digits and/or alphabets, may be A through Z, 0 through 9 or blank, (Z) is alphanumeric combination of five digits and/or alphabets, may be A through Z, 0 through 9 or blank.

Models DF125010(X)(Y)(Z)-A, DF126020(X)(Y)(Z)-A, DF246020(X)(Y)(Z)-A, DF121525(X)(Y1)(Z)-A, DF121525(X)(Y2)(Z)-B series, Where (X) may be S, B, P or Q, (Y) may be H, M or L, (Y1) may be U, H or M, (Y2) may be L or E, (Z) is alphanumeric combination of five digits and/or alphabets, may be A through Z, 0 through 9 or blank.

Models DF128025(X)(a)(Y)-A, DF121225(X)(b)(Y)-C, DF121225(X)E(Y)-C, DF127720(X)(a)(Y)-A, DF121425(X)(c)(Y)-A, DF126010(X)E(Y)-A series, where (X) may be S, B, P, Q, (a) may be H, M, L or E, (b) may be M or L, (c) may be U, H, M, L or E, (Y) is alphanumeric combination of five digits and/or alphabets, may be A through Z, 0 through 9 or blank.

Models DF054010(X)(Y1)(Z1)(Z2)-C, DF124010(X)(Y2)(Z1)(Z2)-C, DF244010(X)(Y2)(Z1)(Z2)-C, DF124020BU(Z1)(Z2)-C, DF124020(X)(Y1)(Z1)(Z2)-C, DF124028BU(Z1)(Z2)-C, DF124028(X)(Y1)(Z1)(Z2)-C, DF126025BU(Z1)(Z2)-C, DF126025(X)(Y1)(Z1)(Z2)-C, DF127015BU(Z1)(Z2)-A, DF127015(X)(Y1)(Z1)(Z2)-A, DF128025BU(Z1)(Z2)-B, DF128025(X)(Y1)(Z1)(Z2)-B, DF129225BU(Z1)(Z2)-A, DF129225(X)(Y1)(Z1)(Z2)-A, DF121225BU(Z1)(Z2)-D, DF121225(X)(Y1)(Z1)(Z2)-D, DF121425(X)(Y1)(Z1)(Z2)-B, DB127015BU(Z1)(Z2)-B, DB127015(X)(Y1)(Z1)(Z2)-B, DB058015(X)(Y3)(Z1)(Z2)-A, where (X) may be S, B, P or Q, where (Y1) may be H, M, L or E, where (Y2) may be U, H, M, L or E, where (Y3) may be M or L, where (Z1) may be blank or 3, where (Z2) may be alphanumeric combination of four digits and/or alphabets, may be A through Z, 0 through 9 or blank.

Models DB128015(X)(Y1)-(Z)-A, DF128038(X)(Y1)-(Z)-A, DB121225(X)(Y2)-(Z)-A, DF054010(X)(Y2)-(Z)-D, DF124010(X)(Y3)-(Z)-D, DF244010(X)(Y4)-(Z)-D, DF125010(X)(Y2)-(Z)-B, DF126010(X)(Y5)-(Z)-B series, where (X) may be S, B, P, Q, (Y1) may be U, H, M, L or E, (Y2) may be H, M or L, (Y3) may be U, M, L or E, (Y4) may be U, H, M or L, (Y5) may be H, M, L or E, (Z) is alphanumeric combination of five digits and/or alphabets, may be A through Z, 0 through 9 or blank.

Series 7515: Models DB127515(X)U-ZZZZ-(A), DB127515(X)H-ZZZZ-(A), DB127515(X)M-ZZZZ-(A), DB127515(X)L-

<http://database.ul.com/cgi-bin/XYV/template/LISEXT/1FRAME/showpage.html?name=GPWV8.E157868&ccnshorttitle=Fans,+Electric+Certified+for+Can...> 1/2



DYNATRON CORPORATION

TOP MOTOR TECHNOLOGY (HUIZHOU) CO, LTD

2016/8/25

GPWV8.E157868 - Fans, Electric Certified for Canada - Component

ZZZZZ-(A).

Series 9225: Models DF129225(X)U-ZZZZZ-(A), DF129225(X)H-ZZZZZ-(A), DF129225(X)M-ZZZZZ-(A), DF129225(X)L-ZZZZZ-(A).

Models DB128015(X)(Y)-(Z)-B and DF126028(X)(W)-(Z)-A series, where (X) may be S, B, P or Q; (Y) may be U, H, M or L; (W) may be U, H, M, L or E; (Z) stands for five variables, each may be A through Z, 0 through 9 or blank.

Model DF124028(X)(Y)-(Z)-D, where (X) may be S, B, P or Q; (Y) may be U, H, M, L, E; (Z) is alphanumeric combination of five digits and/or alphabets, may be A through Z, 0 through 9 or blank.

Electric fans, Models DC0504, -1204, -1205, -1206, DF0504, -0505, -1204, -1205, -1208, -2406, -2408 followed by "S" or "B", followed by two alphanumeric characters.

Low voltage fans, Models DB1206, DF1209, -1212, -2409, DH1204 followed by B or S, followed by two alphanumeric characters.

Models DF124056(X)(Y)-(Z)-(Z1), DF126038(X)(Y)-(Z)-(Z1), DB129015(X)(Y)-(Z)-(Z1) and DB129215(X)(Y)-(Z)-(Z1); where (X) may be S, B, P, Q; (Y) may be U, H, M, L, E; (Z) may be a through Z, 0 through 9 or blank; (Z1) may be A, B, C or D.



Marking: Company name or trademark , model designation and Recognized Component Mark for Canada,



Last Updated on 2015-10-06

[Questions?](#)

[Print this page](#)

[Terms of Use](#)

[Page Top](#)

◆ 2016 UL LLC

The appearance of a company's name or product in this database does not in itself assure that products so identified have been manufactured under UL's Follow-Up Service. Only those products bearing the UL Mark should be considered to be Certified and covered under UL's Follow-Up Service. Always look for the Mark on the product.

UL permits the reproduction of the material contained in the Online Certification Directory subject to the following conditions: 1. The Guide Information, Assemblies, Constructions, Designs, Systems, and/or Certifications (files) must be presented in their entirety and in a non-misleading manner, without any manipulation of the data (or drawings). 2. The statement "Reprinted from the Online Certifications Directory with permission from UL" must appear adjacent to the extracted material. In addition, the reprinted material must include a copyright notice in the following format: "© 2016 UL LLC".



DYNATRON CORPORATION

TOP MOTOR TECHNOLOGY (HUIZHOU) CO, LTD

6.5. Electrical Specifications for pwm production

USA Dynatron Corp.

Electrical Specifications for PWM production

Voltage

Fan operating voltage shall be within the range 12V \pm 1.2V.

Current

Peak fan current draw during start-up operation(with 13.2V applied,with fan operating in the free stream condition)shall not exceed 2.0 A.

Fan current spike during start-up operation(with 13.2V applied with fan operating in the free stream condition)shall be allowed to exceed 1.0 A for a duration of no greater than 1.0 sec.

Tachometer Output Signal

Fan shall provide tachometer output signal with the following characteristics:

- * Two pulses per revolution
- * Open-collector or open-drain type output
- * Motherboard will have a pull up to 12V, maximum 13.2V

PWM Control Input Signal

The following requirements are measured at the PWM(control) pin of the fan cable

connector:PWM Frequency:Target frequency 25kHz,

acceptable operational range 21 kHz to 28 KHz

Maximum voltage for logic low:VIL=0.8V

Absolute maximum current sourced:Imax=5mA(short circuit current)

Absolute maximum voltage level:Vmax=5.25V(open circuit voltage)

Fan Speed Control

1.1Maximum Fan Speed Requirements

The maximum fan speed shall be specified for the fan model by the vendor and correspond to 100% duty cycle PWM signal input.

1.2 Minimum Fan Speed Requirements

The vendor shall specify the minimum RPM and the corresponding PWM duty cycle. This specified minimum RPM shall be 30% of maximum RPM or less.The fan shall be able to start and run at this RPM. To allow a lower specified minimum RPM,it is acceptable to provide a higher PWM duty cycle to the fan motor for a short period of time for startup conditions.This pulse should not exceed 30% maximum RPM and should last no longer than 2 seconds.



DYNATRON CORPORATION

TOP MOTOR TECHNOLOGY (HUIZHOU) CO, LTD

USA Dynatron Corp.

1.3 Fan Speed Response PWM Control Input Signal

The PWM input shall be delivered to the fan through the control signal on Pin4. Fan speed response to this signal shall be a continuous and monotonic of the duty cycle of the signal, from 100% to the minimum specified RPM. The fan RPM (as a percentage of maximum RPM) should match the PWM duty cycle within $\pm 10\%$. If no control signal is present the fan shall operate at maximum RPM.

Figure 1 Fan speed Response to PWM Control input Signal

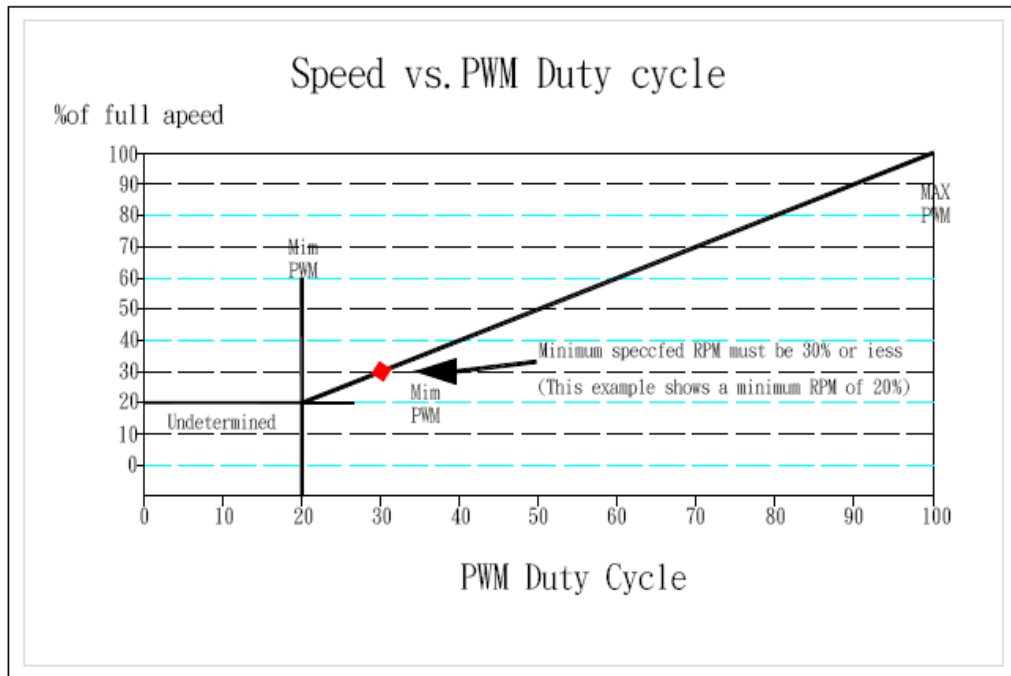

1.4 Operation Below Minimum RPM

For all duty cycles less than the minimum duty cycle, the RPM shall not be greater than the minimum RPM. The following graphs and definitions show three recommended solutions to handle PWM duty cycles that are less than the minimum operational PWM, as a percentage of maximum.

Reference resource by Intel's 4-wire PWM Fan controlled specification.



Certificate of Environment Protection

環保證明書

Document Number: RH-Q8-R0

Customer: 客戶名稱:	Company: Address: _____ Phone Number: _____ - _____ - _____
Issue Date: 發行日期:	03/18/2022
Product Model Number: 產品號碼:	Q8

Dynatron Corporation / Dynaeon Industrial Co., Ltd hereby declares and certifies that all components manufactured are RoHS, ROHS2 & ROHS3 compliant according to the definitions and restrictions given by the European Union's Restriction (Directive 2002/95/EC) (Directive 2011/65/EU) & (Directive (EU) 2015/863) as known as RoHS 3, on the restriction of the use of certain Hazardous Substances in the electrical and electronic equipment.

No exemptions are claimed in order for the part to be compliant with the RoHS directive.

Dynatron Corporation / 政久興業股份有限公司證明所有產品,零件 (包括附屬品,包裝類) 之環境管理物質完全符合 RoHS, WEEE, 及該環保標準之規定, 並承諾遵循以上之證明.

Dynatron Corporation / Dynaeon Industrial Co., Ltd.

Title (職務): _____ ASSISTANT-MANAGER / 副理 _____

Signature (簽字): _____

Date: 03/18/2022