

SI-38N Series

User Manual



2013 Sep. V1

Copyright © 2012 IBASE Technology INC. All Rights Reserved.

No part of this manual, including the products and software described in it, may be reproduced, transmitted, transcribed, stored in a retrieval system, or translated into any language in any form or by any means, except documentation kept by the purchaser for backup purposes, without the express written permission of IBASE Technology INC. ("IBASE").

Products and corporate names mentioned in this manual may or may not be registered trademarks or copyrights of their respective companies, and are used for identification purposes only. All trademarks are the property of their respective owners.

Every effort has been made to ensure that the contents of this manual are correct and up to date. However, the manufacturer makes no guarantee regarding the accuracy of its contents, and reserves the right to make changes without prior notice.

Table of Contents

<i>Safety Information</i>	4
Setting up your system	4
Care during use	4
Acknowledgments	5
<i>Accessories</i>	7
<i>Components</i>	7
I/O View	7
<i>Specification</i>	9
<i>Mounting SI-38N to the Wall</i>	9
Wall mounting requirements	10
Selecting the location	11
<i>Exploded view of the SI-38N assembly</i>	11
Parts description	12
<i>Installation</i>	12
Installing the memory	13
<i>Setting Jumper</i>	13
Jumper Locations on IB939	14
<i>Connectors on IB939</i>	15
<i>Drivers Installation</i>	40
<i>Appendix</i>	46

Safety Information

Your SI-38N is designed and tested to meet the latest standards of safety for information technology equipment. However, to ensure your safety, it is important that you read the following safety instructions.

Setting up your system

- Read and follow all instructions in the documentation before you operate your system.
- Do not use this product near water.
- Set up the system on a stable surface. Do not secure the system on any unstable plane.
- Do not place this product on an unstable cart, stand, or table. The product may fall, causing serious damage to the product.
- Slots and openings on the chassis are for ventilation. Do not block or cover these openings. Make sure you leave plenty of space around the system for ventilation. ***Never insert objects of any kind into the ventilation openings.***
- This system should be operated from the type of power indicated on the marking label. If you are not sure of the type of power available, consult your dealer or local power company.
- Use this product in environments with ambient temperatures between 0°C and 45°C.
- If you use an extension cord, make sure that the total ampere rating of the devices plugged into the extension cord does not exceed its ampere rating.
- DO NOT LEAVE THIS EQUIPMENT IN AN ENVIRONMENT WHERE THE STORAGE TEMPERATURE MAY GO BELOW -20° C (-4° F) OR ABOVE 80° C (176° F). THIS COULD DAMAGE THE EQUIPMENT. THE EQUIPMENT SHOULD BE IN A CONTROLLED ENVIRONMENT.

Care during use

- Do not walk on the power cord or allow anything to rest on it.
- Do not spill water or any other liquids on your system.
- When the system is turned off, a small amount of electrical current still flows. Always unplug all power, and network cables from the power outlets before

cleaning the system.

- If you encounter the following technical problems with the product, unplug the power cord and contact a qualified service technician or your retailer.
 - The power cord or plug is damaged.
 - Liquid has been spilled into the system.
 - The system does not function properly even if you follow the operating instructions.
 - The system was dropped or the cabinet is damaged.

Lithium-Ion Battery Warning

CAUTION: Danger of explosion if battery is incorrectly replaced. Replace only with the same or equivalent type recommended by the manufacturer. Dispose of used batteries according to the manufacturer's instructions.

NO DISASSEMBLY

The warranty does not apply to the products that have been disassembled by users

WARNING



HAZARDOUS MOVING PARTS

KEEP FINGERS AND OTHER BODY PARTS AWAY

Acknowledgments

- AMI is a registered trademark of AMI Software International, Inc.
- AMD and ATI are registered trademarks of AMD Corporation.
- Microsoft Windows is a registered trademark of Microsoft Corporation.
- FINTEK is a registered trademark of FINTEK Electronics Corporation.
- REALTEK is a registered trademark of REALTEK Electronics Corporation.
- All other product names or trademarks are properties of their respective owners.

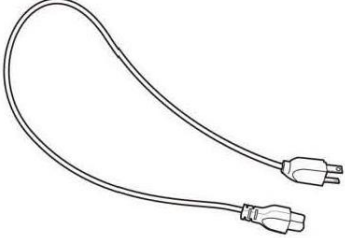
Accessories

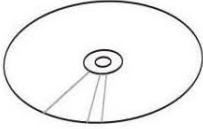
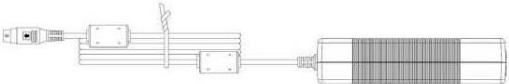
	
a. Power Cord x 1	b. System Manual x 1
	
c. Driver CD x 1	d. Power Brick x 1

Components

I/O View

Refer to the diagram below to identify the components on this side of the system.



Power Bottom

The power switch allows powering ON and OFF the system.

HDD

The hard disk LED blinks when data is being written into or read from the hard disk

Power

The power LED illuminated when system been power on.

Dual Link DVI-I

The Dual Link DVI-I interface to transmitting uncompressed digital data come from A70 (Accelerated Processing Unit). Max resolution can support 2560 X 1600.

Hybrid DVI-I

The Hybrid DVI-I interface can support VGA, DVI-D and HDMI (with audio) to transmitting uncompressed digital data come from A70 (Accelerated Processing Unit).

LAN 1

The eight-pin RJ-45 LAN port supports a standard Ethernet cable for connection to a local network.

COM 1

Communication or serial port is compatible with RJ 45 interface without RI (ring indicator) signal.

USB1/2

The USB (Universal Serial Bus) port is compatible with USB devices such as keyboards, mouse devices, cameras, and hard disk drives. USB allows many devices to run simultaneously on a single computer, with some peripheral acting as additional plug-in sites or hubs.

AUDIO

The stereo audio jack (3.5mm) is used to connect the system's audio out signal to amplified speakers or headphones.

DC-IN 12 V

The supplied power adapter converts AC power to DC power for use with this

jack. Power supplied through this jack supplies power to the system. To prevent damage to the system, always use the supplied power adapter.

Specification

System Mainboard	IB939
Chassis Color	Black / White
Storage	2.5" 320GB SATA HDD x 1
Mounting	Wall mount
Power Supply	84W DC adapter
Operating Temperature	0°C ~ 45°C (32°F ~ 113°F)
Storage Temperature	-20°C ~ 80°C
Relative Humidity	5~90% @45°C (non-condensing)
Vibration	SSD: 5 grms / 5~500Hz / random operation HDD: 0.25 grms / 5~500Hz / random operation
RoHS	Available

·This specification is subject to change without prior notice.

Mounting SI-38N to the Wall

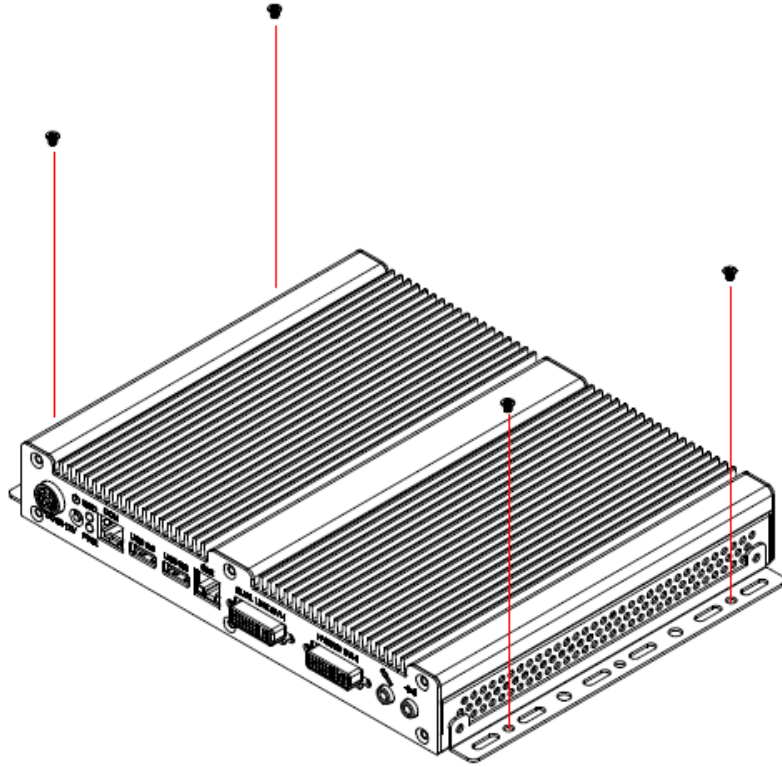

You can install SI-38N on plastic (LCD monitor), wood, drywall surface over studs, or a solid concrete or metal plane directly. Ensure the installer uses at least four M3 length 6mm screws to secure the system on wall. ***Four M3 length 6mm screws are recommended to secure the system on wall.***

Fasteners are not included with the unit, and must be supplied by the installer. The types of fasteners required are dependent on the type of wall construction. Choose fasteners that are rated either "Medium Duty" or "Heavy Duty." To assure proper fastener selection and installation, follow the fastener manufacturer's recommendations.

Wall mounting requirements

Note: Before mounting the system on wall, ensure that you are following all applicable building and electric codes.

When mounting, ensure that you have enough room for power and signal cable routing. And have good ventilation for power adapter. The method of mounting must be able to support weight of the SI-38N plus the suspend weight of all the cables to be attached to the system. Use the following methods for mounting your system:

Mounting to hollow walls

- **Method 1: Wood surface** – A minimum wood thickness – 38mm (1.5in.) by 25.4 cm (10in.) – of high, construction – grade wood is recommended.
Note: This method provides the most reliable attachment of the unit with little risk that the unit will come loose or require ongoing maintenance.
- **Method 2: Drywall walls** - Drywall over wood studs is acceptable.

Mounting to a solid concrete or brick wall - Mounts on a flat smooth surface.

Selecting the location

Plan the mounting location thoroughly. Locations such as walkway areas, hallways, and crowded areas are not recommended. Mount the unit to a flat, sturdy, structurally sound column or wall surface.

The best mounting surface is a standard countertop, cabinet, table, or other structure that is minimally the width and length of the unit. This recommendation reduces the risk that someone may accidentally walk into and damage the device. Local laws governing the safety of individuals might require this type of consideration.

Exploded view of the SI-38N assembly

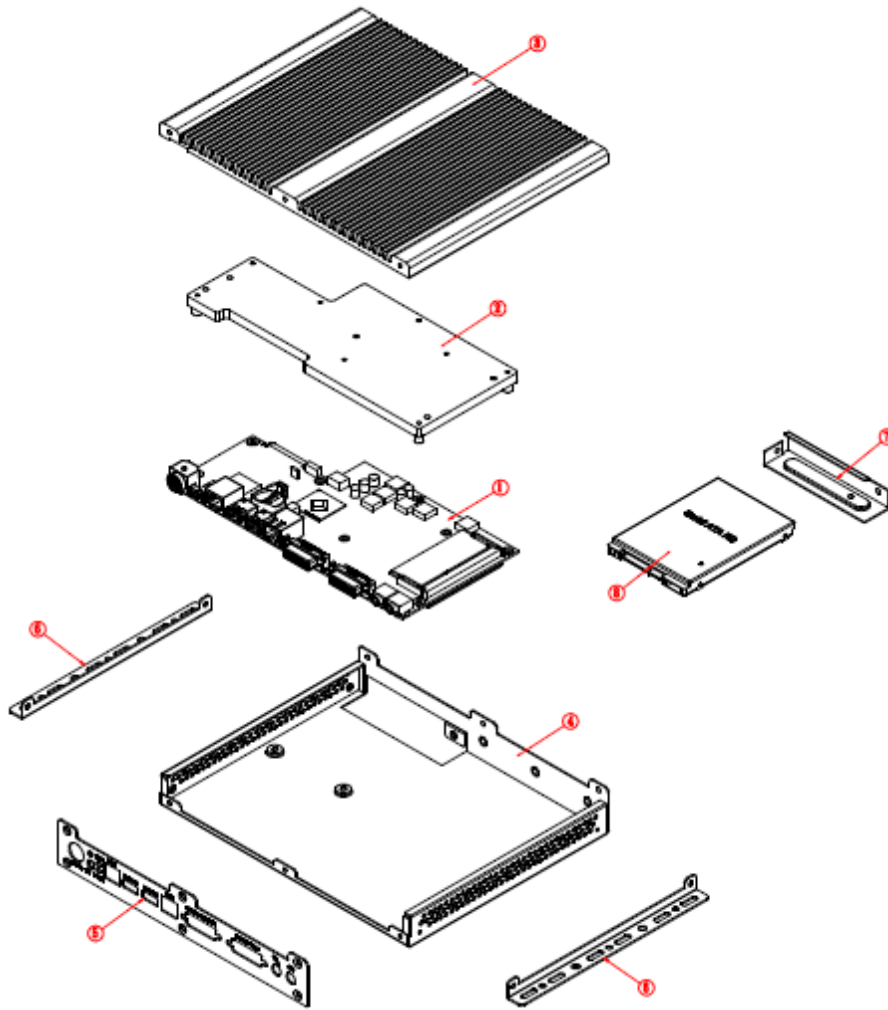

Parts description

Part NO.	Description	Part NO.	Description
1	IB939 MB	2	Base
3	Heat sink	4	Main chassis
5	I/O bracket	6	Wall mount kit
7	HDD bracket	8	2.5" HDD

Installation

Installing the memory

The IB939 board supports two DDR3 memory socket for a maximum total memory of 8GB in DDR3 SO-DIMM memory type.

Installing and Removing Memory Modules

To install the DDR3 modules, locate the memory slot on the board and perform the following steps:

1. Hold the DDR3 module so that the key of the DDR3 module aligns with that on the memory slot. Insert the module into the socket at a slight angle (approximately 30 degrees). Note that the socket and module are both keyed, which means that the module can be installed only in one direction.
2. To seat the memory module into the socket, apply firm and even pressure to each end of the module until you feel it slip down into the socket.
3. With the module properly seated in the socket, rotate the module downward. Continue pressing downward until the clips at each end lock into position.
4. To remove the DDR3 module, press the clips with both hands.

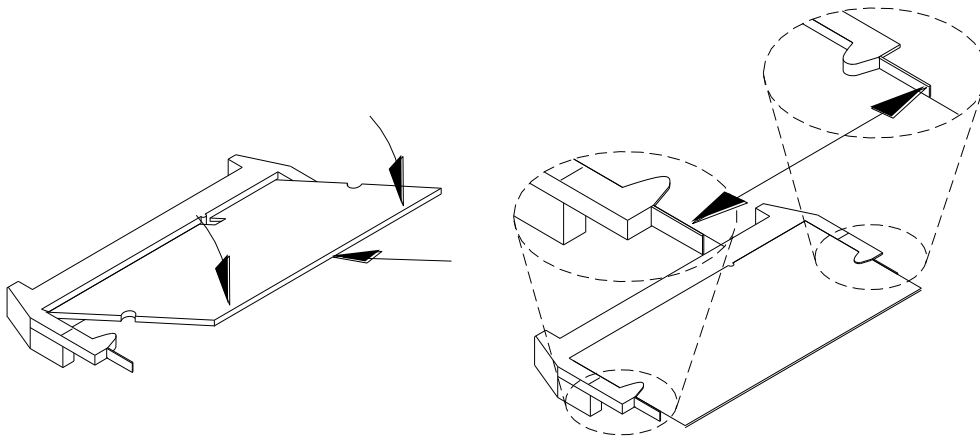

Setting Jumper

Jumpers are used on SI-38N to select various settings and features according to your needs and applications. Contact your supplier if you have doubts about the best configuration for your needs. The following lists the connectors on SI-38N and their respective functions.

Jumper Locations on IB939

Page 13

JP4, JP5: COM4 RS232 RI/+5V/+12V Power Setting

Page 13

Jumper Locations on IB939

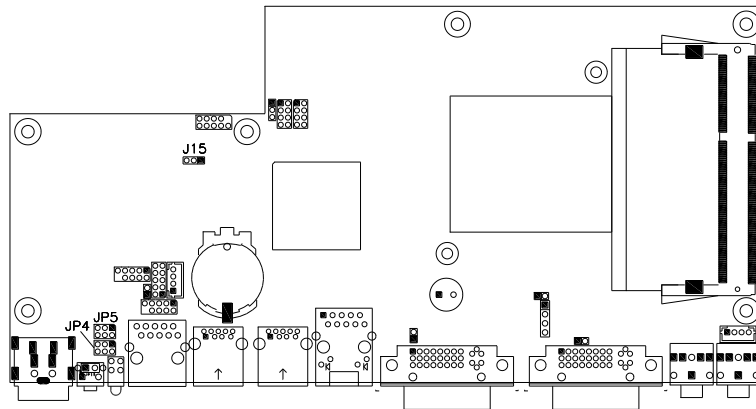



JP4, JP5: COM4 RS232 RI/+5V/+12V Power Setting

JP4/JP5	Setting	Function
	Pin 1-2 Short/Closed	+12V
	Pin 3-4 Short/Closed	RI
	Pin 5-6 Short/Closed	+5V

J15: Clear CMOS Setting

JP15	Function

 1 2 3	Normal
 1 2 3	Clear CMOS

Connectors on IB939

Connector Locations on IB939

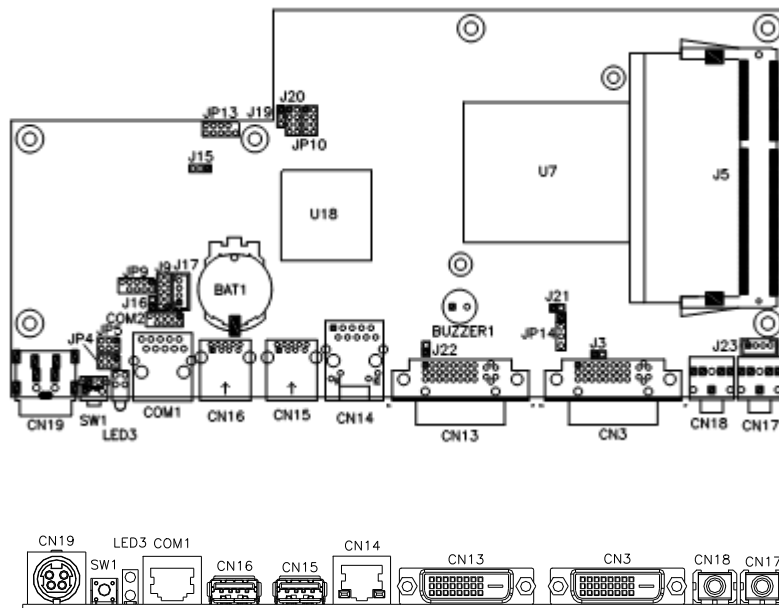

CN19: DC_IN Connector (+12V Adaptor 4 Pin)

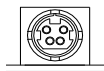

Pin #	Signal Name
1	+12V
2	+12V
3	GND
4	GND
5	GND

SW1: Power Button

LED3: Power LED (Green), HDD LED (RED)

The green LED at the bottom is power LED. The red LED on top is the HDD LED.

COM1: COM1 Connector

COM1	Pin #	Signal Name
	1	DSR, Data set ready
	2	GND, ground
	3	GND, ground
	4	TXD, Transmit data
	5	RXD, Receive data
	6	DCD, Data carrier detect
	7	DTR, Data terminal ready
	8	CTS, Clear to send
	9	RTS, Request to send
	10	RI, Ring indicator

CN15, CN16: USB3.0 Connector

CN14: RJ45 Gigabit LAN

CN13: Dual Link DVI-I Connector

CN3: DVI-I Connector

CN18: Audio MIC-in

CN17: Audio Line out

JP13: SPI Flash Connector

J8: Half Mini PCIE Slot

JP9: LPC Debug Port Connector

COM2: COM2 Connector

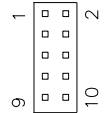

Signal Name	Pin #	Pin #	Signal Name
Data carrier detect	1	2	Data set ready
Receive data	3	4	Request to send
Transmit data	5	6	Clear to send
Data terminal ready	7	8	Ring indicator
Ground	9	10	No connect.

J9: Digital I/O

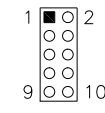

Signal Name	Pin #	Pin #	Signal Name
GND	1	2	VCC
OUT3	3	4	OUT1

OUT2	5	6	OUT0
IN3	7	8	IN1
IN2	9	10	IN0

JP10: US2.0 Connector

	Signal Name	Pin #	Pin #	Signal Name
	Vcc	1	2	Ground
	D-	3	4	D+
	D+	5	6	D-
	Ground	7	8	Vcc

J12: Mini PCIE Slot (Support mSATA)

J17: MCU JTAG (factory use only)

J19: Power LED Connector

J20: System Function Connector

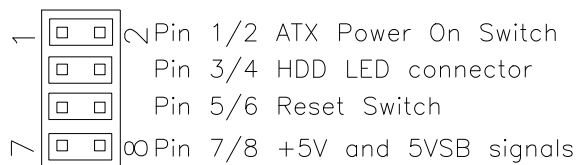

J19: Power LED Connector

	Pin #	Signal Name
	1	+5V

2	NC
3	Ground

J24: CPU_FAN Connector

This is a 3-pin header for the CPU fan. The fan must be a 12V (500mA).



Pin #	Signal Name
1	Ground
2	+12V
3	Rotation detection

J25: SYS_FAN Connector

This is a 3-pin header for system fans. The fan must be a 12V (500mA).



Pin #	Signal Name
1	Ground
2	+12V
3	Rotation detection

J23: Audio Amplifier

BIOS Setup

BIOS Introduction

The BIOS (Basic Input/Output System) installed in your computer system's ROM provides critical low-level support for a standard device such as disk drives, serial ports and parallel ports. It also adds virus and password protection as well as special support for detailed fine-tuning of the chipset controlling the entire system.

BIOS Setup

The BIOS provides a Setup utility program for specifying the system configurations and settings. The BIOS ROM of the system stores the Setup utility. When you turn on the computer, the BIOS is immediately activated. Pressing the key immediately allows you to enter the Setup utility. If you are a little bit late pressing the key, POST (Power On Self Test) will continue with its test routines, thus preventing you from invoking the Setup. If you still wish to enter Setup, restart the system by pressing the "Reset" button or simultaneously pressing the <Ctrl>, <Alt> and <Delete> keys. You can also restart by turning the system Off and back On again. The following message will appear on the screen:

```
Press <DEL> or <ESC> to Enter Setup
```

In general, you press the arrow keys to highlight items, <Enter> to select, the <PgUp> and <PgDn> keys to change entries, <F1> for help and <Esc> to quit.

When you enter the Setup utility, the Main Menu screen will appear on the screen. The Main Menu allows you to select from various setup functions and exit choices.

Main BIOS Setup

This setup allows you to record some basic hardware configurations in your computer system and set the system clock.

Aptio Setup Utility – Copyright © 2010 American Megatrends, Inc.

Main	Advanced	Chipset	Boot	Security	Save & Exit
BIOS Information					Choose the system default language
Memory Information					→ ← Select Screen
Total memory			8176 MB (DDR3)		↑ ↓ Select Item
System Date			[Tue 01/20/2009]		Enter: Select
System Time			[15:27:20]		+ - Change Field
Access Level			Administrator		F1: General Help
					F2: Previous Values
					F3: Optimized Default
					F4: Save
					ESC: Exit

Note: *If the system cannot boot after making and saving system changes with Setup, the AMI BIOS supports an override to the CMOS settings that resets your system to its default.*

Warning: *It is strongly recommended that you avoid making any changes to the chipset defaults. These defaults have been carefully chosen by both AMI and your system manufacturer to provide the absolute maximum performance and reliability. Changing the defaults could cause the system to become unstable and crash in some cases.*

System Language

Choose the system default language.

System Date

Set the Date. Use Tab to switch between Data elements.

System Time

Set the Time. Use Tab to switch between Data elements.

Advanced Settings

This section allows you to configure and improve your system and allows you to set up some system features according to your preference.

Aptio Setup Utility

Main	Advanced	Chipset	Boot	Security	Save & Exit
Legacy OpROM Support					
Launch PXE OpROM [Disabled]					
Launch Storage OpROM [Enabled]					
▶ PCI Subsystem Settings					
▶ ACPI Settings					
▶ Wake up event setting					
▶ CPU Configuration					
▶ Shutdown Temperature Configuration					
▶ Auto Power On Schedule					
▶ SATA Configuration					
▶ PCH-FW Configuration					
▶ AMT Configuration					
▶ USB Configuration					
▶ Super IO Configuration					
▶ H/W Monitor					
▶ Serial Port Console Redirection					
▶ Sandybridge PPM Configuration					
					→ ← Select Screen
					↑ ↓ Select Item
					Enter: Select
					+ - Change Field
					F1: General Help
					F2: Previous Values
					F3: Optimized Default
					F4: Save & EXIT
					ESC: Exit

PCI Latency Timer

Value to be programmed into PCI Latency Timer Register.

VGA Palette Snoop

Enables or disables VGA Palette Registers Snooping.

PERR# Generation

Enables or disables PCI device to generate PERR#.

SERR# Generation

Enables or disables PCI device to generate SERR#.

ACPI Settings

System ACPI Parameters.

Aptio Setup Utility

Main	Advanced	Chipset	Boot	Security	Save & Exit
Enable ACPI Auto Configuration			Disabled		→ ← Select Screen
Enable Hibernation			Enabled		↑ ↓ Select Item
ACPI Sleep State			S3 (Suspend to R...)		Enter: Select
Lock Legacy Resources			Disabled		+ - Change Field
					F1: General Help
					F2: Previous Values
					F3: Optimized Default
					F4: Save & Exit
					ESC: Exit

Enable Hibernation

Enables or Disables System ability to Hibernate (OS/S4 Sleep State). This option may be not effective with some OS.

ACPI Sleep State

Select the highest ACPI sleep state the system will enter, when the SUSPEND button is pressed.

Lock Legacy Resources

Enables or Disables System Lock of Legacy Resources.

CPU Configuration

This section shows the CPU configuration parameters.

Aptio Setup Utility

Main	Advanced	Chipset	Boot	Security	Save & Exit
CPU Configuration					
Module Version: 4.6.5.1 TrinityPI 012					
AGESA Version: 1.0.0.3					
PSS Support				Enable	→ ← Select Screen
PSTATE Adjustment				Pstate 0	↑ ↓ Select Item
NX Mode				Enable	Enter: Select
SVM Mode				Enable	+ - Change Field
CPB Mode				Auto	F1: General Help
C6 Mode				Enable	F2: Previous Values
▶ Node 0 Information					F3: Optimized Default
					F4: Save
					ESC: Exit

PSS Support

Enable/disable the generation of ACPI _PPC, _PPC, _PSS, and _PCT objects.

PSTATE Adjustment

Provide to adjust startup P-state level.

PPC Adjustment

Provide to adjust _PPC object.

NX Mode

Enable/disable No-execute page protection function.

SVM Mode

Enable/disable CPU Virtualization.

CPB Mode

Enable/disable CPB.

C6 Mode

Auto/disable CPB.

Node 0 Information

View memory information related to Node 0.

EuP/ErP Power Saving Controller

Aptio Setup Utility

Main	Advanced	Chipset	Boot	Security	Save & Exit
					EuP/ErP control on S5
					[Keep standby power] Enable
					All of the standby power and ignore EuP/ErP specification.
					[Ethernet Only] Only provide the standby power for Ethernet chip.
					[No standby power] Shutdown all of the standby power.
					→ ← Select Screen
					↑ ↓ Select Item
					Enter: Select
					+ - Change Field
					F1: General Help
					F2: Previous Values
					F3: Optimized Default
					F4: Save
					ESC: Exit

EuP/ErP control on S5 options:

[Keep standby power] Enable All of the standby power and ignore EuP/ErP specification.

[Ethernet Only] Only provide the standby power for Ethernet chip.

[No standby power] Shut down all of the standby power.

IDE Configuration

Aptio Setup Utility

Main	Advanced	Chipset	Boot	Security	Save & Exit
IDE Configuration					
SATA Port0			WDC WD800AAJS-(80.0G	→ ←	Select Screen
SATA Port2			Not Present	↑ ↓	Select Item
					Enter: Select
					+ - Change Field
					F1: General Help
					F2: Previous Values
					F3: Optimized Default
					F4: Save
					ESC: Exit

Shutdown Temperature Configuration

Aptio Setup Utility

Main	Advanced	Chipset	Boot	Security	Save & Exit
APCI Shutdown Temperature					
			Disabled	→ ←	Select Screen
					↑ ↓ Select Item
					Enter: Select
					+ - Change Field
					F1: General Help
					F2: Previous Values
					F3: Optimized Default
					F4: Save
					ESC: Exit

ACPI Shutdown Temperature

The default setting is Disabled.

Auto Power On Schedule

Aptio Setup Utility

Main	Advanced	Chipset	Boot	Security	Save & Exit
Auto Power On Schedule					→ ← Select Screen ↑ ↓ Select Item Enter: Select +- Change Field F1: General Help F2: Previous Values F3: Optimized Default F4: Save ESC: Exit
Power-On after Power failure			Disable		
Schedule Slot 1			None		
Schedule Slot 2			None		

Power-On after Power failure

Enable or Disable.

Schedule Slot 1 / 2

Setup the hour/minute for system power on.

USB Configuration

Aptio Setup Utility

Main	Advanced	Chipset	Boot	Security	Save & Exit
USB Configuration					→ ← Select Screen ↑ ↓ Select Item Enter: Select
USB Devices: 1 Keyboard, 1 Mouse					
Legacy USB Support			Enabled		
USB3.0 Support			Enabled		
XHCI Hand-off			Enabled		

EHCI Hand-off	Enabled	+ - Change Field F1: General Help F2: Previous Values F3: Optimized Default F4: Save ESC: Exit
USB hardware delays and time-outs:		
USB Transfer time-out	20 sec	
Device reset time-out	20 sec	
Device power-up delay	Auto	

Legacy USB Support

Enables Legacy USB support.

AUTO option disables legacy support if no USB devices are connected.

DISABLE option keeps USB devices available only for EFI applications.

USB3.0 Support

Enable/Disable USB3.0 (XHCI) Controller support.

XHCI Hand-off

This is a workaround for Oses without XHCI hand-off support. The XHCI ownership change should be claimed by XHCI driver.

EHCI Hand-off

Enabled/Disabled. This is a workaround for Oses without EHCI hand-off support. The EHCI ownership change should be claimed by EHCI driver.

USB Transfer time-out

The time-out value for Control, Bulk, and Interrupt transfers.

Device reset time-out

USB mass Storage device start Unit command time-out.

Device power-up delay

Maximum time the device will take before it properly reports itself to the Host Controller. 'Auto' uses default value: for a Root port it is 100ms, for a Hub port the delay is taken from Hub descriptor.

NCT6106D Super IO Configuration

Aptio Setup Utility

Main	Advanced	Chipset	Boot	Security	Save & Exit
NCT6106D Super IO Configuration					→ ← Select Screen
NCT6106D Super IO Chip		F81866			↑ ↓ Select Item
▶ Serial Port 0 Configuration					Enter: Select
▶ Serial Port 1 Configuration					+ - Change Field
					F1: General Help
					F2: Previous Values
					F3: Optimized Default
					F4: Save
					ESC: Exit

Serial Port Configuration

Set Parameters of Serial Ports. User can Enable/Disable the serial port and Select an optimal settings for the Super IO Device.

NCT6106D H/W Monitor

Aptio Setup Utility

Main	Advanced	Chipset	Boot	Security	Save & Exit
PC Health Status					
System Smart Fan Function		Disabled			
CPU Smart Fan Function		Disabled			
SYS_Fan2 smart fan control		Disabled			→ ← Select Screen
SYS Temp		+35 C			↑ ↓ Select Item
CPU Temp		+52 C			Enter: Select
Vcore		+1.000 V			+ - Change Field
+5V		+4.413 V			F1: General Help
+12V		+11.408 V			F2: Previous Values
1.5V		+1.544 V			F3: Optimized Default
					F4: Save



Temperatures/Voltages

These fields are the parameters of the hardware monitoring function feature of the motherboard. The values are read-only values as monitored by the system and show the PC health status.

Smart Fan Function

This field enables or disables the smart fan feature. At a certain temperature, the fan starts turning. Once the temperature drops to a certain level, it stops turning again.

Chipset Settings

This section allows you to configure and improve your system and allows you to set up some system features according to your preference.

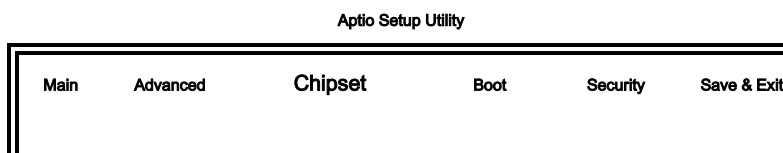
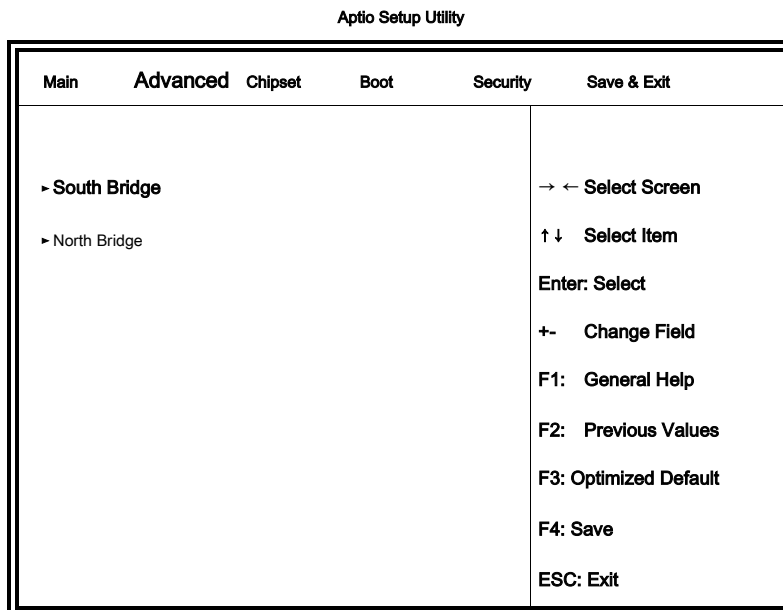

AMD Reference code Version: 1.0.0.3	Trinity P	Options for SATA Configuration
<p>> SB SATA Configuration</p> <p> > SB USB Configuration</p>		<p>→ ←</p> <p>Select Screen</p> <p>↑ ↓ Select Item</p> <p>Enter: Select</p> <p>+ - Change Field</p> <p>F1: General Help</p> <p>F2: Previous Values</p> <p>F3: Optimized Default</p> <p>F4: Save</p> <p>ESC: Exit</p>

Aptio Setup Utility

Main	Advanced	Chipset	Boot	Security	Save & Exit
		OnChip SATA Channel	Enabled		
		OnChip SATA Type	Native iDE		
		OnChip iDE mode	Legacy mode	→ ←	
		SATA IDE Combined Mode	Enabled		
				→ ←	
				Select Screen	
				↑ ↓ Select Item	
				Enter: Select	
				+ - Change Field	
				F1: General Help	
				F2: Previous Values	
				F3: Optimized Default	
				F4: Save	
				ESC: Exit	

OnChip SATA Channel

Enabled or Disabled.

OnChip SATA Type

Native IDE /n RAID /n AHCI /n AHCI /n Legacy IDE /n IDE->AHCI /n HyperFlash

OnChip IDE mode

Legacy mode or Native mode

SATA IDE Combined Mode

Enabled or Disabled.

SB USB Configuration Options:

Main	Advanced	Chipset	Boot	Security	Save & Exit
				XHCI Controller 0	Enabled
				XHCI Controller 1	Enabled
				DHCI HC(Bus 0 Dev 18 Fn 0)	Enabled
				EHCI HC(Bus 0 Dev 18 Fn 2)	Enabled
				DHCI HC(Bus 0 Dev 19 Fn 0)	Enabled
				EDHCI HC(Bus 0 Dev 19 Fn 0)	Enabled
				DHCI HC(Bus 0 Dev 20 Fn 5)	Enabled
				USB Port 0	Enabled
				USB Port	Enabled
				USB Port	Enabled
				USB Port	Enabled
				USB Port	Enabled
				USB Port	Enabled
				USB Port	Enabled
				USB Port	Enabled
				USB Port	Enabled
				USB Port	Enabled
				USB Port	Enabled
				USB Port	Enabled
				USB Port	Enabled
				USB Port	Enabled
				USB Port	Enabled

→ ←

Select Screen

↑ ↓ **Select Item**

Enter: Select

+ - **Change Field**

F1: General Help

F2: Previous Values

F3: Optimized Default

XHCI0 Port 0	Enabled	F4: Save ESC: Exit
XHCI0 Port 1	Enabled	
XHCI1 Port 0	Enabled	
XHCI1 Port 1	Enabled	

Aptio Setup Utility

Main	Advanced	Chipset	Boot	Security	Save & Exit
North Bridge Configuration ▶ GFX Configuration Memory Information Total memory: 8176 MB (DDR3) ▶ Socket 0 Information			→ ← Select Screen ↑ ↓ Select Item Enter: Select +- Change Field F1: General Help F2: Previous Values F3: Optimized Default F4: Save ESC: Exit		

Aptio Setup Utility

Main	Advanced	Chipset	Boot	Security	Save & Exit
GFX Configuration Integrated Graphics Auto			Enable Integrated Graphics Controller → ← Select Screen ↑ ↓ Select Item		

<p>Enter: Select</p> <p>+ - Change Field</p> <p>F1: General Help</p> <p>F2: Previous Values</p> <p>F3: Optimized Default</p> <p>F4: Save</p> <p>ESC: Exit</p>

Integrated Graphics

Options are Auto Disabled and Force

Aptio Setup Utility					
Main	Advanced	Chipset	Boot	Security	Save & Exit
Socket 0 Information			<p>→ ←</p> <p>Select Screen</p> <p>↑ ↓ Select Item</p> <p>Enter: Select</p> <p>+ - Change Field</p> <p>F1: General Help</p> <p>F2: Previous Values</p> <p>F3: Optimized Default</p> <p>F4: Save</p> <p>ESC: Exit</p>		
<p>Starting Address: 0KB</p> <p>Ending Address: 8388607 KB</p> <p>Dimm0: Not Present</p> <p>Dimm1: size=8192 MB, speed=667 MHz</p>					

Boot Settings

This section allows you to configure the boot settings.

Aptio Setup Utility					
Main	Advanced	Chipset	Boot	Security	Save & Exit
Boot Configuration					

Setup Prompt Timeout	1	
Bootup NumLock State	On	
Quiet Boot	Disabled	
Fast Boot	Disabled	
CSM16 Module Version	07.69	→ ← Select Screen
GateA20 Active	Upon Request	↑ ↓ Select Item
Option ROM Messages	Force BIOS	Enter: Select
INT19 Trap Response	Immediate	+ - Change Field
CSM Support	Enabled	F1: General Help
Boot Option Priorities		F2: Previous Values
Boot Option #1	SATA PM: WDC WD80...	F3: Optimized Default
▶ CSM parameters		F4: Save
		ESC: Exit

Setup Prompt Timeout

Number of seconds to wait for setup activation key.

65535(0xFFFF) means indefinite waiting.

Bootup NumLock State

Select the keyboard NumLock state.

Quiet Boot

Enables/Disables Quiet Boot option.

Fast Boot

Enables/Disables boot with initialization of a minimal set of devices required to launch active boot option. Has no effect for BBS boot options.

GateA20 Active

UPON REQUEST – GA20 can be disabled using BIOS services.

ALWAYS – do not allow disabling GA20; this option is useful when any RT code is executed above 1MB.

Option ROM Messages

Set display mode for Option ROM. Options are Force BIOS and Keep Current.

INT19 Trap Response

Enable: Allows Option ROMs to trap Int 19.

Boot Option Priorities

Sets the system boot order.

CSM parameters

OpROM execution, boot options, filter, etc.

Aptio Setup Utility

Main	Advanced	Chipset	Boot	Security	Save & Exit
Launch CSM			Always		
Boot option filter			UEFI and Legacy		
Launch PXE OpROM policy			Do not launch		→ ← Select Screen
Launch Storage OpROM policy			Legacy only		↑ ↓ Select Item
Launch Video OpROM policy			Legacy only		Enter: Select
					+ - Change Field
Other PCI device ROM priority			Legacy OpROM		F1: General Help
					F2: Previous Values
					F3: Optimized Default
					F4: Save
					ESC: Exit

Launch CSM

This option controls if CSM will be launched.

Boot option filter

This option controls what devices system can boot to.

Launch PXE OpROM policy

Controls the execution of UEFI and Legacy PXE OpROM.

Launch Storage OpROM policy

Controls the execution of UEFI and Legacy Storage OpROM.

Launch Video OpROM policy

Controls the execution of UEFI and Legacy Video OpROM.

Other PCI device ROM priority

For PCI devices other than Network, Mass storage or Video defines which OpROM to launch.

Security Settings

This section allows you to configure and improve your system and allows you to set up some system features according to your preference.

Aptio Setup Utility

Main	Advanced	Chipset	Boot	Security	Save & Exit
Password Description					
If ONLY the Administrator's password is set, then this only limit access to Setup and is only asked for when entering Setup.					
If ONLY the User's password is set, then this is a power on password and must be entered to boot or enter Setup. In Setup the User will have Administrator rights					
The password length must be in the following range:					
Minimum length			3		→ ← Select Screen
Maximum length			20		↑ ↓ Select Item
Administrator Password					Enter: Select
					+ - Change Field
					F1: General Help

User Password		F2: Previous Values
UEFI Secure Boot Management		F3: Optimized Default
Secure Boot control	Enabled	F4: Save
▶ Secure Boot Policy		ESC: Exit
▶ Key Management		

Administrator Password

Set Setup Administrator Password.

User Password

Set User Password.

Secure Boot control

Secure Boot flow control.

Secure Boot is possible only if System runs in User Mode.

Secure Boot Policy

Select Secure Boot mode extended options: Internal FV, Option ROM, Removable Media, Fixed Media.

Administrator Password

Set Setup Administrator Password.

Save & Exit Settings

Main	Advanced	Chipset	Boot	Security	Save & Exit
Save Changes and Exit					
Discard Changes and Exit					
Save Changes and Reset					
Discard Changes and Reset					
Save Options					

Save Changes	
Discard Changes	→ ← Select Screen
	↑ ↓ Select Item
Restore Defaults	Enter: Select
Save as User Defaults	+ - Change Field
Restore User Defaults	F1: General Help
	F2: Previous Values
	F3: Optimized Default
Boot Override	F4: Save
	ESC: Exit
Launch EFI Shell from filesystem device	

Save Changes and Exit

Exit system setup after saving the changes.

Discard Changes and Exit

Exit system setup without saving any changes.

Save Changes and Reset

Reset the system after saving the changes.

Discard Changes and Reset

Reset system setup without saving any changes.

Save Changes

Save Changes done so far to any of the setup options.

Discard Changes

Discard Changes done so far to any of the setup options.

Restore Defaults

Restore/Load Defaults values for all the setup options.

Save as User Defaults

Save the changes done so far as User Defaults.

Restore User Defaults

Restore the User Defaults to all the setup options.

Launch EFI Shell from filesystem device

Attempts to Launch EFI Shell application (Shellx64.efi) from one of the available filesystem devices.

Drivers Installation

This section describes the installation procedures for software and drivers. The software and drivers are included with the motherboard. If you find the items missing, please contact the vendor where you made the purchase. The contents of this section include the following:

IMPORTANT NOTE:

After installing your Windows operating system, you must install first the Intel Chipset Software Installation Utility before proceeding with the drivers installation.

VGA Drivers Installation

1. Insert the drivers DVD that comes with the board. Click **AMD**, then **AMD A70M Chipset Drivers**.

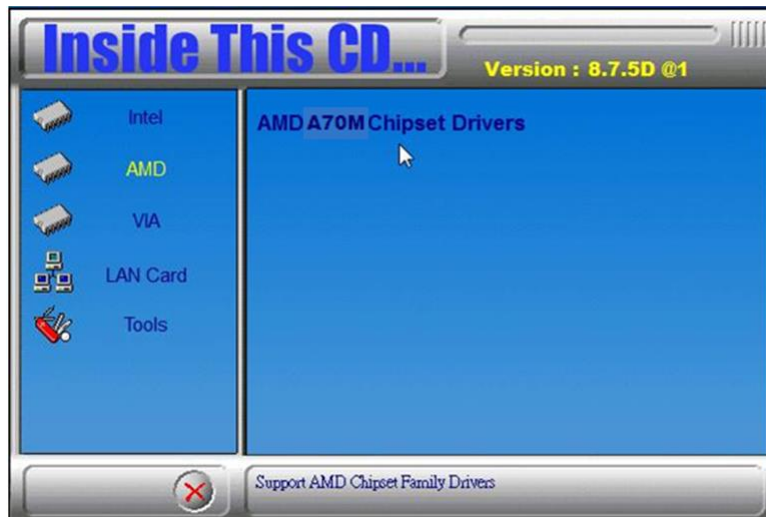

2. Click AMD A70M Series Graphics Drivers.

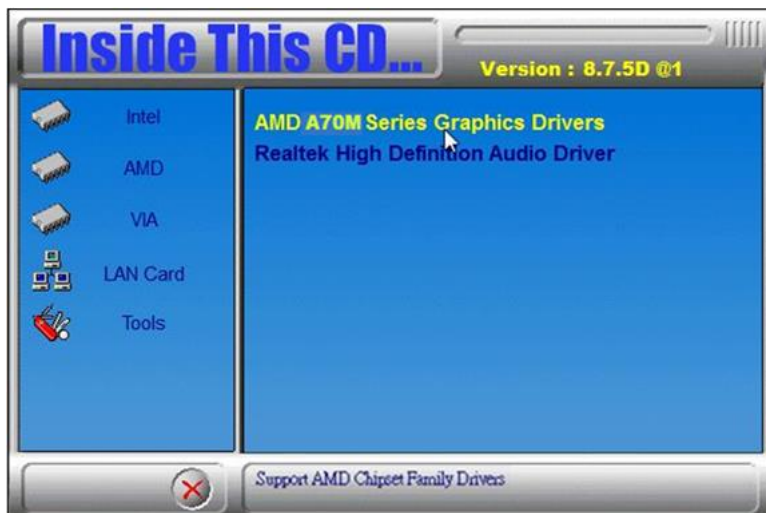

3. When the welcome screen appears, click **Next**.

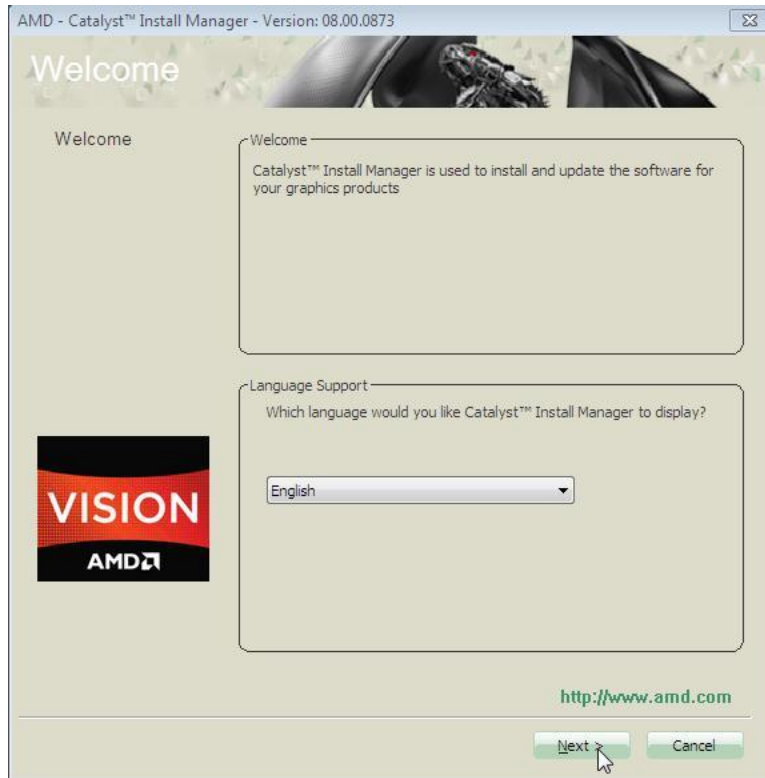

4. Select the language you would like to be displayed and click **Next**.

5. Click **Next** to continue the installation process.



6. Select **Express** and the **installation location** and click **Next**.

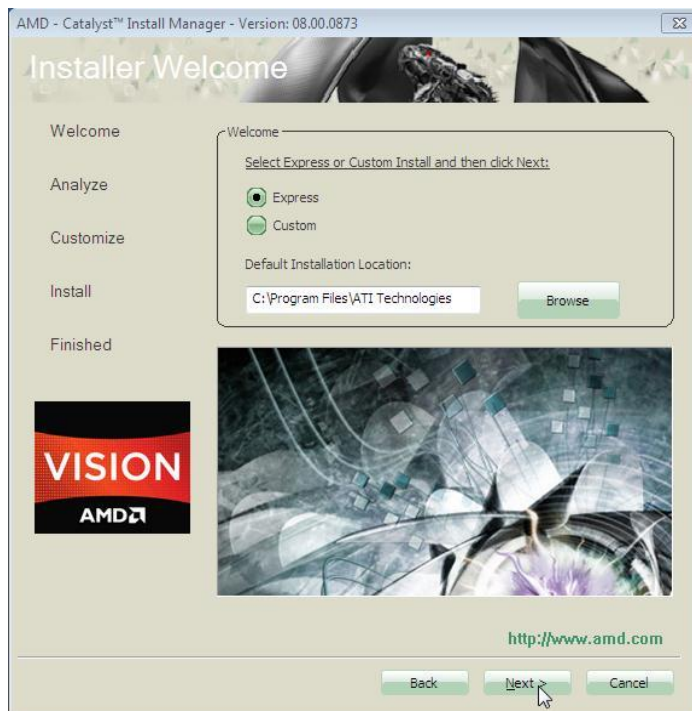

7. Click **Accept** to accept the End User License Agreement.



8. To reboot the system, click **Yes**.

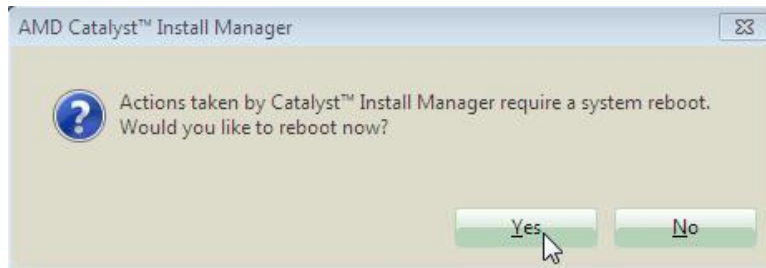

Audio Drivers Installation

1. Insert the drivers DVD that comes with the board. Click **AMD**, then **Realtek High Definition Audio Driver**.

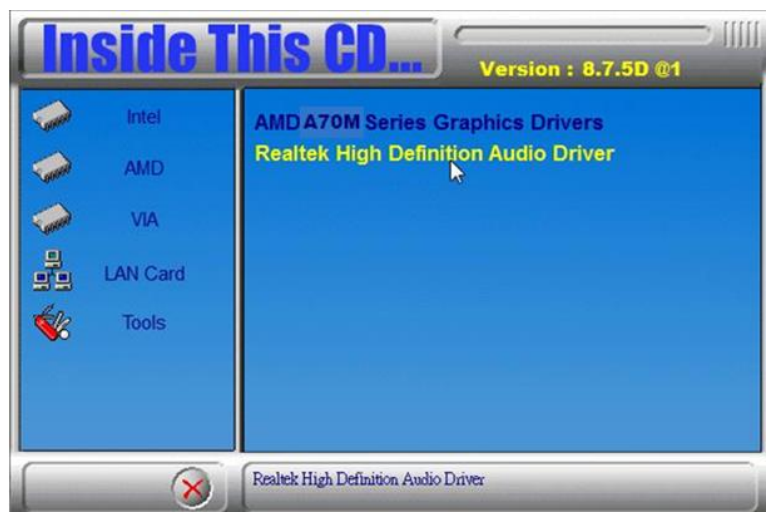

2. When the Welcome screen to the InstallShield Wizard appears, click **Next**.
InstallShield Wizard is now complete, click **Finish** to restart the system and for changes to take effect.

LAN Drivers Installation

1. Insert the drivers DVD that comes with the board. Click **LAN Card**.

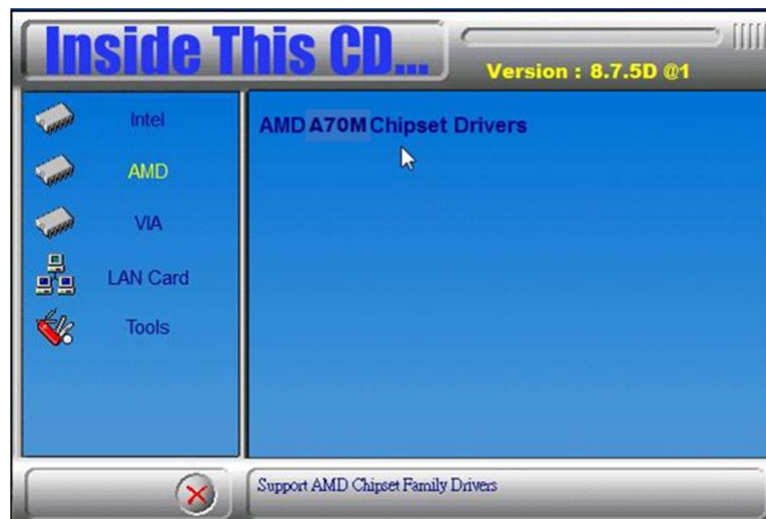

2. Click **Realtek LAN Controller Drivers**



3. Click **Realtek RTL8111E LANDrivers.**



4. When the Welcome screen appears, click **Next.**

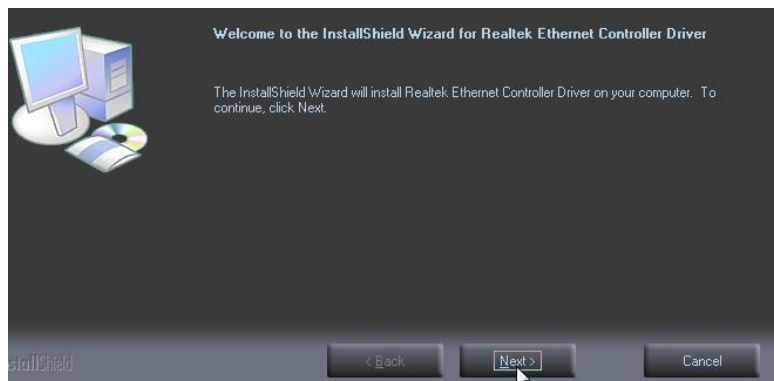

5. Now click **Install** to begin the installation.

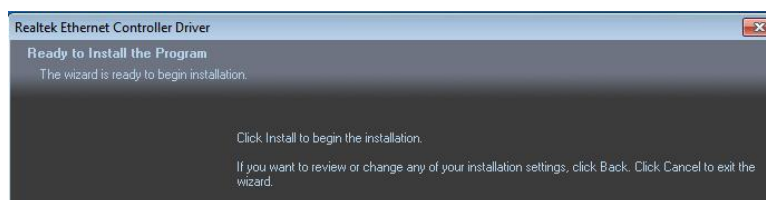

6. InstallShield Wizard is complete. Click **Finish.**

Appendix

A. I/O Port Address Map

Each peripheral device in the system is assigned a set of I/O port addresses, which also becomes the identity of the device. The following table lists the I/O port addresses used.

Address	Device Description
0000h-0CF7h	PCI bus
0000h-0CF7h	Direct memory access controller
0010h-001Fh	Motherboard resources
0020h-0021h	Programmable interrupt controller
0022h-003Fh	Motherboard resources
0040h-0043h	System timer
0044h-005Fh	Motherboard resources
0060h-0060h	Standard 101/102-Key or Microsoft Natural PS/2 Keyboard
0061h-0061h	System speaker
0062h-0063h	Motherboard resources
0064h-0064h	Standard 101/102-Key or Microsoft Natural PS/2 Keyboard
0065h-006Fh	Motherboard resources

0070h-0073h	System CMOS/real time clock
0074h-007Fh	Motherboard resources
0080h-0090h	Direct memory access controller
0091h-0093h	Motherboard resources
0094h-009Fh	Direct memory access controller
00A0h-00A1h	Programmable interrupt controller
00A2h-00BFh	Motherboard resources
00C0h-00DFh	Direct memory access controller
00E0h-00EFh	Motherboard resources
00F0h-00FFh	Numeric data processor
0170h-0177h	Secondary IDE Channel
01F0h-01F7h	Primary IDE Channel
0274h-0277h	ISAPNP Read Data Port
0279h-0279h	ISAPNP Read Data Port
03F8H-03FFFh	Communications Port (COM1)

B. Interrupt Request Lines (IRQ)

Peripheral devices use interrupt request lines to notify CPU for the service required. The following table shows the IRQ used by the devices on board.

Level	Function
IRQ 0	System timer
IRQ 1	Standard 101/102-Key
IRQ 3	Communications Port (COM2)
IRQ 4	Communications Port (COM1)
IRQ 8	System CMOS/real time clock
IRQ 12	PS/2 Compatible Mouse
IRQ 13	Numeric data processor
IRQ 16	High Definition Audio Controller
IRQ 16	PCI standard PCI-to-PCI bridge
IRQ 17	Standard Enhanced PCI to USB Host Controller
IRQ 17	Standard Enhanced PCI to USB Host Controller
IRQ 17	Standard Enhanced PCI to USB Host Controller
IRQ 18	High Definition Audio Controller
IRQ 18	Standard Open HCD USB Host Controller
IRQ 18	Standard Open HCD USB Host Controller
IRQ 18	Standard Open HCD USB Host Controller
IRQ 18	Standard Open HCD USB Host Controller

IRQ 19	PCI standard PCI-to-PCI bridge
IRQ 19	AMD AHCI Compatible RAID Controller

C. Watchdog Timer Configuration

The WDT is used to generate a variety of output signals after a user programmable count. The WDT is suitable for use in the prevention of system lock-up, such as when software becomes trapped in a deadlock. Under these sorts of circumstances, the timer will count to zero and the selected outputs will be driven. Under normal circumstance, the user will restart the WDT at regular intervals before the timer counts to zero.

SAMPLE CODE:

```
//-----
//
// THIS CODE AND INFORMATION IS PROVIDED "AS IS" WITHOUT WARRANTY OF ANY
// KIND, EITHER EXPRESSED OR IMPLIED, INCLUDING BUT NOT LIMITED TO THE
// IMPLIED WARRANTIES OF MERCHANTABILITY AND/OR FITNESS FOR A PARTICULAR
// PURPOSE.
//
//-----
#include <dos.h>
#include <conio.h>
#include <stdio.h>
#include <stdlib.h>
#include "6106"
//-----
int main (int argc, char *argv[]);
void EnableWDT(int);
void DisableWDT(void);
//-----
int main (int argc, char *argv[])
{
```

```

        unsigned char bBuf;
        unsigned char bTime;
        char **endptr;

//
        char SIO;
        printf("6106 watch dog program\n");

        bTime = strtol (argv[1], endptr, 10);
        printf("System will reset after %d seconds\n", bTime);

        if (bTime)
        {
            EnableWDT(bTime);
        }
        else
        {
            DisableWDT();
        }

        if (bTime > 0 && bTime < 256)
        {
            int A;

A=2;

            do{

                unsigned char result;
                Set_6106_LD(0x08);

                gotoxy(1,12);

                result=Get_6106_Reg(0xF1);

                printf("Timer is %i \n",result);

            }while(A!=1);

        }

        return 0;
    }

//-----
void EnableWDT(int interval)
{
    unsigned char bBuf;

    Set_6106_LD(0x08);

```

```

//switch to logic device 8

Set_6106_Reg(0x30, 0x01);

Set_6106_Reg(0xF1, interval);

}

//-----

void DisableWDT(void)

{

    unsigned char bBuf;

    Set_6106_LD(0x08);

//switch to logic device 7

Set_6106_Reg(0x30, 0x00);

}

//-----

//

// THIS CODE AND INFORMATION IS PROVIDED "AS IS" WITHOUT WARRANTY OF ANY

// KIND, EITHER EXPRESSED OR IMPLIED, INCLUDING BUT NOT LIMITED TO THE

// IMPLIED WARRANTIES OF MERCHANTABILITY AND/OR FITNESS FOR A PARTICULAR

// PURPOSE.

//

//-----

#include "6106.H"

#include <dos.h>

//-----

unsigned int 6106_BASE;

void Unlock_6106 (void);

void Lock_6106 (void);

//-----

unsigned int Init_6106(void)

{

    unsigned int result;

    unsigned char ucDid;

    F81865_BASE = 0x4E;

    result = 6106_BASE;

```

```
Init_Finish:
```

```
}
```

```
//-----
```

```
void Unlock_6106 (void)
```

```
{
```

```
ucDid = Get_6106_Reg(0x20);
```

```
if (ucDid == 0x07)
```

```
//Fintek 81865
```

```
{
```

```
goto Init_Finish;
```

```
}
```

```
F81865_BASE = 0x2E;
```

```
result = 6106_BASE;
```

```
ucDid = Get_6106_Reg(0x20);
```

```
if (ucDid == 0x07)
```

```
//Fintek 81865
```

```
{
```

```
goto Init_Finish;
```

```
}
```

```
F81865_BASE = 0x00;
```

```
result = 6106_BASE;
```

```
return (result);
```

```
outportb(6106_INDEX_PORT, 6106_UNLOCK);
```

```

}

//-----

void Lock_6106 (void)
{

}

//-----

void Set_6106_LD( unsigned char LD)
{

}

//-----

void Set_6106_Reg( unsigned char REG, unsigned char DATA)
{

}

//-----

unsigned char Get_6106_Reg(unsigned char REG)
{

}

//-----

```

```

outportb(6106_INDEX_PORT, 6106_UNLOCK);

outportb(6106_INDEX_PORT, 6106_LOCK);

Unlock_6106();
outportb(6106_INDEX_PORT, 6106_REG_LD);
outportb(6106_DATA_PORT, LD);
Lock_6106();

Unlock_6106();
outportb(6106_INDEX_PORT, REG);
outportb(6106_DATA_PORT, DATA);
Lock_6106();

unsigned char Result;
Unlock_6106();
outportb(6106_INDEX_PORT, REG);
Result = inportb(6106_DATA_PORT);
Lock_6106();
return Result;

```