

QBiX-PPC-101A3940T-A1

10.1" Industrial Panel PC system with 3.5" SBC Intel® x5-E3940 Processor Motherboard



Features

- 10.1" Industrial Panel PC system
- 10 points, Projected capacitive touch screen
- Intel® Atom® x5-E3940
- Dual Channel DDR3L, 2 x SO-DIMMs
- 2 x LAN Ports, 1 x COM Port, 2 x USB 3.2 Gen 1, 2 x USB 2.0
- Fanless system design
- Long life time support
- Support VESA mount 100 x 100mm

Specifications

Dimension	System Size : 285.3W x 51.3D x 176.3H (mm)
Motherboard	QBiP-E3940A
LCD	Display Type : 10.1" TFT LCD panel Resolution : 1280 x 800 Brightness : 300 cd/m ² View angel : 80°/85° (H), 80°/85° (V) Contrast Ratio : 1300:1 Response time : 25 ms Backlight lifetime : 15,000 hrs
Touch screen	Type : 10 points, projected capacitive Viewing Area : 217.46L x 136.1W Active Area : 216.96L x 135.6W Surface Hardness : >=3H Transparency : >85%
CPU	Intel® Atom® x5-E3940 Processor 14nm, 4 cores, 4 threads, up to 1.8 GHz TDP 9.5W
Memory	2 x DDR3L SO-DIMM sockets, Max. Capacity 8 GB Support Dual channel DDR3L 1866 MHz memory modules
Ethernet	2 x GbE LAN Ports (Intel® I211AT)
Expansion Slots	1 x 2242 M.2 M-Key (SATA 6Gb/s) 1 x Full-size Mini PCIe with SIM slot (PCIe x1 + USB2.0) -- support 3G module
I/O	1 x COM Port (RS-232/422/485 & RI/5V/12V) 1 x Headphone Jack 2 x RJ45 LAN Ports 2 x USB 3.2 Gen 1 1 x HDMI 1 x D-sub 1 x 3-pin Terminal block 1 x Power button with LED 2 x USB 2.0 2 x External Antenna Holes (Optional)
Speaker	2 x 2W speaker
Power	+9V~36VDC (Full Range)
Operation temperature	Operating temperature: 0°C to 60°C Operating humidity: 0-90% (non-condensing) Non-operating temperature: -40°C to 70°C Non-operating humidity: 0%-95% (non-condensing) Use wide temperature range memory and storage
Vibration During Operation	Operation: IEC 60068-2-64, 1 Grms, random, 5 ~ 500 Hz, 1 hr / Per Axis, With SSD/M.2 2242 Non-operation: IEC 60068-2-6, 2 G, Sine, 10 ~ 500 Hz, 1 Oct/min, 1 hr / Per Axis
Shock During Operation	Operation: IEC 60068-2-27, 50 G, half sine, 11 ms duration, With SSD

GIGAIPC reserves the right to modify or change technical data without prior notice.

Dimension

Unit: mm

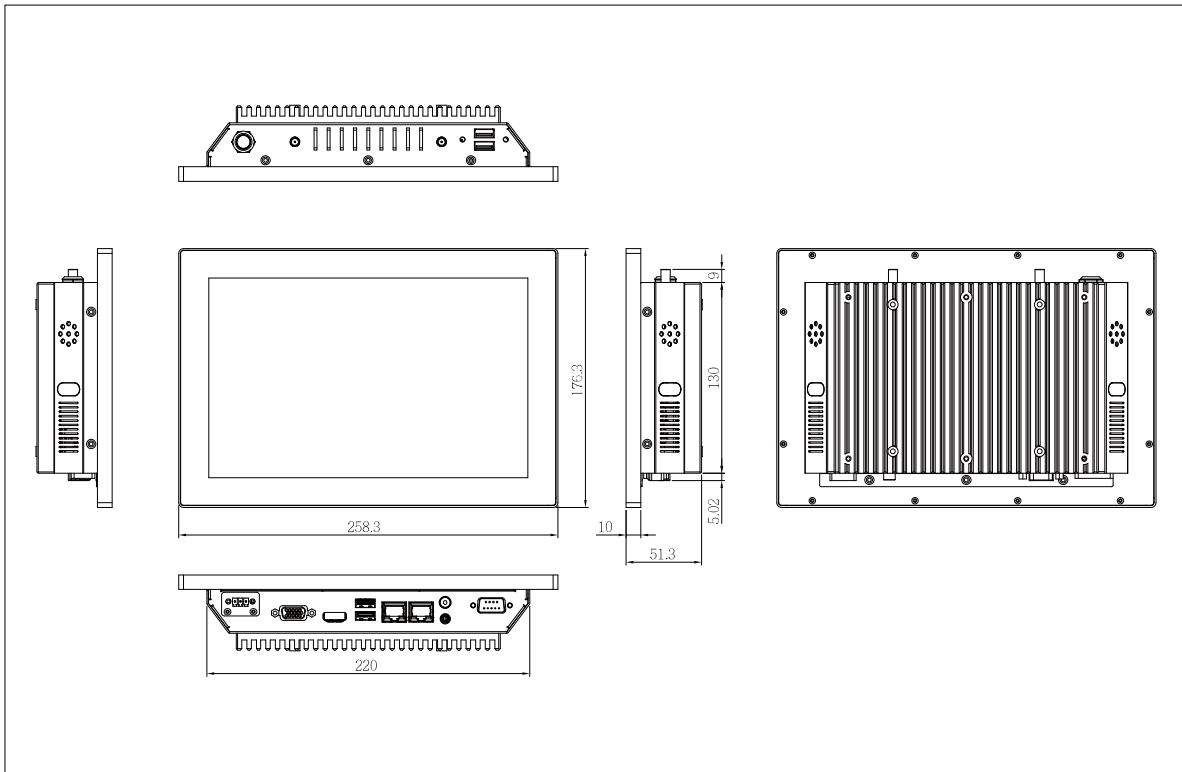

Packing Content

- Carton size: 505 x 324 x 358 (mm)
- Packing Capacity: 4pcs
- Including:
 - Thermal Pad for Memory x 1 (P/N: 25ST3-200051-T5R)
 - Camera Bracket x 1
 - Terminal Blocks Male Plug x 1

Order Information

- System: 6BPS3940AMR-SI (Box packing)

2022/11/14

GIGAIPC reserves the right to modify or change technical data without prior notice.