

16/24/27/32/40" 4K UHD Rack Mount Military Display



4K
ULTRA HD

Model No.
W15L100-MLB3FP
W24L100-MLL1FP
W27L100-MLA3FP
W27L100-MLA3FG
W32L100-MLA1FP
W32L100-MLA3FP
W40L100-MLM1FG

User Manual

Contents

Preface	3
About This User Manual	6
Chapter 1: Introduction	7
1.1 Overview.....	8
1.2 Product Features	8
1.3 Package Contents	8
1.4 Connector Description	9
1.5 Panel Controls	10
1.6 Dimensions.....	12
Chapter 2: Installation	15
2.1 Wiring Requirements	16
2.2 Mounting the Display	17
2.2.1 Panel Mount.....	17
2.2.2 VESA Mount	18
2.3 Powering On.....	19
2.3.1 Connecting to AC Input Power Source (Default).....	19
2.3.2 Connecting to DC Input Power Source (Optional).....	20
2.4 Connecting Other Devices	21
2.4.1 VGA Connector.....	21
2.4.2 HDMI Connector	22
2.4.3 DVI-D Connector.....	23
2.4.4 Display Port Connector	23
2.4.5 Audio Connector	24
2.4.6 Optional RS-232 Connector for Remote Control.....	24
2.4.7 Optional USB Connector for Touch.....	24
Chapter 3: Operating the Device	25
3.1 Navigating the OSD Menu	26
3.1.1 Display	26
3.1.2 Adjust.....	28
3.1.3 Audio.....	30
3.1.4 Multi-Display	31
3.1.5 OSD	32
3.1.6 Advanced.....	32
3.2 Frequency Table.....	34
Appendix	35
Appendix A: Technical Specifications	36

Appendix B: Military Grade Compliance 40

Appendix C: Maintenance..... 41

Preface

Copyright Notice

No part of this document may be reproduced, copied, translated, or transmitted in any form or by any means, electronic or mechanical, for any purpose, without the prior written permission of the original manufacturer.

Trademark Acknowledgement

Brand and product names are trademarks or registered trademarks of their respective owners.

Disclaimer

We reserve the right to make changes, without notice, to any product, including circuits and/or software described or contained in this manual in order to improve design and/or performance. We assume no responsibility or liability for the use of the described product(s) conveys no license or title under any patent, copyright, or masks work rights to these products, and make no representations or warranties that these products are free from patent, copyright, or mask work right infringement, unless otherwise specified. Applications that are described in this manual are for illustration purposes only. We make no representation or guarantee that such application will be suitable for the specified use without further testing or modification.

Warranty

Our warranty guarantees that each of its products will be free from material and workmanship defects for a period of one year from the invoice date. If the customer discovers a defect, we will, at his/her option, repair or replace the defective product at no charge to the customer, provide it is returned during the warranty period of one year, with transportation charges prepaid. The returned product must be properly packaged in its original packaging to obtain warranty service. If the serial number and the product shipping data differ by over 30 days, the in-warranty service will be made according to the shipping date. In the serial numbers the third and fourth two digits give the year of manufacture, and the fifth digit means the month (e. g., with A for October, B for November and C for December).

For example, the serial number 1W18Axxxxxxx means October of year 2018.

Customer Service

We provide a service guide for any problem by the following steps: First, visit the website of our distributor to find the update information about the product. Second, contact with your distributor, sales representative, or our customer service center for technical support if you need additional assistance.

You may need the following information ready before you call:

- Product serial number
- Software (OS, version, application software, etc.)
- Description of complete problem
- The exact wording of any error messages

In addition, free technical support is available from our engineers every business day. We are always ready to give advice on application requirements or specific information on the installation and operation of any of our products.

Federal Communications Commission Radio Frequency Interface Statement



This device complies with part 15 FCC rules.

Operation is subject to the following two conditions:

- This device may not cause harmful interference.
- This device must accept any interference received including interference that may cause undesired operation.

This equipment has been tested and found to comply with the limits for a class "B" digital device, pursuant to part 15 of the FCC rules. These limits are designed to provide reasonable protection against harmful interference when the equipment is operated in a commercial environment. This equipment generates, uses, and can radiate radio frequency energy and, if not installed and used in accordance with the instruction manual, may cause harmful interference to radio communications. Operation of this equipment in a residential area is likely to cause harmful interference in which case the user will be required to correct the interference at his own expense.

European Union



This equipment is in conformity with the requirement of the following EU legislations and harmonized standards. Product also complies with the Council directions.

Electromagnetic Compatibility Directive (2014/30/EU)

- EN55024: 2010/ A1: 2015
 - IEC61000-4-2: 2009
 - IEC61000-4-3: 2006+A1: 2007+A2: 2010
 - IEC61000-4-4: 2012
 - IEC61000-4-5: 2014
 - IEC61000-4-6: 2014
 - IEC61000-4-8: 2010
 - IEC61000-4-11: 2004
- EN55032: 2012/AC:2013
- EN61000-3-2:2014
- EN61000-3-3:2013

Low Voltage Directive (2014/35/EU)

- EN 60950-1:2006/A11:2009/A1:2010/A12:2011/ A2:2013

Advisory Conventions

Four types of advisories are used throughout the user manual to provide helpful information or to alert you to the potential for hardware damage or personal injury. These are Notes, Important, Cautions, and Warnings. The following is an example of each type of advisory.



Note:

A note is used to emphasize helpful information



Important:

An important note indicates information that is important for you to know.



Caution/ Attention

A Caution alert indicates potential damage to hardware and explains how to avoid the potential problem.

Une alerte 'attention' indique un dommage possible à l'équipement et explique comment éviter le problème potentiel.



Warning!/ Avertissement!

An Electrical Shock Warning indicates the potential harm from electrical hazards and how to avoid the potential problem.

Un Avertissement de Choc Électrique indique le potentiel de choc sur des emplacements électriques et comment éviter ces problèmes.



Alternating Current / Mise à la Terre

The Protective Conductor Terminal (Earth Ground) symbol indicates the potential risk of serious electrical shock due to improper grounding.

Le symbole de Mise à Terre indique le risque potentiel de choc électrique grave à la terre incorrecte.

Safety Information



Warning!/ Avertissement!

This monitor is equipped with Mini USB port, signals and power is obtained from standard USB 2.0 or USB 3.0 port. Do not expose this unit in the rain or moisture environment to damage the monitor.



Caution/ Attention!

Do not touch the surface of the LCD panel. Pressure on the panel may cause non-uniformity of color or disorientation of the liquid crystals.

PRECAUTIONS:

- Do not use the monitor near water.
- Do not place the monitor on an unstable cart, stand, or table. If the monitor falls, it can injure a person and cause serious damage to the appliance. Use only a cart or stand recommended by the manufacturer or sold with the monitor. If you mount the monitor on a wall or shelf, use a mounting kit approved by the manufacturer and follows the kit instructions.
- The monitor should be operated with an USB cable with Mini USB B type connector on monitor end and standard USB A type connector on the other end to PC or USB signal source.
- Normally it is packed with monitor.
- Never spill liquids on the monitor.
- Do not attempt to service the monitor yourself; opening or removing covers can damage to the monitor or panel. Please refer all servicing to qualified service personnel.
- For Wall mount adaptor, wall socket shall be installed near the equipment and shall be easily accessible.

About This User Manual

This User Manual provides information about using the 27/32/40" 4K UHD Rack Mount Display. The documentation set provides information for specific user needs, and includes:

- **27/ 32/40" 4K UHD Rack Mount Display User Manual** – contains detailed description on how to use the display, its components and features.



Note:

Some pictures in this guide are samples and can differ from actual product.

Chapter 1: Introduction

This chapter gives you product overview, describes features and hardware specification. You will find all accessories that come with the display device in the packing list. Mechanical dimensions and drawings included in this chapter.

1.1 Overview

Congratulations on purchasing Winmate® 27/32" 4K UHD Rack Mount Military Display. Featuring anti-corrosive coating with aluminum alloy housing withstands the harshest military environments. Armored power connector MIL-DTL-38999 Type I initially developed for aerospace industry perfectly fit in our military grade product line.

1.2 Product Features

4K UHD Rack Mount Military Display features:

- 16/ 24/ 27/ 32/ 40" Display with UHD 4K (3840 x 2160) native resolution
- Dimmable 0-100% with backlight light sensing
- Thin and compact design with impact resistant screen
- Panel mount design with front side removable handle
- AR protection glass or Projected capacitive multitouch screen

1.3 Package Contents

Carefully remove the box and unpack your display. Please check if all the items listed below are inside your package. If any of these items are missing or damaged contact us immediately.

Standard package includes:

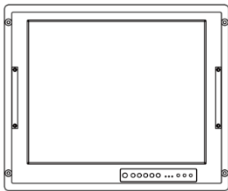

- **Display**



- **User Manual (Hardcopy)**

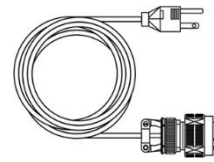

- **Power Cord MIL-DTL-38999/1 (2m)**

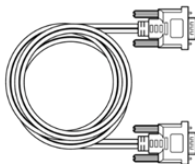

- **VGA Cable (2m)**

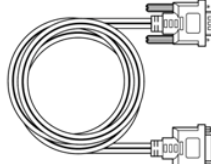

- **DVI Cable (2m)**

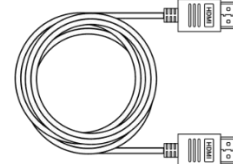

- **HDMI Cable (2m)**

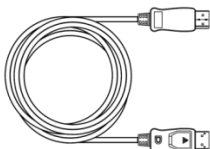







- **Display Port Cable (2m)**

The package may include the following optional items based on your order:

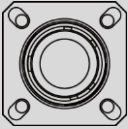
- 1 x Touch Driver CD
- 1 x RS-232 Remote Control Shielding Cable, 2 meter
- 1 x USB for Touch Cable

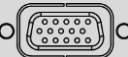
1.4 Connector Description

Display connectors are located on the bottom rear side of the display.

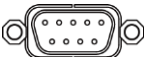
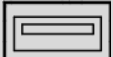
Item	Description	Function
	Power input connector	Power input 24V DC 150W, with external AC to DC Adapter 110-240V.
	Audio connector	Connects microphone to display.
	VGA connector	The 15-pin VGA connector transmits video from video source to display.
	Display Port 1.2 connector	Transmits a video source to a display.
	HDMI 2.0 connector	Transmits uncompressed video data and compressed or uncompressed digital audio data from a display.
	HDMI 1.X connector	Transmits uncompressed video data and compressed or uncompressed digital audio data from a display.
	DVI-D connector	Transmits uncompressed digital video from video source to display.
	RS232 (Optional)	For remote control.
	USB connector (Optional)	For touch interface.

* I/O position varies by display size. Refer to the section [1.6 Dimensions](#) of this user manual to check mechanical drawing and I/O position.

1.5 Panel Controls

Panel controls are located on the front side of the display.

Option 1 (AR Protection Glass, No Touch)

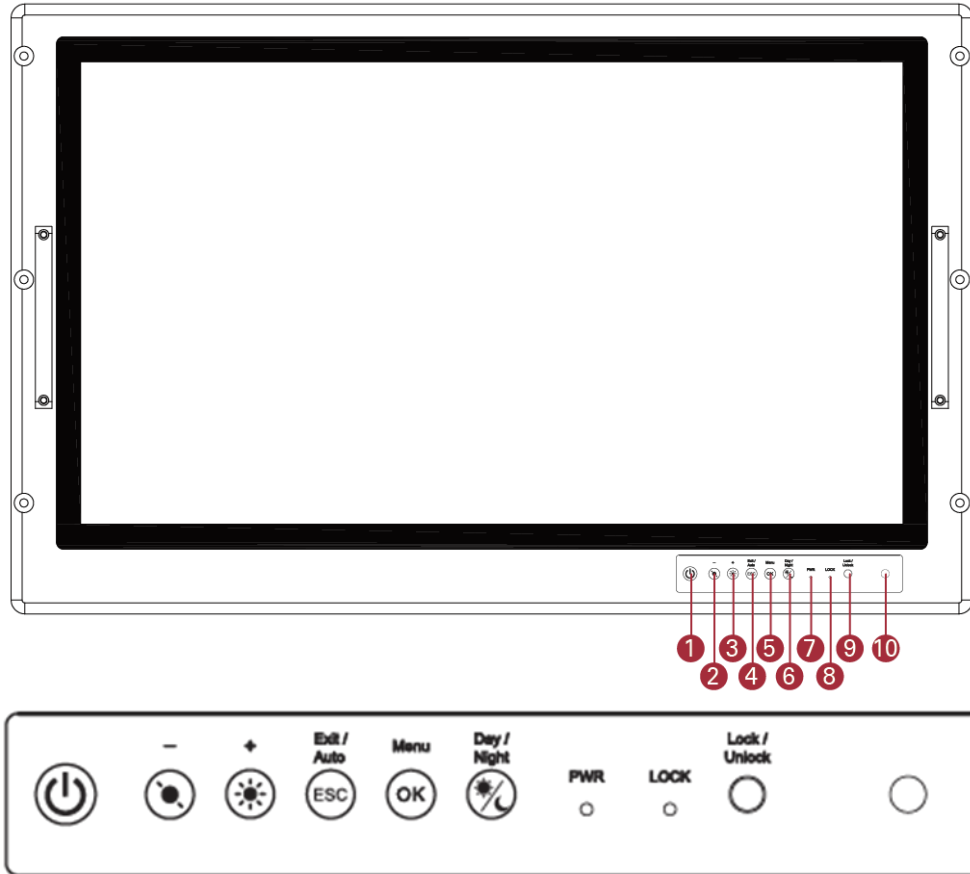

Item	Description	Function
1	Power	Press to turn on or turn off the display.
2	Decrease	Press this key to decrease screen brightness. Use to navigate items of a single OSD menu.
3	Increase	Press this key to increase screen brightness. Use to navigate items of a single OSD menu.
4	Exit/ Auto	Automatically adjusts brightness of the display screen, or allows user to exit the OSD menu.
5	Menu	Allows user to enter the main menu.
6	Day/ Night	Tap this button to enter DAY MODE. Tap this button to enter NIGHT MODE to increase visibility in low-light conditions.
7	Power LED	<ul style="list-style-type: none"> ● Lights up green when the display turns on; signals that display functions normally. ● Lights up orange when display is suspended.
8	Lock LED	<ul style="list-style-type: none"> ● Lights up red when OSD button locked. <p>OFF Turns off when OSD button lock function disabled.</p>
9	Lock/ Unlock	Tap this button to lock/ unlock the function of OSD panel.
10	Light Sensor	Detect light density.

Option 2 (Projected Capacitive Multi Touch)

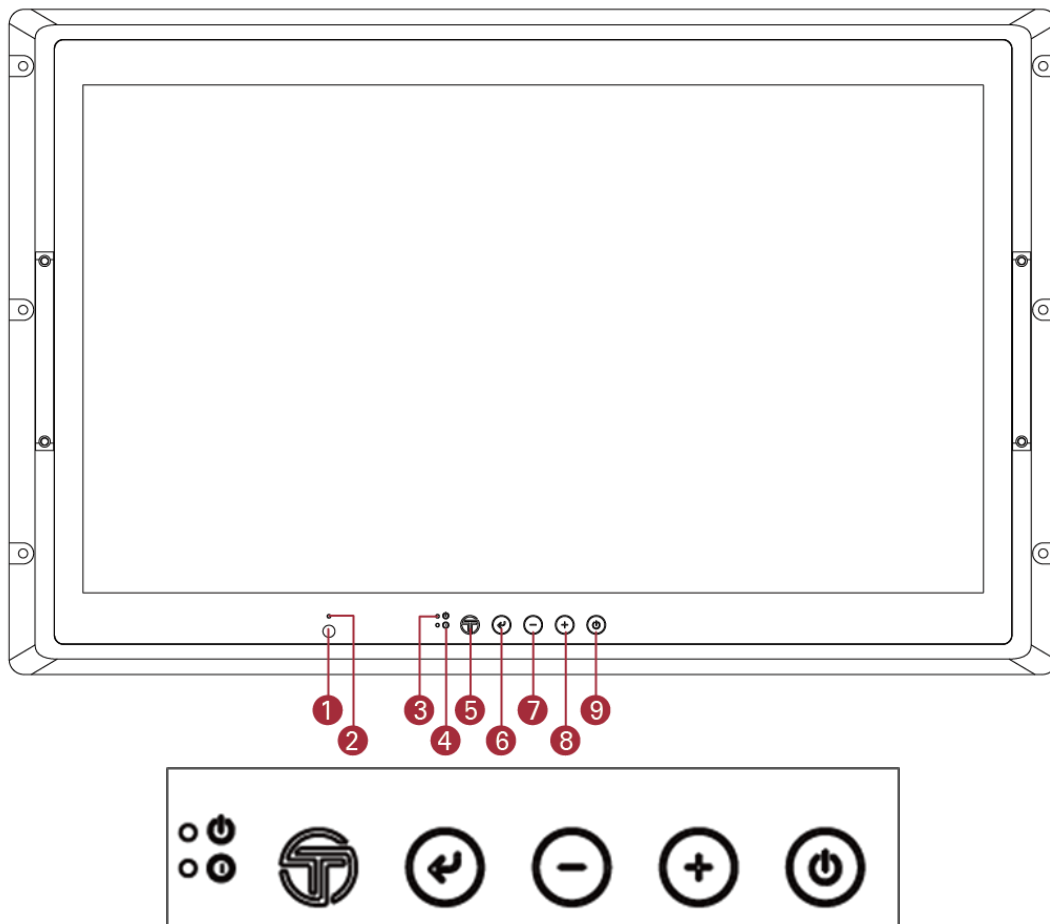

Item	Description	Function
1	IR Receiver	IR receiver for infrared remote control.
2	Light Sensor	Detect light density.
3	Power LED	Lights up when the display turns on; signals that display functions normally.
4	Sleep	Indicates when the system is in sleep mode.
5	Menu	Displaying: Tap to close OSD menu. Off: Tap to open the Quick menu.
6	Enter	Displaying: Tap to enter. Off: Tap to open OSD menu.
7	Minus	Displaying: Tap to move down or decrease value. Off: N/A.
8	Plus	Displaying: Tap to move up /or increase value. Off: N/A
9	Power	Displaying: Tap to disable video image. Off: Tap to enable video image.

1.6 Dimensions

W15L100-MLB3FP

Unit: mm

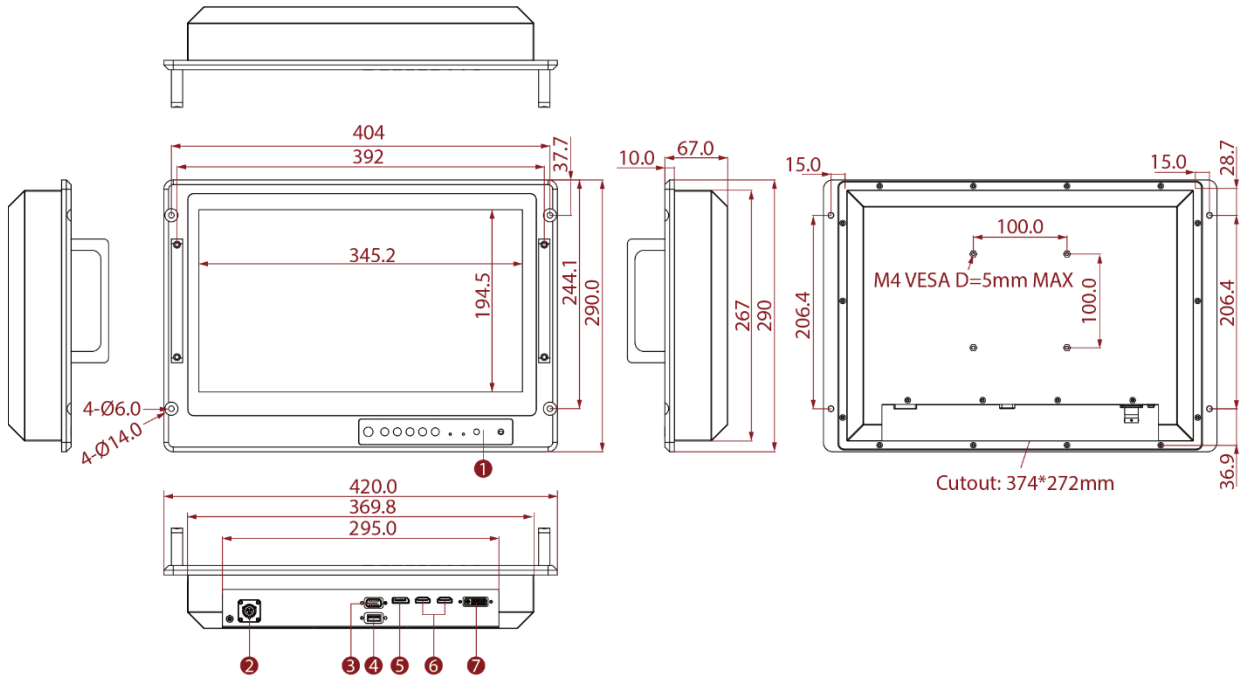

W24L100-MLL1FP

Unit: mm

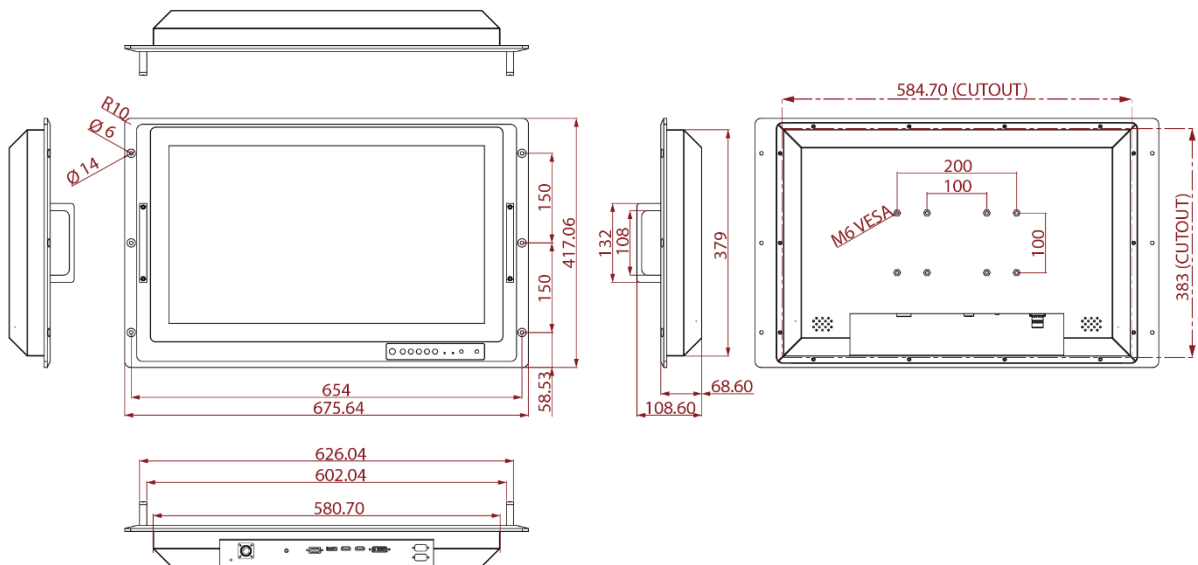

W27L100-MLA3FP

Unit: mm

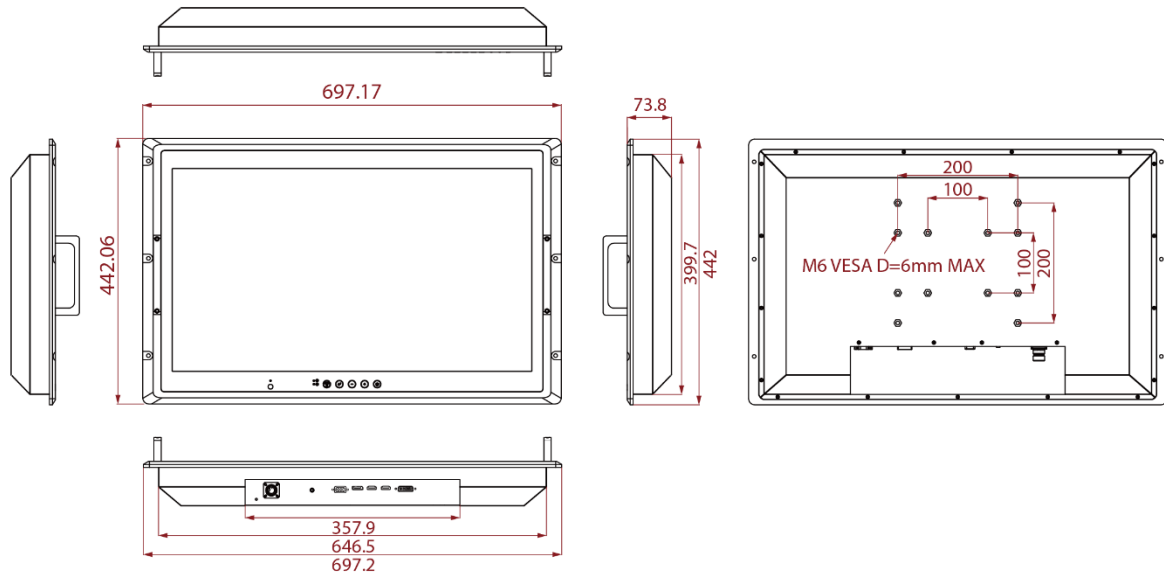

W27L100-MLA3FG

Unit: mm

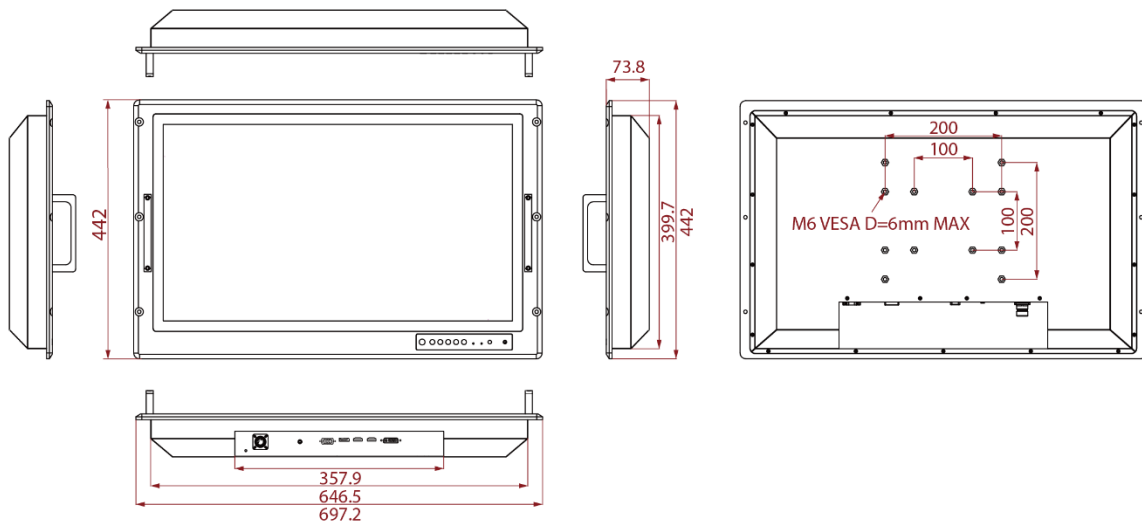

W32L100-MLA1FP

Unit: mm

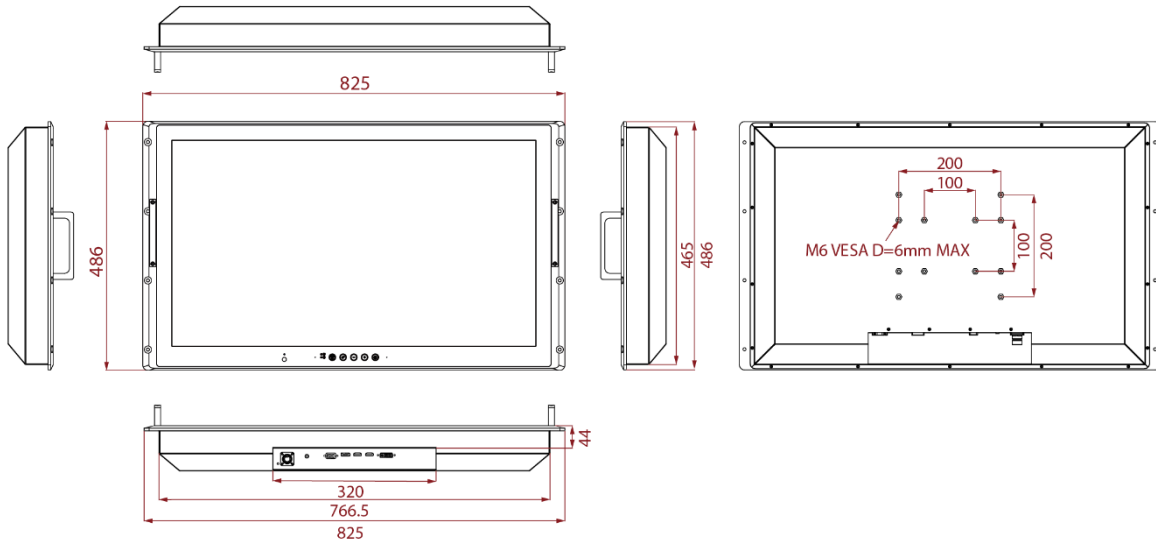

W32L100-MLA3FP

Unit: mm

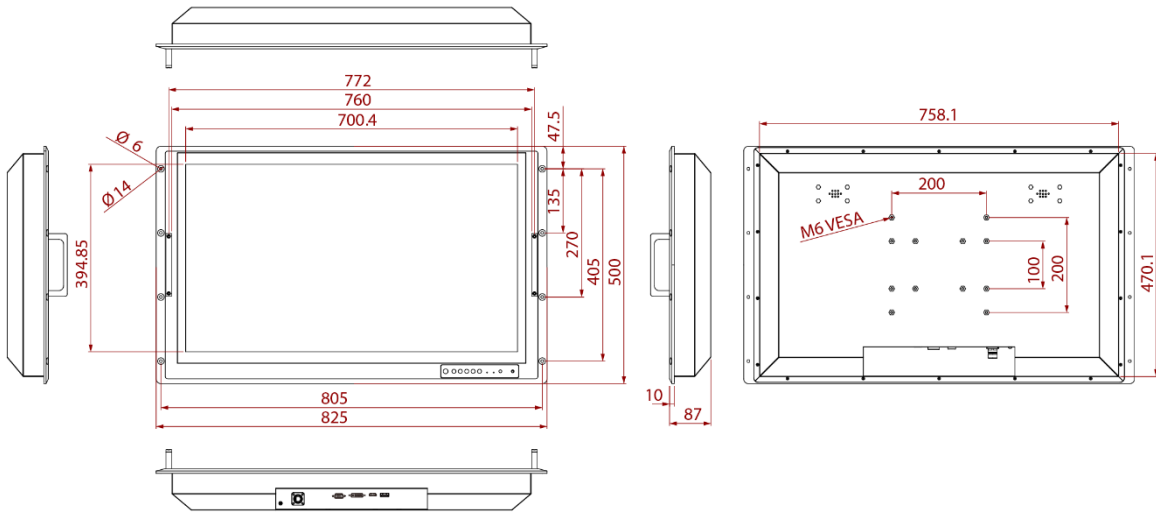

W40L100-MLM1FG

Unit: mm

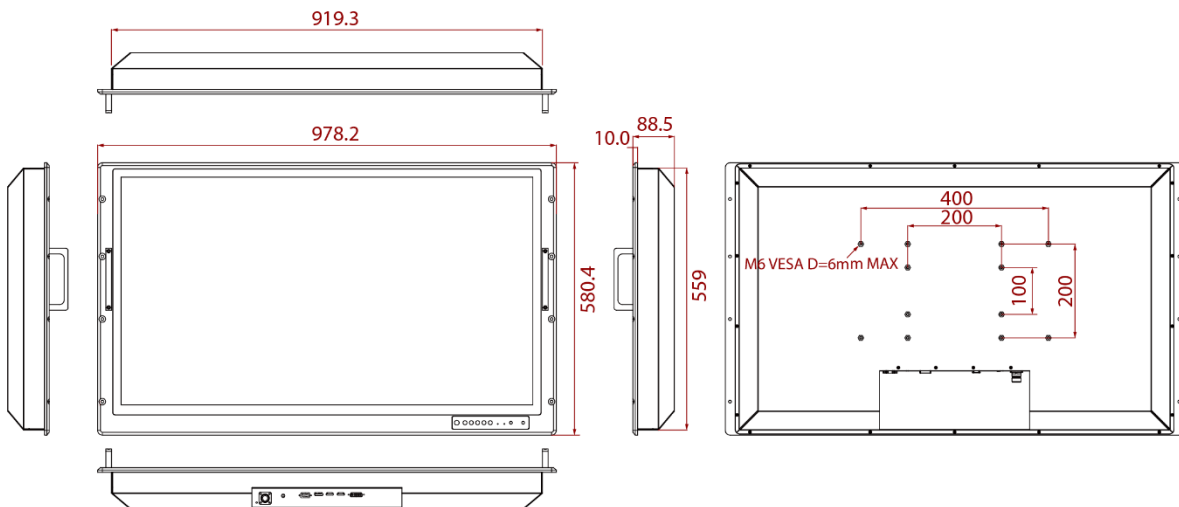

Chapter 2: Installation

This chapter provides hardware installation instructions and mounting guide for all available mounting options. Pay attention to cautions and warning to avoid any damages

2.1 Wiring Requirements

The following common safety precautions should be observed before installing any electronic device:

- Strive to use separate, non-intersecting paths to route power and networking wires. If power wiring and device wiring paths must cross make sure the wires are perpendicular at the intersection point.
- Keep the wires separated according to interface. The rule of thumb is that wiring that shares similar electrical characteristics may be bundled together.
- Do not bundle input wiring with output wiring. Keep them separate.
- When necessary, it is strongly advised that you label wiring to all devices in the system.
- Do not run signal or communication wiring and power wiring in the same conduit. To avoid interference, wires with different signal characteristics (i.e., different interfaces) should be routed separately.
- Be sure to disconnect the power cord before installing and/or wiring your device.
- Verify the maximum possible current for each wire gauge, especially for the power cords. Observe all electrical codes dictating the maximum current allowable for each wire gauge.
- If the current goes above the maximum ratings, the wiring could overheat, causing serious damage to your equipment.



Caution/ Attention

Follow mounting instructions and use recommended mounting hardware to avoid the risk of injury.

Suivez les instructions de montage et d'utilisation recommandé le matériel de montage pour éviter le risque de blessure.



Caution/ Attention

Turn off the device and disconnect other peripherals before installation.

Éteindre l'appareil et débrancher tous les périphériques avant l'installation.

Be careful when handling the unit. When the unit is plugged in, the internal components generate a lot of heat which may leave the outer casing too hot to touch.

2.2 Mounting the Display

The Military Display supports different mounting options. Refer to sub-sections below for more details.

2.2.1 Panel Mount

The main mounting approach for military applications is panel mount – very user-friendly in terms of installation.

Installation Instruction:

1. Prepare a fixture for the specific dimensions of the device.
2. Cut a hole on a sub frame or panel according to the cutout dimensions.
3. Install the device properly onto the cutout area of the sub frame or panel with the sides of the front bezel.
4. Fix the device from the outside to the fixture with four M6 truss head screws.

Console / Rack Mount Installation

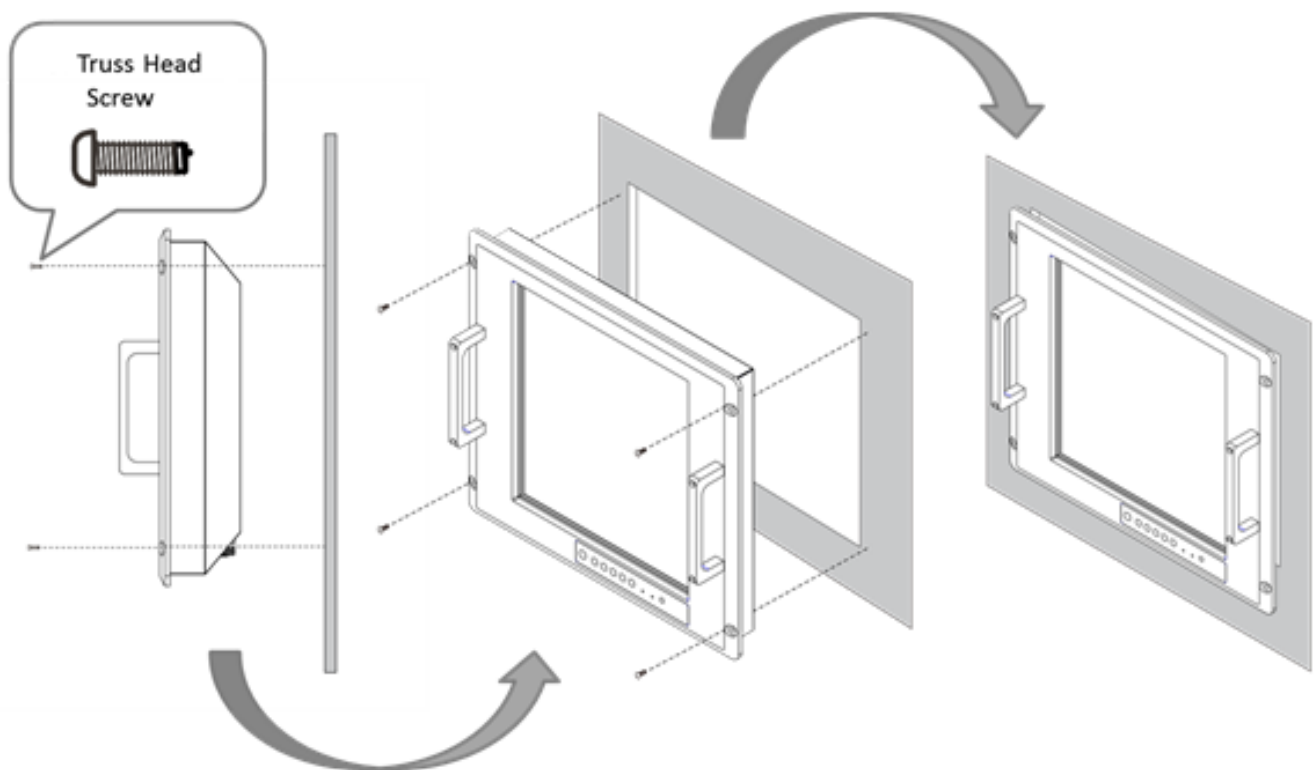

Size	Cutout Dimensions (W x D)	Screw Size
15"	457.6 x 287.7 mm	M6 truss head (4 pcs)
24"	675.6 x 417 mm	M6 truss head (4 pcs)
27"	697.2 x 442 mm	M6 truss head (4 pcs)
32"	825 x 486 mm / 825 x 500 mm	M6 truss head (4 pcs)
40"	978.2 x 580.4 mm	M6 truss head (4 pcs)

2.2.2 VESA Mount

The Military Display supports VESA Mount installation. Notice that VESA Plate is not included in Winmate's standard accessories package.

Installation Instruction:

1. Turn off the display and disconnect peripherals.
2. Screw VESA bracket to the fixture (ex. Swing arm) with four M4 VESA screws.
3. Place the device on VESA bracket.
4. Follow instructions supplied with your mounting kit.
5. Connect cables, power on the display.

VESA Mount Installation

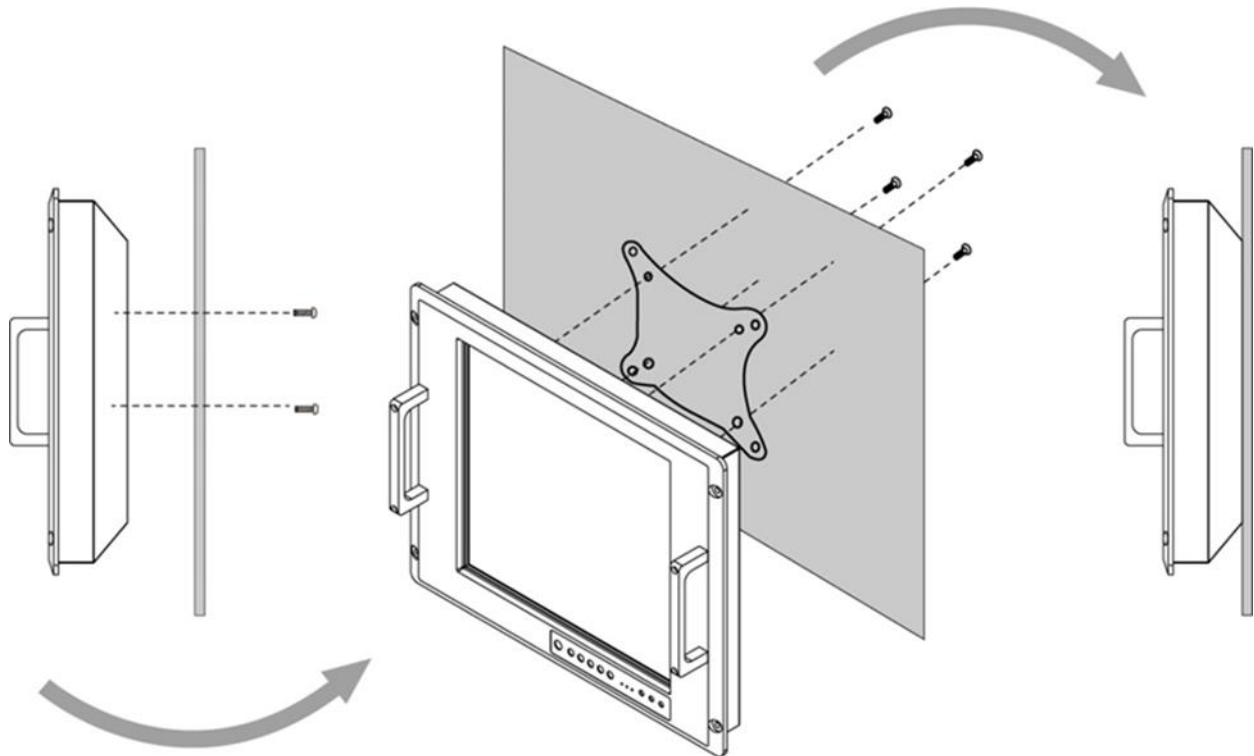

**Notice that VESA stand and mounting kit are not provided by Winmate.*

Size	VESA Plate	Screw Size
15"	100 x 100 mm	M6 VESA, D=6 mm (4 pcs)
24"	100 x 100 mm 100 x 200 mm	M6 VESA, D=6 mm (4 pcs)
27"	100 x 100 mm 100 x 200 mm	M6 VESA, D=6 mm (4 pcs)
32"	100 x 100 mm 100 x 200 mm 100 x 300 mm	M6 VESA, D=6 mm (4 pcs)
40"	100 x 200 mm 200 x 200 mm 200 x 400 mm	M6 VESA, D=6 mm (4 pcs)

2.3 Powering On

Follow the recommendations below when powering on the equipment.

- Plug-in the power cord to easy accessible AC outlet.
- Plug-in the AC adapter to a grounded outlet.



ALTERNATING CURRENT / MISE À LA TERRE !

This product must be grounded. Use only a grounded AC outlet. Install the additional PE ground wire if the local installation regulations require it.

**If you do not use a grounded outlet while using the device, you may notice an electrical tingling sensation when the palms of your hands touch the device.*

Ce produit doit être mis à la terre. Utiliser seulement un cordon d'alimentation avec mise à la terre. Si les règlements locaux le requiert, installer des câbles de mise à la terre supplémentaires.

**Si vous n'utilisez pas une prise d'alimentation avec mise à la terre, vous pourriez remarquer une sensation de picotement électrique quand la paume de vos mains touche à l'appareil.*

2.3.1 Connecting to AC Input Power Source (Default)

AC Power Input Requirements: AC 110~240V, Universal, $\pm 10\%$

Connect one end of the Military Grade power connector MIL-DTL-38999/1 to the Display (CN2), and plug the other end of the power connector (CN1) in to a working AC outlet.

Note: Power cords vary in appearance by region and country.

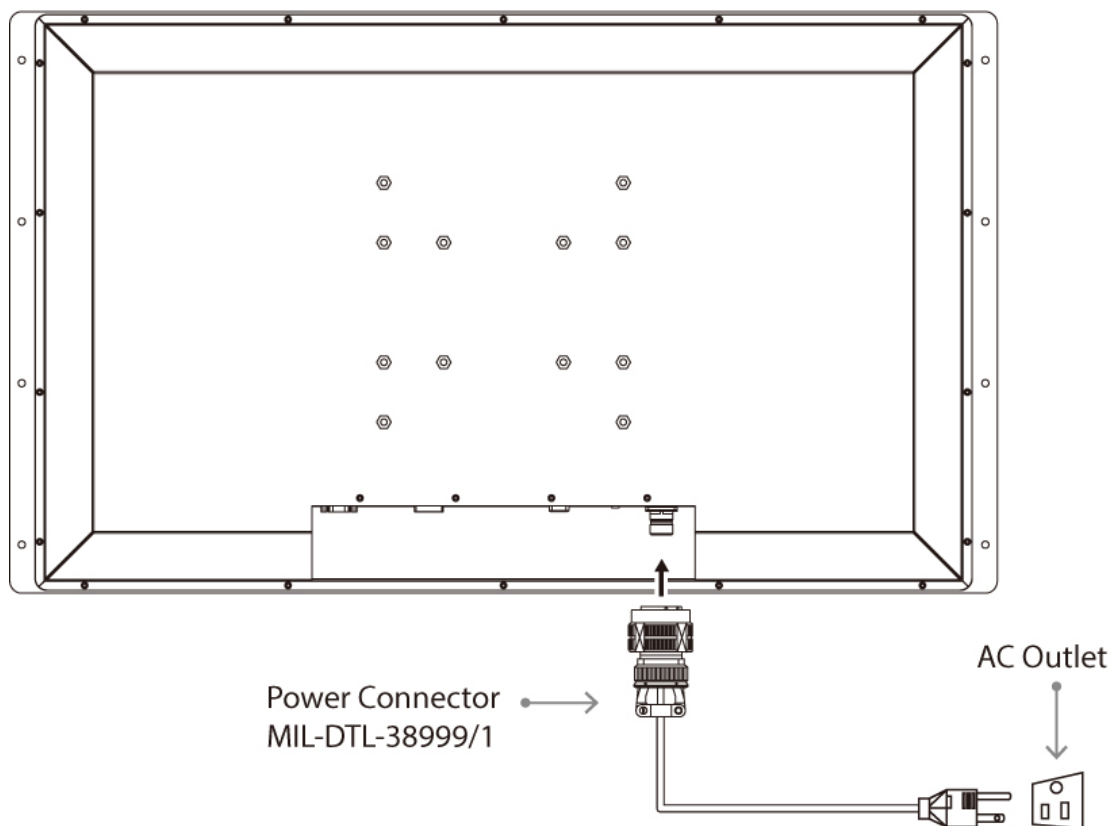

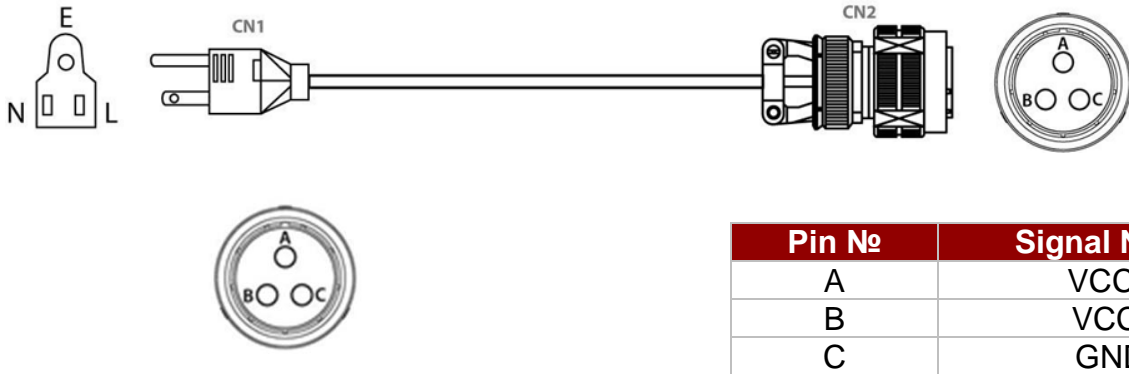
Connector Pinouts:**2.3.2 Connecting to DC Input Power Source (Optional)**

DC Power Input Requirements: 9~36V DC.

1. Insert the exposed wires of the DC Power Cable to the appropriate connectors on the terminal block plug.
2. Plug the terminal block plug firmly to the DC IN Jack.
3. Connect the other end of the DC power cable (wires with lug terminals that are labeled + and - to the terminals of the 9-36V DC Power Source). Ensure that the power connections maintain the proper polarity.

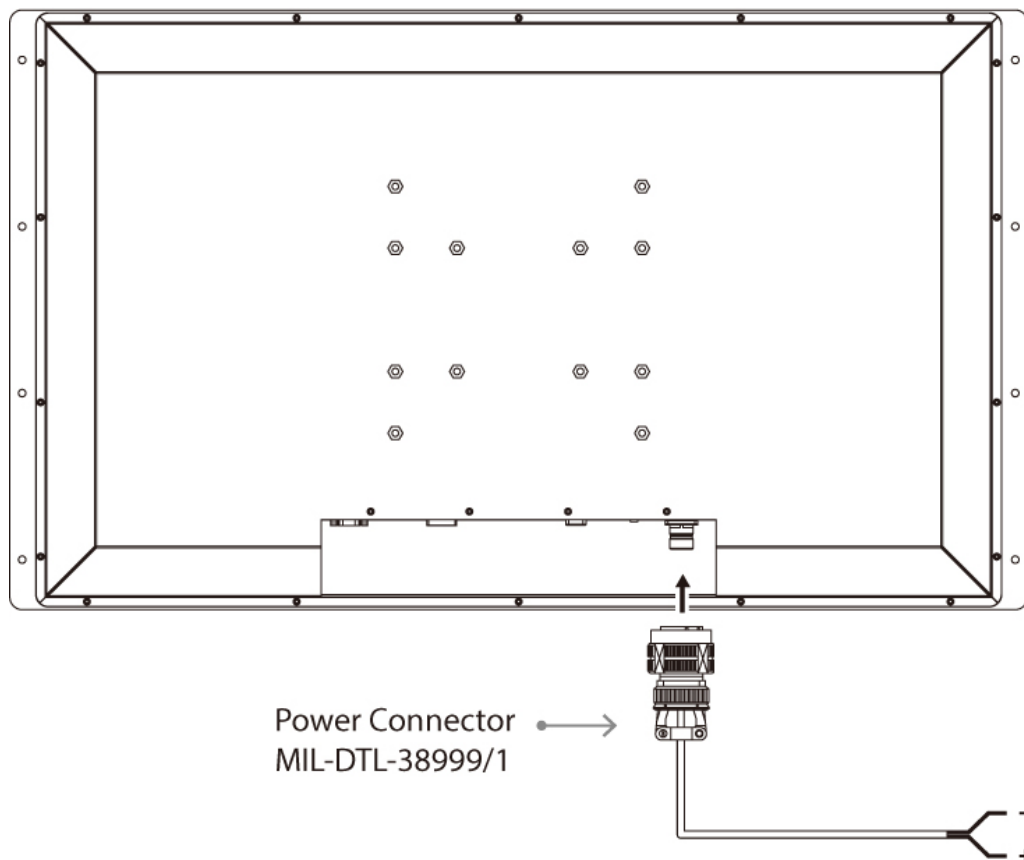
**Warning!/ Avertissement!**

Make sure that the polarization of the power lines is correct and complete including earth ground.

Assurez-vous que la polarisation des lignes électriques est correcte et complète, y compris la terre.

2.4 Connecting Other Devices

Use VGA, HDMI, DVI-D or Display Port cable to connect your display to external device. Connect USB cable for touch capabilities. Connect RS-232 cable for remote control.



Caution/ Attention

Observe all local installation requirements for connection cable type and protection level.

Suivre tous les règlements locaux d'installations, de câblage et niveaux de protection.



Warning!/ Avertissement!

Make sure the power is off when connecting and disconnecting the connectors.

Assurez-vous que l'alimentation est coupée lors de la connexion et la déconnexion des connecteurs.

2.4.1 VGA Connector

Plug one end of the 15-pin signal cable to the video signal connector at the rear of the PC system and the other end to the Display. Secure the connectors with the screws on the cable connector at both ends.



Note:

For the optimal results, select display native resolution as the external computer's input resolution.

Pin Assignments and Signal Names of VGA Connector

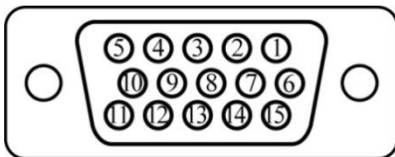

Pin №	Signal Name	Pin №	Signal Name
1	RED	2	GREEN
3	BLUE	4	ID2/RES
5	GND	6	RED_RTN
7	GREEN_RTN	8	BLUE_RTN
9	KEY/PWR	10	GND
11	ID0/RES	12	ID1/SDA
13	Hsync	14	Vsync
15	ID3/SCL		

2.4.2 HDMI Connector

Plug HDMI signal cable to the HDMI connector on the rear side of PC system, and plug the other end to the monitor.

Pin Assignment and Signal Names of HDMI1.4 Connector



Pin №	Signal Name	Pin №	Signal Name
1	HDMI_RX2+	2	GND
3	HDMI_RX2-	4	HDMI_RX1+
5	GND	6	HDMI_RX1-
7	HDMI_RX0+	8	GND
9	HDMI_RX0-	10	HDMI_RXC+
11	GND	12	HDMI_RXC-
13	HDMI_CON_CEC	14	NC
15	HDMI_CON_SCL	16	HDMI_CON_SDA
17	GND	18	+5V_HDMI
19	HDMI_CON_HP		

Pin Assignment and Signal Names of HDMI2.0 Connector



Pin №	Signal Name	Pin №	Signal Name
1	HDMI_RX2+	2	GND
3	HDMI_RX2-	4	HDMI_RX1+
5	GND	6	HDMI_RX1-
7	HDMI_RX0+	8	GND
9	HDMI_RX0-	10	HDMI_RXC+
11	GND	12	HDMI_RXC-
13	HDMI_CON_CEC	14	NC
15	HDMI_CON_SCL	16	HDMI_CON_SD A
17	GND	18	+5V_HDMI
19	HDMI_CON_HP		

2.4.3 DVI-D Connector

Plug one end of the DVI signal cable to the video signal connector (DVI-D digital only) at the rear of the PC system and the other end to the Display.

Pin Assignment and Signal Names of DVI-D Connector



Pin №	Signal Name	Pin №	Signal Name
1	DVI_RX2-	2	DVI_RX2+
3	GND	4	NC
5	NC	6	DVI_SCL
7	DVI_SDA	8	NC
9	DVI_RX1-	10	DVI_RX1+
11	GND	12	NC
13	NC	14	+5V
15	DVI_CON_CABLE	16	DVI_CON_HP
17	DVI_RX0-	18	DVI_RX0+
19	GND	20	NC
21	NC	22	GND
23	DVI_CLKP	24	DVI_CLKN
C1	NC	C2	NC
C3	NC	C4	NC
C5	NC		

2.4.4 Display Port Connector

Plug Display Port signal cable to the Display Port 1.2 connector on the rear side of PC system, and plug the other end to the monitor.

Pin Assignment and Signal Names of Display Port Connector

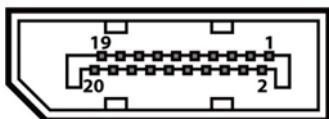

Pin №	Signal Name	Pin №	Signal Name
1	Lane 0+	2	GND
3	Lane 0-	4	Lane 1+
5	GND	6	Lane 1-
7	Lane 2+	8	GND
9	Lane 2-	10	Lane 3+
11	GND	12	Lane 3-
13	AUX_EN_N	14	GND
15	AUX+	16	GND
17	AUX-	18	Hot Plug
19	GND	20	+3.3V

2.4.5 Audio Connector

Pin Assignment and Signal Names of Audio Connector

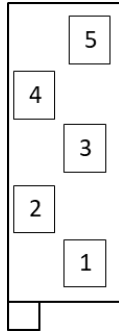

Pin No.	Signal name	Pin No.	Signal name
1	AGND	2	AUDIO_IN
3	NC	4	AUDIO_IN
5	NC		

2.4.6 Optional RS-232 Connector for Remote Control

Use RS-232 D-Sub 9pin terminal for remote control.

Pin Assignment and Signal Names of RS-232 D-Sub 9pin Connector

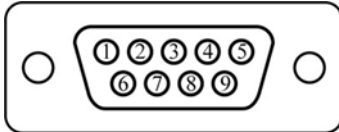

Pin №	Signal Name	Pin №	Signal Name
1	DCD	2	RXD
3	TXD	4	DTR
5	GND	6	DSR
7	RTS	8	CTS
9	RI		

2.4.7 Optional USB Connector for Touch

Use USB 2.0 connector for optional touch.

Pin Assignment and Signal Names of USB 2.0 Connector



Pin №	Signal Name	Pin №	Signal Name
1	+5V	2	Data-
3	Data+	4	GND

Chapter 3: Operating the Device

In this chapter you will find instructions on how to operate the display.

3.1 Navigating the OSD Menu

This section describes how to navigate the OSD Menu.

3.1.1 Display

The OSD offers a variety of monitor adjustment capabilities. Below is a description of a few common functions used.

Under SCHEME ADJUST, the HUE and Saturation of each primary and secondary color can be changed. These changes are stored under the SCHEME currently activated. (Found under the Quick Menu)

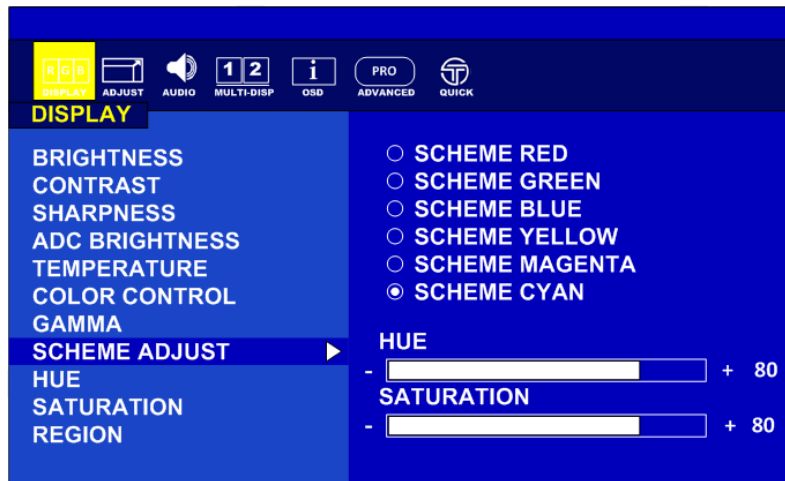

Under COLOR CONTROL, the RED, GREEN, and BLUE colors of the current image are changed. These adjustments DO NOT over write the setting of SCHEME or PROFILE.

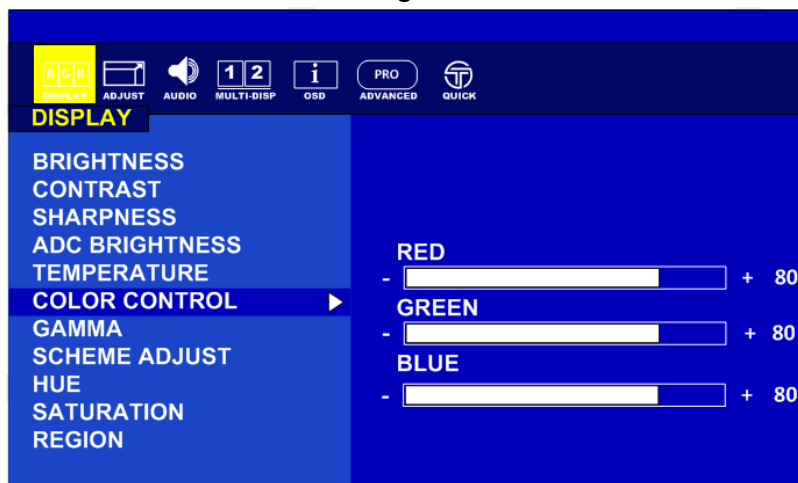

Region allows the user to select the “region(s)” / input(s) to adjust with a feature.

Example: Monitor has four inputs signals activated on a quad screen. There are nine (9) possible region combinations that can be adjusted. In the picture below, only quadrant “1” will receive adjustment.

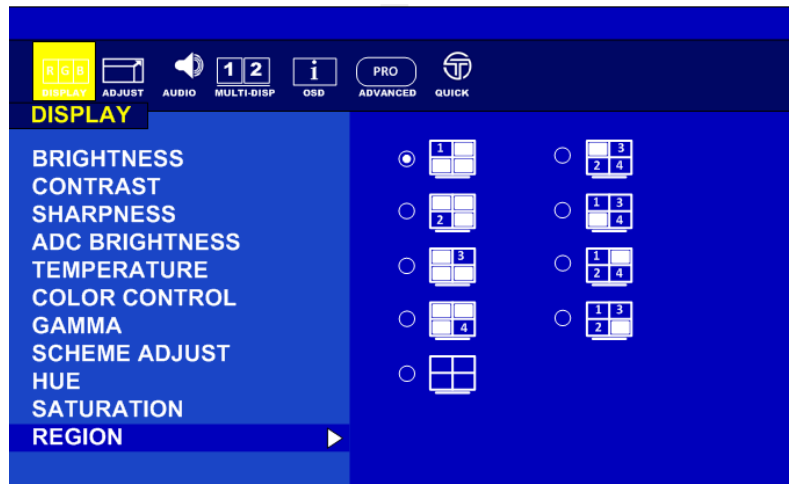

Function	Description
Brightness	Adjusts the overall image and background brightness Value: 0-100
Contrast	Adjusts the image contrast in relationship to the background Value: 0-100
Sharpness	Adjusts the crispness of the image Value: 0 to 4
ADC Brightness	Adjusts the Auto Display Control (ADC) brightness Value: 0-100
Temperature	Adjusts the color temperature of the entire screen. USER/5600/6500/7600/9300 <i>Note: low color temperature makes the screen reddish. High color temperature makes the screen bluish.</i>
Color Control	Adjusts the level of red, green, blue, yellow, magenta, and cyan colors RGB Slide Bar Value: 0-100
Gamma	Select a display gamma value for best picture quality. Native 1.8 / 2.0 / 2.2 / 2.4 / DICOM *DICOM can be calibrated by optional calibration software
Scheme Adjust	Select scheme for different default setting combination. Adjust the appearance of the Active Scheme
Hue	Adjust the level of hue Value: 0-100
Saturation	Adjust the level of saturation Value: 0-100
Region	Select the multi-source 1P 1/2P,2/2P ,1+2/2P 1/4P,2+3+4/4P 2/4P, 1+3+4/4P 3/4P, 1+2+4/4P 4/4P,1+2+3/4P,1+2+3+4/4P

3.1.2 Adjust

The ADJUST feature will automatically adjust an analog image.

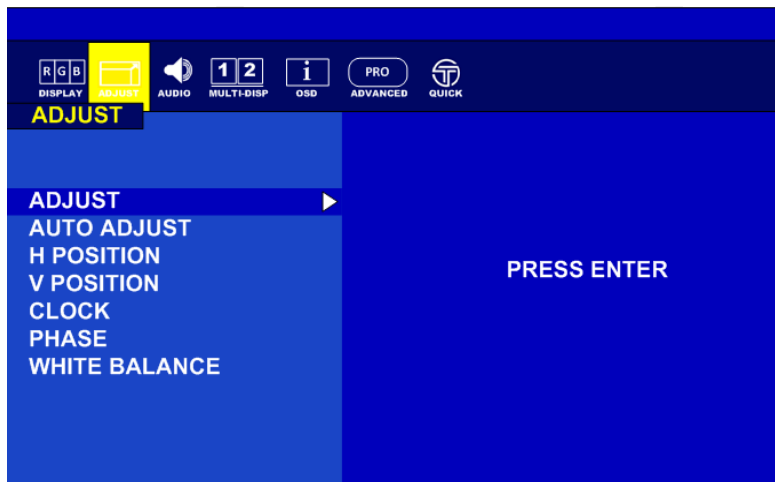

When an analog image is initially detected, the monitor will attempt to automatically adjust the image positioning. This automatic adjustment feature can be turned On/Off here.

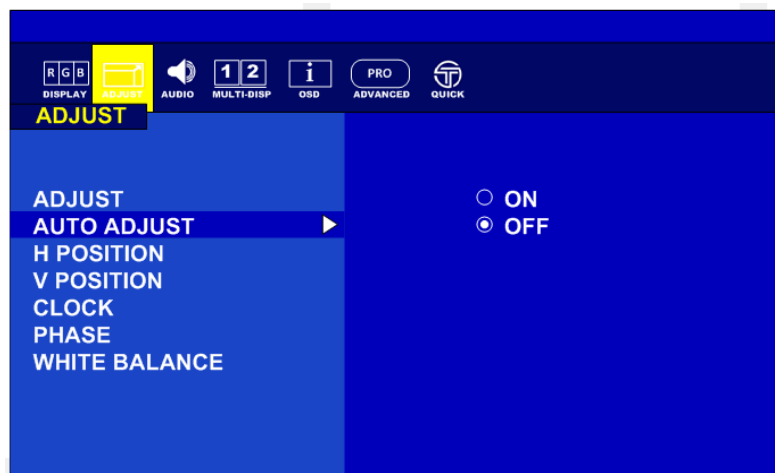

Adjust the white balance automatically here by selecting PRESS ENTER

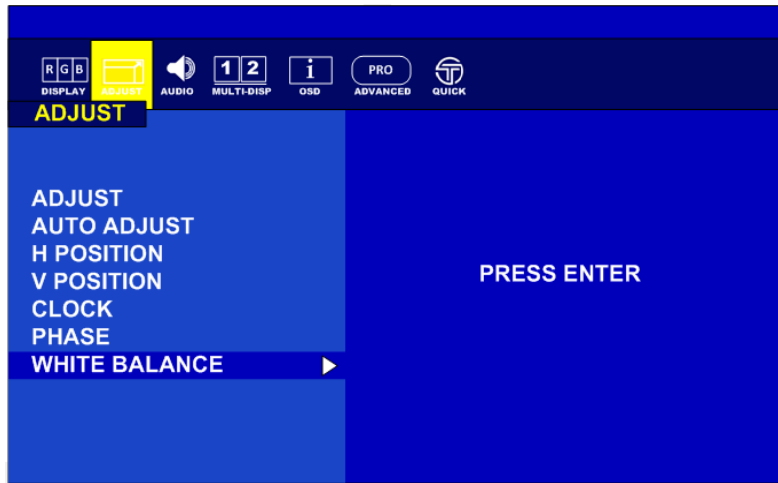

Function	Description
AUTO Adjust	Automatically adjusts screen size, H position, V position, Clock, Clock Phase when video source is changed
H Position	Controls the horizontal position of the image within the display area of the LCD. Value: 0-100
V Position	Controls the vertical position of the image within the display area of the LCD. Value: 0-100
Clock (Adjust H total)	+ Expand the width of the image on the right of the screen - Narrow the width of the image on the left of the screen Value: 0-100
Phase	Adjusts the image phase Value: 0-100
White Balance	Perform the white balance

3.1.3 Audio

The speaker volume for all audio inputs is controlled here.

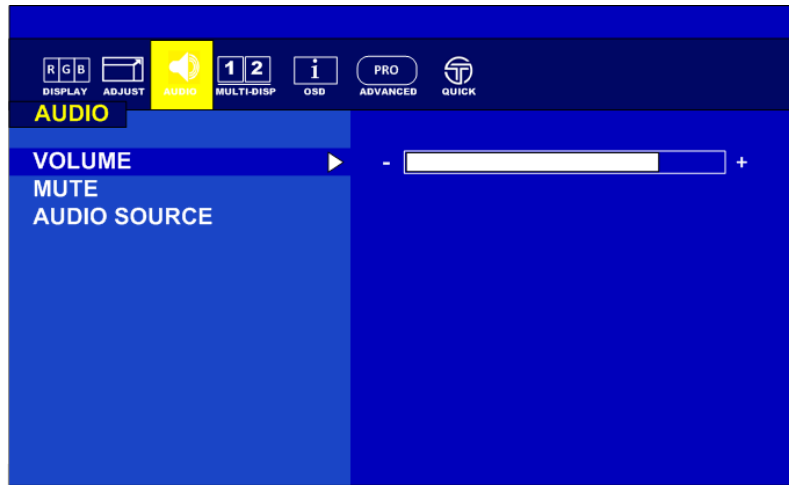

AUDIO SOURCE allows the user to select which from the available inputs. Example, there are 3 regions within the Quad display with audio.



Function	Description
Volume	Adjusts the level of volume - Decrease + Increase Value: 0-100
Mute	ON/OFF
Audio Source	Select the Audio Source Audio IN, Fiber, 1P, 2P, 3P, 4P

3.1.4 Multi-Display

Display mode offer the user up to five different layouts to view input images

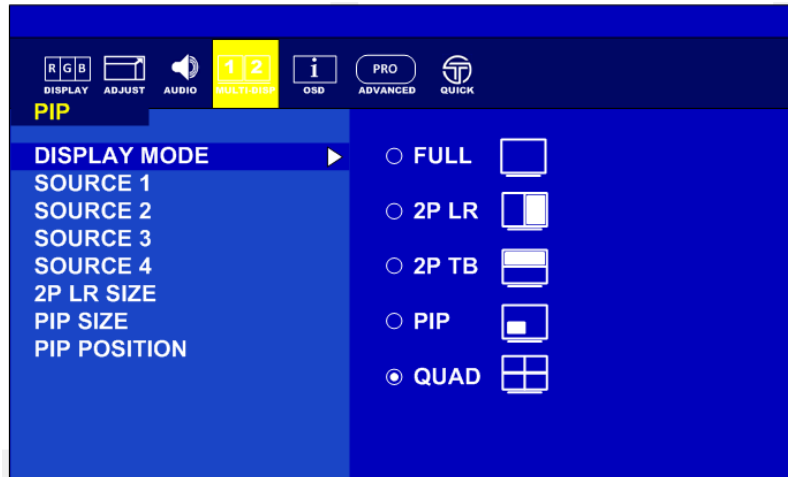

Under the PIP layout position and size of the inner image can be adjusted

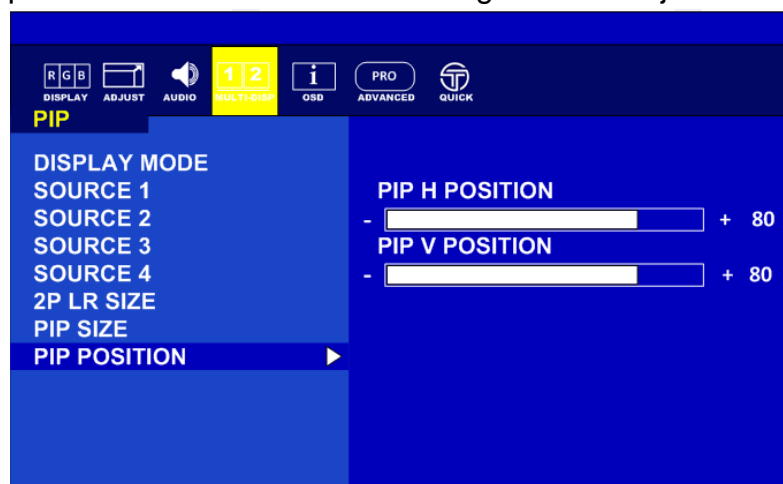

Function	Description
Display Mode	Choose the Display Mode Full, 2PLR, 2PTB, PIP or QUAD
Source 1	Choose the channel of display source Auto Scan/VGA/DVI/HDMI 2.0/HDMI 1.4/DP
Source 2	Choose the channel of display source Auto Scan/VGA/DVI/HDMI 2.0/HDMI 1.4/DP
Source 3	Choose the channel of display source Auto Scan/VGA/DVI/HDMI 2.0/HDMI 1.4/DP
Source 4	Choose the channel of display source Auto Scan/VGA/DVI/HDMI 2.0/HDMI 1.4/DP
2P LR Ratio	RATIO 0/1/2/3/4
PIP Size	Adjust picture-in-picture(PIP) size Value: 0-10
PIP Position-H	Adjust the horizontal position of PIP Value: 0-100
PIP Position-V	Adjust the Vertical position of PIP Value: 0-100

3.1.5 OSD

Selecting MONITOR INFO will display the current state of the monitor: PCB version, firmware version, serial number, and inputs.

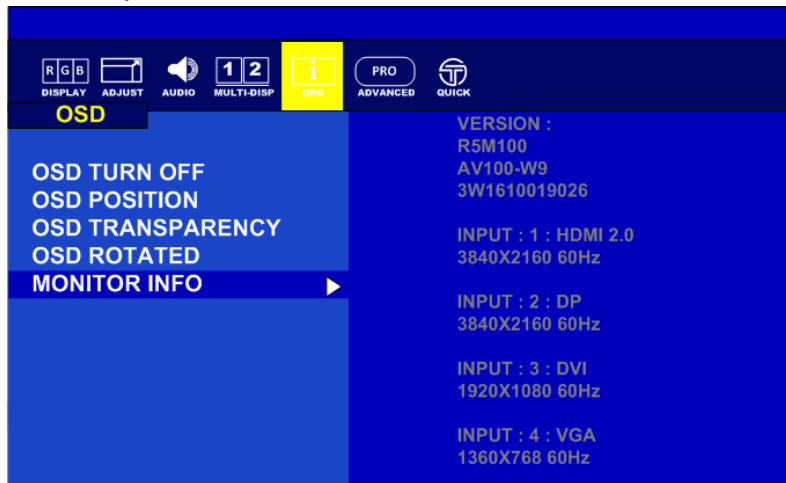

Function	Description
OSD Turn Off	Set the time of auto close OSD menu Value: 0-60 sec
OSD Position	Adjust the horizontal and vertical location where the OSD appears on the screen Value: 0-100
OSD Transparency	Adjust the transparency level of OSD Value: 0-255
OSD Rotated	Set to rotate the OSD menu 0°/90°/270°
Monitor Information	PCB Version Firmware version Serial number Current input Current resolution

3.1.6 Advanced

By selecting SCALING, the user can choose the perspective the image is displayed in.



The ability to control the monitor's functions by way of an infrared remote can be enabled/disabled here.

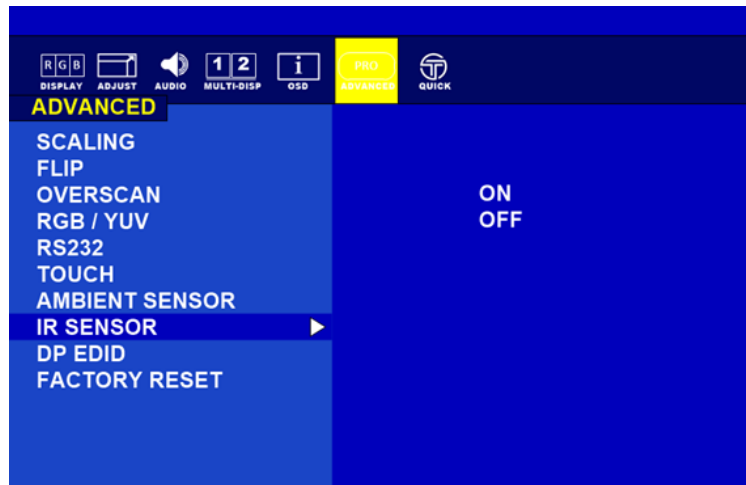

Function	Description
Scaling	Adjust the image scaling setting Full/16:10/16:9/4:3/5:4/1:1
Flip	Set the flip image mode Rotate 0 / Rotate 90 / Rotate 180 / Rotate 270 / LEFT/RIGHT /UP/DOWN
Overscan	Perform over scan function Under scan Over Scan
RGB/YUV	RGB/YUV Can Switch Between Color Spaces
RS232	Select the RS232 signal source: local COM or Fiber Local / Fiber
Touch	Select the Touch signal source: local COM or Fiber Local / Fiber
Ambient Sensor	On / off
IR Sensor	On / off
DP EDID	1080P/ 4K2K 30Hz/ 4K2K 60Hz
Factory Reset	Resets OSD options back to factory settings. Yes/No

3.2 Frequency Table

Signal name	Vertical Frequency (Hz)	DVI	VGA	DP1.2	HDMI 1.4	HDMI 2.0
640 x 480	60	✓	✓	✓	✓	✓
	72	✓	✓	✓	✓	✓
	75	✓	✓	✓	✓	✓
480P	60	✓	✓	✓	✓	✓
	72	✓	✓	✓	✓	✓
	75	✓	✓	✓	✓	✓
800 x 600	60	✓	✓	✓	✓	✓
	72	✓	✓	✓	✓	✓
	75	✓	✓	✓	✓	✓
1024 x 768	60	✓	✓	✓	✓	✓
	72	✓	✓	✓	✓	✓
	75	✓	✓	✓	✓	✓
720P	60	✓	✓	✓	✓	✓
	72	✓	✓	✓	✓	✓
	75	✓	✓	✓	✓	✓
1280 x 1024	60	✓	✓	✓	✓	✓
	72	✓	✓	✓	✓	✓
	75	✓	✓	✓	✓	✓
1600 x 1200	60	✓	✓	✓	✓	✓
	72	✓	✓	✓	✓	✓
	75	✓	✓	✓	✓	✓
1920 x 1080	60	✓	✓	✓	✓	✓
	72	✓	✓	✓	✓	✓
	75	✓	✓	✓	✓	✓
1920 x 1200	60	✓	✓	✓	✓	✓
2560 x 1440	60	✓		✓	✓	✓
3840 x 2160	30	✓		✓	✓	✓
	60			✓		✓
4096 x 2160	60			✓		✓

Appendix

This chapter contains additional product information, including troubleshooting guide and frequency table



Appendix A: Technical Specifications

This section includes product technical specifications.

	Model No.			
	W15L100-MLB3FP	W24L100-MLL1FP	W27L100-MLA3FG	W27L100-MLA3FP
Display				
Size	15.6"	23.8"	27"	27"
Resolution	3840 x 2160	3840 x 2160	3840 x 2160	3840 x 2160
Active Display Area, mm	344.21"(H) x 193.76"(V)	531.36"(H) x 298.89"(V)	596.16"(H) x 335.54"(V)	596.16"(H) x 335.54"(V)
Pixel Pitch, mm	0.155 (H) x 0.155 (V)	0.155 (H) x 0.155 (V)	0.155 (H) x 0.155 (V)	0.155 (H) x 0.155 (V)
Contrast Ratio	1400:1 (typ.)	1000:1 (typ.)	1000:1 (typ.)	1000:1 (typ.)
Display Color	1.07B	1.07B	1.07B	1.07B
Light Intensity	300 cd/m2 (typ.), Optional for high brightness 700cd/m2 (typ.)	300 cd/m2 (typ.), Optional for high brightness 700cd/m2 (typ.)	300 cd/m2 (typ.), Optional for high brightness 700cd/m2 (typ.)	300 cd/m2 (typ.), Optional for high brightness 700cd/m2 (typ.)
Viewing Angle	89/89/89/89	89/89/89/89	89/89/89/89	89/89/89/89
Aspect Ratio	16:9	16:9	16:9	16:9
Response Time	12ms (Gray to Gray)	12ms (Gray to Gray)	12ms (Gray to Gray)	12ms (Gray to Gray)
Synchronization Signal Autodetect	Digital Separate, Composite, On Green	Digital Separate, Composite, On Green	Digital Separate, Composite, On Green	Digital Separate, Composite, On Green
Synchronization Range	31.5 kHz to 60.0 kHz (H) - 30 Hz to 75 Hz (V)	31.5 kHz to 60.0 kHz (H) - 30 Hz to 75 Hz (V)	31.5 kHz to 60.0 kHz (H) - 30 Hz to 75 Hz (V)	31.5 kHz to 60.0 kHz (H) - 30 Hz to 75 Hz (V)
Optimal Resolution and Hz	3840 x 2160 @ 60 Hz 4:4:4	3840 x 2160 @ 60 Hz 4:4:4	3840 x 2160 @ 60 Hz 4:4:4	3840 x 2160 @ 60 Hz 4:4:4
Detectable Resolutions (Partial List)	640 x 480, 720 x 400, 800 x 600, 1024 x 768, 1280 x 1024, 1600 x 1200, 1920 x 1080, 1920 x 1200, 2560 x 1440, 3840 x 2160, 4096 x 2160	640 x 480, 720 x 400, 800 x 600, 1024 x 768, 1280 x 1024, 1600 x 1200, 1920 x 1080, 1920 x 1200, 2560 x 1440, 3840 x 2160, 4096 x 2160	640 x 480, 720 x 400, 800 x 600, 1024 x 768, 1280 x 1024, 1600 x 1200, 1920 x 1080, 1920 x 1200, 2560 x 1440, 3840 x 2160, 4096 x 2160	640 x 480, 720 x 400, 800 x 600, 1024 x 768, 1280 x 1024, 1600 x 1200, 1920 x 1080, 1920 x 1200, 2560 x 1440, 3840 x 2160, 4096 x 2160
Touch	AR Protection Glass, No Touch function	Projected Capacitive Multi Touch	AR Protection Glass, No Touch function	Projected Capacitive Multi Touch
User Controls and Activity				
Front OSD Panel	Power, Brightness Down/Up, Auto Adjustment, Main Menu, Day/Night Mode, Key Pad Control	Power ON/OFF, Menu Brightness Control	Power, Brightness Down/Up, Auto Adjustment, Main Menu, Day/Night Mode, Key Pad Control	Power ON/OFF, Menu Brightness Control
Mechanical Specifications				
Dimensions, mm	404.0 x 290.0 x 67.0	675.6 x 417 x 68.6	697.2 x 442 x 73.8	697.2 x 442 x 73.8
Cutout, mm	374.0 x 272.0	584.7 x 383	649.5 x 399.7	649.5 x 399.7
Mounting	Panel Mount, VESA 100 x 100	Panel Mount, VESA 100 x 100, 200 x 100	Panel Mount, VESA 100 x 100, 200 x 100	Panel Mount, VESA 100 x 100, 200 x 100

Power Specifications				
Power Input	AC 110~240V (Default), DC 24V (Optional), MIL-DTL-38999/1 Connector	AC 110~240V (Default), DC 24V (Optional), MIL-DTL-38999/1 Connector	AC 110~240V (Default), DC 24V (Optional), MIL-DTL-38999/1 Connector	AC 110~240V (Default), DC 24V (Optional), MIL-DTL-38999/1 Connector
Power Consumption	50W (Typ.)	50W (Typ.)	50W (Typ.)	50W (Typ.)
Input/ Output:				
Signal Connectors	HDMI 2.0 HDMI 1.4 VGA DVI-D Display Port 1.2 Audio Line In RS232 for Optional Remote Control USB for Optional Touch	HDMI 2.0 HDMI 1.4 VGA DVI-D Display Port 1.2 Audio Line In RS232 for Optional Remote Control USB for Optional Touch	HDMI 2.0 HDMI 1.4 VGA DVI-D Display Port 1.2 Audio Line In RS232 for Optional Remote Control USB for Optional Touch	HDMI 2.0 HDMI 1.4 VGA DVI-D Display Port 1.2 Audio Line In RS232 for Optional Remote Control USB for Optional Touch
Environmental Considerations:				
Operating Temperature	0°C to 50°C	0°C to 50°C	0°C to 50°C	0°C to 50°C
Storage Temperature	-25°C to 60°C	-25°C to 60°C	-25°C to 60°C	-25°C to 60°C
Operating Humidity	95%RH ±3%	95%RH ±3%	95%RH ±3%	95%RH ±3%
Order Information				
Touch	P-Cap Multi-Touch (Optional), EMI ITO Glass (Optional)	P-Cap Multi-Touch (Optional), EMI ITO Glass (Optional)	P-Cap Multi-Touch (Optional), EMI ITO Glass (Optional)	P-Cap Multi-Touch (Optional), EMI ITO Glass (Optional)
Power Source	DC 24V, ±10% (Optional)	DC 24V, ±10% (Optional)	DC 24V, ±10% (Optional)	DC 24V, ±10% (Optional)
Standards and Certifications				
EMI	CE, FCC Class B	CE, FCC Class B	CE, FCC Class B	CE, FCC Class B
Military	Compliance with MIL-STD 810F/G and MIL-STD-461F/G(RE101/RE102),(CE101/CE102)	Compliance with MIL-STD 810F/G and MIL-STD-461F/G(RE101/RE10),(CE101/CE102)	Compliance with MIL-STD 810F/G and MIL-STD-461F/G(RE101/RE102),(CE101/CE102)	Compliance with MIL-STD 810F/G and MIL-STD-461F/G(RE101/RE10),(CE101/CE102)

NOTE:

- Accessories and Integrated Options may vary depending on your configuration. The product shown in this datasheet is a standard model. For diagrams that contain customized or optional I/O, please contact the Winmate Sales Team for more information.
- All specifications are subject to change without prior notice.

	Model No.		
	W32L100-MLA1FP	W32L100-MLA3FP	W40L100-MLM1FG
Display			
Size	32"	32"	40"
Resolution	3840 x 2160	3840 x 2160	3840 x 2160
Active Display Area, mm	708.48"(H) x 398.52"(V)	596.16"(H) x 335.54"(V)	878.1 (H) x 485.3 (V)
Pixel Pitch, mm	0.181 (H) x 0.181(V)	0.181 (H) x 0.181(V)	0.0762 (H) x 0.2247 (V)
Contrast Ratio	1000:1 (typ.)	1000:1 (typ.)	5000:1 (typ.)
Display Color	1.07B	1.07B	1.07B
Light Intensity	350 cd/m2 (typ.), Optional for high brightness 700cd/m2 (typ.)	350 cd/m2 (typ.), Optional for high brightness 700cd/m2 (typ.)	350 cd/m2 (typ.),
Viewing Angle	89/89/89/89	89/89/89/89	89/89/89/89
Aspect Ratio	16:9	16:9	16:9
Response Time	12ms (Gray to Gray)	12ms (Gray to Gray)	12ms (Gray to Gray)
Synchronization Signal Autodetect	Digital Separate, Composite, On Green	Digital Separate, Composite, On Green	Digital Separate, Composite, On Green
Synchronization Range	31.5 kHz to 60.0 kHz (H) - 30 Hz to 75 Hz (V)	31.5 kHz to 60.0 kHz (H) - 30 Hz to 75 Hz (V)	31.5 kHz to 60.0 kHz (H) - 30 Hz to 75 Hz (V)
Optimal Resolution and Hz	3840 x 2160 @ 60 Hz 4:4:4	3840 x 2160 @ 60 Hz 4:4:4	3840 x 2160 @ 60 Hz 4:4:4
Detectable Resolutions (Partial List)	640 x 480, 720 x 400, 800 x 600, 1024 x 768, 1280 x 1024, 1600 x 1200, 1920 x 1080, 1920 x 1200, 2560 x 1440, 3840 x 2160, 4096 x 2160	640 x 480, 720 x 400, 800 x 600, 1024 x 768, 1280 x 1024, 1600 x 1200, 1920 x 1080, 1920 x 1200, 2560 x 1440, 3840 x 2160, 4096 x 2160	640 x 480, 720 x 400, 800 x 600, 1024 x 768, 1280 x 1024, 1600 x 1200, 1920 x 1080, 1920 x 1200, 2560 x 1440, 3840 x 2160, 4096 x 2160
Touch	AR Protection Glass, No Touch function	Projected Capacitive Multi Touch	AR Protection Glass, No Touch function,
User Controls and Activity			
Front OSD Panel	Power, Brightness Down/Up, Auto Adjustment, Main Menu, Day/Night Mode, Key Pad Control	Power ON/OFF, Menu Brightness Control	Menu / Auto-adjust / Bright
Mechanical Specifications			
Dimensions, mm	825 x 486 x 88.5	825 x 486 x 88.5	958.2 x 580.4 x 88.5
Cutout, mm	769.5 x 468	769.5 x 468	924.3 x 564
Mounting	Panel Mount, VESA 100 x 100, 200 x 100, 300 x 100	Panel Mount, VESA 100 x 100, 200 x 100, 300 x 100	Panel Mount, VESA 100 x 200, 200 x 200, 200 x 400
Power Specifications			
Power Input	AC 110~240V (Default), DC 24V (Optional), MIL-DTL-38999/1 Connector	AC 110~240V (Default), DC 24V (Optional), MIL-DTL-38999/1 Connector	AC 110~240V (Default), DC 24V (Optional), MIL-DTL-38999/1 Connector
Power Consumption	60W (Typ.)	60W (Typ.)	70W (Typ.)
Input/ Output:			

Signal Connectors	HDMI 2.0 HDMI 1.4 VGA DVI-D Display Port 1.2 Audio Line In RS232 for Optional Remote Control USB for Optional Touch	HDMI 2.0 HDMI 1.4 VGA DVI-D Display Port 1.2 Audio Line In RS232 for Optional Remote Control USB for Optional Touch	HDMI 2.0 HDMI 1.4 VGA DVI-D Display Port 1.2 Audio Line In RS232 for Optional Remote Control
Environmental Considerations:			
Operating Temperature	0°C to 50°C	0°C to 50°C	0°C to 50°C
Storage Temperature	-25°C to 60°C	-25°C to 60°C	-25°C to 60°C
Operating Humidity	95%RH ±3%	95%RH ±3%	95%RH ±3%
Order Information			
Touch	P-Cap Multi-Touch (Optional), EMI ITO Glass (Optional)	P-Cap Multi-Touch (Optional), EMI ITO Glass (Optional)	P-Cap Multi-Touch (Optional), EMI ITO Glass (Optional)
Power Source	DC 24V, ±10% (Optional)	DC 24V, ±10% (Optional)	DC 9~36V, ±10% (Optional)
Standards and Certifications			
EMI	CE, FCC Class B	CE, FCC Class B	CE, FCC Class B
Military	Compliance with MIL-STD 810F/G and MIL-STD- 461F/G(RE101/RE102), (CE101/CE102)	Compliance with MIL-STD 810F/G and MIL-STD- 461F/G(RE101/RE10, (CE101/CE102)	Compliance with MIL- STD 810F/G and MIL- STD- 461F/G(RE101/RE10, (CE101/CE102)

NOTE:

- Accessories and Integrated Options may vary depending on your configuration. The product shown in this datasheet is a standard model. For diagrams that contain customized or optional I/O, please contact the Winmate Sales Team for more information.
- All specifications are subject to change without prior notice.

Appendix B: Military Grade Compliance

This section includes description of military grade compliance.

Military Grade EMC Compliance

EMC (MIL-STD 461E/F Compliance)			
EMC Test Spec	Type of Test	Frequency Range	Requirement
CE101	Conducted Emissions	30Hz ~10kHz	30Hz ~ 1kHz :110 dB 1k-10k:110-90 dB
CE102	Conducted Emissions	30Hz ~10kHz	10kHz ~ 500KHz: 100-66dB, 500KHz~10MHz:66dB
RE101	Radiated Emissions	30Hz ~100kHz	30~100k :180-110 dBpT
RE102	Radiated Emissions	10kHz ~-18GHz	2MHz~18G Hz: 44-89 dB

Military Grade Environmental Compliance

Environmental (MIL-STD 810F/G Compliance)		
Low Pressure	Operating	15,000 ft, Method 500.5 / Procedure II
	Storage	15,000 ft, Method 500.5 / Procedure I
Salt Fog	Method 509.5	
Vibration	5 ~ 500 Hz, 1.48 & 1.90 & 2.24 Grms Method 514.6 / Procedure I	
Transit Drop	Method 516.6 / Procedure IV	
Shock	Method 516.6 / Procedure I	

Appendix C: Maintenance

This equipment is extremely rugged and does not require a lot of maintenance. Remember that electrical equipment should be handled with care and used accordingly to its specifications.

Cleaning the Display Screen

- Wipe the screen with a clean, soft, lint-free cloth. This removes dust and other particles. Do not use acetone, ethyl alcohol, toluene, ethyl acid or methyl chloride to clear the panel. It may permanently damage the display screen.
- You can apply a small amount of non-ammonia; non-alcohol based glass cleaner onto a clean, soft, lint-free cloth and wipe the screen.
- Never spray or pour any liquid directly on the screen or case.
- **Do Not** use water or oil directly on the display screen. If droplets are allowed to drop on the screen, permanent staining or discoloration may occur.

Cleaning the Casing

Use the following procedure to clean the equipment.



Caution/ Attention

Always turn off the device and disconnect other peripherals before cleaning and maintenance procedures.

Toujours éteindre l'appareil et débrancher tous les périphériques avant que les procédures de nettoyage et d'entretien.

Before Cleaning:

- Make sure the device is turned off.
- Disconnect the power cable from any AC outlet.

When Cleaning:

- Wipe dust off the outside casing with a cloth slightly moistened with water or mild ammonia-based cleaning solution. Do not use this cloth on a display screen!
- Do not use an abrasive cleaner or high pressure washer on the screen.
- Do not rub the unit with a dry cloth. This action can result in a static charge being built up and cause a spark. Always use damp cloth while cleaning the unit.



Warning!/ Avertissement!

POTENTIAL ELECTROSTATIC CHARGE HAZARD – SEE INSTRUCTIONS
POTENTIEL ÉLECTROSTATIQUE CHARGE DANGER - VOIR INSTRUCTIONS



Winmate Inc.
9F, No.111-6, Shing-De Rd., San-Chung District,
New Taipei City 24158, Taiwan, R.O.C
www.winmate.com

Copyright © Winmate Inc. All rights reserved.

