

P400M9

4" ARM A73 + A53 Rugged Handheld Computer



KEY FEATURES

- Compatible PoC application
- Cortex-A73 + Cortex-A53 (Octa-core up to 2.0 GHz)
- 4" 800 x 480 Panel with direct optical bonding
- Supports Android 11 Rugged Handheld Computer



SPECIFICATIONS

Display			
Bonding	Optical Bonding for Sunlight Viewability	Resolution	480x800
Size	4 inches	Contrast Ratio	800:1
Panel Brightness	550 nits	View Angles	80,80,80,80
Type	Projected Capacitive Multi Touch		
System Specification			
Processor	ARM A73 x 4 (2.0 GHz) + A53 x 4 (2.0 GHz)	Memory	4GB
Storage	64GB	Operating System	Android 11.0
WLAN	Support	BT	Support
WWAN	4G/LTE (Optional)	GNSS	GPS/AGPS
RFID	NFC (Read / Write, Peer to Peer mode) (Optional)	Sensors	Ambient Light Sensor, E-Compass, Gyro, Acceleration Sensors
Camera			
Front Camera	8MP Camera	Rear Camera	13MP Camera with LED Auxiliary Light (Auto Focus)
Mechanical			
Dimension	156.56 x 75 x 26 mm	Weight	310g
IO Ports			
USB Port	1 x USB Type C OTG (support charging)	SD Card Slot	1 x Micro SD Card Slot
SIM Card Slot	1 x Micro SIM Card Slot	Audio	1 x Kenwood Audio Combo connector (Mic in or Line Out) 1 x Built-in Mic 1 x Speaker
Indicator	1 x LED Indicators (Power, Battery)	Docking Connector	1 x Docking Connector
Environment			
Operating Humidity	5% to 95% RH, Non-Condensing	Operating Temperature	-10°C to 50°C (Battery mode)
Storage Temperature	-30°C to 70°C	Shock	MIL-STD-810G Method 516.6 Procedure I
Vibration	MIL-STD-810G Method 514.6 Procedure I	IP rating	IP65
Drop	MIL-STD-810G Method 516.6, 4 ft		

Certification			
Certification	CE, FCC		
Control			
Button	1 x Power Button, 3 x Function Button, 1 x PTT Button, 1 x SOS Button		
Power			
Battery	7.6V 2700mAh	Battery Operating Time	8Hr
Power Rating	12V	Adapter	12V PD Adapter with USB TypeC
Security Function			
SOTI MobiControl	SOTI MobiControl Compliance		
Accessory			
Accessory	Universal Adapter Battery	Optional Accessory	USB Type-C Cable Micro SD Card Battery Charging Dock 2 bay Battery Charging Dock 6 bay

DIMENSIONS UNIT:MM

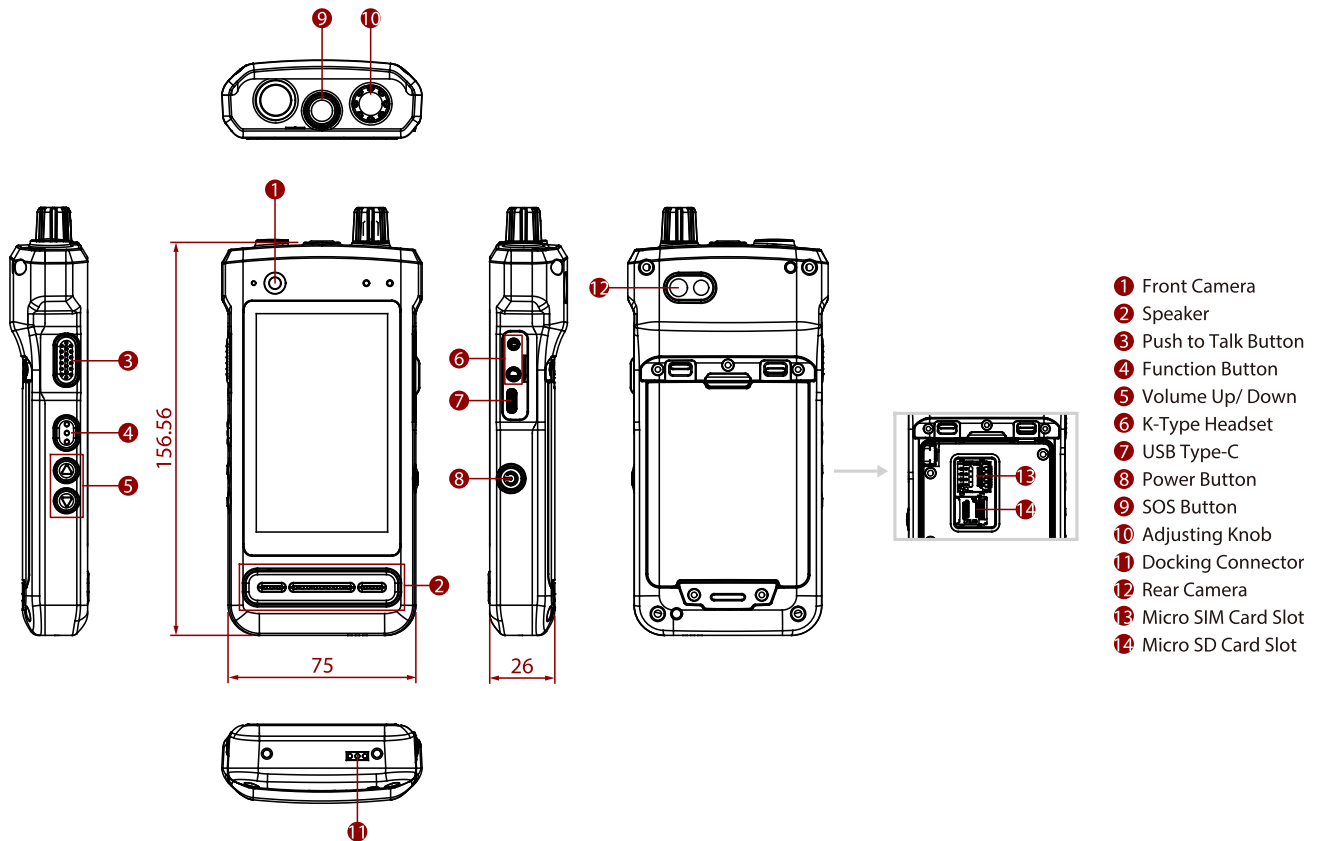

NOTE

1. This is a simplified drawing and some components are not marked in detail.
2. Please contact our sales representative if you need further product information.
3. All specifications are subject to change without prior notice.
4. The product shown in this datasheet is a standard model. For diagrams that contain customized or optional I/O, please contact the Winmate Sales Team for more information.