

DT122-GH

Ryzen



FC CE

Features

- AMD Ryzen V1000/R1000 Desktop Box PC
- 2 DDR4 SODIMM up to 64GB
- 4 DP++ resolution up to 4096x2160 @ 60Hz
- 1x 3.5" or 2x 2.5" SATA drive bay
- Supports 1 expansion slot: 1 PCIe or 1 PCI
- Built in 150W psu



Panel

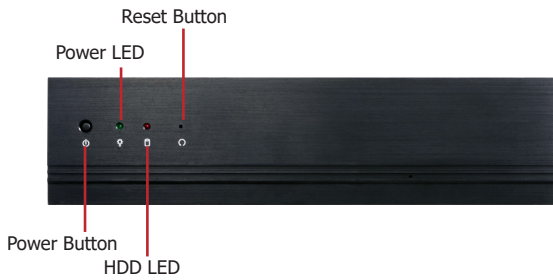

Front View

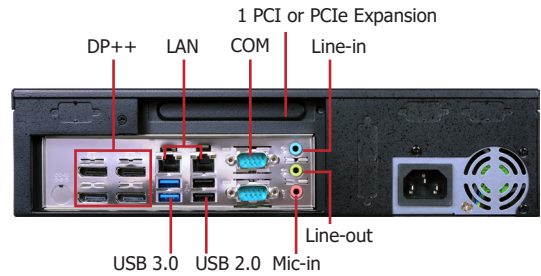

Rear View

Dimensions

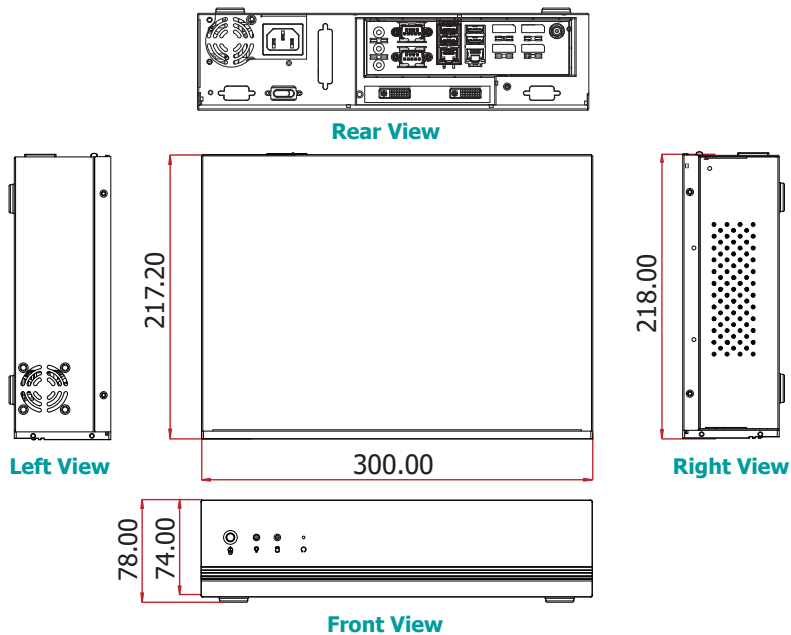

► Specifications

SYSTEM	Processor	AMD® Ryzen™ Embedded V1000 series AMD® Ryzen™ Embedded V1807, Quad Core, 2M Cache, 11 CU, 3.35GHz (3.8GHz), 35-54W AMD® Ryzen™ Embedded V1756, Quad Core, 2M Cache, 8 CU, 3.25GHz (3.6GHz), 35-54W AMD® Ryzen™ Embedded V1605, Quad Core, 2M Cache, 8 CU, 2.0GHz (3.6GHz), 12-25W AMD® Ryzen™ Embedded V1202, Dual Core, 1M Cache, 3 CU, 2.3GHz (3.2GHz), 12-25W AMD® Ryzen™ Embedded R1000 series
	Memory	Two 260-pin SODIMM up to 32GB Dual Channel DDR4 3200MHz
	BIOS	AMI BIOS
	GRAPHICS	Controller
GRAPHICS	Feature	OpenGL 4.5, DirectX 12, OpenCL 2.1 HW Decode: AVC/H.264, MPEG2, VC1/WMV9, JPEG/MJPEG, HEVC/H265, VP8, VP9 HW Encode: MPEG2, AVC/H264, JPEG, HEVC/H265, VP8, VP9
	Display	4 x DP++ (V1000) DP: resolution up to 4096x2160 @ 60Hz 3 x DP++ (R1000)
	Four Displays	DP++ (R1000 supports triple displays)
	STORAGE	1 x 3.5" or 2 x 2.5" SATA 3.0 Drive Bay 1 x M.2 2280 NVME SSD (2280 PCIe x4), (x2 signal with R1000)
EXPANSION	Interface	1 x PCIe or 1 x PCI (through optional riser card)
AUDIO	Audio Codec	Realtek Audio Codec with 5.1 Channel Support
ETHERNET	Controller	2 x Realtek Ethernet LAN Controller
LED	Indicators	1 x Power LED 1 x HDD LED
FRONT I/O	Buttons	1 x Power Button
REAR I/O	Ethernet	2 x GbE (RJ-45)
	Serial	1 x RS-232/422/485 (DB-9) 1 x RS-232 (DB-9)
	USB	2 x USB 3.0 2 x USB 2.0
	Display	4 x DP++ (V1000), or 3 x DP++ (R1000)
	Audio	1 x Line-in 1 x Line-out 1 x Mic-in
COOLING	Fan	1 x System Fan 1 x CPU Fan
WATCHDOG TIMER	Output & Interval	System Reset, Programmable via Software from 1 to 255 Seconds
POWER	Supply	AC150W, ATX, 100 to 240V AC input
OS SUPPORT		Windows 10 Linux
MECHANISM	Construction	Front Bezel aluminum + Chassis Sheet Metal
	Mounting	Wall mount
	Dimensions (W x H x D)	300mm x 75mm x 217mm
	Weight	3.7 Kg
ENVIRONMENT	Operating Temperature	0 to 45°C
	Storage Temperature	-40 to 85°C
	Relative Humidity	10 to 90% RH (non-condensing)
STANDARDS AND CERTIFICATIONS	Certification	CE, FCC Class A

Wall Mounting

Type A Wall mount bracket

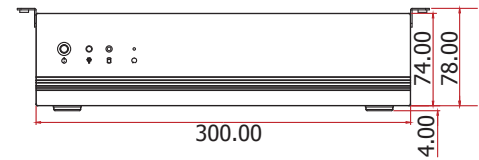
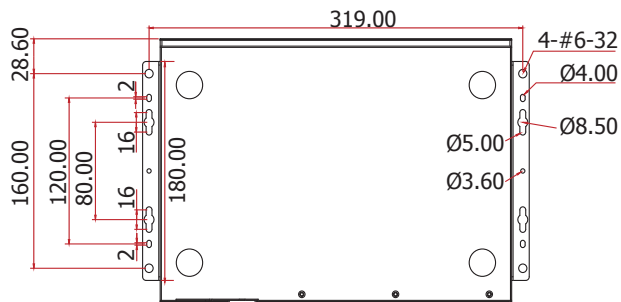
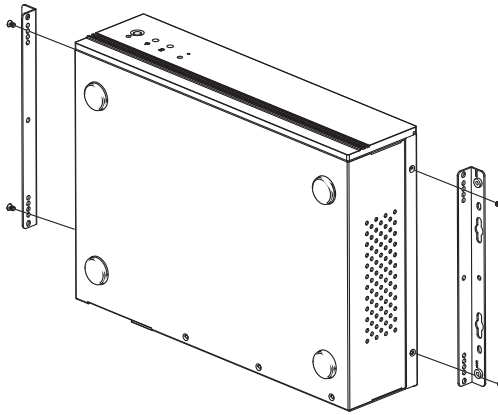

Type B Wall mount bracket

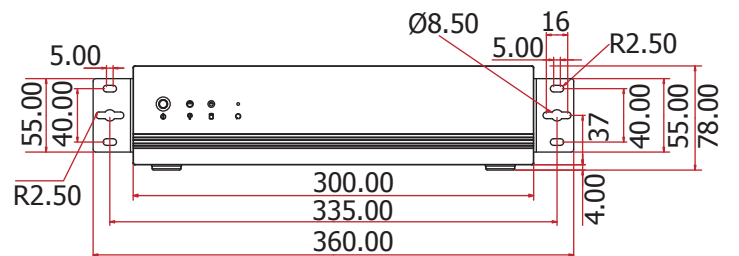
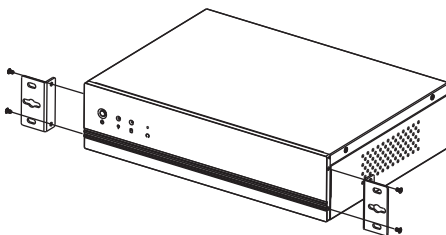

► **Ordering Information**

Model Name	Part Number	Description
DT122-GH	750-DT1222-000G	DT122-GH: GH171-V1807B, 150W, F/G SYSTEM, RoHS
DT122-GH	750-DT1222-100G	DT122-GH: GH171-V1807B, 150W, PCIe Riser, F/G SYSTEM, RoHS
DT122-GH	750-DT1222-200G	DT122-GH: GH171-V1807B, 150W, PCI Riser, F/G SYSTEM, RoHS

► **Option Item**

Model Name	Part Number	Description
CPU	785-1151DL	CPU, LGA1151, Long-Term Support, RoHS
Memory	138-540002-106G	4GB DDR4 2666Mhz SO-DIMM 1Rx8 512Mx8 CL19 1.2V
	138-580004-102G	8GB DDR4 2666Mhz SO-DIMM 1Rx8 1Gx8 CL19 1.2V
	138-5G0163-102G	16GB DDR4 2666Mhz SO-DIMM 2Rx8 1Gx8 CL19 1.2V
SSD 2.5" (for all model)	635-600322-1A0G	32GB, 2.5" SSD, SATA3, MLC
	635-600644-100G	64GB, 2.5" SSD, SATA3, MLC
	635-601282-1E0G	128GB, 2.5" SSD, SATA3, MLC
	635-602562-121G	256GB, 2.5" SSD, SATA3, MLC
	635-605122-130G	512GB, 2.5" SSD, SATA3, MLC
	635-601286-110G	128GB, 2.5" SSD, SATA3, 3D TLC, PE: 3K
	TBD	256GB, 2.5" SSD, SATA3, 3D TLC, PE: 3K
	TBD	512GB, 2.5" SSD, SATA3, 3D TLC, PE: 3K
SSD M.2 2280	TBD	32GB, M.2 2280 SSD, SATA3 B+M Key, MLC
	TBD	64GB, M.2 2280 SSD, SATA3 B+M Key, MLC
	638-712811-100G	128GB, M.2 2280 SSD, SATA3 B+M Key, MLC
	638-725615-100G	256GB, M.2 2280 SSD, SATA3 B+M Key, MLC
	638-712818-100G	128GB, M.2 2280 SSD, SATA3 B+M Key, 3D TLC, PE: 3K
	638-725614-100G	256GB, M.2 2280 SSD, SATA3 B+M Key, 3D TLC, PE: 3K
	TBD	512GB, M.2 2280 SSD, SATA3 B+M Key, 3D TLC, PE: 3K
	638-701T01-100G	1TB, M.2 2280 SSD, SATA3 B+M Key, 3D TLC, PE: 3K
	638-712816-110G	128GB, M.2 2280, PCIe Gen3x4, M-Key, 3D TLC, PE: 3K
	638-725608-100G	256GB, M.2 2280, PCIe Gen3x4, M-Key, 3D TLC, PE: 3K
	TBD	512GB, M.2 2280, PCIe Gen3x4, M-Key, 3D TLC, PE: 3K
	TBD	1TB, M.2 2280, PCIe Gen3x4, M-Key, 3D TLC, PE: 3K
HDD 2.5"	635-550092-090G	2.5" SATAIII 500GB 5400RPM 128MB BLUE
	635-500100-220G	2.5" SATAIII 1TB 5400RPM 128MB BLUE
	TBD	2.5" SATAIII 2TB 5400RPM 128MB BLUE
	TBD	2.5" SATAIII 500GB 7200RPM 64MB BLACK
	635-500111-000G	2.5" SATAIII 1TB 7200RPM 64MB BLACK

► **Option Item**

HDD 3.5"	635-550091-040G	HDD 3.5" SATAIII 500GB 7200RPM 32MB BLUE
	635-510002-300G	HDD 3.5" SATAIII 1TB 7200RPM 64MB BLUE
	635-500208-300G	HDD 3.5" SATAIII 2TB 5400RPM 256MB BLUE
	TBD	HDD 3.5" SATAIII 3TB 5400RPM 64MB BLUE
	635-500401-300G	HDD 3.5" SATAIII 4TB 5400RPM 64MB BLUE
	TBD	HDD 3.5" SATAIII 6TB 5400RPM 256MB BLUE
	635-500801-300G	HDD 3.5" SATAIII 8TB 7200RPM 256MB, DC HC320, HUS728T8TALE6L4, WD
	SPL-63500198	HDD 3.5" SATAIII 8TB 7200RPM 256MB, Gold WD8003FRYZ, WD
	TBD	HDD 3.5" SATAIII 12TB 7200RPM 256MB, Purple WD121PURZ, WD
	TBD	HDD 3.5" SATAIII 12TB 7200RPM 256MB, HUH721212ALE604 (0F30146), WD
mSATA	785-MS128GMF	mSATA Card, 128GB MLC, RoHS
	785-MS64GMF	mSATA Card, 64GB MLC, RoHS
	785-MS32GMF	mSATA Card, 32GB MLC, RoHS
	785-MS16GMF	mSATA Card, 16GB MLC, RoHS
	785-MS08GMF	mSATA Card, 8GB MLC, RoHS
	785-MS04GMF	mSATA Card, 4GB MLC, RoHS
WiFi/BT Kit	761-OPS150-001G	1x intel M.2 2230 AC 3168.NGWG 802.11abgn/ac 1T1R + Bluetooth 4.2 2x MHF4 to SMA cable 200mm 2x dipole antenna 1x M2x4mm screw
	TBD	M.2 2280 B/M key to M.2 2230 A/E key adapter card
Power Cord	785-PWRD	Power Cord, Standards (USA/EUR/CH), 1.8m, RoHS
Wall Mount	761-DT1220-100G	DT122 Type A Wall Mount Kit for Top Cover, RoHS
	761-DT1220-000G	DT122 Type B Wall Mount Kit for Front Cover, RoHS
Adapter Card	TBD	M.2 2280 M key to M.2 A key, support WiFi module

► **Packing List**

• 1 DT122-GH system unit
• 1 CPU cooler
• 1 HDD drive bay kit
• 1 Heatsink/fan
• 1 Quick Installation Guide