

EAX-C236KP-B1

Intel® Core™ Processors with Intel® C236 ATX Motherboard

User's Manual



1st Ed – 01 September 2022

Part No. E2047AKBX00R

FCC Statement



THIS DEVICE COMPLIES WITH PART 15 FCC RULES. OPERATION IS SUBJECT TO THE FOLLOWING TWO CONDITIONS:

(1) THIS DEVICE MAY NOT CAUSE HARMFUL INTERFERENCE.

(2) THIS DEVICE MUST ACCEPT ANY INTERFERENCE RECEIVED INCLUDING INTERFERENCE THAT MAY CAUSE UNDESIRE OPERATION.

THIS EQUIPMENT HAS BEEN TESTED AND FOUND TO COMPLY WITH THE LIMITS FOR A CLASS "A" DIGITAL DEVICE, PURSUANT TO PART 15 OF THE FCC RULES.

THESE LIMITS ARE DESIGNED TO PROVIDE REASONABLE PROTECTION AGAINST HARMFUL INTERFERENCE WHEN THE EQUIPMENT IS OPERATED IN A COMMERCIAL ENVIRONMENT. THIS EQUIPMENT GENERATES, USES, AND CAN RADIATE RADIO FREQUENCY ENERGY AND, IF NOT INSTALLED AND USED IN ACCORDANCE WITH THE INSTRUCTION MANUAL, MAY CAUSE HARMFUL INTERFERENCE TO RADIO COMMUNICATIONS.

OPERATION OF THIS EQUIPMENT IN A RESIDENTIAL AREA IS LIKELY TO CAUSE HARMFUL INTERFERENCE IN WHICH CASE THE USER WILL BE REQUIRED TO CORRECT THE INTERFERENCE AT HIS OWN EXPENSE.

Notice

This guide is designed for experienced users to setup the system within the shortest time. For detailed information, please always refer to the electronic user's manual.

Copyright Notice

Copyright © 2022 Avalue Technology Inc., ALL RIGHTS RESERVED.

No part of this document may be reproduced, copied, translated, or transmitted in any form or by any means, electronic or mechanical, for any purpose, without the prior written permission of the original manufacturer.

Trademark Acknowledgement

Brand and product names are trademarks or registered trademarks of their respective owners.

Disclaimer

Avalue Technology Inc. reserves the right to make changes, without notice, to any product, including circuits and/or software described or contained in this manual in order to improve design and/or performance. Avalue Technology assumes no responsibility or liability for the use of the described product(s), conveys no license or title under any patent, copyright, or masks work rights to these products, and makes no representations or warranties that

these products are free from patent, copyright, or mask work right infringement, unless otherwise specified. Applications that are described in this manual are for illustration purposes only. Avalue Technology Inc. makes no representation or warranty that such application will be suitable for the specified use without further testing or modification.

Life Support Policy

Avalue Technology's PRODUCTS ARE NOT FOR USE AS CRITICAL COMPONENTS IN LIFE SUPPORT DEVICES OR SYSTEMS WITHOUT THE PRIOR WRITTEN APPROVAL OF Avalue Technology Inc.

As used herein:

1. Life support devices or systems are devices or systems which, (a) are intended for surgical implant into body, or (b) support or sustain life and whose failure to perform, when properly used in accordance with instructions for use provided in the labeling, can be reasonably expected to result in significant injury to the user.
2. A critical component is any component of a life support device or system whose failure to perform can be reasonably expected to cause the failure of the life support device or system, or to affect its safety or effectiveness.

A Message to the Customer

Avalue Customer Services

Each and every Avalue's product is built to the most exacting specifications to ensure reliable performance in the harsh and demanding conditions typical of industrial environments. Whether your new Avalue device is destined for the laboratory or the factory floor, you can be assured that your product will provide the reliability and ease of operation for which the name Avalue has come to be known.

Your satisfaction is our primary concern. Here is a guide to Avalue's customer services. To ensure you get the full benefit of our services, please follow the instructions below carefully.

Technical Support

We want you to get the maximum performance from your products. So if you run into technical difficulties, we are here to help. For the most frequently asked questions, you can easily find answers in your product documentation. These answers are normally a lot more detailed than the ones we can give over the phone. So please consult the user's manual first.

To receive the latest version of the user's manual; please visit our Web site at:

<http://www.avalue.com.tw/>

Product Warranty

Avalue warrants to you, the original purchaser, that each of its products will be free from defects in materials and workmanship for two years from the date of purchase.

This warranty does not apply to any products which have been repaired or altered by persons other than repair personnel authorized by Avalue, or which have been subject to misuse, abuse, accident or improper installation. Avalue assumes no liability under the terms of this warranty as a consequence of such events. Because of Avalue's high quality-control standards and rigorous testing, most of our customers never need to use our repair service. If any of Avalue's products is defective, it will be repaired or replaced at no charge during the warranty period. For out-of-warranty repairs, you will be billed according to the cost of replacement materials, service time, and freight. Please consult your dealer for more details. If you think you have a defective product, follow these steps:

1. Collect all the information about the problem encountered. (For example, CPU type and speed, Avalue's products model name, hardware & BIOS revision number, other hardware and software used, etc.) Note anything abnormal and list any on-screen messages you get when the problem occurs.
2. Call your dealer and describe the problem. Please have your manual, product, and any helpful information available.
3. If your product is diagnosed as defective, obtain an RMA (return material authorization) number from your dealer. This allows us to process your good return more quickly.
4. Carefully pack the defective product, a complete Repair and Replacement Order Card and a photocopy proof of purchase date (such as your sales receipt) in a shippable container. A product returned without proof of the purchase date is not eligible for warranty service.
5. Write the RMA number visibly on the outside of the package and ship it prepaid to your dealer.

Content

1. Getting Started	9
1.1 Safety Precautions	9
1.2 Packing List.....	9
1.3 Document Amendment History	10
1.4 Manual Objectives.....	11
1.5 System Specifications	12
1.6 Architecture Overview—Block Diagram	15
2. Hardware Configuration	16
2.1 Product Overview.....	17
2.2 Jumper and Connector List.....	18
2.3 Setting Jumpers & Connectors	20
2.3.1 Serial port 1 pin9 signal select (JRI1)	20
2.3.2 Serial port 2 pin9 signal select (JRI2)	20
2.3.3 AT/ATX Power Mode Select (JATATX1).....	21
2.3.4 Clear CMOS (JCMOS1).....	21
2.3.5 Serial port 2 connector (JCOM2A).....	22
2.3.6 COM2 RS485/422 connector (JCOM2B).....	22
2.3.7 Serial port 3/4/5/6 connector (JCOM3/4/5/6)	23
2.3.8 General purpose I/O connector (JDIO1)	23
2.3.9 SGPIO connector (JSGPIO1)	24
2.3.10 ATX Power connector (ATXPWR1).....	24
2.3.11 Power connector (ATX12V1).....	25
2.3.12 SMBus connector (JSMB1)	25
2.3.13 USB connector 1 (JUSB1).....	26
2.3.14 USB connector 2 (JUSB2).....	26
2.3.15 USB connector 4 (JUSB4).....	27
2.3.16 Battery connector (JBAT1)	27
2.3.17 Audio connector (JAUDIO1).....	28
2.3.17.1 Signal Description –Audio connector (JAUDIO1).....	28
2.3.18 LPC connector (JLPC1).....	28
2.3.19 SPI connector (JSPI1).....	29
2.3.20 Speaker connector (JSPK1).....	29
2.3.21 Miscellaneous setting connector (JFP1)	30
2.3.22 CPU fan connector (CPUFAN1).....	30
2.3.23 System fan connector 1 (SYSFAN1).....	31
2.3.24 System fan connector 2 (SYSFAN3).....	31
2.3.25 PS/2 keyboard & mouse connector (JKBMS1)	32

EAX-C236KP-B1 User's Manual

2.3.26	S/PDIF connector (JSPDIF1)	32
2.3.27	External Speaker connector (JBZ1)	33
2.3.28	LPT connector (LPT1)	33
2.3.29	Auxiliary Panel connector (JAUXP1)	34
3	BIOS Setup	35
3.1	Introduction	36
3.2	Starting Setup	36
3.3	Using Setup	37
3.4	Getting Help	38
3.5	In Case of Problems	38
3.6	BIOS setup	39
3.6.1	Main Menu	39
3.6.1.1	System Language	40
3.6.1.2	System Date	40
3.6.1.3	System Time	40
3.6.2	Advanced Menu	40
3.6.2.1	Intel RC ACPI Settings	41
3.6.2.2	CPU Configuration	41
3.6.2.2.1	CPU – Power management Control	42
3.6.2.2.1.1	View/Configure Turbo Options	43
3.6.2.3	CH-FW Configuration	43
3.6.2.3.1	OEM Flags Settings	44
3.6.2.3.2	Firmware Update Configuration	45
3.6.2.4	Trusted Computing	45
3.6.2.5	ACPI Settings	46
3.6.2.6	S5 RTC Wake Settings	47
3.6.2.7	Super IO Configuration	47
3.6.2.7.1	Serial Port 1 Configuration	48
3.6.2.7.2	Serial Port 2 Configuration	49
3.6.2.7.3	Serial Port 3 Configuration	49
3.6.2.7.4	Serial Port 4 Configuration	50
3.6.2.7.5	Serial Port 5 Configuration	50
3.6.2.7.6	Serial Port 6 Configuration	51
3.6.2.7.7	Parallel Port Configuration	51
3.6.2.8	NCT6106D H/W Monitor	52
3.6.2.8.1	Smart Fan Configuration	52
3.6.2.9	Serial Port Console Redirection	53
3.6.2.9.1	Legacy Console Redirection Settings	54
3.6.2.10	Intel TXT Configuration	55
3.6.2.11	Network Stack Configuration	55

3.6.2.12	CSM Configuration	56
3.6.2.13	USB Configuration.....	56
3.6.3	Chipset.....	57
3.6.3.1	System Agent (SA) Configuration.....	58
3.6.3.1.1	Memory Configuration	58
3.6.3.1.2	Graphics Configuration.....	59
3.6.3.1.3	DMI/OPI Configuration	59
3.6.3.1.4	PEG Port Configuration	60
3.6.3.1.4.1	PEG Port Feature Configuration.....	61
3.6.3.2	PCH-IO Configuration.....	61
3.6.3.2.1	PCI Express Configuration	62
3.6.3.2.1.1	PCI-E x4 Slot (PCI-E Port 1)	62
3.6.3.2.1.1.1	Extra options.....	63
3.6.3.2.1.2	mPCIe/mSATA Slot (PCI-E Port 5)	64
3.6.3.2.1.2.1	Extra options.....	65
3.6.3.2.1.3	PCI-E to PCI Bridge (PCI-E Port 6).....	65
3.6.3.2.1.4	PCI-E x1 Slot (PCI-E Port 7)	66
3.6.3.2.1.4.1	Extra options.....	67
3.6.3.2.1.5	Intel I211 LAN Chip (PCI-E Port 8).....	68
3.6.3.2.1.6	NGFF1(M.2) Slot (PCI-E Port 9).....	68
3.6.3.2.1.6.1	Extra options.....	69
3.6.3.2.2	SATA And RST Configuration	70
3.6.3.2.3	HD Audio Configuration.....	71
3.6.4	Security.....	72
3.6.4.1	Secure Boot menu.....	72
3.6.4.1.1	Key Management	73
3.6.5	Boot	74
3.6.6	Save and exit.....	75
3.6.6.1	Save Changes and Reset.....	75
3.6.6.2	Discard Changes and Reset.....	75
3.6.6.3	Restore Defaults.....	76
3.6.6.4	Launch EFI Shell from filesystem device	76
4.	Drivers Installation.....	77
4.1	Install Chipset Driver	78
4.2	Install VGA Driver.....	79
4.3	Install SOL Driver	80
4.4	Install Audio Driver (For Realtek ALC888S HD Audio).....	81
4.5	Install LAN Driver	82
4.6	Install RST Driver	84

5. Mechanical Drawing86

1. Getting Started

1.1 Safety Precautions

Warning!



Always completely disconnect the power cord from your chassis whenever you work with the hardware. Do not make connections while the power is on. Sensitive electronic components can be damaged by sudden power surges. Only experienced electronics personnel should open the PC chassis.

Caution!



Always ground yourself to remove any static charge before touching the CPU card. Modern electronic devices are very sensitive to static electric charges. As a safety precaution, use a grounding wrist strap at all times. Place all electronic components in a static-dissipative surface or static-shielded bag when they are not in the chassis.

1.2 Packing List

Before you begin installing your single board, please make sure that the following materials have been shipped:

- 1 x EAX-C236KP-B1 motherboard
- 2 x SATA cable
- 1 x I/O Shield



If any of the above items is damaged or missing, contact your retailer.

1.3 Document Amendment History

Revision	Date	By	Comment
1 st	September 2022	Avalue	Initial Release

1.4 Manual Objectives

This manual describes in details Avalue Technology EAX-C236KP-B1 Single Board.

We have tried to include as much information as possible but we have not duplicated information that is provided in the standard IBM Technical References, unless it proved to be necessary to aid in the understanding of this board.

We strongly recommend that you study this manual carefully before attempting to set up EAX-C236KP-B1 or change the standard configurations. Whilst all the necessary information is available in this manual we would recommend that unless you are confident, you contact your supplier for guidance.

Please be aware that it is possible to create configurations within the CMOS RAM that make booting impossible. If this should happen, clear the CMOS settings, (see the description of the Jumper Settings for details).

If you have any suggestions or find any errors regarding this manual and want to inform us of these, please contact our Customer Service department with the relevant details.

1.5 System Specifications

System	
CPU	Intel® LGA1151 Socket Supports 6/7th Generation Core™ / Intel® Xeon® Process E3-1200 v5/v6 Family (Workstation) / Intel® Pentium® / Celeron® Processors (Max. TDP at 95W)
BIOS	AMI uEFI BIOS, 128Mbit SPI Flash ROM
System Chipset	Intel® C236 Chipset
I/O Chip	Nuvoton® NCT6106D
System Memory	Four 288-pin DDR4 2400MHz DIMM socket, supports up to 64GB Max (ECC memory supported by CPU)
Watchdog Timer	H/W Reset, 5~255 seconds/5~255 minutes
H/W Status Monitor	CPU temperature monitoring Voltages monitoring CPU fan speed control
Other	EEPROM: AMI uEFI BIOS, 128Mbit SPI Flash ROM
Expansion Slot	
mPCIe	1 x Full Size Mini-PCIe with mSATA (Shared with SATA 4) or PCI-e by switch IC
M.2	1 x M.2 2230 KeyA Slot support WiFi module
PCIe	1 x PCI-e x16 1 x PCI-e x4 1 x PCI-e x1
Storage	
mSATA	1 x Full Size Mini-PCIe with mSATA (Shared with SATA 4) or PCI-e by switch IC
SATA	5 x SATA III 1 x Full Size Mini-PCIe with mSATA (Shared with SATA 4) or PCI-e by switch IC
Edge I/O	
COM	COM 1 by DB9 Connector at IO support RS-232
LAN	1 x Intel® I219LM Gigabit Ethernet PHY 1 x Intel® I211AT co-lay I210AT PCI-e Gigabit Ethernet
USB 2.0	PS/2 KB/MS + 2 x USB 2.0 at I/O
USB 3.1	2 x RJ-45 Dual stack for 4 x USB 3.0 connector
DP	1 x DP
HDMI	1 x HDMI
VGA	1 x VGA
Onboard I/O	
COM	COM 2~6: 1 x 2 x 5 pin, pitch 2.54mm BOX connector for COM2 support RS232 with Pin 9,

	<p>+5V&+12V/RI (JCOM2A)</p> <p>1 x 1 x 3 pin, pitch 2.0mm connector for COM1 & COM2 support RS232 with Pin 9, +5V&+12V/RI</p> <p>1 x 2 x 3 pin, pitch 2.00mm connector for COM2: support RS422/485 connector, Pin 5 with +5V By BIOS setting RS232/422/485 Selection.</p> <p>COM3~6 (JCOM3~6)</p> <p>4 x 2 x 5 pin, pitch 2.54mm BOX connector for COM3~6: support RS-232 connector, Pin 9 with RI Supported</p>
USB 2.0	<p>1 x 1 x 5 pin, pitch 2.54mm USB 2.0 by pin header (JUSB2)</p> <p>1 x 2 x 10 pin, pitch 2.0mm USB 2.0 by box header (JUSB1)</p> <p>1 x 2 x 5 pin, pitch 2.54mm USB 2.0 by pin header (JUSB4)</p> <p>1 x USB 2.0 By Vertical type A connector (JUSB3)</p>
USB 3.1	1 x 2 x 10 pin, pitch 2.0mm connector for USB 3.0 (JUSB1)
GPIO	1 x 2 x 6 pin, pitch 2.00mm connector for 8 bits GPIO (JDIO1)
CPU/System FAN	<p>1 x 1 x 4 pin, pitch 2.54mm CPU fan connector with smart fan function supported (CPUFAN1)</p> <p>1 x 1 x 4 pin, pitch 2.54mm System fan connector with smart fan function supported (SYSFAN1)</p> <p>1 x 1 x 3 pin, pitch 2.54mm System fan connector (SYSFAN3)</p>
Buzzer	Onboard (BZ1), 1 x 1 x 4 pin, pitch 2.54mm connector for buzzer (JBZ1)
Front Panel	1 x 2 x 5 pin, pitch 2.54mm connector for front panel (JFP1)
RTC Battery	<p>1 x 1 x 2 pin pitch 1.25mm battery wafer connector (JBAT1)</p> <p>Co-lay 1 x 2 pin pitch horizontal type battery holder (JBT1)</p>
AT/ATX Selector	<p>1 x 1 x 3 pin pitch 2.00mm connector for AT/ATX jumper (JATATX1)</p> <p>1 x 2 x 12 pin ATX power connector (ATXPWR1)</p> <p>1 x 2 x 4 pin ATX 12V power connector (ATX12V1)</p>
Clear CMOS	1 x 1 x 3pin, pitch 2.54mm connector for COMS Clear (JCMOS1)
LPC	1 x 2 x 5 pin, pitch 2.00 mm connector for LPC (JLPC1)
BIOS SPI	1 x 2 x 4 pin, pitch 2.00 mm connector for BIOS SPI (JSPI1)
Audio	1 x 2 x 5 pin, pitch 2.54mm connector for front Audio (JAUDIO1)
Other	<p>1 x 5 pin, pitch 2.54mm connector for SMBus (JSMB1)</p> <p>1 x 2 x 13 pin, pitch 2.54mm wafer connector for LPT (JLPT1)</p> <p>1 x 1 x 6 pin, pitch 2.5mm wafer connector for PS2 KB / Mouse (JKBMS1)</p> <p>1 x 2 x 3 pin, pitch 2.00mm connector for JSGPIO1</p> <p>1 x 1 x 4 pin, pitch 2.54mm connector for S/PDIF (JSPDIF1)</p> <p>1 x 2 x 10 pin, pitch 2.54mm connector for Auxiliary panel (JAUXP1)</p> <p>1 x 4 pin, pitch wafer 2.00mm connector for 6W x 2 Speaker (JSPK1)</p>
Display	
Graphic Chipset	Intel® C236 chipset

EAX-C236KP-B1 User's Manual

Spec. & Resolution	VGA: 2560 x 1600 @ 60 Hz HDMI: 3840 x 2160 @ 30 Hz, 2560 x 1600 @ 30 Hz (Note: This resolution is actual test result. Intel resolution: 4096 x 2160 @24Hz) DP: 4096 x 2304 @60Hz
Multiple Display	Triple Display
Audio	
Audio Codec	Realtek ALC888S co-lay ALC897 (Default: ALC888S) HD Audio with 6W Amplifier
Amplifier	2 x 6W Amplifier
Ethernet	
LAN Chipset	1 x Intel® I219LM Gigabit Ethernet PHY 1 x Intel® I211AT co-lay I210AT PCI-e Gigabit Ethernet
Mechanical & Environmental Specification	
Power Requirement	+12V / +5V / 5VSB /+3.3V/ -12V
ACPI	Single power ATX Support S0, S3, S4, S5
Power Mode	AT/ATX mode
Operating Temp.	0~60°C (32~140°F)
Storage Temp.	-40~ 75°C
Operating Humidity	40°C @ 95% relative humidity, non-condensing
Size (L x W) (Please consult product engineers for the production feasibility if the size is larger than 410x360mm or smaller than 80x70mm)	12" x 9.6" (304.8mm x 243.84mm)
Weight	0.60 kg



Note: Specifications are subject to change without notice.

1.6 Architecture Overview—Block Diagram

The following block diagram shows the architecture and main components of EAX-C236KP-B1.

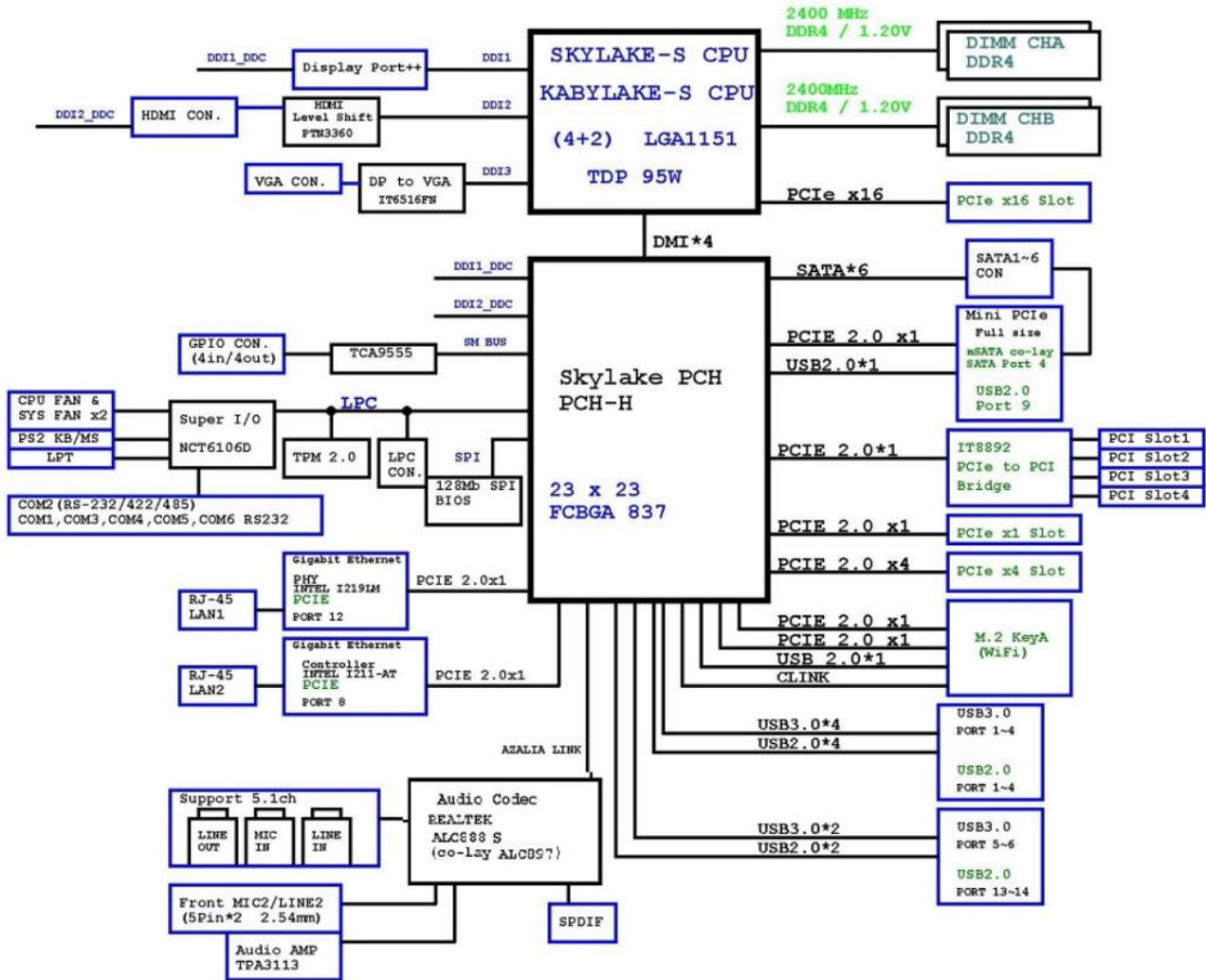

2. Hardware Configuration

2.1 Product Overview

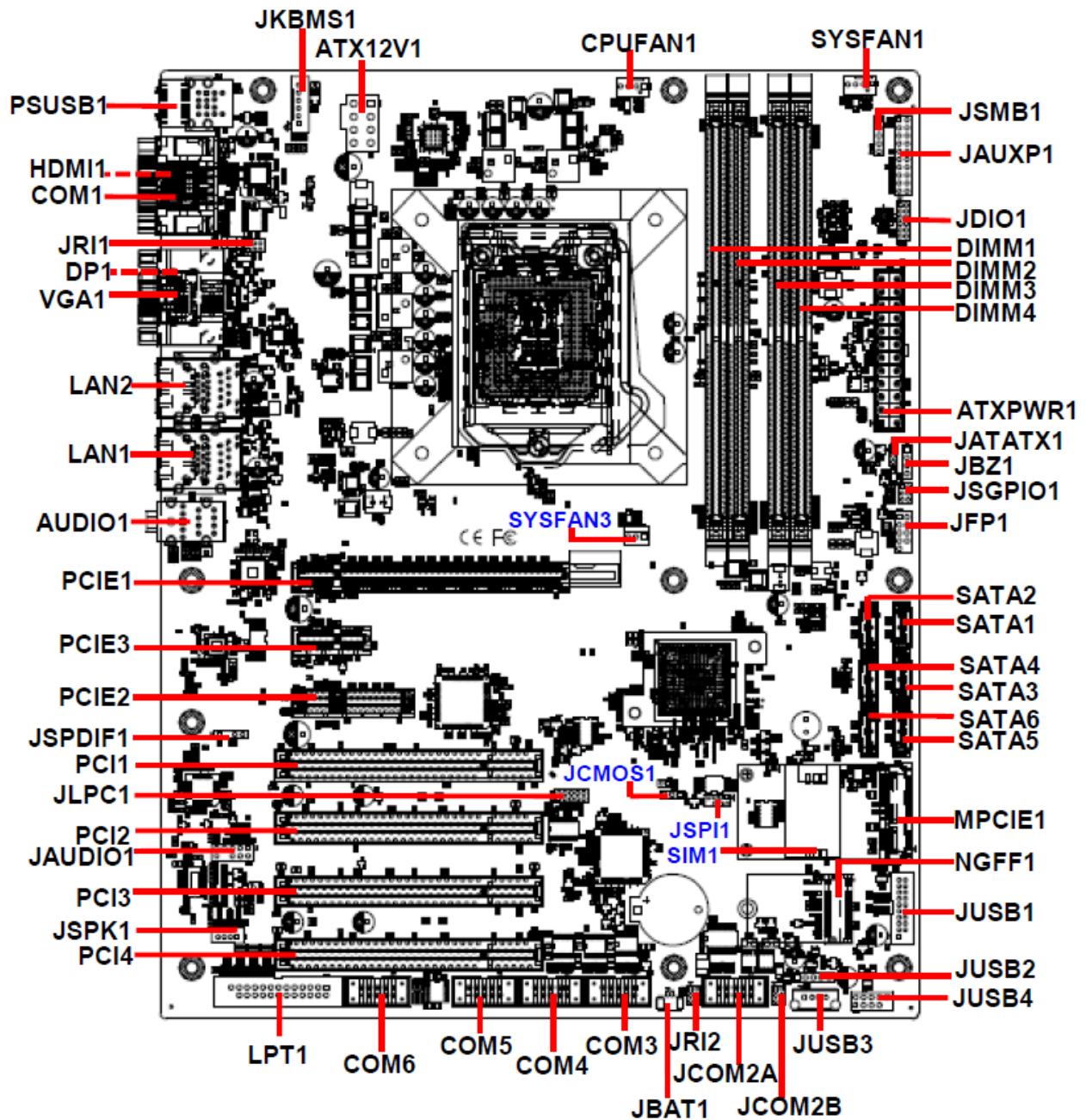

2.2 Jumper and Connector List

You can configure your board to match the needs of your application by setting jumpers. A jumper is the simplest kind of electric switch.

It consists of two metal pins and a small metal clip (often protected by a plastic cover) that slides over the pins to connect them. To “close” a jumper you connect the pins with the clip. To “open” a jumper you remove the clip. Sometimes a jumper will have three pins, labeled 1, 2, and 3. In this case, you would connect either two pins.

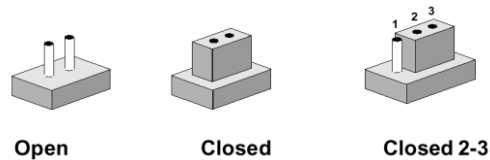

The jumper settings are schematically depicted in this manual as follows:



A pair of needle-nose pliers may be helpful when working with jumpers.

Connectors on the board are linked to external devices such as hard disk drives, a keyboard, or floppy drives. In addition, the board has a number of jumpers that allow you to configure your system to suit your application.

If you have any doubts about the best hardware configuration for your application, contact your local distributor or sales representative before you make any changes.

The following tables list the function of each of the board's jumpers and connectors.

Jumpers

Label	Function	Note
JRI1/2	Serial port 1/2 pin9 signal select	3 x 2 header, pitch 2.00mm
JATATX1	AT/ATX Power Mode Select	3 x 1 header, pitch 2.00mm
JCMOS1	Clear CMOS	3 x 1 header, pitch 2.54mm

Connectors

Label	Function	Note
CPUFAN1	CPU fan connector	4 x 1 wafer, pitch 2.54mm
SYSFAN1	System fan connector 1 (with smart fan function supported)	4 x 1 wafer, pitch 2.54mm
SYSFAN3	System fan connector 2	3 x 1 wafer, pitch 2.54mm
JFP1	Miscellaneous setting connector	5 x 2 header, pitch 2.54 mm
DIMM1/2/3/4	288-pin DDR4 DIMM socket	
AUDIO1	Audio connector	

JAUDIO1	Audio connector 2	5 x 2 header, pitch 2.54 mm
JAUXP1	Auxiliary Panel connector	10 x 2 header, pitch 2.54 mm
JSPI1	SPI connector	4 x 2 header, pitch 2.00mm
COM1	Serial Port 1 connector	D-sub 9 pin, male
JCOM2A	Serial Port 2 connector	5 x 2 wafer, pitch 2.54mm
JCOM2B	COM2 RS485/422 connector	3 x 2 header, pitch 2.00 mm
JCOM3/4/5/6	Serial Port 3/4/5/6 connector	5 x 2 wafer, pitch 2.54mm
JBZ1	External Speaker connector	4 x 1 header, pitch 2.54 mm
JDIO1	General purpose I/O connector	6 x 2 header, pitch 2.00mm
JSGPIO1	SGPIO connector	3 x 2 header, pitch 2.00 mm
JSPK1	Speaker connector	1 x 4 wafer, pitch 2.00 mm
PSUSB1	PS/2 keyboard & mouse connector 2 x USB 2.0 connector	
JKBMS1	PS/2 keyboard & mouse connector	6 x 1 wafer, pitch 2.50 mm
LAN1/2	2 x RJ-45 with Dual deck USB 3.0 connector	
JUSB1	USB connector 1	10 x 2 wafer, pitch 2.00mm
JUSB2	USB connector 2	5 x 1 header, pitch 2.54mm
JUSB3	USB connector 3	
JUSB4	USB connector 4	5 x 2 header, pitch 2.54mm
JLPC1	LPC connector	5 x 2 header, pitch 2.00mm
PCIE1/2/3	PCIe slot 1/2/3	
PCI1/2/3/4	PCI slot 1/2/3/4	
JBAT1	Battery connector	2 x 1 wafer, pitch 1.25mm
MPCIE1	Mini-PCI connector	
ATXPWR1	ATX Power connector	12 x 2 wafer, pitch 4.20mm
ATX12V1	Power connector	2 x 4 wafer, pitch 4.20mm
SATA1~6	Serial ATA connector 1~6	
HDMI1	HDMI connector	
DP1	DP connector	
VGA1	VGA connector	
NGFF1	M.2 2230 KeyA Slot support WiFi module	
LPT1	LPT connector	13 x 2 header, pitch 2.54mm
JSIM1	SIM card slot	
JSPDIF1	S/PDIF connector	
JSMB1	SMBus connector	5 x 1 header, pitch 2.54mm

2.3 Setting Jumpers & Connectors

2.3.1 Serial port 1 pin9 signal select (JRI1)

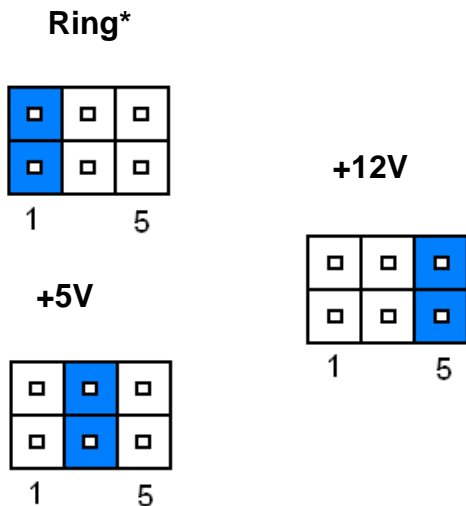
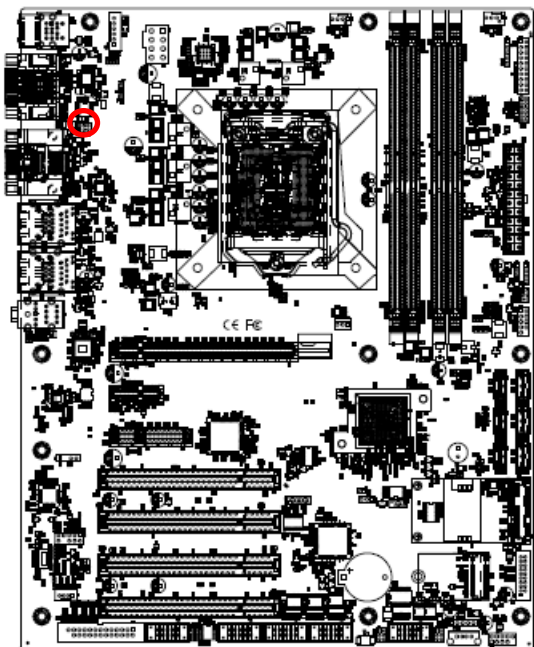

* Default

2.3.2 Serial port 2 pin9 signal select (JRI2)

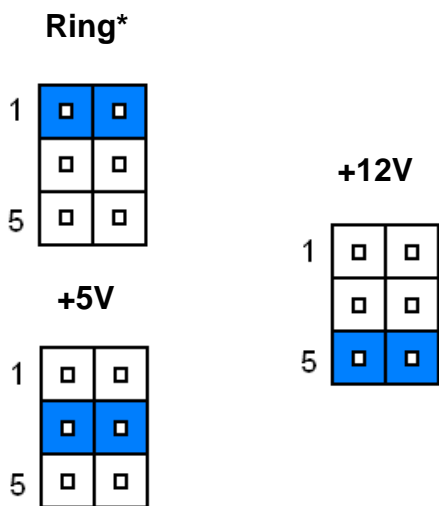
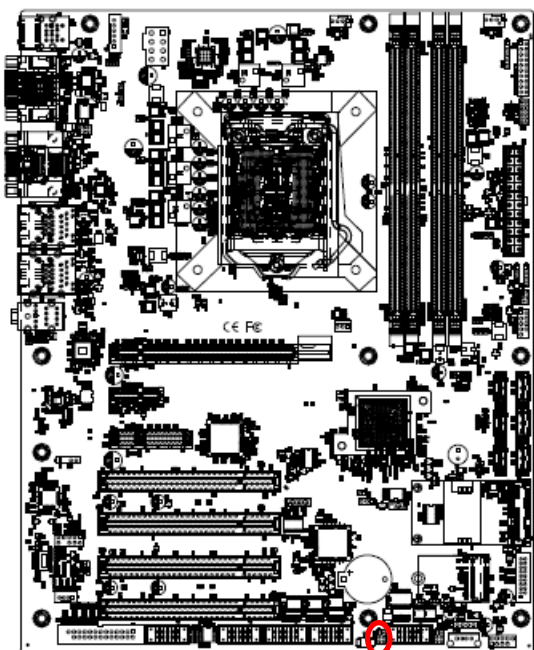

* Default

2.3.3 AT/ATX Power Mode Select (JATATX1)

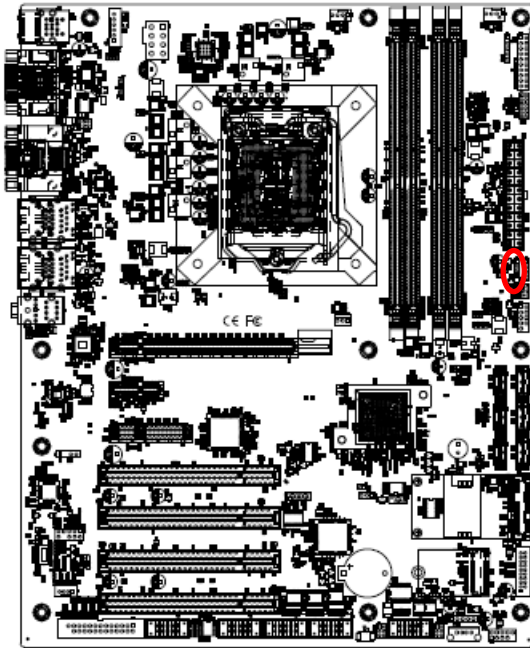

AT*

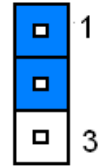

ATX

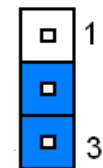

* Default

2.3.4 Clear CMOS (JCMOS1)

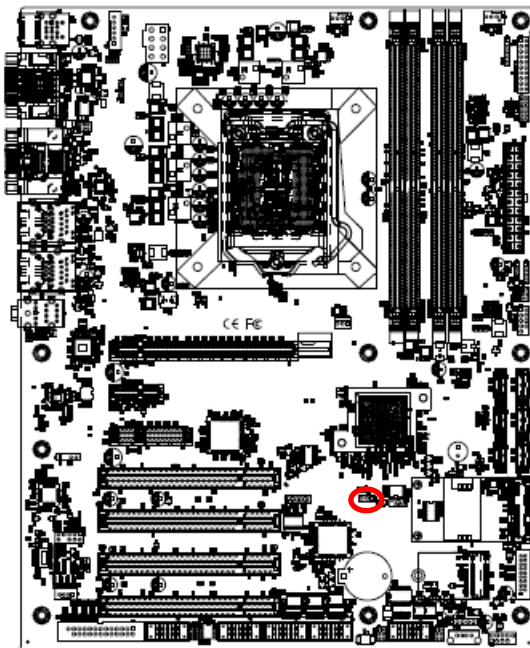

Protect*

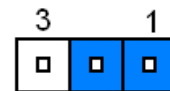

Clear CMOS

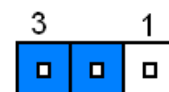

* Default

2.3.5 Serial port 2 connector (JCOM2A)

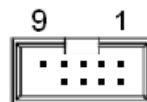
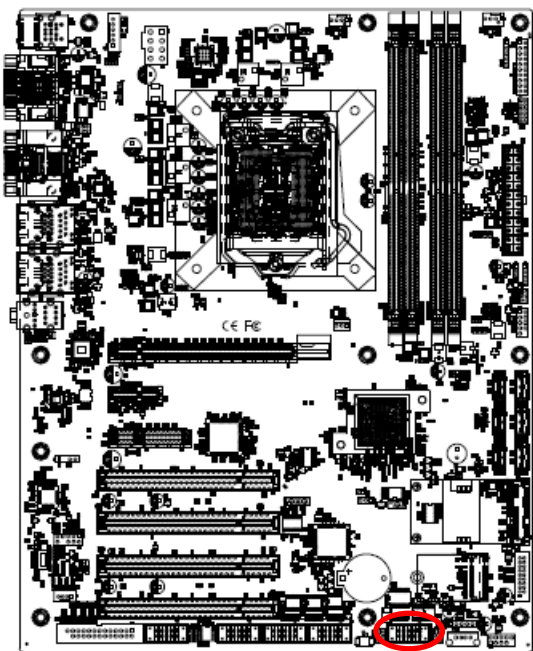

Signal	PIN	PIN	Signal
NRXD	2	1	NDCD#
NDTR#	4	3	NTXD
NDSR#	6	5	GND
NCTS#	8	7	NRTS#
		9	JNRI#

2.3.6 COM2 RS485/422 connector (JCOM2B)

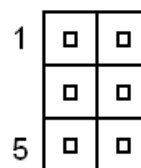
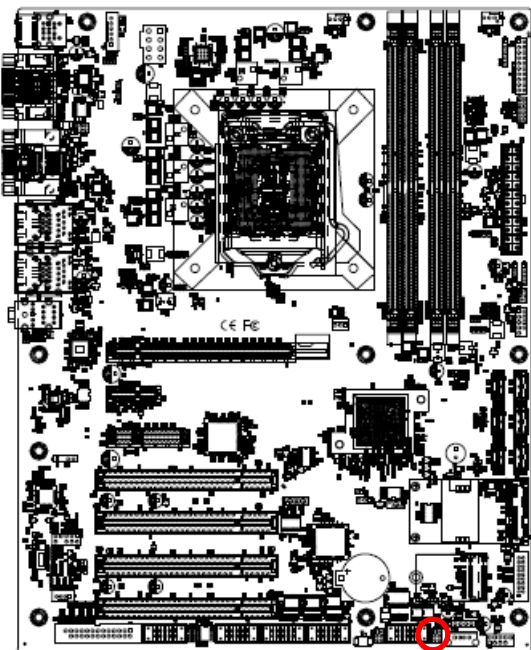

Signal	PIN	PIN	Signal
485TX-	1	2	422RX-
485TX+	3	4	422RX+
+5V	5	6	GND

2.3.7 Serial port 3/4/5/6 connector (JCOM3/4/5/6)

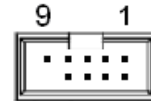
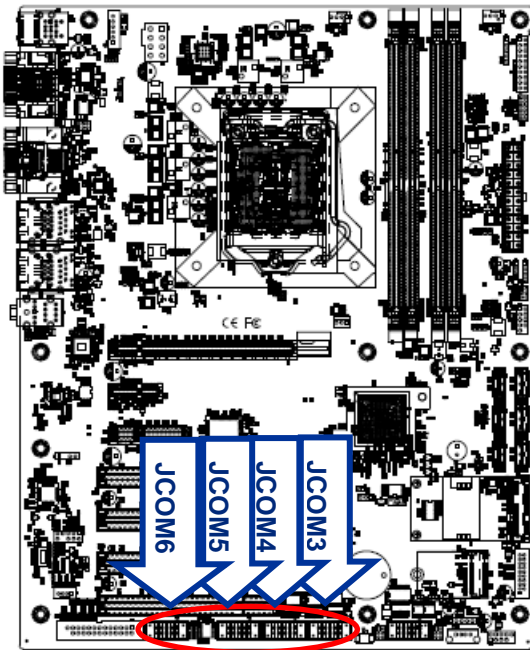

Signal	PIN	PIN	Signal
NRXD	2	1	NDCD#
NDTR#	4	3	NTXD
NDSR#	6	5	GND
NCTS#	8	7	NRTS#
NC	10	9	NRI#

2.3.8 General purpose I/O connector (JDIO1)

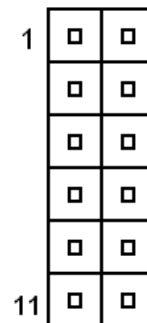
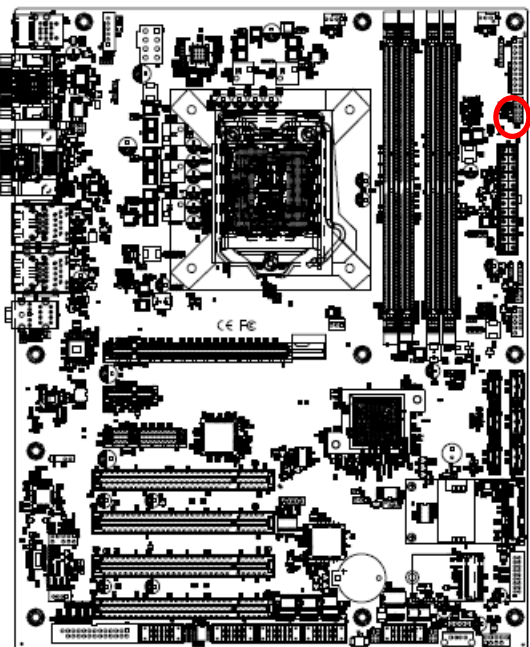

Signal	PIN	PIN	Signal
DI0	1	2	DO0
DI1	3	4	DO1
DI2	5	6	DO2
DI3	7	8	DO3
SMB_CLK_9555	9	10	SMB_DATA_9555
GND	11	12	+5V

2.3.9 SGPIO connector (JSGPIO1)

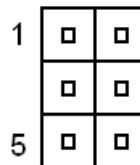
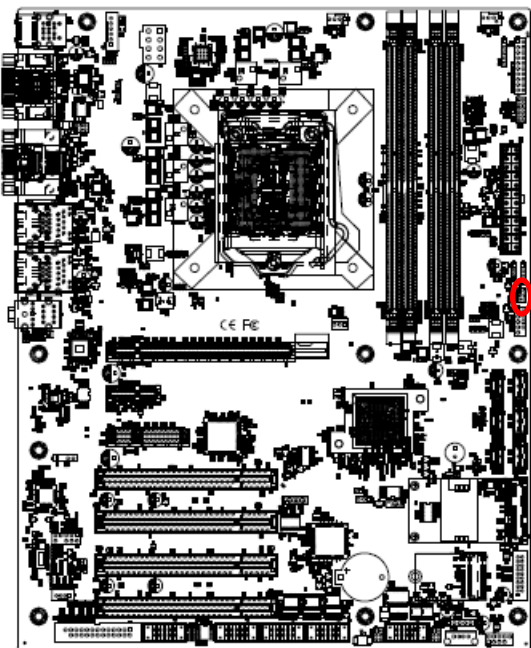

Signal	PIN	PIN	Signal
GND	1	2	GND
SGIO_LOAD	3	4	SGIO_DATOUT0
SGIO_CLK	5	6	SGIO_DATOUT1

2.3.10 ATX Power connector (ATXPWR1)

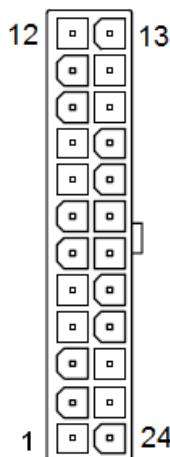
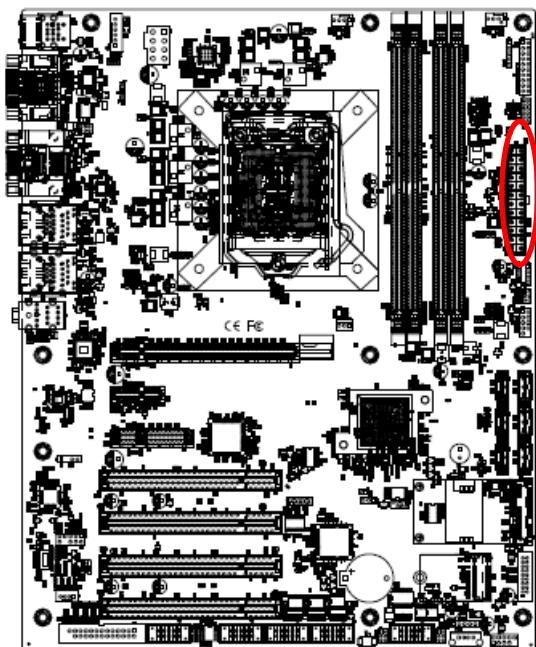

Signal	PIN	PIN	Signal
+3.3V	12	24	GND
+12V	11	23	+5V
+12V	10	22	+5V
+V5SB	9	21	+5V
ATX_PWRGD	8	20	-5V
GND	7	19	GND
+5V	6	18	GND
GND	5	17	GND
+5V	4	16	ATX_PSON#
GND	3	15	GND
+3.3V	2	14	-12V
+3.3V	1	13	+3.3V

2.3.11 Power connector (ATX12V1)

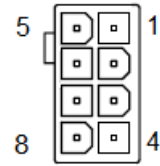
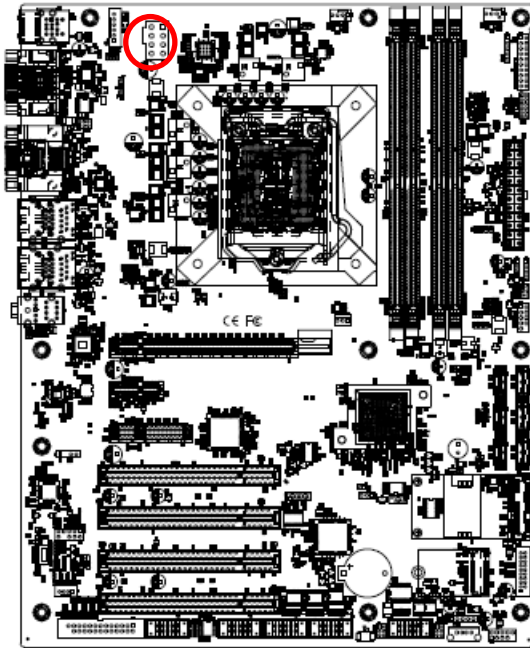

Signal	PIN	PIN	Signal
+12V	5	1	GND
+12V	6	2	GND
+12V	7	3	GND
+12V	8	4	GND

2.3.12 SMBus connector (JSMB1)

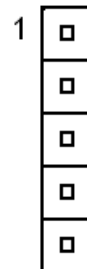
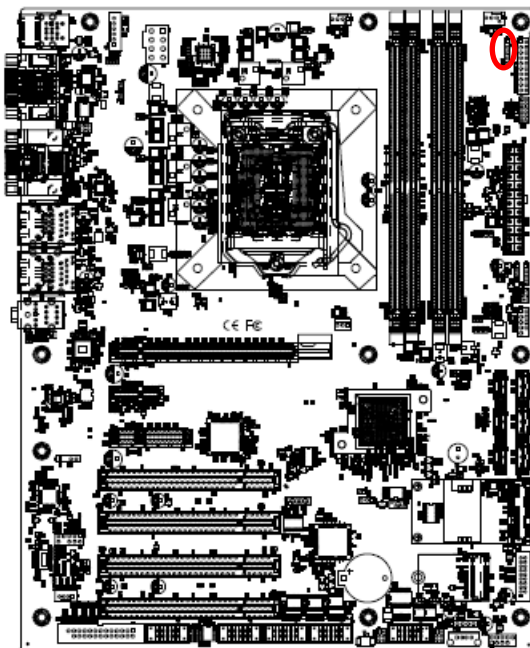

Signal	PIN
SMB_CLK_MAIN	1
SMB_DATA_MAIN	2
SMB_ALERT#_MAIN	3
GND	4
+3.3V	5

2.3.13 USB connector 1 (JUSB1)

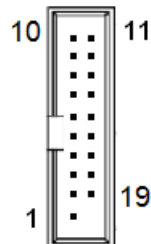
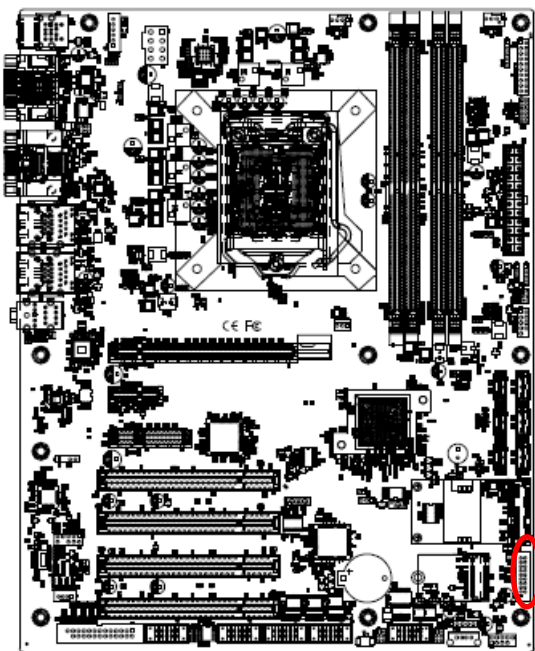

Signal	PIN	PIN	Signal
NC	10	11	USB_R_DP14
USB_R_DP13	9	12	USB_R_DN14
USB_R_DN13	8	13	GND
GND	7	14	SS_USB_TXP_C_6
SS_USB_TXP_C_5	6	15	SS_USB_TXN_C_6
SS_USB_TXN_C_5	5	16	GND
GND	4	17	SS_USB_RXP_C_6
SS_USB_RXP_C_5	3	18	SS_USB_RXN_C_6
SS_USB_RXN_C_5	2	19	USBVCC_DE
USBVCC_DE	1		

2.3.14 USB connector 2 (JUSB2)

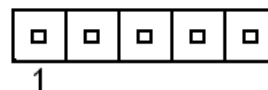
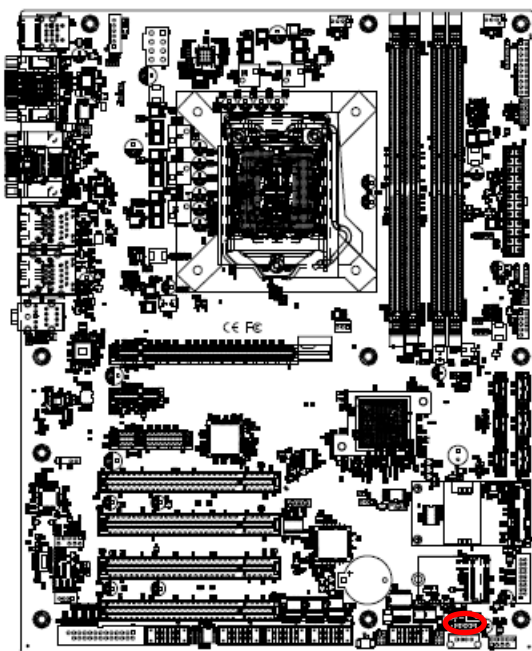

Signal	PIN
USBVCC56	1
USB_R_DN5	2
USB_R_DP5	3
GND	4
GND	5

2.3.15 USB connector 4 (JUSB4)

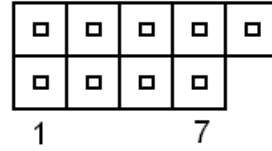
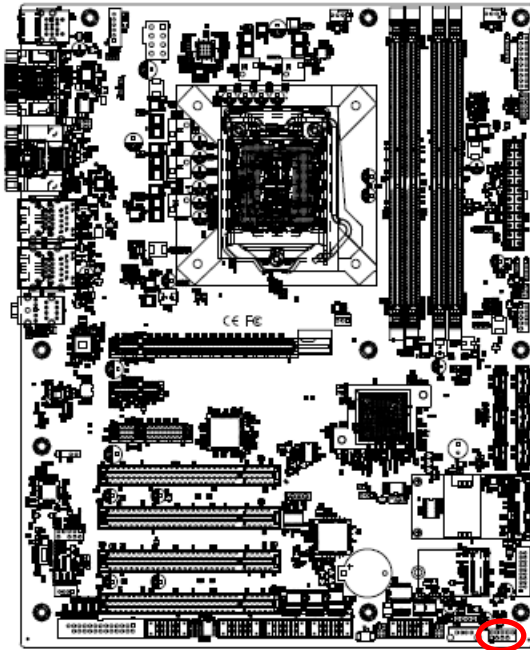

Signal	PIN	PIN	Signal
USBVCC_BC	1	2	USBVCC_BC
USB_R_DN12	3	4	USB_R_DN11
USB_R_DP12	5	6	USB_R_DP11
GND	7	8	GND
		10	NC

2.3.16 Battery connector (JBAT1)

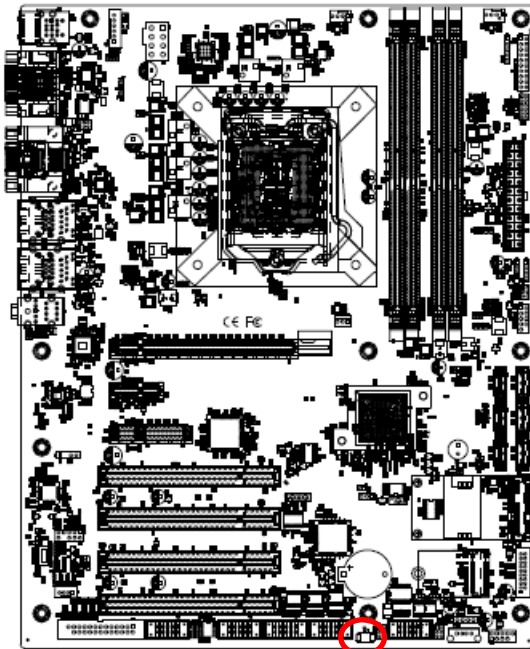

Signal	PIN
RTC_VBAT_1	1
GND	2

2.3.17 Audio connector (JAUDIO1)

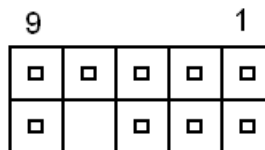
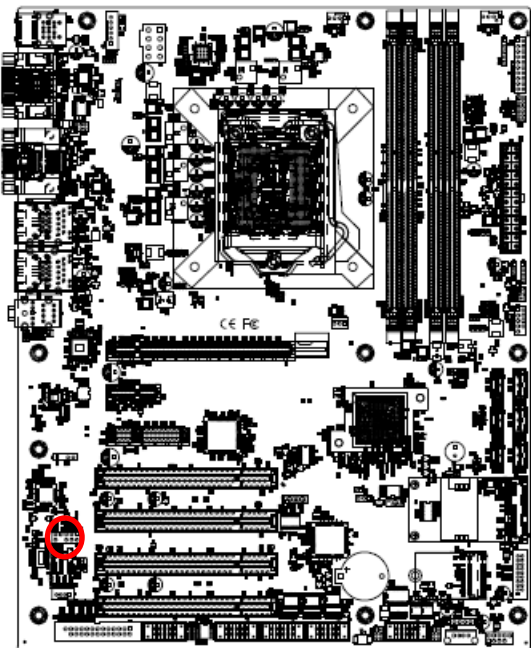

Signal	PIN	PIN	Signal
MIC2_L	1	2	GND
MIC2_R	3	4	ACZ_DET#_R
LNE2_RIN	5	6	MIC2_JD
GND	7		
LINE2_LIN	9	10	LINE2_JD

2.3.17.1 Signal Description –Audio connector (JAUDIO1)

Signal	Signal Description
LINE2_JD	AUDIO IN (LINE_RIN/LIN)sense pin
MIC2_JD	MIC IN (MIC_RIN/LIN) sense pin

2.3.18 LPC connector (JLPC1)

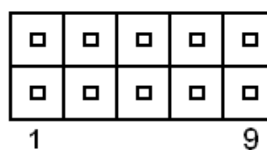
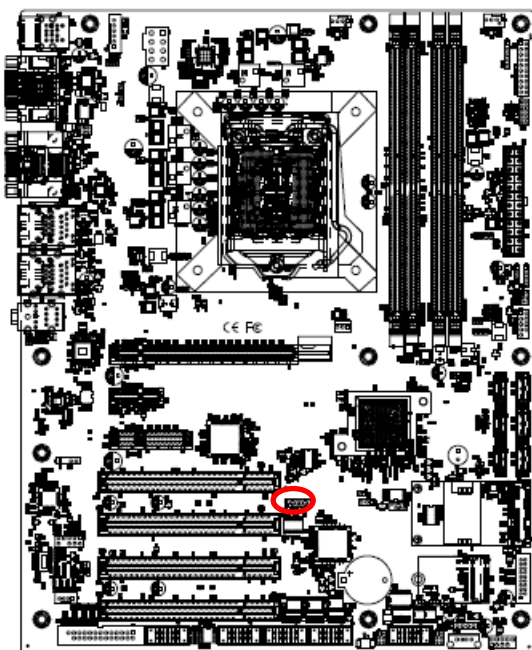

Signal	PIN	PIN	Signal
LPC_AD0_R	1	2	+3.3V
LPC_AD1_R	3	4	BUF_PLT_RST#
LPC_AD2_R	5	6	LPC_FRAME#_R
LPC_AD3_R	7	8	LPC_CLK
LPC_SERIRQ_R	9	10	GND

2.3.19 SPI connector (JSPI1)

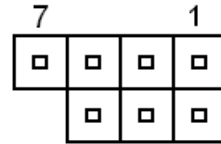
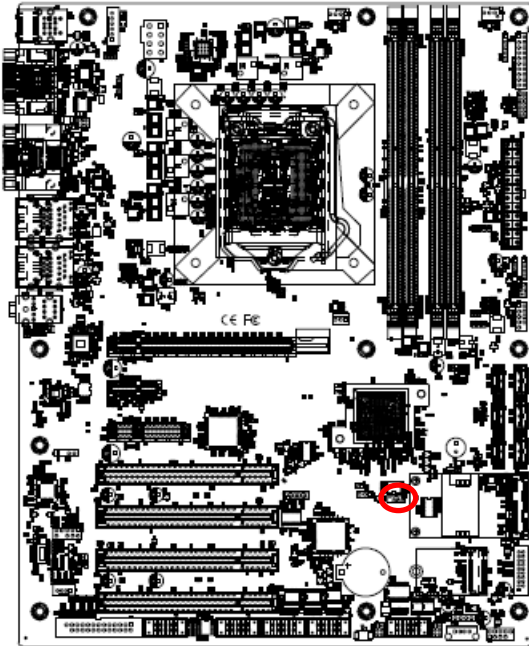

Signal	PIN	PIN	Signal
+3.3V	1	2	GND
SSPI_CS0#_R	3	4	SSPI_SCLK_R
SSPI_SO_R	5	6	SSPI_SI_R
SSPI_HOLD#0	7		

2.3.20 Speaker connector (JSPK1)

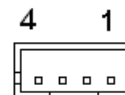
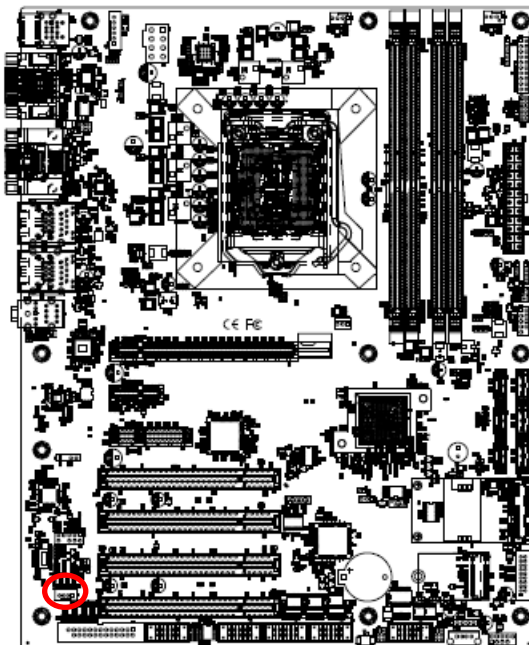

Signal	PIN
SPK_L+	1
SPK_L-	2
SPK_R+	3
SPK_R-	4

2.3.21 Miscellaneous setting connector (JFP1)

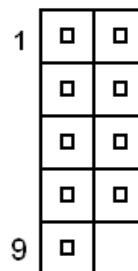
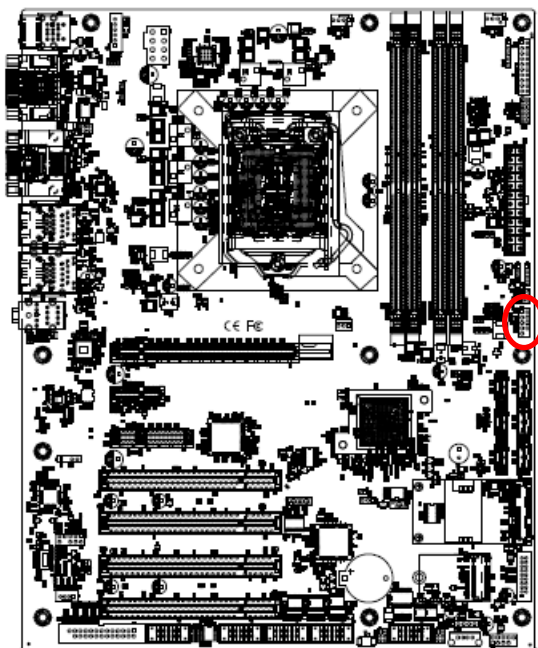

Signal	PIN	PIN	Signal
HDD_LED+	1	2	PWR_LED+
HDD_LED-	3	4	PWE_LED-
RSET_BTN#	5	6	PWRBTN#
GND	7	8	GND
NC	9		

2.3.22 CPU fan connector (CPUFAN1)

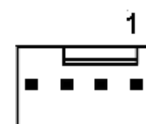
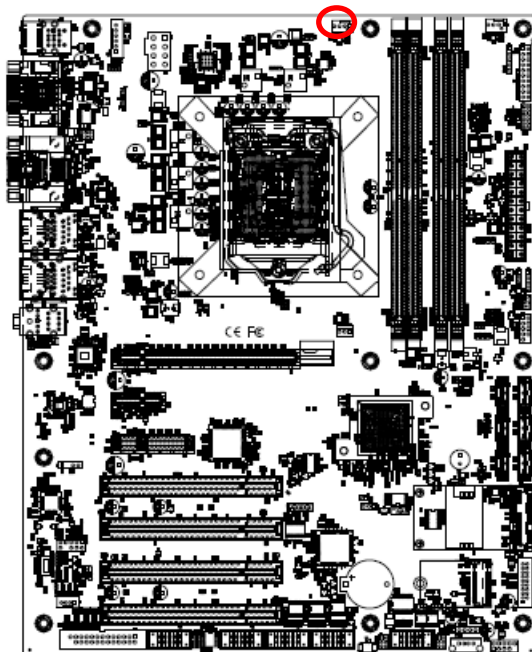

Signal	PIN
GND	1
+12V	2
CPUFANIN	3
CPUFANOUT	4

2.3.23 System fan connector 1 (SYSFAN1)

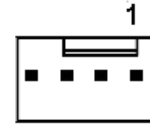
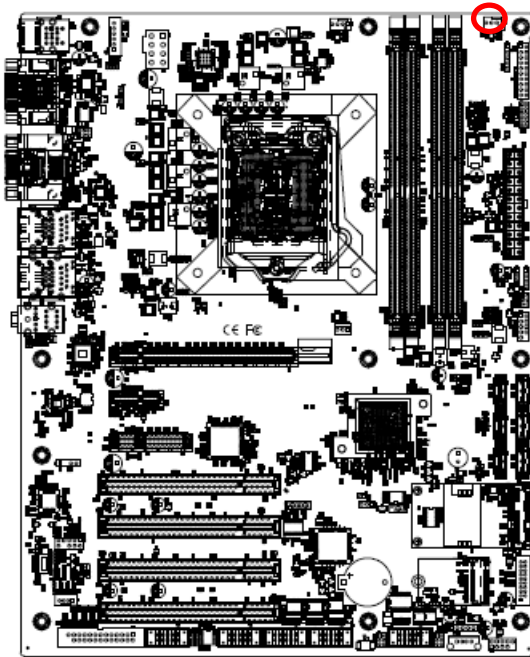

Signal	PIN
GND	1
+12V	2
SYSFANIN1	3
SYSFANOUT1	4

2.3.24 System fan connector 2 (SYSFAN3)

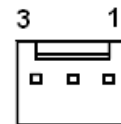
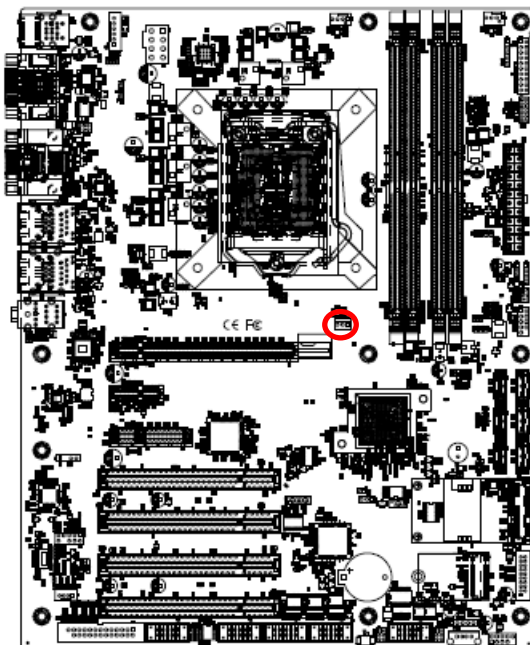

Signal	PIN
GND	1
+12V	2
SYS_FAN_IN_2	3

2.3.25 PS/2 keyboard & mouse connector (JKBMS1)

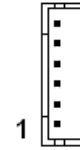
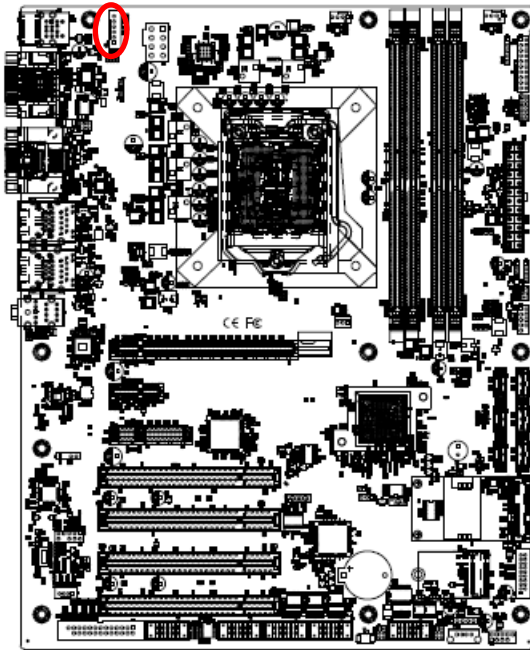

Signal	PIN
MSCK	6
+5V	5
GND	4
MSDT	3
KBDT	2
KBCK	1

2.3.26 S/PDIF connector (JSPDIF1)

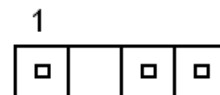
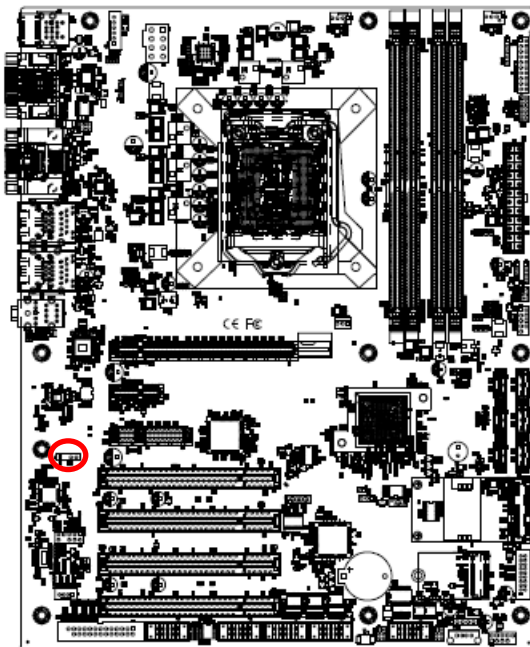

Signal	PIN
+5V	1
SPDIF_O	3
GND	4

2.3.27 External Speaker connector (JBZ1)

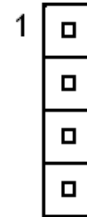
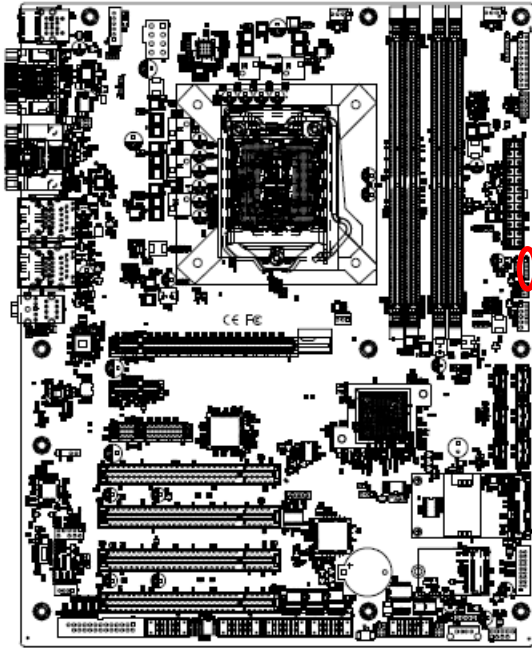

Signal	PIN
+5V	1
NC	2
NC	3
SIO_BEEP	4

2.3.28 LPT connector (LPT1)

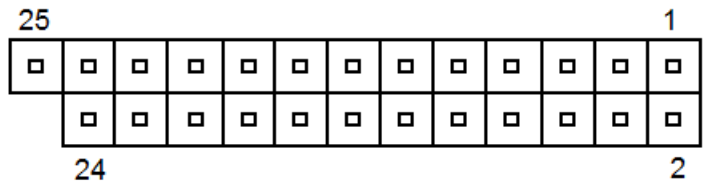
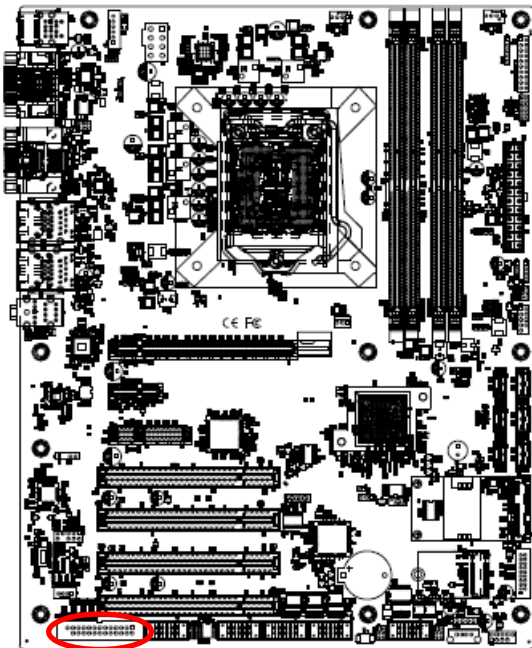

Signal	PIN	PIN	Signal
PT-STB-	1	2	PT_AFD#
PTD0	3	4	ERR#
PTD1	5	6	PT_PAR_INIT#
PTD2	7	8	PT_SLIN#
PTD3	9	10	GND
PTD4	11	12	GND
PTD5	13	14	GND
PTD6	15	16	GND
PTD7	17	18	GND
ACK#	19	20	GND
BUSY	21	22	GND
PE	23	24	GND
SLCT	25		

2.3.29 Auxiliary Panel connector (JAUXP1)

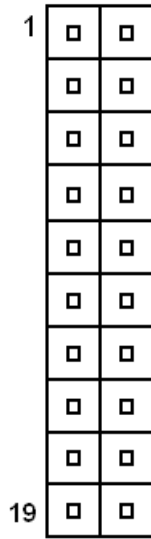
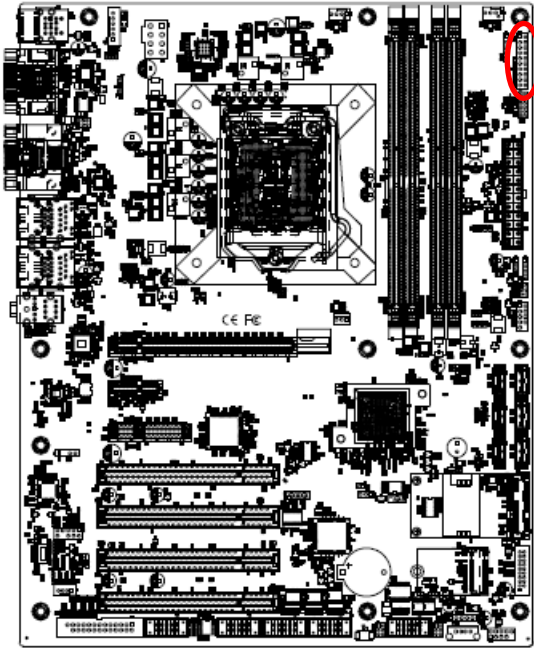

Signal	PIN	PIN	Signal
+5V	1	2	NC
NC	3	4	SMB_CLK_MAIN
CASEOPEN#	5	6	NC
GND	7	8	GND
ERROR_LED	9	10	SMB_DATA_MAIN
ERROR_LED#	11	12	+5V
FRONT_LAN1_ACT	13	14	FRONT_LAN1_LINK100#
GND	15	16	FRONT_LAN1_LINK1000#
FRONT_LAN2_ACT	17	18	FRONT_LAN2_LINK100#
GND	19	20	FRONT_LAN2_LINK1000#

3. BIOS Setup

3.1 Introduction

The BIOS setup program allows users to modify the basic system configuration. In this following chapter will describe how to access the BIOS setup program and the configuration options that may be changed.

3.2 Starting Setup

The AMI BIOS™ is immediately activated when you first power on the computer. The BIOS reads the system information contained in the NVRAM and begins the process of checking out the system and configuring it. When it finishes, the BIOS will seek an operating system on one of the disks and then launch and turn control over to the operating system.

While the BIOS is in control, the Setup program can be activated in one of two ways:

By pressing or <F2> immediately after switching the system on, or

By pressing the or <F2> key when the following message appears briefly at the left-top of the screen during the POST (Power On Self Test).

Press or <F2> to enter SETUP

If the message disappears before you respond and you still wish to enter Setup, restart the system to try again by turning it OFF then ON or pressing the "RESET" button on the system case. You may also restart by simultaneously pressing <Ctrl>, <Alt>, and <Delete> keys. If you do not press the keys at the correct time and the system does not boot, an error message will be displayed and you will again be asked to.

Press F1 to Continue, DEL to enter SETUP

3.3 Using Setup

In general, you use the arrow keys to highlight items, press <Enter> to select, use the PageUp and PageDown keys to change entries, press <F1> for help and press <Esc> to quit. The following table provides more detail about how to navigate in the Setup program using the keyboard.

Button	Description
↑	Move to previous item
↓	Move to next item
←	Move to the item in the left hand
→	Move to the item in the right hand
Esc key	Main Menu -- Quit and not save changes into NVRAM Status Page Setup Menu and Option Page Setup Menu -- Exit current page and return to Main Menu
+ key	Increase the numeric value or make changes
- key	Decrease the numeric value or make changes
F1 key	General help, only for Status Page Setup Menu and Option Page Setup Menu
F2 key	Previous Values.
F3 key	Optimized defaults
F4 key	Save & Exit Setup

- **Navigating Through The Menu Bar**

Use the left and right arrow keys to choose the menu you want to be in.



Note: Some of the navigation keys differ from one screen to another.

- **To Display a Sub Menu**

Use the arrow keys to move the cursor to the sub menu you want. Then press <Enter>. A “>” pointer marks all sub menus.

3.4 Getting Help

Press F1 to pop up a small help window that describes the appropriate keys to use and the possible selections for the highlighted item. To exit the Help Window press <Esc> or the F1 key again.

3.5 In Case of Problems

If, after making and saving system changes with Setup, you discover that your computer no longer is able to boot, the AMI BIOS supports an override to the NVRAM settings which resets your system to its defaults.

The best advice is to only alter settings which you thoroughly understand. To this end, we strongly recommend that you avoid making any changes to the chipset defaults. These defaults have been carefully chosen by both BIOS Vendor and your systems manufacturer to provide the absolute maximum performance and reliability. Even a seemingly small change to the chipset setup has the potential for causing you to use the override.

3.6 BIOS setup

Once you enter the Aptio Setup Utility, the Main Menu will appear on the screen. The Main Menu allows you to select from several setup functions and exit choices. Use the arrow keys to select among the items and press <Enter> to accept and enter the sub-menu.

3.6.1 Main Menu

This section allows you to record some basic hardware configurations in your computer and set the system clock.

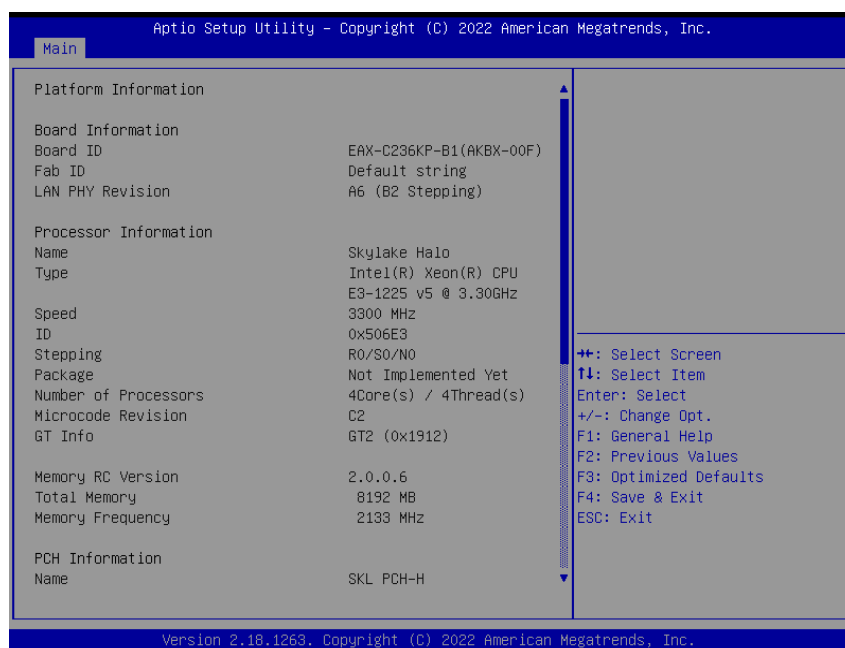

EAX-C236KP-B1 User's Manual

3.6.1.1 System Language

This option allows choosing the system default language.

3.6.1.2 System Date

Use the system date option to set the system date. Manually enter the day, month and year.

3.6.1.3 System Time

Use the system time option to set the system time. Manually enter the hours, minutes and seconds.



Note: The BIOS setup screens shown in this chapter are for reference purposes only, and may not exactly match what you see on your screen. Visit the Avalue website (www.avalue.com.tw) to download the latest product and BIOS information.

3.6.2 Advanced Menu

This section allows you to configure your CPU and other system devices for basic operation through the following sub-menus.

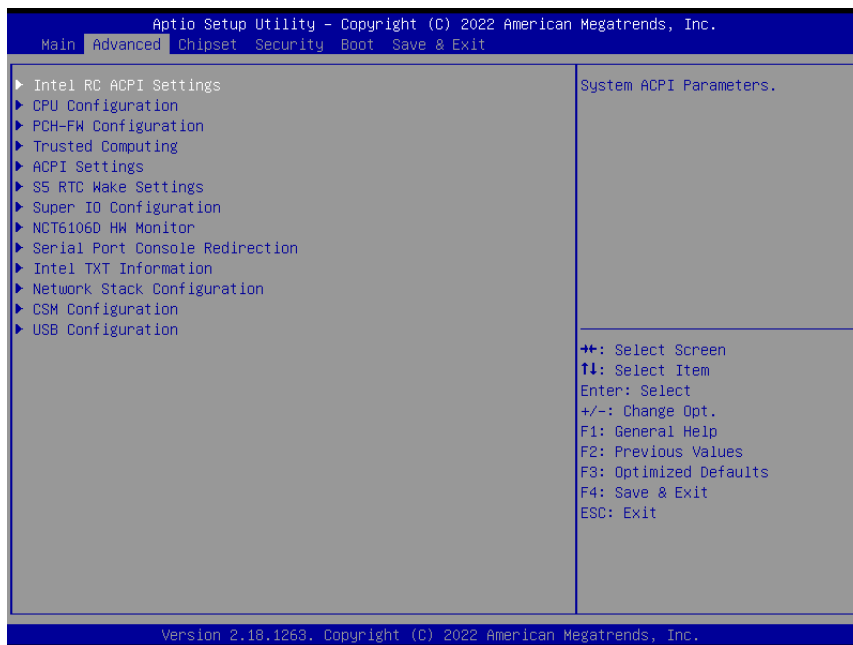

3.6.2.1 Intel RC ACPI Settings

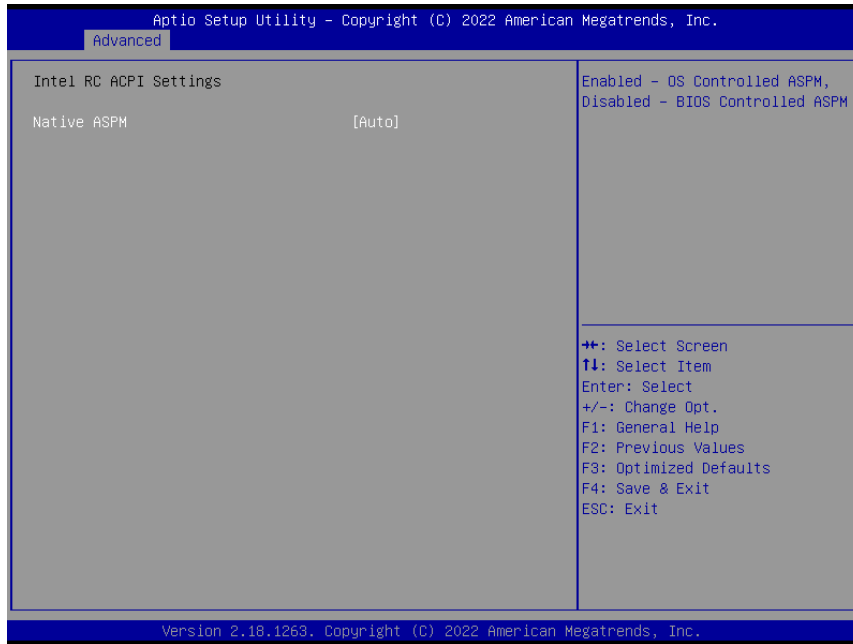

Item	Options	Description
Native ASPM	Auto[Default], Disabled Enabled	Enabled - OS Controlled ASPM, Disabled - BIOS Controlled ASPM

3.6.2.2 CPU Configuration

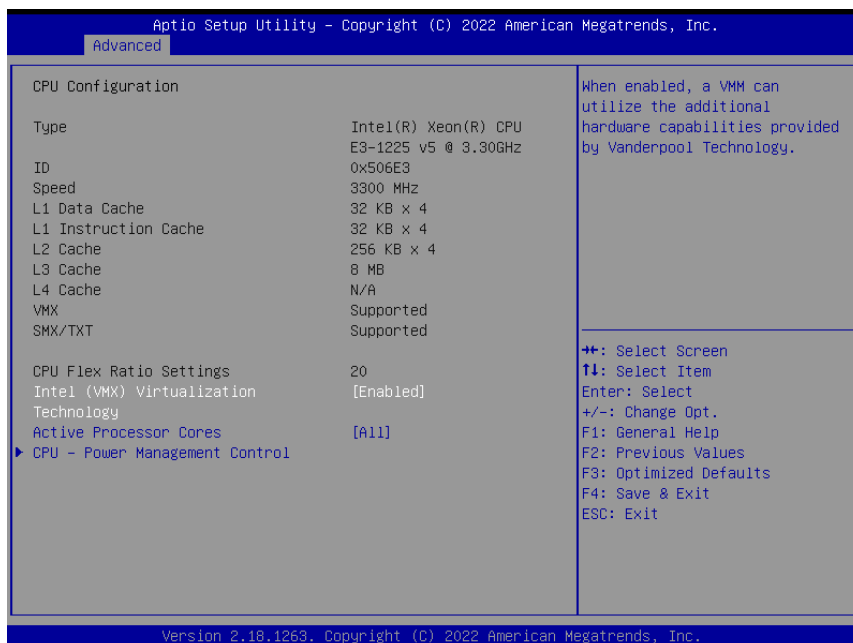

Item	Options	Description
Intel (VMX) Virtualization Technology	Disabled Enabled[Default],	When enabled, a VMM can utilize the additional hardware capabilities provided by Vanderpool Technology.

EAX-C236KP-B1 User's Manual

Active Processor Cores	All[Default], 1 2 3	Number of cores to enable in each processor package.
-------------------------------	------------------------------	--

3.6.2.2.1 CPU – Power management Control

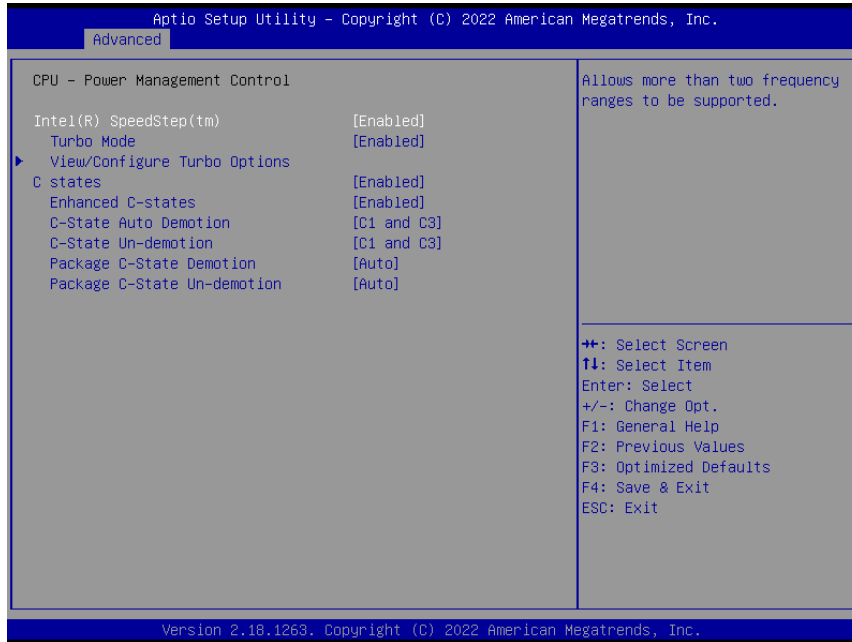

Item	Option	Description
Intel(R) SpeedStep(tm)	Disabled, Enabled[Default]	Allows more than two frequency ranges to be supported.
Turbo Mode	Disabled, Enabled[Default]	Enable/Disable processor Turbo Mode (requires EMTTM enabled too). AUTO means enabled, unless max turbo ratio is bigger than 16 – SKL A0 W/A
C states	Disabled, Enabled[Default]	Enable/Disable CPU Power Management. Allows CPU to go to C states when it's not 100% utilized.
Enhanced C-states	Disabled, Enabled[Default]	Enable/Disable C1E. When enabled, CPU will switch to minimum speed when all cores enter C-State.
C-State Auto Demotion	Disabled C1 C3 C1 and C3[Default]	Configure C-State Auto Demotion.
C-State Un-demotion	Disabled C1 C3 C1 and C3[Default]	Configure C-State Un-demotion.

<p>Package C-State Demotion</p>	<p>Disabled Enabled Auto[Default]</p>	<p>Enable or Disable Package C-State UnDemotion. 0: Disable; 1: Enable; 2: Auto (Auto: Enabled for Skylake; Disabled for Kabylake)</p>
<p>Package C-State Un-demotion</p>	<p>Disabled Enabled Auto[Default]</p>	<p>Enable or Disable Package C-State Demotion. 0: Disable; 1: Enable; 2: Auto (Auto: Enabled for Skylake; Disabled for Kabylake)</p>

3.6.2.2.1.1 View/Configure Turbo Options

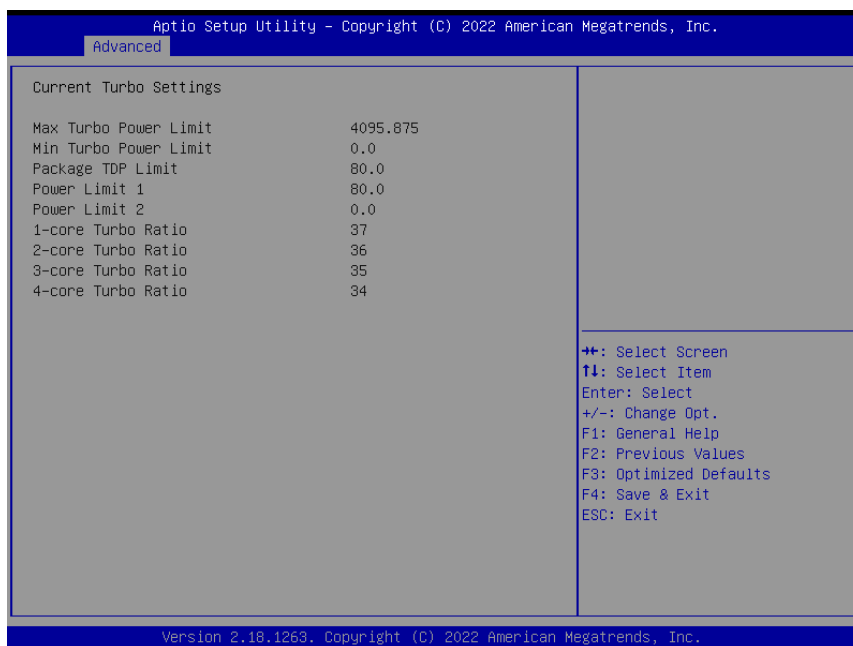

3.6.2.3 CH-FW Configuration

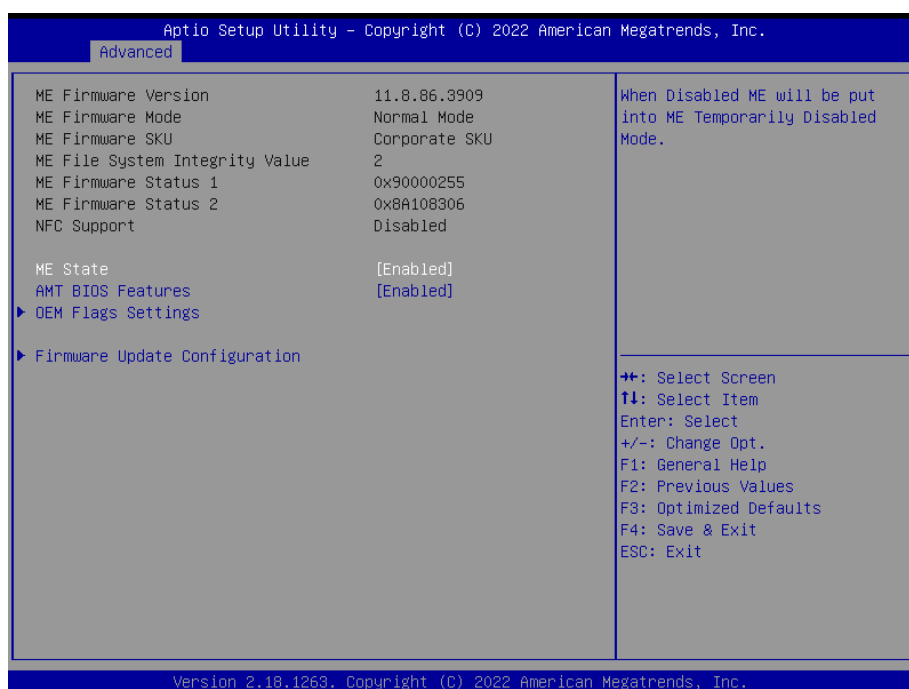

EAX-C236KP-B1 User's Manual

Item	Options	Description
ME State	Disabled, Enabled[Default]	When Disabled ME will be put into ME Temporarily Disabled Mode.
AMT BIOS Features	Disabled, Enabled[Default]	When disabled AMT BIOS Features are no longer supported and user is no longer able to access MEBx Setup. Note: This option does not disable Manageability Features in FW.

3.6.2.3.1 OEM Flags Settings



Item	Option	Description
Unconfigure ME	Disabled[Default], Enabled	OEMFlag Bit 15: Unconfigure ME with resetting MEBx password to default.

3.6.2.3.2 Firmware Update Configuration

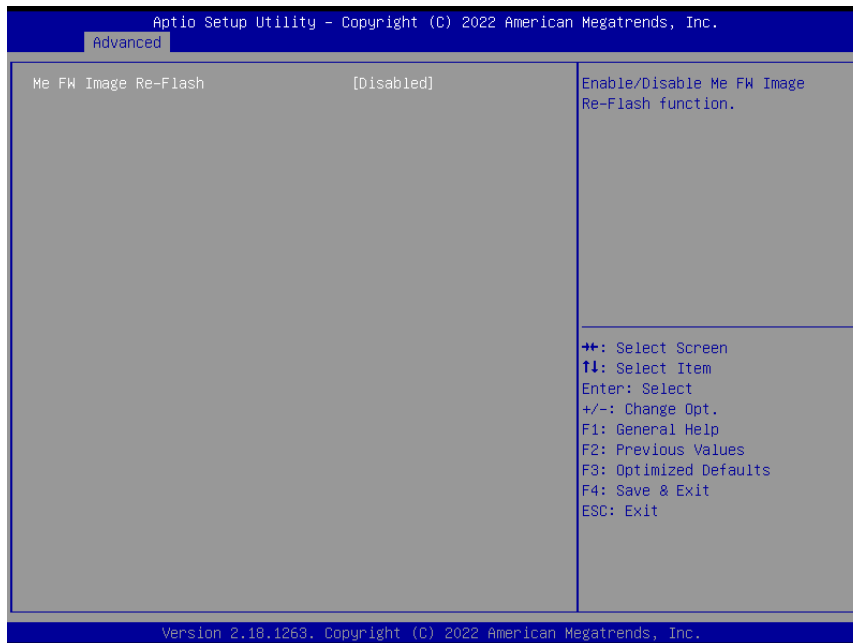

Item	Option	Description
Me FW Image Re-Flash	Disabled[Default], Enabled	Enable/Disable Me FW Image Re-Flash function.

3.6.2.4 Trusted Computing

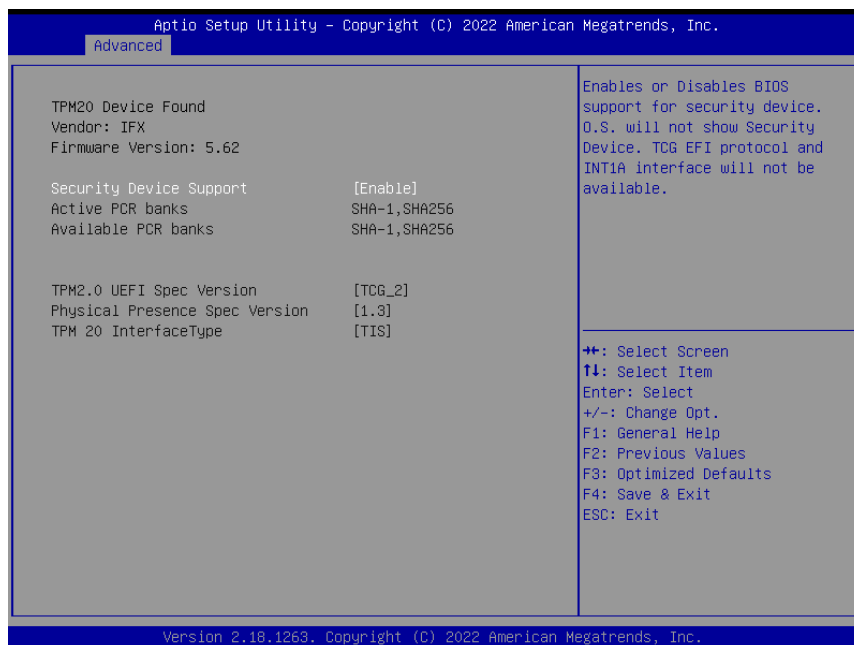

Item	Options	Description
Security Device Support	Disable, Enable[Default]	Enables or Disables BIOS support for security device. O.S. will not show Security Device. TCG EFI protocol and INT1A interface will not be available.

EAX-C236KP-B1 User's Manual

3.6.2.5 ACPI Settings

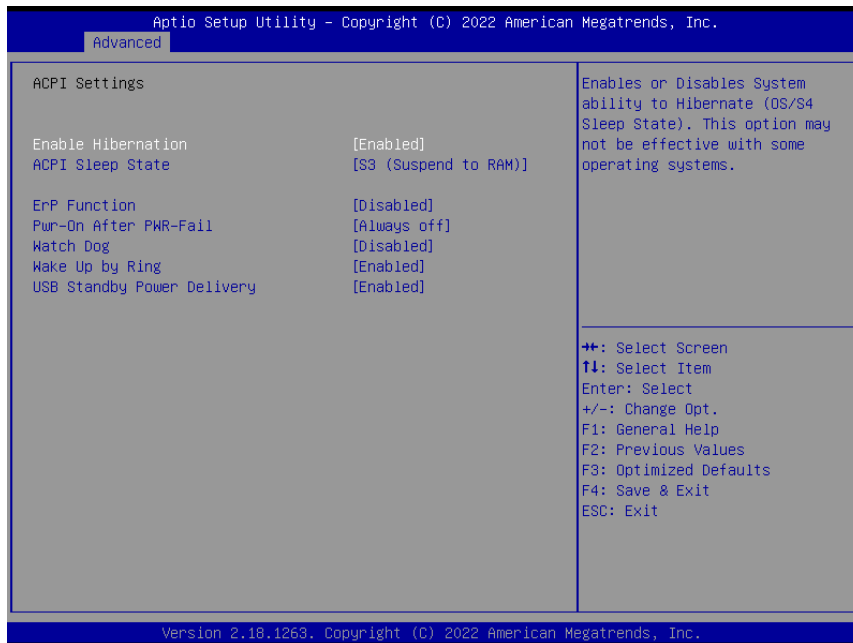

Item	Options	Description
Enable Hibernation	Disabled Enabled [Default] ,	Enables or Disables System ability to Hibernate (OS/S4 Sleep State). This option may be not effective with some operating systems.
ACPI Sleep State	Suspend Disabled, S3 (Suspend to RAM) [Default]	Select the highest ACPI sleep state the system will enter when the SUSPEDN button is pressed.
ErP Function	Disabled [Default] , Enabled	ErP (Deep S5) Function. Allow BIOS switching off peripheral power delivery at S5 state.
Pwr-On After PWR-Fail	Always Off [Default] Always On Keep Last state	Specify what state to go to when power is re-applied after a power failure (G3 state).
Watch Dog	Disabled [Default] , 30 sec 40 sec 50 sec 1 min 2 min 10 min 30 min	Select Watch Dog Timer (WDT) Mode.
Wake Up by Ring	Disabled Enabled [Default] ,	Enable/Disable system waked up by Ring signal from S3(Sleep), S4(Hibernate) and S5(Soft Off) States.
USB Standby Power Delivery	Disabled Enabled [Default] ,	Enable/Disable USB Power delivery in S3 (Sleep), S4 (Hibernate) and S5 (Soft Off) States.

3.6.2.6 S5 RTC Wake Settings

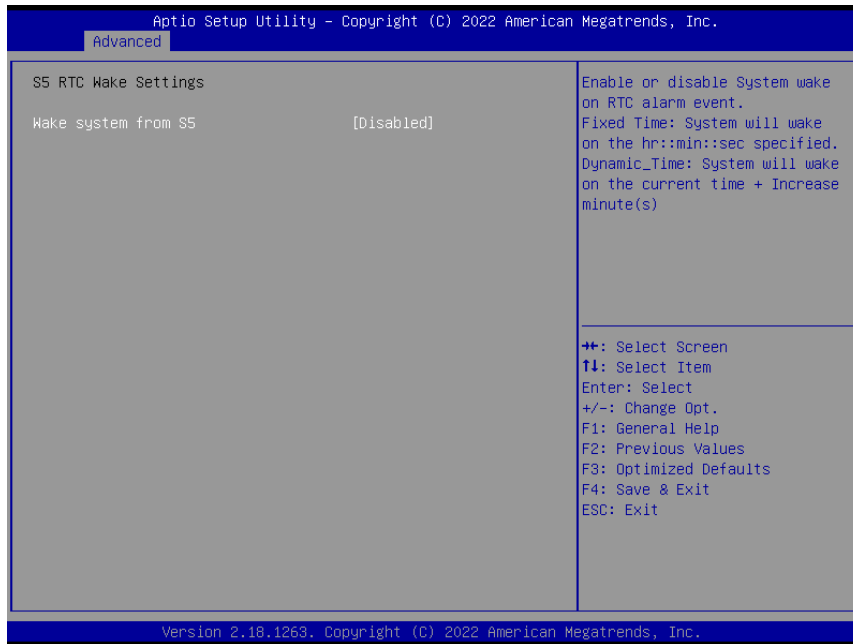

Item	Options	Description
Wake system from S5	Disabled[Default], Fixed Time Dynamic Time	Enable or disable System wake on RTC alarm event. Fixed Time: System will wake on the hr::min::sec specified. Dynamic_Time: System will wake on the current time + Increase minute(s).

3.6.2.7 Super IO Configuration

You can use this item to set up or change the Super IO configuration for serial ports. Please refer to 3.6.2.6.1~ 3.6.2.6.7 for more information.

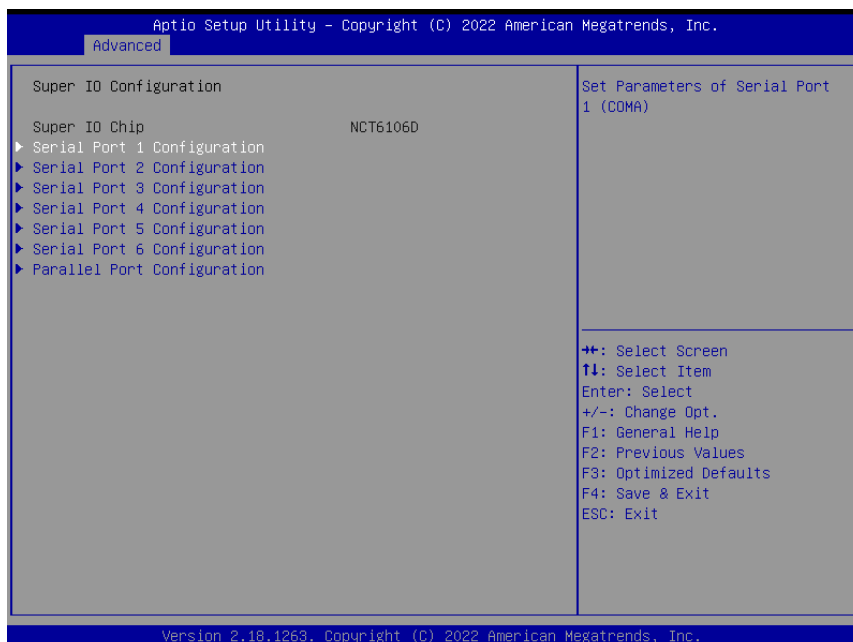

EAX-C236KP-B1 User's Manual

Item	Description
Serial Port 1 Configuration	Set Parameters of Serial Port 1 (COMA).
Serial Port 2 Configuration	Set Parameters of Serial Port 2 (COMB).
Serial Port 3 Configuration	Set Parameters of Serial Port 3 (COMC).
Serial Port 4 Configuration	Set Parameters of Serial Port 4 (COMD).
Serial Port 5 Configuration	Set Parameters of Serial Port 5 (COME).
Serial Port 6 Configuration	Set Parameters of Serial Port 6 (COMF).
Parallel Port Configuration	Set Parameters of Parallel Port (LPT/LPTE).

3.6.2.7.1 Serial Port 1 Configuration

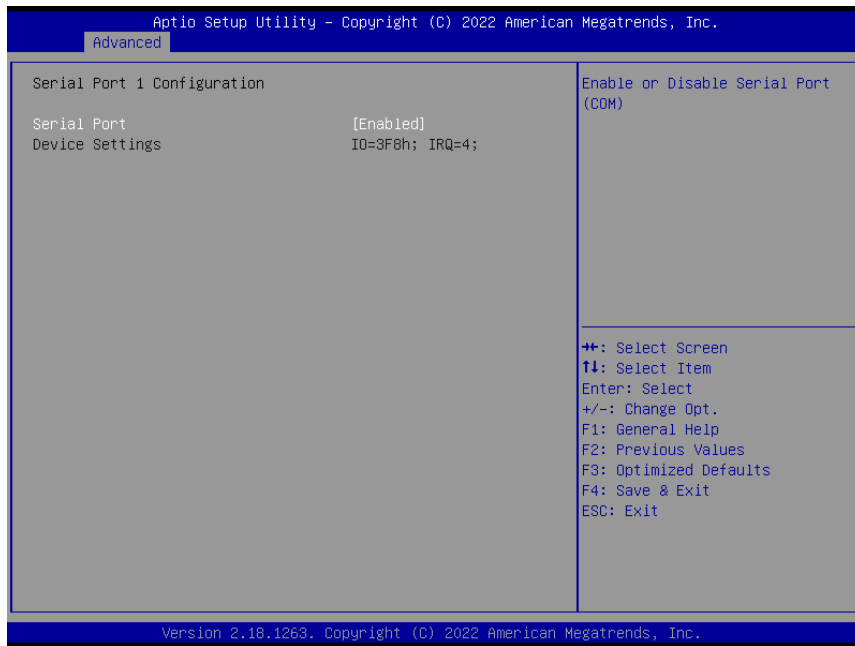

Item	Option	Description
Serial Port	Enabled [Default] , Disabled	Enable or Disable Serial Port (COM).

3.6.2.7.2 Serial Port 2 Configuration

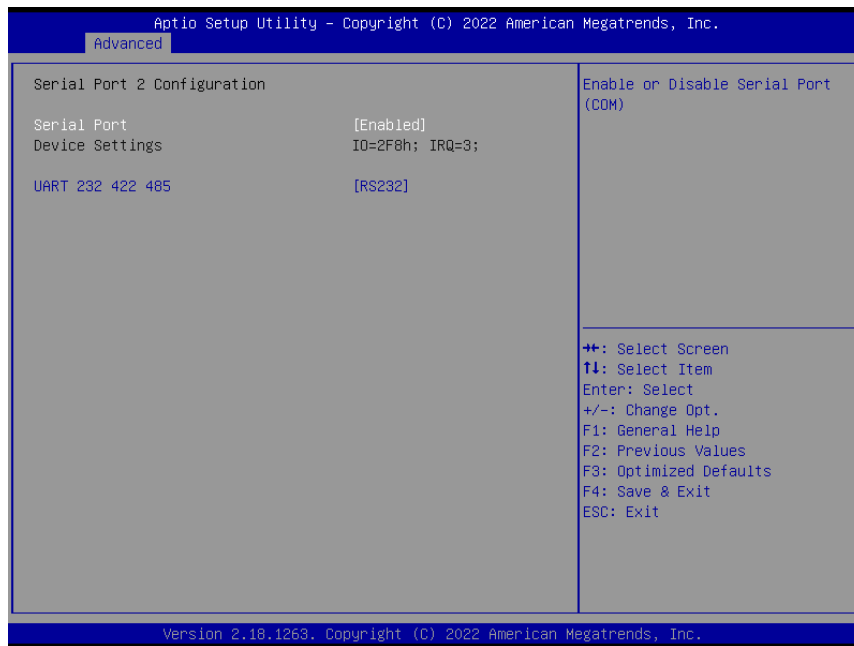

Item	Option	Description
Serial Port	Enabled[Default], Disabled	Enable or Disable Serial Port (COM).
UART 232 422 485	RS232[Default] RS422 RS485	Set COM Port as RS232, RS422 or RS485 mode.

3.6.2.7.3 Serial Port 3 Configuration

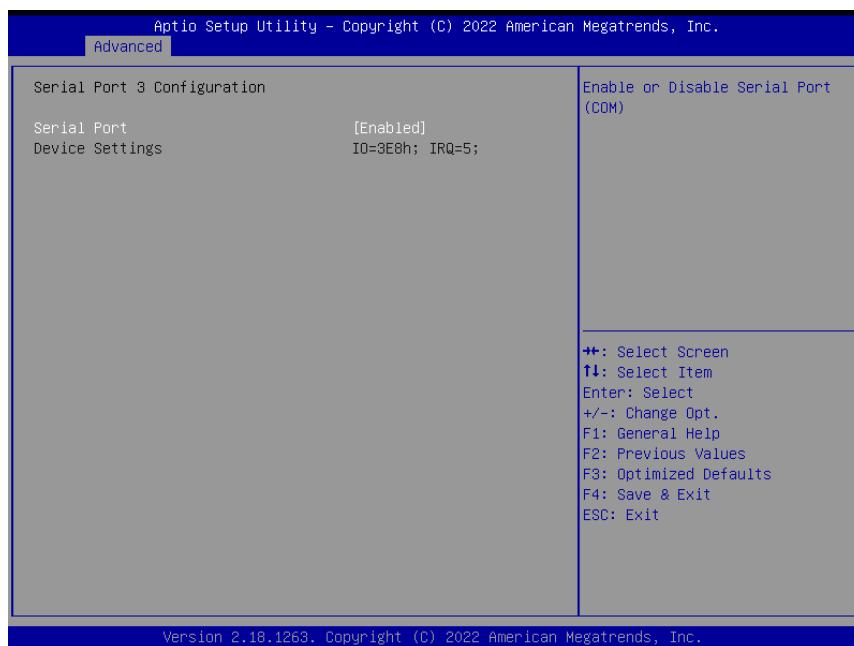

EAX-C236KP-B1 User's Manual

Item	Option	Description
Serial Port	Enabled[Default], Disabled	Enable or Disable Serial Port (COM).

3.6.2.7.4 Serial Port 4 Configuration

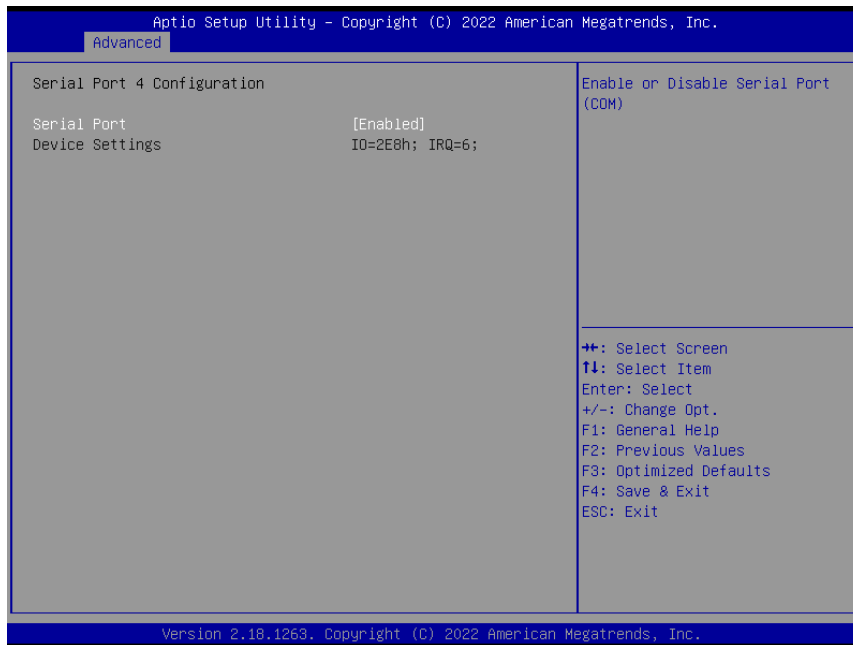

Item	Option	Description
Serial Port	Enabled[Default], Disabled	Enable or Disable Serial Port (COM).

3.6.2.7.5 Serial Port 5 Configuration

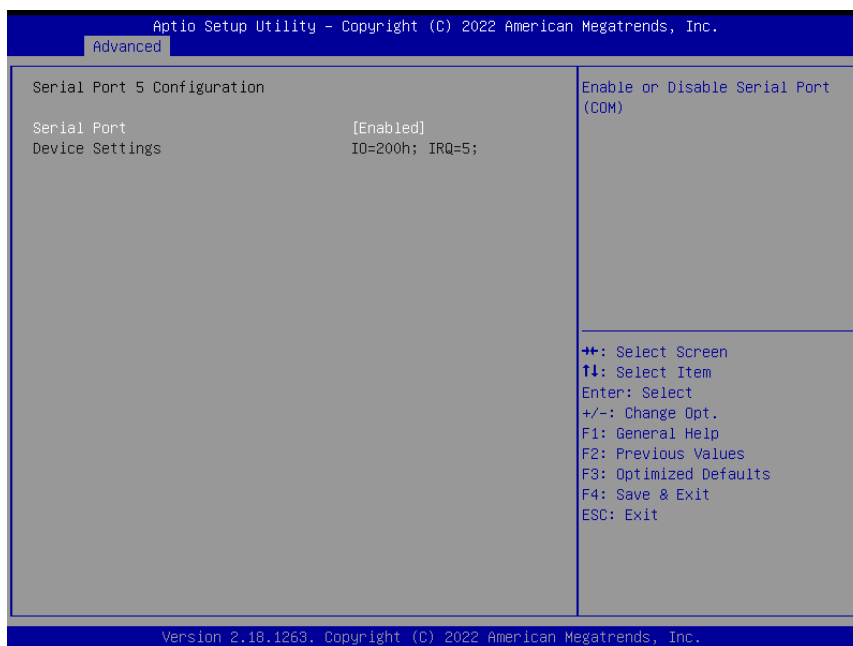

Item	Option	Description
Serial Port	Enabled[Default], Disabled	Enable or Disable Serial Port (COM).

3.6.2.7.6 Serial Port 6 Configuration

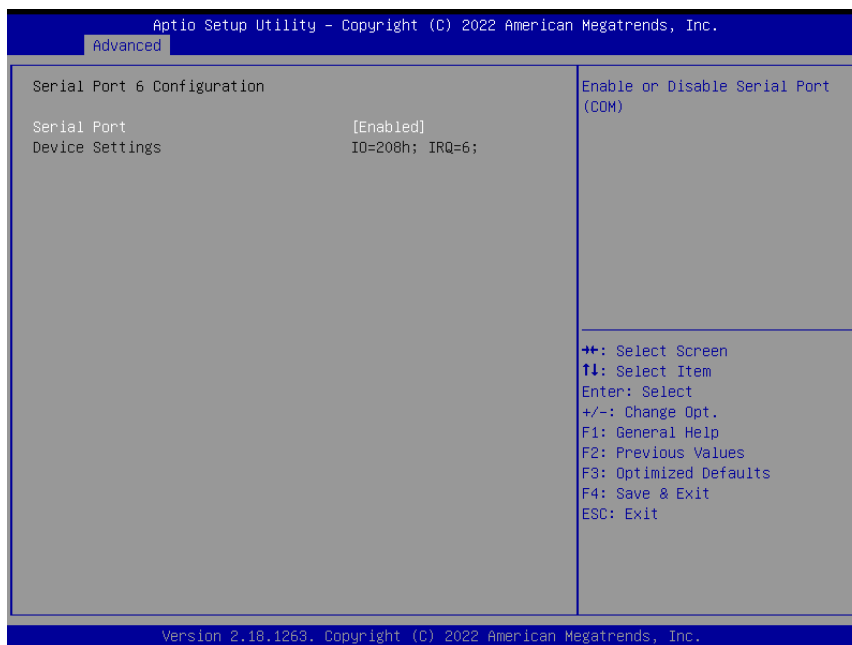

Item	Option	Description
Serial Port	Enabled[Default], Disabled	Enable or Disable Serial Port (COM).

3.6.2.7.7 Parallel Port Configuration

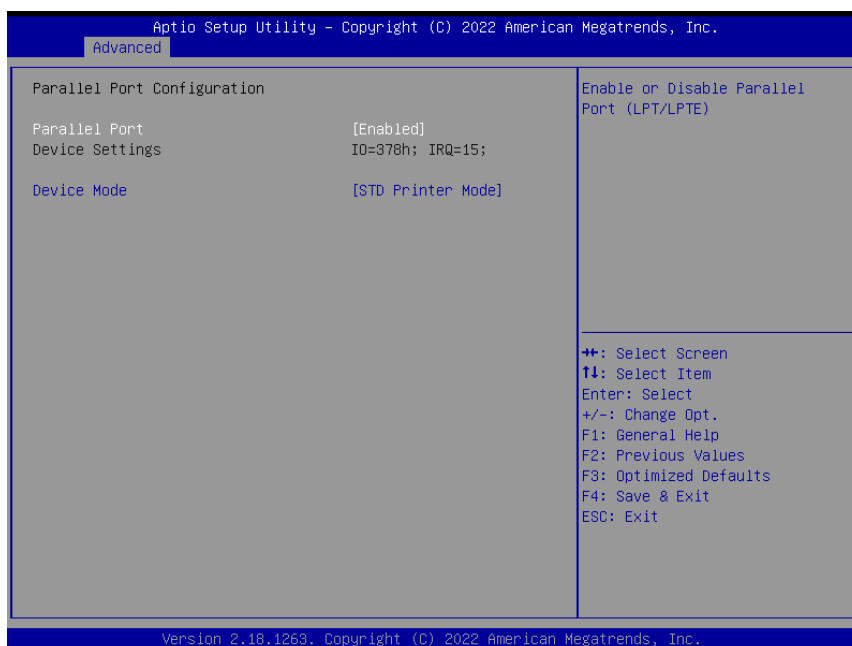

EAX-C236KP-B1 User's Manual

Item	Option	Description
Parallel Port	Enabled[Default], Disabled	Enable or Disable Parallel Port (LPT/LPTE).
Device Mode	STD Printer Mode[Default] SPP Mode EPP-1.9 and SPP Mode EPP-1.7 and SPP Mode	Change the Printer Port mode.

3.6.2.8 NCT6106D H/W Monitor

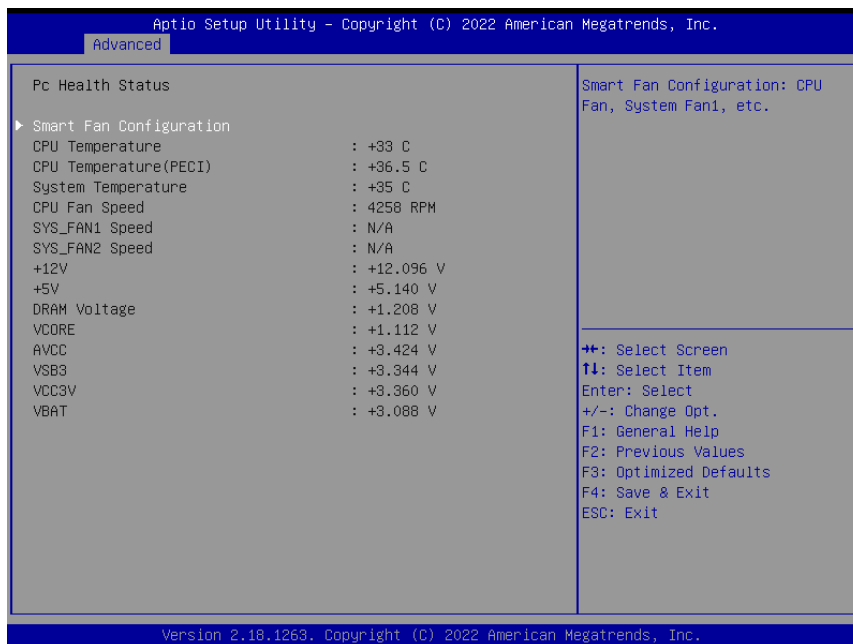

3.6.2.8.1 Smart Fan Configuration

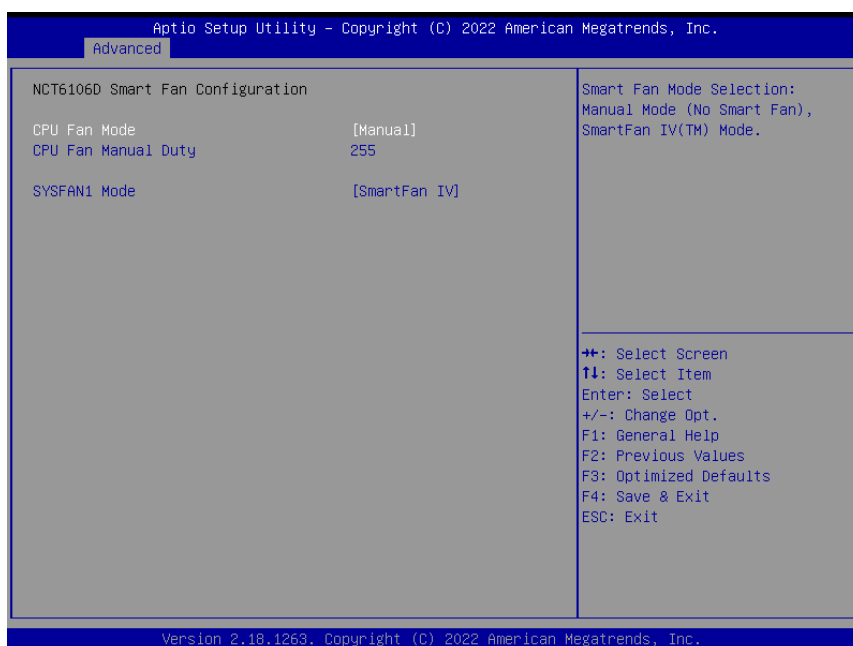

Item	Option	Description
CPU Fan Mode	Manual[Default], SmartFan IV	Smart Fan Mode Selection: Manual Mode (No Smart Fan), SmartFan IV™ Mode.
CPU Fan Manual Duty	255	CPU Fan manual output duty: 0 to 255.
SYSFAN1 Mode	Manual SmartFan IV[Default],	Smart Fan Mode Selection: Manual Mode (No Smart Fan), SmartFan IV™ Mode.

3.6.2.9 Serial Port Console Redirection

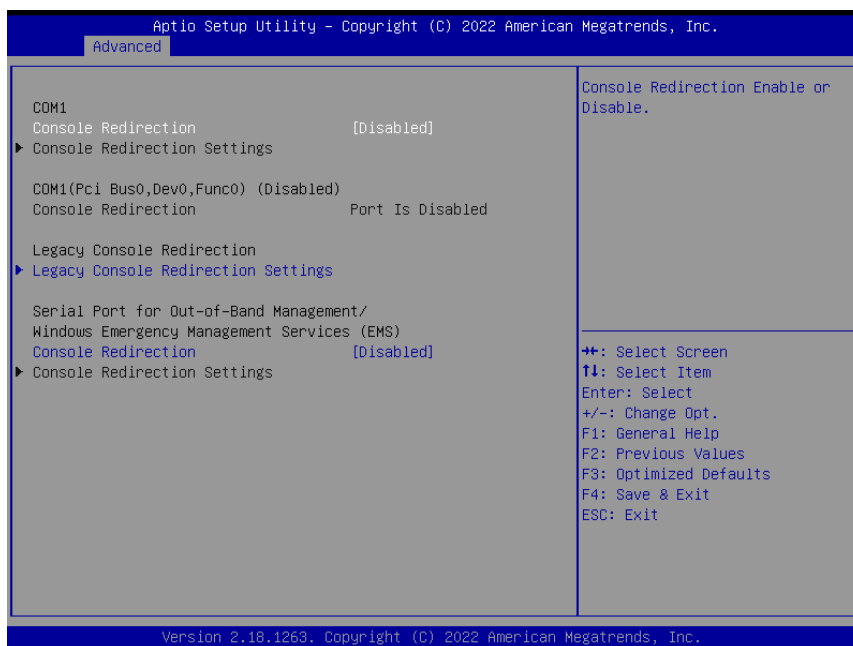

Item	Options	Description
Console Redirection	Disabled[Default], Enabled	Console Redirection Enable or Disable.

3.6.2.9.1 Legacy Console Redirection Settings

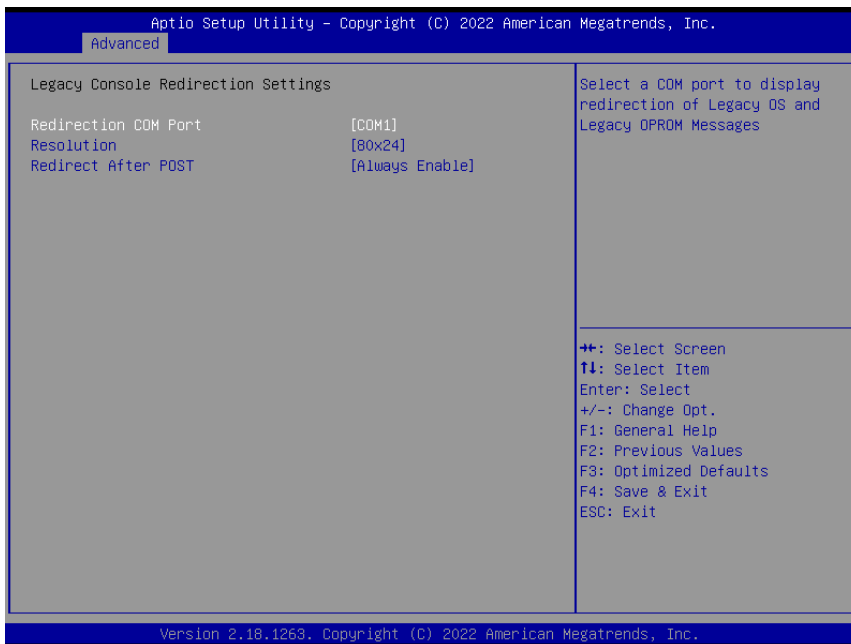

Item	Options	Description
Redirection COM Port	COM1	Select a COM port to display redirection of Legacy OS and Legacy OPRM Messages
Resolution	80X24[Default], 80X25	On Legacy OS, the Number of Rows and Columns supported redirection
Redirect After POST	Always Enable[Default], BootLoader	When Bootloader is selected, then Legacy Console Redirection is disabled before booting to legacy OS. When Always Enable is selected, then Legacy Console Redirection is enabled for legacy OS. Default setting for this option is set to Always Enable.

3.6.2.10 Intel TXT Configuration

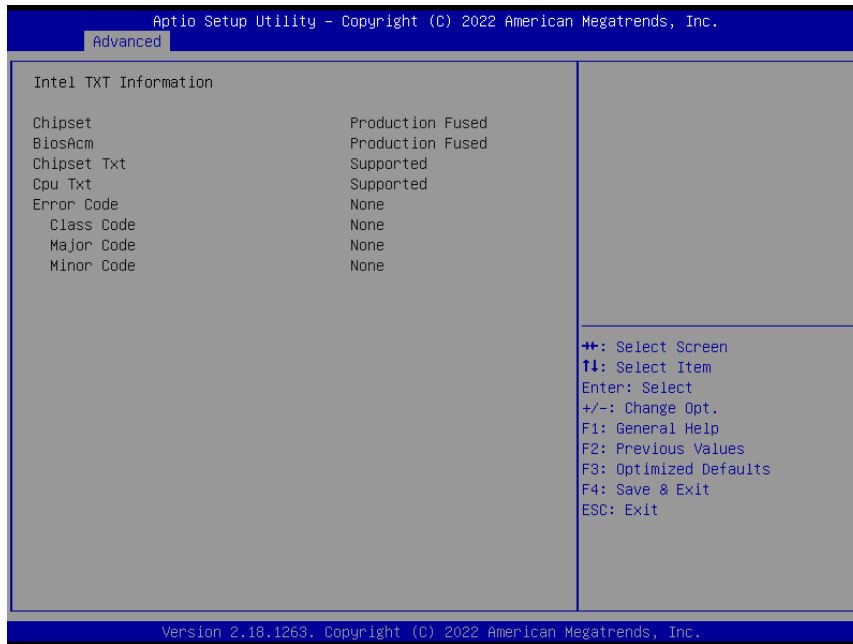

3.6.2.11 Network Stack Configuration

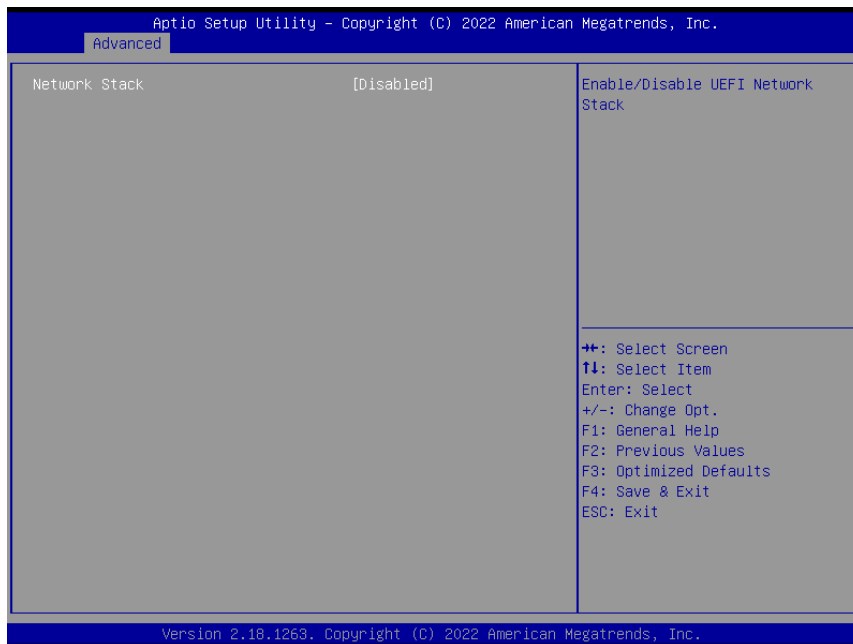

Item	Options	Description
Network Stack	Disabled[Default] Enabled	Enable/Disable UEFI Network Stack.

3.6.2.12 CSM Configuration

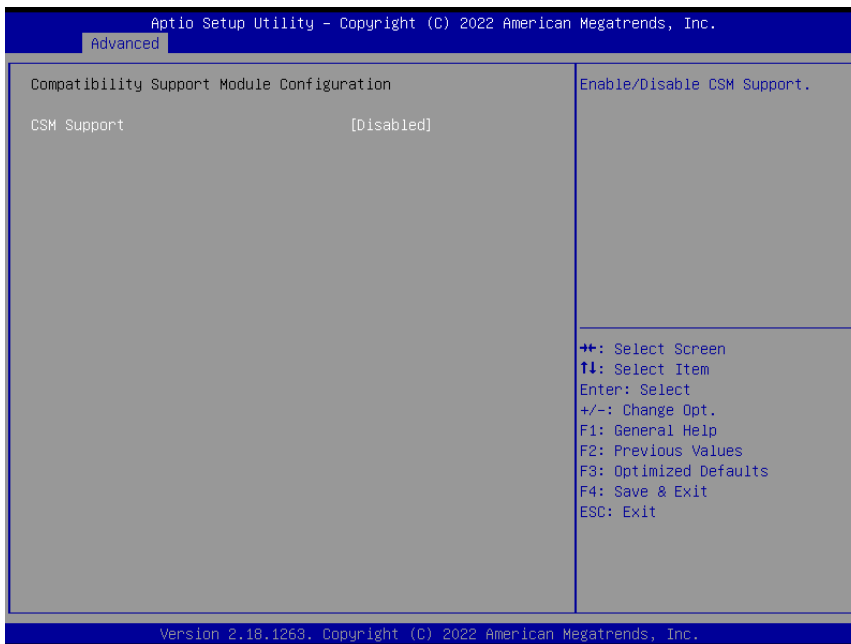

Item	Options	Description
CSM Support	Disabled[Default] Enabled	Enable/Disable CSM Support.

3.6.2.13 USB Configuration

The USB Configuration menu helps read USB information and configures USB settings.

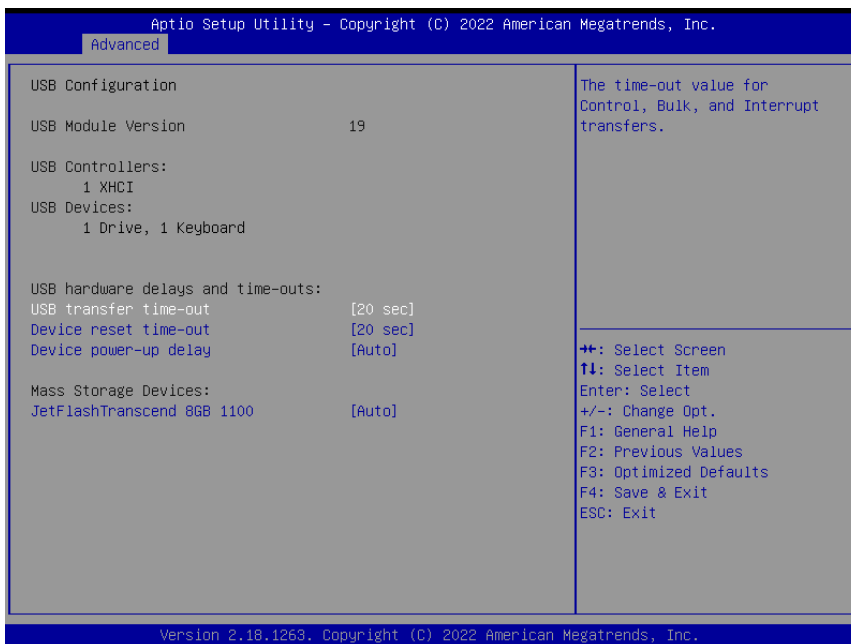

Item	Options	Description
USB transfer time-out	1 sec 5 sec 10 sec 20 sec[Default]	The time-out value for Control, Bulk, and Interrupt transfers.
Device reset time-out	10 sec 20 sec[Default] 30 sec 40 sec	USB mass storage device Start Unit command time-out.
Device power-up delay	Auto[Default] Manual	Maximum time the device will take before it properly reports itself to the Host Controller. 'Auto' uses default value: for a Root port it is 100ms, for a Hub port the delay is taken form Hub descriptor.
Mass Storage Devices	Auto[Default] Floppy Forced FDD Hard Disk CD-ROM	Mass storage device emulation type. 'AUTO' enumerates devices according to their media format. Optical drives are emulated as 'CDROM', drives with no media will be emulated according to a drive type.

3.6.3 Chipset

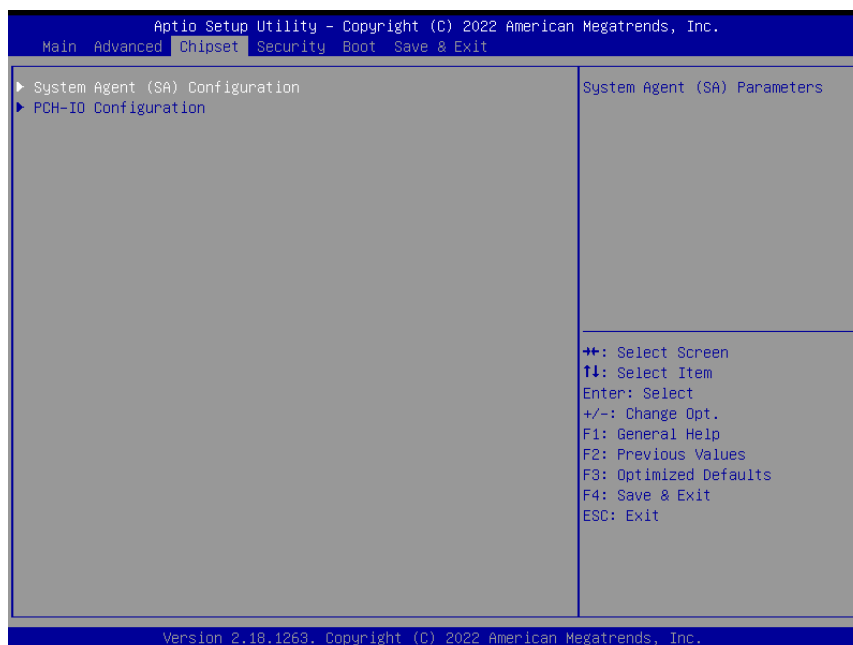

3.6.3.1 System Agent (SA) Configuration



Item	Option	Description
VT-d	Disabled Enabled[Default]	VT-d capability.

3.6.3.1.1 Memory Configuration

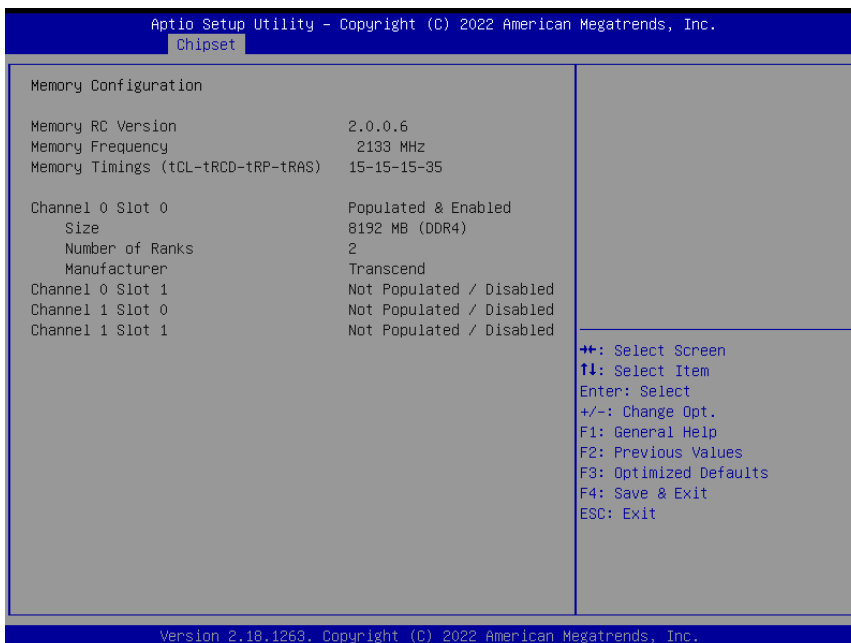

3.6.3.1.2 Graphics Configuration

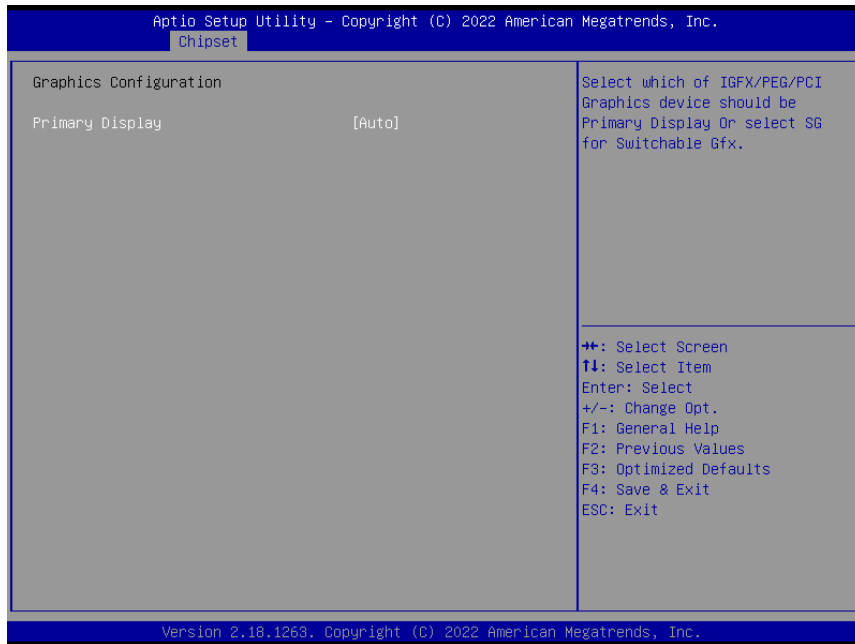

Item	Option	Description
Primary Display	Auto[Default] IGFX PEG PCIE	Select which of IGFX/PEG/PCI Graphics device should be Primary Display Or select SG for Switchable Gfx.

3.6.3.1.3 DMI/OPI Configuration



3.6.3.1.4 PEG Port Configuration

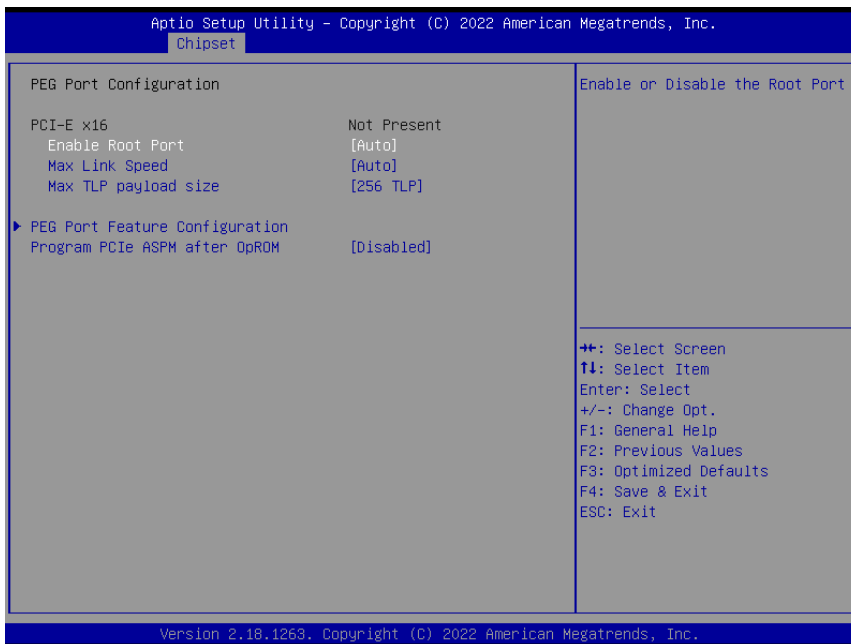

Item	Option	Description
Enable Root Port	Disabled Enabled Auto[Default]	Enable or Disable the Root Port.
Max Link Speed	Auto[Default] Gen1 Gen2 Gen3	Configure PEG 0:1:0 Max Speed.
Max TLP payload size	128 TLP 256 TLP[Default]	Select PCI Express Max Transaction Layer Packet payload size.
Program PCIe ASPM after OpROM	Disabled[Default] Enabled	Enabled: PCIe ASPM will be programmed after OpROM. Disabled: PCIe ASPM will be programmed before OpROM.

3.6.3.1.4.1 PEG Port Feature Configuration

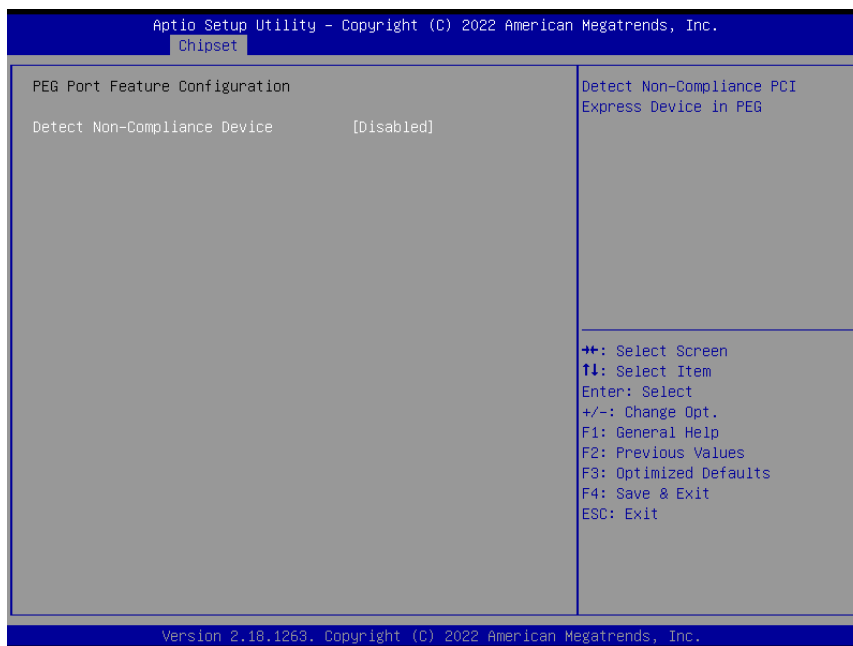

Item	Option	Description
Detect Non-Compliance Device	Disabled[Default] Enabled	Detect Non-Compliance PCI Express Device in PEG

3.6.3.2 PCH-IO Configuration

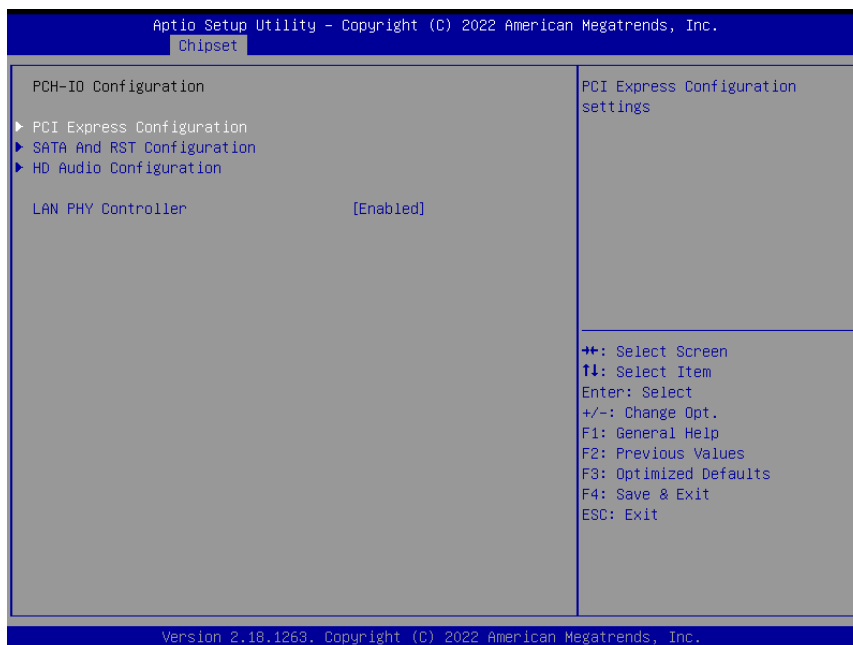

Item	Option	Description
LAN PHY Controller	Disabled Enabled[Default]	Enable or disable OnBoard PCH LAN PHY Controller.

3.6.3.2.1 PCI Express Configuration

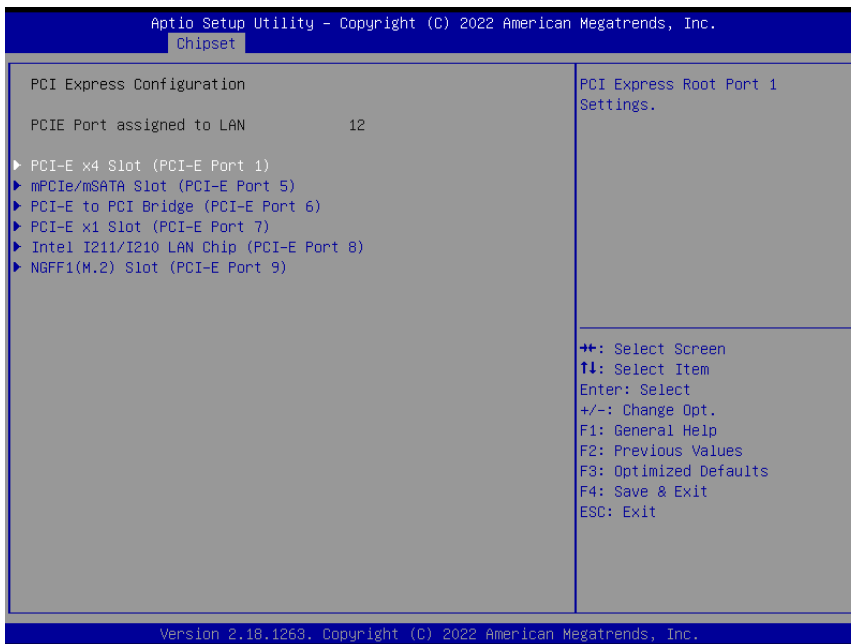

3.6.3.2.1.1 PCI-E x4 Slot (PCI-E Port 1)

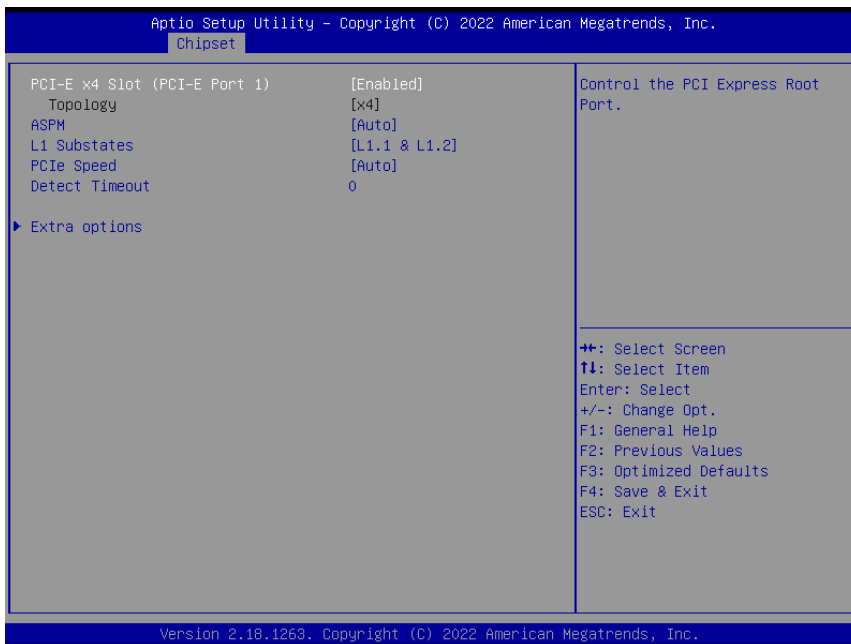

Item	Option	Description
PCIe x4 Slot (PCI-E Port 1)	Disabled Enabled[Default]	Control the PCI Express Root Port.
ASPM	Auto[Default] L0sL1 L1 L0s Disabled	Set the ASPM Level: Force L0s – Force all links to L0s State AUTO – BIOS auto configure DISABLE – Disables ASPM.

L1 Substates	Disabled[Default] L1.1 L1.2 L1.1 & L1.2	PCI Express L1 Substates settings.
PCIe Speed	Auto[Default] Gen1 Gen2 Gen3	Configure PCIe Speed.
Detect Timeout	0	The number of milliseconds reference code will wait for link to exit Detect state for enabled ports before assuming there is no device and potentially disabling the port.

3.6.3.2.1.1.1 Extra options

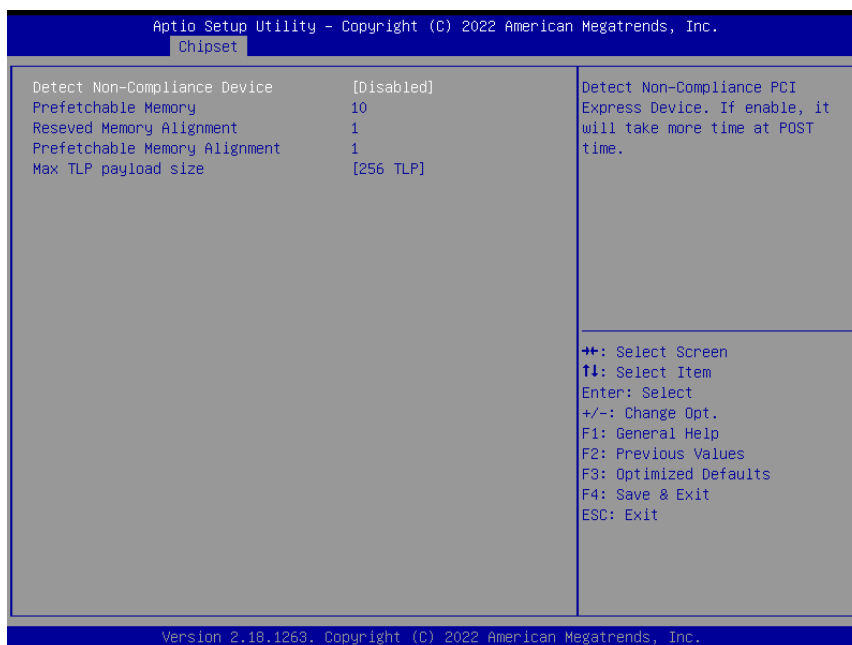

Item	Option	Description
Detect Non-Compliance Device	Disabled[Default] Enabled	Detect Non-Compliance PCI Express Device. If enable, it will take more time at POST time
Prefetchable Memory	10	Prefetchable Memory Range for this Root Bridge.
Reseved Memory Alignment	1	Reseved Memory Alignment (0 - 31 bits)
Prefetchable Memory Alignment	1	Prefetchable Memory Alignment (0 - 31 bits)
Max TLP payload size	128 TLP 256 TLP[Default]	Select PCI Express Max Transaction Layer Packet payload size.

3.6.3.2.1.2 mPCIe/mSATA Slot (PCI-E Port 5)

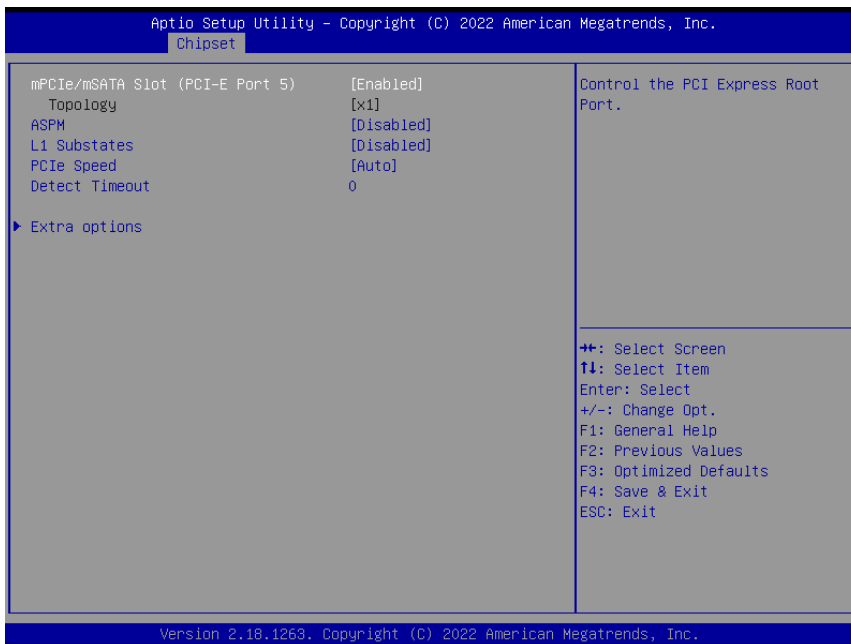

Item	Option	Description
mPCIe/mSATA Slot (PCI-E Port 5)	Disabled Enabled[Default]	Control the PCI Express Root Port.
ASPM	Disabled [Default] L0s Auto	Set the ASPM Level: Force L0s – Force all links to L0s State AUTO – BIOS auto configure DISABLE – Disables ASPM.
L1 Substates	Disabled[Default] L1.1 L1.2 L1.1 & L1.2	PCI Express L1 Substates settings.
PCIe Speed	Auto[Default] Gen1 Gen2	Configure PCIe Speed.
Detect Timeout	0	The number of milliseconds reference code will wait for link to exit Detect state for enabled ports before assuming there is no device and potentially disabling the port.

3.6.3.2.1.2.1 Extra options

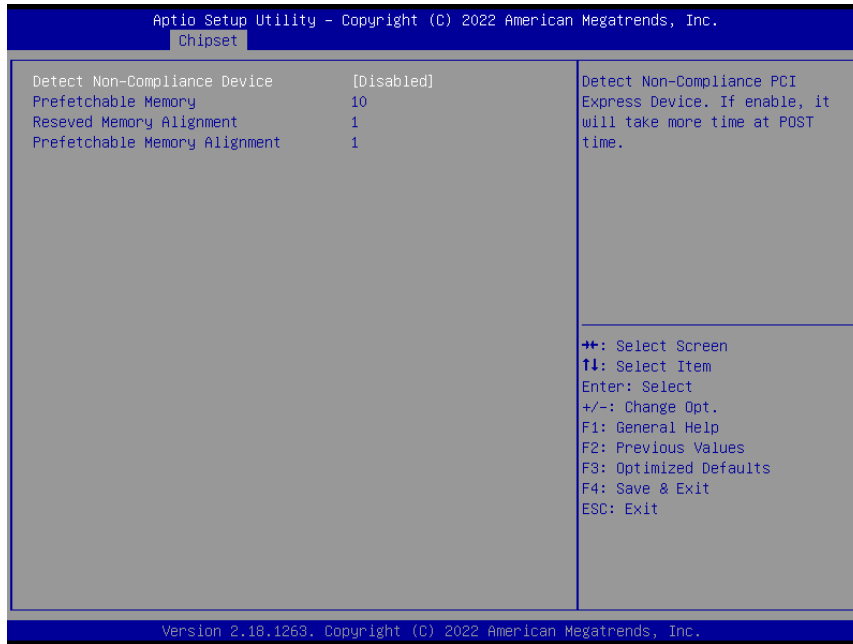

Item	Option	Description
Detect Non-Compliance Device	Disabled[Default] Enabled	Detect Non-Compliance PCI Express Device. If enable, it will take more time at POST time
Prefetchable Memory	10	Prefetchable Memory Range for this Root Bridge.
Reseved Memory Alignment	1	Reseved Memory Alignment (0 - 31 bits)
Prefetchable Memory Alignment	1	Prefetchable Memory Alignment (0 - 31 bits)

3.6.3.2.1.3 PCI-E to PCI Bridge (PCI-E Port 6)



EAX-C236KP-B1 User's Manual

Item	Option	Description
PCI-E to PCI Bridge (PCI-E Port 6)	Disabled[Default] Enabled	Control the PCI Express Root Port.

3.6.3.2.1.4 PCI-E x1 Slot (PCI-E Port 7)

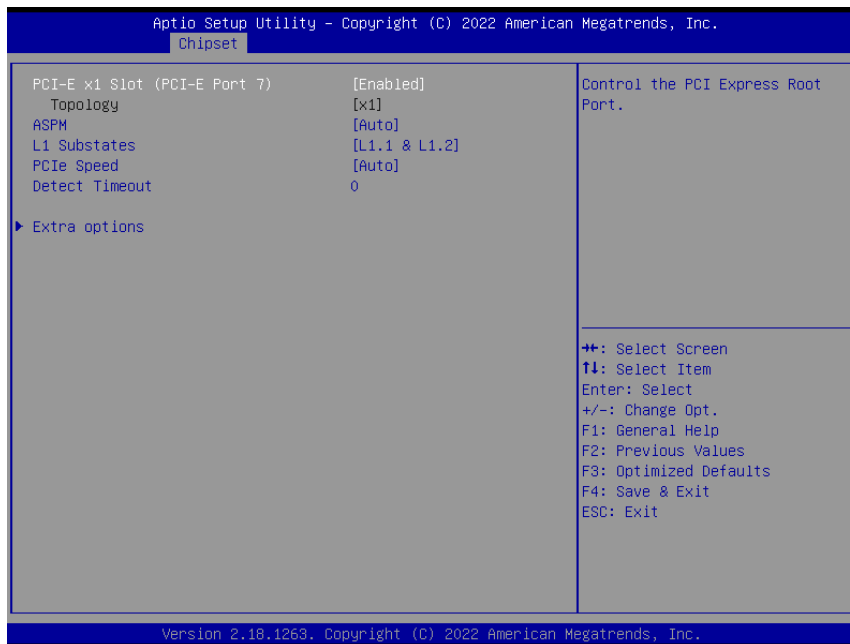

Item	Option	Description
PCI-E x1 Slot (PCI-E Port 7)	Disabled Enabled[Default]	Control the PCI Express Root Port.
ASPM	Auto[Default] L0sL1 L1 L0s Disabled	Set the ASPM Level: Force L0s – Force all links to L0s State AUTO – BIOS auto configure DISABLE – Disables ASPM.
L1 Substates	Disabled[Default] L1.1 L1.2 L1.1 & L1.2	PCI Express L1 Substates settings.
PCIe Speed	Auto[Default] Gen1 Gen2 Gen3	Configure PCIe Speed.
Detect Timeout	0	The number of milliseconds reference code will wait for link to exit Detect state for enabled ports before assuming there is no device and potentially disabling the port.

3.6.3.2.1.4.1 Extra options

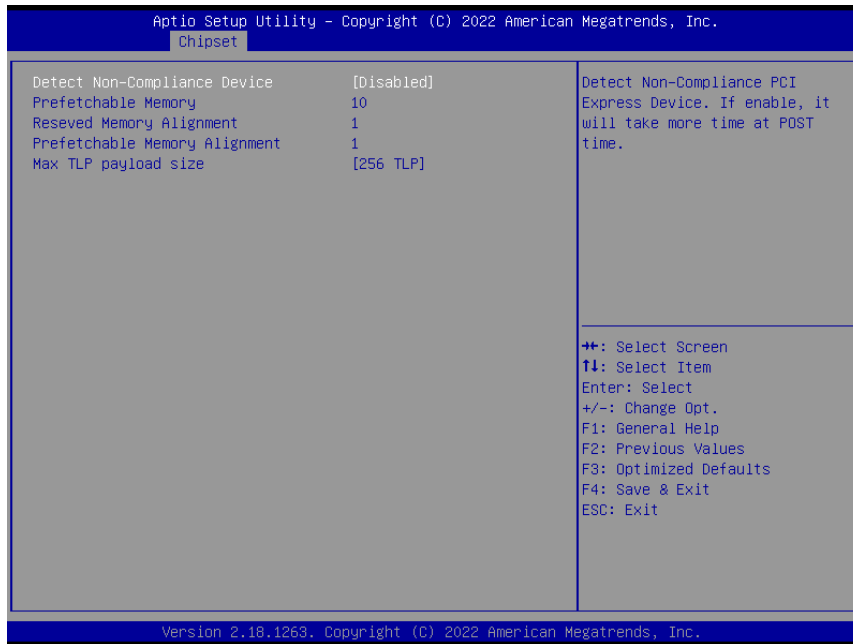

Item	Option	Description
Detect Non-Compliance Device	Disabled [Default] Enabled	Detect Non-Compliance PCI Express Device. If enable, it will take more time at POST time
Prefetchable Memory	10	Prefetchable Memory Range for this Root Bridge.
Reseved Memory Alignment	1	Reseved Memory Alignment (0 - 31 bits)
Prefetchable Memory Alignment	1	Prefetchable Memory Alignment (0 - 31 bits)
Max TLP payload size	128 TLP 256 TLP [Default]	Select PCI Express Max Transaction Layer Packet payload size.

3.6.3.2.1.5 Intel I211 LAN Chip (PCI-E Port 8)



Item	Option	Description
Intel I211/I210 LAN Chip (PCI-E Port 8)	Disabled Enabled[Default]	Control the PCI Express Root Port.

3.6.3.2.1.6 NGFF1(M.2) Slot (PCI-E Port 9)

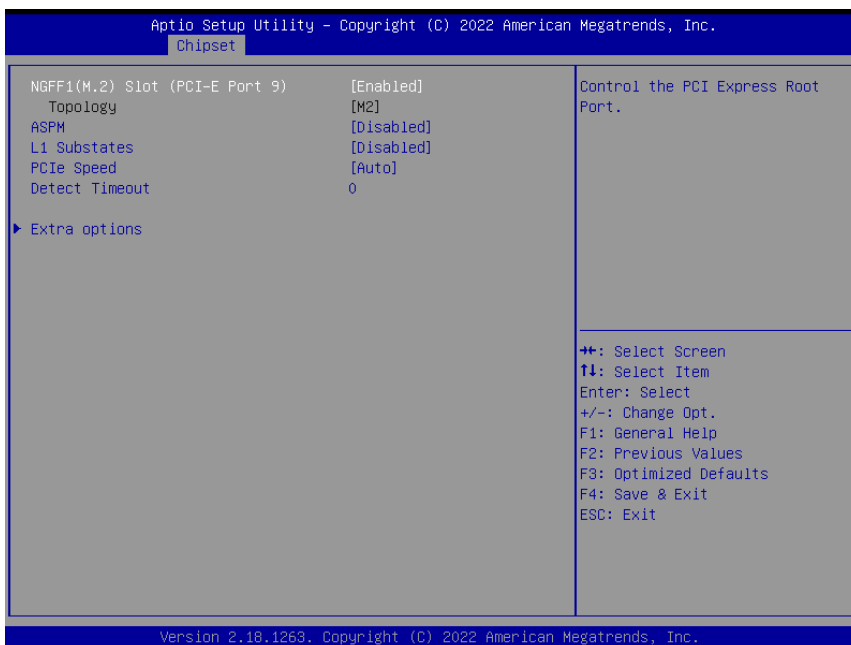

Item	Option	Description
NGFF1(M.2) Slot (PCI-E Port 9)	Disabled Enabled[Default]	Control the PCI Express Root Port.

ASPM	Auto[Default] L0sL1 L1 L0s Disabled	Set the ASPM Level: Force L0s – Force all links to L0s State AUTO – BIOS auto configure DISABLE – Disables ASPM.
L1 Substates	Disabled[Default] L1.1 L1.2 L1.1 & L1.2	PCI Express L1 Substates settings.
PCIe Speed	Auto[Default] Gen1 Gen2 Gen3	Configure PCIe Speed.
Detect Timeout	0	The number of milliseconds reference code will wait for link to exit Detect state for enabled ports before assuming there is no device and potentially disabling the port.

3.6.3.2.1.6.1 Extra options

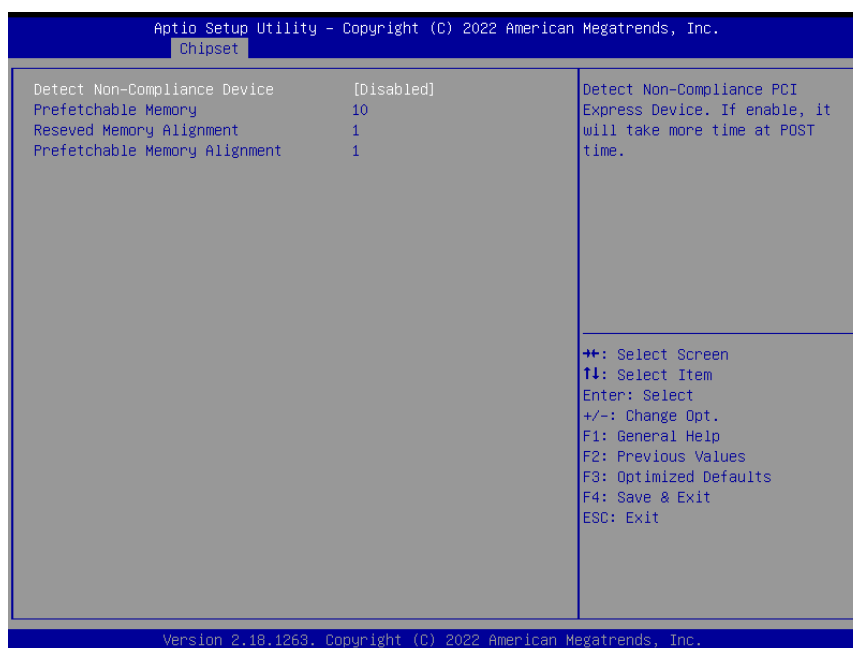

Item	Option	Description
Detect Non-Compliance Device	Disabled[Default] Enabled	Detect Non-Compliance PCI Express Device. If enable, it will take more time at POST time
Prefetchable Memory	10	Prefetchable Memory Range for this Root Bridge.
Reseved Memory Alignment	1	Reseved Memory Alignment (0 - 31 bits)
Prefetchable Memory Alignment	1	Prefetchable Memory Alignment (0 - 31 bits)

3.6.3.2.2 SATA And RST Configuration

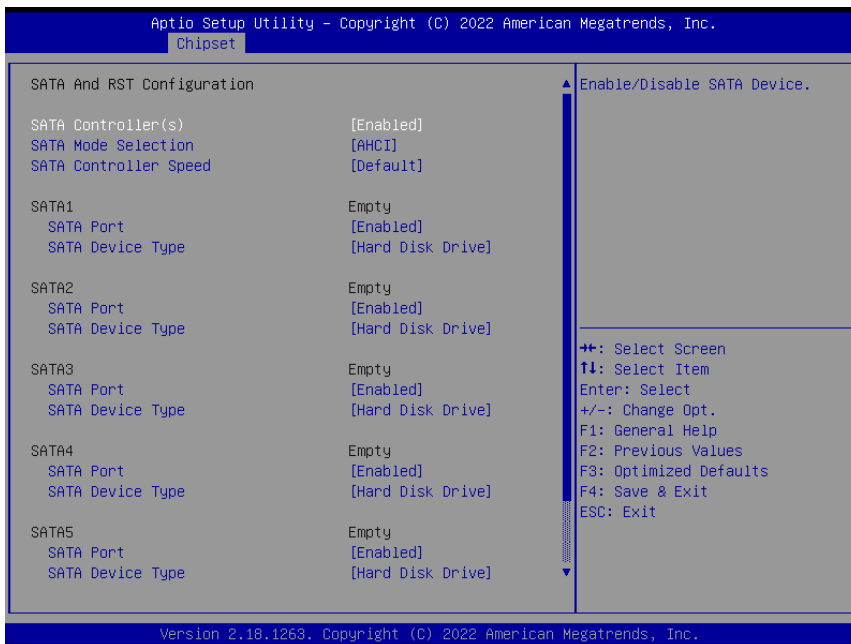

Item	Option	Description
SATA Controller(s)	Enabled[Default], Disabled	Enable/Disable SATA Device.
SATA Mode Selection	AHCI[Default], RAID	Determines how SATA controller(s) operate.
SATA Controller Speed	Default[Default], Gen1, Gen2, Gen3	Indicates the maximum speed the SATA controller can support.
SATA Port	Disabled, Enabled[Default]	Enable or Disable SATA Port.
SATA Device Type	Hard Disk Drive[Default], Solid State Drive	Identify the SATA port is connected to Solid State Drive or Hard Disk Drive.

3.6.3.2.3 HD Audio Configuration

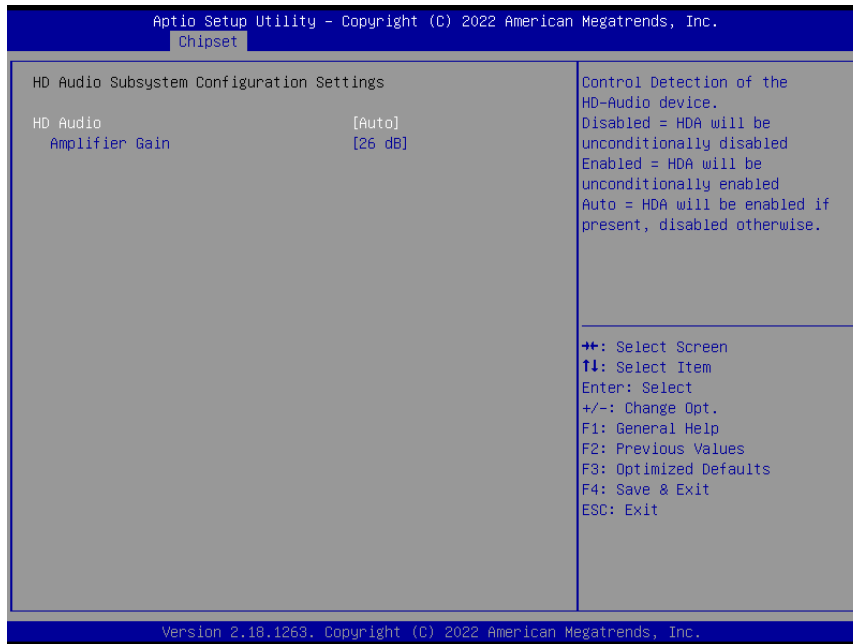

Item	Option	Description
HD Audio	Disabled Enabled, Auto[Default]	Control Detection of the HD-Audio device. Disabled = HDA will be unconditionally disabled Enabled = HDA will be unconditionally enabled Auto = HDA will be enabled if present, disabled otherwise.
Amplifier Gain	20 dB 26 dB[Default], 32 dB 36 dB	Select Amplifier Gain(dB).

3.6.4 Security



- **Administrator Password**

Set setup Administrator Password

- **User Password**

Set User Password

3.6.4.1 Secure Boot menu

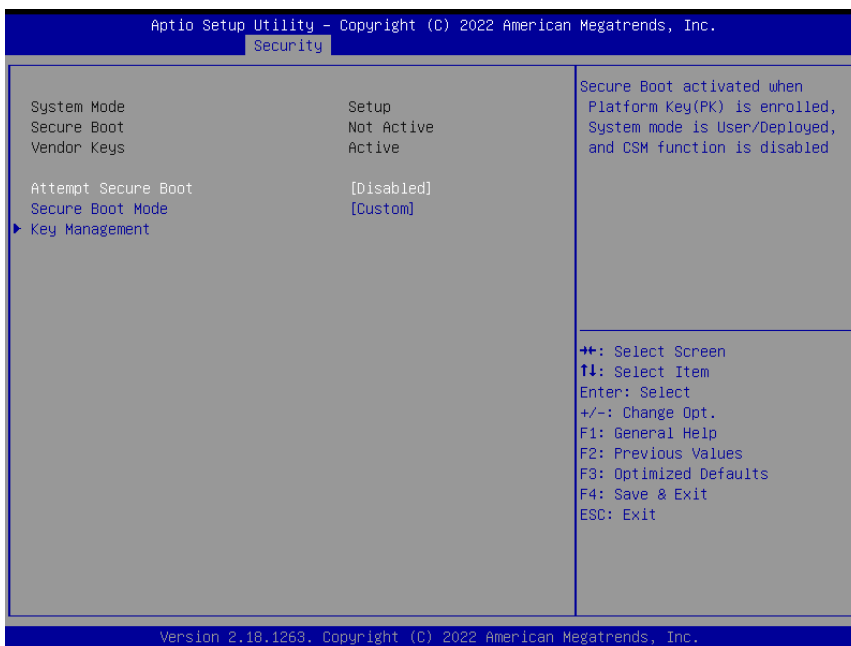

Item	Option	Description
Attempt Secure Boot	Disabled[Default] Enabled	Secure Boot activated when Platform Key(PK) is enrolled, System mode is User/Deployed, and CSM function is disabled.
Secure Boot Mode	Standard Custom[Default]	Secure Boot mode selector. 'Custom' Mode enables users to change Image Execution policy and manage Secure Boot Keys.

3.6.4.1.1 Key Management

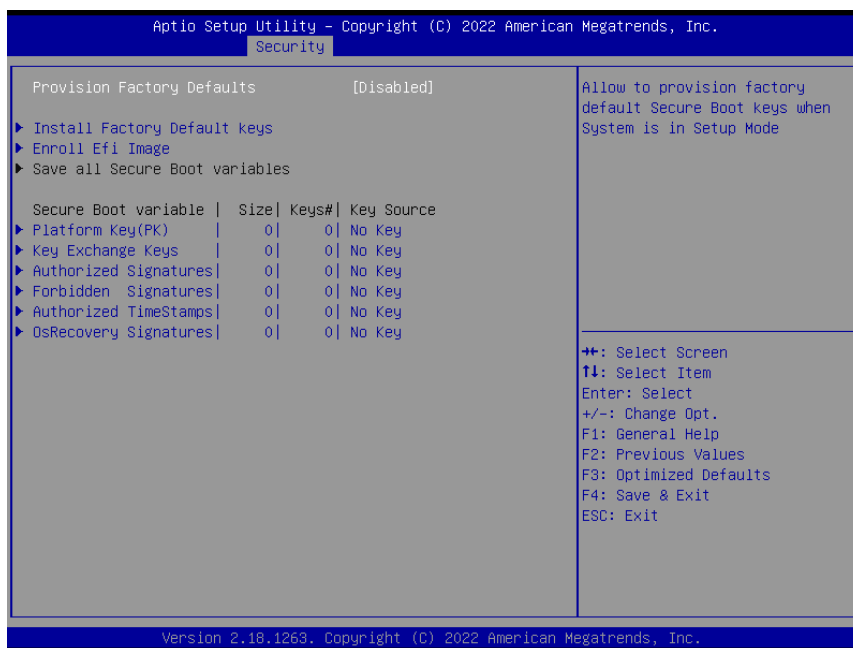

Item	Option	Description
Provision Factory Defaults	Enabled, Disabled[Default]	Allow to provision factory default Secure Boot keys when System is in Setup Mode.

3.6.5 Boot

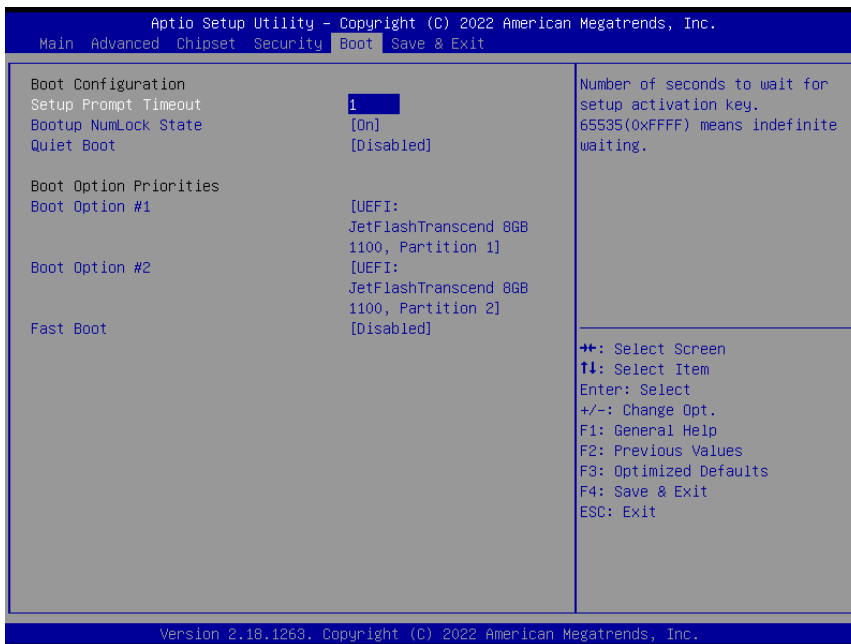

Item	Option	Description
Setup Prompt Timeout	1~ 65535	Number of seconds to wait for setup activation key. 65535(0xFFFF) means indefinite waiting.
Bootup NumLock State	On[Default] Off	Select the keyboard NumLock state
Quiet Boot	Disabled[Default] Enabled	Enables or disables Quiet Boot option
Fast Boot	Disabled[Default] Enabled	Enables or disables boot with initialization of a minimal set of devices required to launch active boot option. Has no effect for BBS boot options.
Boot Option #1	Set the system boot order.	

3.6.6 Save and exit

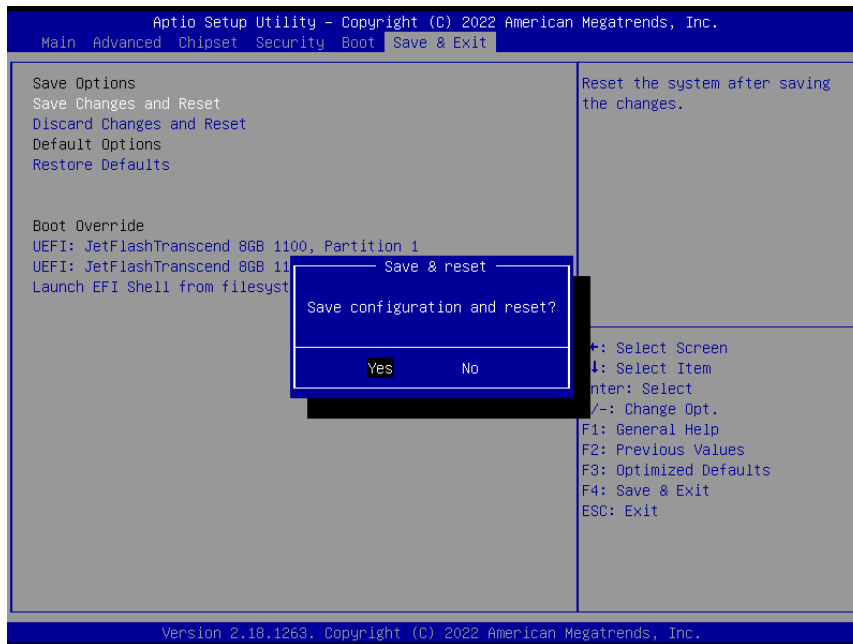
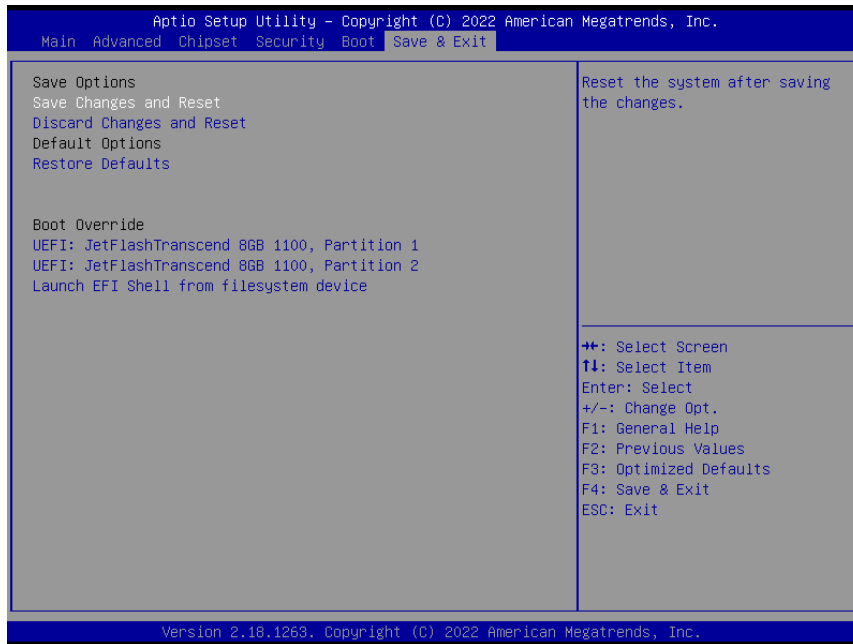

3.6.6.1 Save Changes and Reset

Reset the system after saving the changes.

3.6.6.2 Discard Changes and Reset

Any changes made to BIOS settings during this session of the BIOS setup program are discarded. The setup program then exits and reboots the controller.

EAX-C236KP-B1 User's Manual

3.6.6.3 *Restore Defaults*

This option restores all BIOS settings to the factory default. This option is useful if the controller exhibits unpredictable behavior due to an incorrect or inappropriate BIOS setting.

3.6.6.4 *Launch EFI Shell from filesystem device*

Attempts to Launch EFI Shell application (Shellx64.efi) from one of the available filesystem devices.

4. Drivers Installation



Note: Installation procedures and screen shots in this section are for your reference and may not be exactly the same as shown on your screen.

4.1 Install Chipset Driver

All drivers can be found on the Avalue Official Website:

<http://www.avalue.com.tw>.



Note: The installation procedures and screen shots in this section are based on Windows 10 operation system.

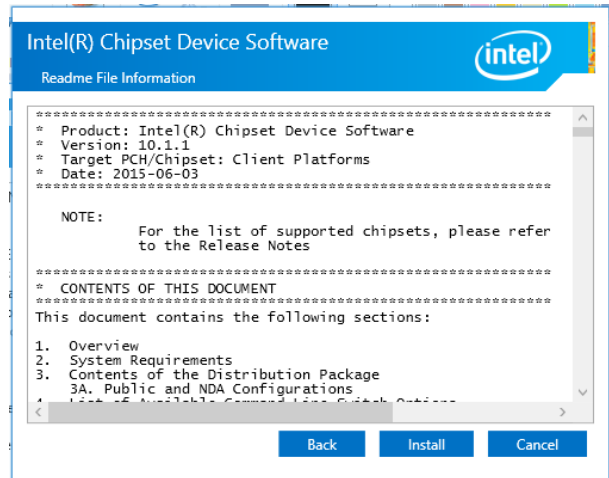

Step 3. Click Install.

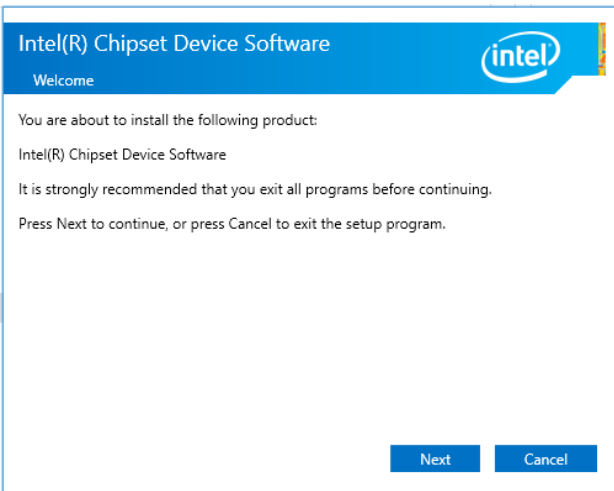

Step1. Click Next.

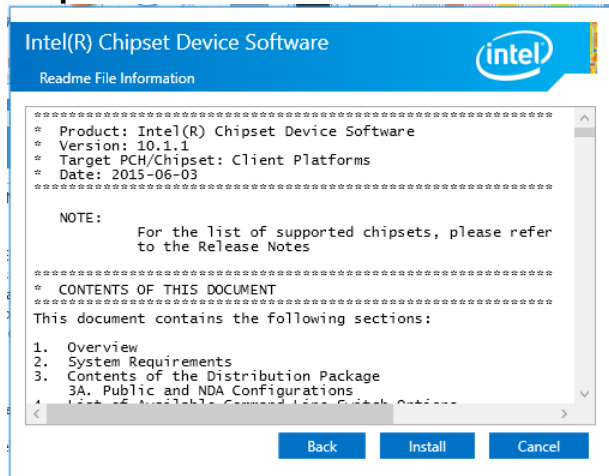

Step 4. Complete setup.

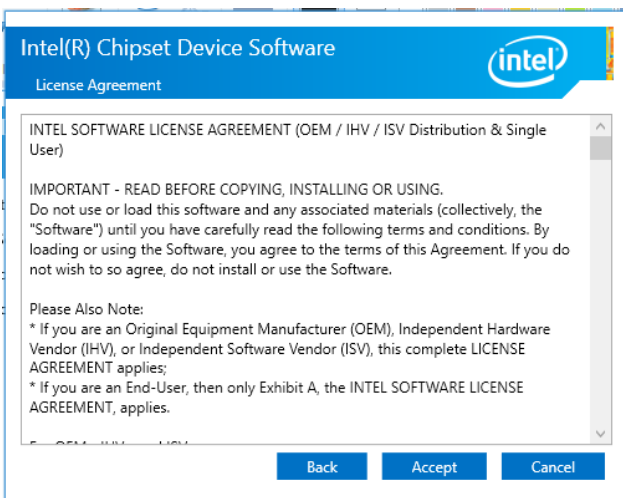

Step 2. Click Accept.

4.2 Install VGA Driver

All drivers can be found on the Avalue Official Website:

<http://www.avalue.com.tw>.



Note: The installation procedures and screen shots in this section are based on Windows 10 operation system.

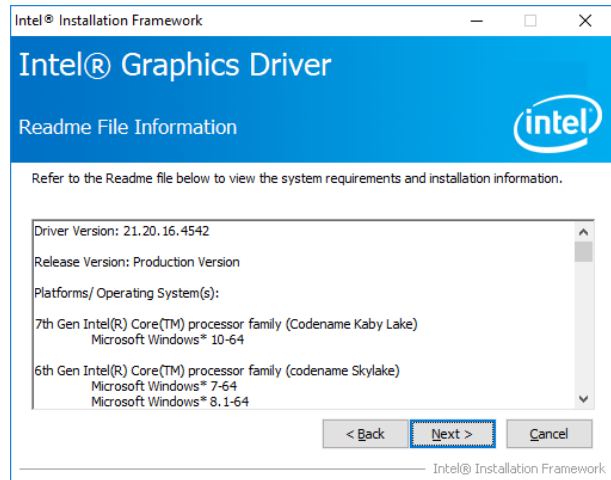

Step 3. Click Next.

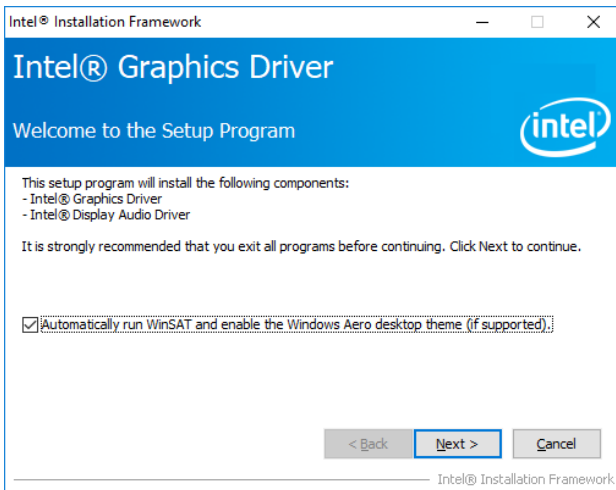

Step 1. Click Next to continue installation.

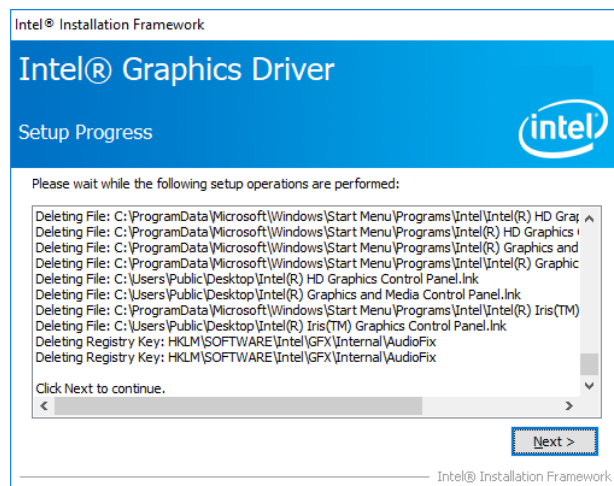

Step 4. Click Next.

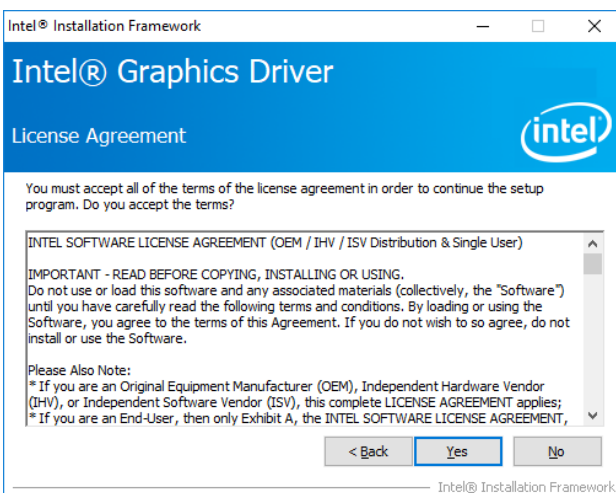

Step 2.
Click **Yes** to accept license agreement.

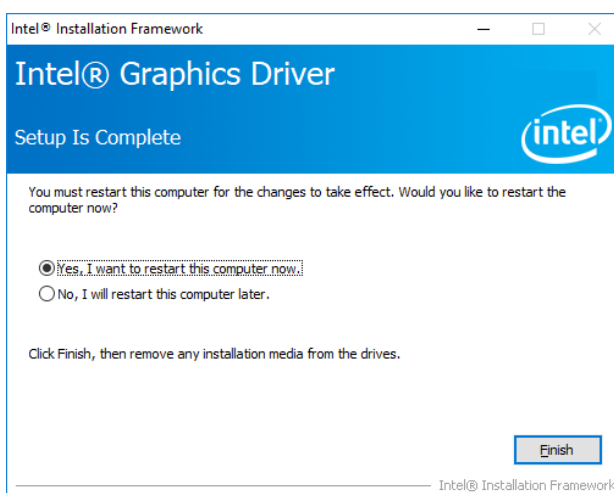

Step 5. Click Finish to complete setup.

4.3 Install SOL Driver

All drivers can be found on the Avalue Official Website:

<http://www.avalue.com.tw>.



Note: The installation procedures and screen shots in this section are based on Windows 10 operation system.

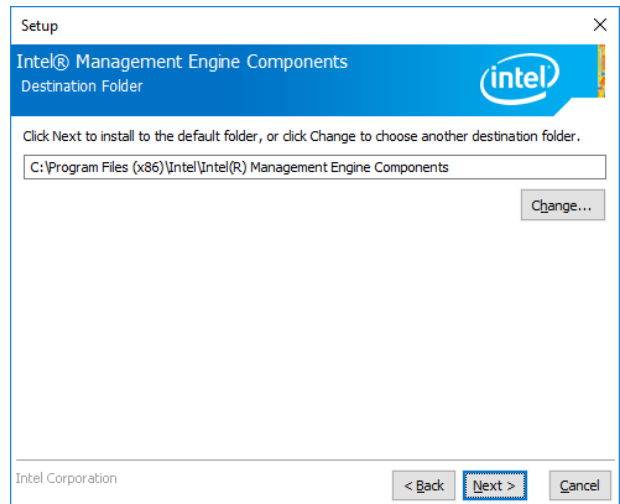

Step 3. Click Next

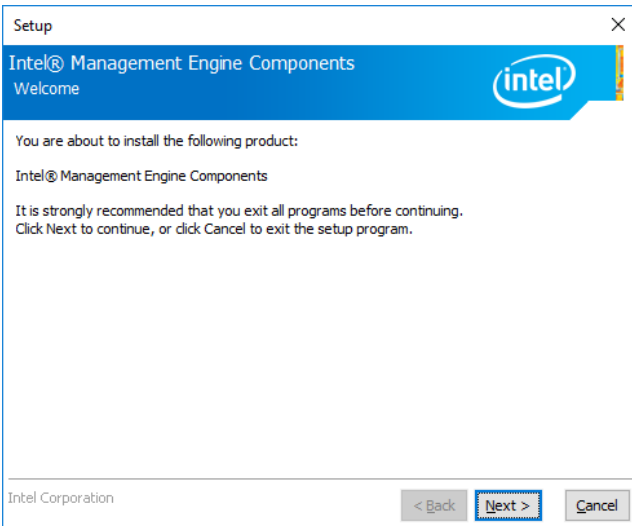

Step 1. Click Next to continue setup.

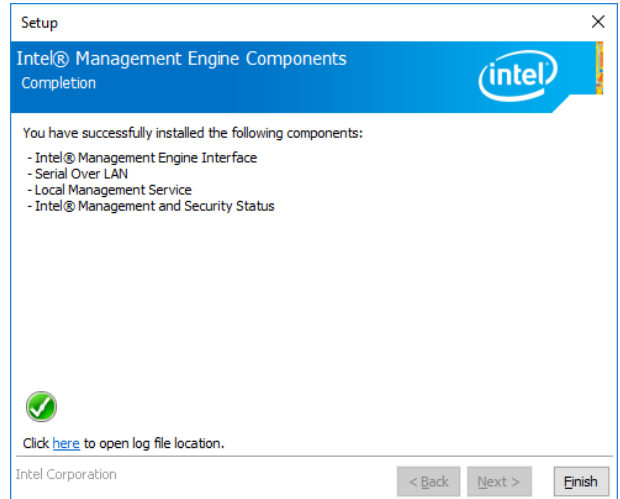

Step 4. Click Finish to complete the setup

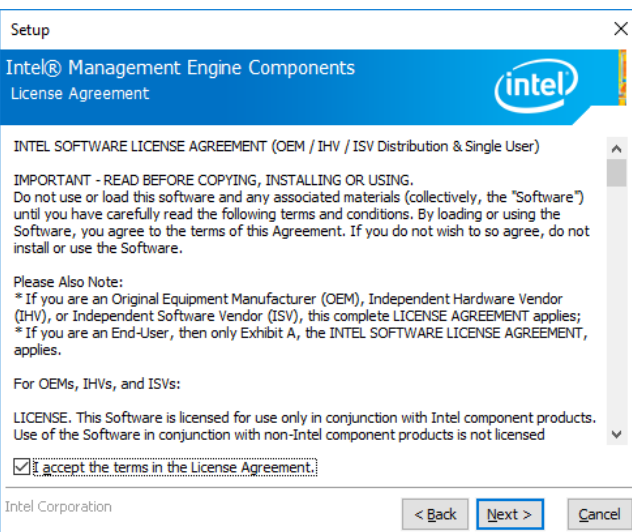

Step 2. Click Next.

4.4 Install Audio Driver (For Realtek ALC888S HD Audio)

All drivers can be found on the Avalue Official Website:

<http://www.avalue.com.tw>.



Note: The installation procedures and screen shots in this section are based on Windows 10 operation system.

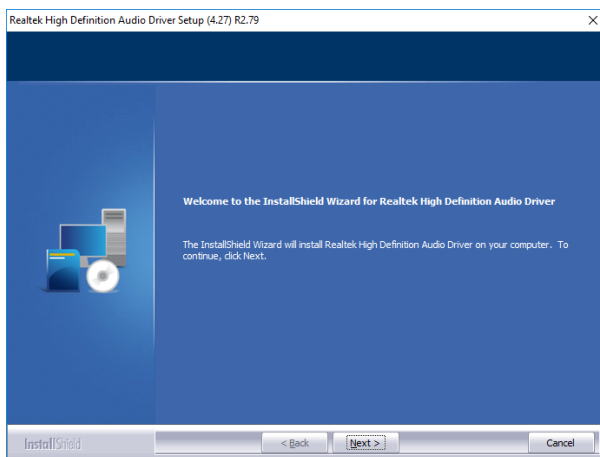

Step1. Click **Next** to Install.

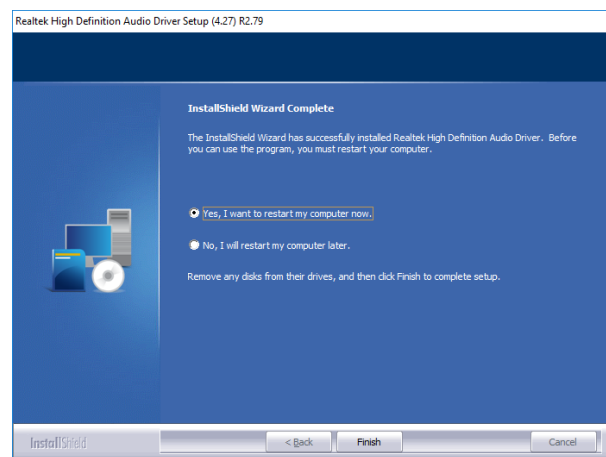

Step 2. Select **Finish** to complete Installation.

4.5 Install LAN Driver

All drivers can be found on the Avalue Official Website:

<http://www.avalu.com.tw>.



Note: The installation procedures and screen shots in this section are based on Windows 10 operation system.

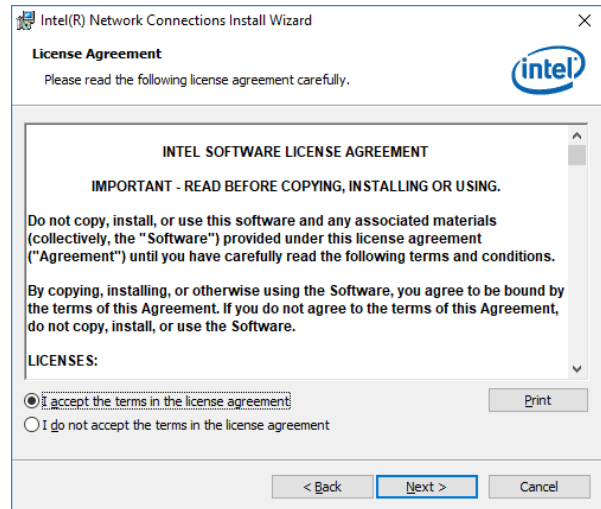

Step 3. Click Next.

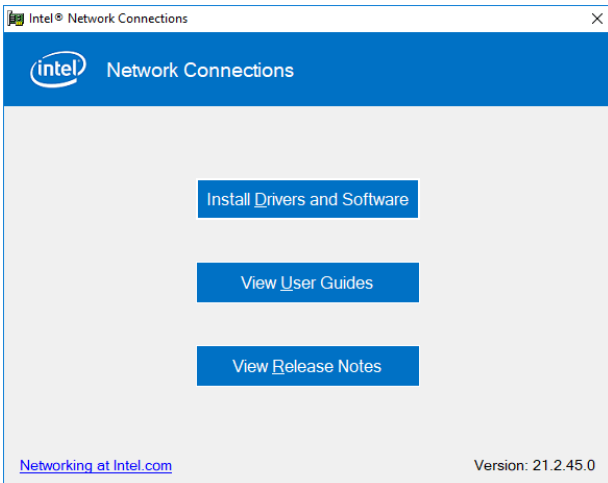

Step 1. Click Install Drivers and Software.

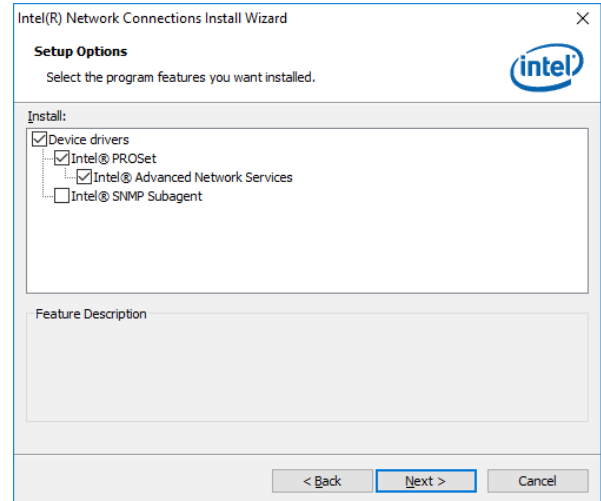

Step 4. Click Next.

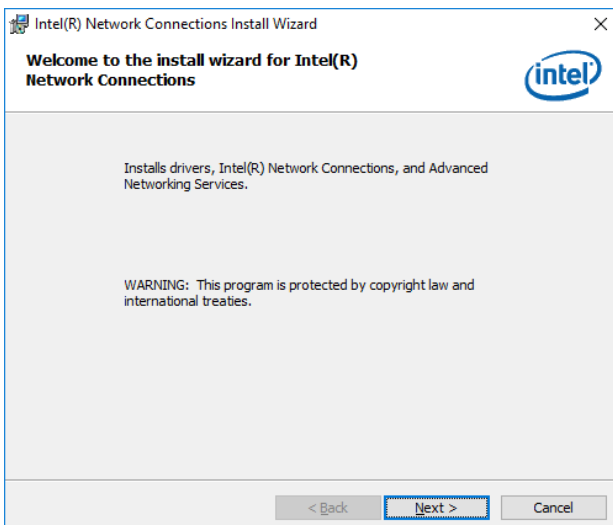

Step 2. Click Next.

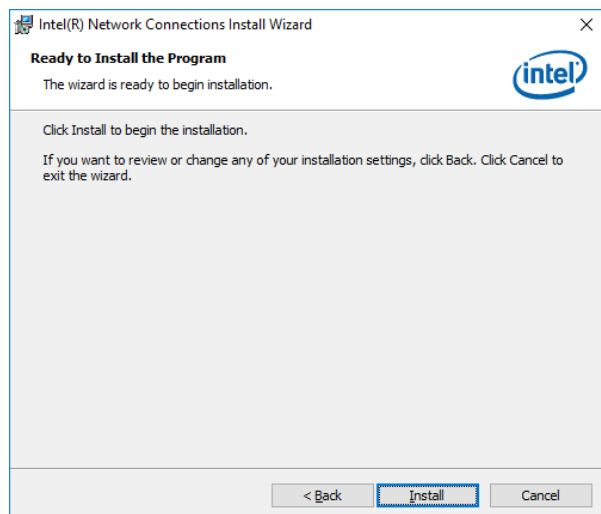

Step 5. Click Install.

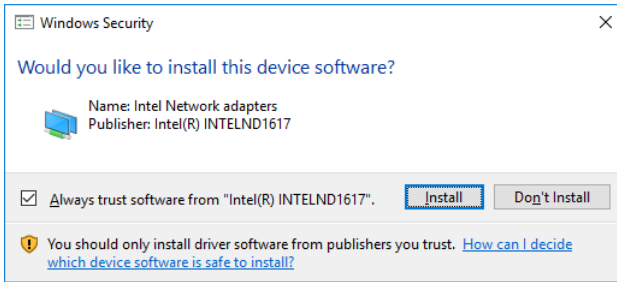

Step 6. Click Install.

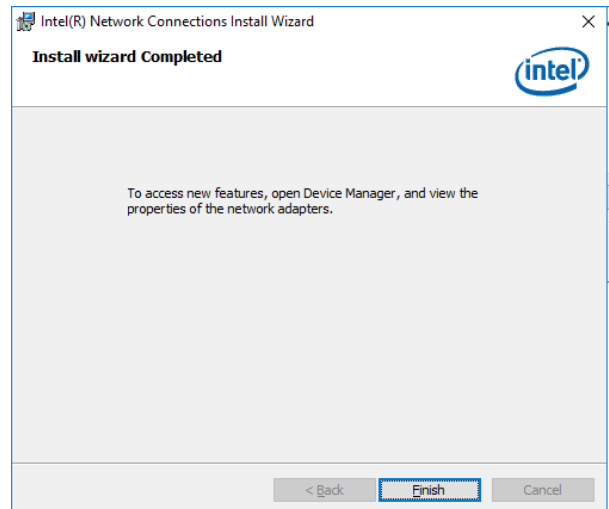

Step 7. Click Finish to complete setup.

4.6 Install RST Driver

All drivers can be found on the Avalue Official Website:
<http://www.avalue.com.tw>.



Note: The installation procedures and screen shots in this section are based on Windows 10 operation system.

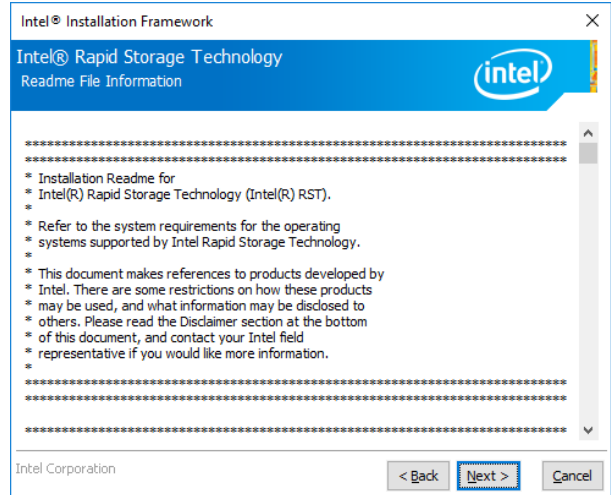

Step 3. Click Next.

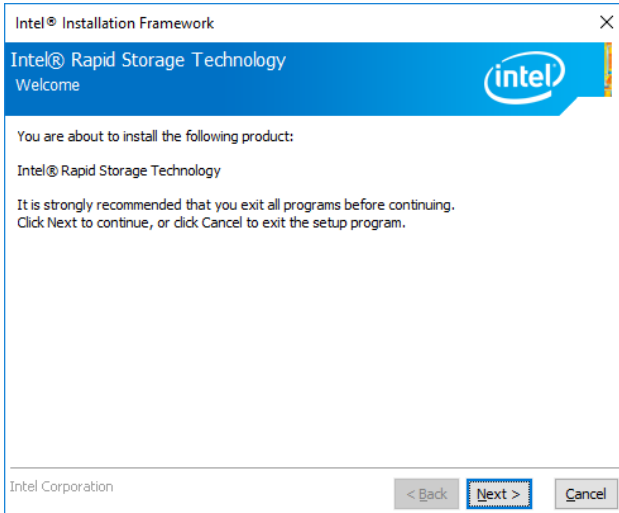

Step 1. Click Next to continue installation.

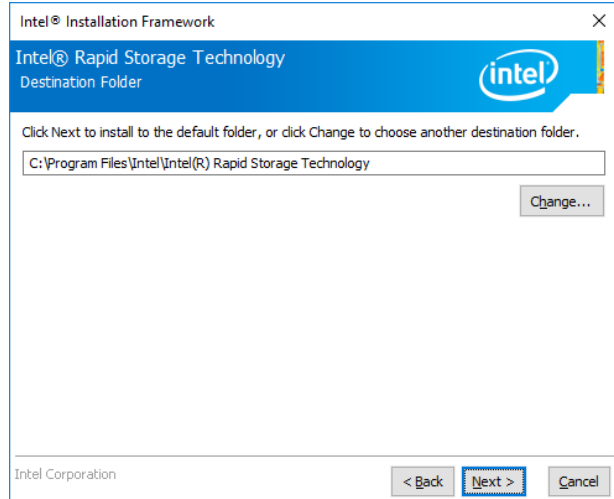

Step 4. Click Next.

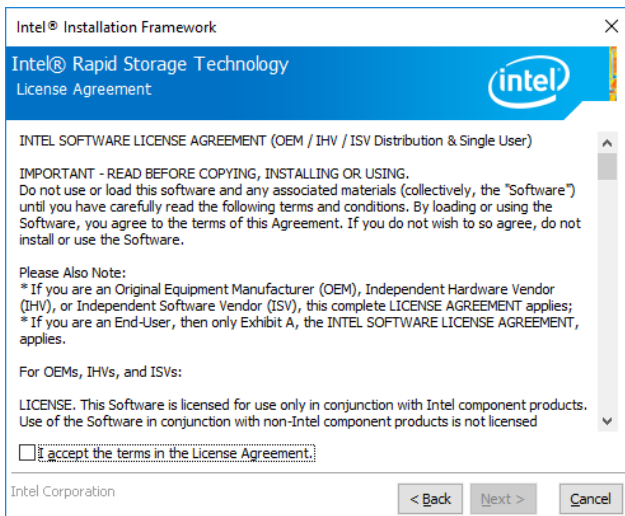

Step 2. Click Next.

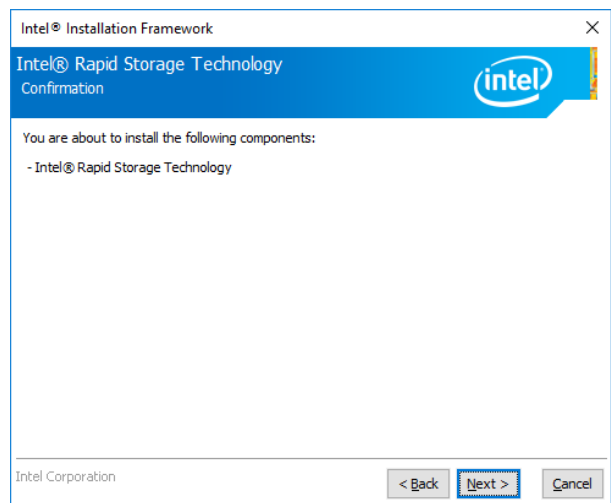

Step 5. Click Next.

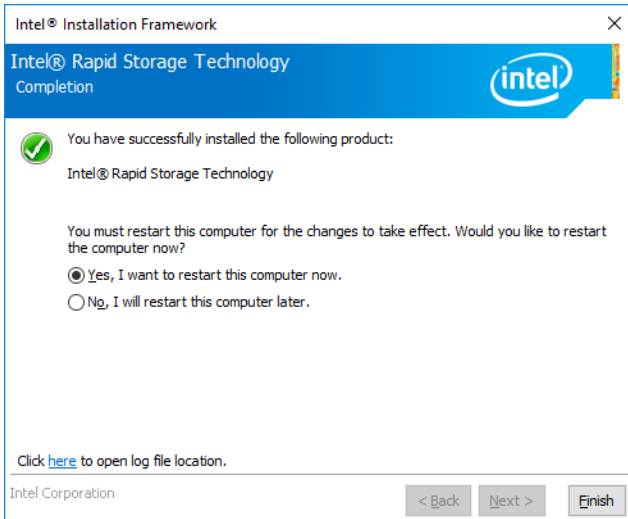

Step 6. Click **Finish** to complete setup.

5. Mechanical Drawing

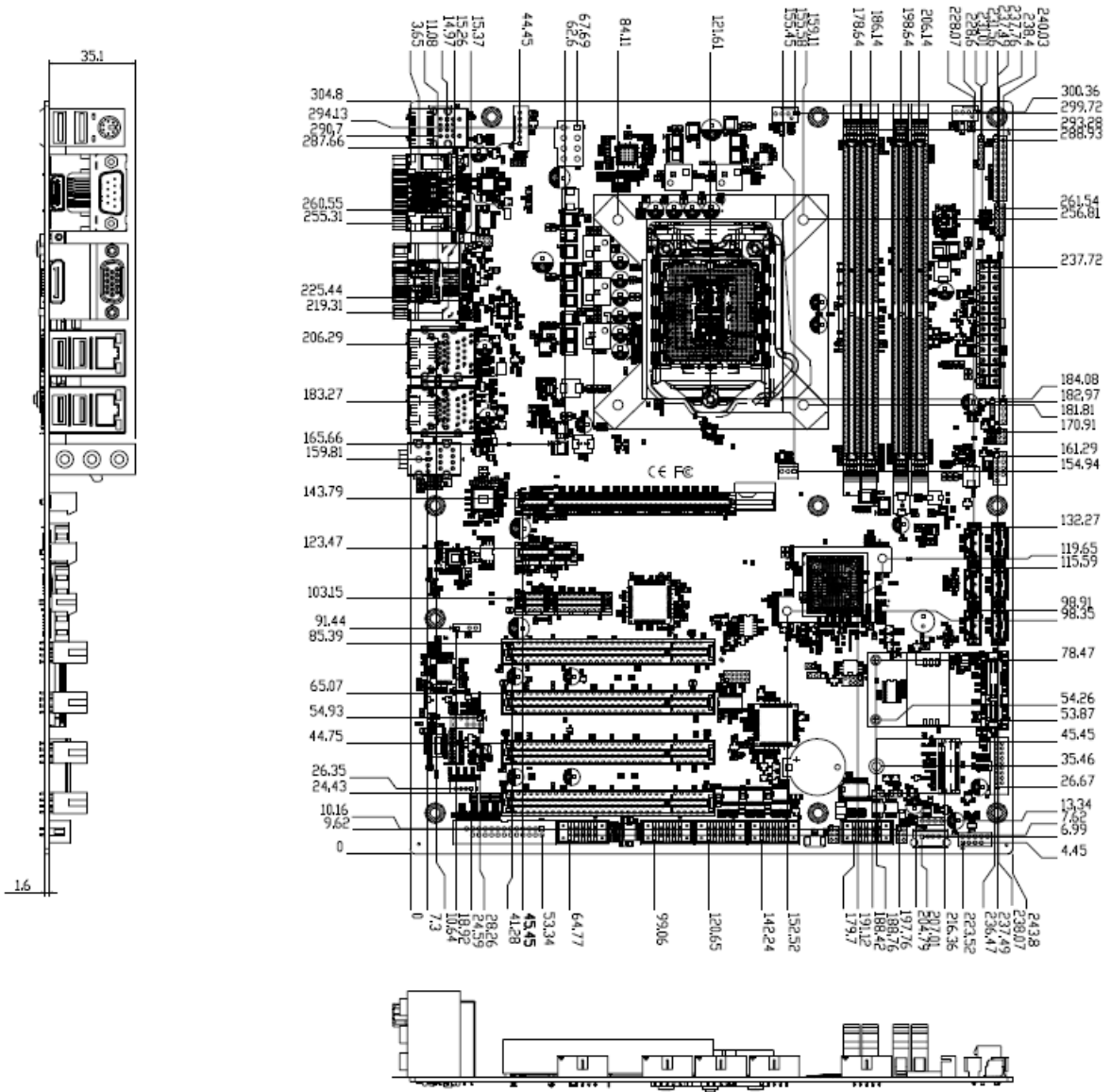

Unit: mm

EAX-C236KP-B1 User's Manual

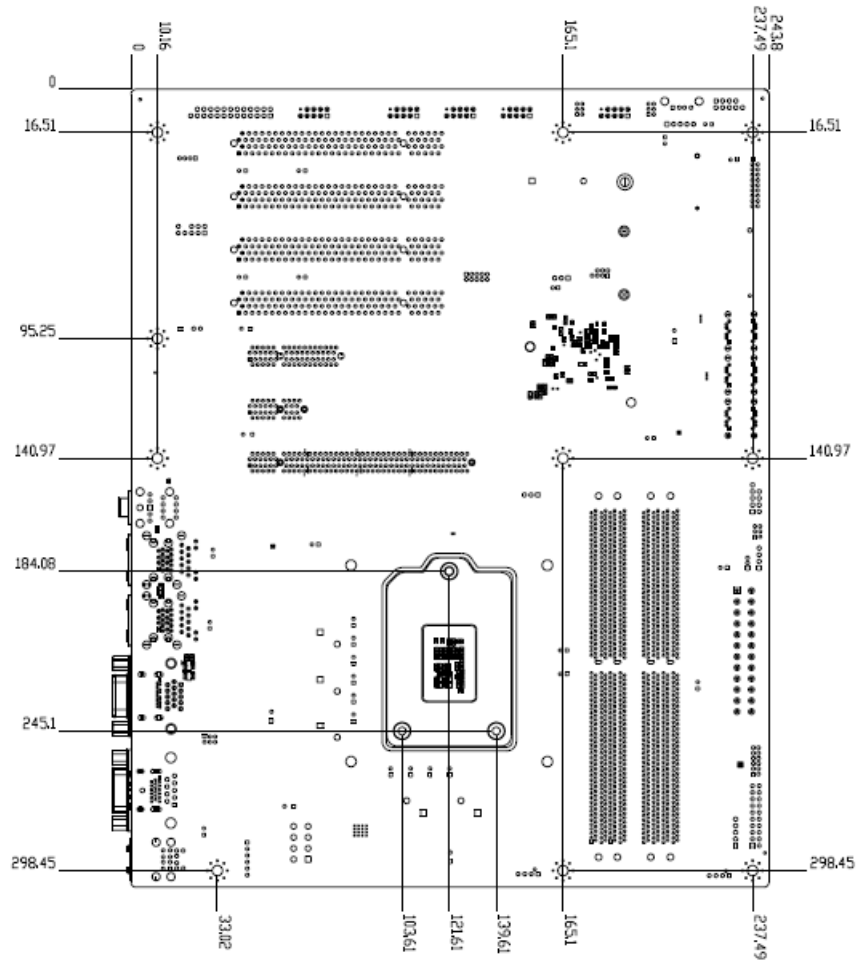

Unit: mm

