

# R19IT3S-MRA2

## 19" Intel® Core™ i7-1165G7 Marine Panel PC

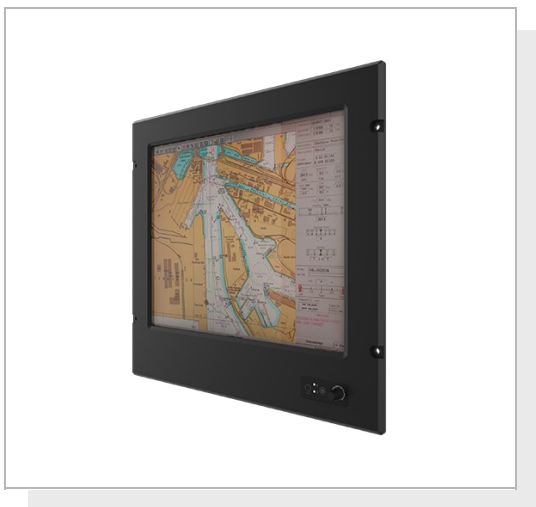

### KEY FEATURES

- Intel® Core™ i7-1165G7 processor marine panel PC
- Dimming knob control backlight brightness from nearly 0% to 100%
- 9~36V DC power input acceptable
- Panel (flush) mount IP66 aluminum housing with powder coating design



### SPECIFICATIONS

Display	
<b>Resolution</b>	1280x1024
<b>Contrast Ratio</b>	1000:1
<b>View Angles</b>	85,85,80,80
<b>Touch / Glass</b>	Resistive Touch Screen AR Glass (Optional)
<b>Size</b>	19 inches
<b>Panel Brightness</b>	350 nits
<b>Active Area</b>	376.32x301.06 mm
System Specification	
<b>Processor</b>	Intel Core i7-1165G7 2.8GHz (up to 4.7GHz)
<b>Memory</b>	1 x SO-DIMM, DDR4 2400 MHz, 4GB 8GB (Optional) 16GB (Optional) 32GB (Optional)
<b>Storage</b>	1 x M.2 2242 B-key SSD 64GB M.2 2242 B-key SSD up to 512GB (Optional) M.2 2280 M-Key NVME SSD, up to 4TB (Optional)
<b>Ethernet controller</b>	2 x Intel® Ethernet Controller
<b>Operating System</b>	Windows 10 IoT Enterprise (64 bit) (Optional) Windows 11 IoT Enterprise SAC (64 bit) (Optional) Linux Ubuntu 22.04 (Optional)
Environment	
<b>Operating Humidity</b>	5% to 95%
<b>Operating Temperature</b>	-15~55°C
<b>Shock</b>	15G, 11ms duration
<b>Vibration</b>	0.7g@DNVGL CG-0339 (Class A)
<b>IP rating</b>	IP66 (Front Side)
Certification	
<b>Certification</b>	CE, FCC
IO Ports	
<b>USB Port</b>	2 x USB 3.0
<b>Serial Port</b>	1 x RS232, 4 x RS232 or 4 x Isolation RS422/485 (Optional)
<b>Video</b>	1 x VGA 1 x HDMI (Optional)
<b>LAN</b>	2 x RJ45-10/100/1000 Mbps
Mechanical	
<b>Dimension</b>	425 x 303 x 77.5 mm
<b>Mounting</b>	VESA Mount/ Panel Mount
<b>Enclosure</b>	Metal Housing with Aluminum Bezel
<b>Cooling System</b>	Fanless Design

<b>Cut out</b>	408 x 359 mm		
<b>Accessory</b>	Driver CD & User Manual 4 x M6 Black Screw Bolt with M6 Nut 1 x AC Adapter 12V/ 84W 1 x Power Cord		
<b>Power</b>			
<b>Power Rating</b>	24V DC-in with Isolation (Approval by Certificate) 9~36V DC Input Acceptable	<b>Consumption</b>	65W (Typical)
<b>Control</b>			
<b>Button</b>	1 x Power Button 1 x Reset Button 1 x The Dimming Knob		

## DIMENSIONS UNIT:MM

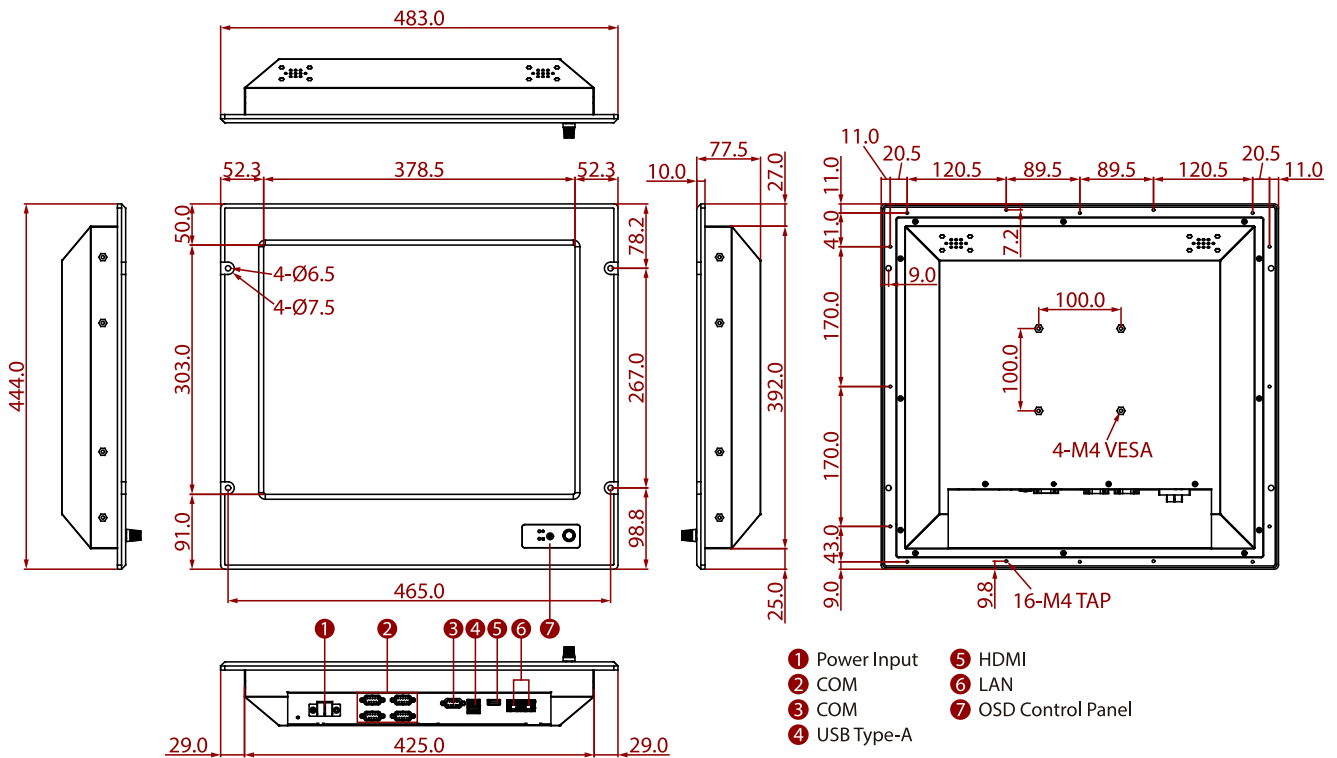

## NOTE

1. This is a simplified drawing and some components are not marked in detail.
2. Please contact our sales representative if you need further product information.
3. All specifications are subject to change without prior notice.
4. The product shown in this datasheet is a standard model. For diagrams that contain customized or optional I/O, please contact the Winmate Sales Team for more information.