

R12IT3S-MRM2

12.1" Intel® Core™ i7-1165G7 Marine Panel PC

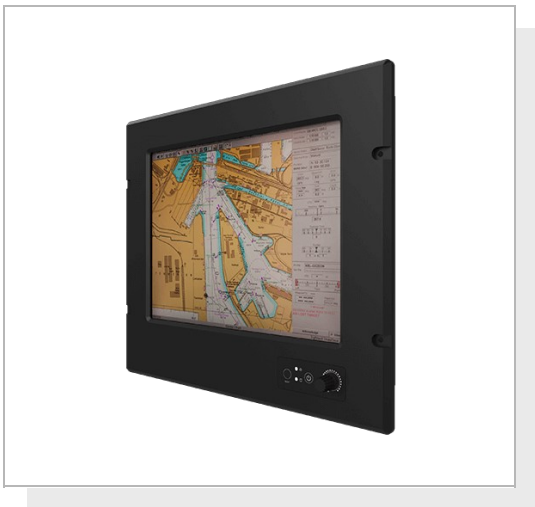

KEY FEATURES

- Intel® Core™ i7-1165G7 processor marine panel PC
- Dimming knob control backlight brightness from nearly 0% to 100%
- 9~36V DC power input acceptable
- Panel (flush) mount IP66 aluminum housing with powder coating design



SPECIFICATIONS

Display	
Resolution	1024x768
Contrast Ratio	1000:1
View Angles	89,89,89,89
Touch / Glass	Resistive Touch Screen AR Glass (Optional)
Size	12.1 inches
Panel Brightness	500 nits
Active Area	245.76x184.32 mm
System Specification	
Processor	Intel Core i7-1165G7 2.8GHz (up to 4.7GHz)
Memory	1 x SO-DIMM, DDR4 2400 MHz, 4GB 8GB (Optional) 16GB (Optional) 32GB (Optional)
Storage	1 x M.2 2242 B-key SSD 64GB M.2 2242 B-key SSD up to 512GB (Optional) M.2 2280 M-Key NVME SSD, up to 4TB (Optional)
Operating System	Windows 10 IoT Enterprise (64 bit) (Optional) Windows 11 IoT Enterprise SAC (64 bit) (Optional) Linux Ubuntu 22.04 (Optional)
Ethernet controller	2 x Intel® Ethernet Controller
Environment	
Operating Humidity	5% to 95%
Operating Temperature	-15~55°C
Shock	15G, 11ms duration
Vibration	0.7g@DNVGL CG-0339 (Class A)
IP rating	IP66 (Front Side)
Certification	
Certification	CE, FCC
Mechanical	
Dimension	412 x 345 x 71.7 mm
Mounting	VESA Mount/ Panel Mount
Enclosure	Metal Housing with Aluminum Bezel
Cooling System	Fanless Design
Cut out	338 x 288mm
IO Ports	
USB Port	2 x USB 3.0
Serial Port	1 x RS232 2 x RS232 or 2 x Isolation RS422/485 (Optional)
Video	1 x VGA
LAN	2 x RJ45-10/100/1000 Mbps

1 x HDMI (Optional)

Accessory

Accessory Driver CD & User Manual
4 x M6 Black Screw Bolt with M6 Nut
1 x AC Adapter 12V/ 84W
1 x Power Cord

Power

Power Rating 24V DC-in with Isolation (Approval by Certificate) **Consumption** 55W (Typical)
9~36V DC Input Acceptable

Control

Button 1 x Power Button
1 x Reset Button
1 x The Dimming Knob

DIMENSIONS UNIT:MM

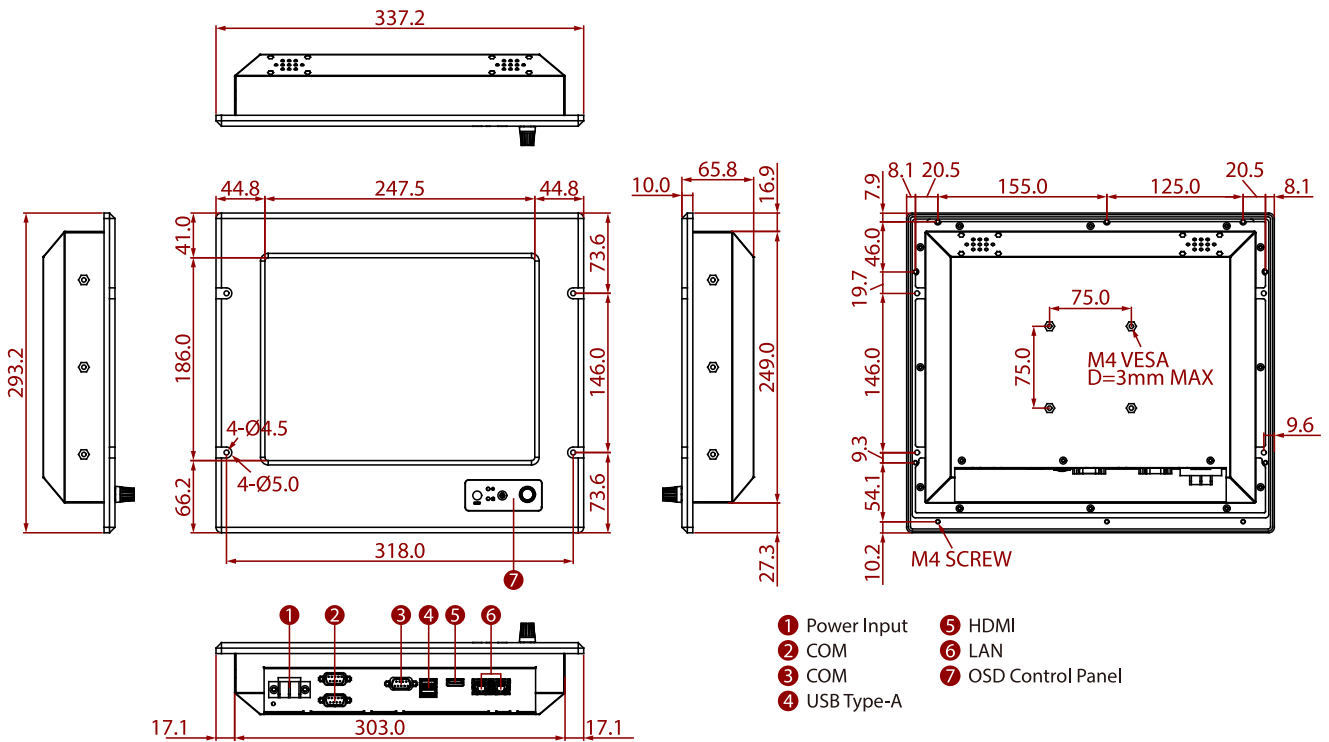

NOTE

- 1.This is a simplified drawing and some components are not marked in detail.
- 2.Please contact our sales representative if you need further product information.
- 3.All specifications are subject to change without prior notice.
- 4.The product shown in this datasheet is a standard model.For diagrams that contain customized or optional I/ O, please contact the Winmate Sales Team for more information.