

ARC-1235

12.1" XGA LED with P-cap Touch by B type (Option 5-wire Resistive touch by A type) Fanless Rugged Touch Panel PC with IET Expansion

Quick Reference Guide

1st Ed – 03 February 2023

Copyright Notice

Copyright © 2023 Avalue Technology Inc., ALL RIGHTS RESERVED.

Part No. E2017A250A0R

FCC Statement



THIS DEVICE COMPLIES WITH PART 15 FCC RULES. OPERATION IS SUBJECT TO THE FOLLOWING TWO CONDITIONS:

(1) THIS DEVICE MAY NOT CAUSE HARMFUL INTERFERENCE.

(2) THIS DEVICE MUST ACCEPT ANY INTERFERENCE RECEIVED INCLUDING INTERFERENCE THAT MAY CAUSE UNDESIRE OPERATION.

THIS EQUIPMENT HAS BEEN TESTED AND FOUND TO COMPLY WITH THE LIMITS FOR A CLASS "A" DIGITAL DEVICE, PURSUANT TO PART 15 OF THE FCC RULES.

THESE LIMITS ARE DESIGNED TO PROVIDE REASONABLE PROTECTION AGAINST HARMFUL INTERFERENCE WHEN THE EQUIPMENT IS OPERATED IN A COMMERCIAL ENVIRONMENT. THIS EQUIPMENT GENERATES, USES, AND CAN RADIATE RADIO FREQUENCY ENERGY AND, IF NOT INSTALLED AND USED IN ACCORDANCE WITH THE INSTRUCTION MANUAL, MAY CAUSE HARMFUL INTERFERENCE TO RADIO COMMUNICATIONS.

OPERATION OF THIS EQUIPMENT IN A RESIDENTIAL AREA IS LIKELY TO CAUSE HARMFUL INTERFERENCE IN WHICH CASE THE USER WILL BE REQUIRED TO CORRECT THE INTERFERENCE AT HIS OWN EXPENSE.

A Message to the Customer

Avalue Customer Services

Each and every Avalue's product is built to the most exacting specifications to ensure reliable performance in the harsh and demanding conditions typical of industrial environments. Whether your new Avalue device is destined for the laboratory or the factory floor, you can be assured that your product will provide the reliability and ease of operation for which the name Avalue has come to be known.

Your satisfaction is our primary concern. Here is a guide to Avalue's customer services. To ensure you get the full benefit of our services, please follow the instructions below carefully.

Technical Support

We want you to get the maximum performance from your products. So if you run into technical difficulties, we are here to help. For the most frequently asked questions, you can easily find answers in your product documentation. These answers are normally a lot more detailed than the ones we can give over the phone. So please consult the user's manual first.

To receive the latest version of the user's manual; please visit our Web site at:

<http://www.avalue.com.tw/>

Content

1.	Getting Started	7
1.1	Safety Precautions	7
1.2	Packing List.....	7
1.3	System Specifications	8
1.4	System Overview	13
1.4.1	I/O View	13
1.5	System Dimensions	14
2.	Hardware Configuration	15
2.1	ARC-1235 connector mapping	16
2.1.1	Serial port 1 connector (COM1).....	16
2.1.2	Serial port 2 connector (COM2).....	16
2.2	Installing Memory	17
2.3	ARC-EHL Overviews.....	18
2.4	ARC-EHL Jumper and Connector list.....	19
2.5	ARC-EHL Jumpers & Connectors settings.....	21
2.5.1	Serial port 1/2 pin9 signal select (JRI1/2).....	21
2.5.2	LCD backlight brightness adjustment (JSBKL1)	21
2.5.3	AT/ATX Input power select (JSATX1)	22
2.5.4	Serial port 1 in RS-232/422/485 mode (JCOM_SEL1).....	22
2.5.5	M.2 KEY power select (JP1).....	23
2.5.6	LCD Inverter connector (JBKL1)	23
2.5.7	Touch connector (JTP1) co-lay USB2.0 header (JUSB1)	24
2.5.8	On-board header for USB2.0 (JUSB2).....	24
2.5.9	LVDS connector (LVDS1).....	25
2.5.10	AMPLIFIER_R (JSPKR1)	26
2.5.11	AMPLIFIER_L (JSPKL1)	26
2.5.12	Battery connector (BT1)	27
2.5.13	SPI connector (JSPI1)	27
2.5.14	B2B connector (JB2B1)	28
2.5.15	General purpose I/O connector (JGPIO1).....	29
2.5.16	SATA Power connector (SATAPW1).....	29
2.5.17	Front Panel connector (JFP1)	30
2.5.18	ESPI connector (JESPI1)	30
2.5.19	EC connector (JEC1).....	31

ARC-1235

2.6	ARC-BYT DB-A/B/C/D/G/H/K Overviews	32
2.6.1	ARC-BYT DB-A	32
2.6.2	ARC-BYT DB-B	32
2.6.3	ARC-BYT DB-C	32
2.6.4	ARC-BYT DB-D	33
2.6.5	ARC-BYT DB-G	33
2.6.6	ARC-BYT DB-H	33
2.6.7	ARC-BYT DB-K	34
2.7	ARC-BYT DB-A/B/C/D/G/H/K Connector list	34
2.7.1	ARC-BYT DB-A	34
2.7.2	ARC-BYT DB-B	34
2.7.3	ARC-BYT DB-C	34
2.7.4	ARC-BYT DB-D	35
2.7.5	ARC-BYT DB-G	35
2.7.6	ARC-BYT DB-H	35
2.7.7	ARC-BYT DB-K	35
2.8	ARC-BYT DB-D Connectors settings	36
2.8.1	Serial Port 1 connector (D_COM1)	36
2.8.2	Serial Port 2 connector (D_COM2)	36
2.9	ARC-BYT DB-G Connectors settings	37
2.9.1	Serial Port 1 connector (G_COM1)	37
2.9.2	Serial Port 2 connector (G_COM2)	37
2.9.3	Serial Port 3 connector (G_COM3)	38
2.10	ARC-BYT DB-H Jumpers settings	38
2.10.1	USB Power selector (H_USB_PWR_SEL1)	38
2.11	ARC-BYT DB-H Connectors settings	39
2.11.1	Serial Port 1 connector (H_COM1)	39
2.11.2	Serial Port 2 connector (H_COM2)	39
2.12	ARC-BYT DB-K Connectors settings	40
2.12.1	Serial Port 1 connector (I_COM1)	40
2.12.2	Serial Port 2 connector (I_COM2)	40
3	BIOS Setup	41
3.1	Introduction	42
3.2	Starting Setup	42
3.3	Using Setup	43
3.4	Getting Help	44
3.5	In Case of Problems	44
3.6	BIOS setup	45
3.6.1	Main Menu	45
3.6.1.1	System Language	46

3.6.1.2	System Date	46
3.6.1.3	System Time	46
3.6.2	Advanced Menu	46
3.6.2.1	CPU Configuration	47
3.6.2.2	Power & Performance	48
3.6.2.2.1	CPU – Power Management Control	48
3.6.2.2.1.1	View/Configure Turbo Options	49
3.6.2.2.2	GT – Power Management Control	50
3.6.2.3	PCH-FW Configuration	50
3.6.2.3.1	Firmware Update Configuration	51
3.6.2.3.2	PTT Configuration	51
3.6.2.4	Trusted Computing	52
3.6.2.5	ACPI Settings	52
3.6.2.6	Super IO Configuration	53
3.6.2.6.1	Serial Port 1 Configuration	54
3.6.2.6.2	Serial Port 2 Configuration	54
3.6.2.6.3	Serial Port 3 Configuration	55
3.6.2.6.4	Serial Port 4 Configuration	55
3.6.2.6.5	Serial Port 5 Configuration	56
3.6.2.7	EC 5571 HW Monitor	56
3.6.2.8	S5 RTC Wake Settings	57
3.6.2.9	Serial Port Console Redirection	57
3.6.2.10	USB Configuration	58
3.6.2.11	Network Stack Configuration	59
3.6.3	Chipset	60
3.6.3.1	System Agent (SA) Configuration	60
3.6.3.1.1	Memory Configuration	61
3.6.3.1.2	Graphics Configuration	62
3.6.3.2	PCH-IO Configuration	62
3.6.3.2.1	PCI Express Configuration	63
3.6.3.2.1.1	PCI Express Root Port 3(LAN1-I225/I226)	63
3.6.3.2.1.2	PCI Express Root Port 4(LAN2-I225/I226)	64
3.6.3.2.1.3	PCI Express Root Port 5(M.2 KeyE)	65
3.6.3.2.1.4	PCI Express Root Port 7(M.2 KeyB/B2B)	66
3.6.3.2.2	SATA Configuration	67
3.6.3.2.3	USB Configuration	68
3.6.3.2.4	HD Audio Configuration	68
3.6.3.3	Board & Panel Configuration	69
3.6.4	Security	71
3.6.4.1	Secure Boot	71

ARC-1235

3.6.4.1.1	Key Management	72
3.6.5	Boot.....	73
3.6.6	Save and exit	74
3.6.6.1	Save Changes and Reset	75
3.6.6.2	Discard Changes and Reset	75
3.6.6.3	Restore Defaults.....	75
3.6.6.4	Launch EFI Shell from filesystem device	75

1. Getting Started

1.1 Safety Precautions

Warning!



Always completely disconnect the power cord from your chassis whenever you work with the hardware. Do not make connections while the power is on. Sensitive electronic components can be damaged by sudden power surges. Only experienced electronics personnel should open the PC chassis.

Caution!



Always ground yourself to remove any static charge before touching the CPU card. Modern electronic devices are very sensitive to static electric charges. As a safety precaution, use a grounding wrist strap at all times. Place all electronic components in a static-dissipative surface or static-shielded bag when they are not in the chassis.

1.2 Packing List

- 1 x ARC-1235 Panel PC
- 1 x Power Adapter
- 4 x screws for VESA



If any of the above items is damaged or missing, contact your retailer.

1.3 System Specifications

Component	
Mother Board	ARC-EHL
CPU	Onboard Intel® Elkhart Lake Processor Intel Atom® x6211E Processor (6W, 1.5M Cache, up to 3.00 GHz) Intel Atom® x6413E Processor (9W, 1.5M Cache, up to 3.00 GHz) Intel Atom® x6425E Processor (12W, 1.5M Cache, up to 3.00 GHz)
CPU Cooler (Type)	Fanless Heatsink
Memory	1 x 260-pin DDR4 3200 MHz SO-DIMM socket, supports up to 32GB Max (In-BEND ECC supported) *Using wide temp. RAM if work with wide temp.
Power Supply	Wide Range DC Power Input from 12~24v in
Adapter	AC/DC adapter 19V/3.78A Screw Type, 72W power adaptor
System Fan	Fanless
Speaker	2W*2
Wireless LAN	Default N/A; Optional support by M.2 Key-E 2230 slot (Support PCIe1, USB2.0 Wi-Fi/BT module)
Bluetooth	Default N/A; Optional support by M.2 Key-E 2230 slot (Support PCIe1, USB2.0 Wi-Fi/BT module)
Operating System	Windows 10 Linux
Expansion Card	2 x M.2 Slots: 1 x M.2 Key-B, 2242/3042/3052, support SATAIII USB2.0, SIM Slot for LTE Cards BOM option for PCIe1 or USB3.2 Gen1x1 (*Default PCIe1 is for IET CON., Option for M.2 Key-B PCIe or USB) 1 x M.2 Key-E, 2230, support PCIe1, USB2.0 1 x 80-pin Expansion IET interface
Other Component	SIM card slot (for 4G or 5G module) for M.2 Key-B 2242/3042/3052 TPM 2.0 (NuvoTon_NPCT754AADYX / Infineon_SLB9670VQ2.0 co-lay) Default is NuvoTon
Storage	
Hard Disk Drive	1 x 2.5" Drive Bay *Using wide temp. Storage if work with wide temp.

Solid State Drive	1 x 2.5" Drive Bay *Using wide temp. Storage if work with wide temp.
Other Storage Device	1 x M.2 Key-B 2242/3042/3052 for M.2 SATAIII SSD by default
Panel	
LCD Panel	Resistive Touch 12.1" XGA LED PANEL InnoLux G121XCE-L01 P-cap Touch: 12.1" XGA LED PANEL InnoLux G121XCE-L01
B/L Inverter/Converter	Panel built in
Touch Screen	Resistive Touch Touch panel 5 wire Analog RoHS/T121S-5RB014N-0A18R0-200FH P-cap Touch: 12.1" PCAP H8573C+EETI EXC84H4254
Touch Controller	Resistive Touch PenMount 6000 P-cap Touch: N/A
Others	Bonding Panel: Resistive Touch 12.1" Innolux G121XCE-L01+ 5-wire P-cap Touch: 12.1" Inno G121XCE-L01+PCAP H8573C
External I/O	
Serial Port	1 x DB-9 COM1 (RS-232/422/485, selectable by BIOS & JUMPER, RS-485 supports Auto Flow, Pin-9 selected for Ring/+5V/+12V by Jumper) 1 x DB-9 COM2 (RS-232, Pin-9 selected for Ring/+5V/+12V by Jumper)
USB Port	4 x USB3.2 Gen2x1 (10Gbp/s) (2 x Dual Deck, Type A)
DIO Port	1 x 8 bit GPIO (by onboard JGPIO1 wafer 6Px2) 12-bit GPIO + 2-pin CAN Bus (by ARC-BYT DB-E)
Video Port	(Option By IET module only, (DB-B, DB-C) (Option By IET module only, AUX-080 (for 2xHDMI)
Audio Port	Realtek ALC888S & 897 co-layout (or other option decided by Avalue)
LAN Port	2 x Intel® I225-IT 2.5 Gigabit Ethernet * Intel® I225-IT for wide temperature
Wireless LAN Antenna	5 x Antenna hole on Top of back cover (2 x Antenna hole on empty IET bracket) (5G needs 4~6 antenna, Wi-Fi 6 needs 3 antenna)
Indicator Light	HDD LED, Power LED (Green for Power, Yellow for HDD)
Expansion Slots	2 x M.2 Slots:

ARC-1235

	<p>1 x M.2 Key-B, 2242/3042/3052, support SATAIII</p> <p>USB2.0, SIM Slot for LTE Cards</p> <p>BOM option for PCIe1 or USB3.2 Gen1x1 (*Default PCIe1 is for IET CON., Option for M.2 Key-B PCIe or USB)</p> <p>1 x M.2 Key-E, 2230, support PCIe1, USB2.0</p> <p>1 x 80-pin Expansion IET interface</p>
Mechanical	
Power Type	ATX/AT by jumper (Default ATX)
Power button	1 x Power Switch on the side
Power Connector Type	Lockable DC in power jack (phoenix connector by option)
Dimension	283 x 221.1 x 51.2 mm
Weight	2.4 Kgs
Color	A Type: Front: Silver Aluminum; Rear: Black Casting-Aluminum B Type: Die Casting with Cover lens
Fanless	Full System Fan-less
OS Support	Win 10 Linux
Reliability	
EMI Test	CE FCC Class B
Dust and Rain Test	Front Panel IP65, Rear IP41 except I/O
Vibration Test	<p>Random Vibration Operation:</p> <ol style="list-style-type: none"> 1. PSD: 0.00454G²/Hz , 3 Grms 2. operation mode 3. Test Frequency : 5-500Hz 4. Test Axis : X,Y and Z axis 5. 30 minutes per each axis 6. IEC 60068-2-64 Test:Fh 7. Storage : SSD or M.2 SSD <p>Sine Vibration test (Non-operation)</p> <ol style="list-style-type: none"> 1 Test Acceleration : 2G 2 Test frequency : 5~500 Hz 3 Sweep : 1 Oct/ per one minute. (logarithmic) 4 Test Axis : X,Y and Z axis 5 Test time :30 min. each axis

	<p>6 System condition : Non-Operating mode</p> <p>7. Reference IEC 60068-2-6 Testing procedures</p> <p>Package vibration test</p> <ol style="list-style-type: none"> 1. PSD: 0.026G²/Hz , 2.16 Grms 2. Non-operation mode 3. Test Frequency : 5-500Hz 4. Test Axis : X,Y and Z axis 5. 30 min. per each axis 6. IEC 60068-2-64 Test:Fh
Mechanical Shock Test	<ol style="list-style-type: none"> 1. Wave form : Half Sine wave 2. Acceleration Rate : 20g for operation mode 3. Duration Time : 11ms 4. No. of Shock : +/- X,Y,Z axis 3 times 5. Test Axis: +/- X,Y,Z axis 6. Operation mode 7. Reference IEC 60068-2-27 Testing procedures Test Eb : Shock Test
Drop Test	<p>Package drop test</p> <p>Reference ISTA 2A, Method : IEC-60068-2-32 Test:Ed</p> <p>Test Ea : Drop Test</p> <ol style="list-style-type: none"> 1 Test phase : One corner, three edges, six faces 2 Test high : 96.5cm 3 Package weight : 5Kg 4 Test drawing <p>4-feet drop resistance without package</p> <p>MIL-STD-810G</p>
Operating Temperature	Wide temp.-20°C ~ 60°C (-4°F ~ 140°F)
Operating Humidity	40°C @ 95% Relative Humidity, Non-condensing
Storage Temperature	Wide temp.-20°C ~ 60°C(-4°F ~ 140°F)
Compliant with following Flexible Expansion Modules	
	Optional IET Module list:
ACC-ARC-USB-1R	IET DB-A 4 x USB3.0 kit for ARC Series (Unavailable when using M.2 key-B 5G module(PCIe changed to M.2 key-B))
ACC-ARC-AUDIO-1R	IET DB-B HDMI + 5.1 CH Audio Kit for ARC Series
ACC-ARC-MPCIE-1R	IET DB-C HDMI + MPCIE w/SIM Kit for ARC Series (Unavailable when using M.2 key-B 5G module(PCIe changed to M.2 key-B))

ARC-1235

ACC-ARC-COM-1R	IET DB-D 2 x Isolated RS-232 Kit for ARC Series (ARC-EHL is used eSPI EC, so need to add eSPI to LPC IC for UART)
ACC-ARC-COM-2R	IET DB-G 3 x RS-232 Kit for ARC Series (ARC-EHL is used eSPI EC, so need to add eSPI to LPC IC for UART)
ACC-ARC-COM-3R	IET DB-H 2 x RS-232 + USB Kit for ARC Series (ARC-EHL is used eSPI EC, so need to add eSPI to LPC IC for UART)
ACC-ARC-COM-4R	IET DB-K 2 x RS-232 + LAN Kit for ARC Series (ARC-EHL is used eSPI EC, so need to add eSPI to LPC IC for UART) (Unavailable when using M.2 key-B 5G module(PCIe changed to M.2 key-B))
ACC-ARC-GPIO-1R	IET DB-E 12-bit GPIO + 2-pin CAN Bus Kit for ARC Series
ACC-ARC-OBDDII-1R	IET DB-F OBDII - CAN Bus Kit for ARC Series (OBDII/EOBD for Small Vehicle) (ARC-EHL is used eSPI EC, so need to add eSPI to LPC IC for UART)
ACC-ARC-OBDDII-2R	IET DB-F OBDII - CAN Bus Kit for ARC Series (J1939J1708 for Large Vehicle) (ARC-EHL is used eSPI EC, so need to add eSPI to LPC IC for UART)
ACC-ARC-OBDDII-3R	IET DB-F OBDII - CAN Bus Kit for ARC Series (ISO15765-4 for Special Large Vehicle) (ARC-EHL is used eSPI EC, so need to add eSPI to LPC IC for UART)



Note: Specifications are subject to change without notice.

1.4 System Overview

1.4.1 I/O View

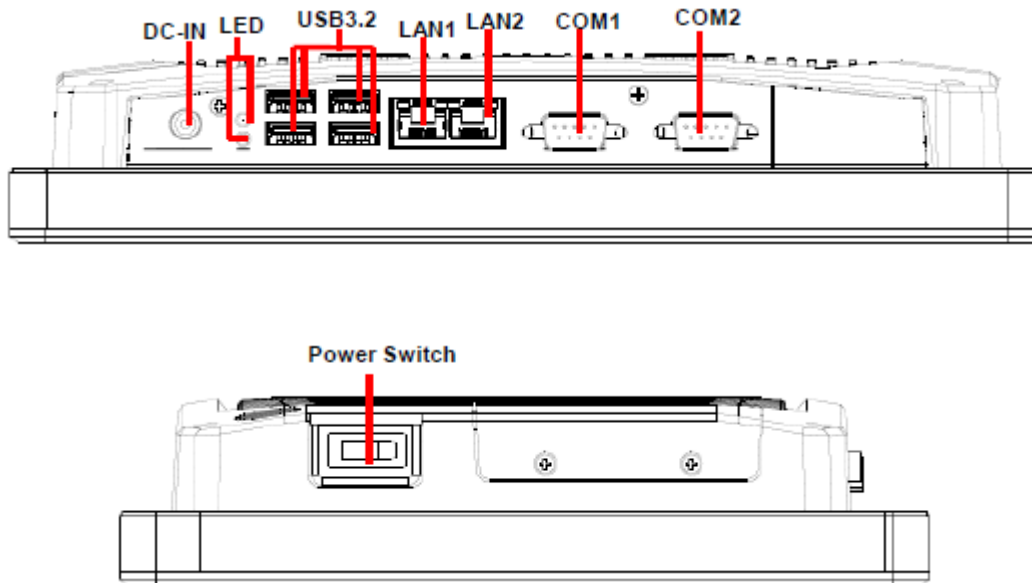

Connectors

Label	Function	Note
DC-IN	DC Power-in connector	Default: Lockable DC Jack Option: Phoenix Connector(MOQ apply)
COM1/2	Serial port 1/2 connector	DB-9 male connector
USB	4 x USB 3.2 connector	
LAN1/2	RJ-45 Ethernet 1/2	
LED	HDD/Power LED indicator	
Power Switch	Power on button	

1.5 System Dimensions

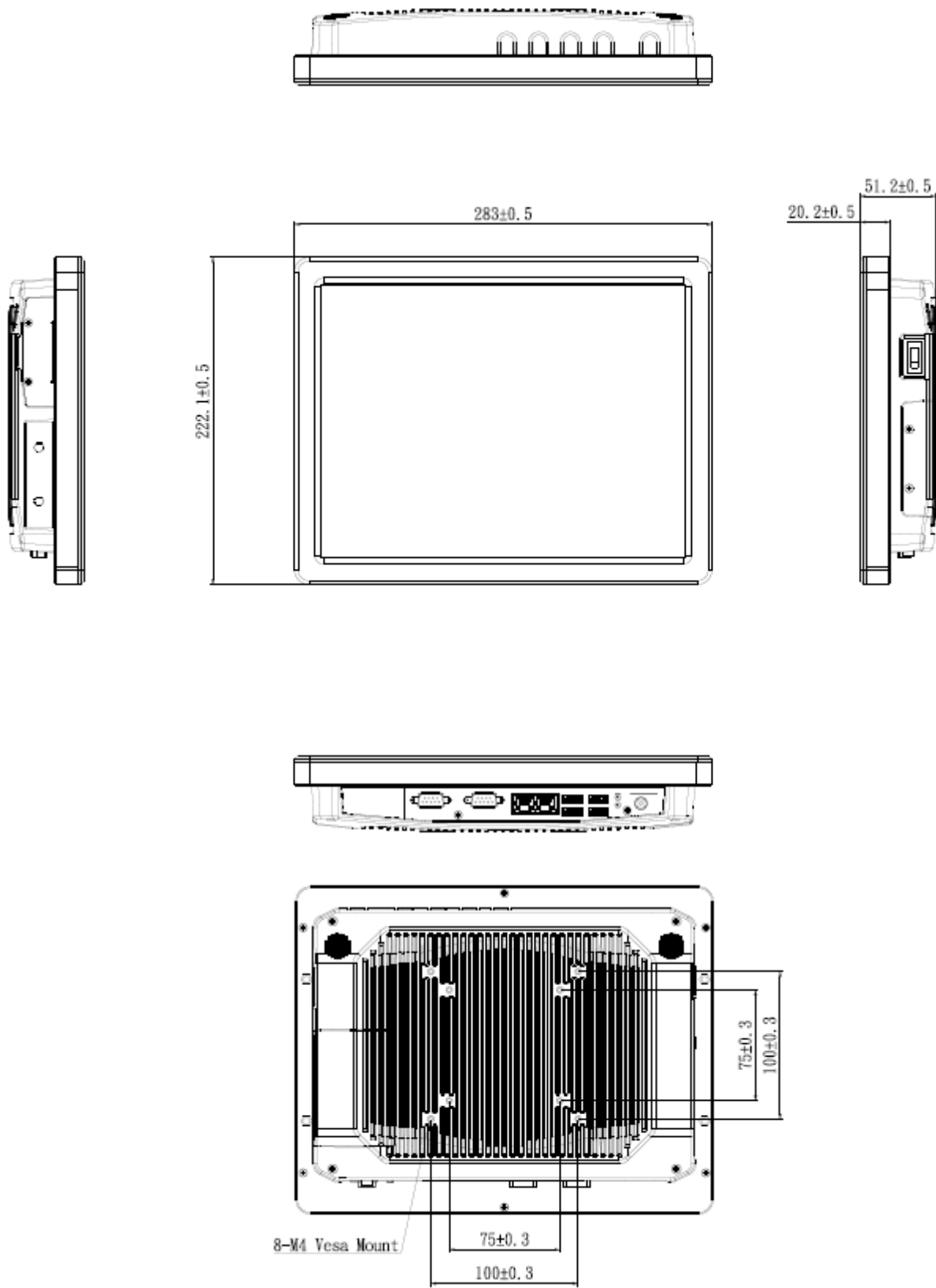

(Unit: mm)

2. Hardware Configuration

For advanced information, please refer to:

1- ARC-EHL, ARC-BYT DB-A/B/C/D/G/H/K included in this manual.



Note: If you need more information, please visit our website:

<http://www.avalue.com.tw>

2.1 ARC-1235 connector mapping

2.1.1 Serial port 1 connector (COM1)

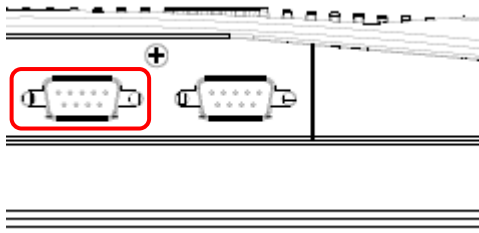

RS-485

Signal	PIN	PIN	Signal
DATA-	1	6	NC
DATA+	2	7	NC
NC	3	8	NC
NC	4	9	NC
GND	5		

Please set BIOS & JCOM1_SEL1

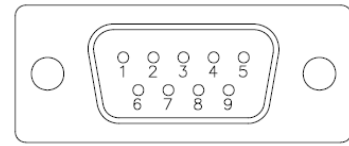

RS-232

Signal	PIN	PIN	Signal
NDCDA#	1	6	NDSRA#
NRXDA	2	7	NRTSA#
NTXDA	3	8	NCTSA#
NDTRA#	4	9	NRIA#
GND	5		

RS-422

Signal	PIN	PIN	Signal
TxD-	1	6	NC
TxD+	2	7	NC
RxD+	3	8	NC
RxD-	4	9	NC
GND	5		

Please set BIOS & JCOM1_SEL1

2.1.2 Serial port 2 connector (COM2)

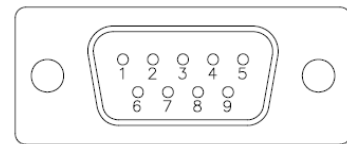
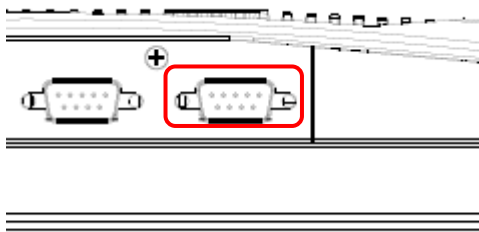

Signal	PIN	PIN	Signal
NDCDB#	1	6	NDSRB#
NRXDB	2	7	NRTSB#
NTXDB	3	8	NCTSB#
NDTRB#	4	9	NRIB#
GND	5		

2.2 Installing Memory

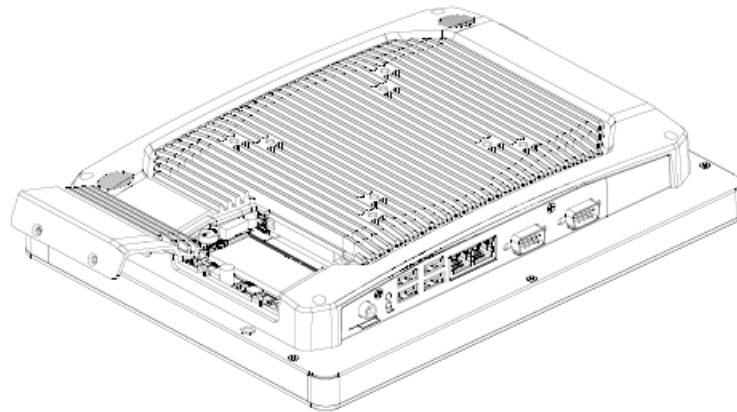
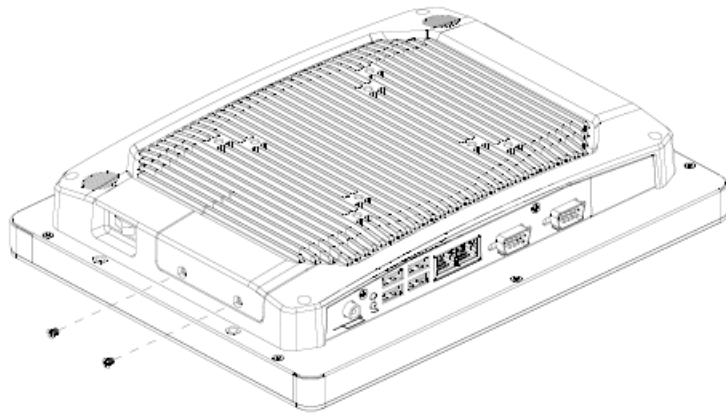

Step 1. Remove 2 screws to release the chassis cover, and remove it.

Step 2.1 Insert the SODIMM into the memory socket.

Step 2.2 Re-assemble your system back through previous steps to complete the installation.

2.3 ARC-EHL Overviews

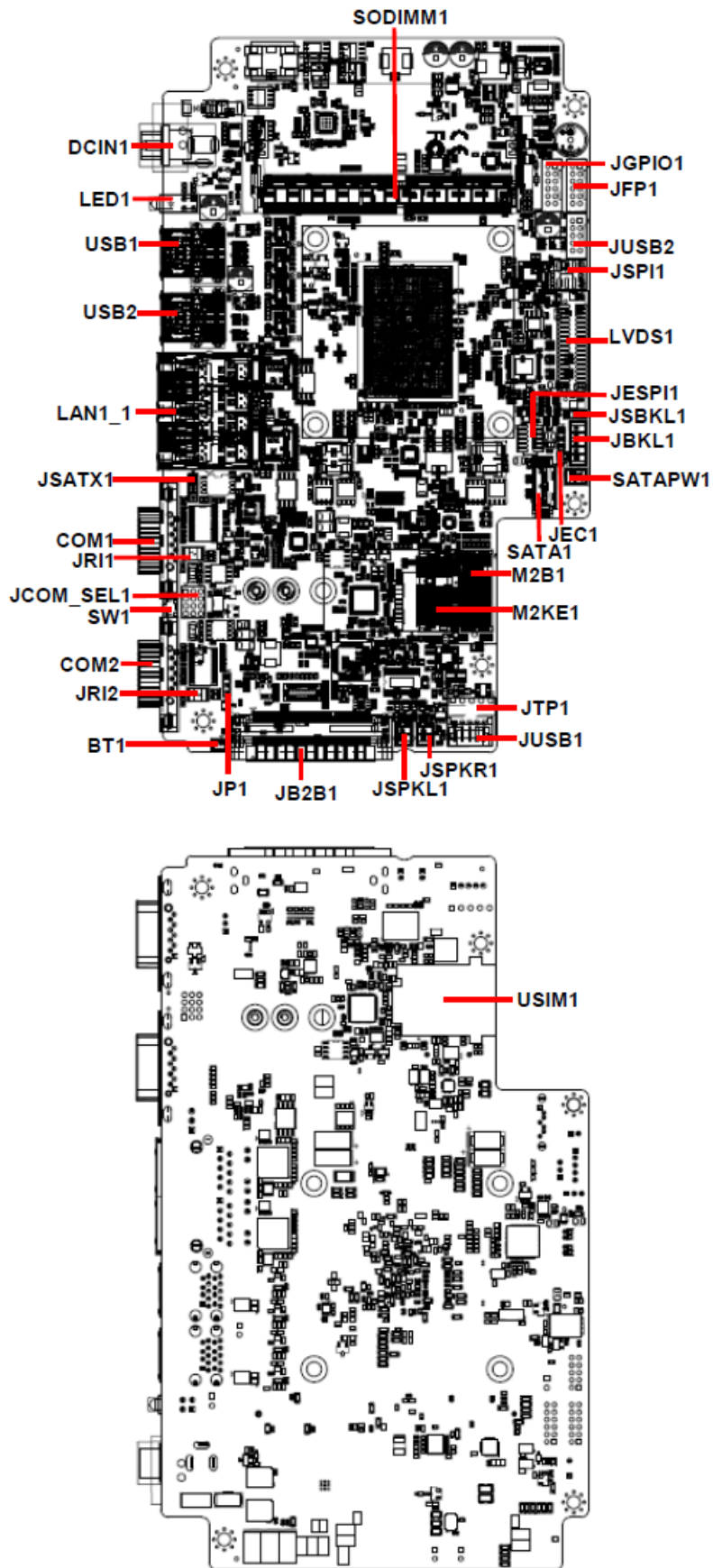

2.4 ARC-EHL Jumper and Connector list

Jumper

Label	Function	Note
JRI1/2	Serial port 1/2 pin9 signal select	3 x 2 header, pitch 2.00mm
JP1	M.2 KEY power select	3 x 1 header, pitch 2.00mm
JCOM_SEL1	Serial port 1 in RS-232/422/485 mode	4 x 3 header, pitch 2.00mm
JSBKL1	LCD backlight brightness adjustment	3 x 1 header, pitch 2.00mm
JSATX1	AT/ATX Input power select	3 x 1 header, pitch 2.54mm

Connectors

Label	Function	Note
SODIMM1	260-Pin DDR4 SO-DIMM	
JBKL1	LCD Inverter connector	5 x 1 wafer, pitch 2.00mm
COM1/2	Serial Port 1/2 connector	D-sub 9 pin, male
JSPKL1	AMPLIFIER_L	2 x 1 wafer, pitch 2.00mm
JSPKR1	AMPLIFIER_R	2 x 1 wafer, pitch 2.00mm
JB2B1	B2B connector	40 x 2 wafer, pitch 0.80mm
LED1	HDD/Power LED indicator	
LVDS1	LVDS connector	DIN 40-pin wafer, pitch 1.25mm
USB1/2	4 x USB3.2 connector	
JUSB1	On-board header for USB2.0	5 x 1 wafer, pitch 2.00mm
JUSB2	On-board header for USB2.0	5 x 2 wafer, pitch 2.00mm
LAN1_1	2 x RJ-45 Ethernet	
JFP1	Front Panel connector	6 x 2 wafer, pitch 2.00mm
BT1	Battery connector	2 x 1 wafer, pitch 1.25mm
JGPIO1	General purpose I/O connector	6 x 2 wafer, pitch 2.00mm
DCIN1	DC-IN connector	
JSPI1	SPI connector	4 x 2 header, pitch 2.00mm
SATA1	Serial ATA connector	
SATAPW1	SATA Power connector	2 x 1 wafer, pitch 2.00mm
SW1	Power button	
M2B1	M.2 KEY-B 2242/3042/3052 connector	
M2KE1	M.2 KEY-E 2230 connector	
JEC1	EC connector	3 x 1 header, pitch 2.00mm
JESPI1	ESPI connector	6 x 2 header, pitch 1.27mm

ARC-1235

JTP1	Touch connector	5 x 1 header, pitch 2.54mm
USIM1	SIM card slot	

2.5 ARC-EHL Jumpers & Connectors settings

2.5.1 Serial port 1/2 pin9 signal select (JRI1/2)

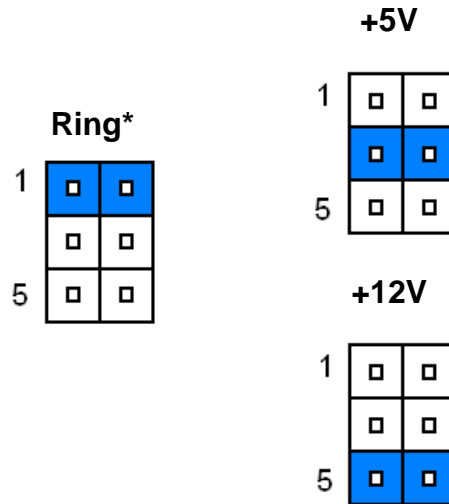
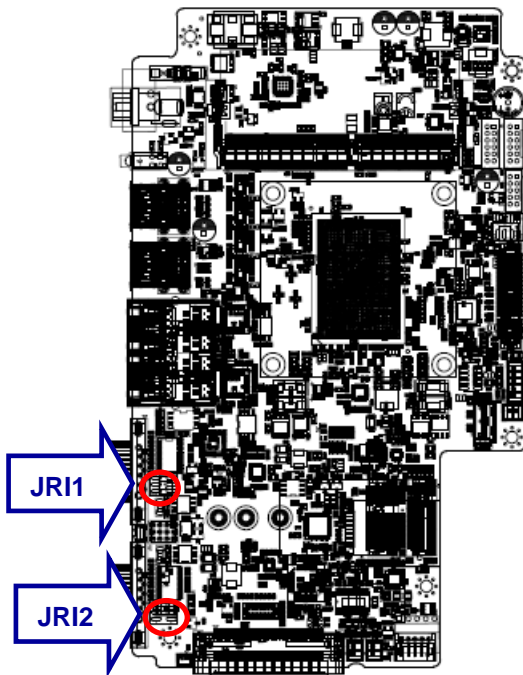

* Default

2.5.2 LCD backlight brightness adjustment (JSBKL1)

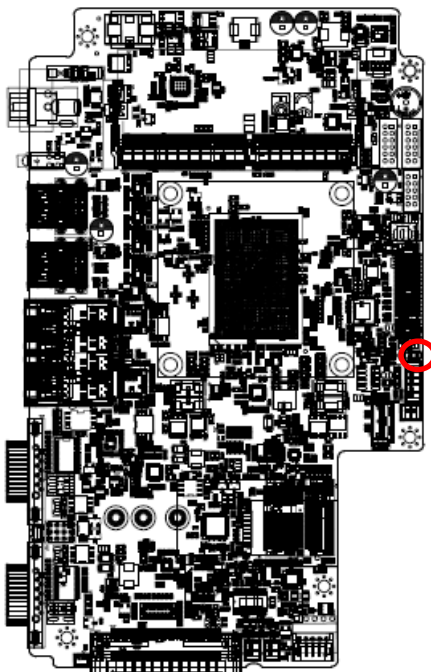

PWM Mode*

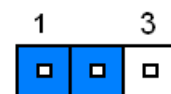

DC Mode

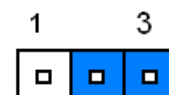

* Default

2.5.3 AT/ATX Input power select (JSATX1)

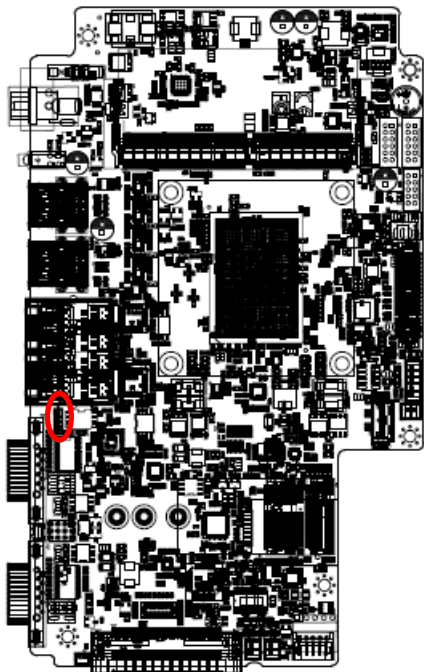

ATX*

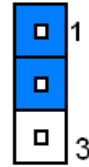

AT

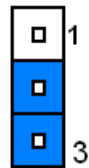

* Default

2.5.4 Serial port 1 in RS-232/422/485 mode (JCOM_SEL1)

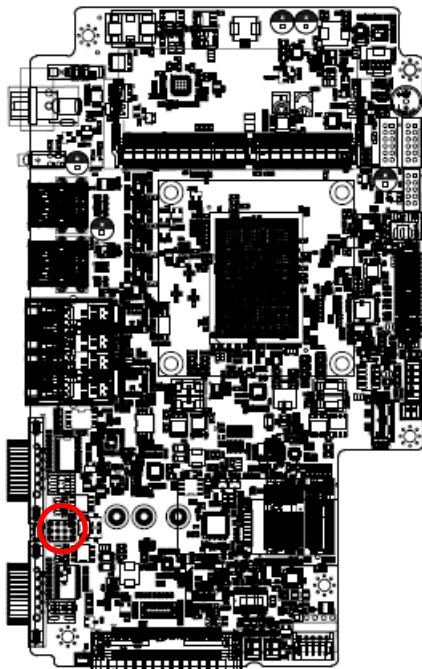

RS232*

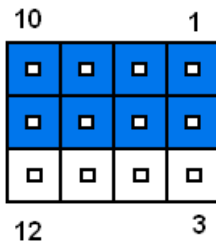

RS422

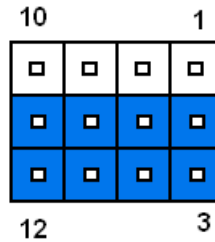

RS485

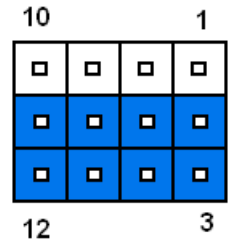

PIN	Signal	PIN	Signal	PIN	Signal
12	422RX1-	11	COM1-4	10	NDTRA#
9	485_422TX1+	8	COM1-2	7	NRXDA
6	422RX1+	5	COM1-3	4	NTXDA
3	485_422TX1-	2	COM1-1	1	NDCDA#

* Default

Note:

This connector is available after modify the mode of COM1 in BIOS setting.

2.5.5 M.2 KEY power select (JP1)

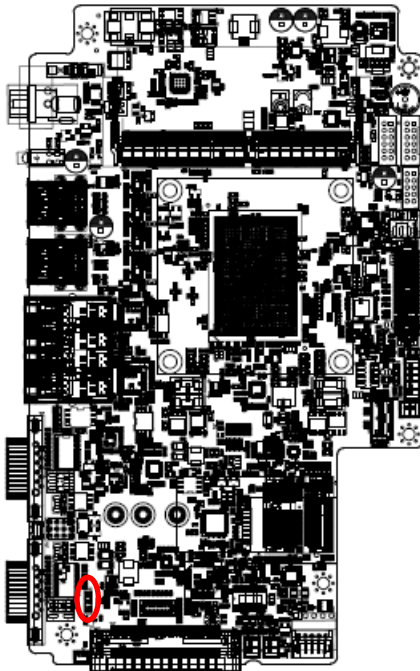

+3.8V

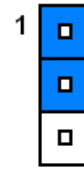

+3.3V*



*Default

2.5.6 LCD Inverter connector (JBKL1)

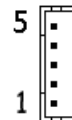
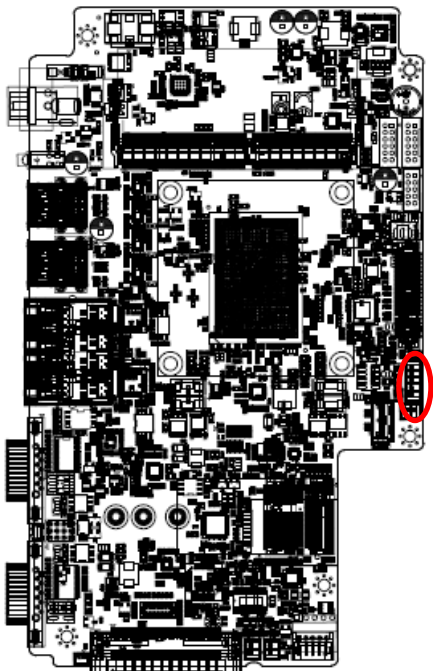

Signal	PIN
+5V	5
LVDS_BKLTCTL	4
LVDS_BKLT_EN	3
GND	2
+12V	1

2.5.7 Touch connector (JTP1) co-lay USB2.0 header (JUSB1)

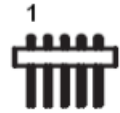
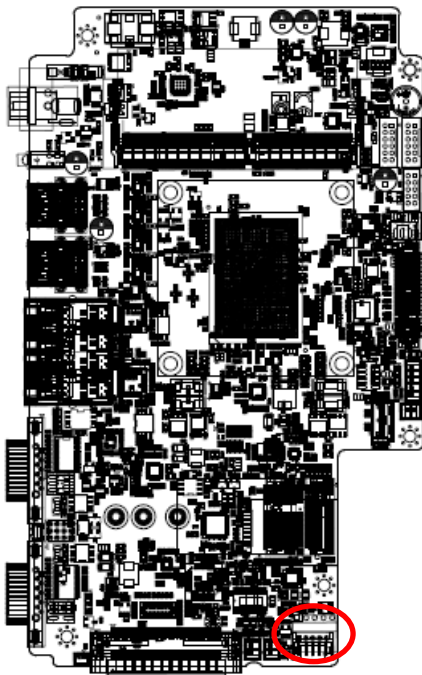

JTP1*

Signal	PIN
X+	1
X-	2
SENSE	3
Y+	4
Y-	5

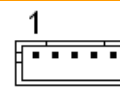

JUSB1

Signal	PIN
+5VSB	1
USB_WFR_PN8	2
USB_WFR_PP8	3
GND	4
GND	5

*Default

2.5.8 On-board header for USB2.0 (JUSB2)

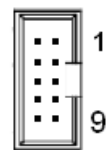
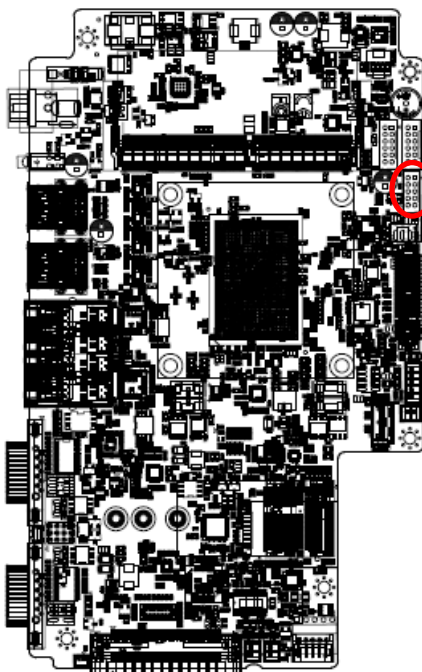

Signal	PIN	PIN	Signal
+5VSB	2	1	+5VSB
USB2_R_DN6	4	3	USB2_R_DN5
USB2_R_DP6	6	5	USB2_R_DP5
GND	8	7	GND
GND	10	9	GND

2.5.9 LVDS connector (LVDS1)

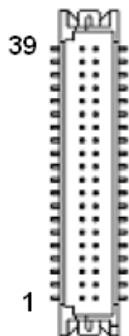
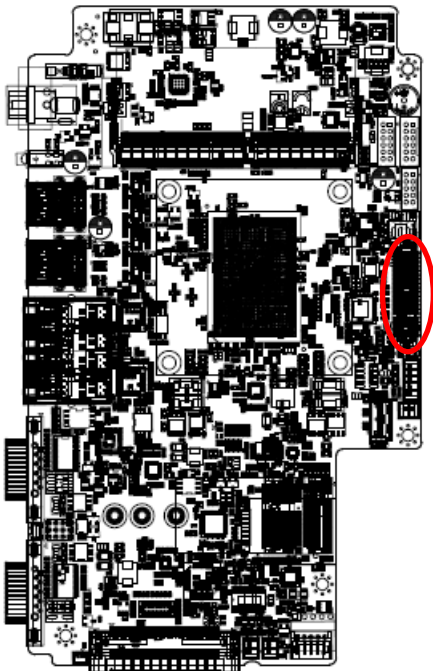

Signal	PIN	PIN	Signal
+12V	39	40	+12V
GND	37	38	LVDS_GND/EDP_HPDP
LVDS_CLK2_N	35	36	LVDS_CLK1_N
LVDS_CLK2_P	33	34	LVDS_CLK1_P
GND	31	32	GND
LVDS_DATA7_N	29	30	LVDS_DATA6_N
LVDS_DATA7_P	27	28	LVDS_DATA6_P
GND	25	26	GND
LVDS_DATA5_N/ EDP_TXN2	23	24	LVDS_DATA4_N
LVDS_DATA5_P/ EDP_TXP2	21	22	LVDS_DATA4_P
GND	19	20	GND
LVDS_DATA3_N/ EDP_TXN1	17	18	LVDS_DATA2_N/ EDP_AUXN
LVDS_DATA3_P/ EDP_TXP1	15	16	LVDS_DATA2_P/ EDP_AUXP
GND	13	14	GND
LVDS_DATA1_N/ EDP_TXN0	11	12	LVDS_DATA0_N/ EDP_TXN3
LVDS_DATA1_P/ EDP_TXP0	9	10	LVDS_DATA0_P/ EDP_TXP3
GND	7	8	GND
LVDS_DDC_CLK_R	5	6	LVDS_DDC_DATA_R
VCC_LVDS/EDP	3	4	+5V
VCC_LVDS/EDP	1	2	+5V

* Pin1 & 3 -- VCC_LVDS/EDP default 3.3V, BOM option 5/12V.

2.5.10 AMPLIFIER_R (JSPKR1)

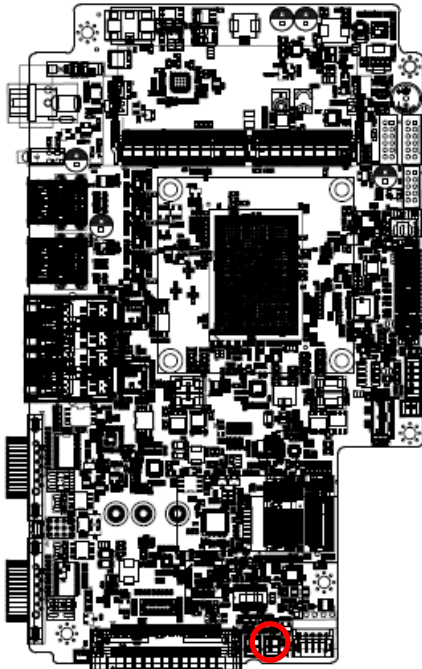

Signal	PIN
SPK_R-	2
SPK_R+	1

2.5.11 AMPLIFIER_L (JSPKL1)

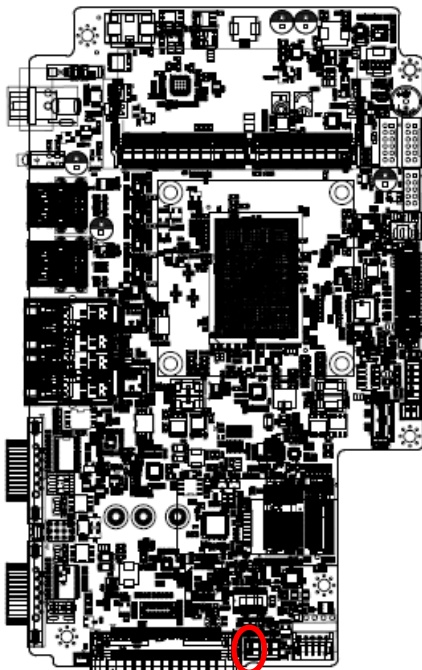

Signal	PIN
SPK_L-	2
SPK_L+	1

2.5.12 Battery connector (BT1)

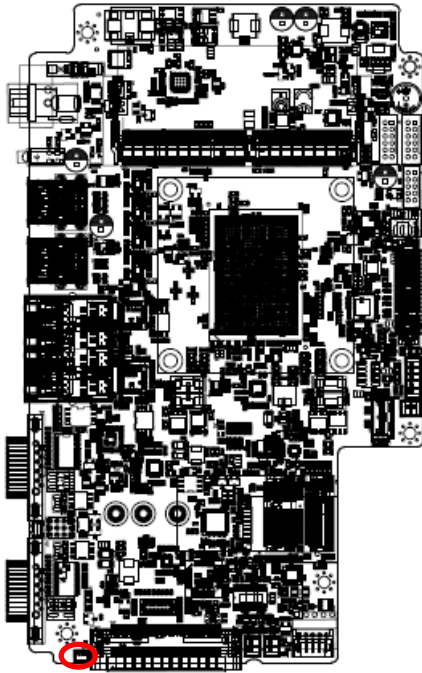

Signal	PIN
+RTCBATT	1
GND	2

2.5.13 SPI connector (JSPI1)

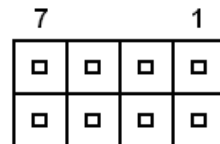
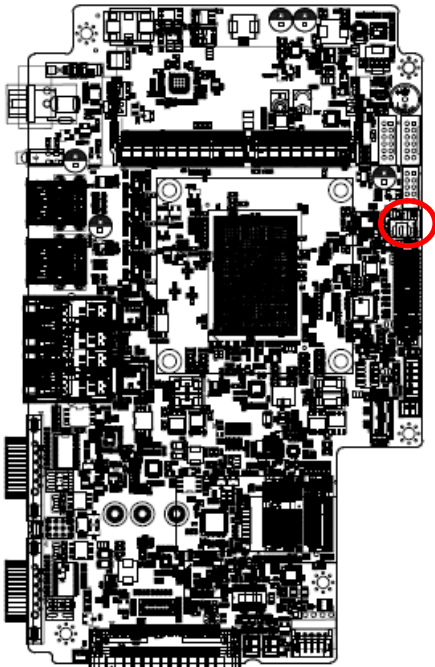

Signal	PIN	PIN	Signal
+3.3VSB	1	2	GND
ROM_CS#	3	4	ROM_SPI_CLK
ROM_SPI_MISO	5	6	ROM_SPI_MOSI
HOLD#	7	8	SPI_WP#

2.5.14 B2B connector (JB2B1)

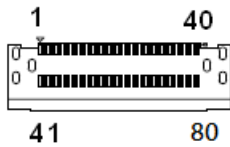
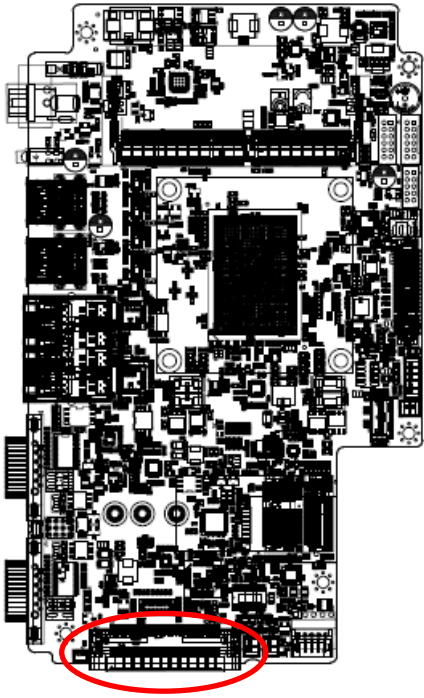

Signal	PIN	PIN	Signal
GND	1	41	GND
GND	2	42	GND
+12V	3	43	GND
+12V	4	44	GND
GND	5	45	GND
LPC_SERIRQ	6	46	+5VSB
LPC_LFRAME#	7	47	+5VSB
CLK_24M_B2B	8	48	+5VSB
LPC_AD0	9	49	+5VSB
LPC_AD1	10	50	+5VSB

Signal	PIN	PIN	Signal
LPC_AD2	11	51	GND
LPC_AD3	12	52	B2B_USB2_DP7
PS_ON_B2B	13	53	B2B_USB2_DN7
PLT_BUF_RST#	14	54	GND
PCH_SLP_S3#	15	55	SMB_SCL_S0
HDMI1_HPD_CONN	16	56	SMB_SDA_S0
GND	17	57	GND
HDMI1_DDC_CLK	18	58	B2B_BOARD_ID
HDMI1_DDC_DAT	19	59	PCIEUSB3_PONRSTB
GND	20	60	PCIEUSB3_SMIB_INT#
HDMI1_TX_N2	21	61	B2BPCIE_WAKE#
HDMI1_TX_P2	22	62	RST_B2BPCIE#
GND	23	63	CLK_B2B_REQ2#
HDMI1_TX_N1	24	64	GND
HDMI1_TX_P1	25	65	PCIE_TXN8
GND	26	66	PCIE_TXP8
HDMI1_TX_N0	27	67	GND
HDMI1_TX_P0	28	68	PCIE_RXN8
GND	29	69	PCIE_RXP8
HDMI1_CLKN	30	70	GND
HDMI1_CLKP	31	71	CLK_B2B_N2
GND	32	72	CLK_B2B_P2
GND	33	73	GND
MICIN_R	34	74	GND
MICIN_L	35	75	MIC1_JD
GND	36	76	GND
LINEOUT1_JD	37	77	LINE1-JD
LINEOUT_R	38	78	LINEIN_R
LINEOUT_L	39	79	LINEIN_L
GND	40	80	GND

2.5.15 General purpose I/O connector (JGPIO1)

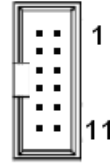
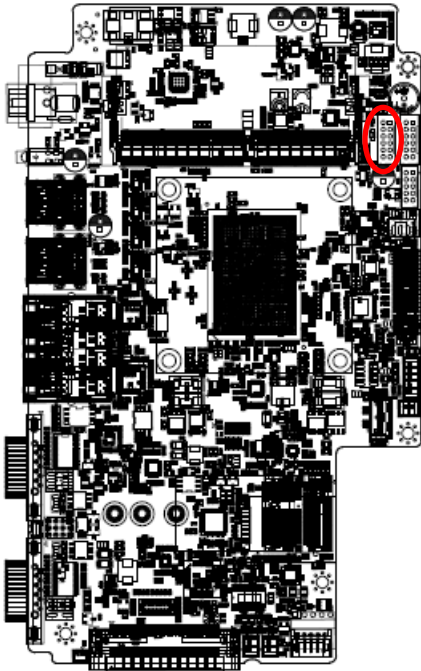

Signal	PIN	PIN	Signal
DO0	2	1	DI0
DO1	4	3	DI1
DO2	6	5	DI2
DO3	8	7	DI3
SMB_SCL_S0	10	9	SMB_SDA_S0
GND	12	11	+3.3V

2.5.16 SATA Power connector (SATAPW1)

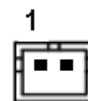
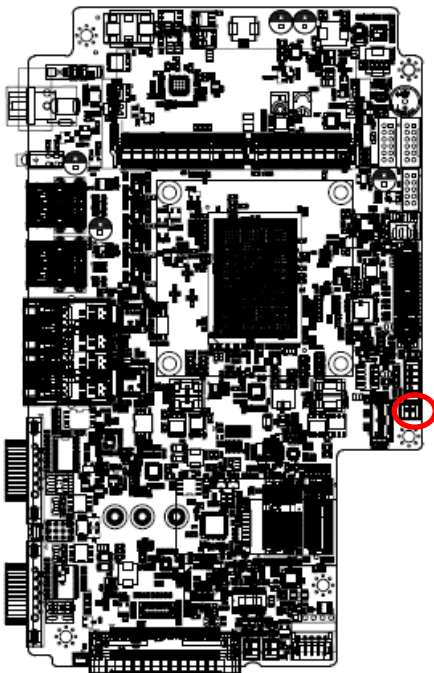

Signal	PIN
GND	1
+5V	2

2.5.17 Front Panel connector (JFP1)

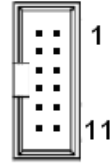
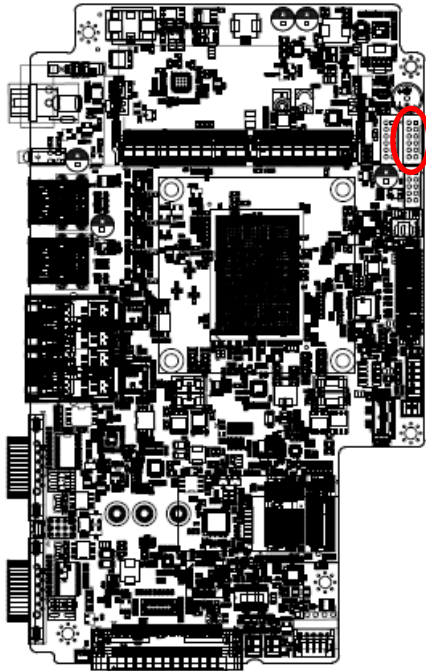

Signal	PIN
PWBT	1
	2
RST#	3
	4
PWR-LED-	5
PWR-LED+	6
HDD-LED-	7
HDD-LED+	8
LAN1-LED-	9
LAN1-LED+	10
LAN2-LED-	11
LAN2-LED+	12

2.5.18 ESPI connector (JESPI1)

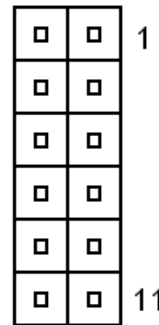
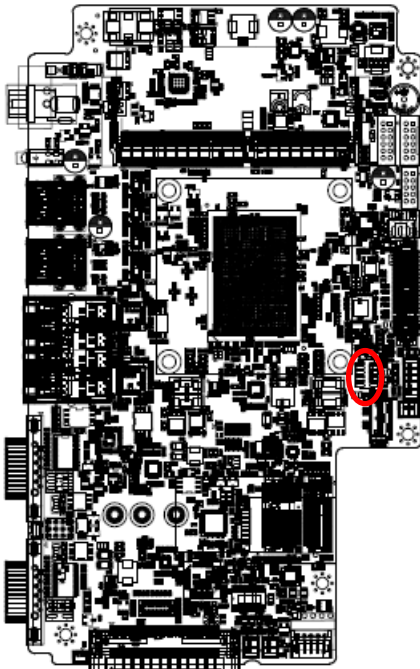

Signal	PIN	PIN	Signal
+3.3VSB	2	1	CN_ESPI_IO0
PLT_BUF_RST#	4	3	CN_ESPI_IO1
ESPI_CS#0	6	5	CN_ESPI_IO2
CN_ESPI_CLK	8	7	CN_ESPI_IO3
GND	10	9	NC
ESPI_ALERT#2	12	11	ESPI_RST#

2.5.19 EC connector (JEC1)

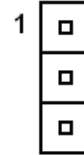
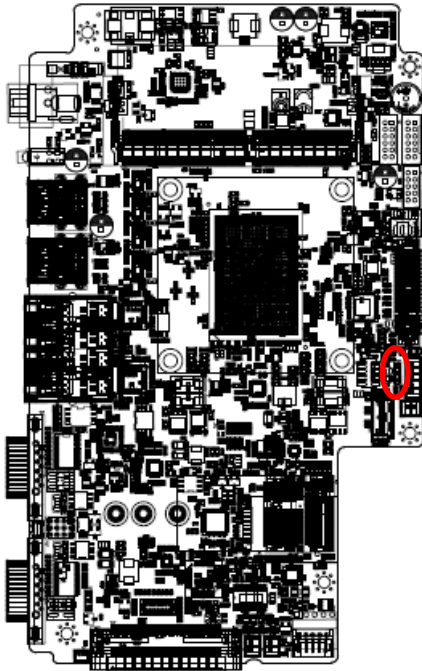

Signal	PIN
EC_SMDAT_DBG	1
EC_SMCLK_DBG	2
GND	3

2.6 ARC-BYT DB-A/B/C/D/G/H/K Overviews

2.6.1 ARC-BYT DB-A

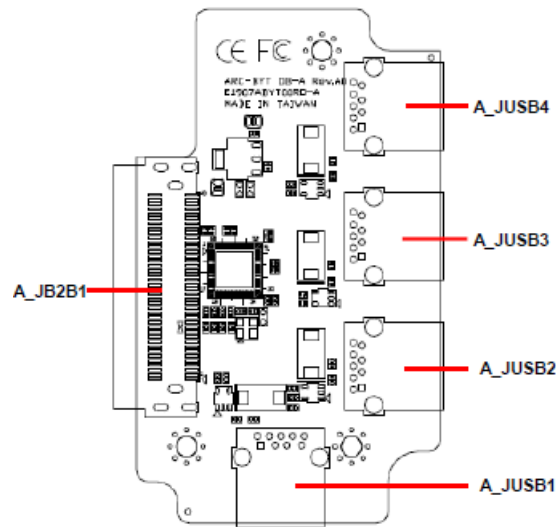

2.6.2 ARC-BYT DB-B

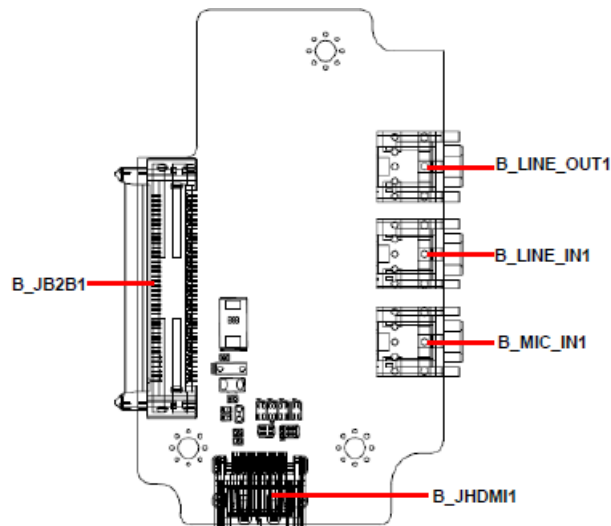

2.6.3 ARC-BYT DB-C

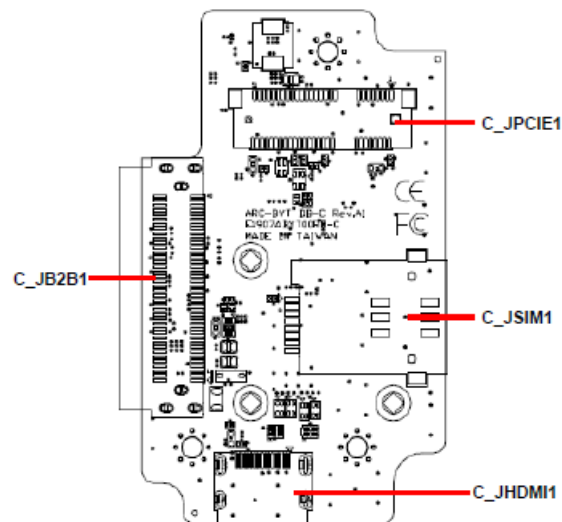

2.6.4 ARC-BYT DB-D

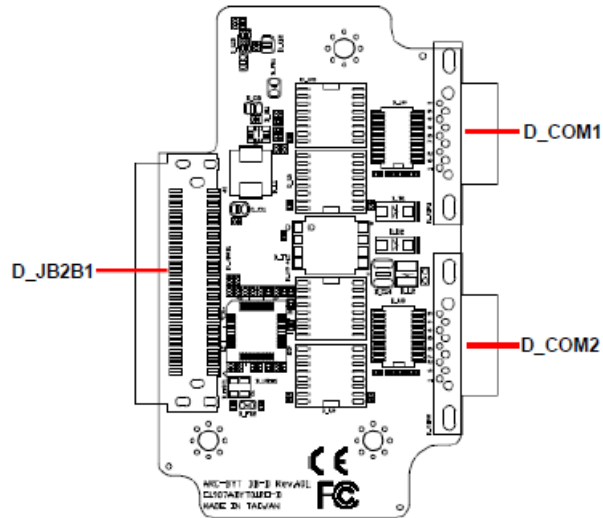

2.6.5 ARC-BYT DB-G

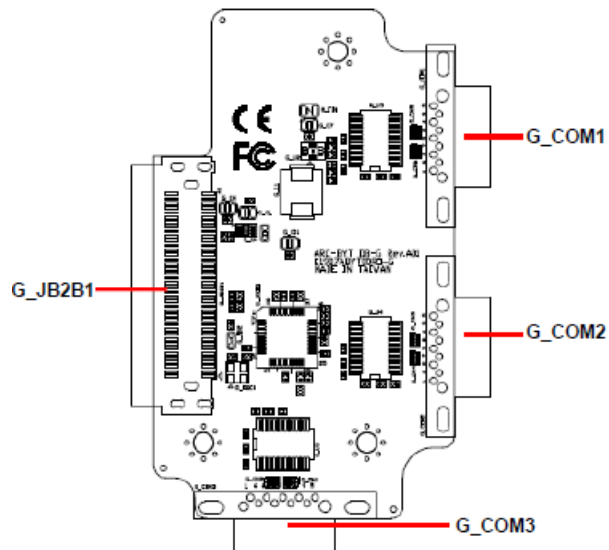

2.6.6 ARC-BYT DB-H

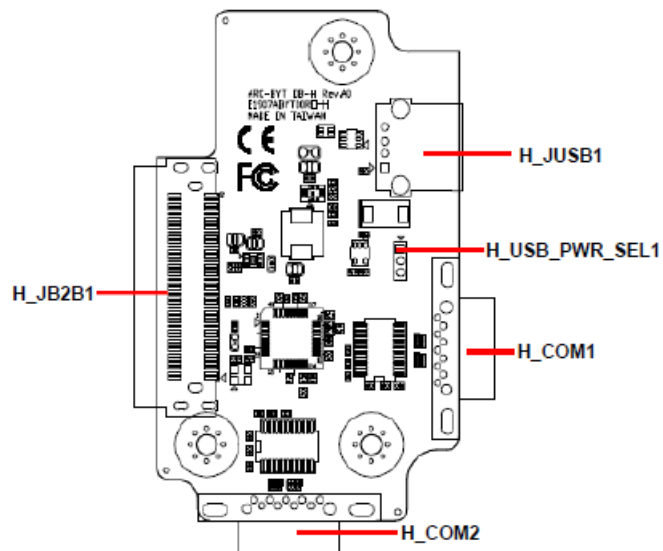

2.6.7 ARC-BYT DB-K

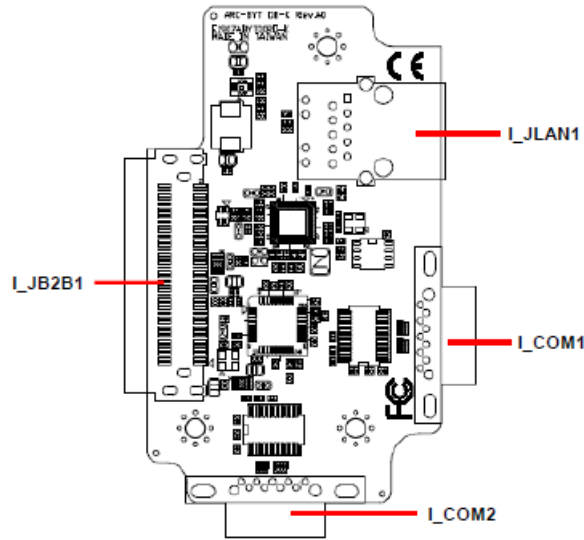

2.7 ARC-BYT DB-A/B/C/D/G/H/K Connector list

2.7.1 ARC-BYT DB-A

Connectors

Label	Function	Note
A_JUSB1~4	USB3.0 connector 1~4	
A_JB2B1	B2B connector	

2.7.2 ARC-BYT DB-B

Connectors

Label	Function	Note
B_LINE_OUT1	Line-out audio jack	
B_LINE_IN1	Line-in audio jack	
B_MIC_IN1	Mic-in audio jack	
B_JHDMI1	HDMI connector	
B_JB2B1	B2B connector	

2.7.3 ARC-BYT DB-C

Connectors

Label	Function	Note
C_JPCIE1	Mini PCI Express connector	
C_JSIM1	SIM card slot (Push-push)	
C_JHDMI1	HDMI connector	
C_JB2B1	B2B connector	

2.7.4 ARC-BYT DB-D

Connectors

Label	Function	Note
D_COM1/2	Serial Port 1/2 connector	DB-9 male connector
D_JB2B1	B2B connector	

2.7.5 ARC-BYT DB-G

Connectors

Label	Function	Note
G_COM1/2/3	Serial Port 1/2/3 connector	DB-9 male connector
G_JB2B1	B2B connector	

2.7.6 ARC-BYT DB-H

Jumpers

Label	Function	Note
H_USB_PWR_SEL1	USB Power selector	3 x 1 header, pitch 2.00mm

Connectors

Label	Function	Note
H_JUSB1	USB3.0 connector	
H_COM1/2	Serial Port 1/2 connector	DB-9 male connector
H_JB2B1	B2B connector	

2.7.7 ARC-BYT DB-K

Connectors

Label	Function	Note
I_JLAN1	RJ-45 Ethernet	
I_COM1/2	Serial Port 1/2 connector	DB-9 male connector
I_JB2B1	B2B connector	

2.8 ARC-BYT DB-D Connectors settings

2.8.1 Serial Port 1 connector (D_COM1)

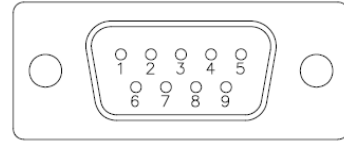
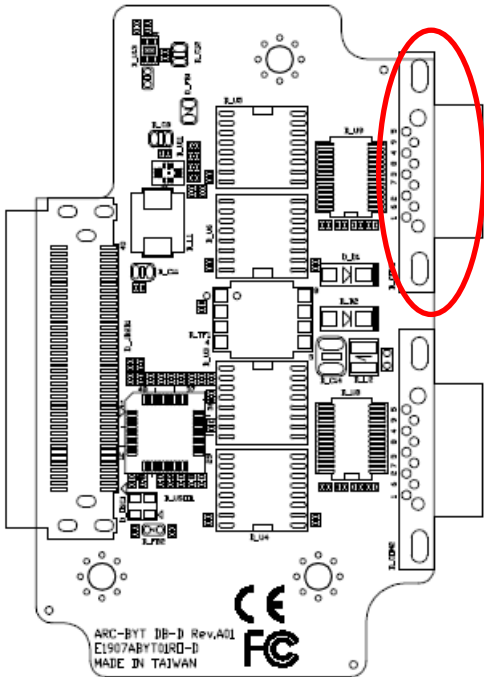

Signal	PIN	PIN	Signal
NDCD#_3_D	1	6	NDSR#_3_D
NRXD_3_D	2	7	NRTS#_3_D
NTXD_3_D	3	8	NCTS#_3_D
NDTR#_3_D	4	9	NRI#_3_D
GND	5		

2.8.2 Serial Port 2 connector (D_COM2)

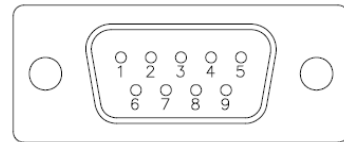
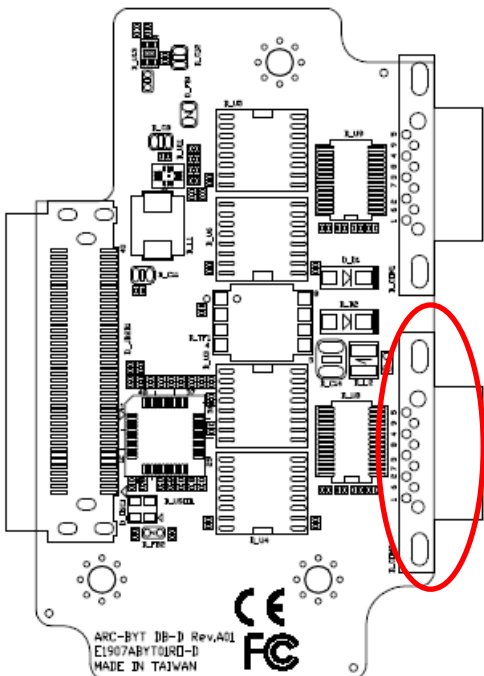

Signal	PIN	PIN	Signal
NDCD#_2_D	1	6	NDSR#_2_D
NRXD_2_D	2	7	NRTS#_2_D
NTXD_2_D	3	8	NCTS#_2_D
NDTR#_2_D	4	9	NRI#_2_D
GND	5		

2.9 ARC-BYT DB-G Connectors settings

2.9.1 Serial Port 1 connector (G_COM1)

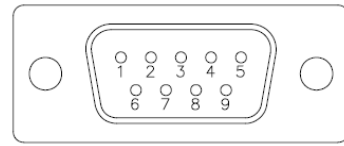
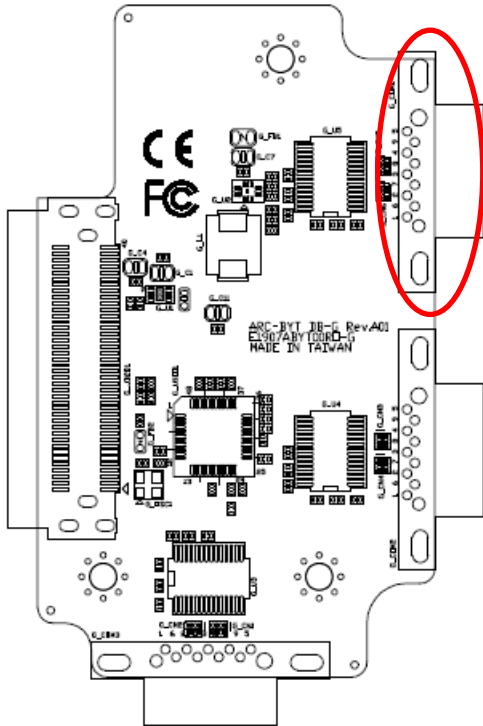

Signal	PIN	PIN	Signal
NDCD#_3_G	1	6	NDSR#_3_G
NRXD_3_G	2	7	NRTS#_3_G
NTXD_3_G	3	8	NCTS#_3_G
NDTR#_3_G	4	9	NRI#_3_G
GND	5		

2.9.2 Serial Port 2 connector (G_COM2)

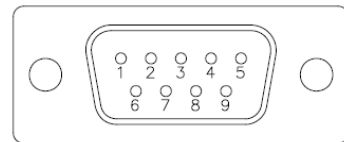
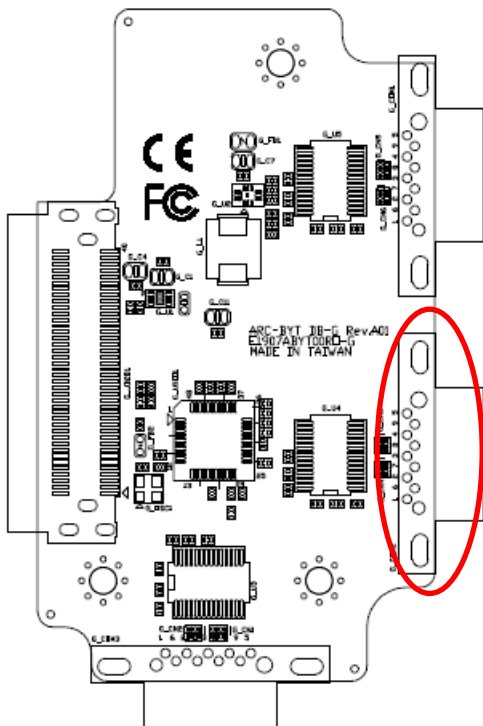

Signal	PIN	PIN	Signal
NDCD#_2_G	1	6	NDSR#_2_G
NRXD_2_G	2	7	NRTS#_2_G
NTXD_2_G	3	8	NCTS#_2_G
NDTR#_2_G	4	9	NRI#_2_G
GND	5		

2.9.3 Serial Port 3 connector (G_COM3)

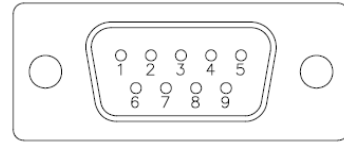
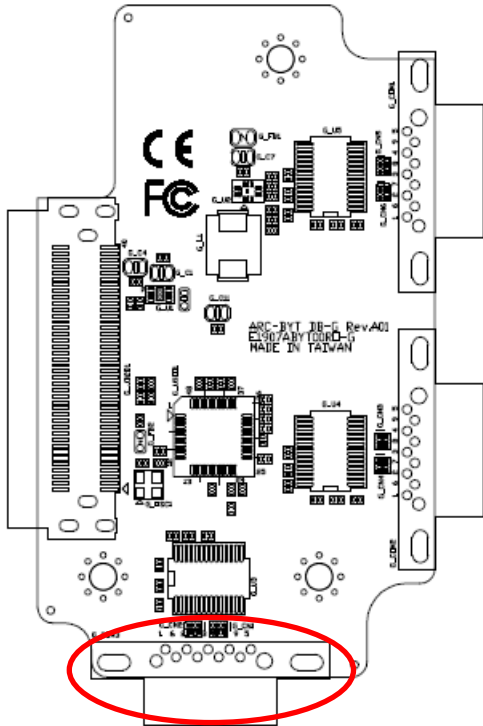

Signal	PIN	PIN	Signal
NDCD#_1_G	1	6	NDSR#_1_G
NRXD_1_G	2	7	NRTS#_1_G
NTXD_1_G	3	8	NCTS#_1_G
NDTR#_1_G	4	9	NRI#_1_G
GND	5		

2.10 ARC-BYT DB-H Jumpers settings

2.10.1 USB Power selector (H_USB_PWR_SEL1)

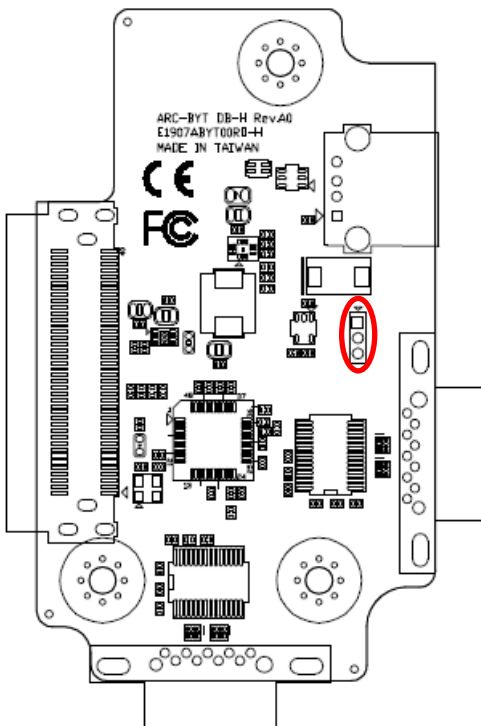

+5VSB*

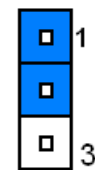

+5V

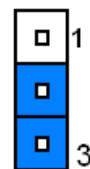

*Default

2.11 ARC-BYT DB-H Connectors settings

2.11.1 Serial Port 1 connector (H_COM1)

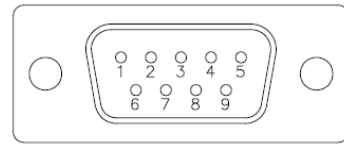
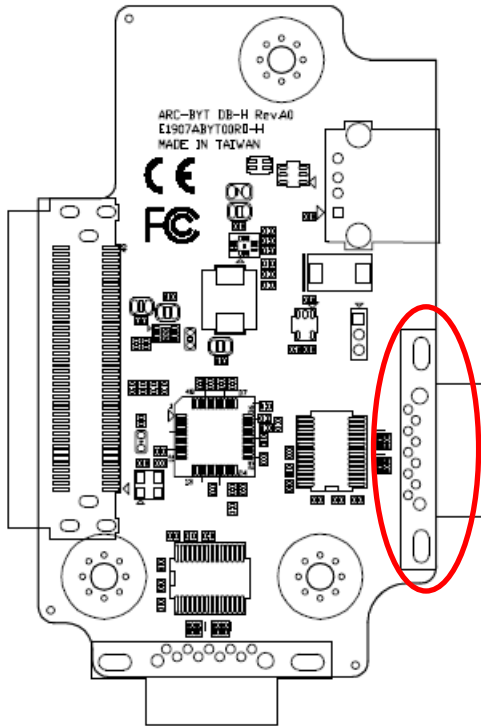

Signal	PIN	PIN	Signal
NDCD#_1_H	1	6	NDSR#_1_H
NRXD_1_H	2	7	NRTS#_1_H
NTXD_1_H	3	8	NCTS#_1_H
NDTR#_1_H	4	9	NRI#_1_H
GND	5		

2.11.2 Serial Port 2 connector (H_COM2)

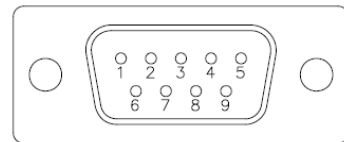
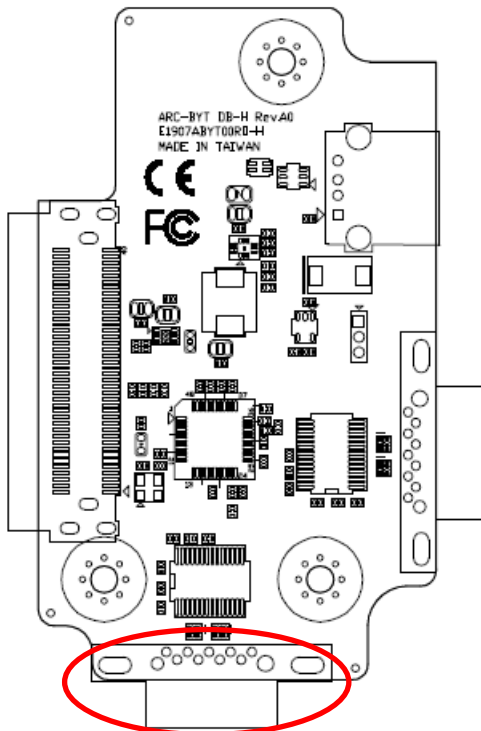

Signal	PIN	PIN	Signal
NDCD#_2_H	1	6	NDSR#_2_H
NRXD_2_H	2	7	NRTS#_2_H
NTXD_2_H	3	8	NCTS#_2_H
NDTR#_2_H	4	9	NRI#_2_H
GND	5		

2.12 ARC-BYT DB-K Connectors settings

2.12.1 Serial Port 1 connector (I_COM1)

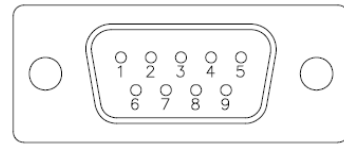
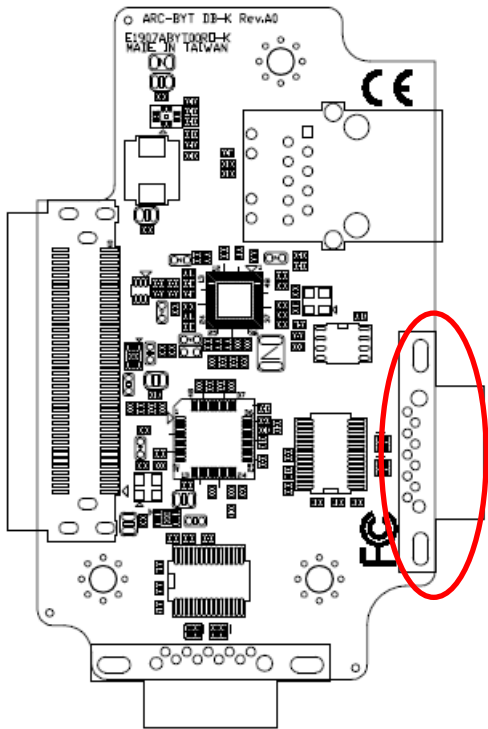

Signal	PIN	PIN	Signal
NDCD#_1_I	1	6	NDSR#_1_I
NRXD_1_I	2	7	NRTS#_1_I
NTXD_1_I	3	8	NCTS#_1_I
NDTR#_1_I	4	9	NRI#_1_I
GND	5		

2.12.2 Serial Port 2 connector (I_COM2)

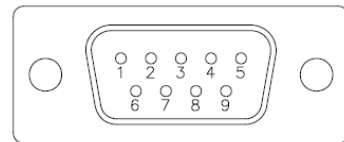
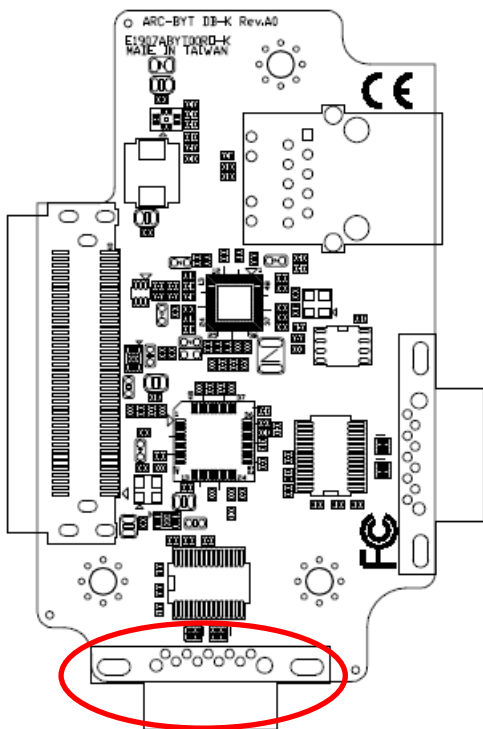

Signal	PIN	PIN	Signal
NDCD#_2_I	1	6	NDSR#_2_I
NRXD_2_I	2	7	NRTS#_2_I
NTXD_2_I	3	8	NCTS#_2_I
NDTR#_2_I	4	9	NRI#_2_I
GND	5		

3. BIOS Setup

3.1 Introduction

The BIOS setup program allows users to modify the basic system configuration. In this following chapter will describe how to access the BIOS setup program and the configuration options that may be changed.

3.2 Starting Setup

AMI BIOS™ is immediately activated when you first power on the computer. The BIOS reads the system information contained in the NVRAM and begins the process of checking out the system and configuring it. When it finishes, the BIOS will seek an operating system on one of the disks and then launch and turn control over to the operating system.

While the BIOS is in control, the Setup program can be activated in one of two ways:

By pressing <F2> or immediately after switching the system on, or

By pressing the <F2> or key when the following message appears briefly at the left-top of the screen during the POST (Power On Self Test).

Press <F2> or to enter SETUP

If the message disappears before you respond and you still wish to enter Setup, restart the system to try again by turning it OFF then ON or pressing the "RESET" button on the system case. You may also restart by simultaneously pressing <Ctrl>, <Alt>, and <Delete> keys.

3.3 Using Setup

In general, you use the arrow keys to highlight items, press <Enter> to select, use the PageUp and PageDown keys to change entries, press <F1> for help and press <Esc> to quit. The following table provides more detail about how to navigate in the Setup program using the keyboard.

Button	Description
↑	Move to previous item
↓	Move to next item
←	Move to the item in the left hand
→	Move to the item in the right hand
Esc key	Main Menu -- Quit and not save changes into NVRAM Status Page Setup Menu and Option Page Setup Menu -- Exit current page and return to Main Menu
+ key	Increase the numeric value or make changes
- key	Decrease the numeric value or make changes
F1 key	General help, only for Status Page Setup Menu and Option Page Setup Menu
F2 key	Previous Values
F3 key	Optimized defaults
F4 key	Save & Exit Setup

- **Navigating Through The Menu Bar**

Use the left and right arrow keys to choose the menu you want to be in.



Note: Some of the navigation keys differ from one screen to another.

- **To Display a Sub Menu**

Use the arrow keys to move the cursor to the sub menu you want. Then press <Enter>. A “➤” pointer marks all sub menus.

3.4 Getting Help

Press F1 to pop up a small help window that describes the appropriate keys to use and the possible selections for the highlighted item. To exit the Help Window press <Esc> or the F1 key again.

3.5 In Case of Problems

If, after making and saving system changes with Setup, you discover that your computer no longer is able to boot, the AMI BIOS supports an override to the NVRAM settings which resets your system to its defaults.

The best advice is to only alter settings which you thoroughly understand. To this end, we strongly recommend that you avoid making any changes to the chipset defaults. These defaults have been carefully chosen by both BIOS Vendor and your systems manufacturer to provide the absolute maximum performance and reliability. Even a seemingly small change to the chipset setup has the potential for causing you to use the override.

3.6 BIOS setup

Once you enter the Aptio Setup Utility, the Main Menu will appear on the screen. The Main Menu allows you to select from several setup functions and exit choices. Use the arrow keys to select among the items and press <Enter> to accept and enter the sub-menu.

3.6.1 Main Menu

This section allows you to record some basic hardware configurations in your computer and set the system clock.

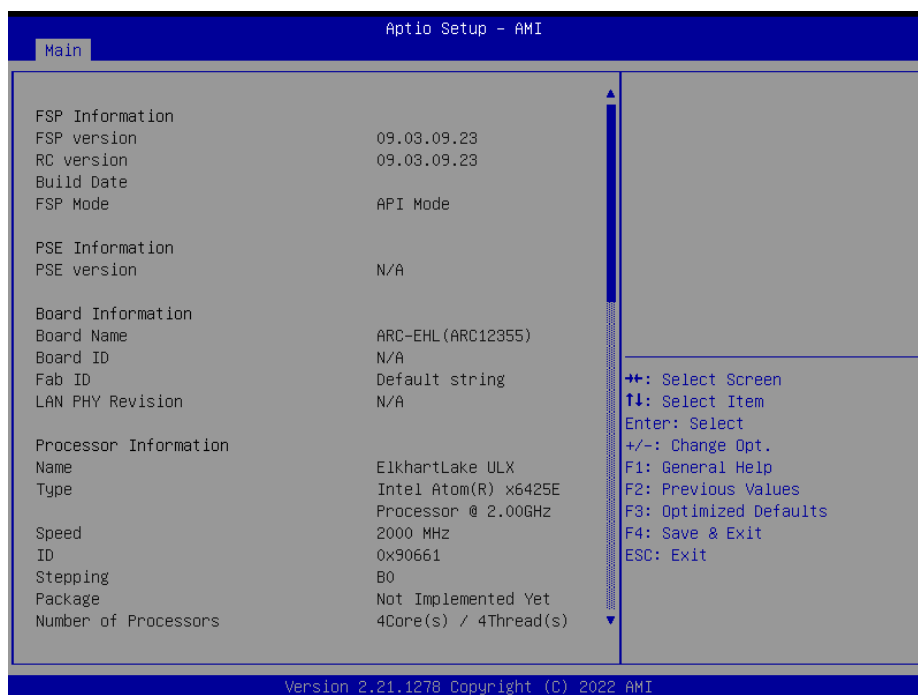
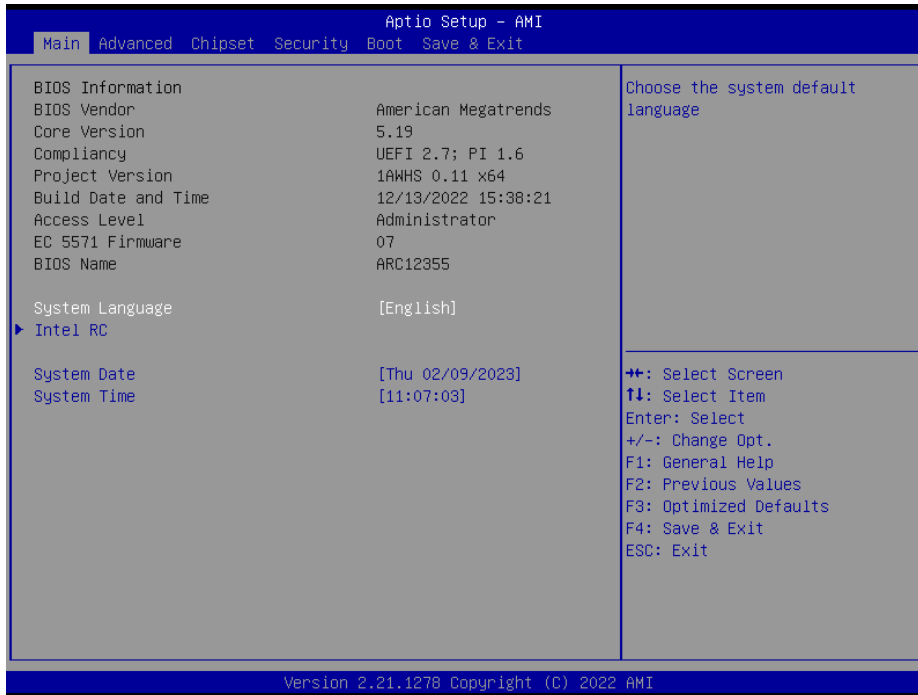

3.6.1.1 System Language

This option allows choosing the system default language.

3.6.1.2 System Date

Use the system date option to set the system date. Manually enter the day, month and year.

3.6.1.3 System Time

Use the system time option to set the system time. Manually enter the hours, minutes and seconds.



Note: The BIOS setup screens shown in this chapter are for reference purposes only, and may not exactly match what you see on your screen. Visit the Avalue website (www.avalue.com.tw) to download the latest product and BIOS information.

3.6.2 Advanced Menu

This section allows you to configure your CPU and other system devices for basic operation through the following sub-menus.



3.6.2.1 CPU Configuration

Use the CPU configuration menu to view detailed CPU specification and configure the CPU.

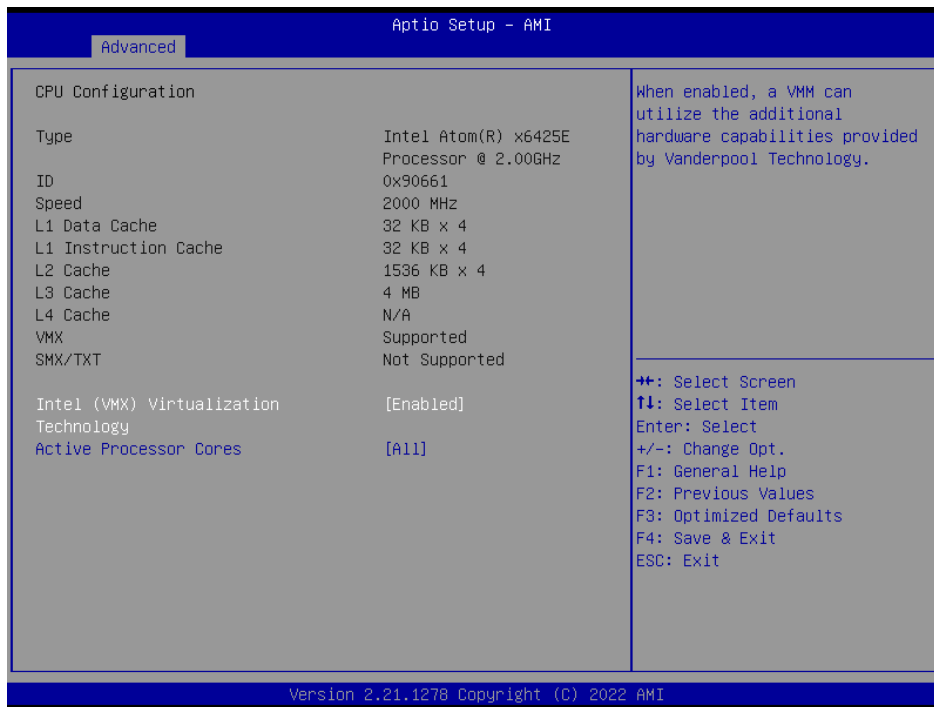

Item	Options	Description
Intel (VMX) Virtualization Technology	Disabled Enabled[Default]	When enabled, a VMM can utilize the additional hardware capabilities provided by Vanderpool Technology.
Active Processor Cores	All[Default] 1 2 3	Number of cores to enable in each processor package.

3.6.2.2 Power & Performance

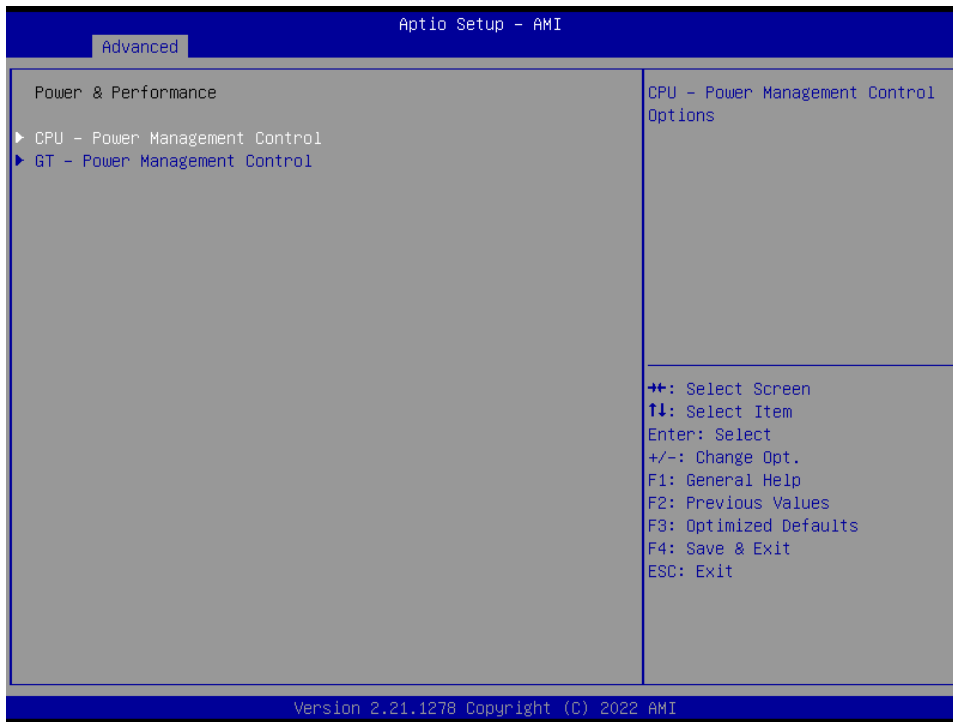

3.6.2.2.1 CPU – Power Management Control

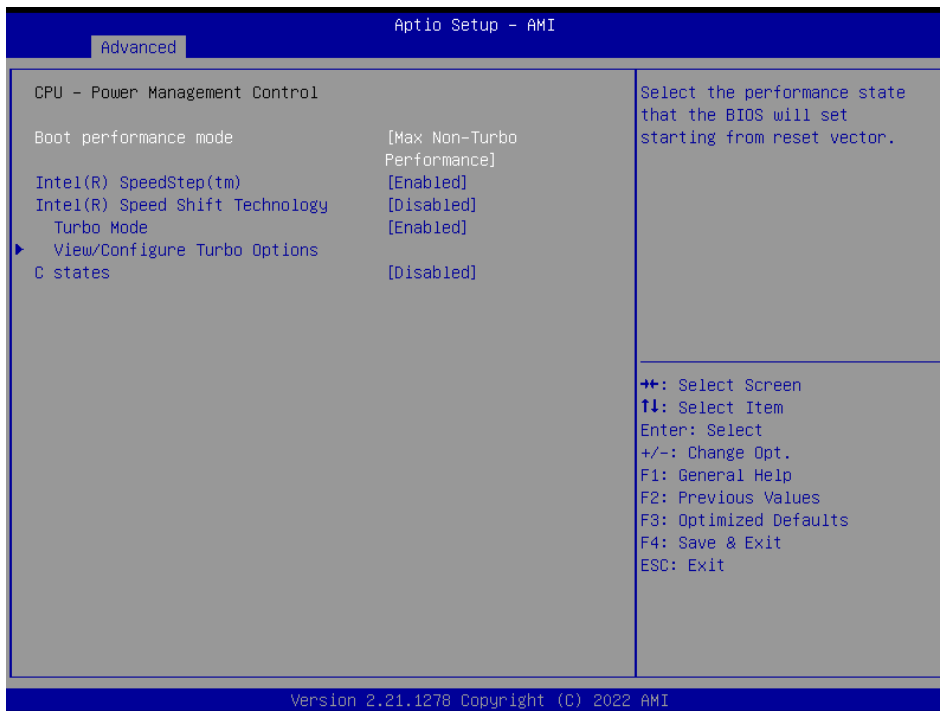

Item	Option	Description
Boot performance mode	Max Non-Turbo Performance[Default], Turbo Performance	Select the performance state that the BIOS will set starting from reset vector.
Intel® SpeedStep™	Enabled[Default], Disabled	Allows more than two frequency ranges to be supported.

<p>Intel® Speed Shift Technology</p>	<p>Enabled Disabled[Default],</p>	<p>Enable/Disable Intel® Speed Shift Technology support. Enabling will expose the CPPC v2 interface to allow for hardware controlled P-states.</p>
<p>Turbo Mode</p>	<p>Enabled[Default], Disabled</p>	<p>Enable/Disable processor Turbo Mode (requires EMTTM enabled too). AUTO means enabled.</p>
<p>C States</p>	<p>Enabled Disabled[Default],</p>	<p>Enable/Disable CPU Power Management. Allows CPU to go to C states when it's not 100% utilized.</p>

3.6.2.2.1.1 View/Configure Turbo Options

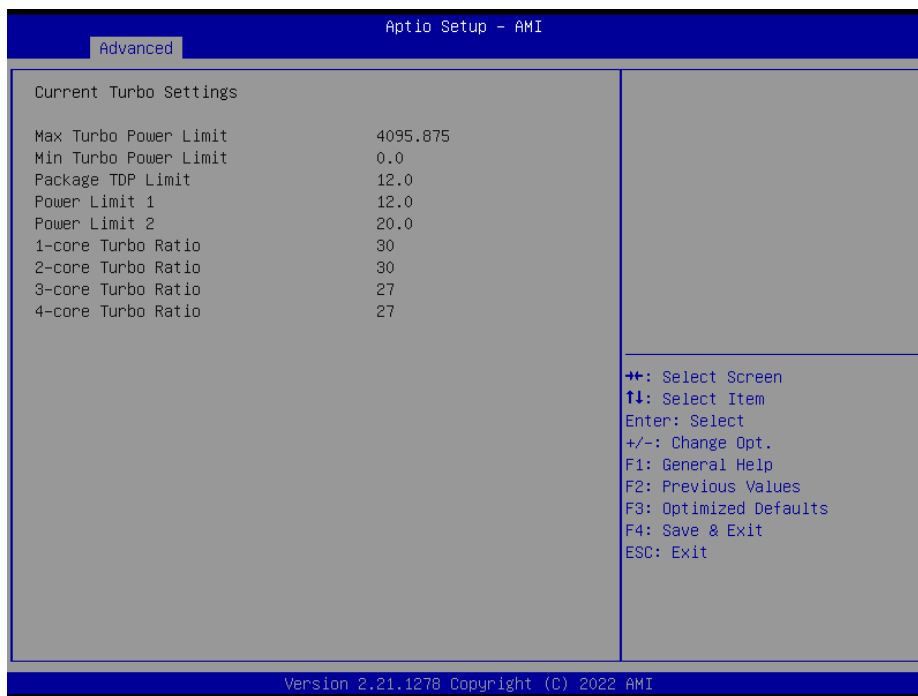

3.6.2.2.2 GT – Power Management Control

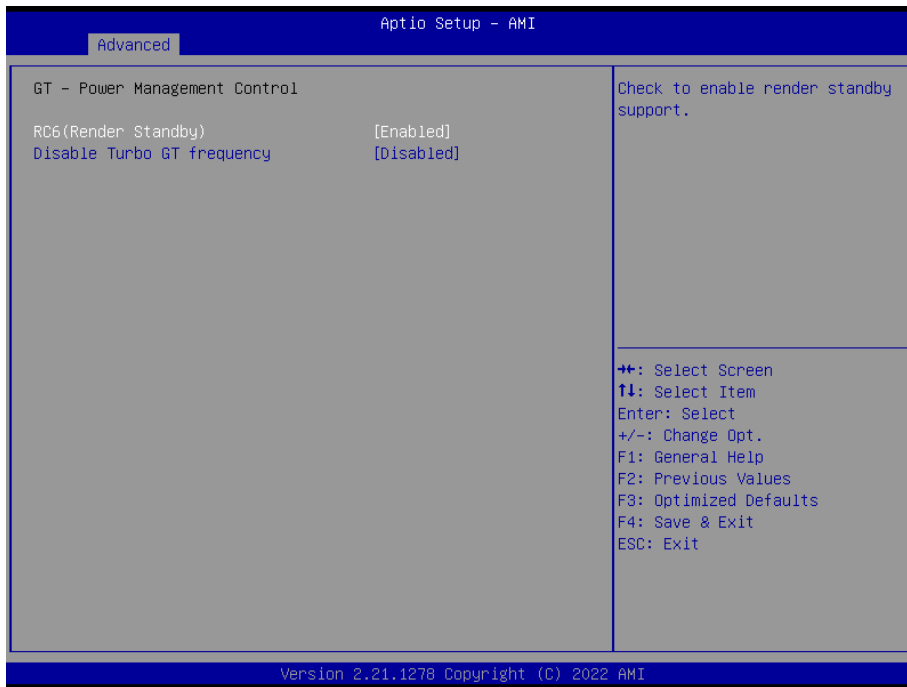

Item	Option	Description
RC6 (Render Standby)	Enabled[Default], Disabled	Check to enable render standby support.
Disable Turbo GT frequency	Enabled Disabled[Default]	Enabled: Disables Turbo GT frequency. Disabled: GT frequency is not limited.

3.6.2.3 PCH-FW Configuration

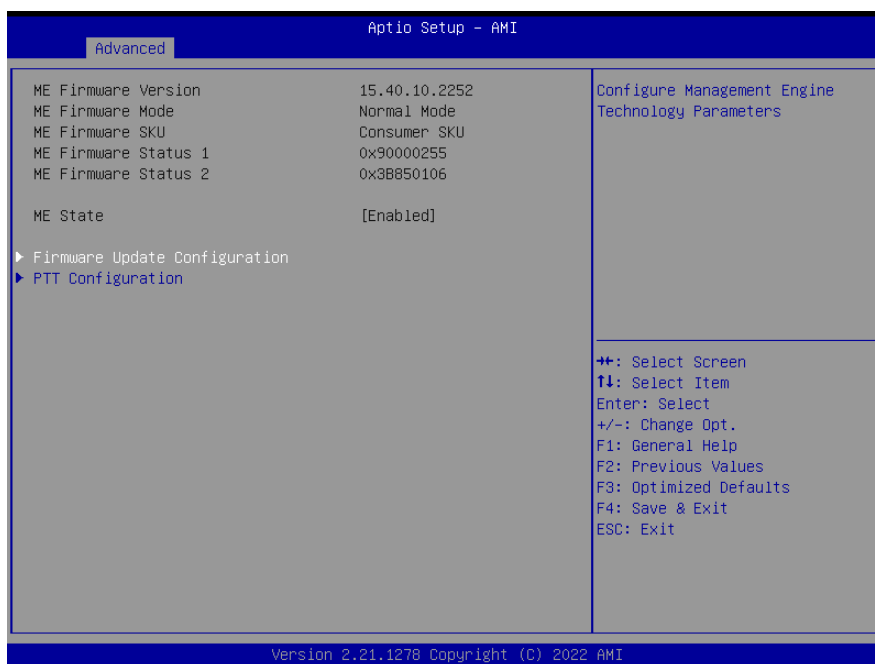

3.6.2.3.1 Firmware Update Configuration

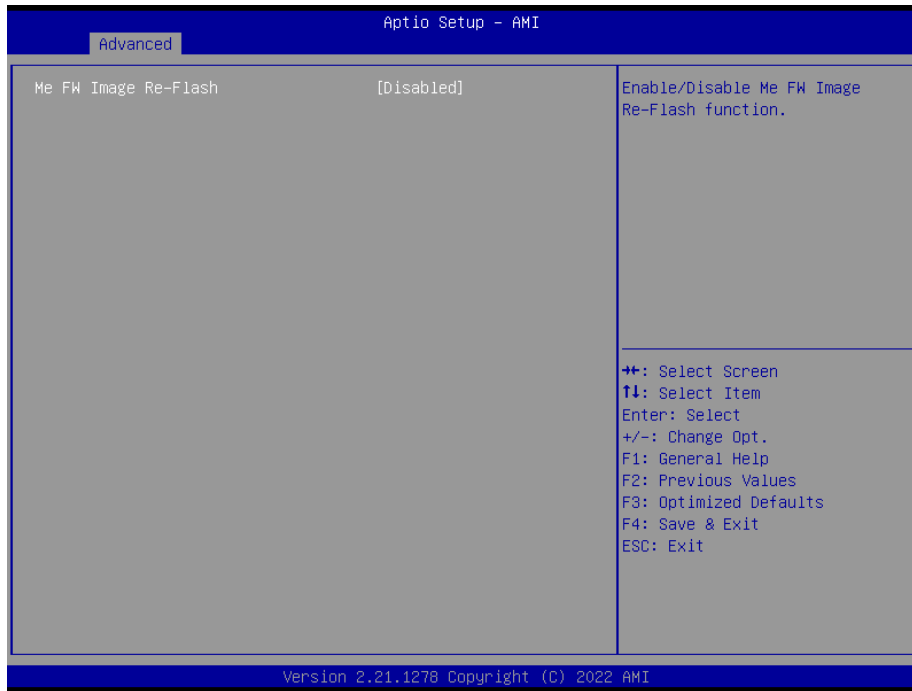

Item	Option	Description
ME FW Image Re-Flash	Disabled[Default], Enabled	Enable/Disable Me FW Image Re-Flash function.

3.6.2.3.2 PTT Configuration

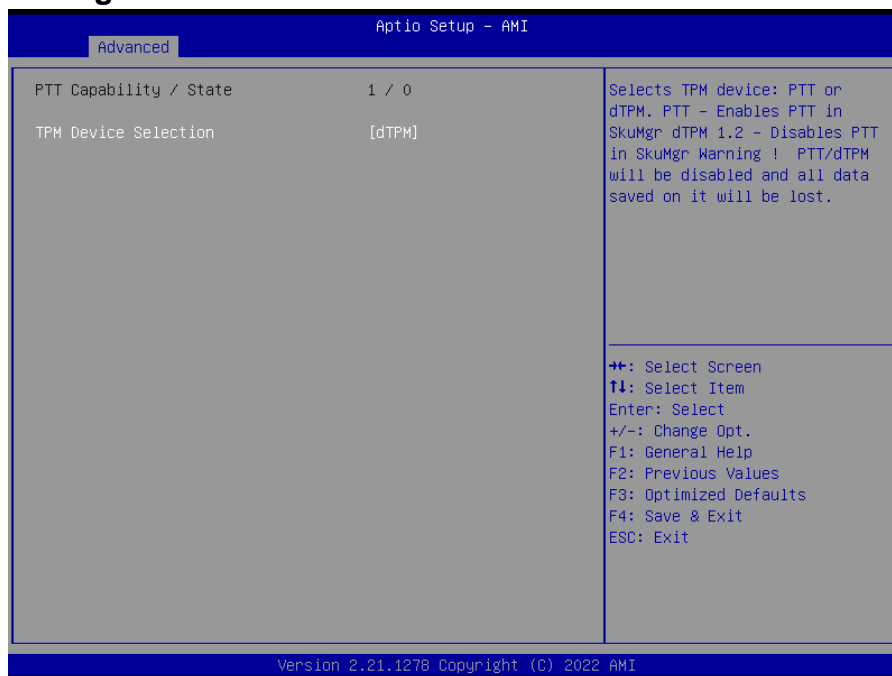

Item	Option	Description
TPM Device Selection	dTPM[Default], PTT	Select TPM device: PTT or dTPM. PTT – Enables PTT in SkuMgr dTPM 1.2 – Disables PTT in SkuMgr Warning! PTT/dTPM will be disabled and all data saved on it will be lost.

3.6.2.4 Trusted Computing

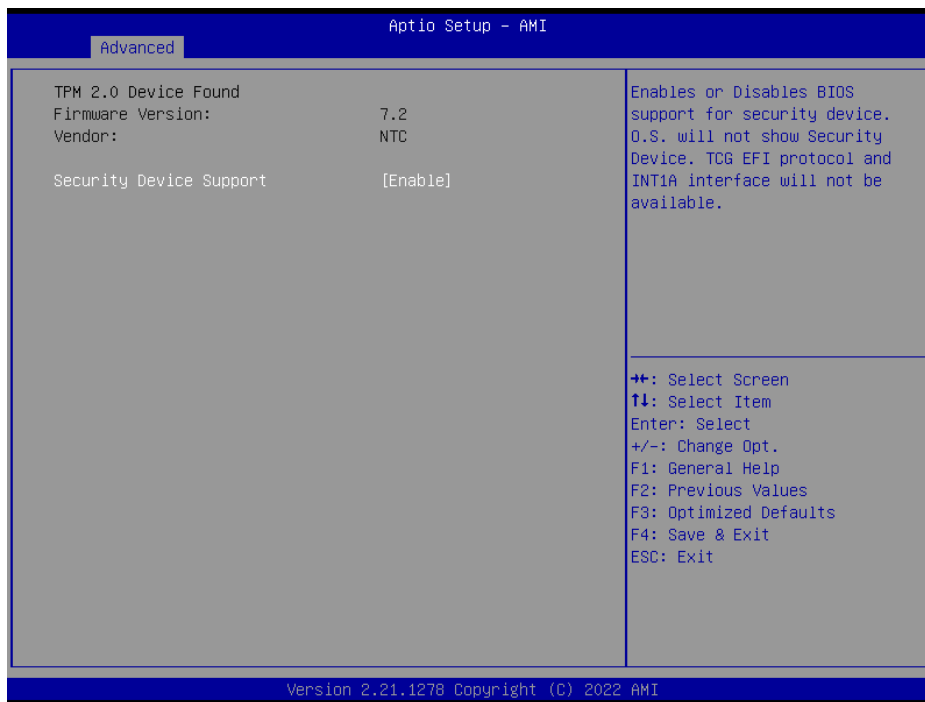

Item	Options	Description
Security Device Support	Disable, Enable [Default]	Enables or Disables BIOS support for security device. O.S. will not show Security Device. TCG EFI protocol and INT1A interface will not be available.

3.6.2.5 ACPI Settings

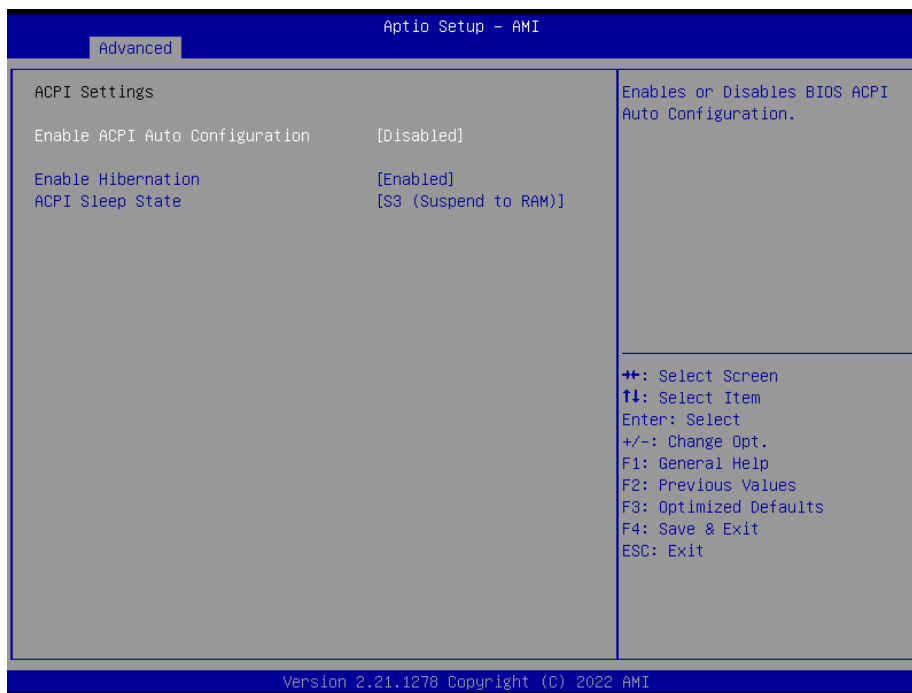

Item	Options	Description
Enable ACPI Auto Configuration	Disabled[Default], Enabled	Enables or Disables BIOS ACPI Auto Configuration.
Enable Hibernation	Disabled Enabled[Default],	Enables or Disables System ability to Hibernate (OS/S4 Sleep State). This option may not be effective with some OS.
ACPI Sleep State	Suspend Disabled, S3 (Suspend to RAM)[Default]	Select the highest ACPI sleep state the system will enter when the SUSPEND button is pressed.

3.6.2.6 Super IO Configuration

You can use this item to set up or change the Super IO configuration for serial ports. Please refer to 3.6.2.6.1 ~ 3.6.2.6.5 for more information.

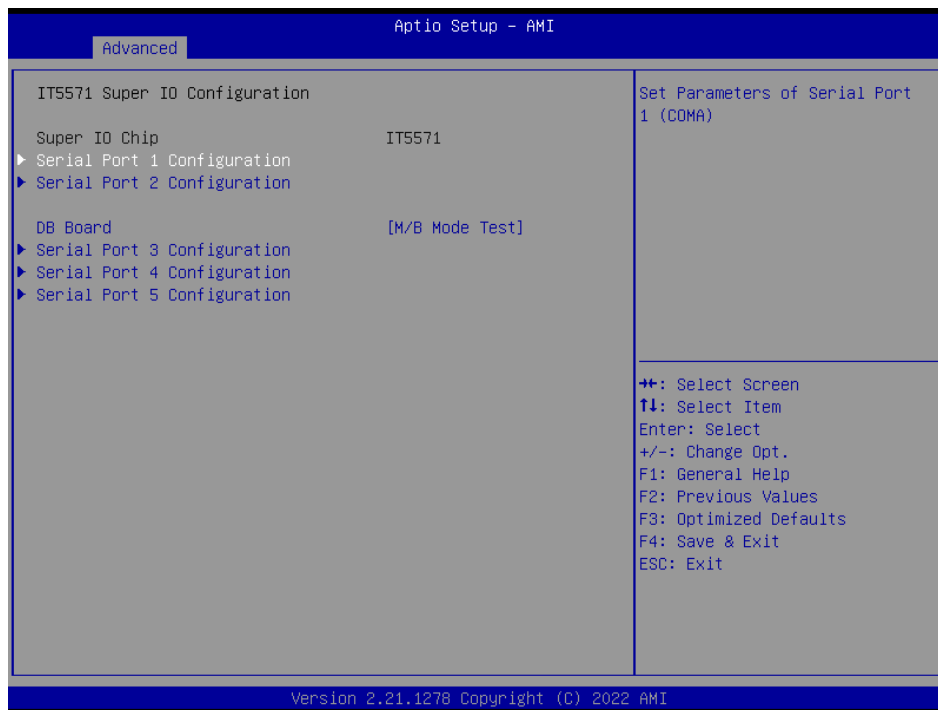

Item	Options	Description
DB Board	DB-A/C/E DB-B DB-F 1COM DB-D/H/K 2COM DB-G 3COM M/B Mode Test[Default],	DB Board A-K: DB-A/B/C/E w/o UART DB-G w/t 3UART DB-D/H/K w/t 2UART DB-F w/t 1UART.
Serial Port 1 Configuration	Set Parameters of Serial Port 1 (COMA).	
Serial Port 2 Configuration	Set Parameters of Serial Port 2 (COMB).	
Serial Port 3 Configuration	Set Parameters of Serial Port 3 (COMC).	
Serial Port 4 Configuration	Set Parameters of Serial Port 4 (COMD).	
Serial Port 5 Configuration	Set Parameters of Serial Port 5 (COME).	

3.6.2.6.1 Serial Port 1 Configuration

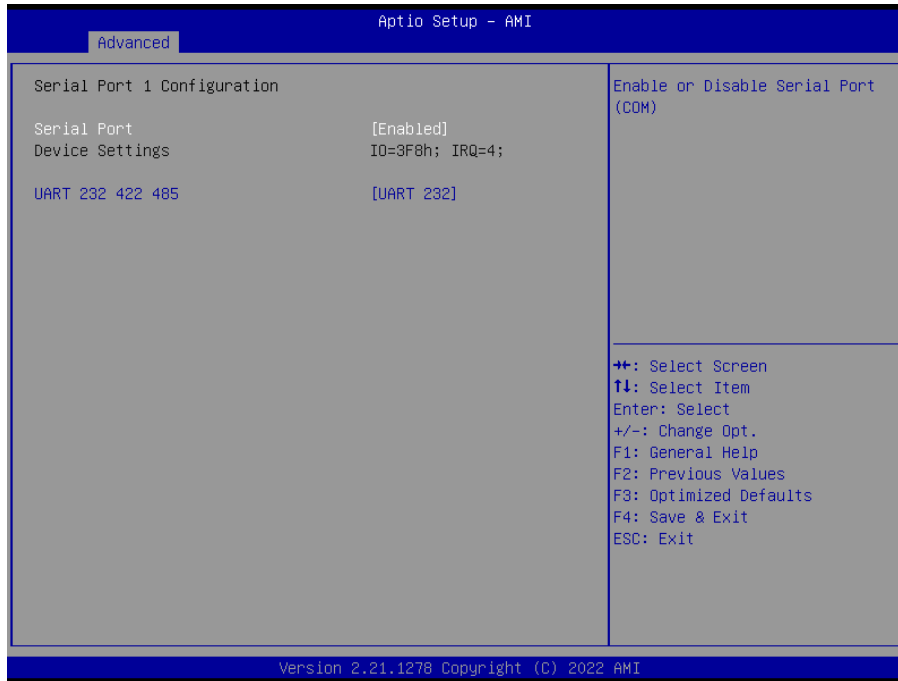

Item	Option	Description
Serial Port	Enabled[Default], Disabled	Enable or Disable Serial Port (COM).
UART 232 422 485	UART 232[Default] UART 422 UART 485	Change the Serial Port as RS232/422/485.

3.6.2.6.2 Serial Port 2 Configuration

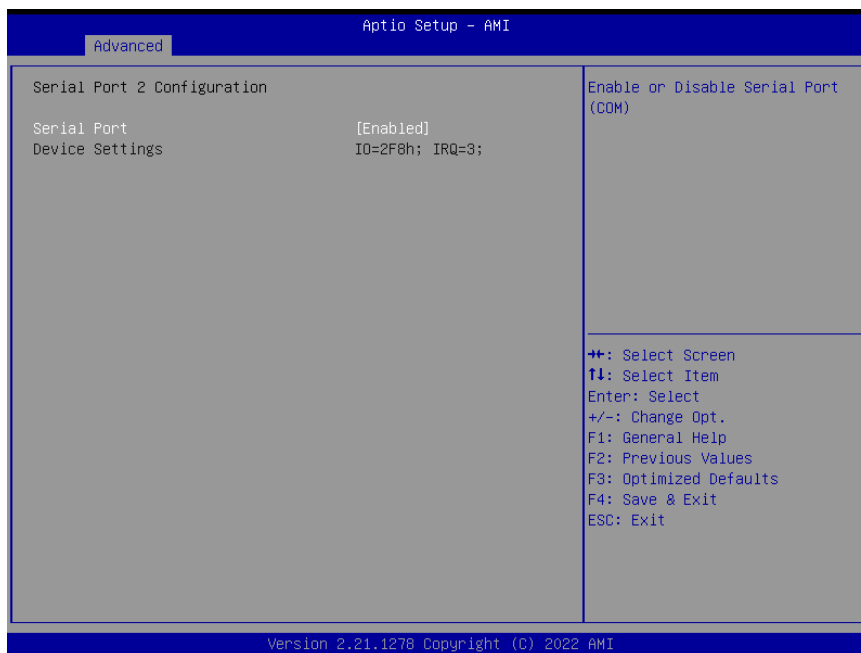

Item	Option	Description
Serial Port	Enabled[Default], Disabled	Enable or Disable Serial Port (COM).

3.6.2.6.3 Serial Port 3 Configuration

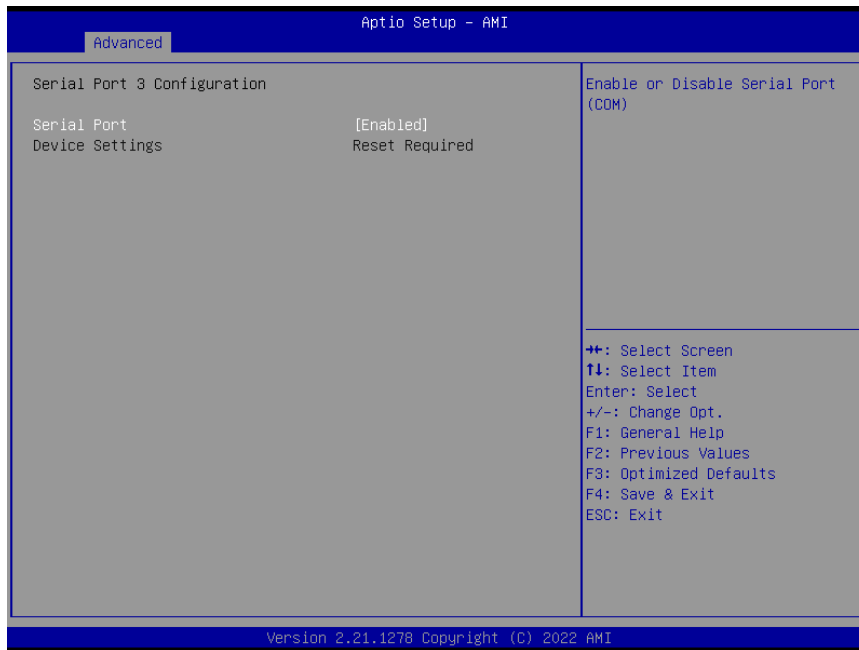

Item	Option	Description
Serial Port	Enabled[Default], Disabled	Enable or Disable Serial Port (COM).

3.6.2.6.4 Serial Port 4 Configuration

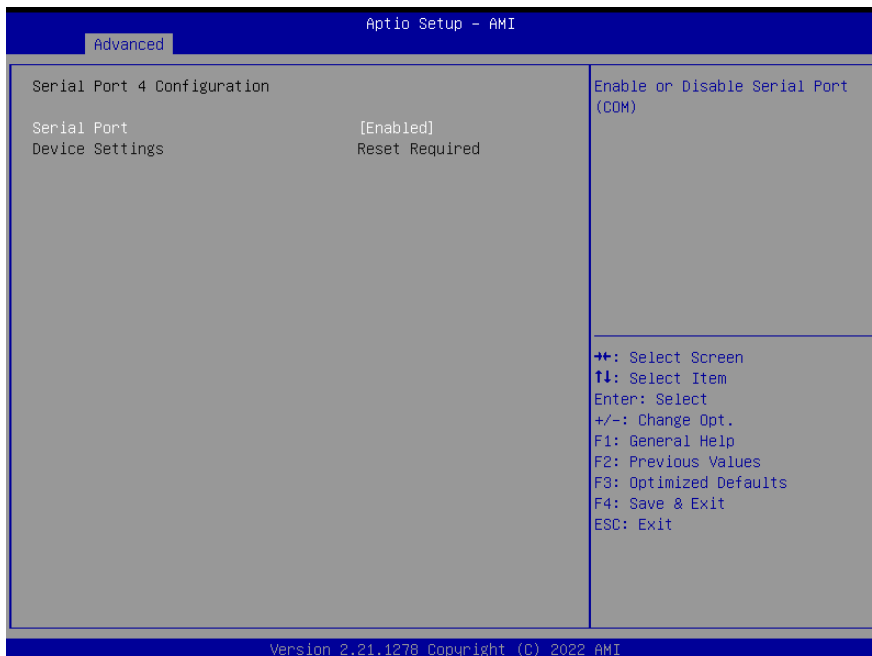

Item	Option	Description
Serial Port	Enabled[Default], Disabled	Enable or Disable Serial Port (COM).

3.6.2.6.5 Serial Port 5 Configuration

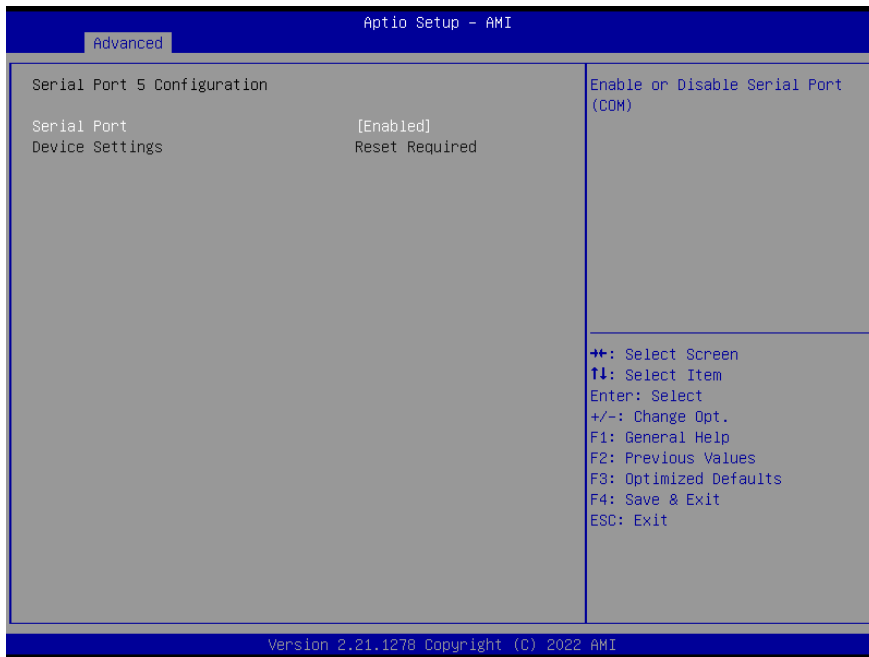

Item	Option	Description
Serial Port	Enabled[Default], Disabled	Enable or Disable Serial Port (COM).

3.6.2.7 EC 5571 HW Monitor

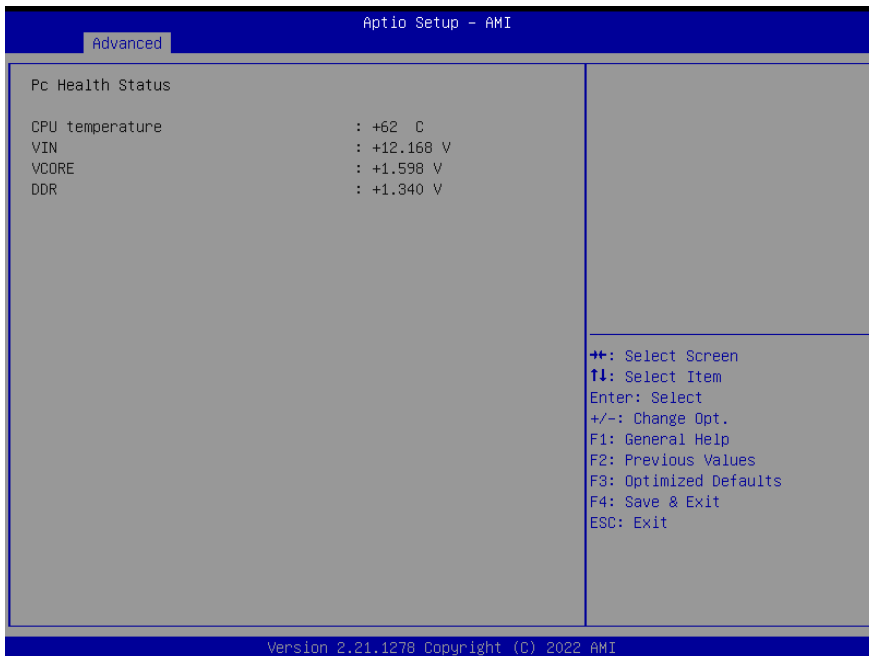

3.6.2.8 S5 RTC Wake Settings

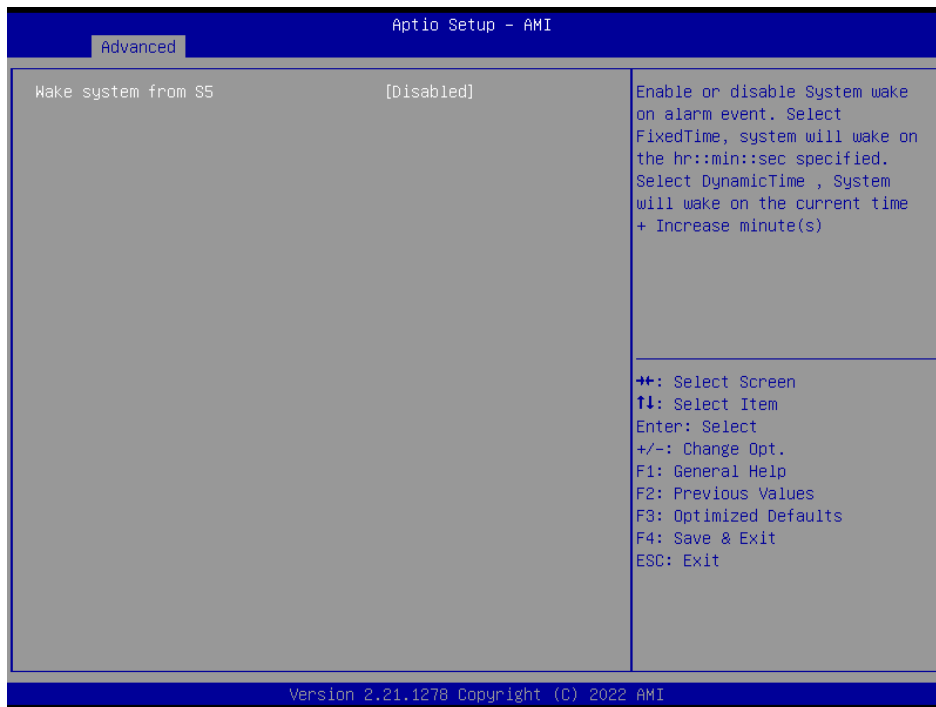

Item	Options	Description
Wake system from S5	Disabled[Default], Fixed Time Dynamic Time	Enable or disable System wake on alarm event. Select Fixed Time, system will wake on the hr::min::sec specified. Select Dynamic Time, System will wake on the current time + Increase minute(s).

3.6.2.9 Serial Port Console Redirection



Item	Options	Description
Console Redirection	Disabled[Default], Enabled	Console Redirection Enable or Disable.
Console Redirection EMS	Disabled[Default], Enabled	Console Redirection Enable or Disable.

3.6.2.10 USB Configuration

The USB Configuration menu helps read USB information and configures USB settings.

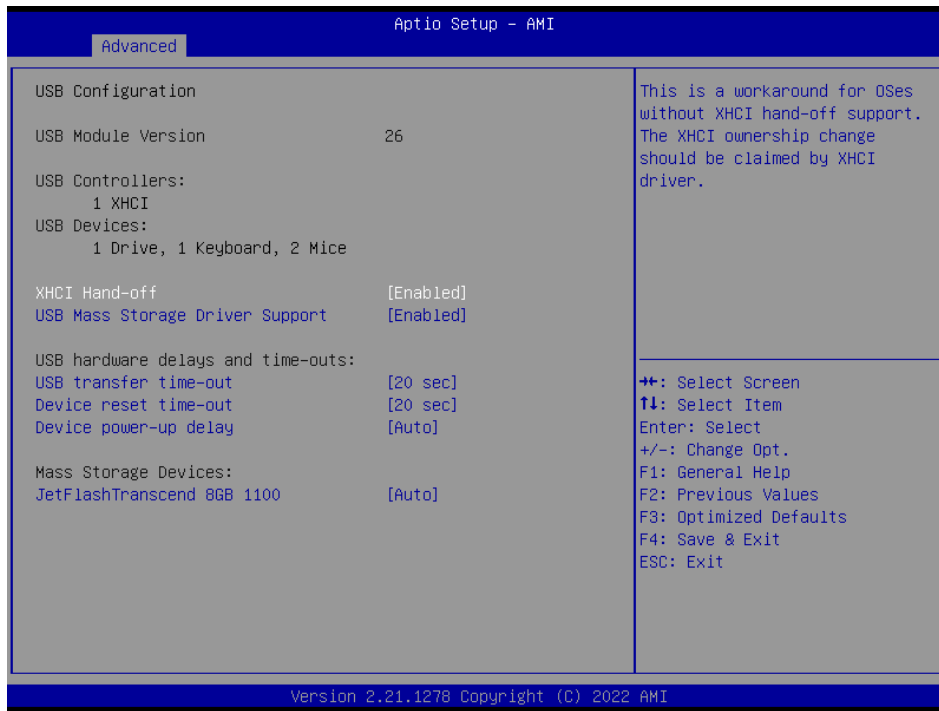

Item	Options	Description
XHCI Hand-off	Enabled[Default], Disabled	This is a workaround for Oses without XHCI hand-off support. The XHCI ownership change should be claimed by XHCI driver.
USB Mass Storage Driver Support	Disabled Enabled[Default],	Enable/Disable USB Mass Storage Driver Support.
USB transfer time-out	1 sec 5 sec 10 sec 20 sec[Default]	The time-out value for Control, Bulk, and Interrupt transfers.
Device reset time-out	10 sec 20 sec[Default] 30 sec 40 sec	USB mass storage device Start Unit command time-out.
Device power-up delay	Auto[Default] Manual	Maximum time the device will take before it properly reports itself to the Host Controller. 'Auto' uses default value: for a Root port it is 100ms, for a Hub port the delay is taken form Hub descriptor.
Mass Storage Devices	Auto[Default]	Mass storage device emulation type. 'AUTO'

	Floppy Forced FDD Hard Disk CD-ROM	enumerates devices according to their media format. Optical drives are emulated as 'CDROM', drives with no media will be emulated according to a drive type.
--	---	--

3.6.2.11 Network Stack Configuration

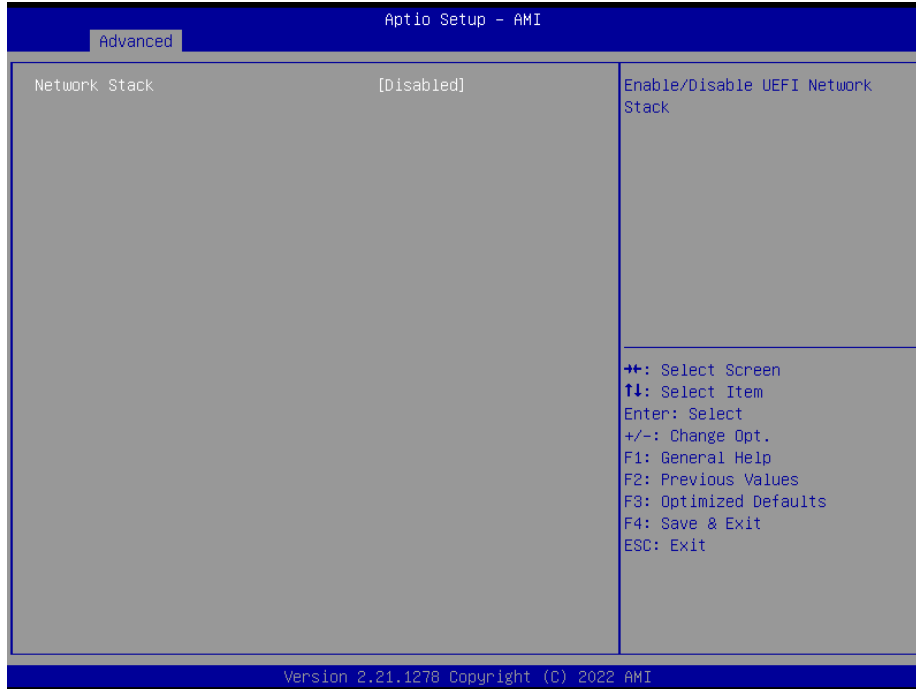

Item	Options	Description
Network Stack	Enabled Disabled[Default]	Enable/Disable UEFI Network Stack.

3.6.3 Chipset

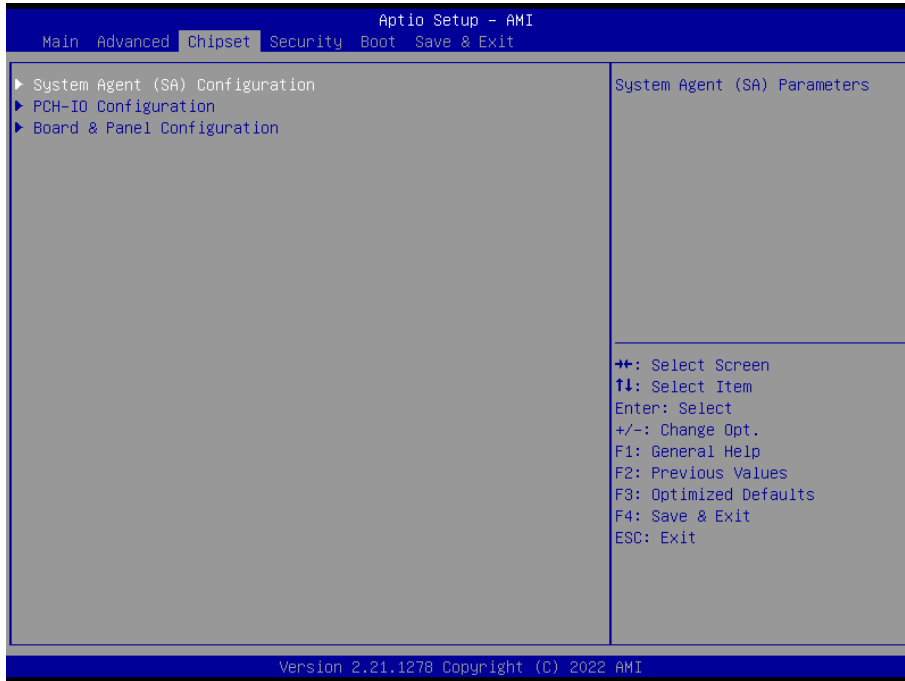

3.6.3.1 System Agent (SA) Configuration



Item	Option	Description
VT-d	Enabled[Default] Disabled	VT-d capability.
Above 4GB MMIO BIOS assignment	Enabled Disabled[Default]	Enable/Disable above 4GB MemoryMappedIO BIOS assignment. This is enabled automatically when Aperture Size is set to 2048MB.

3.6.3.1.1 Memory Configuration

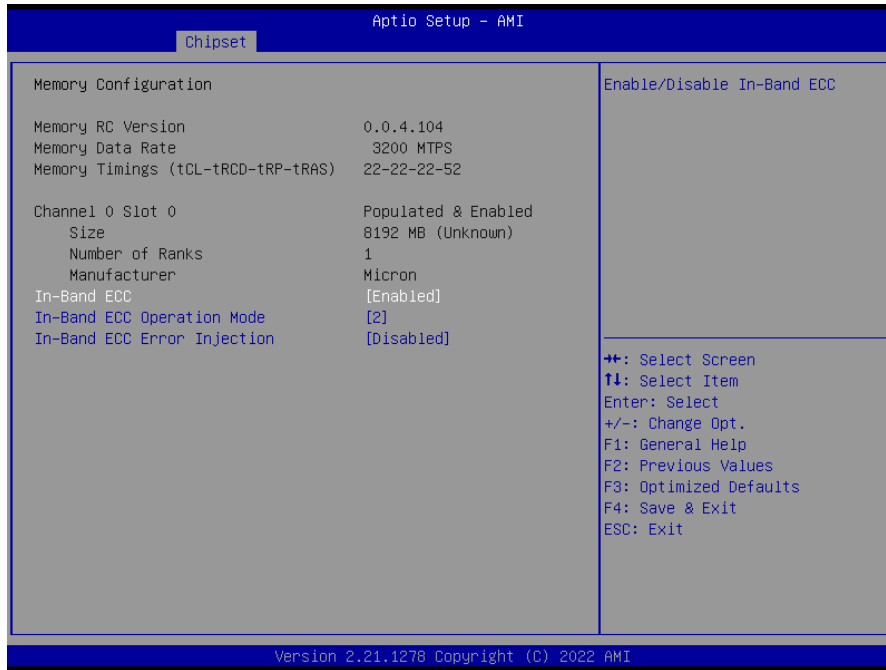

Item	Option	Description
In-Band ECC	Enabled[Default] Disabled	Enable/Disable In-Band ECC.
In-Band ECC Operation Mode	0 1 2[Default]	0: Functional Mode protects requests based on the address range, 1: Makes all requests non protected and ignore range checks, 2: Makes all requests protected and ignore range checks.
In-Band ECC Error Injection	Enabled Disabled[Default]	By enabling this Error Injection Enabling feature, the user acknowledges the security risks. Enabling Error Injection allows attackers who have access to the Host Operating System to inject IB ECC errors that can cause unintended memory corruption and enable the leak of security data in the BIOS stolen.

3.6.3.1.2 Graphics Configuration

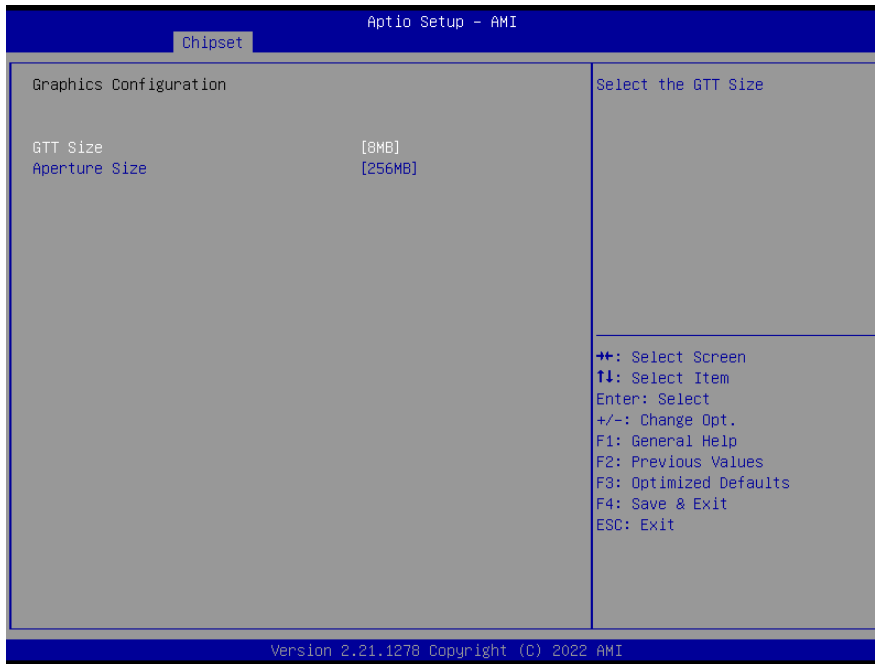

Item	Option	Description
GTT Size	2MB	Select the GTT Size.
	4MB	
	8MB[Default]	
Aperture Size	128MB	Select the Aperture Size. Note: Above 4GB MMIO BIOS assignment is automatically enabled when selecting 2048MB aperture. To use this feature, please disable CSM Support.
	256MB[Default]	
	512MB	
	1024MB	

3.6.3.2 PCH-IO Configuration



3.6.3.2.1 PCI Express Configuration

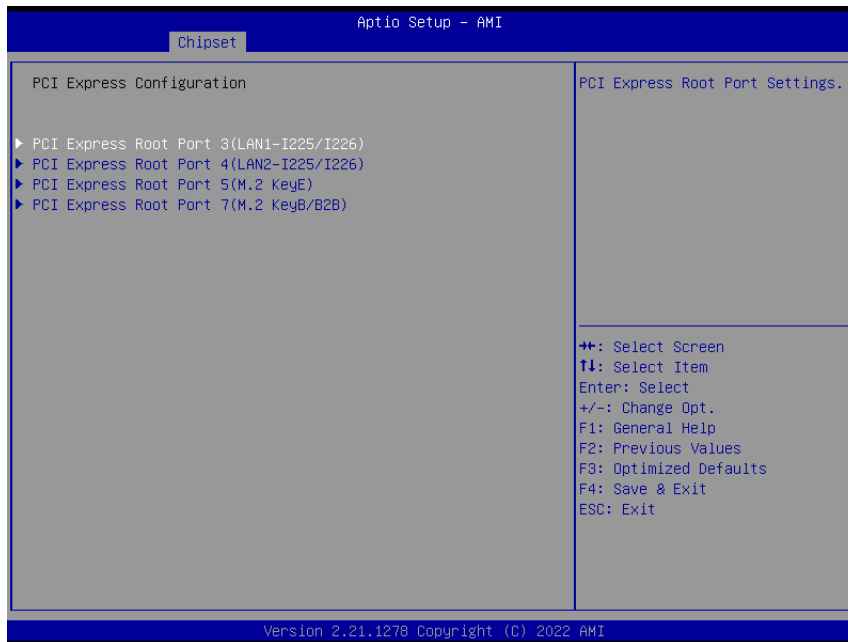

3.6.3.2.1.1 PCI Express Root Port 3(LAN1-I225/I226)

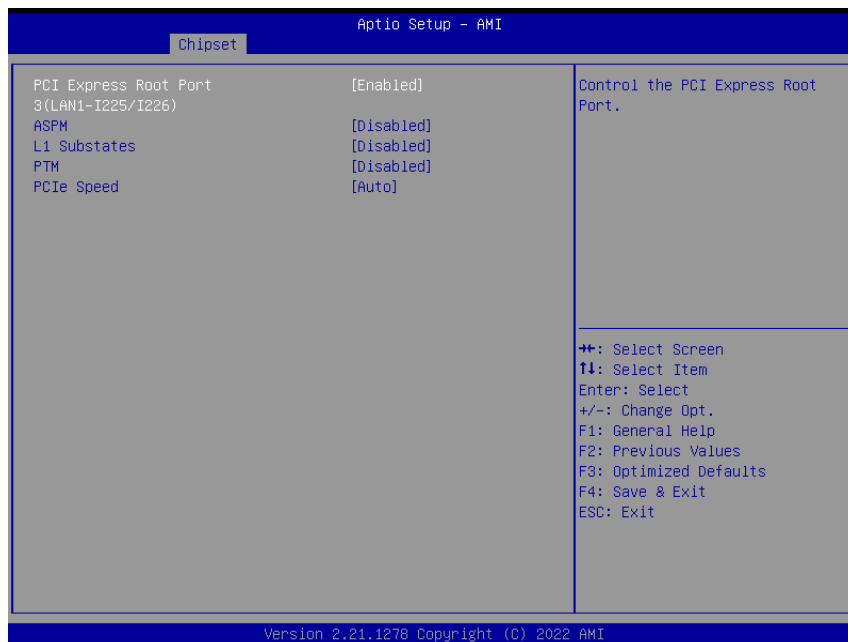

Item	Option	Description
PCI Express Root Port 3(LAN1-I225/I226)	Enabled[Default], Disabled	Control the PCI Express Root Port.
ASPM	Disabled[Default], L0s L1 L0sL1 Auto	Set the ASPM Level: Force L0s – Force all links to L0s State AUTO – BIOS auto configure DISABLE – Disables ASPM.

ARC-1235

L1 Substates	Disabled[Default] L1.1 L1.1 & L1.2	PCI Express L1 Substates settings.
PTM	Disabled[Default] Enabled	Enable/Disable Precision Time Measurement.
PCIe Speed	Auto[Default] Gen1 Gen2 Gen3	Configure PCIe Speed.

3.6.3.2.1.2 PCI Express Root Port 4(LAN2-I225/I226)



Item	Option	Description
PCI Express Root Port 4(LAN2-I225/I226)	Enabled[Default], Disabled	Control the PCI Express Root Port.
ASPM	Disabled[Default], L0s L1 L0sL1 Auto	Set the ASPM Level: Force L0s – Force all links to L0s State AUTO – BIOS auto configure DISABLE – Disables ASPM.
L1 Substates	Disabled[Default] L1.1 L1.1 & L1.2	PCI Express L1 Substates settings.
PTM	Disabled[Default] Enabled	Enable/Disable Precision Time Measurement.
PCIe Speed	Auto[Default] Gen1 Gen2 Gen3	Configure PCIe Speed.

3.6.3.2.1.3 PCI Express Root Port 5(M.2 KeyE)

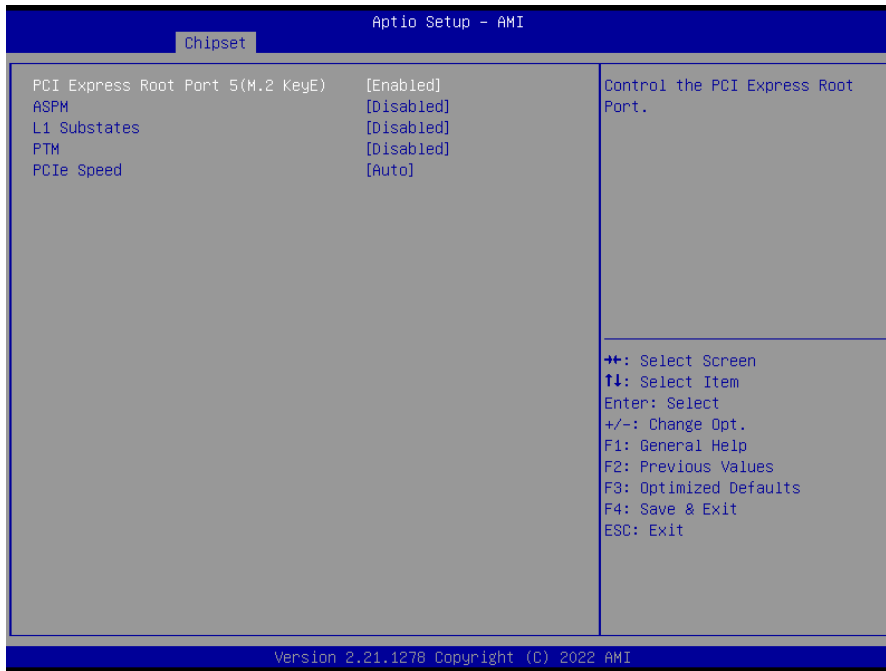

Item	Option	Description
PCI Express Root Port 5(M.2 KeyE)	Enabled[Default], Disabled	Control the PCI Express Root Port.
ASPM	Disabled[Default], L0s L1 L0sL1 Auto	Set the ASPM Level: Force L0s – Force all links to L0s State AUTO – BIOS auto configure DISABLE – Disables ASPM.
L1 Substates	Disabled[Default], L1.1 L1.1 & L1.2	PCI Express L1 Substates settings.
PTM	Disabled[Default] Enabled	Enable/Disable Precision Time Measurement.
PCIe Speed	Auto[Default] Gen1 Gen2 Gen3	Configure PCIe Speed.

3.6.3.2.1.4 PCI Express Root Port 7(M.2 KeyB/B2B)

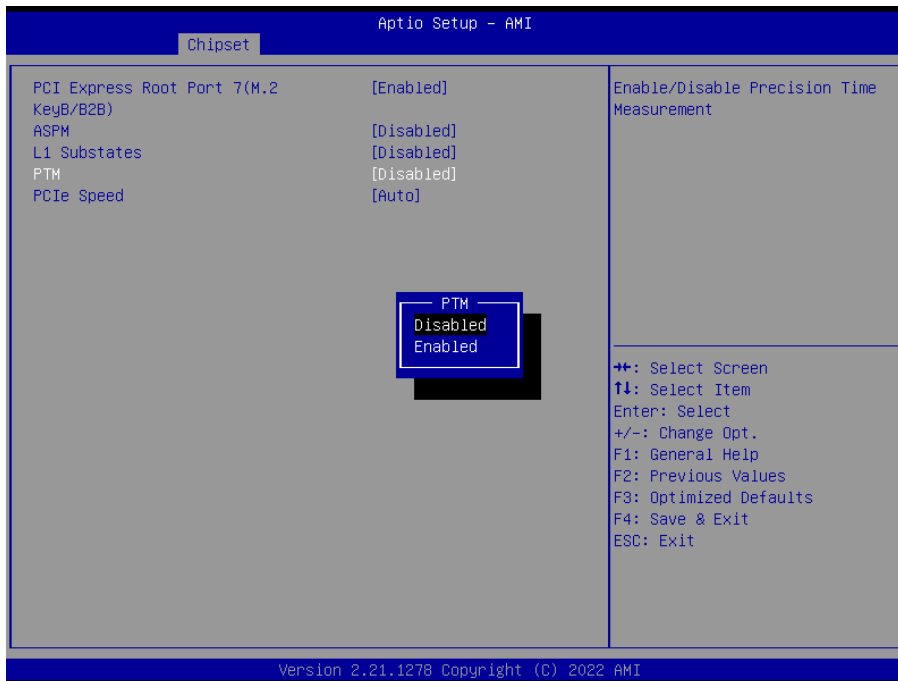
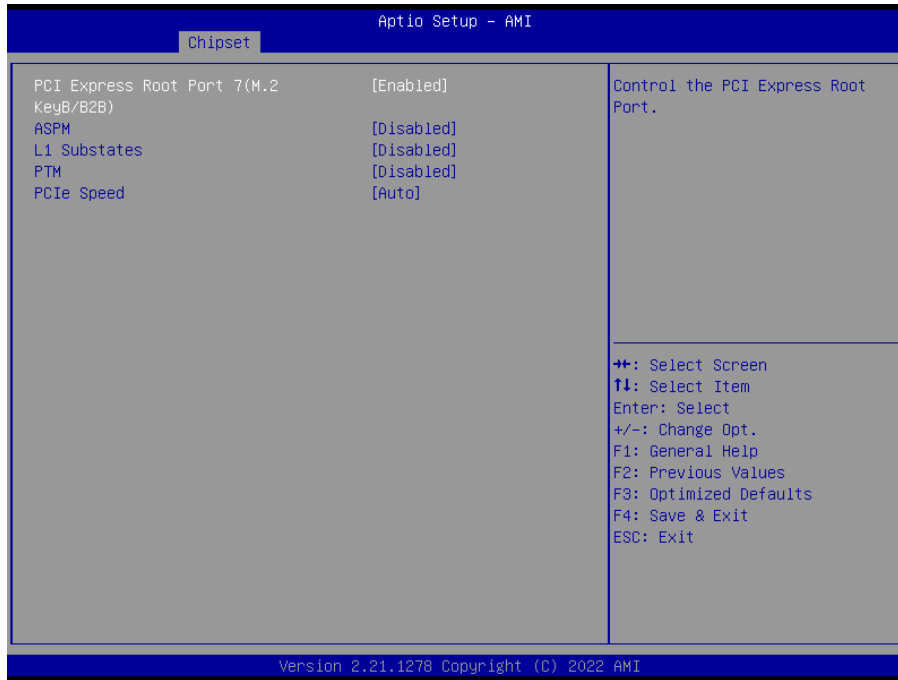

Item	Option	Description
PCI Express Root Port 7(M.2 KeyB/B2B)	Enabled[Default], Disabled	Control the PCI Express Root Port.
ASPM	Disabled[Default], L0s L1 L0sL1 Auto	Set the ASPM Level: Force L0s – Force all links to L0s State AUTO – BIOS auto configure DISABLE – Disables ASPM.

L1 Substates	Disabled[Default], L1.1 L1.1 & L1.2	PCI Express L1 Substates settings.
PTM	Disabled[Default] Enabled	Enable/Disable Precision Time Measurement.
PCIe Speed	Auto[Default] Gen1 Gen2 Gen3	Configure PCIe Speed.

3.6.3.2.2 SATA Configuration

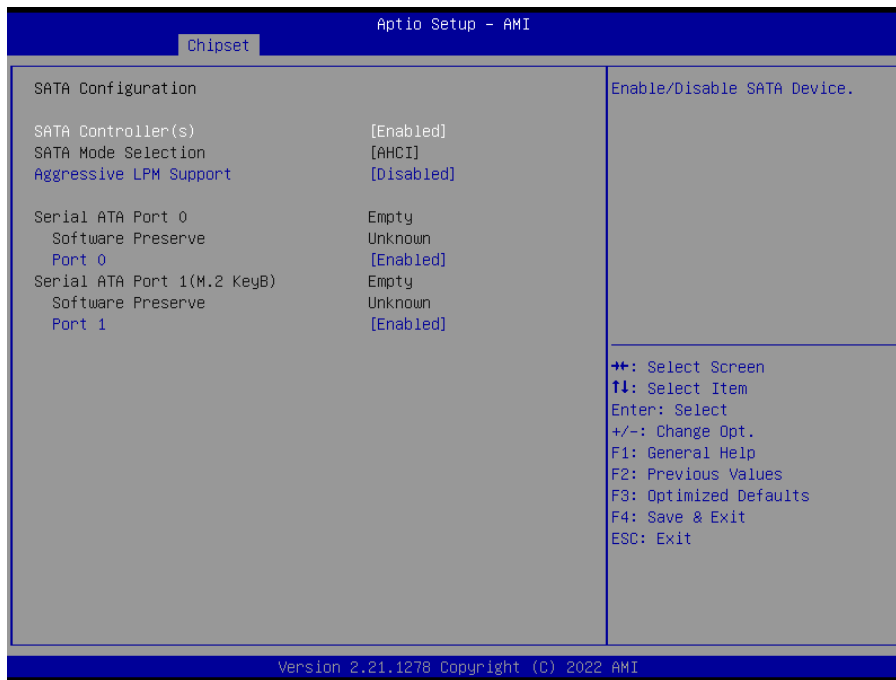

Item	Options	Description
SATA Controller(s)	Enabled[Default] Disabled,	Enable/Disable SATA Device.
Aggressive LPM Support	Enabled Disabled[Default]	Enable PCH to aggressively enter link power state.
Port 0	Enabled[Default] Disabled	Enable or Disable SATA Port.
Port 1	Enabled[Default] Disabled	Enable or Disable SATA Port.

3.6.3.2.3 USB Configuration

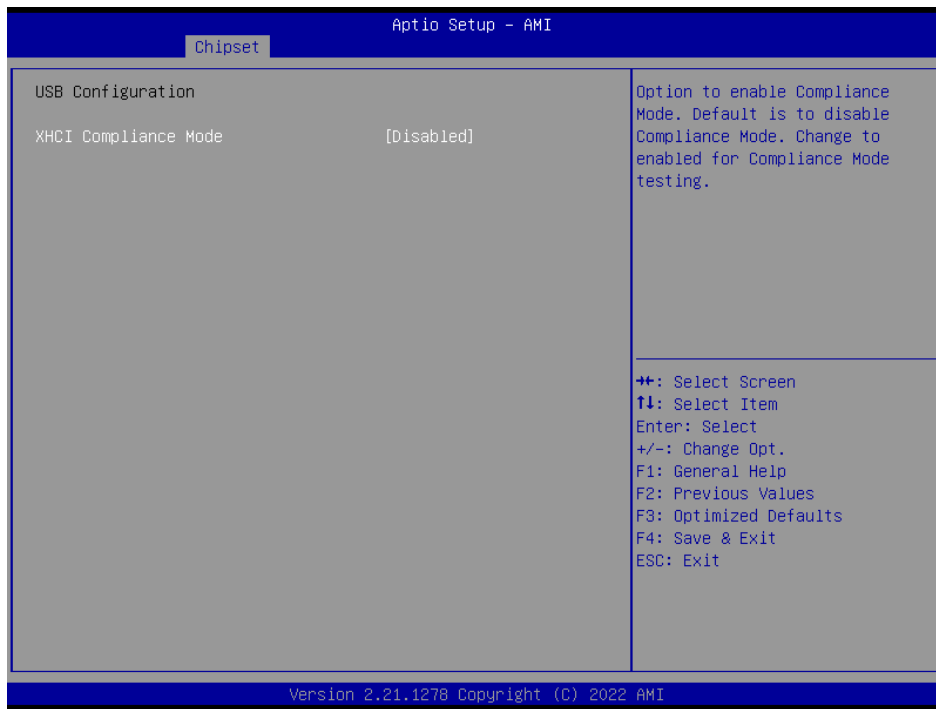

Item	Option	Description
XHCI Compliance Mode	Disabled[Default] Enabled	Option to enable Compliance Mode. Default is to disable Compliance Mode. Change to enabled for Compliance Mode testing.

3.6.3.2.4 HD Audio Configuration

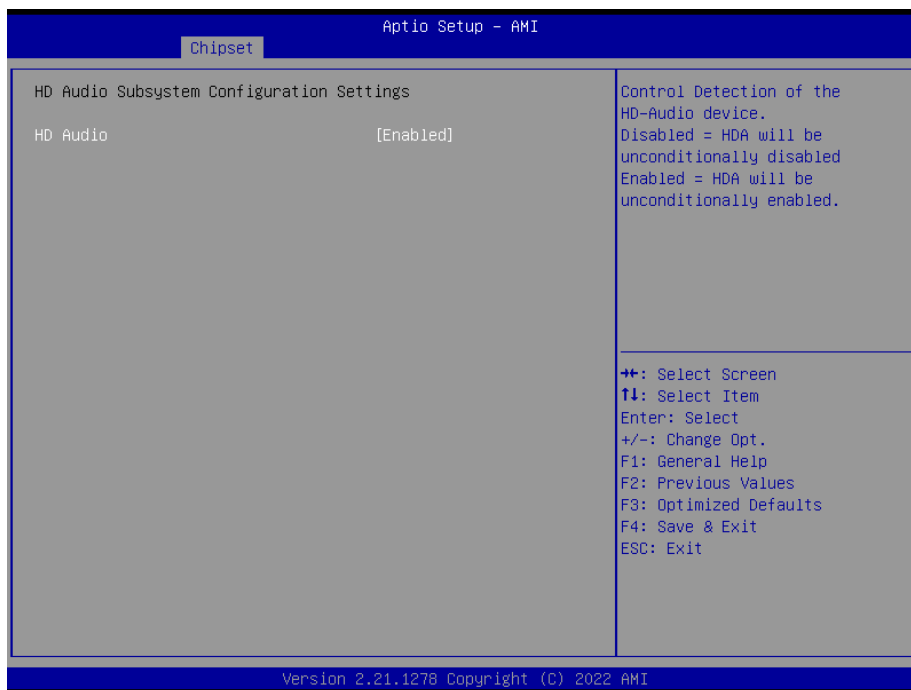

Item	Option	Description
HD Audio	Disabled Enabled[Default]	Control Detection of the HD-Audio device. Disable = HDA will be unconditionally disabled Enabled = HDA will be unconditionally enabled.

3.6.3.3 Board & Panel Configuration

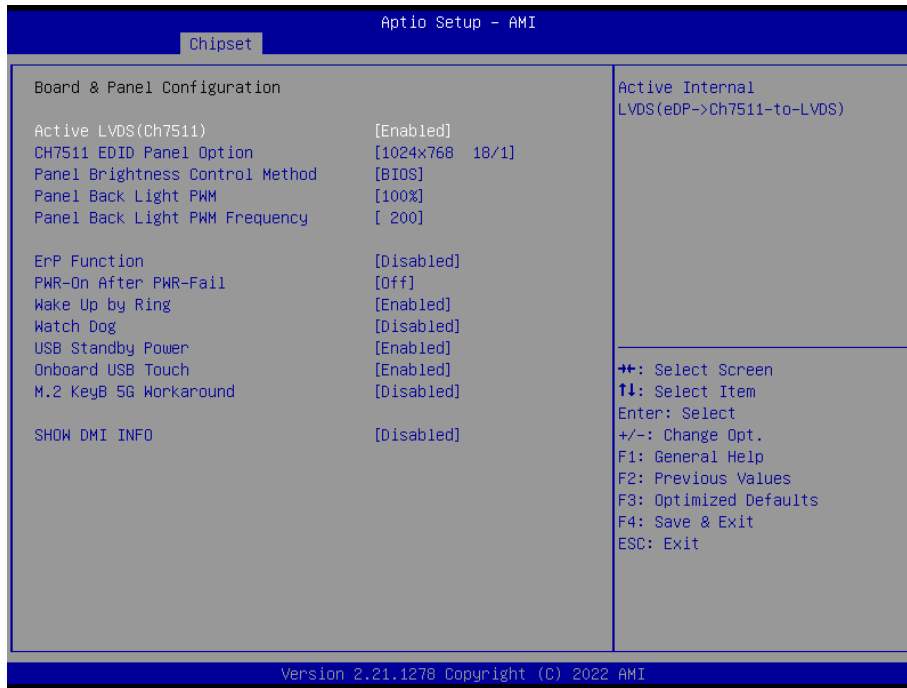

Item	Option	Description
Active Panel(Ch7511)	Disabled Enabled[Default]	Active Internal LVDS(eDP->Ch7511-to-LVDS).
CH7511 EDID Panel Option	1024x768 24/1[Default] 800x600 18/1 1024x768 18/1 1366x768 18/1 1024x600 18/1 1280x800 18/1 1920x1200 24/2 640x480 18/1 800x480 18/1 1920x1080 18/2 1280x1024 24/2 1440x900 18/2 1600x1200 24/2 1366x768 24/1 1920x1080 24/2 1680x1050 24/2	Port-EDP to LVDS(Chrotel 7511) Panel EDID Option.
Panel Brightness Control Method	BIOS[Default] OS Driver	Panel Brightness Control Method. 1.BIOS 2.OS Driver.
Panel Back Light PWM	00% 25%	Select Panel(eDP/LVDS) back light PWM duty.

ARC-1235

	50% 75% 100% [Default]	
Panel Back Light PWM Frequency	200 [Default] 300 400 500 700 1k 2k 3k 5k 10k 20k	Select Panel(eDP/LVDS) back light PWM Frequency.
ErP Function	Disabled [Default] Enabled	ErP Function (Deep S5).
PWR-On After PWR-Fail	Off [Default] On Last state	AC loss resume.
Wake Up by Ring	Disabled Enabled [Default]	Wake Up by Ring from S3/S4/S5.
Watch Dog	Disabled [Default] 30 sec 40 sec 50 sec 1 min 2 min 10 min 30 min	Select WatchDog.
USB Standby Power	Disabled Enabled [Default]	Enable/Disabled USB Standby Power during S3/S4/S5.
Onboard USB Touch	Disabled Enabled [Default]	Onboard USB Touch Enabled/Disabled.
M.2 KeyB 5G Workround	Disabled [Default] Enabled	Enabled/Disabled M.2 KeyB 5G Card Workaround
SHOW DMI INFO	Disabled [Default] Enabled	SHOW DMI INFO.

3.6.4 Security



- **Administrator Password**

Set setup Administrator Password

- **User Password**

Set User Password

3.6.4.1 Secure Boot



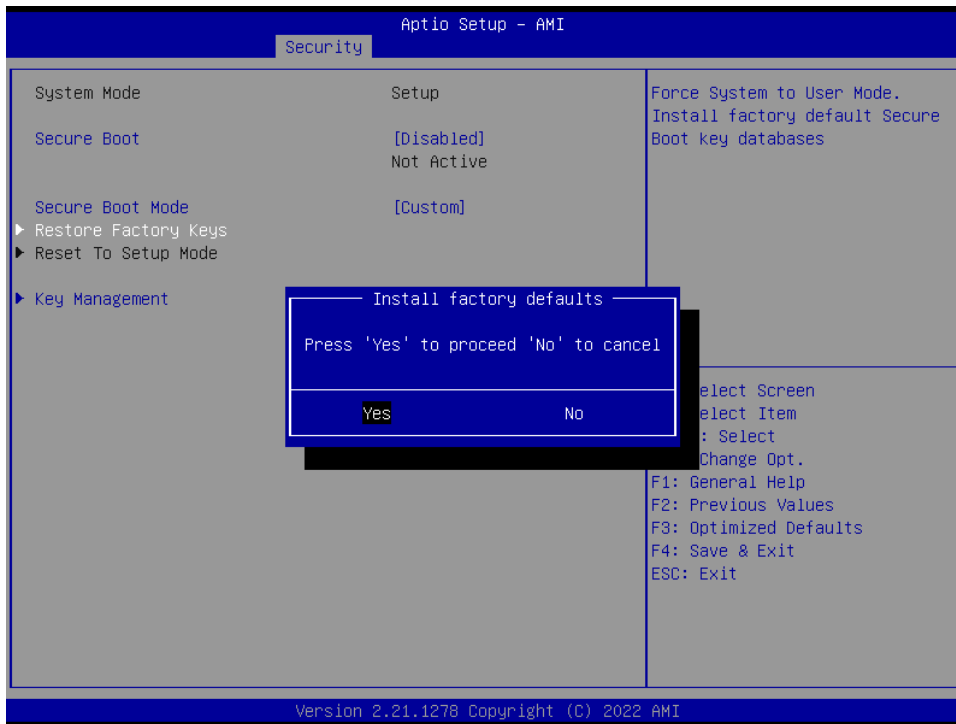

Item	Option	Description
Secure Boot	Disabled[Default] Enabled	Secure Boot feature is Active if Secure Boot is Enable, Platform Key(PK) is enrolled and the System is in User mode. The mode change requires platform reset.
Secure Boot Mode	Standard Custom[Default]	Secure Boot mode selector: Standard/Custom. In Custom mode Secure Boot Variables can be configured without authentication.

3.6.4.1.1 Key Management

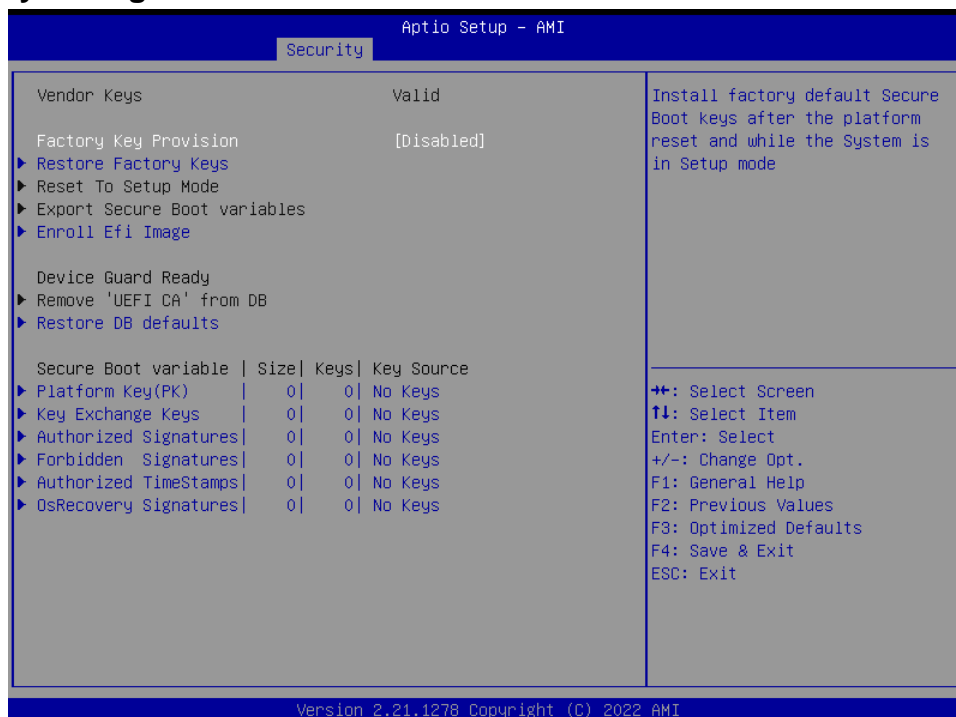

Item	Option	Description
Factory Key Provision	Disabled[Default] Enabled	Install factory default Secure Boot keys after the platform reset and while the System is in Setup mode.

3.6.5 Boot

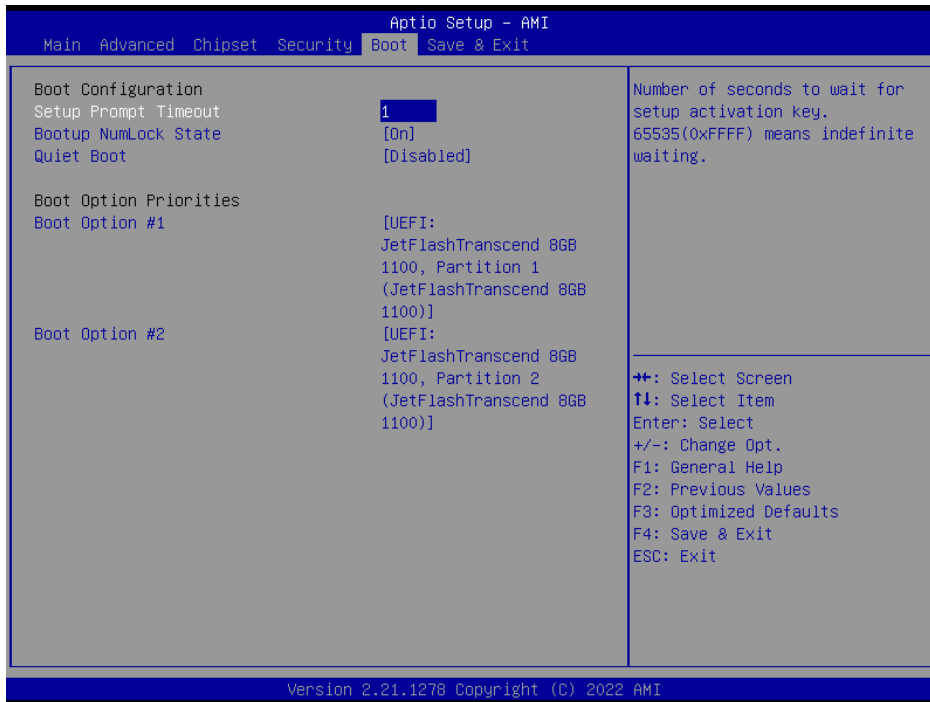

Item	Option	Description
Setup Prompt Timeout	1~ 65535	Number of seconds to wait for setup activation key. 65535(0xFFFF) means indefinite waiting.
Bootup NumLock State	On[Default] Off	Select the keyboard NumLock state
Quiet Boot	Disabled[Default] Enabled	Enables or disables Quiet Boot option
Boot Option #1/2	Set the system boot order.	

3.6.6 Save and exit

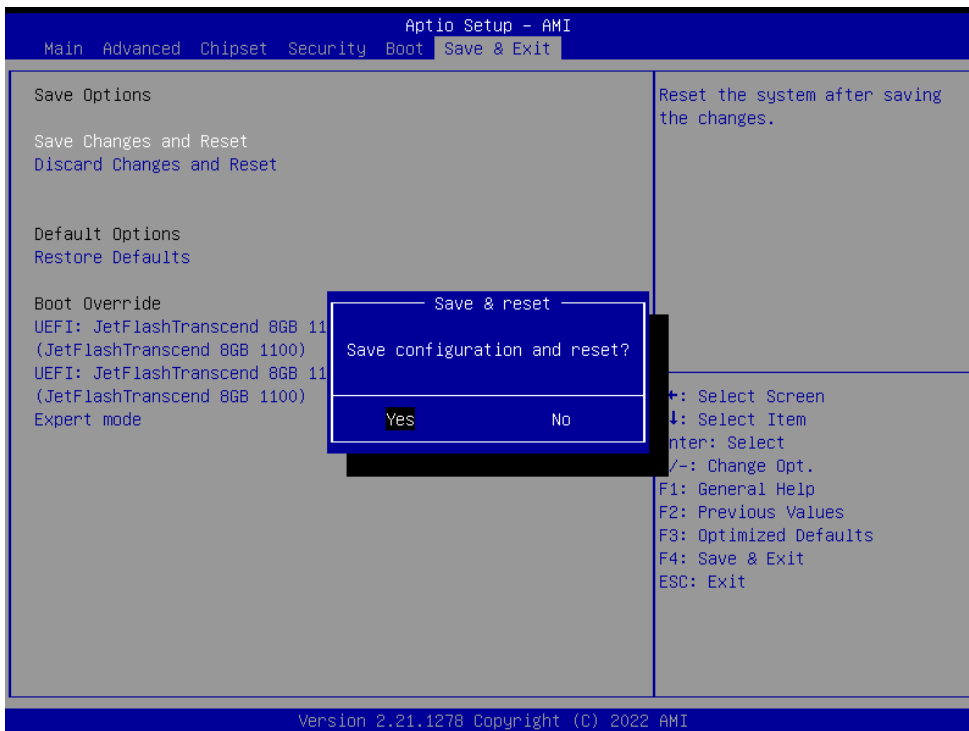
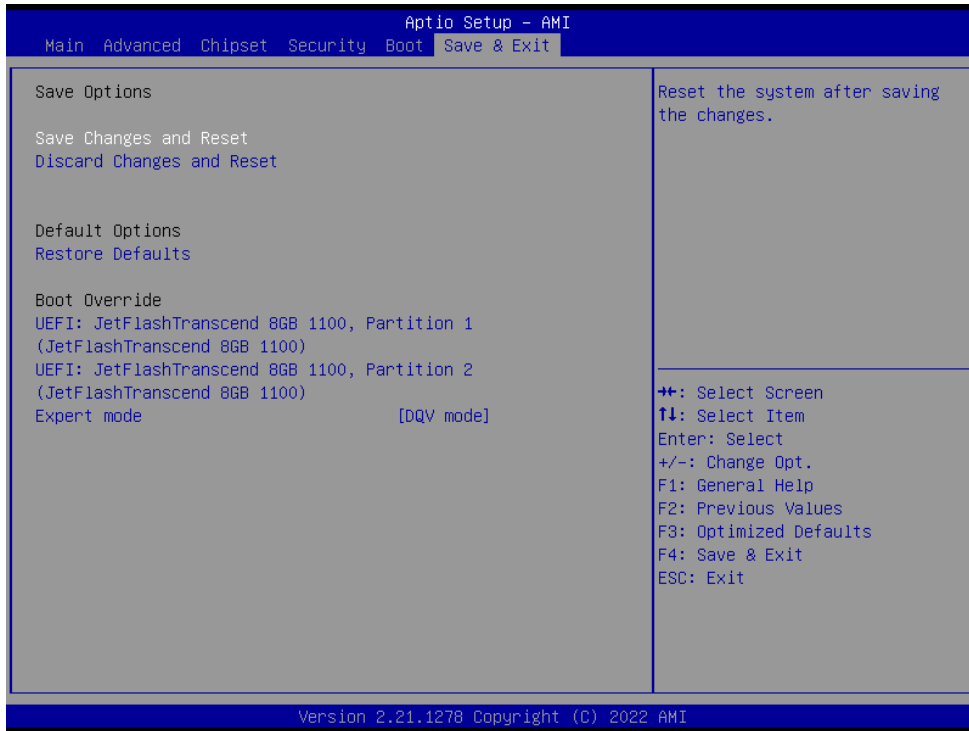

3.6.6.1 Save Changes and Reset

Reset the system after saving the changes.

3.6.6.2 Discard Changes and Reset

Any changes made to BIOS settings during this session of the BIOS setup program are discarded. The setup program then exits and reboots the controller.

3.6.6.3 Restore Defaults

This option restores all BIOS settings to the factory default. This option is useful if the controller exhibits unpredictable behavior due to an incorrect or inappropriate BIOS setting.

3.6.6.4 Launch EFI Shell from filesystem device

Attempts to Launch EFI Shell application (Shellx64.efi) from one of the available filesystem devices.

