

# M140TG/T

## 14" Rugged Windows Tablet

Intel Core i51135G7 @ 2.40GHz, up to 4.20GHz



# User Manual

---



# Contents

<b>Chapter 1: Read Me First</b> .....	<b>3</b>
1.1 Advisory Conventions.....	3
1.2 Safety Information .....	4
1.3 Handling and Maintenance.....	6
1.4 Declaration of Conformity (DoC).....	7
1.5 Copyright Notice.....	8
1.6 Trademark Acknowledgement.....	8
1.7 Disclaimer .....	8
<b>Chapter 2: Getting Started</b> .....	<b>9</b>
2.1 Introduction .....	9
2.2 Unpacking .....	9
2.3 Description of Parts .....	10
2.4 Indicators.....	11
2.5 Hotkey for Specific Functions .....	12
2.6 First-Time Operation .....	12
2.6.1 Installing Battery .....	12
2.6.2 Installing SIM card (For 4G/LTE Equipped Devices).....	13
2.6.3 Installing a MicroSD Card .....	13
2.6.4 Charging Your Tablet.....	14
2.6.5 Starting the Tablet .....	14
<b>Chapter 3: Setting Up Windows for the First Time</b> .....	<b>15</b>
3.1 Introduction .....	15
3.2 Setting up Windows 10 IoT Enterprise.....	15
<b>Chapter 4: Operating the Device</b> .....	<b>21</b>
4.1 Hottab Introduction .....	21
4.2 Shortcuts .....	22
4.3 Built-in Devices On/Off .....	22
4.3.1 Using the Wireless LAN .....	23
4.3.2 Using the Wireless WAN .....	23
4.3.3 Using the GPS.....	23
4.3.4 Using the BT.....	24
4.3.5 Using Camera.....	24
4.3.6 Turning On/Off LED Indicators.....	26
4.3.7 Turn on/off the GPS External Antenna.....	26
4.3.8 Turn on/off the Light Sensor .....	26
4.3.9 Changing Touchscreen Modes .....	27
4.3.10 Using the HF RFID Reader.....	29
4.4 Check Battery Capacity .....	34

4.5 Check for Update ..... 35

**Chapter 5: Frequently Used Settings ..... 36**

5.1 Screen Resolution Scaling and Setting..... 36

    5.1.1 Changing Display Scaling (Recommended)..... 36

    5.1.2 Changing Screen Resolution ..... 37

5.2 Using Recovery Wizard to Restore Computer ..... 39

5.3 Docking Connector Pin Definition ..... 40

5.4 COM Port Definition ..... 41

5.5 Pairing with a Wireless BT Barcode Scanner ..... 43

    5.5.1 Setup Computer for BT Pairing..... 43

    5.5.2 Set up the Barcode Scanner for BT Pairing ..... 46

    5.5.3 Perform BT Pairing ..... 46

**Chapter 6: Troubleshooting..... 48**

6.1 Basic Troubleshooting ..... 48

**Appendix..... 50**

Appendix A: Product Specifications..... 50

# Chapter 1: Read Me First

## 1.1 Advisory Conventions

Four types of advisories are used throughout the user manual to provide helpful information or to alert you to the potential for hardware damage or personal injury. These are Notes, Important, Cautions, and Warnings. The following is an example of each type of advisory.

**Note:**

A note is used to emphasize helpful information

**Important:**

An important note indicates information that is important for you to know.



**Caution** A Caution alert indicates potential damage to hardware and explains how to avoid the potential problem.

**Attention** Une alerte d'attention indique un dommage possible à l'équipement et explique comment éviter le problème potentiel.



**Warning!** An Electrical Shock Warning indicates the potential harm from electrical hazards and how to avoid the potential problem.

**Avertissement!** Un Avertissement de Choc Électrique indique le potentiel de choc sur des emplacements électriques et comment éviter ces problèmes.

## 1.2 Safety Information



### Precaution on Battery Pack *Précaution avec le bloc-pile*

Do Not Disassemble, Modify, or Insert Sharp Objects Into the Battery Pack. Electrolyte leakage, generation of heat, ignition, or rupture may result.

*[FR] Ne pas démonter, modifier, ou insérer des objets pointus à l'intérieur du bloc-pile. Une fuite d'électrolyte, la génération de chaleur, l'amorçage ou la rupture peuvent être occasionnés.*

Do Not Short the Positive (+) and Negative (-) Terminals of the Battery. Generation of heat, ignition, or rupture may result. When carrying or storing the device, do not place the battery pack with articles that may contact electricity.

*[FR] Ne pas court-circuiter les bornes Positive (+) et Négative (-) de la pile, la génération de chaleur, l'amorçage ou la rupture peuvent être occasionnés. Lors du transport et du rangement de l'appareil, ne pas placer le bloc-pile en même temps que des articles pouvant créer un contact électrique.*

Do Not Apply Shocks to the Battery by Dropping It or Applying Strong Pressure to It. Electrolyte leakage, generation of heat, ignition, or rupture of the battery may occur.

*[FR] Ne pas faire subir de choc à la pile en la laissant tomber ou en appliquant une forte pression dessus. Une fuite d'électrolyte, la génération de chaleur, l'amorçage ou la rupture peuvent être occasionnés.*

Do Not Charge the Battery Other Than Methods Those Specified In This Manual. If the battery is not charged using one of the specified methods, electrolyte leakage, generation of heat, ignition, or rupture may result.

*[FR] Ne pas charger la pile par d'autres méthodes que celles spécifiées dans ce manuel. Si la pile n'est pas chargée en utilisant l'une des méthodes spécifiées, une fuite d'électrolyte, la génération de chaleur, l'amorçage ou la rupture peuvent être occasionnés.*

When the Battery Pack Has Deteriorated, Replace It with a New Battery. Continued use of a damaged battery pack may result in heat generation, ignition, or battery rupture.

*[FR] Lorsque la pile est détériorée, la remplacer par une nouvelle pile. L'utilisation continue d'une pile endommagée peut occasionner une génération de chaleur, l'amorçage ou la rupture de la pile.*

Do Not Expose the Battery Pack to Excessive Heat or Extreme Heat (for example, Near Fire, in Direct Sunlight) Generation of heat, ignition, or rupture may result

*[FR] Ne pas exposer le bloc-pile à une Chaleur Excessive, ou une Chaleur Extrême (Près d'un feu, sous la lumière du soleil par exemple) Une production de chaleur, l'amorçage ou la rupture peuvent être occasionnés*

Do Not Use the Battery Pack With Any Other Products. The battery pack is rechargeable and is only designed for this specific product. Electrolyte leakage, generation of heat, ignition, or rupture may result if used with a product other than the specified product.

*[FR] Ne pas utiliser avec un autre produit La batterie est rechargeable et a été conçue pour un produit spécifique. Si elle est utilisée sur un produit différent de celui pour lequel elle a été conçue, des pertes d'électrolytes et une production de chaleur sont possibles, elle risque également de prendre feu ou de casser.*

Do Not Use This Product With Battery Other Than the One Specified.

*[FR] Ne pas utiliser ce produit avec une batterie autre que celle spécifiée*

Discontinue using the device immediately if you notice the battery is swelling or looks puffy or misshapen. Do not attempt to charge or use the device. Do not handle a damaged or leaking battery. Do not let leaking battery fluid come into contact with your eyes, skin, or clothing.

*[FR] Si vous remarquez une pile gonflée, élargie ou anormale, cesser l'utilisation de l'appareil immédiatement. N'essayez pas de recharger l'appareil ou de l'utiliser. Ne pas manipuler une pile qui fuit ou qui est endommagée. Ne laissez pas de liquide qui fuit entrer en contact avec vos yeux, votre peau ou vos vêtements.*



### General Product Safety *Sécurité générale des produits*

- Do not block any ventilation openings. Do not place the product against a wall or in an enclosed space, as doing so might impede the flow of cooling air.
- *[FR] Ne pas bloquer les ouvertures de ventilation. Ne pas placer le produit contre un mur ou dans un espace clos de façon à entraver la circulation de l'air de refroidissement.*
- Do not place the product near any heat sources such as radiators, warm air intakes, stoves, or other heat-generating devices (including amplifiers or other heat-producing equipment).
- *[FR] Ne pas placer le produit près d'une source de chaleur comme des radiateurs, les arrivées d'air chaud, poêles ou autres produits générant de la chaleur (y compris les amplificateurs ou autre équipement produisant de la chaleur.)*
- Protect the power cord from being crushed or pinched, particularly in the area of the plugs, any receptacles used, and the point of exit from the apparatus. Do not break off the ground pin of the power cord.
- *[FR] Empêcher le cordon d'alimentation d'être écrasé ou pincé, en particulier dans les zones de prises, des containers utilisés, et du point de sortie de l'appareil. Ne pas casser la broche de terre du cordon d'alimentation.*
- Do not disregard the safety that a polarized or grounded connection can provide. A polarized connection consists of two plugs, one of which is larger than the other. A grounded connection has two blades and a third one that is grounded. If the main plug provided cannot be inserted into your outlet, consult an electrician to replace your obsolete outlet.
- *[FR] Ne pas ignorer la sécurité qu'une prise polarisée ou une prise de terre peut prévoir. Une prise polarisée se compose de deux fiches, dont l'une est plus large que l'autre. Une prise de terre possède deux lames et une troisième qui est la terre. Si la fiche principale fournie ne peut être insérée dans votre prise, consultez un électricien pour remplacer votre prise obsolète.*
- Use only accessories specified by the manufacturer.
- *[FR] Utiliser uniquement les accessoires spécifiés par le fabricant.*

- This product should not be used near water such as bathtubs, sinks, swimming pools, wet basement, etc.
- *[FR] Ce produit ne doit pas être utilisé près de l'eau comme les baignoires, les éviers, les piscines, les sous-sols humides, etc.*
- Use only with its transport carriage, stand, tripod, console, or table specified by the manufacturer or sold with the product. When using a carriage, move the carriage assembly with the product carefully to avoid damage from falling over.
- *[FR] Utiliser uniquement avec son chariot de transport, support, trépied, console ou table spécifiés par le fabricant ou vendu avec le produit. Lors de l'utilisation d'un charriot, déplacez l'ensemble chariot avec le produit avec soin pour éviter tout dommage de chute.*
- Unplug this apparatus during lightning storms or when it is not being used for long periods.
- *[FR] Débrancher cet appareil durant les orages ou lorsqu'il n'est pas utilisé pendant de longues périodes.*
- Refer all servicing to qualified service personnel. A technical intervention is required when the apparatus has been damaged in any way, for example, if the power cord or plug is damaged, liquid has been spilled, or objects have fallen inside the unit if the product has been exposed to rain or moisture, if it does not operate normally or if it has been dropped.
- *[FR] Confier toute réparation à du personnel qualifié. Une intervention technique est nécessaire lorsque l'appareil a été endommagé de quelque façon, par exemple si le cordon d'alimentation ou la fiche est endommagé, du liquide a été renversé ou des objets sont tombés à l'intérieur de l'unité, si le produit a été exposé à la pluie ou à l'humidité, s'il ne fonctionne pas normalement ou s'il a été jeté.*



### General Guideline *Directive générale*

It is recommended to reboot the device when some functions are defective or inactive. If it still can't solve the problems, please contact your dealer or agent.

*Il est recommandé de redémarrer l'appareil lorsque certaines fonctions sont défectueuses ou inactives. Si le problème persiste, veuillez contacter votre revendeur ou votre agent.*

## 1.3 Handling and Maintenance



### General Guideline Guide Général

Keep the product at least 13 cm (5 inches) away from electrical appliances that generate a strong magnetic field such as TV, refrigerator, motor, or a large audio speaker.

*[FR] Garder le produit au moins à 13 cm (5 pouces) de distance des appareils électriques qui peuvent générer un fort champ magnétique comme une télévision, un réfrigérateur, un moteur, ou un important haut-parleur.*

Do not place heavy objects on top of the tablet computer as this may damage the display.

*[FR] Ne pas placer d'objets lourds sur le dessus de l'ordinateur tablette cela peut endommager l'écran.*

The screen surface can be easily scratched. Use with care. Do not use paper towels to clean the display but use the included cleaning cloth. Avoid touching it with a pen or pencil.

*[FR] La surface de l'écran peut être facilement rayée. Utiliser avec précaution. Ne pas utiliser de serviette en papier pour nettoyer l'écran mais utiliser le chiffon de nettoyage inclus. Éviter de toucher avec un stylo ou un crayon.*

To maximize the life of the backlight in the display, allow the backlight to automatically turn off as a result of power management. Avoid using a screen saver or other software that prevents the power management from working.

*[FR] Pour maximiser la durée de vie du rétroéclairage de l'écran, autoriser le rétroéclairage résultant de la gestion de l'alimentation. Éviter d'utiliser un économiseur d'écran ou un autre logiciel empêchant la gestion de l'alimentation de fonctionner.*



### Cleaning Guideline Guide de nettoyage

Use a soft cloth moistened with water or a non-alkaline detergent to wipe the exterior of the product.

*[FR] Utiliser un chiffon doux humidifié avec de l'eau ou un détergeant non alcalin pour essuyer l'extérieur du produit.*

Gently wipe the display with a soft, lint-free cloth. Do not use alcohol or detergent on the product.

*[FR] Essuyer délicatement l'écran avec un chiffon doux non pelucheux. Ne pas utiliser d'alcool ou un détergent sur le produit.*



### Touchscreen Guideline Guide de l'écran tactile

Use your finger or the stylus on display. Using sharp or metallic objects may cause scratches and damage the display, thereby causing errors.

*[FR] Utiliser votre doigt ou le stylet sur l'écran. L'utilisation d'un objet pointu ou métallique peut provoquer des rayures.*

Use a soft cloth to remove dirt on display. The touchscreen surface has a special protective coating that prevents dirt from sticking to it. Not using a soft cloth may cause damage to the special protective coating on the touchscreen surface. To clean off hard to remove dirt, blow some steam on the particular area and gently wipe away using a soft cloth.

*[FR] Utiliser un chiffon doux pour enlever la poussière sur l'écran. La surface de l'écran tactile a un revêtement protecteur spécial empêchant la saleté de se coller à lui. Ne pas utiliser un chiffon doux peut endommager le revêtement spécial sur la surface de l'écran tactile. Pour nettoyer les saletés plus difficiles à enlever, souffler de la buée sur la zone particulière et essuyer doucement avec un chiffon doux.*

Do not use excessive force on display. Avoid placing objects on top of the display as this may cause the glass to break.

*[FR] Ne pas utiliser une force excessive sur l'écran. Éviter de placer des objets au dessus de l'écran cela pourrait provoquer une cassure du verre.*

When there is a noticeable discrepancy in the operation of the touchscreen function (your touch does not correlate to the proper location on the screen), recalibrate the touchscreen display.

*[FR] Lorsqu'il y a un écart sensible dans le fonctionnement de l'écran tactile (votre contact ne correspond pas à la bonne position sur l'écran), recalibrer l'écran tactile.*

## 1.4 Declaration of Conformity (DoC)

### FCC Statement

This device complies with part 15 FCC rules.



Operation is subject to the following two conditions:

- This device may not cause harmful interference.
- This device must accept any interference received, including interference that may cause undesired operation

This equipment has been tested and found to comply with the limits for a Class "B" digital device, pursuant to part 15 of the FCC rules. These limits are designed to provide reasonable protection against harmful interference when the equipment is operated in a commercial environment. This equipment generates, uses, and can radiate radio frequency energy and, if not installed and used in accordance with the instruction manual, may cause harmful interference to radio communications. Operation of this equipment in a residential area is likely to cause harmful interference, in which case the user will be required to correct the interference at his own expense.

### CE Notice (European Union)

This equipment is in conformity with the requirement of the following EU legislation and harmonized standards. The product also complies with the Council's directions.



Electromagnetic Compatibility Directive (2014/30/EU)

- EN55035: 2017/ A11: 2020
  - IEC61000-4-2: 2009
  - IEC61000-4-3: 2020
  - IEC61000-4-4: 2012
  - IEC61000-4-5: 2014
  - IEC61000-4-6: 2014
  - IEC61000-4-8: 2010
  - IEC61000-4-11: 2004
- EN55032: 2015
- EN61000-3-2:2019
- EN61000-3-3:2013

Low Voltage Directive (2014/35/EU)

- EN 62368-1:2014



## **1.5 Copyright Notice**

No part of this document may be reproduced, copied, translated, or transmitted in any form or by any means, electronic or mechanical, for any purpose, without the prior written permission of the original manufacturer.

## **1.6 Trademark Acknowledgement**

Brand and product names are trademarks or registered trademarks of their respective owners.

## **1.7 Disclaimer**

Winmate Inc. reserves the right to make changes, without notice, to any product, including circuits and/or software described or contained in this manual in order to improve design and/or performance. We assume no responsibility or liability for the use of the described product(s) conveys no license or title under any patent, copyright, or masks work rights to these products, and make no representations or warranties that these products are free from patent, copyright, or mask work right infringement unless otherwise specified. Applications that are described in this manual are for illustration purposes only. We make no representation or guarantee that such application will be suitable for the specified use without further testing or modification.

## Chapter 2: Getting Started

This chapter tells you step by step how to get the tablet Computer up and running.

### 2.1 Introduction

Congratulations on purchasing Winmate® 14-inch Rugged Windows Tablet M140TG/T.

M140TG/T is a rugged tablet with robust features designed to withstand industrial use while providing high-tech solutions that increase productivity, improve safety, and reduce operational costs. It features:

- 11<sup>th</sup> Gen. Intel® Processor Family – Tiger Lake Processor
- 14-inch tablet, 1920 x 1080 wide viewing angle LED Panel
- Optical bonding and Anti-glare technology for sunlight readability
- IP65 waterproof and dustproof
- Hot-swappable battery for whole day work
- Optional integrated Smart Card Reader

### 2.2 Unpacking

Check and identify the supplied accessories:

- **Tablet Computer**

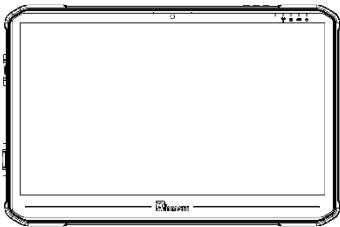

- **Standard Battery**

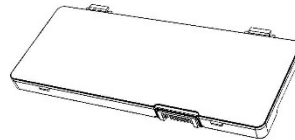

- **Power Adapter**



- **Power Cord and Plugs**



- **Stylus**

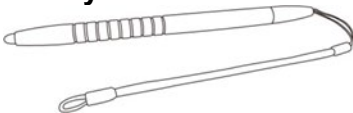

- **Quick Start Guide**



Your package may include other optional accessories based on your order:

## 2.3 Description of Parts

Dimensions: 341.91 x 224.67 x 25.4 mm

Front:

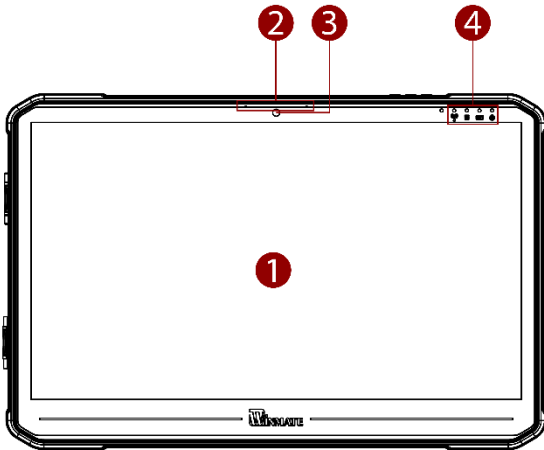

Left:

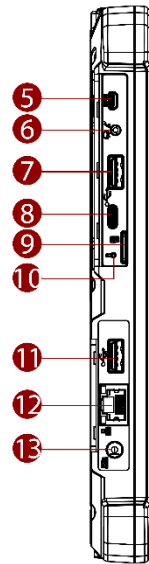

Right:

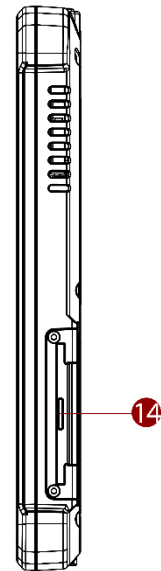

No	Item	Description
1	14" Touch Screen	Display and act as one of the inputs for the Tablet Computer
2	Digital Microphone	Enable audio recording for communications, music vocals, speech, and sound recording.
3	Front Camera	2 Megapixel Webcam
4	LED Indicators	Show the current status of the tablet computer: battery status and power status.

No	Item	Description
5	Micro HDMI (Optional)	HDMI output to the external display
6	Audio Jack	Headset or headphone can be connected (Mic is only supported with 3.5mm 4-pin headset)
7	USB 3.0 Type-A	USB 3.0 port connects to USB devices, such as USB flash drive, mouse, keyboard, printer, etc.
8	USB 3.0 Type-C	A high-speed USB port connects to USB devices.  <b>Note:</b> The USB Type-C connector follows USB 3.0 standards, not supporting Alternate Mode (ALT) or USB Power Delivery (USB-PD).
9	MicroSD Card Slot	Memory card reader port for MicroSD Card
10	Reset Button	Hardware reset button
11	USB 3.0 Type-A	USB 3.0 port connects to USB devices, such as USB flash drive, mouse, keyboard, printer, etc.
12	RJ45 Connector	Connects the LAN cable.
13	Power Jack	DC power input jack.
14	Smart Card Reader	Only available on M140TGT

Rear:

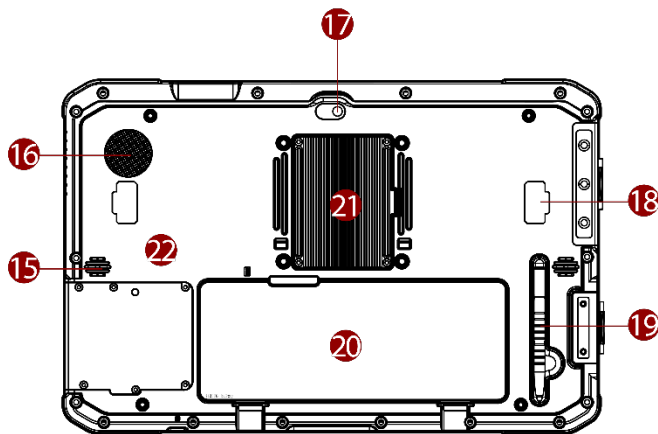

Top:





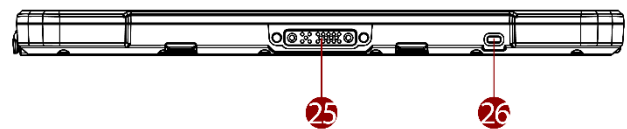

Bottom:



No	Item	Description
15	Speaker	Send out sound and voice from the computer.
16	Fan	Cooling system
17	Rear Camera	8MP Autofocus Camera. Capture photos and videos.
18	Kickstand Handle (Optional)	User-adjustable 180° kickstand handle
19	Stylus	Use as an input.
20	Battery	11.4 V, typ. 3500 mAh. Li-ion re-chargeable battery (3S1P)
21	Service Windows	Access to SSD and WWAN module.
22	HF RFID (Optional)	Read HF RFID tags.

No	Item	Description
23	Power Button	Power on/off the tablet
24	Function Buttons	Programmable function keys configured by Hottab Utility
25	Docking Connector	Port to docking solutions such as vehicle docking to provide power and external antenna.
26	Kensington Lock	Use to attached tablet computer around a table leg or another secure location.

## 2.4 Indicators

Icon	Indicator	Description
	RF Communication	<b>Green</b> – WLAN/ BT/ 4G LTE/ GPS is ON. <b>No light</b> - None of WLAN / BT/ 4G LTE/ GPS is ON.
	Disk Activity Indicator	<b>Green</b> – Hard drive activity. <b>No light</b> – Hard drive idling.
	Power Indicator	<b>Blue</b> – Tablet is ON <b>No light</b> – Tablet is OFF
	Battery Status	<b>Green</b> – AC adapter is plugged in and batteries are fully charged. <b>Solid Orange</b> – AC adapter is plugged in and battery is charging. <b>Flash Orange</b> – AC adapter is plugged in and batteries are charging <b>Solid Red</b> – Low battery level (<10%). <b>No light</b> – Battery is in use and more than 10%.

## 2.5 Hotkey for Specific Functions

Physical buttons with its dedicated functions can also be used to emulate commonly used keyboard keystrokes. Under a different scenario, a single physical button or a combination of physical buttons provide different keyboard keystrokes, which are specified below:

**In POST (before Windows boots up):**

Buttons	Keystroke
<b>Fn1</b>	enter Recovery Menu
<b>Fn2</b>	enter BIOS setup screen
<b>Fn3</b>	

**In Windows:**

Buttons	Keystroke
<b>Fn1</b>	Short Press Default: Web Browser Long Press Default: Touch Mode
<b>Fn2</b>	Short Press Default: None Long Press Default: Volume Mute
<b>Fn3</b>	Short Press Default: Calculator Long Press Default: Notepad

## 2.6 First-Time Operation

### 2.6.1 Installing Battery

*To install the standard battery pack:*

1. Disconnect any cords connected to the tablet computer and turn the tablet over, back facing up.
2. Insert the battery with the connector-pins side first, and then lower the battery into the battery compartment. The battery will be flat against the housing once fully inserted.
3. Slide the Battery Lock to the "Locked" position.

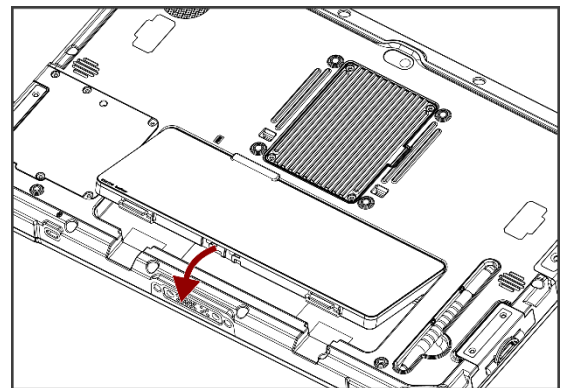

*To remove the battery pack:*

1. Shut down the tablet (or put it into sleep mode). Disconnect any cords connected to the computer.
2. Turn the tablet computer over, back facing up.
3. Push and hold the Battery Release Latch while lifting the battery out of the compartment.

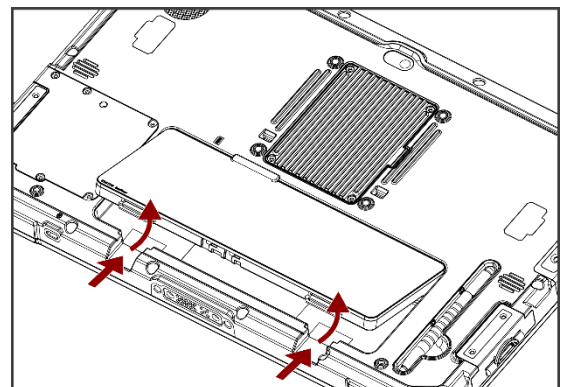

## 2.6.2 Installing SIM card (For 4G/LTE Equipped Devices)

The Tablet Computer supports 4G/LTE data connections and fits a Nano-SIM card.

To install the SIM card:

- 1 Remove the battery, as described in the section *Inserting Battery Pack*.

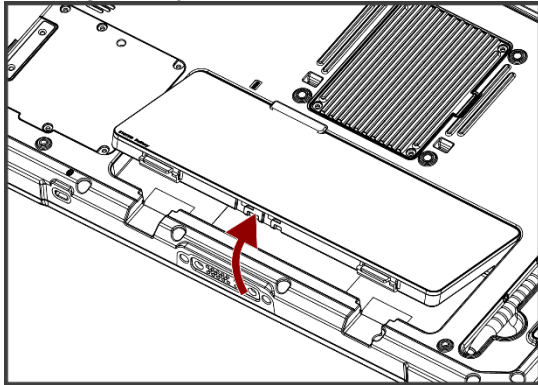

- 2 Push and pull out the SIM-card slot.

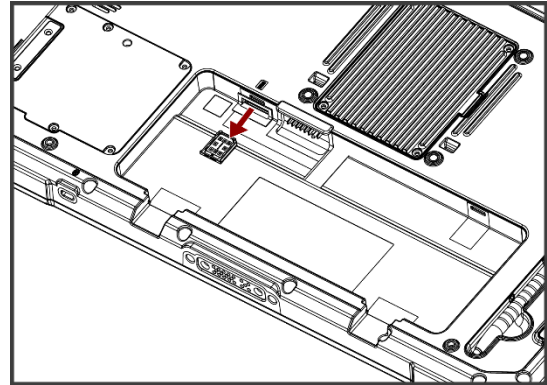

- 3 Insert SIM-Card on the other side of the SIM-card slot. **Chip/contact is facing down**

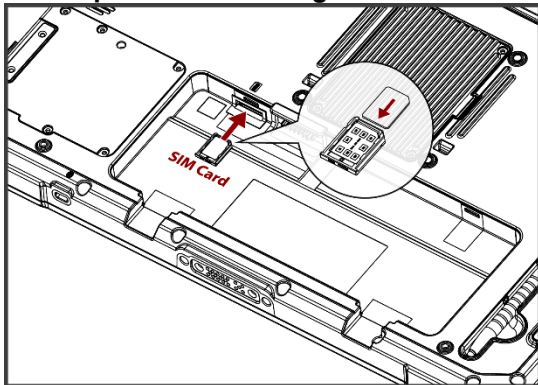

- 4 Push the SIM-card slot and put the battery back.

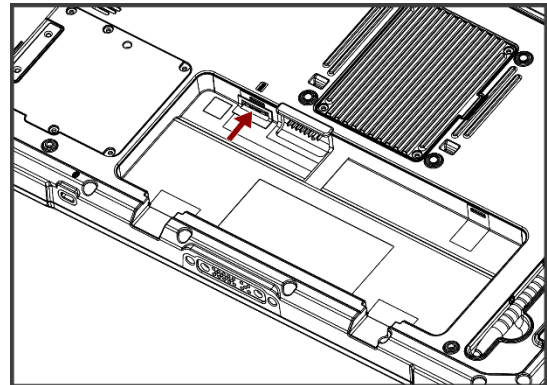

## 2.6.3 Installing a MicroSD Card

Your tablet supports additional storage with an optional microSD card slot.

To install MicroSD Card:

1. On the left side of the device, open I/O protective cover.
2. Insert the microSD card into a slot with contacts the bottom part of the device.
3. Press the card in to ensure that it is seated properly.
4. Close I/O protective cover.

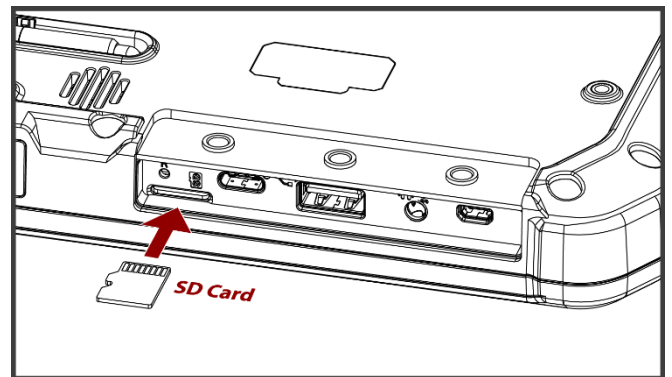

To remove Micro SD Card:

1. Open I/O protective cover by pulling out the latch.
2. Push and release the microSD card to unlock it.
3. Pull out the microSD card.

## 2.6.4 Charging Your Tablet

The tablet operates either on AC power or internal and external battery power. It is recommended to use AC power when you start up the tablet for the first time.



**Caution** Use only the AC adapter included with your Tablet Computer. Using other AC adapters may damage the Tablet Computer and the Battery.

**Attention** Utilisez uniquement l'adaptateur secteur fourni avec votre tablette. L'utilisation d'autres adaptateurs secteur peut endommager la tablette et la batterie.

To connect a tablet to AC power:

1. Open I/O protective cover by pulling out the latch.
2. Plug the DC cord of the AC adapter into the power jack of the tablet computer.
3. Plug the AC power cord into the AC adapter.
4. Plug the AC power cord into the electrical outlet.

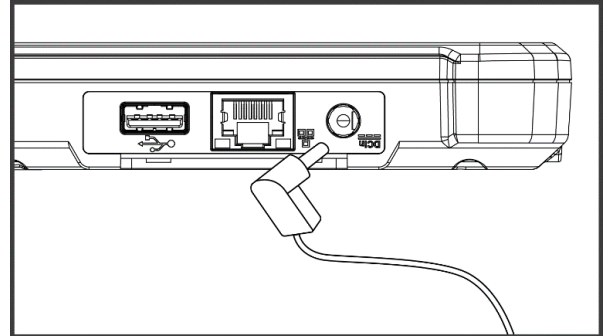

The battery LED indicator shows different battery states:

**Green** – AC adapter is plugged in and batteries are fully charged.

**Solid Orange** – AC adapter is plugged in and battery is charging.

**Flash Orange** – AC adapter is plugged in and batteries are charging.

**Solid Red** – Low battery level (<10%).

**No light** – Battery is in use and more than 10%.

Batteries behavior:

External battery capacity	Powered by
More than 10%	External Battery
Less than 3%	Automatically switch to internal Battery

To check internal and external batteries capacity, please refer to Chapter 4.4 Check Battery Capacity.

## 2.6.5 Starting the Tablet



### Important:

When powering on the device for the first time, please make sure there's no interruption during the Windows setting up process, for example, accidentally powering off. If it happened, please access the recovery menu by pressing **Fn1** button to initiate the recovery process.

Press and hold the power button for **3 seconds** until the blue LED power indicator light up.



### Note:

Do not press the power button repeatedly.

Do not perform the following operations until the tablet is booted to Windows.

- Connecting or disconnecting the AC adapter
- Pressing the power button
- Touching the tablet buttons, screen, or external keyboard/mouse

To power off the Tablet Computer:

1. Make sure you have closed any programs that are open on the desktop. Start Screen apps don't need to be closed.
2. Tap on **Power**.
3. Tap on **Shut Down**.
4. Wait for Tablet Computer to power off.



### Note:

The computer will forcibly be powered off if the power button is pressed and held for **6 seconds or longer**.

## Chapter 3: Setting Up Windows for the First Time

This chapter details how to setup the Windows that may be installed on the tablet for the first time.

### 3.1 Introduction

The M140TG/T Tablet Computer operates on Windows 10 IoT Enterprise operating system.



**Caution** Make sure the battery is full charged before starting the Tablet Computer for the first time with internal battery power.

**Attention** Assurez-vous que la batterie est complètement chargée avant de démarrer la tablette PC pour la première fois avec l'alimentation par batterie interne.

- **Public network:** Select this location if you do not recognize all the computers on the network. (For example, you are in a coffee shop or airport or have mobile broadband) with a public network and is *not* trusted. Select the location where you will most often use the computer.

### 3.2 Setting up Windows 10 IoT Enterprise

Follow the steps below to complete the Windows 10 IoT Enterprise set-up process.

1. Press the power button to turn on the computer.
2. Select your region, then tap Yes.

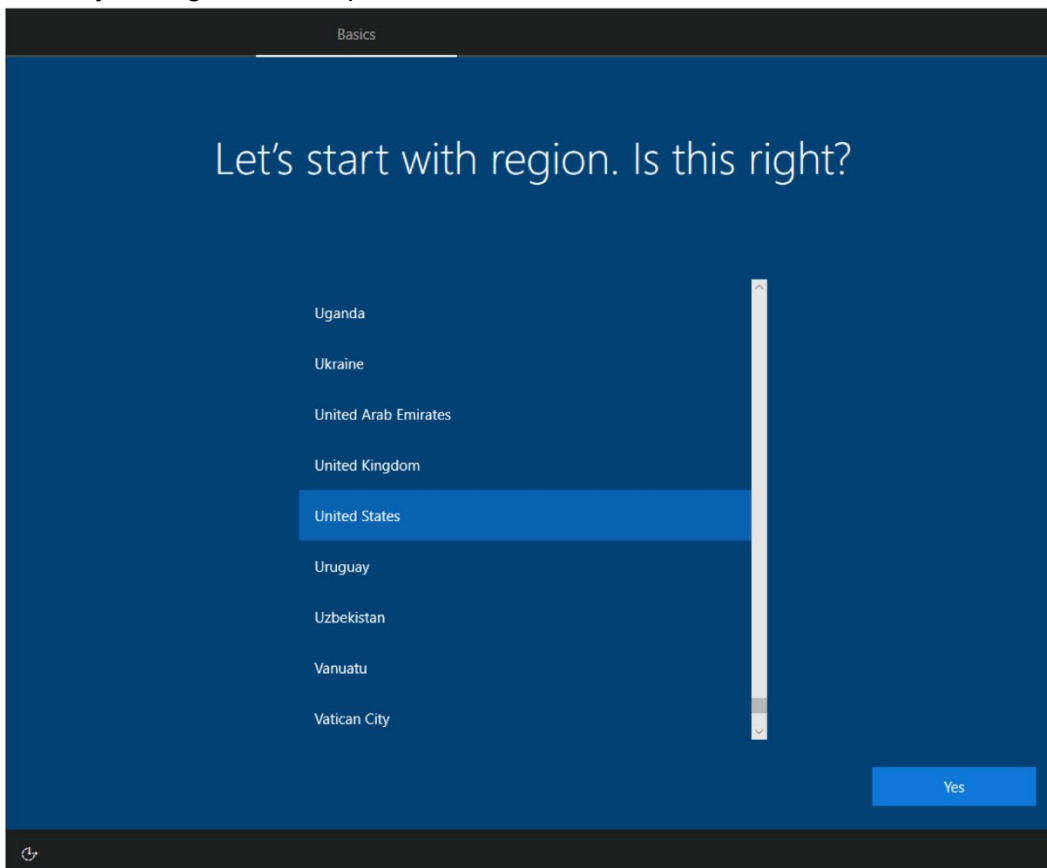



3. Select your preferred keyboard layout, then tap **Yes**.

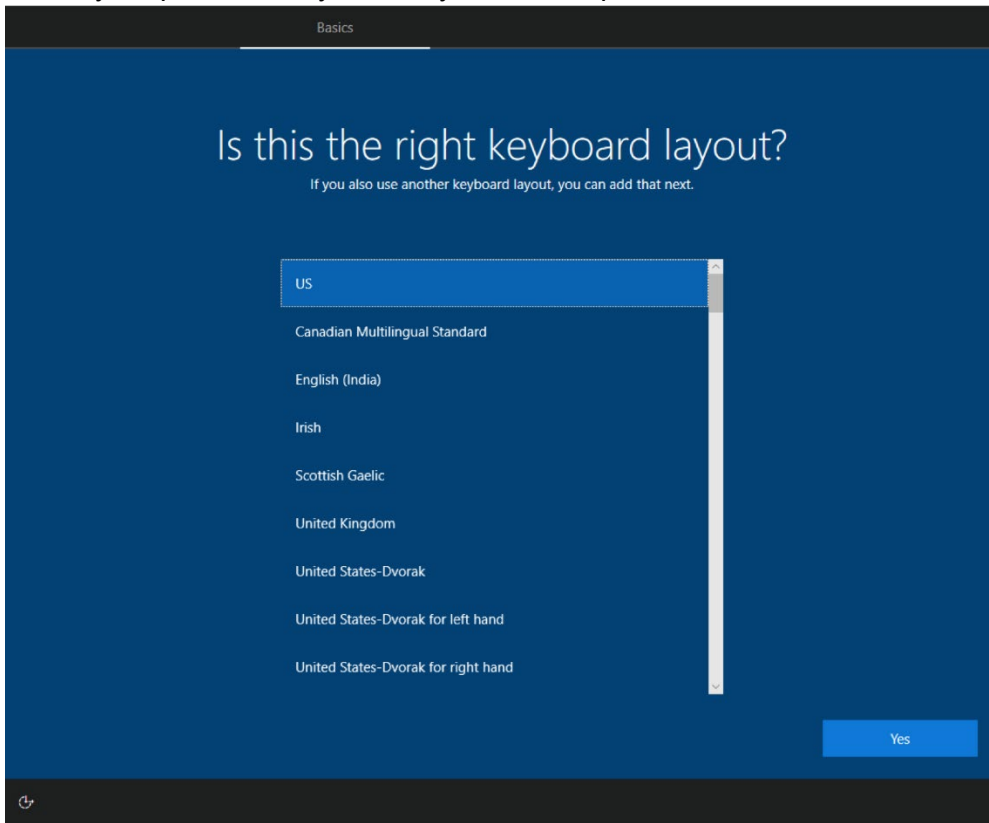

4. Tap **Add layout** if you want to add a second keyboard layout, or tap **Skip** for the next step.

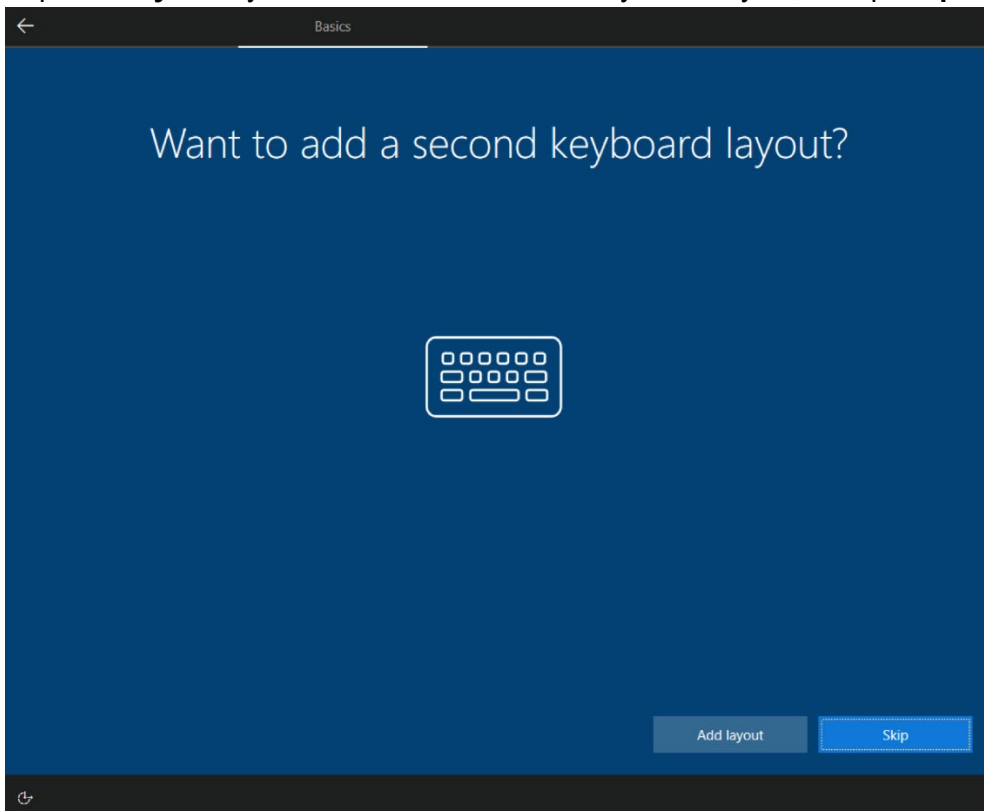

5. Windows will then try to connect you to a network. Select your network or tap **I don't have internet** to continue without a wireless connection, as you can set up the network later. You'll then jump to 7. if you don't connect to a network.

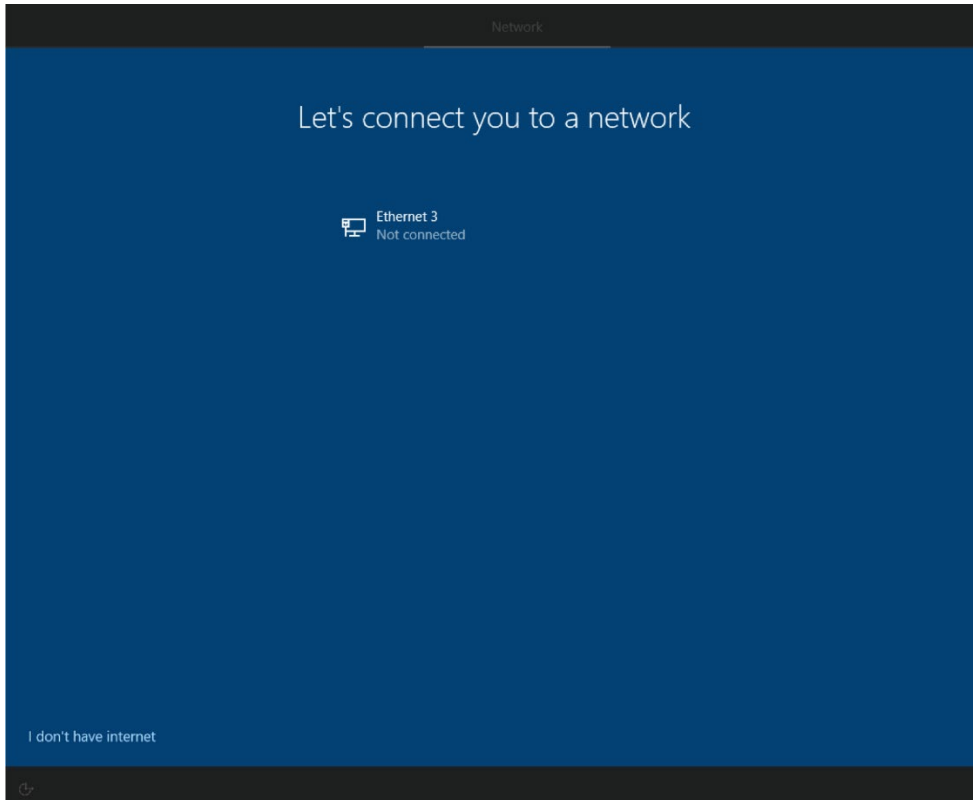

6. Tap **Connect now** to connect to your Microsoft account so that you could get the features and security, or tap **Continue with limited setup** to continue without connecting to the account, as you can connect to your account later.

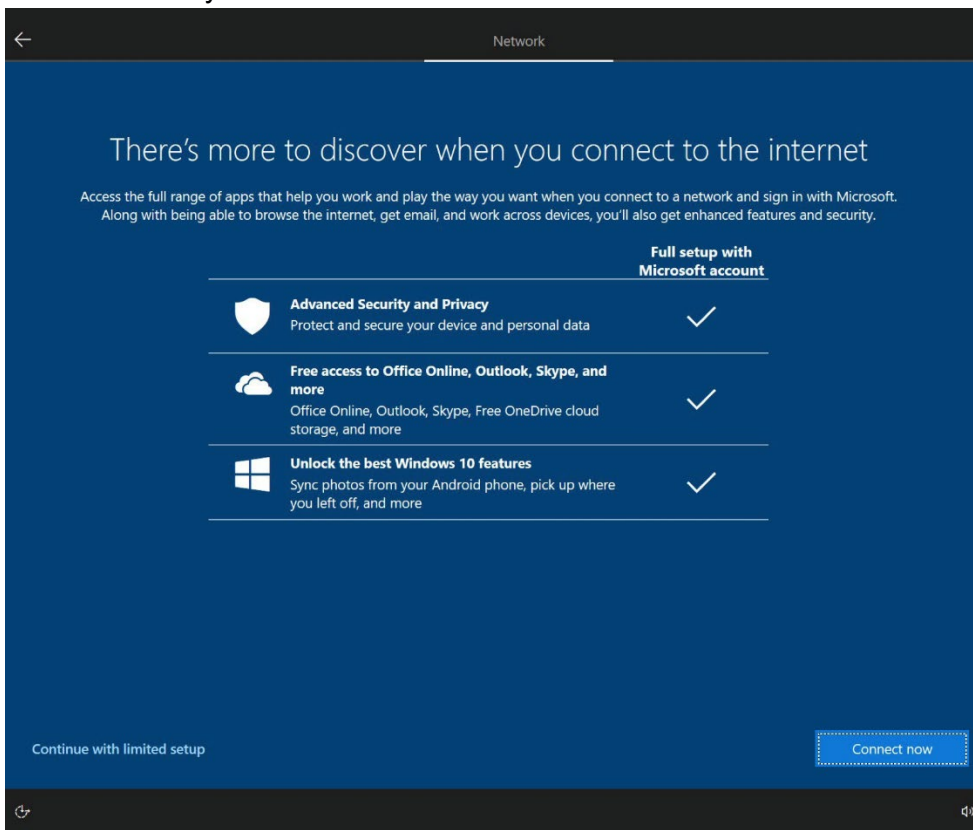

7. Type your name, then tap **Next**.

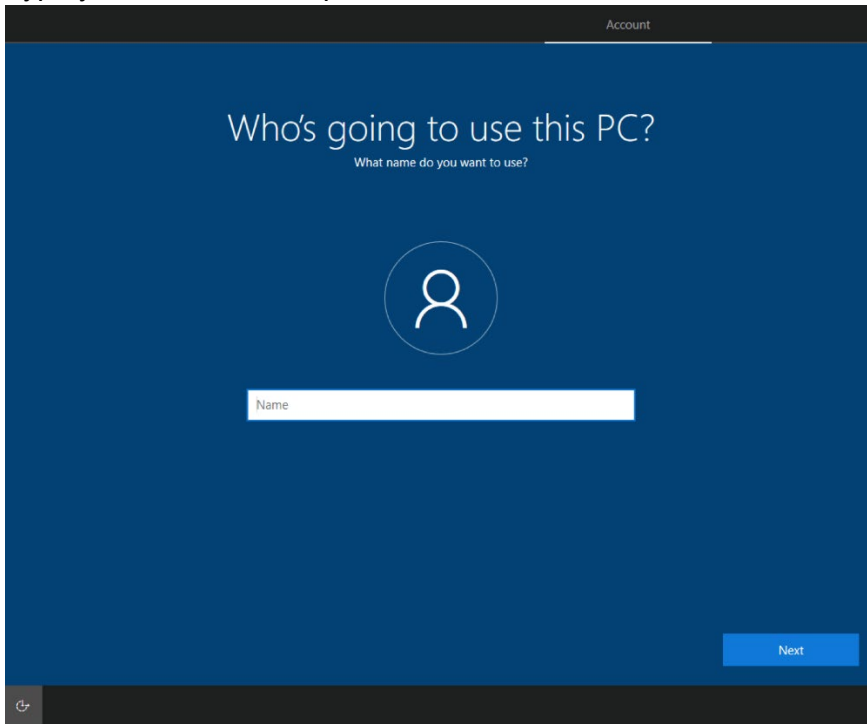

8. Create your password, then tap Next

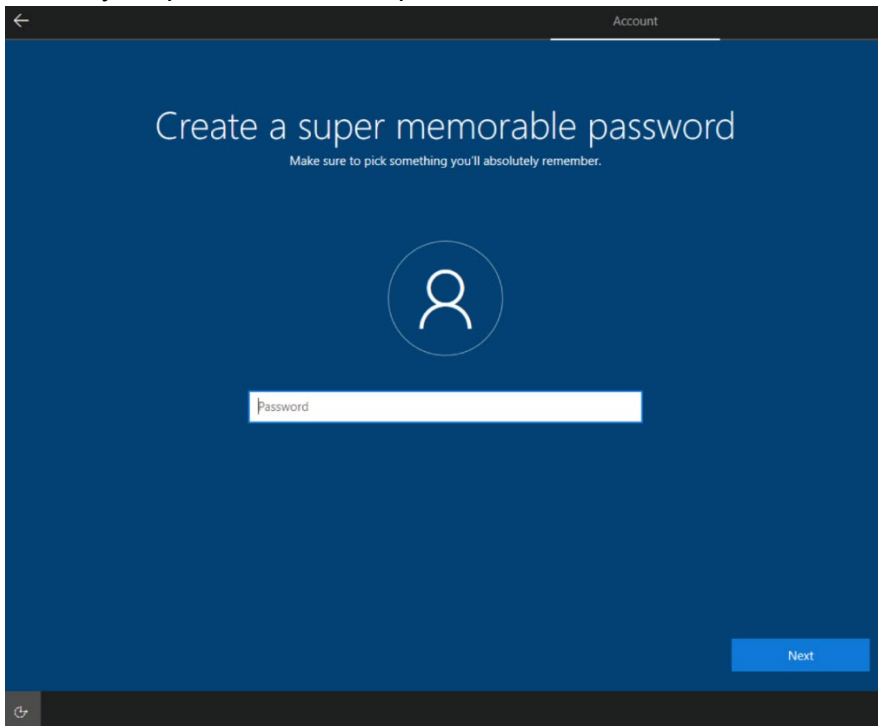

9. Read each privacy settings and choose it, you can tap **Learn more** for more information, or tap **Accept** to save them. You can change these settings at any time.

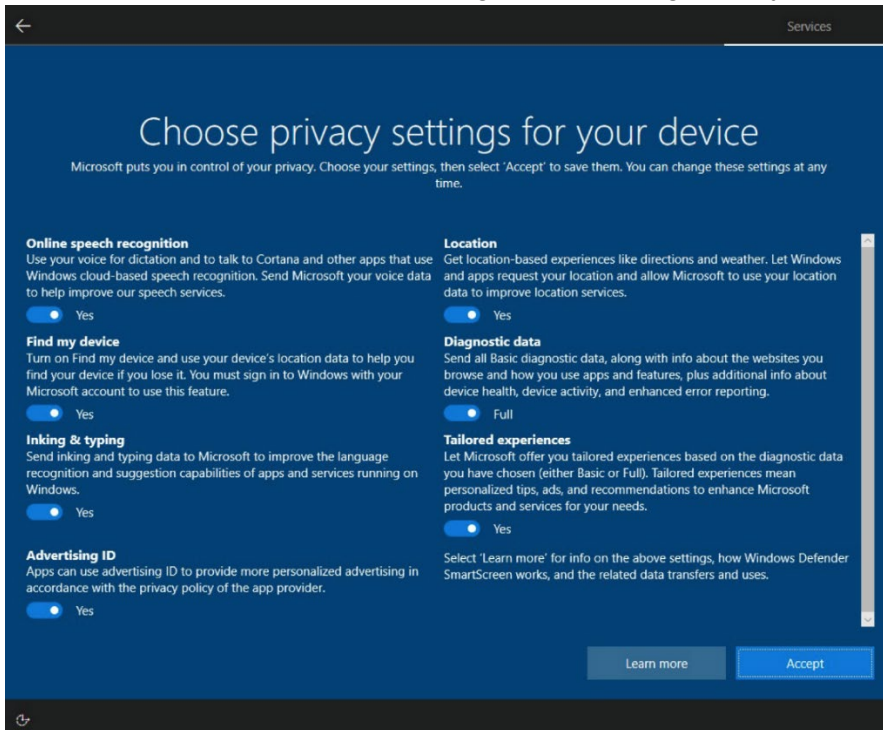

10. Read any introductory screens describing features of your computer, and tap **Next** upon completing each. You are now done with the initial setup process.

## 11. Create your password, then tap Next

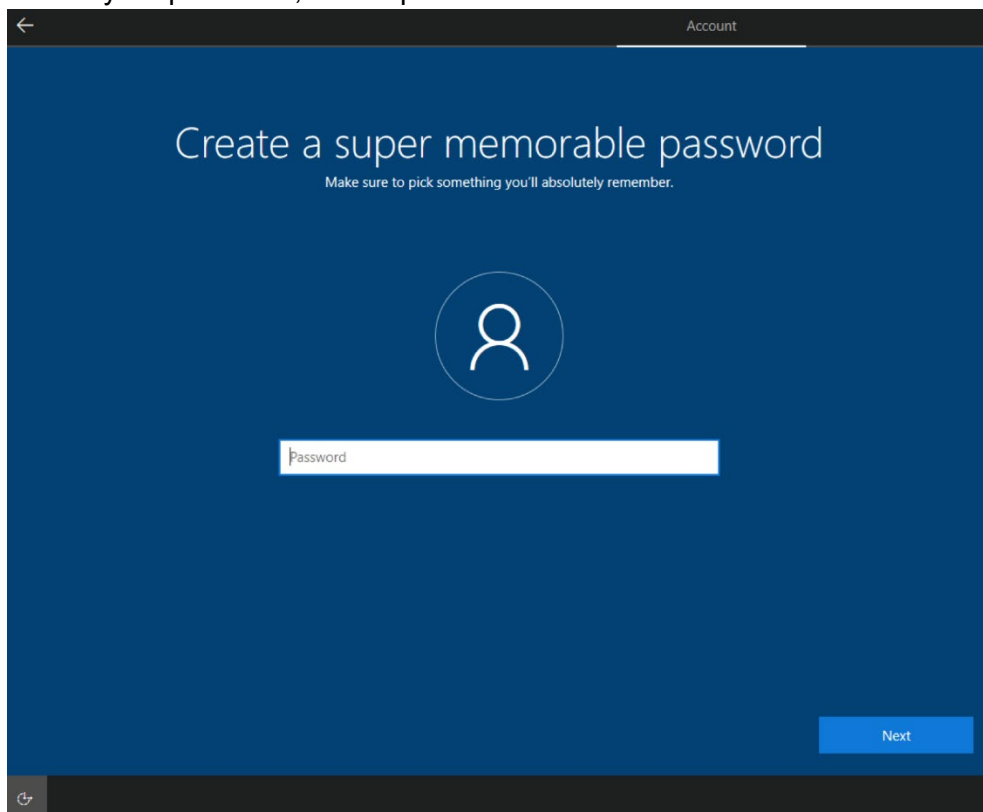
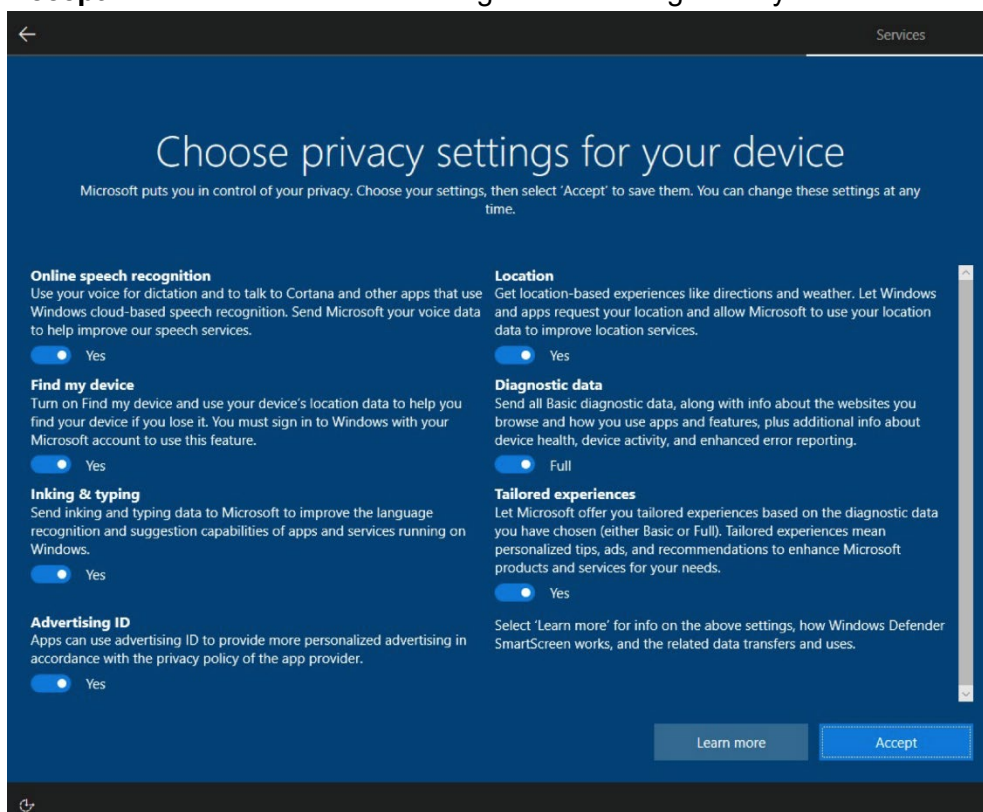
12. Read each privacy settings and choose it, you can tap **Learn more** for more information, or tap **Accept** to save them. You can change these settings at any time.13. Read any introductory screens describing features of your computer, and tap **Next** upon completing each. You are now done with the initial setup process.

## Chapter 4: Operating the Device

This chapter describes how to operate the M140TG/T Tablet Computer.

### Note:



Please download the SDK from Winmate Download Center (the QR code in the cover page) >> M140TG >> Development Kit.



Please notice that the RFID reader is an optional module. Please make sure you have ordered the module before using the SDK.

### 4.1 Hottab Introduction

Hottab provides quick access to the tablet's functions and features, such as setting up shortcuts, using camera, powering on/off built-in devices, programming function keys, and changing power management. As Windows starts up, Hottab starts and runs in the background. To display the Hottab control utility, launch the Hottab Utility application .

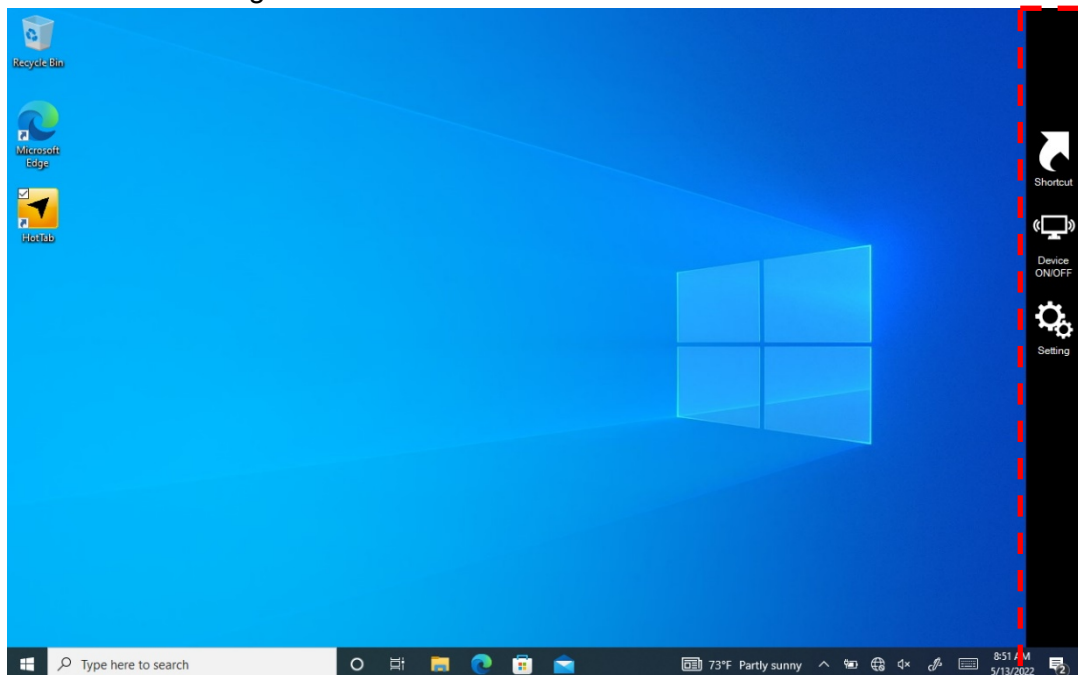
The main user interface is located on the right side of the screen. There are 4 main menu options: Shortcuts, Camera, Device ON/OFF, and Settings. Operations and functions on each menu option are explained in detail in the coming section.



Icon	Description
 Shortcuts	Allows users to configure short cut to access programs quickly with a few tabs.
 Device ON/OFF	Enables/disables tablet computer's hardware functions. The configurable functions are WLAN, WWAN (4G/LTE), GPS, BT, Camera, LED indicators, Barcode Reader, and GPS Antenna routing options.
 Settings	Provide PC information, battery status, device settings such as power management setting, and function key mappings.

## 4.2 Shortcuts

Hottab Shortcuts Menu provides a user-friendly interface to configure onscreen software shortcuts and allow users to access programs quickly with a few taps. The Shortcuts menu offers 8 empty slots to store user's desired quick access. Shortcuts can be mapped to any of the executable files (.exe) installed on the tablet.

### Short Cut Menu:

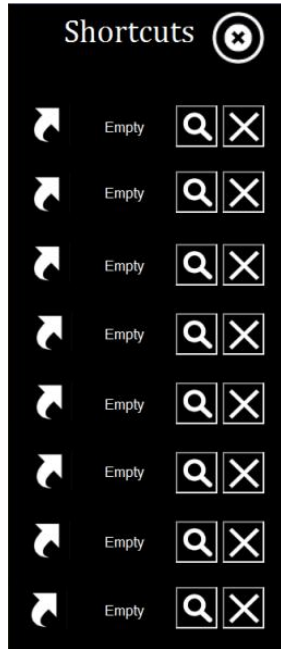

### To store a new shortcut:

1. Launch the Hottab Utility application.
2. Tap on the **Shortcuts** button.
3. Tap on  button of any empty slot.
4. An onscreen file browser will appear.
5. Browse to find the desired application to have a shortcut.
6. Click "Open" to save the shortcut.

### To remove a saved shortcut:

1. Launch the Hottab Utility application.
2. Tap on the **Shortcuts** button.
3. Tap on the  button of any saved slot to remove
4. The shortcut will be removed and show "Empty" to indicate the slot is empty.

Tap on the  button will hide the Hottab Utility Menu.

### Using the Hottab shortcuts:

1. Launch the Hottab Utility application.
2. Tap on the **Shortcuts** button.
3. Tap on the saved shortcut items to access saved programs.

## 4.3 Built-in Devices On/Off

This section describes how to get quick access to set up built-in devices, including turning on/off RF modules and setting up barcode reader.

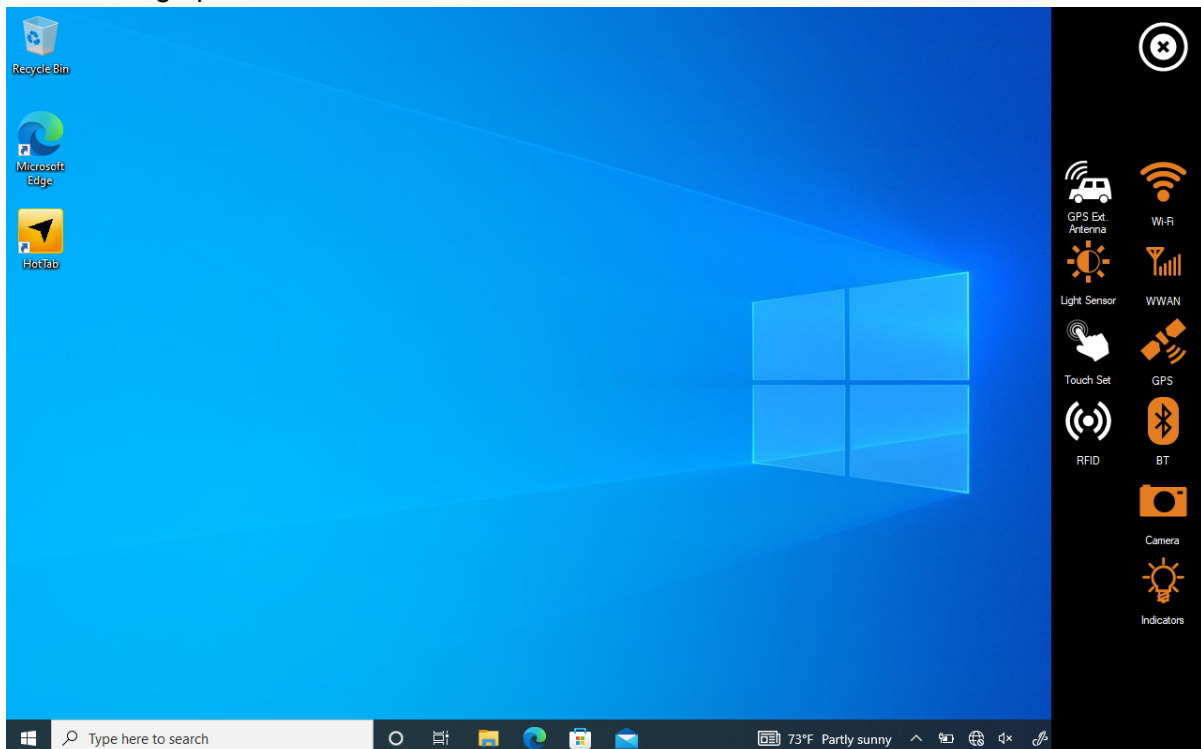

### 4.3.1 Using the Wireless LAN

To use the wireless LAN (WLAN) feature to connect to the network, perform the following procedure:

1. Launch the Hottab Utility application.
2. Tap on the **Device ON/OFF** button.
3. Check the status color of the **Wi-Fi** icon:

Item	Status Color	Description
 <b>Wi-Fi</b>	Orange	WLAN is enabled.
	White	WLAN is disabled.

4. If the WLAN feature is disabled (white), tap on the Wi-Fi icon to enable it (orange).
5. Click the wireless network connection status icon in the Windows notification area. A list of available wireless networks is displayed.
6. Double-click a network to connect to it. Provide required authentication information if needed.
7. To check the connection status, observe the wireless network connection status icon in the Windows notification area. The more bars the icon shows, the better the wireless LAN connection strength is.
8. Now wireless LAN connection is set up, try to connect to the network with an internet browser such as Internet Explorer.

### 4.3.2 Using the Wireless WAN



**Note:**

Please make sure a SIM card is placed. Refer to Chapter 2.6.2 Installing SIM card.

To connect to the network using wireless WAN:

1. Launch the Hottab Utility application.
2. Tap on the **Device ON/OFF** button.
3. Check the status color of the **WWAN** icon:

Item	Status Color	Description
 <b>WWAN</b>	Orange	WWAN (4G/LTE) is enabled.
	White	WWAN (4G/LTE) is disabled.

4. If the WWAN feature is disabled (white), tap on the WWAN icon to enable it (orange).
5. You can check the wireless WAN connection status through the wireless network connection status icon in the Windows notification area. The more bars encompassed, the better the signal is.

### 4.3.3 Using the GPS

The GPS is optional feature for M140TG and M140TGT Tablet PCs and is not re-workable by the end user. To use this feature, please make sure the tablet PC is support function before use, or contact our sales contact window for more details.



To enable the GPS:

1. Launch the Hottab Utility application.
2. Tap on the **Device ON/OFF** button.
3. Check the status color of the **GPS** icon:

Item	Status Color	Description
 <b>GPS</b>	Orange	GPS is enabled.
	White	GPS is disabled.

4. If the GPS feature is disabled (white), tap on the GPS icon to enable it (orange).
5. Now the GPS feature is ready to be used with an application utilizing the GPS.

#### 4.3.4 Using the BT

To enable the BT:

1. Launch the Hottab Utility application.
2. Tap on the **Device ON/OFF** button.
3. Check the status color of the **BT** icon:

Item	Status Color	Description
 <b>BT</b>	Orange	BT is enabled.
	White	BT is disabled.

4. If the BT feature is disabled (white), tap on the **BT** icon to enable it (orange).
5. Click the **BT** icon in the Windows notification area. A contextual menu for BT is displayed.
6. To add a device, tap on **Add a Bluetooth Device**. Windows will search any BT device automatically.
7. Choose the BT device to connect and follow the onscreen prompt to continue the pairing procedure and use the BT device.

#### 4.3.5 Using Camera



##### CAUTION

Possibly hazardous optical radiation emitted from this product. Do not stare at operating lamp. May be harmful to the eyes.

This Hottab menu option allows users to take a picture or record a video. Before use, make sure the camera is on under the **Device ON/OFF** menu with the following scenarios.

1. Launch the  Hottab Utility application.
2. Tap on **Device ON/OFF** button to check the status of the built-in device.
3. Check the status color of the **Camera** icon:

Item	Status Color	Description
 <b>Camera</b>	Orange	The camera is enabled.
	White	The camera is disabled.

4. If the camera is disabled (white), tap on the *Camera* icon to enable it (orange).





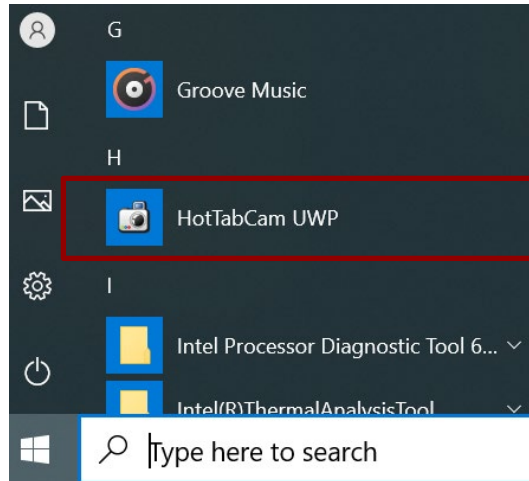

To open camera interface:

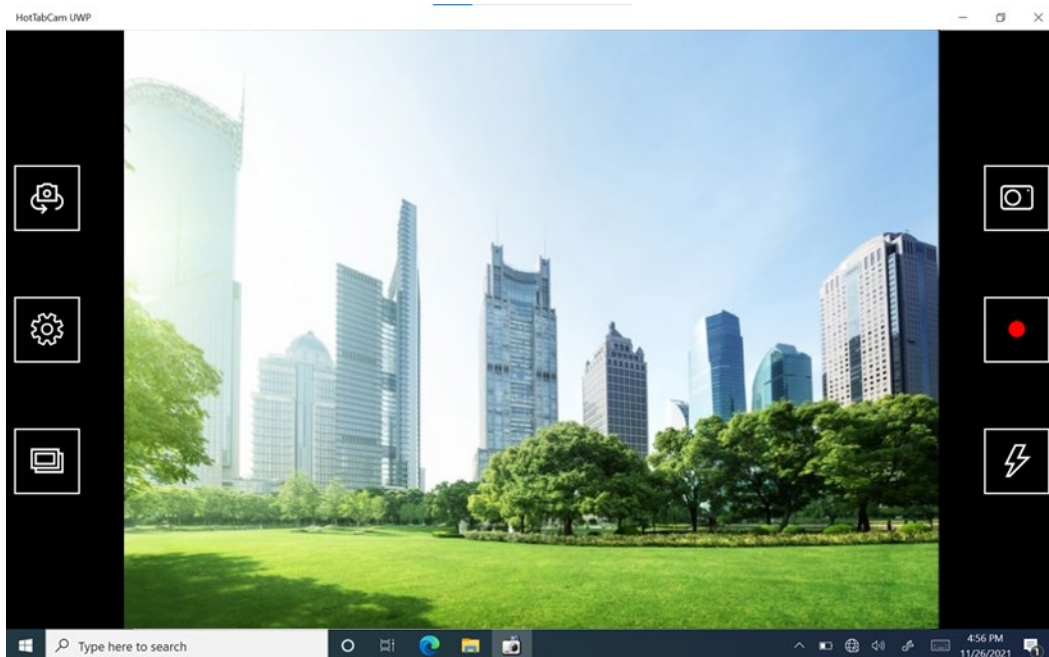
1. Click  **Start** → **HotTabCam UWP**.



2. The default camera is the rear camera. To change into the front camera, click on the **Switch Camera** button.



No	Item	Description
1	<b>Switch Camera</b> 	Switch between front camera or rear camera.
2	<b>Settings</b> 	Set picture quality.
3	<b>Review</b> 	Review. <ul style="list-style-type: none"> <li>• <b>Picture Save:</b> modify/inspect saved location for pictures.</li> <li>• <b>Video Save Folder:</b> modify/inspect saved location for video recordings.</li> </ul>
4	<b>Shutter Camera</b> 	Camera Shutter Button. Tap to take picture.
5	<b>Video Record</b> 	Tap to Start, and press again to stop recording.
6	<b>Flash Control</b> 	Enables/ Disables LED Flash when taking picture.

### 4.3.6 Turning On/Off LED Indicators

The LED Indicators for Power and Battery status can be turned on/off from Hottab menu.

To enable/disable the LED indicators:

1. Launch the Hottab Utility application.
2. Tap on the **Device ON/OFF** button.
3. Check the status color of the **Indicator** icon:

Item	Status Color	Description
 <b>Indicator</b>	Orange	LED indicator is enabled.
	White	LED indicator is disabled.

4. If the indicator is disabled (white), tap on the Indicator icon to enable it (orange).

### 4.3.7 Turn on/off the GPS External Antenna

The vehicle dock of the M140TG/T Tablet PC supports an external GPS antenna through a standard SMA connector. To work with an external GPS antenna, please make sure the tablet PC is installed correctly to the vehicle dock and the vehicle dock has connected with an external GPS antenna.

When working with the vehicle dock connecting to an external antenna, user can switch the GPS antenna from the internal to the external one from the Hottab menu.

To enable/disable the GPS Ext. Antenna:

1. Launch the Hottab Utility application.
2. Tap on the **Device ON/OFF** button.
3. Check the status color of the **GPS Ext. Antenna** icon:

Item	Status Color	Description
 <b>GPS Ext. Antenna</b>	Orange	GPS Ext. antenna is enabled and using an external antenna if available
	White	GPS Ext. antenna is disabled and using built-in antenna

4. If the GPS Ext. antenna is disabled (white), tap on the GPS Ext. Antenna icon to enable it (orange).

### 4.3.8 Turn on/off the Light Sensor



The Light Sensor can be turned on/off from the Hottab menu. To enable/disable the Light Sensor, perform the following procedure:

1. Launch the Hottab Utility application.
2. Tap on the **Device ON/OFF** button.
3. Check the status color of the **Light Sensor** icon:

Item	Status Color	Description
 <b>Light Sensor</b>	Orange	Light Sensor is enabled.
	White	Light Sensor is disabled.

### 4.3.9 Changing Touchscreen Modes

The tablet computer supports three built-in operating modes for different usage scenarios:

Mode	Description
 <b>Hand/Rain (Default)</b>	In <i>Hand/Rain</i> mode, the touchscreen rejects false inputs from liquid drops. When the liquid is removed, the touchscreen accepts touch inputs from bare fingertips. <i>Supports input by:</i> <ul style="list-style-type: none"> <li>• <i>Rubber tip passive stylus</i></li> <li>• <i>Bare fingertips</i></li> </ul>
 <b>Stylus</b>	In <i>Stylus</i> mode, the touchscreen supports inputs from the fine-tip passive capacitive stylus (shipped with tablet). <i>Support input by:</i> <ul style="list-style-type: none"> <li>• <i>Fine-tip passive stylus with palm rejection</i></li> <li>• <i>Rubber tip passive stylus</i></li> <li>• <i>Bare fingertips</i></li> </ul>
 <b>Glove</b>	In <i>Glove</i> mode, the touchscreen supports inputs while the user is operating the touchscreen with gloves on. <i>Supports input by:</i> <ul style="list-style-type: none"> <li>• <i>Glove</i></li> <li>• <i>Rubber tip passive stylus</i></li> <li>• <i>Bare fingertips</i></li> </ul>

To change touch mode:

- (1) Press and hold Function Key Fn1 (refer to User Manual, Chapter 4 to define the function key).
- (2) Launch HotTab Utility application. Choose "**Device ON/OFF**", and then click "**Touch Set**" icon.



#### 4.3.9.1 Switch via Built-in HotTab Utility

To switch touchscreen mode via the HotTab:

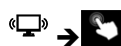
1. Launch the Hottab Utility application.
2. Choose "**Device ON/OFF**" and then click on **Touch Set** icon 
3. Under the **Touch Mode**, select the desired touch modes by tapping on the radio button.
4. Here's also additional touch-related settings to switch the touchscreen input between mouse mode with a cursor or with multi-touch mode:  
*Mouse Mode:* Single touch point supported, with mouse cursor shown.  
*Multi-touch Mode:* The default setting of the touch screen supports multi-touch mode (up to 10 points)

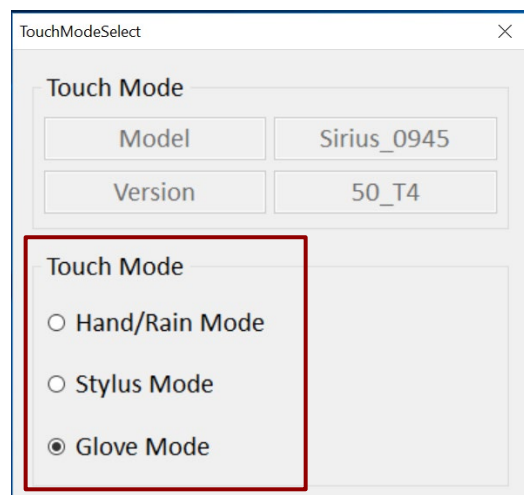

#### 4.3.9.2 Switch via Programmable Function Buttons:

To switch between the different touchscreen modes via the programmable function buttons, ensure the touchscreen mode switching is set to the programmable function buttons first.

1. Launch the Hottab Utility application.
2. Tap on the **Setting** button.
3. Tap on **Fn1** icon.
4. Tap on the **Long Press** icon.
5. Change the Long Press function to "**Touch Mode**" as shown below:

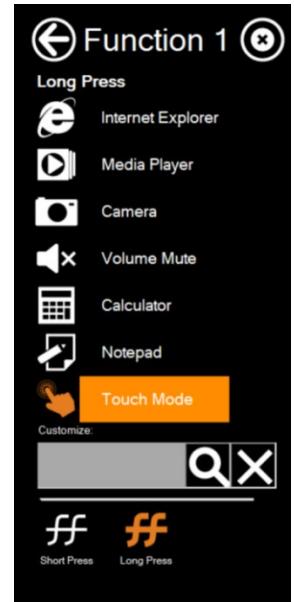

Once the touchscreen mode switching is set to the programmable function button, **Long Press** on **Fn1** function button to cycle through the different touchscreen modes, when touchscreen mode is switched, an icon will temporarily overlay on the lower center of the screen to indicate current touchscreen mode:

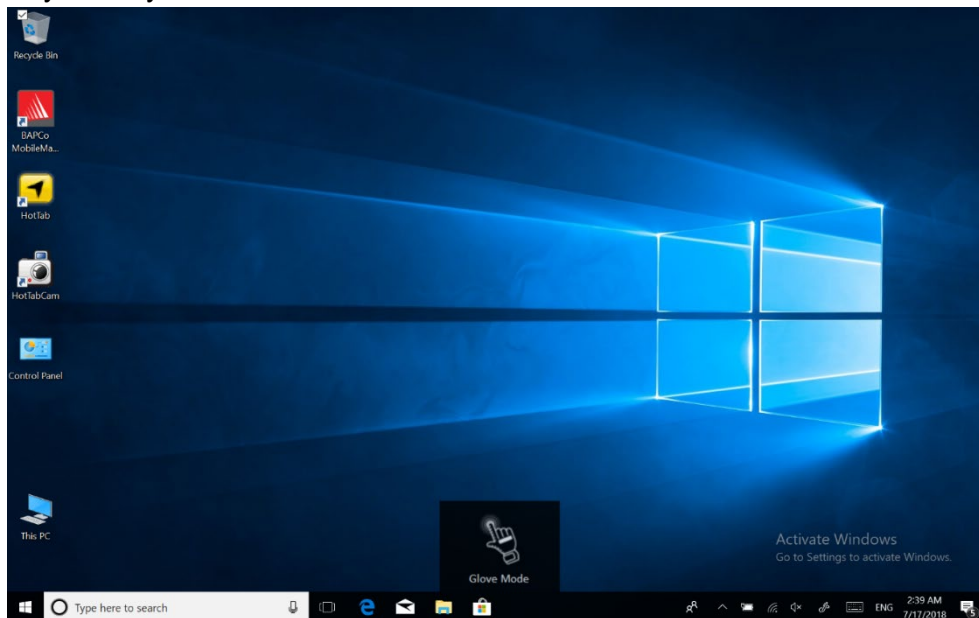

### 4.3.10 Using the HF RFID Reader

The HF RFID Reader is optional for M140TG and M140TGT Tablet PCs and is not re-workable by the end user. To use this feature, please make sure the tablet PC is a built-in HF RFID reader before use, or contact our sales contact window for more details.

To enable the HF RFID Reader feature:

1. Open the Hottab utility by press the  (Menu) Button located on the front panel OR launching the Hottab Utility application.
2. Tap on the **Device ON/OFF** button.
3. Tap on **RFID**, and the setting utility will show up as below:

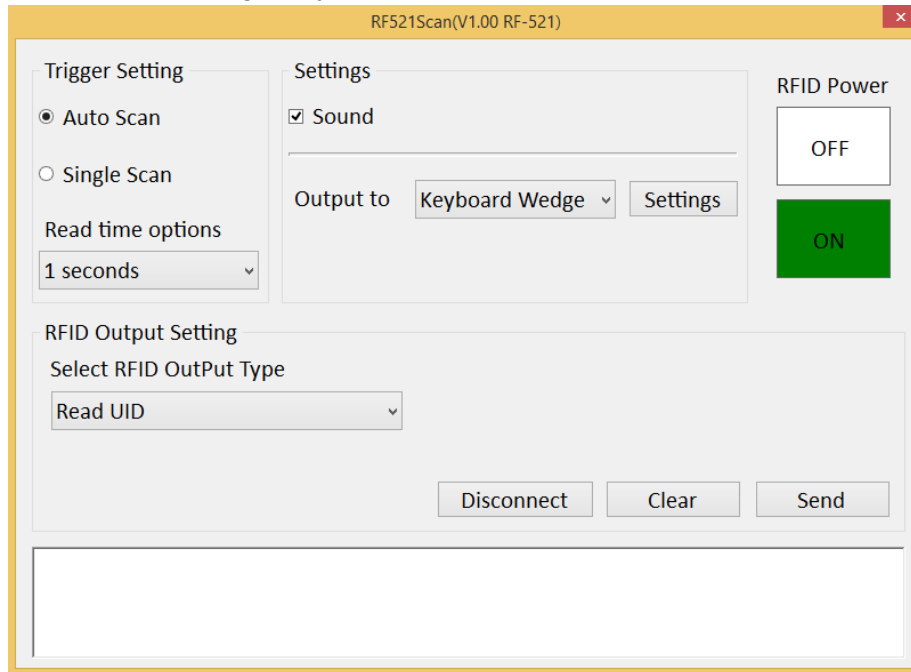

4. Tap on the **ON** button.
5. Check the status color of the ON icon is green and the status color of the RFID icon on the Hottab menu is orange at the same time.

Item	Status Color	Description
 <b>RFID</b>	Orange	HF RFID Reader is enabled.
	White	HF RFID Reader is disabled.

## 4.3.10.1 RFID Trigger Setting

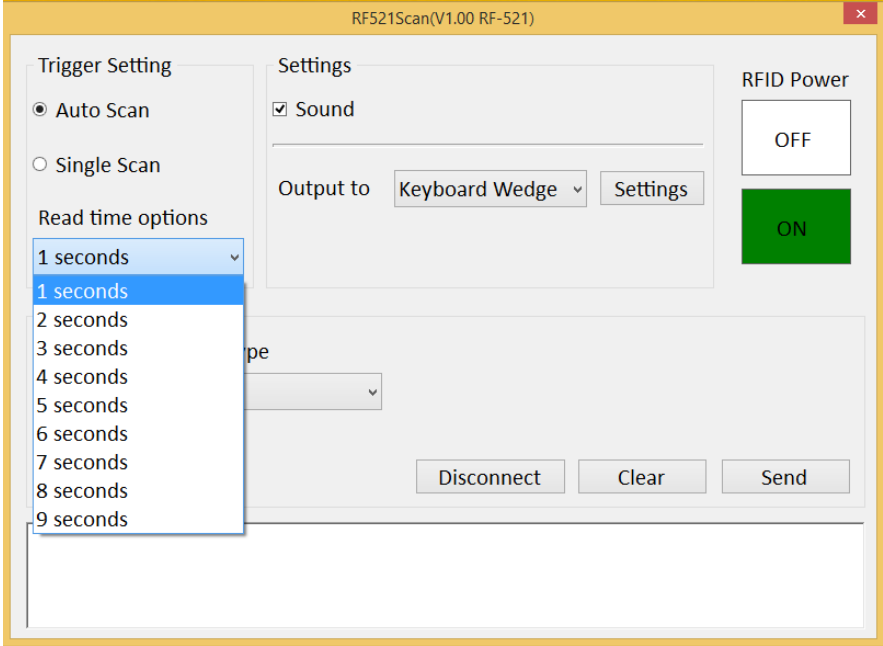
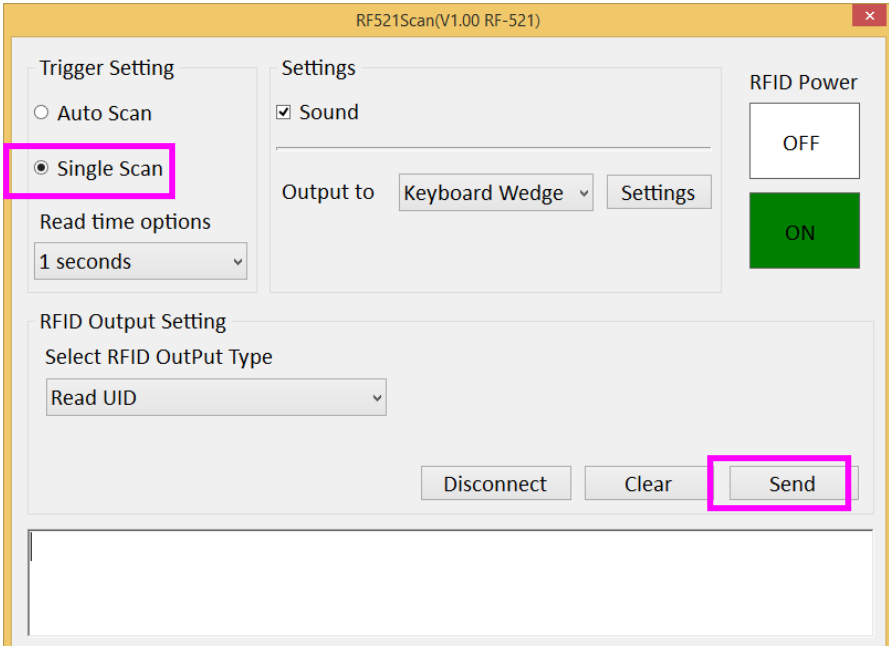
Item	Description
Auto Scan	<p>The default setting for the RFID trigger is Auto-Scan. Under this setting, the RFID Reader will always be ready to scan tags.</p> <ol style="list-style-type: none"> <li>1. When the RFID tag is detected from the RFID antenna, the data will be read automatically.</li> <li>2. User can define the RFID scanning frequency from the drop-down menu shown as below. The frequency can be from 1 second to 9 seconds.</li> </ol> 
Single Scan	<p>User can also define the RFID Reader scanning as a <b>Single Scan</b>. Under this setting, the RFID Reader will be triggered only when the user clicks on <b>Send</b>.</p> 

## 4.3.10.2 Settings

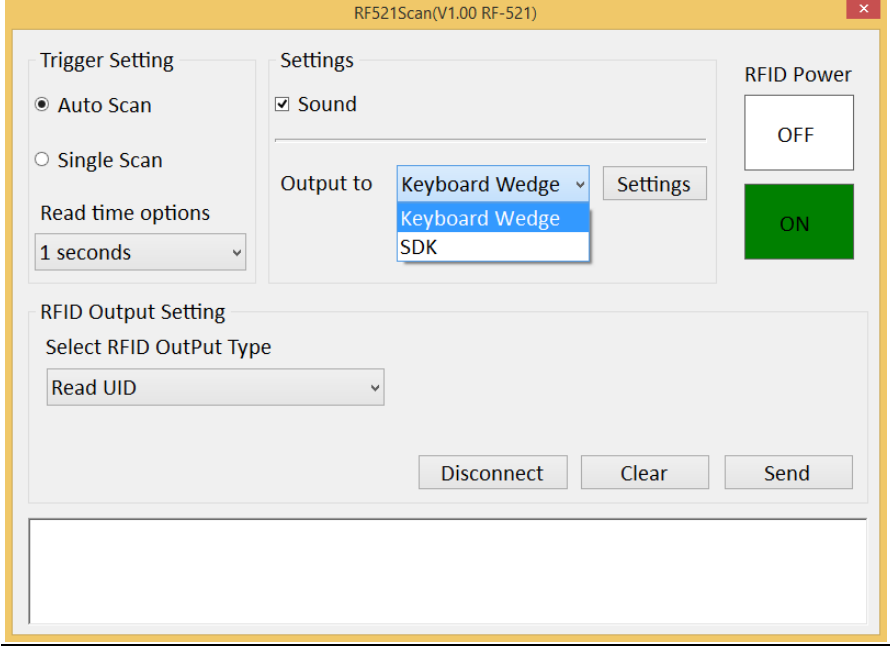
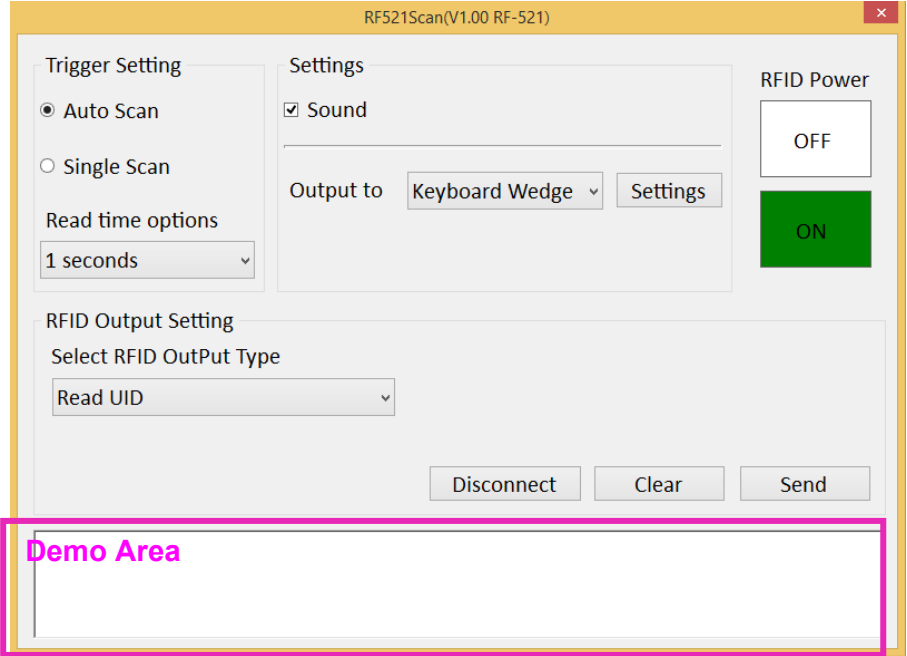
Item	Description
Sound	The <b>Sound</b> check box defines whether a beep sound will come with the data scanning.
Output to	<p>This setting defines the output type of the scanned data. Two options are available:</p> 
<p><b><u>Keyboard Wedge</u></b>  Under this setting, the data scanned is sent like keyboard data. The scanned data can be output directly to the demo area below this window. For data input, the user can also open other utilities, such as Office Word or Notepad files.</p>	
	
<p><b>Note:</b> notice that the input method should support the scanned character. User can also tap on the <b>Settings</b> button for further details settings.</p>	



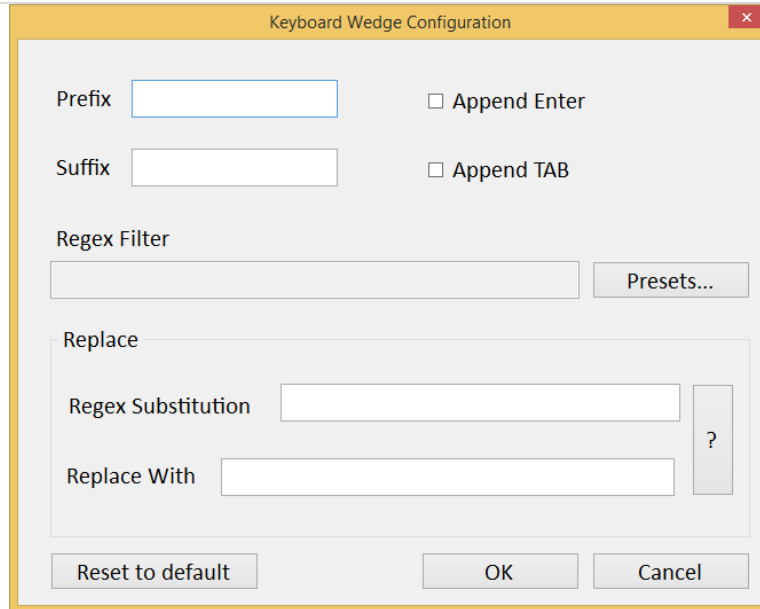

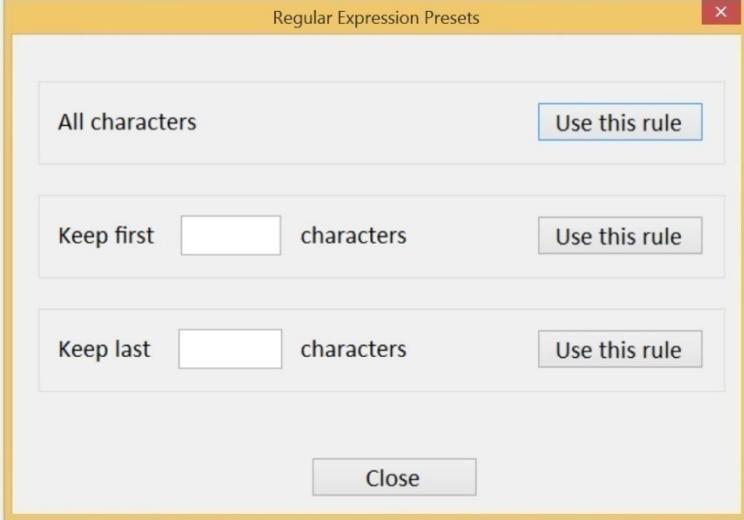
Item	Description
Prefix	User can type in this field to define the characters BEFORE the data scanned.
Suffix	User can type in this field to define the characters AFTER the data scanned.
Append Enter	The check box user can define to append an “Enter” which is followed by the characters.
Append TAB	The check box user can define to append an “TAB” which is followed by the characters.
Regex Filter	<p>Press on “Presets...” button, user can define how many characters to show after the data scanned.</p> 
Replace	User can define specific characters to be replaced with preferred characters automatically. When the characters defined in <b><u>Regex Substitution</u></b> is scanned, the data will be replaced with the one filled in <b><u>Replace with.</u></b>
Reset to default	User can remove all the setup and back to default mode.

## Software Development Kit (SDK)

For users following SDK for software porting, the scanned data can also be output with the format needed.



### NOTE:

User can download the SDK from Winmate Download center (the QR code in the cover page).

### 4.3.10.3 RFID Output Setting

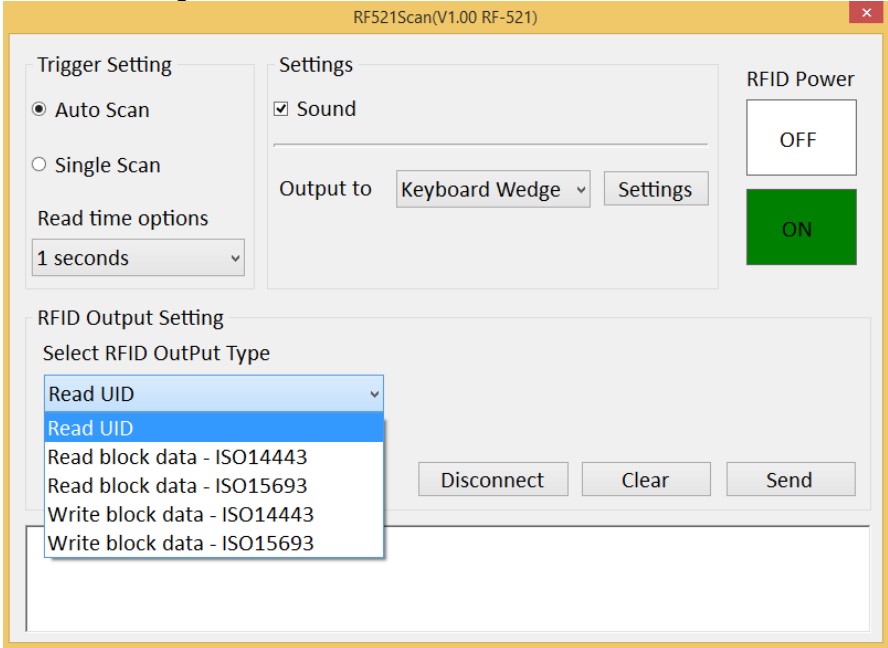
Item	Description
Select RFID Output Type	<p>The default setting for built-in HF RFID Reader is to <b>Read UID</b>. For some applications, user might need to read or write further block data; the drop-down menu under this section can do this change.</p> 
Disconnect	<p>User can tap on the <b>Disconnect</b> button to stop the connection with a built-in HF RFID reader. *To recover the connection, please turn off the module from setting UI and then turn on the module again.</p>

## 4.4 Check Battery Capacity

The M140TG/T Tablet supports hot-swap, hence the tablet doesn't need to be powered off to replace the main battery. To support hot-swap, there is an internal battery that is charged together with the main battery.

Perform the following to check the batteries capacities:

1. Power on the tablet, open the HotTab icon, click **Setting** to check the power level of the Internal battery.

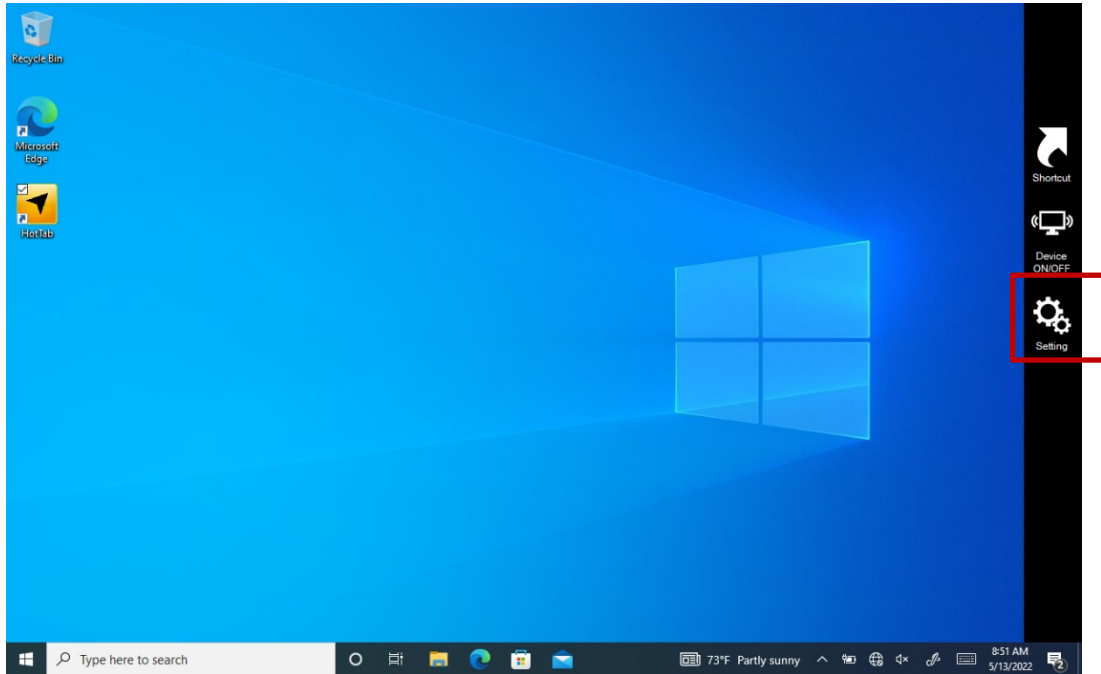

2. If the Internal battery level is “Low”, please charge the tablet with AC Power until the Internal battery level is “Medium” or “High”.
3. If the Internal battery level is at “Medium” or “High”, you can replace or hot-swapping the External battery.



### Important:

The system performance and display brightness will be reduced to the minimum to support hot-swap battery. Please save the data before activating this function.

4. Insert a new fully charged battery into the battery compartment.

- Open HotTab and click **Setting** to check Main battery level. If the battery level is displayed incorrect, check if the new removable battery is inserted properly.

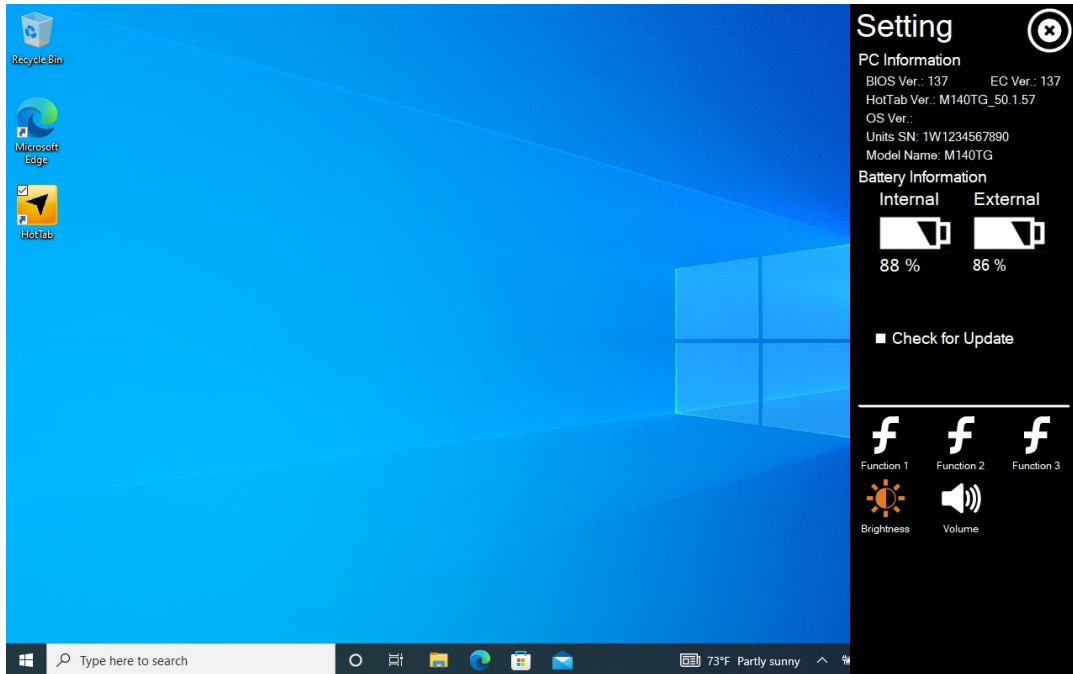

- If the battery level is correct, continue using the tablet.



**Caution** Charge the built-in back-up battery every two months to keep battery health and prevent possible issues from battery over-discharge.

**Attention** Chargez la batterie de secours intégrée tous les deux mois pour préserver la santé de la batterie et éviter d'éventuels problèmes de décharge excessive de la batterie.

## 4.5 Check for Update

To check for software update, perform the following procedure:

- Launch the Hottab Utility application.
- Tap on the **Setting** button.
- Check the **Check for Update**.

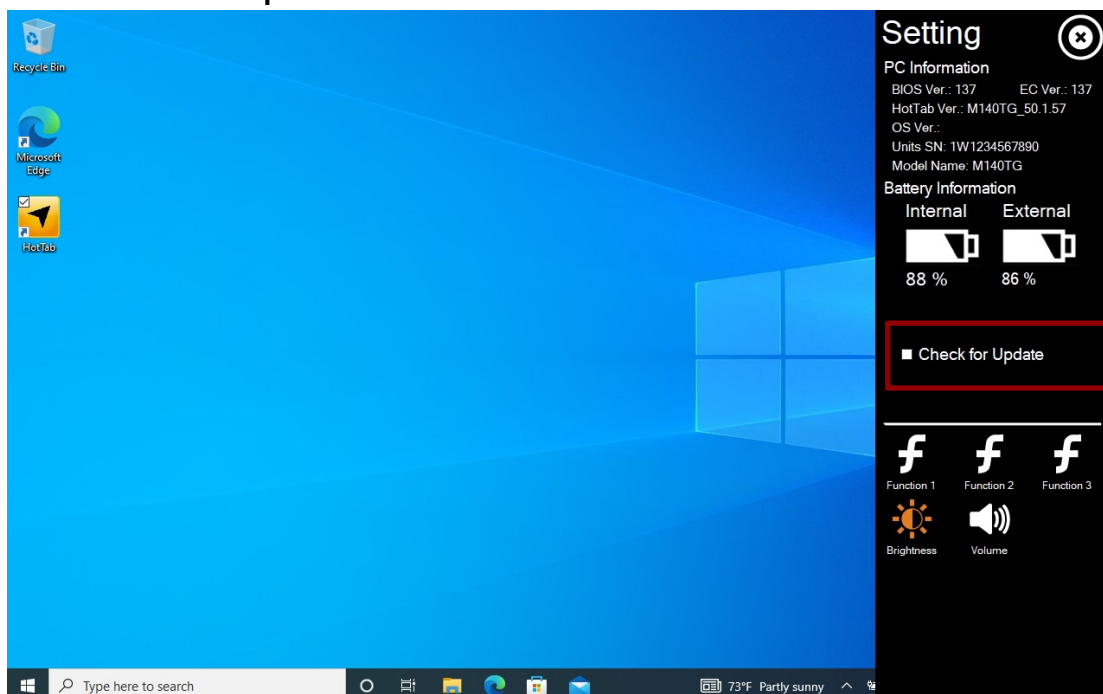

- The available update will show up. Click **Update** to download and install it.

## Chapter 5: Frequently Used Settings

### 5.1 Screen Resolution Scaling and Setting

The M140TG and M140TGT's 1920 x 1080 high-resolution display is perfect for viewing images, videos, or other applications. However, the Windows user interface (icons, buttons, and other user interface elements) may be too small to read and operate at the default Windows settings. By changing the display scaling or the display resolution setting of the device, you can adjust the size of the text and other items on the desktop for optimal viewing. Display scaling is the recommended method because it has the effect of adjusting user interface elements without moving away from the optimal resolution setting. This section will explain how you can adjust the built-in windows display scaling setting and resolution setting.



#### Note:

The Tablet computer is shipped with a display scaling set at **Larger - 150%**. We recommend the users set the scaling to this setting for optimal text and image viewing. Before proceeding to change the scaling option, make sure any opened document is saved and close also, all running applications are closed before proceeding to change the display scaling because this procedure requires users to log out of their account to apply display scaling change.

#### 5.1.1 Changing Display Scaling (Recommended)

Perform the following to change the display scaling setting:

1. Tap and hold anywhere on the desktop for 3 seconds and release to bring up the context menu, and select the **Display settings** option as shown below:

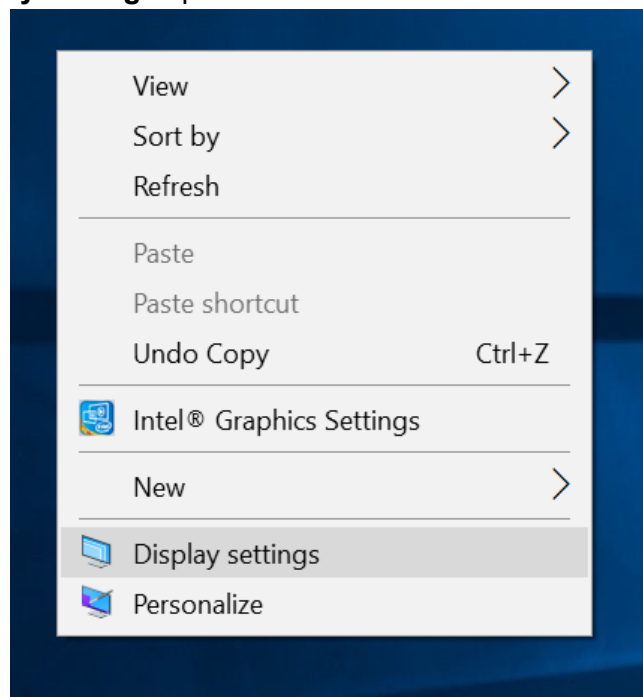

2. A "Display" Window will show up. Click on the drop-down option under the "**Scale and layout**" section and change the scaling option to "**150% (Recommended)**" or any other desired display scaling.

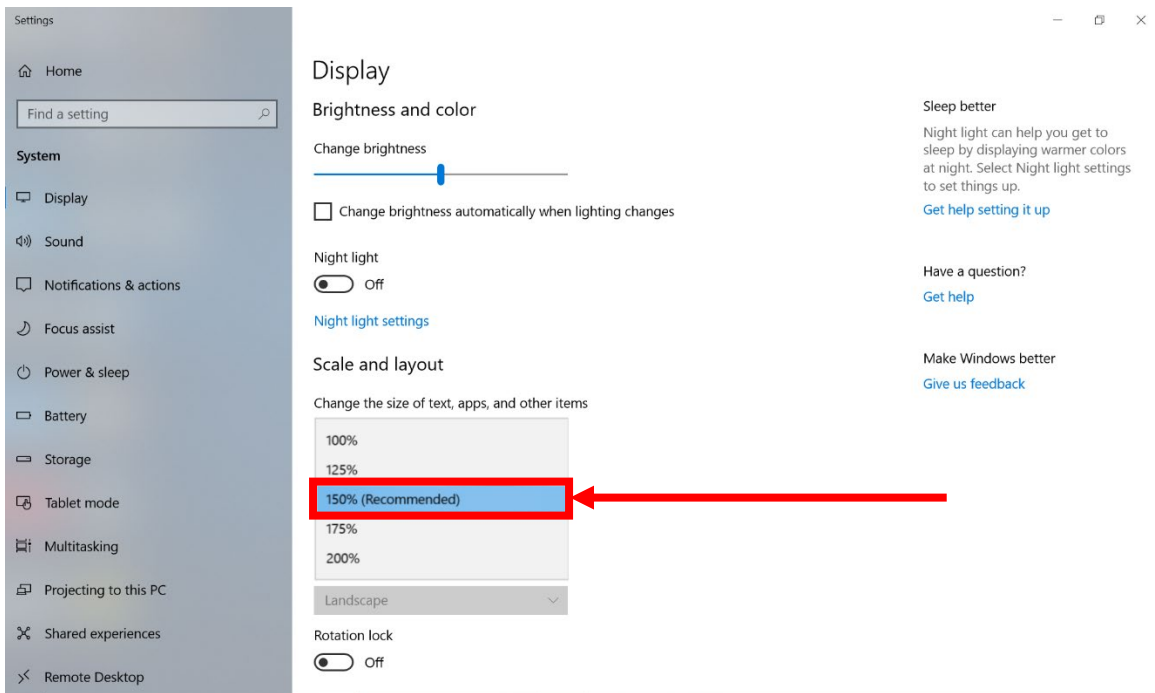

### 5.1.2 Changing Screen Resolution

Alternatively, instead of changing the display scaling setting, user may choose to change the overall resolution setting to make screen elements bigger.

1. Tap and hold anywhere on the desktop for 3 seconds and release to bring up the context menu, and select the **Display settings** option as shown below:

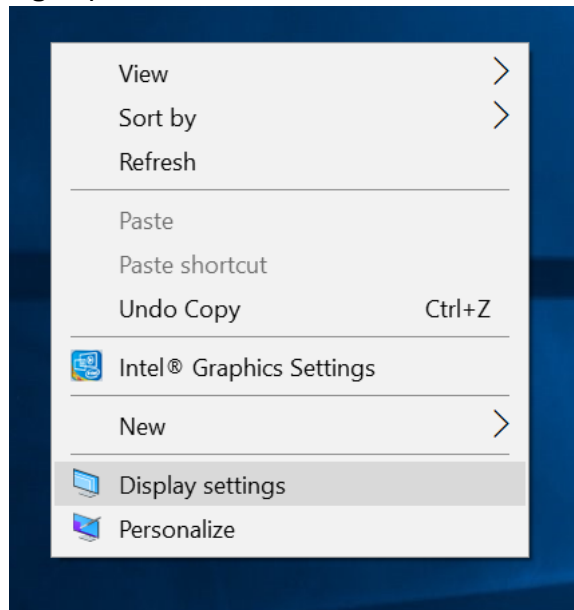

2. Click on the drop-down option next to **Resolution** and select the desired resolution by tapping on the scale:

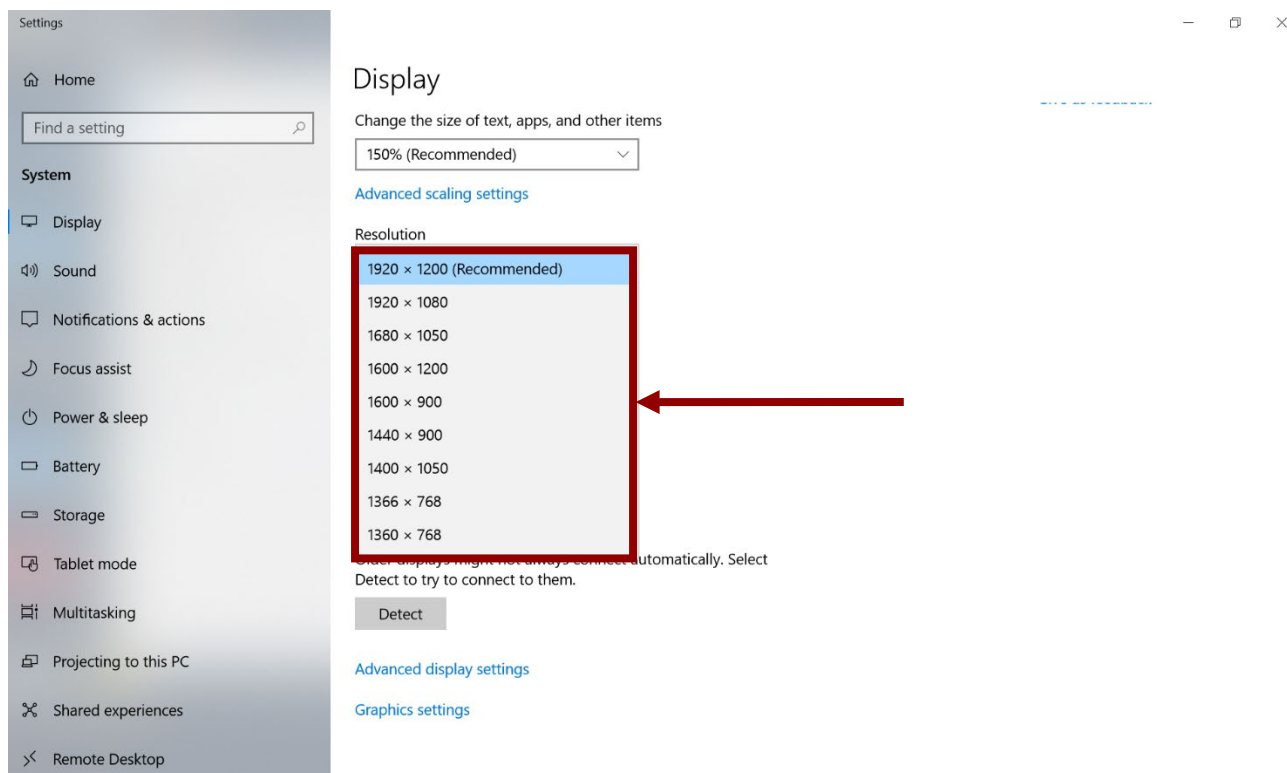

3. Hit **Apply**. A **Display Settings** prompt will show up to ask the user if the applied resolution is usable.
4. If the new resolution is the desired display setting hit **Keep changes** and continue to next step. If the new resolution is not desirable, hit **Revert** and select a different resolution to change to, and start again from step 2.
5. The user may now use the device with the new resolution setting.

## 5.2 Using Recovery Wizard to Restore Computer

M140TG/T Tablet Computer has a dedicated recovery partition stored on the tablet's hard drive to enable a quick one-key recovery process. This partition occupies about 11GB of the storage space and comes built-in to each M140TG/T Tablet Computer.



**Warning!** Before starting the recovery process, be sure to backup all user data, as all data will be lost after the recovery process.

**Avertissement!** Avant de démarrer le processus de récupération, assurez-vous de sauvegarder toutes les données utilisateur, car toutes les données seront perdues après le processus de récupération.

Follow the procedure below to enable quick one-key recovery:

1. Plug in the AC adapter into the tablet computer. Make sure the tablet computer stays plugged into the power source during the recovery process.
2. Power on the tablet computer, and when the boot screen shows up, press the **Fn1** button (Recovery Key) or press **F6** when using an external USB keyboard to initiate the Recovery Wizard.
3. The following screen shows the Recovery Wizard. Click on the **Recovery** button to continue.



4. A warning message about data loss will show up. Make sure data is backed up before recovery, and click on **Yes** to continue.

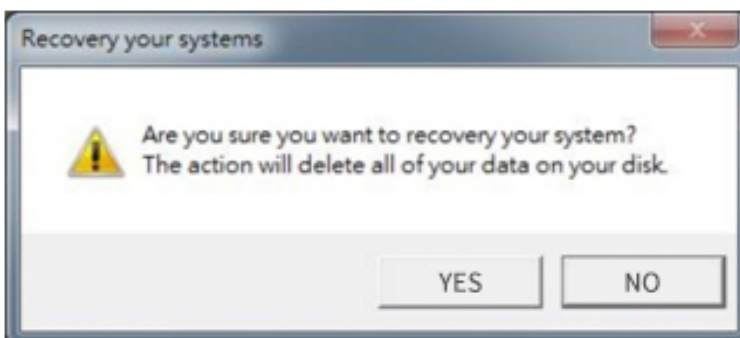



5. Wait till the recovery process to complete. During the recovery process, a command prompt will show up to indicate the percent of the recovery process.



6. After the recovery is complete, please press any key to continue, and the tablet computer will shut down automatically.

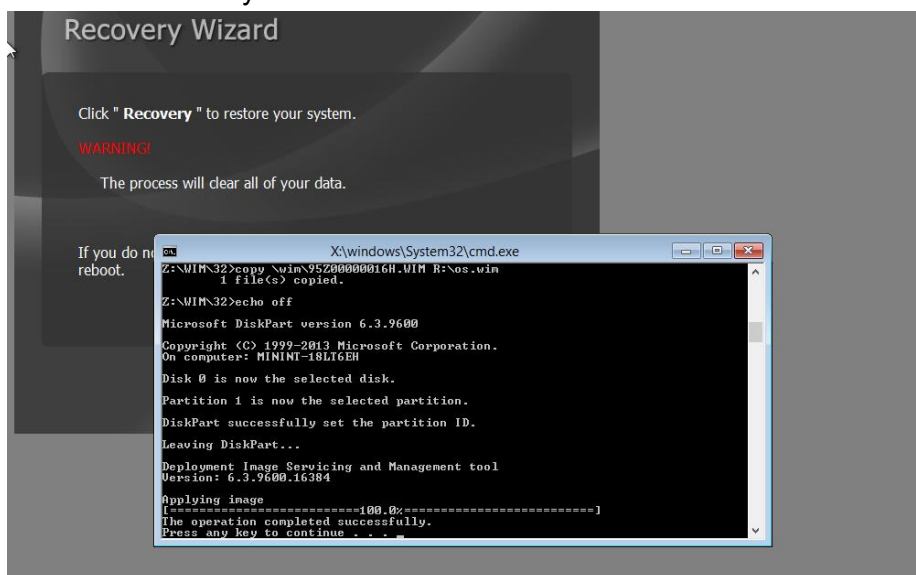

## 5.3 Docking Connector Pin Definition

M140TG/T tablet computer supports one 19-pin docking connector at the bottom side. The pin definition is listed in the following table.

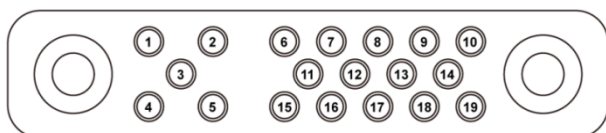

19 Pin Docking Connector			
Pin No.	Description	Pin No.	Description
1	RF_GND	11	NC
2	DOCK_DET#	12	NC
3	GPS ANT	13	GND
4	RF_GND	14	Power
5	RF_GND	15	USB+
6	NC	16	USB-
7	NC	17	GND
8	DETECT+	18	GND
9	Power	19	DETECT-
10	Power		

## 5.4 COM Port Definition

M140TG/T tablet computer uses Hottab utility for built-in peripherals control. All the COM port numbers have been defined in the OS image coming with the package.

COM Port	Device
COM 1	Reserved
COM 2	Reserved
COM 3	HF RFID (optional)
COM 4	BT Auto Pairing
COM 9	GPS (optional)
COM 11	RS232 at Docking (optional)

For some special applications, user might re-install OS and lose the COM port settings. To make sure the features work properly with Hottab utility, please follow the procedure below to re-define the COM port numbers:

1. Go to **Device Manager**, right-click on the COM number that need to be changed, and tap on **Properties** to open the setting page.

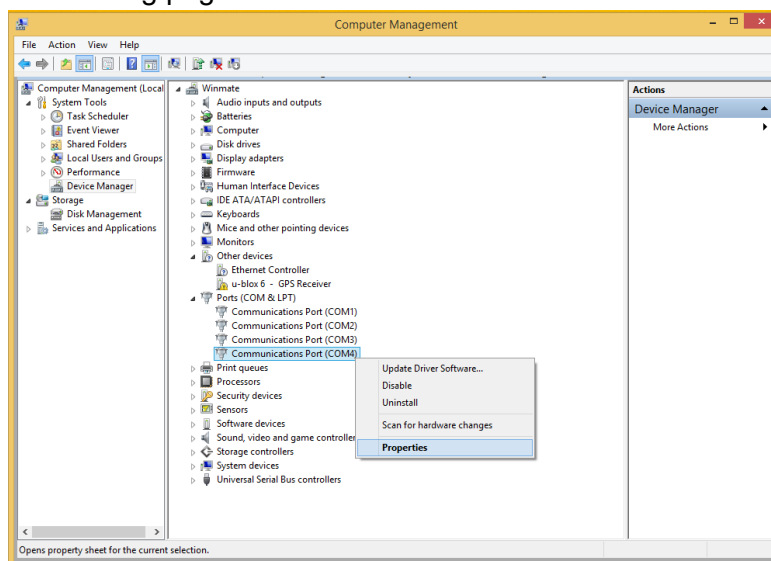

2. Tap on the **Port Setting** tab and click on **Advanced** button.

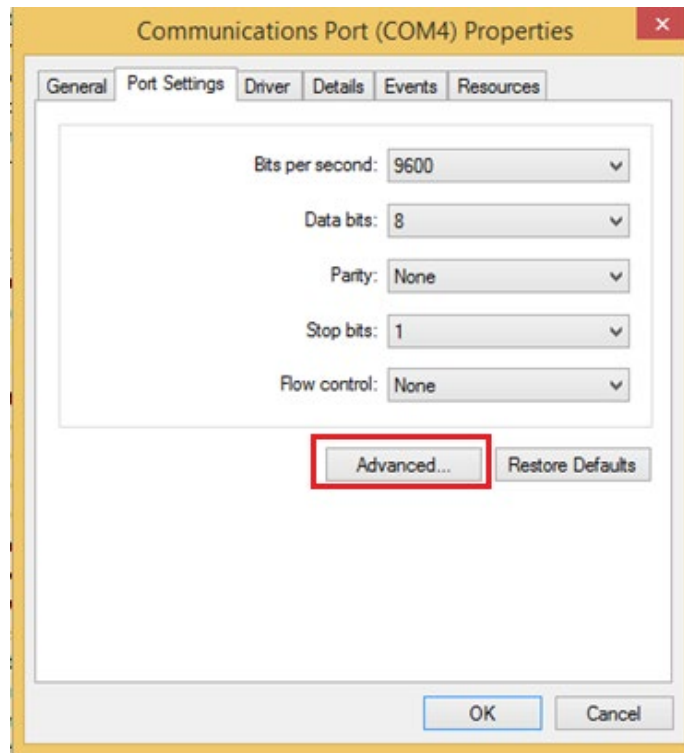

3. Tap on the drop-down list, choose the correct COM Port Number (refer to the COM Port Definition Table), and click **OK**.

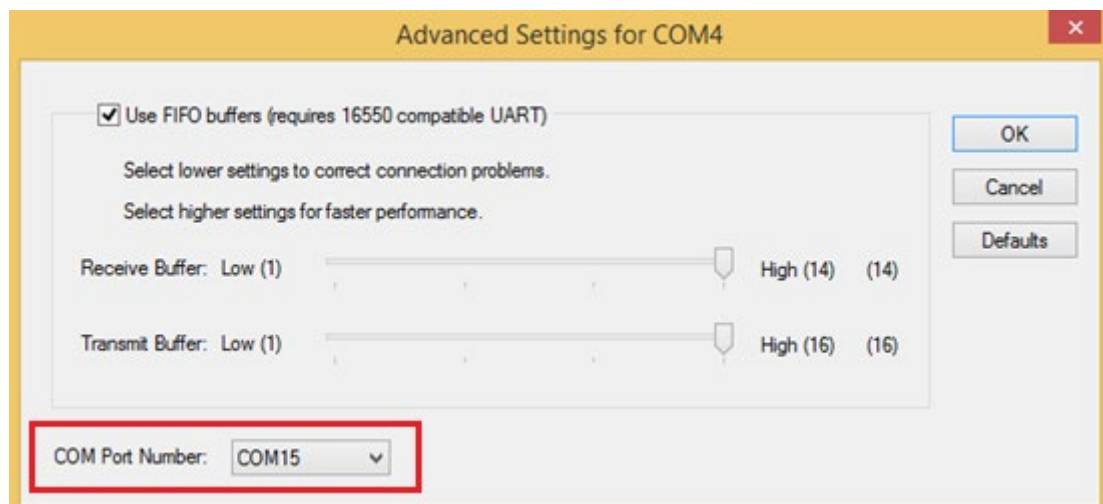

4. Double-check **Device Manager** to make sure the COM Port number has been re-defined successfully, and then restart the system.

## 5.5 Pairing with a Wireless BT Barcode Scanner

The computer is affixed with a Bluetooth MAC (Media Access Control) address barcode label that enables wireless BT Barcode Scanner to establish a BT connection quickly. It is encoded with leading characters to instruct the wireless BT barcode scanner to initial Bluetooth Serial Port Profile pairing request.

### 5.5.1 Setup Computer for BT Pairing

To start the pairing process, first, perform the following steps to ensure the computer is properly set up for pairing:

1. Locate the **BT** icon in the Notification Area

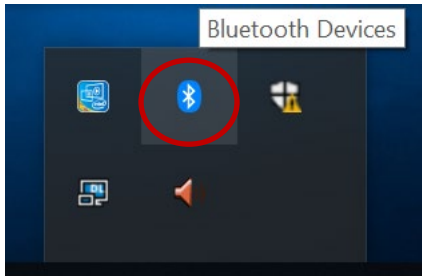

2. Bring up the Contextual Menu by performing a long press on the icon with touchscreen or right-click on the icon with a mouse and select **Open Settings**.

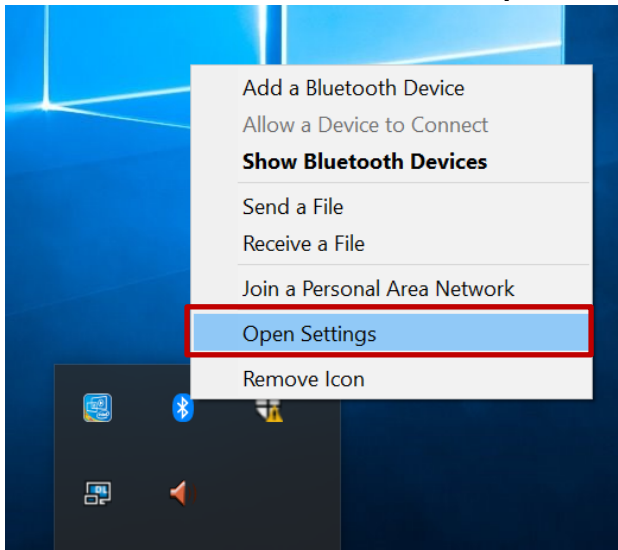

3. Once the **Bluetooth & other devices** Menu appears, click **More Bluetooth options** under Related settings section as shown below.

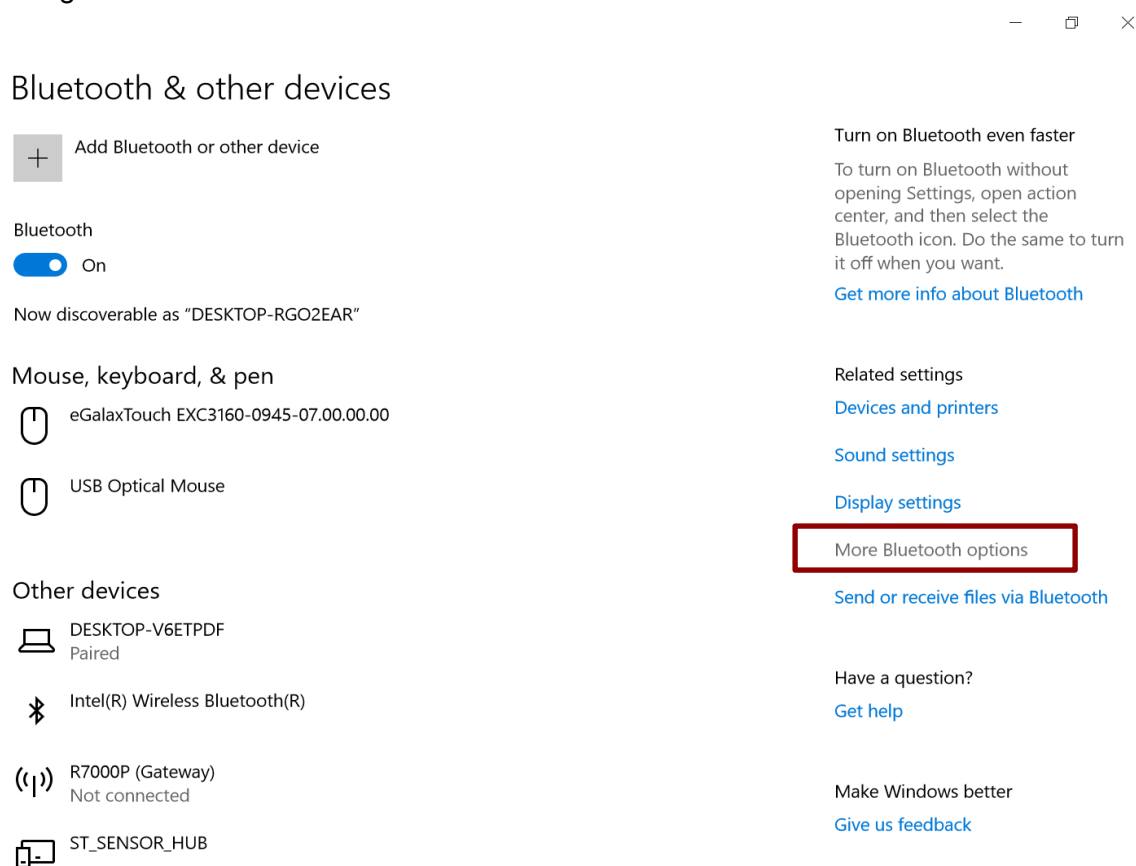

4. Go to **Options** tab, and make sure that in the Discovery section, the computer is set to **Allow Bluetooth devices to find this computer** as shown below:

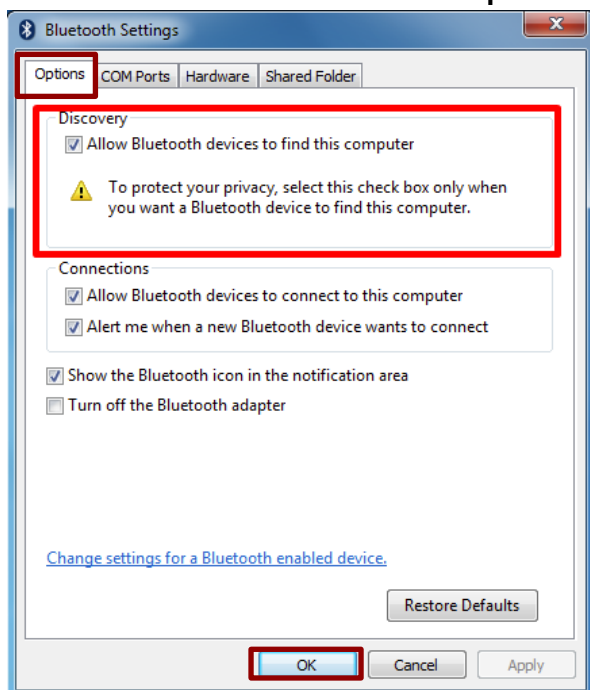

Click **OK** to continue.

5. In the **Bluetooth Settings** menu, go to **COM Ports** tab. COM port has to be setup for the wireless BT Barcode Scanner to communicate via the Bluetooth Serial Port Profile. Click on the **Add...** button.

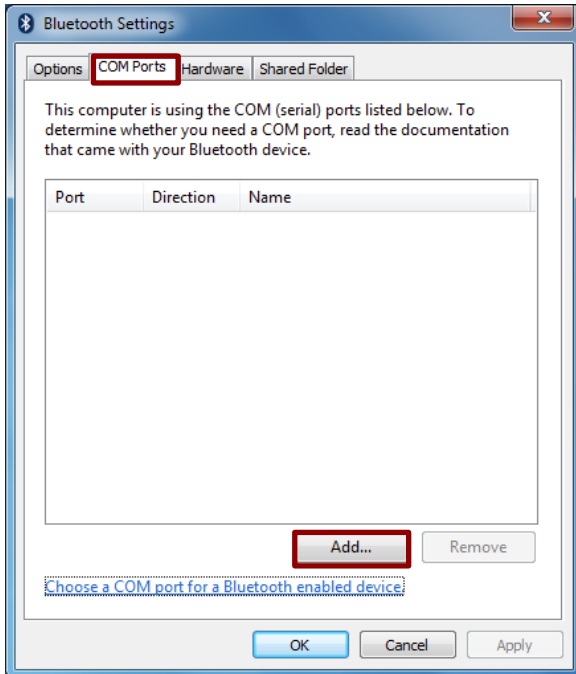

6. You are in **Add COM Port** window. Choose **Incoming (device initiates the connection)** and click **OK**.

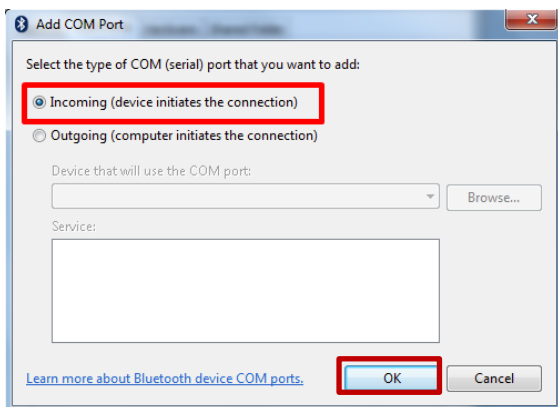

7. The computer will automatically assign COM Port to the BT connection. In the screenshot below, **COM4** is allocated. Click **OK** to continue.

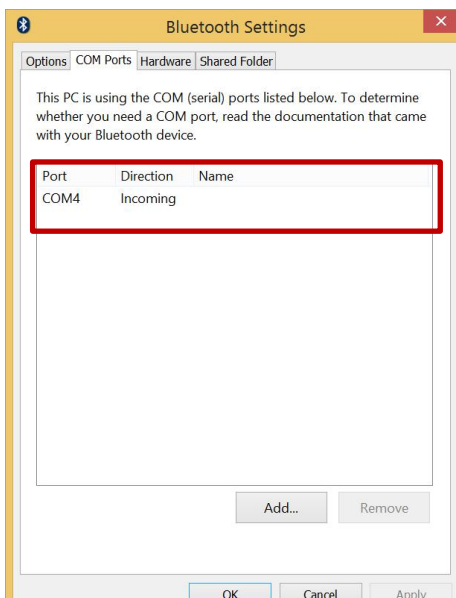

- Next, the user has to configure the application to accept the scanned data from the wireless BT Barcode Scanner. The application has to be configured to accept the same COM Port that has been assigned for the Bluetooth Serial Port Profile in the previous step.



**Important:**

Make sure the application stays open while pairing.

- Now the computer is ready to start the pairing process.

### 5.5.2 Set up the Barcode Scanner for BT Pairing



**Important:**

The wireless BT Barcode Scanner has to be configured as a Bluetooth Serial Port Profile Master device to establish connection via Bluetooth MAC address barcode label. Please refer to the User Guide for the wireless Bluetooth Barcode Scanner you are using for pairing for a more detailed instruction.

Now the Barcode Scanner is ready for the pairing process to start.

### 5.5.3 Perform BT Pairing

After you finish setting up both the Computer and Barcode Scanner, you are ready to start pairing.

- Open a program that is used for pairing.
- Perform scanning procedures. A BT notification window pop-up on the right-hand side of the desktop. Left-click on the mouse to enter Add a device menu.
- Locate the **Bluetooth** icon  in the Notification Area.

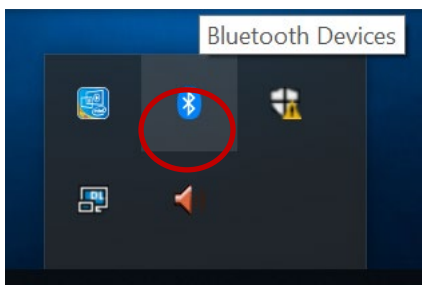

- Click **Add Bluetooth Device**.

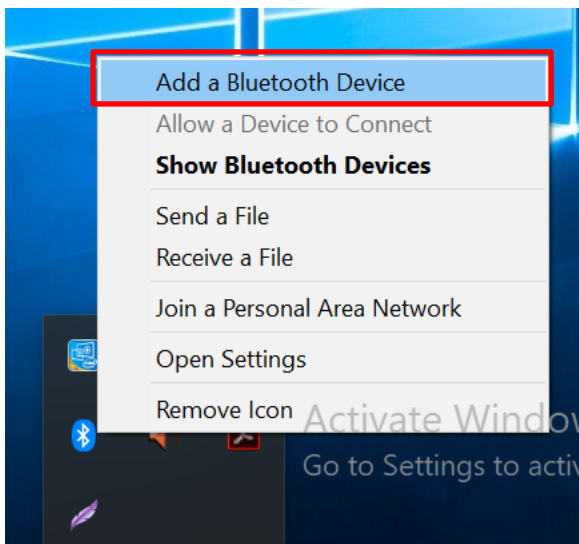

5. In **Add a Bluetooth Device** window, click **Next** to connect the Barcode Scanner to the Computer.

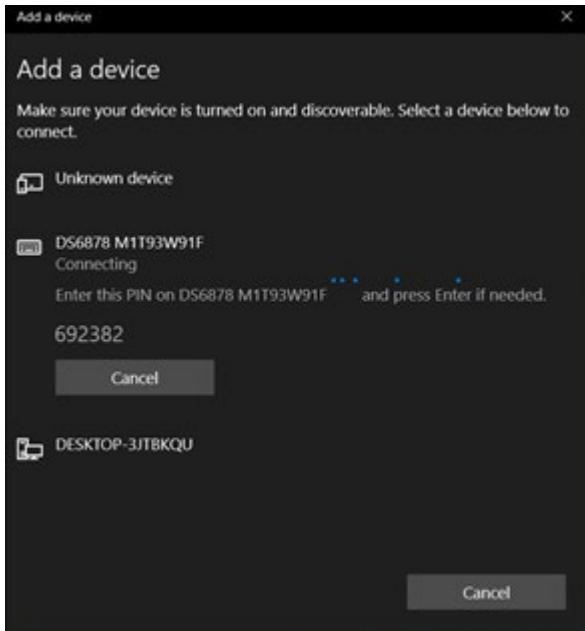

In order to ensure that Bluetooth Device is successfully paired to the computer, follow the steps below:

1. Locate the **Bluetooth** icon in the Notification Area. Select **Show Bluetooth Devices**.

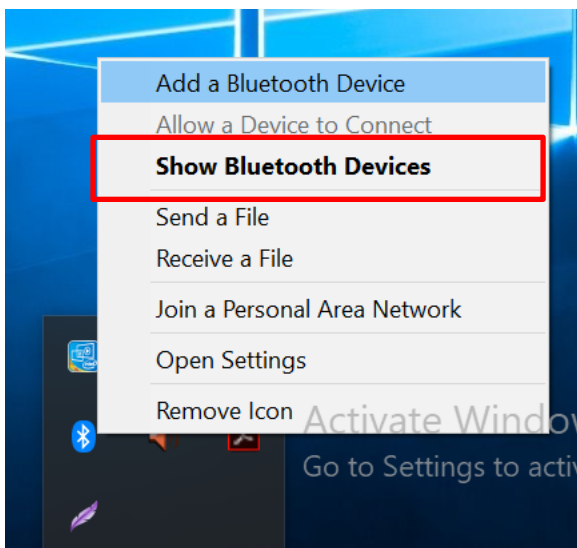

You can access this menu in the Control Panel:

Windows  → Control Panel → Devices and Printers → Bluetooth Devices

2. Make sure your device is connected to the computer.



## Chapter 6: Troubleshooting

### 6.1 Basic Troubleshooting

Problem	Solution
The removable battery is not charging.	<ul style="list-style-type: none"> <li>• Make sure the AC adapter is properly connected and that the removable battery is properly inserted.</li> </ul>
Nothing appears on the screen.	<ul style="list-style-type: none"> <li>• The tablet computer may be in sleep mode. Press the power button to wake up the display.</li> <li>• The brightness level may be too low. Increase brightness.</li> </ul>
The screen suddenly turns blank and the power indicator goes off.	<ul style="list-style-type: none"> <li>• Make sure that the LED indicator is not powered off in Hottab.</li> <li>• Make sure the AC adapter is properly connected.</li> <li>• If running on battery power, the battery may be depleted, charge the battery.</li> </ul>
Wireless LAN signal quality is poor.	<ul style="list-style-type: none"> <li>• The tablet computer may be out of range. Move the tablet computer closer to the access point or another wireless LAN device associated with it.</li> <li>• Check if your surroundings have interferences, such as microwave ovens, cordless phones. Move the tablet computer away from objects causing interference.</li> </ul>
I cannot connect to another wireless LAN device.	<ul style="list-style-type: none"> <li>• Make sure that the wireless LAN feature is powered on.</li> <li>• Make sure that the SSID setting is the same for every wireless LAN device in the network.</li> <li>• Restart the tablet computer</li> <li>• Make sure the IP address or subnet mask setting is correct.</li> </ul>
I cannot connect to another device with BT.	<ul style="list-style-type: none"> <li>• Ensure that both devices have BT powered on (Check Hottab to see if BT is powered on).</li> <li>• Ensure that the distance between the two devices is within 10 meters and that there are no walls or large obstructions between the devices.</li> <li>• Make sure both devices are powered on and configured to be discoverable.</li> <li>• Make sure that both devices are compatible.</li> </ul>
The GPS application cannot find my location.	<ul style="list-style-type: none"> <li>• Make sure that GPS is powered on in Hottab.</li> <li>• Make sure the GPS receiver and the location sensor are enabled in Control Panel.</li> <li>• The tablet computer may be out of coverage area. Move your tablet computer outdoors or closer to a window.</li> <li>• Check if your surroundings have interferences, such as microwave ovens, cordless phones. Move the tablet computer away from objects causing interference.</li> </ul>

Problem	Solution
<b>No sound is produced.</b>	<ul style="list-style-type: none"> <li>• Adjust the volume of the tablet computer by pressing on the volume rocker.</li> <li>• If using an external audio device, make sure that the cable is properly connected.</li> </ul>
<b>I cannot project the tablet computer display to another monitor through docking.</b>	<ul style="list-style-type: none"> <li>• Make sure the VGA driver is installed.</li> <li>• Make sure the output setting selected is correct.</li> </ul>
<b>The barcode scanner does not emit laser beam and does not seem to work.</b>	<ul style="list-style-type: none"> <li>• Make sure the Barcode scanner device is enabled in Hottab utility.</li> </ul>
<b>Barcode Scanner emits laser beam but does not read barcode presented to it.</b>	<ul style="list-style-type: none"> <li>• Adjust the distance between the barcode scanner of the device and the barcode being scanned.</li> <li>• Make sure the barcode code type is enabled in the tablet. To enable/disable a specific barcode code type, go through the "Barcode Scanner Configuration" section.</li> </ul>
<b>I am having a GPS accuracy issue</b>	<ul style="list-style-type: none"> <li>• When utilizing the GPS function, we recommend disabling the Barcode Reader in Hottab to reduce interference.</li> </ul>
<b>Battery leaking or swollen</b>	<ul style="list-style-type: none"> <li>• The lithium battery used in this tablet may swell after being charged/ discharged many times, but there is no problem regarding safety.</li> <li>• Continued use in such a state may result in the battery getting jammed, so please stop using the battery, and purchase a new one.</li> </ul>

## Appendix

### Appendix A: Product Specifications

Model Name	M140TG / M140TGT	
Display	Size	14 inches
	Resolution	1920 x 1080
	Brightness	700 nits
	Contrast Ratio	800:1
	Viewing Angle	85,85,85,85
	Touch	Projected Capacitive Multi-Touch
	Bonding	Optical Bonding for Sunlight Viewability
System Specification	Processor	Intel Core i51135G7 @ 2.40GHz, up to 4.20GHz
	System Memory	4GB DDR4 SDRAM (up to 32 GB)
	Storage	128GB SSD (optional up to 2TB)
	Operating System	Windows 10 IoT Enterprise (64 bit)
	WLAN	Support
	BT	Support
	GNSS	GPS, GLONASS (Optional)
	WWAN	4G LTE (Optional)
	RFID	HF RFID (Optional)
Camera	Smart Card Reader	Comply with ISO7816-1.2.3 T=1 and T=Ø protocol (Only M140TGT)
	Front Camera	2MP Front Camera
	Rear Camera	8MP Rear Camera with auto-focus and LED light
Mechanical	Dimensions	341.91 x 224.67 x 25.4 mm
	Weight	1.7 Kg
	Cooling System	Fan design
I/O Ports	USB Port	2 x USB 3.0 (Type A), 1 x USB 3.0 (Type C)
	Video	1 x Micro HDMI (Optional)
	Audio	1 x Headphone Combo Jack Integrated Digital Mic with Noise Cancellation Integrated Stereo Speaker
	SD Card Slot	1 x Micro SDXC slot
	SIM Card Slot	1 x Nano SIM card slot
	Indicator	4 x LED Indicator for Power, Battery, SSD, RF status
	Docking Connector	1 x 19-pin docking connector
	LAN	1 x RJ45-10/100/1000 Mbps LAN
Environment	Operating Humidity	10% to 90% RH, non-condensing
	Operating Temperature	-20°C to 60°C (AC mode), -10°C to 50°C (Battery mode)
	Storage Temperature	-20°C to 60°C (-4°F to 140°F)
	Shock	MIL-STD-810H Method 516.8 Procedure I
	Vibration	MIL-STD-810H Method 514.8 Procedure I
	Drop	MIL-STD-810H Method 516.8, 4 ft.
	IP Rating	IP65 certified, dustproof and waterproof
Security Function	SOTI MobiControl	SOTI MobiControl Compliance
	Trusted Platform Module (TPM) 2.0	Support

Model Name	M140TG / M140TGT	
	Kensington Lock	Support
<b>Control</b>	Button	1 x Power 3 x Programmable function Keys
<b>Power</b>	Internal Battery	10.8V typ. 2400 mAh Li-Ion Battery
	Hot swappable Battery	11.4V, typ. 3500 mAh Li-Ion Re-chargeable Battery (3S1P)
	Battery Operating Time	Standard Battery: 8 hours
	Power Rating	19V DC
	Adapter	100-240V, 50-60 Hz / 19V DC
<b>Accessory</b>	Standard	Adapter and Power Cord Standard Battery
	Optional	Kickstand Vehicle Charger Battery Charger Shoulder Strap Carry Bag Stylus
<b>Certification</b>	Certification	CE, FCC

**NOTE:**

1. Accessories and Integrated Options may vary depending on your configuration. The product shown in this document is a standard model. For diagrams that contain customized or optional I/O, please contact the Winmate Sales Team for more information.
2. All specifications are subject to change without prior notice.









---

Winmate Inc.  
9F, No.111-6, Shing-De Rd., San-Chung District,  
New Taipei City 24158, Taiwan, R.O.C  
[www.winmate.com](http://www.winmate.com)

Copyright © 2022 Winmate Inc. All rights reserved.

