

PT Series Multi-Touch Chassis HMI

Intel® Celeron® N6211 (1.5M Cache, up to 3.0GHz)



Model No. R15IE3S-PTC3
W15IE3S-PTA3
W22IE3S-PTA3
W24IE3S-PTA2

User Guide

Preface	3
Chapter 1: Introduction	7
1.1 Features	7
1.2 Package Contents	7
1.3 Mechanical Dimensions	8
1.4 Connector Description	10
1.5 Physical Buttons and LED Indicators	10
Chapter 2: Installation	12
2.1 Wiring Requirements	12
2.2 VESA Mounting	13
2.3 Turning On	14
2.4 Connecting Peripherals	15
2.4.1 Power Connector	15
2.4.2 Ethernet Connector	15
2.4.3 Serial Port Connector	16
2.4.4 USB Connector	16
2.4.5 HDMI Connector	17
2.5 Speaker	18
Chapter 3: Operating the Device	19
3.1 Introduction	19
3.2 How to Enable Watchdog	20
3.3 Using Recovery Wizard to Restore Computer	21
Chapter 4: BIOS Setup	22
This chapter describes the different settings available in the INSYDE BIOS that comes with the board. This chapter offers information on the Award BIOS installation utility.	22
4.1 How and When to Use BIOS Setup	22
4.2 BIOS Functions	22
4.1 How and When to Use BIOS Setup	22
4.2 BIOS Functions	24
4.2.1 Main Menu	24
4.2.2 Advanced Settings	25
4.2.3 Chipset Menu	35
4.2.4 Security Menu	39
4.2.5 Boot Menu	41
4.2.6 Exit Menu	42
Appendix	43
Appendix A: Product Specifications	43
Appendix B: Cleaning the LCD Monitor	46
Appendix C: Technical Support	46

Preface

FCC Statement

This device complies with part 15 FCC rules.



Operation is subject to the following two conditions:

- This device may not cause harmful interference.
- This device must accept any interference received including interference that may cause undesired operation.

This equipment has been tested and found to comply with the limits for a class "A" digital device, pursuant to part 15 of the FCC rules. These limits are designed to provide reasonable protection against harmful interference when the equipment is operated in a commercial environment. This equipment generates, uses, and can radiate radio frequency energy and, if not installed and used in accordance with the instruction manual, may cause harmful interference to radio communications.

Operation of this equipment in a residential area is likely to cause harmful interference in which case the user will be required to correct the interference at his own expense.

European Union



Electromagnetic Compatibility Directive (2014/30/EU)

- EN55024: 2010/ A1: 2015
 - IEC61000-4-2: 2009
 - IEC61000-4-3: 2006+A1: 2007+A2: 2010
 - IEC61000-4-4: 2012
 - IEC61000-4-5: 2014
 - IEC61000-4-6: 2014
 - IEC61000-4-8: 2010
 - IEC61000-4-11: 2004
- EN55032: 2012/AC:2013
- EN61000-3-2:2014
- EN61000-3-3:2013

Low Voltage Directive (2014/35/EU)

- EN 60950-1:2006/A11:2009/A1:2010/A12:2011/ A2:2013

This equipment is in conformity with the requirement of the following EU legislations and harmonized standards. Product also complies with the Council directions.

Copyright Notice

No part of this document may be reproduced, copied, translated, or transmitted in any form or by any means, electronic or mechanical, for any purpose, without the prior written permission of the original manufacturer.

Trademark Acknowledgement

Brand and product names are trademarks or registered trademarks of their respective owners.

Disclaimer

We reserve the right to make changes, without notice, to any product, including circuits and/or software described or contained in this manual in order to improve design and/or performance. We assume no responsibility or liability for the use of the described product(s) conveys no license or title under any patent, copyright, or masks work rights to these products, and make no representations or warranties that these products are free from patent, copyright, or mask work right infringement, unless otherwise specified. Applications that are described in this manual are for illustration purposes only. We make no representation or guarantee that such application will be suitable for the specified use without further testing or modification.

Warranty

Our warranty guarantees that each of its products will be free from material and workmanship defects for a period of one year from the invoice date. If the customer discovers a defect, we will, at his/her option, repair or replace the defective product at no charge to the customer, provide it is returned during the warranty period of one year, with transportation charges prepaid. The returned product must be properly packaged in its original packaging to obtain warranty service. If the serial number and the product shipping data differ by over 30 days, the in-warranty service will be made according to the shipping date. In the serial numbers the third and fourth two digits give the year of manufacture, and the fifth digit means the month (e. g., with A for October, B for November and C for December).

For example, the serial number 1W16Axxxxxxx means October of year 2016.

Customer Service

We provide a service guide for any problem by the following steps: First, visit the website of our distributor to find the update information about the product. Second, contact with your distributor, sales representative, or our customer service center for technical support if you need additional assistance.

Advisory Conventions

Four types of advisories are used throughout the user manual to provide helpful information or to alert you to the potential for hardware damage or personal injury. These are Notes, Important, Cautions, and Warnings. The following is an example of each type of advisory.



Note:

A note is used to emphasize helpful information



Important:

An important note indicates information that is important for you to know.



Caution/ Attention

A Caution alert indicates potential damage to hardware and explains how to avoid the potential problem.

Unalerted' attention indique un dommage possible à l'équipement et explique comment éviter le problem potentiel.



Warning!/ Avertissement!

An Electrical Shock Warning indicates the potential harm from electrical hazards and how to avoid the potential problem.

Un Avertissement de Choc Électrique indique le potentiel de choc sur des emplacements électriques et comment éviter ces problèmes.

Safety Information



Warning!/ Avertissement!

Always completely disconnect the power cord from your chassis whenever you work with the hardware. Do not make connections while the power is on. Sensitive electronic components can be damaged by sudden power surges. Only experienced electronics personnel should open the PC chassis.

Toujours débrancher le cordon d'alimentation du chassis lorsque vous travaillez sur celui-ci. Ne pas brancher de connections lorsque l'alimentation est présente. Des composantes électroniques sensibles peuvent être endommagées par des sauts d'alimentation. Seulement du personnel expérimenté devrait ouvrir ces chassis.



Caution/ Attention

Always ground yourself to remove any static charge before touching the CPU card. Modern electronic devices are very sensitive to static electric charges. As a safety precaution, use a grounding wrist strap at all times. Place all electronic components in a static-dissipative surface or static-shielded bag when they are not in the chassis.

Toujours verifier votre mise à la terre afin d'éliminer toute charge statique avant de toucher la carte CPU. Les équipements électroniques modernes sont très sensibles aux décharges d'électricité statique. Toujours utiliser un bracelet de mise à la terre comme précaution. Placer toutes les composantes électroniques sur une surface conçue pour dissiper les charge, ou dans un sac anti-statique lorsqu'elles ne sont pas dans le chassis.



RoHS Declaration

According to the European Union issued Directive 2011/65/EU on the restriction of the use of certain hazardous substances in electrical and electronic equipment (RoHS 2.0). Winmate Inc.'s guaranty is able to meet the current regulations and customer requirements in respect of the application of cadmium, lead, mercury, hexavalent chromium, PBBs, PBDEs in its product.

Chapter 1: Introduction

The PT Series HMI runs on low power consuming Intel® Celeron® N2930 processor. Multiple I/O interface includes USB 2.0, one LAN port, serial interface RS-232/422/485 for machine-to-machine communications, USB 2.0 and USB 3.0 for data transfer. Chassis housing is protected with IP65 standard against water and dust from the front. The PT Series HMI is an ultimate solution for Point-of-Sale (POS) applications.

1.1 Features

- 15~23.8" screen with P-Cap touch
- Low power consumption with Intel® Celeron® N6211 (1.5M Cache, up to 3.0GHz)
- Fanless cooling system and ultra-low power consumption
- Front IP65 for protection against water and dust
- A true flat, easy-to-clean front surface with edge-to-edge design

1.2 Package Contents

Carefully remove the box and unpack your device. Please check if all the items listed below are inside your package. If any of these items are missing or damaged contact us immediately.

Standard factory shipment list:

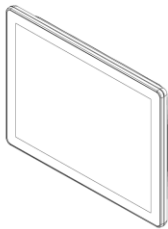

- **HMI Device**

Varies by product specifications



- **Quick Start Guide (Hardcopy)**

Part No. 91521110110N

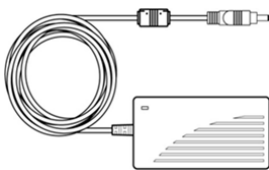

- **AC Adapter (12V/ 50W)**

Part No. 922D050W12VA

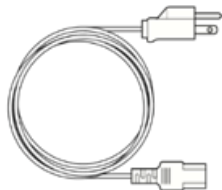

- **Power Cord**

Varies by country

1.3 Mechanical Dimensions

15-inch, R15IE3S-PTC3

Unit: mm

Dimensions: 352.5x276.7x45

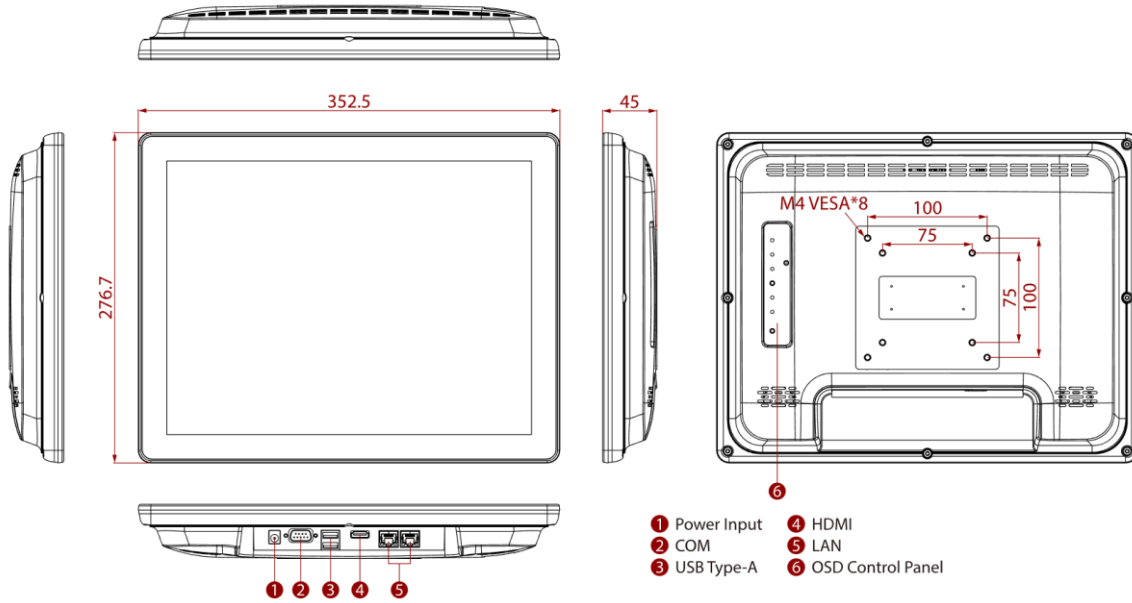

15.6-inch, W15IE3S-PTC3

Unit: mm

Dimensions: 352.5x276.7x45

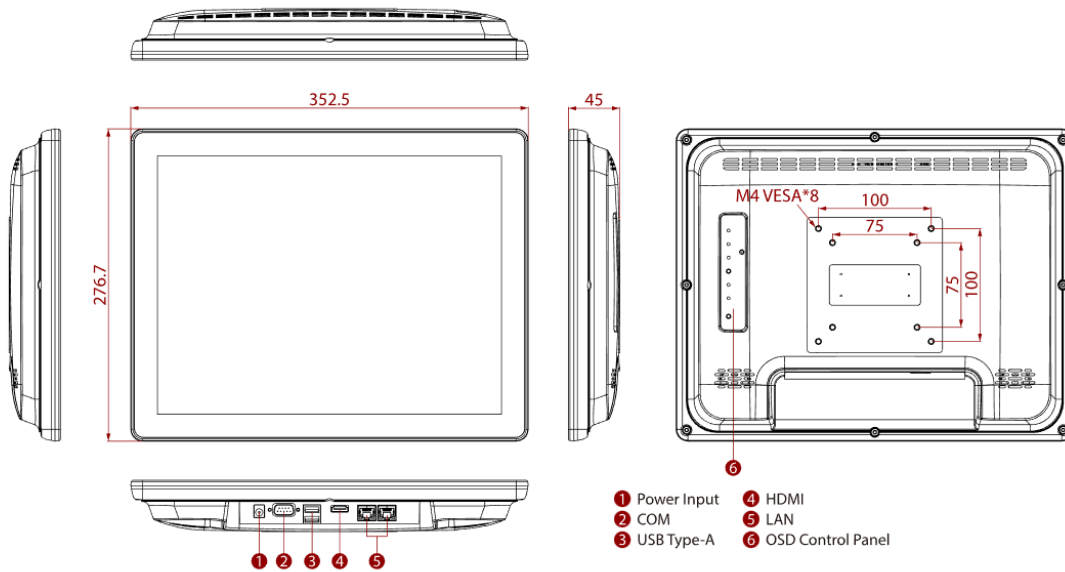

21.5-inch W22IE3S-PTA3

Unit: mm

Dimensions: 530 x 322 x 56

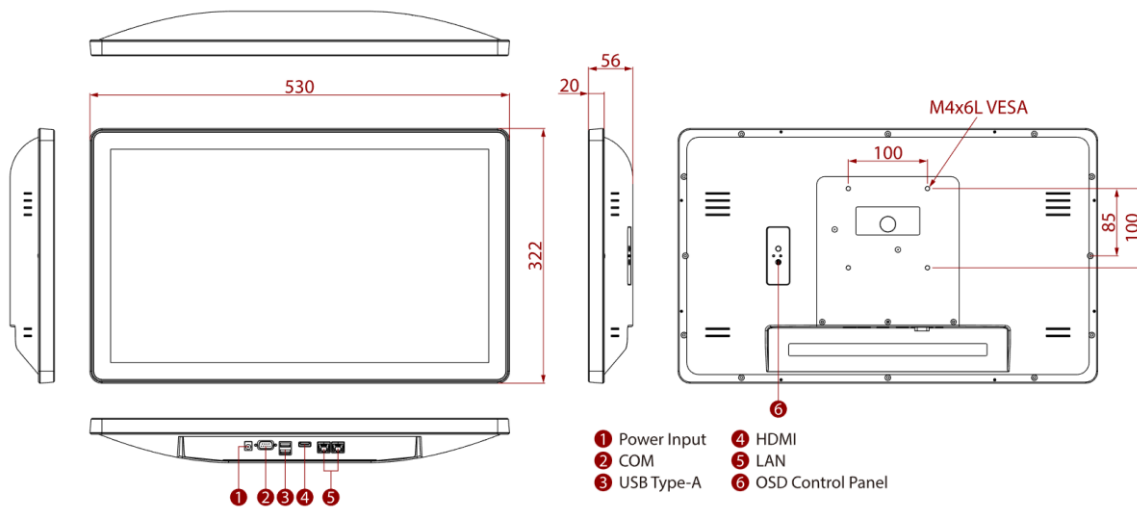

23.8-inch W24IE3S-PTA2

Unit: mm

Dimensions: 588 x 358 x 60

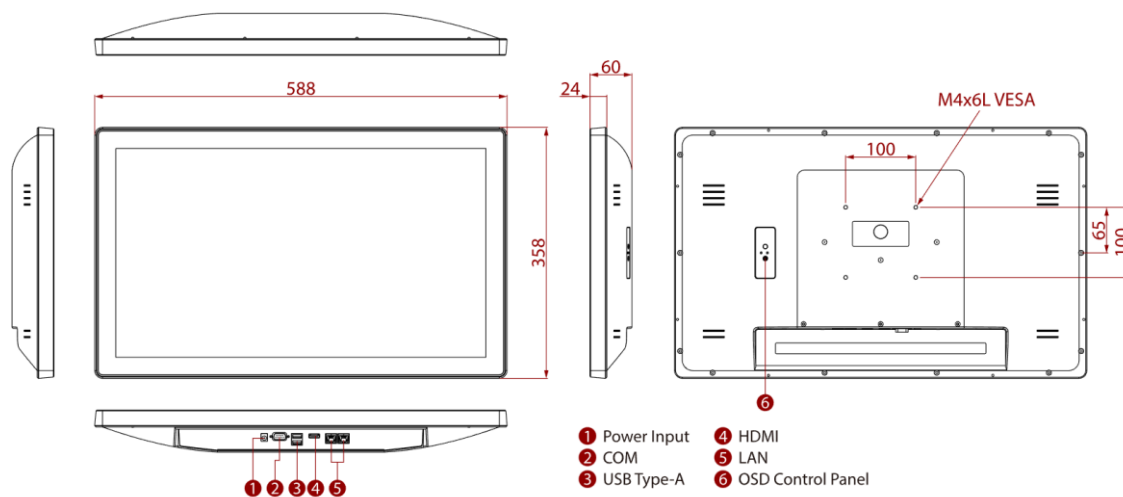

1.4 Connector Description





Terminal interfaces are located on the bottom side of the HMI device.



Note:

Notice that input and output connectors vary by product size and specifications.

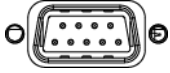

Terminal interfaces description:

Item	Description
	Power Jack – Provides power to the PANEL PC, accepts 12V DC power input.
	HDMI - Transmits and protects copyrighted digital video and audio. Example: An HD tuner to an HD ready TV
	RS-232/422/485 – Connects external devices to HMI device. Example: A barcode reader or scanner to HMI device.
	USB 3.2 Connects USB compatible devices to HMI device. Example: A printer to HMI device.
	RJ45 – Connects HMI device to Ethernet network.

1.5 Physical Buttons and LED Indicators

PT Series HMI has Power and Reset physical buttons located on the back side.

For R15IE3S-PTC3, W15IE3S-PTA3

Item	Description
	Power Button – Press to turn on/ off the device.
	Reset Button – Press to forcible shut down and reset the device.





PT Series HMI has Power LED indicator located on the back side.

Item	Description
	Power LED Indicator – Lights up when HMI device is powered on.

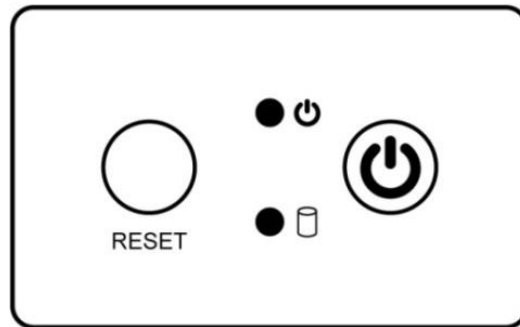
Physical buttons and LED indicators located on the rear side of the Panel PC.

For W22IE3S-PTA3, W24IE3S-PTA2



Physical Buttons		
Icon	Button	Description
	Reset	Press to reset the system.
	Power On/ Off	Press to power on or power off the device.
LED Indicators		
LED Type	Status	Description
	On	Power is on.
	Off	Power is off.
	Blinking	Storage activity (Data is being read or written).
	Off	System is idle.

Chapter 2: Installation

2.1 Wiring Requirements

The following common safety precautions should be observed before installing any electronic device:

- Strive to use separate, non-intersecting paths to route power and networking wires. If power wiring and device wiring paths must cross make sure the wires are perpendicular at the intersection point.
- Keep the wires separated according to interface. The rule of thumb is that wiring that shares similar electrical characteristics may be bundled together.
- Do not bundle input wiring with output wiring. Keep them separate.
- When necessary, it is strongly advised that you label wiring to all devices in the system.



Caution

- Do not run signal or communication wiring and power wiring in the same conduit. To avoid interference, wires with different signal characteristics (i.e., different interfaces) should be routed separately.
- Be sure to disconnect the power cord before installing and/or wiring your device.
- Verify the maximum possible current for each wire gauge, especially for the power cords. Observe all electrical codes dictating the maximum current allowable for each wire gauge.
- If the current goes above the maximum ratings, the wiring could overheat, causing serious damage to your equipment.
- Be careful when handling the unit. When the unit is plugged in, the internal components generate a lot of heat which may leave the outer casing too hot to touch.

2.2 VESA Mounting

This device supports VESA Mounting and provides various types of mounting options to fit any industrial use.

Size	VESA Plate	Screw Size
15"	75x75 mm, 100x100 mm	M4 x 5
15.6"	75x75 mm, 100x100 mm, 200 x 100 mm	M4 x 8
21.5"	100x100mm	M3 x 5
23.8"	100x100mm	M3 x 5

Installation Instruction

Use Philips M4x5 screws to fix the desk stand to VESA holes on the back cover of the device.

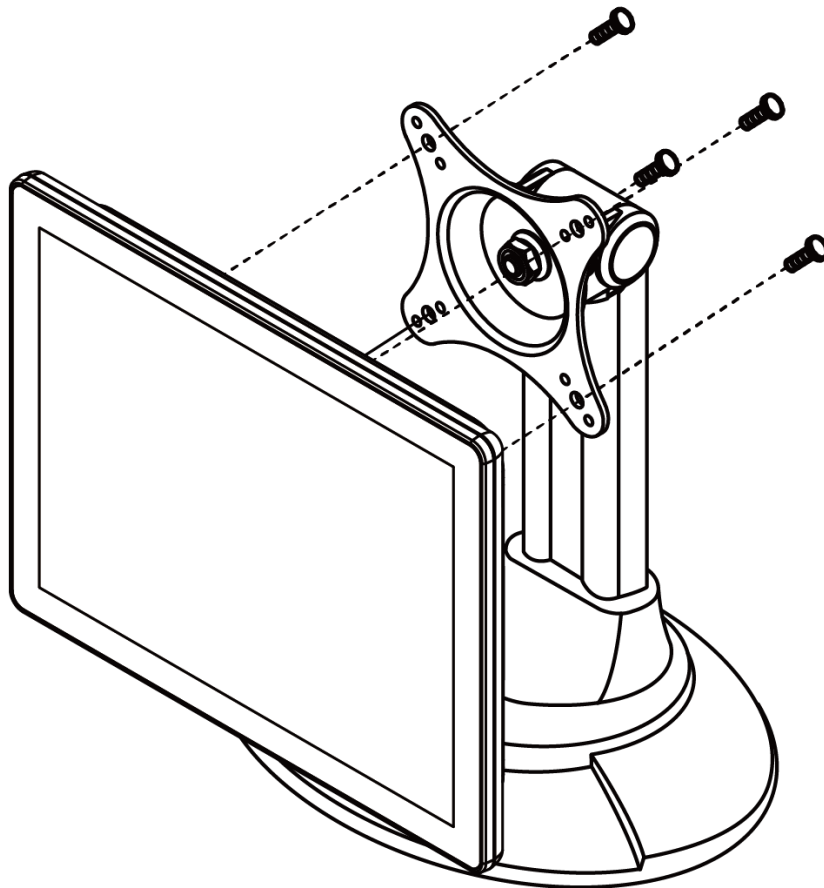

**The picture is for demonstration purposes only. VESA mount accessories are not supplied by Winmate.*

2.3 Turning On

Follow the following steps to turn on your device:

1. Connect AC adapter to DC jack connector of the HMI.
2. Connect the power cord to AC adapter.
3. Plug the power cord to the AC outlet.
4. Press **Power** button on the rear OSD panel.

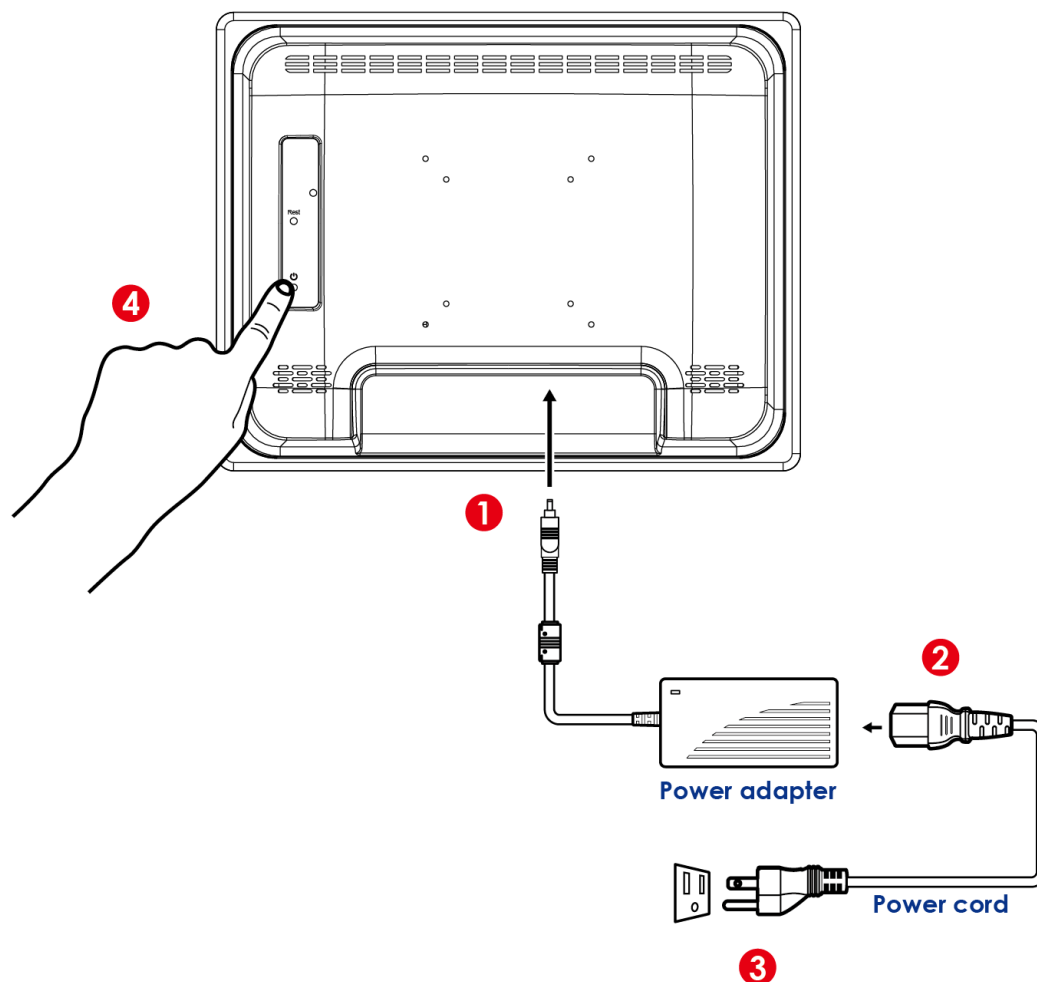

Caution

Use only the AC adapter included in your package. Using other AC adapters may damage the device.



Alternating Current

This product must be grounded. Use only a grounded AC outlet. Install the additional PE ground wire if the local installation regulations require it.

2.4 Connecting Peripherals

This section lists HMI connectors and pin assignment.

2.4.1 Power Connector

DC power source input is a DC-in power jack connector that accepts 12V DC power input.

Pin assignment and signal names of power input connector

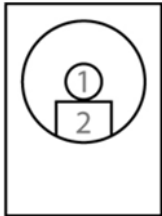

Pin №	Name	Pin №	Name
1	DC_IN	2	GND

 Voltage	Minimum Voltage 11.4V Maximum Voltage 12.6V Maximum Current 4.2A
---	--

2.4.2 Ethernet Connector

The HMI has two RJ45 connectors that support 10/100/1000 Mbps Ethernet interface for connecting to the internet. Notice that only one RJ45 connector supports PoE function.

Pin assignment and signal names of Ethernet connector

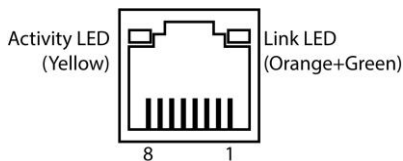

Pin №	Signal Name	Pin №	Signal Name
1	TX1+	2	TX1-
3	TX2+	4	TX2-
5	TX3+	6	TX3-
7	TX4+	8	TX4-



Important:

Power Device (PD): IEEE 802.3at (25 Watt)

2.4.3 Serial Port Connector

Use COM1 serial port connector to connect your HMI to external devices such as mouse, modem or printer. You can configure serial port settings via jumpers located on the motherboard.

Pin assignment and signal names of serial port connector

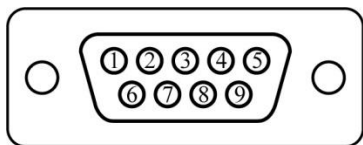

Pin №	RS232	RS422	RS485
1	DCD	TxD-	D-
2	RXD	TxD+	D+
3	TXD	RxD+	NC
4	DTR	RxD-	NC
5	GND	GND	GND
6	DSR	NC	NC
7	RTS	NC	NC
8	CTS	NC	NC
9	RI	NC	NC

2.4.4 USB Connector

The HMI has two USB 3.2 connectors. Use USB connector to connect your device to other USB compatible devices such as mouse, keyboard and printer.

Pin assignment and signal names of USB 3.2 connectors

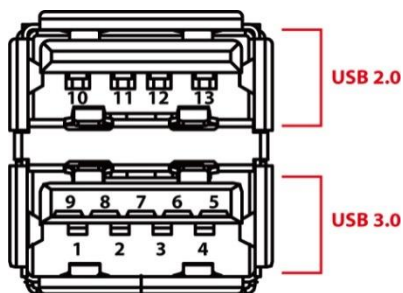

Pin №	Signal Name	Pin №	Signal Name
1	+5V	2	USB_D-
3	USB_D+	4	GND
5	STDA_SSRX-	6	STDA_SSRX+
7	GND_DRAIN	8	STDA_SSTX-
9	STDA_SSTX+	10	+5V
11	USB_D-	12	USB_D+
13	GND		

2.4.5 HDMI Connector

The HMI has one HDMI1.4a connector.

Pin assignment and signal name of HDMI connector

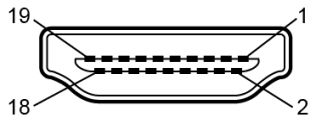

Pin No.	Signal Name	Pin No.	Signal Name
1	HDMI_DET	2	NC
3	HDMI_D2P	4	GND
5	HDMI_D2M	6	HDMI_D1P
7	GND	8	HDMI_D1M
9	HDMI_D0P	10	GND
11	HDMI_D0M	12	HDMI_CLKP
13	GND	14	HDMI_CLKM
15	HDMI_CEC_OUT	16	GND
17	DDC_CLOCK	18	DDC_DATA

2.5 Speaker

Speaker is located on the rear side of the HMI.

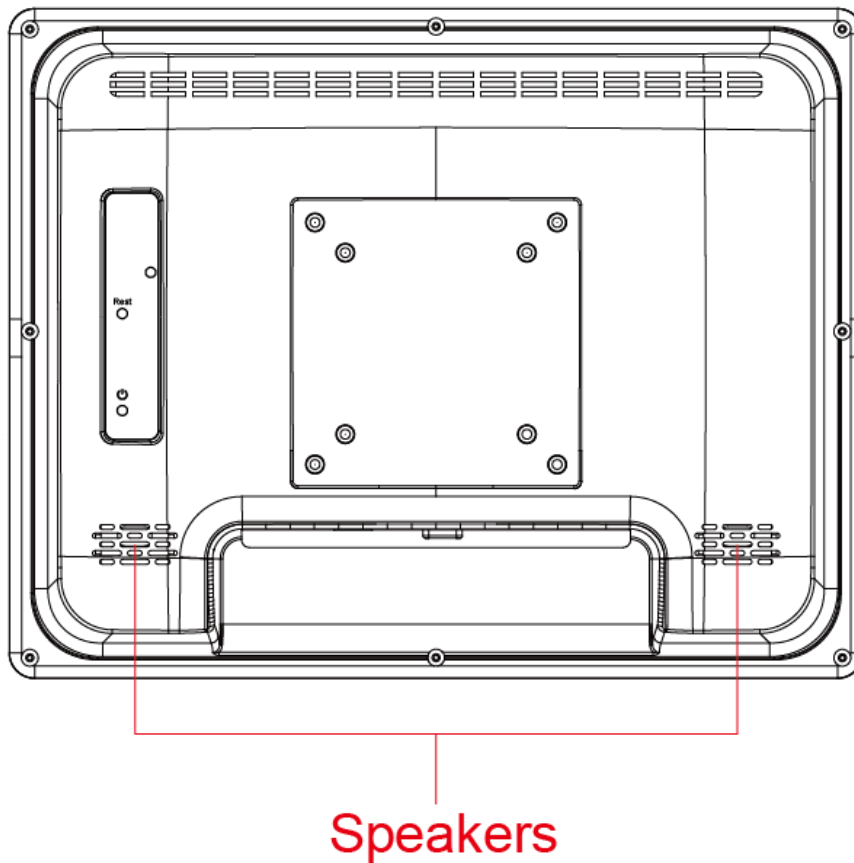

Electrical Specifications	
Rated impedance	6±15% ohms@2KHz, 1 Vrms input
Power Rating	0.67 W
Short Term Max Power	1.3W
Acoustical Specifications	
Sound Pressure Level	75±3dB/40cm@1kHz

Chapter 3: Operating the Device

3.1 Introduction

Your HMI supports several versions of Windows OS:

- Windows 10 IoT
- Windows Embedded 8.1 Industry Pro
- Windows Embedded 7 Standard





Important:

The device is shipped with the OS System according to your order. Contact us if you have any questions regarding OS settings.

3.2 How to Enable Watchdog

To enable Watchdog, you need to download Winmate Watchdog utility. Find more information on Watchdog in “Watchdog Guide” that you can download from Winmate Download Center.

To enable watchdog in Watchdog AP follow the instructions below:

1. On the right bottom side of the desktop screen, click  triangle button to show hidden icons.
2. Click  icon to open Watchdog utility.

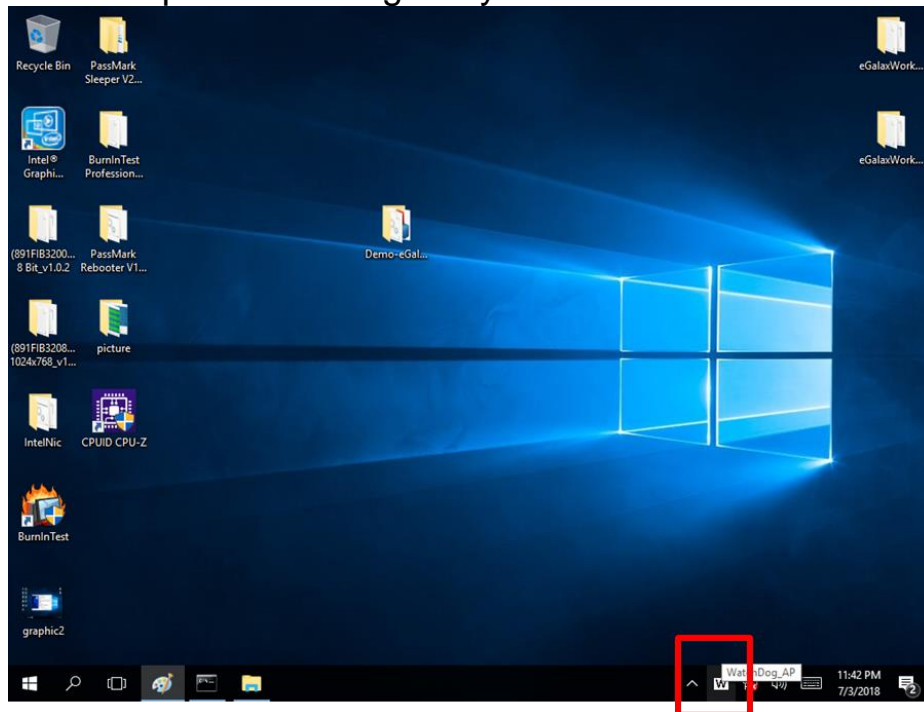

3. In Watchdog utility window set countdown time and periodically feed time, or disable watchdog.

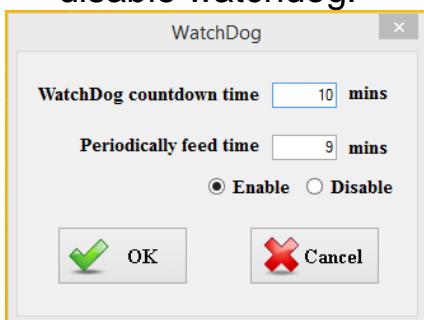

Example:

Every 10 min watchdog will monitor the system, in case any error occurs the system will restart automatically when the countdown time reaches 0.

Every 9 min watchdog timer will be reset to 10 min.

Setting	Description
Watchdog Countdown Time	The system automaticity restarts when this countdown time reaches zero. <i>Default: 10 min</i>
Periodically Feed Time	To set a cycle time to automatically reset watchdog timer. <i>Default: 9 min</i>
Enable / Disable	Enable or disable watchdog. <i>Default: Enable</i>

3.3 Using Recovery Wizard to Restore Computer



Note:

Before starting the recovery process, make sure to backup all user data. The data will be lost after the recovery process.

To enable quick one-key recovery procedure:

1. Connect the computer to the power source. Make sure the computer stays plugged in to power source during the recovery process.
2. Turn on the computer, and when the boot screen shows up, press **Tab+ F6** to initiate the Recovery Wizard.
3. The following screen shows the Recovery Wizard. Click **Recovery** button to continue.



4. A warning message about data loss will show up. Make sure the data is backed up before recovery, and click **Yes** to continue.



Wait the recovery process to complete. During the recovery process, a command prompt will show up to indicate the percent of recovery process complete. The system will restart automatically after recovery completed.

Chapter 4: BIOS Setup

This chapter describes the different settings available in the INSYDE BIOS that comes with the board. This chapter offers information on the Award BIOS installation utility.

4.1 How and When to Use BIOS Setup

4.2 BIOS Functions

4.1 How and When to Use BIOS Setup

To enter the BIOS setup, you need to connect an external USB keyboard, external monitor and press Del key when the prompt appears on the screen during start up. The prompt screen shows only few seconds so need press Del key quickly.



Important:

Updated BIOS version may be published after the manual released. Check the latest version of BIOS on the website.

You may need to run BIOS setup utility for reasons listed below:

1. Error message on screen indicates to check BIOS setup
2. Restoring the factory default settings.
3. Modifying the specific hardware specifications
4. Necessity to optimize specifications

BIOS Navigation Keys

The following keys are enabled during POST:

Key	Function
Del	Enters the BIOS setup menu.
F7	Display the boot menu. Lists all bootable devices that are connected to the system. With cursor ↑ and cursor ↓ and by pressing <ENTER>, select the device used for the boot.
Pause	Pressing the [Pause] key stops the POST. Press any other key to resume the POST.

The following Keys can be used after entering the BIOS Setup.

Key	Function
F1	General Help
F2	Previous Values
F3	Optimized Defaults
F4	Save & Exit
Esc	Exit
+/-	Change Opt.
Enter	Select or execute command
Cursor ↑	Moves to the previous item
Cursor ↓	Goes to the next item
Cursor ←	Moves to the previous item
Cursor →	Goes to the next item



Note:

You can press the F1, F2, F3, F4, +/-, and Esc keys by connecting a USB keyboard to your computer.

For items marked ► press <Enter> for more options.

4.2 BIOS Functions

4.2.1 Main Menu

The Main menu displays the basic information about your system including BIOS version, processor RC version, system language, time, and date.

When you enter BIOS setup, the first menu that appears on the screen is the main menu. It contains the system information including BIOS version, processor RC version, system language, time, and date.



BIOS Information

Shows system information including UEFI BIOS version, model name, marketing name, built date, etc.

Total Memory

Shows system memory size, VGA shared memory will be excluded.

System Date

Set the system date. Note that the 'Day' automatically changes when you set the date.

System Time

Set the system internal clock.

Access Level

Shows the access level of current user.

4.2.2 Advanced Settings

Select the Advanced Tab from the setup menu to enter the advanced BIOS setup screen. You can select any of the items on the left frame of the screen to go to the sub menu for the item, such as CPU Configuration. You can use the <Arrow> keys enter all advanced BIOS setup options. The advanced BIOS setup menu is shown below. The submenus described on the following pages.



Caution

- Handle advanced BIOS settings page with caution. Any changes can affect the operation of your computer.
- Beware of that setting inappropriate values in items of this menu may cause system to malfunction.
- The options and default settings might be different by RAM or CPU models.

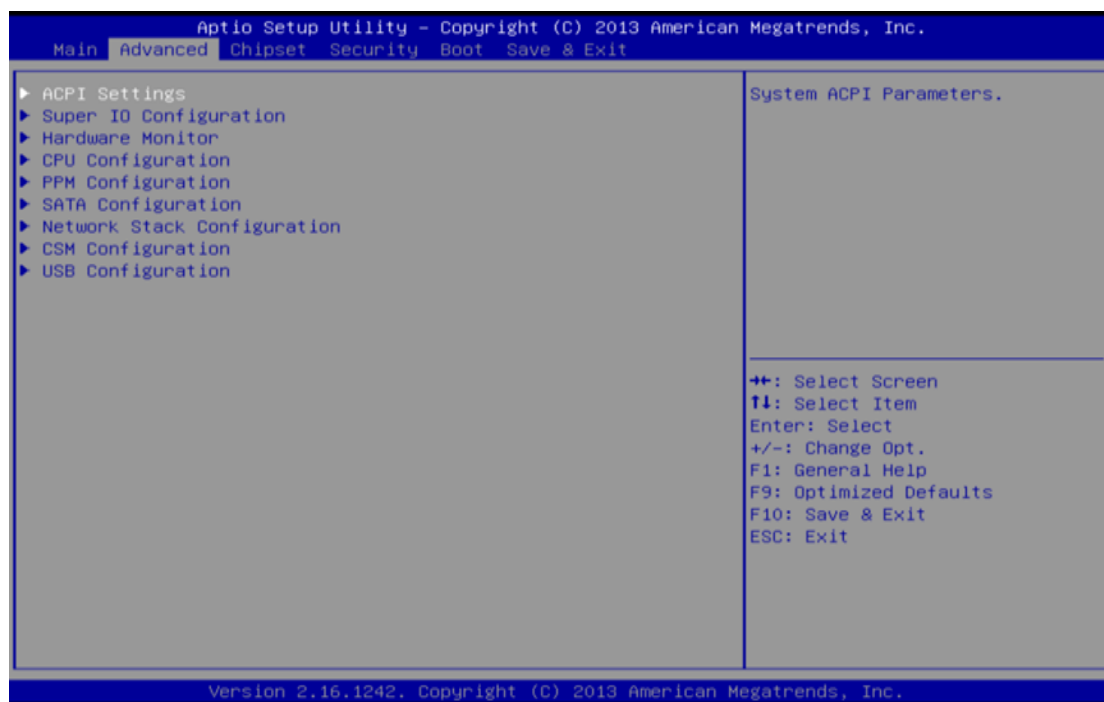

4.2.2.1 Super I/O Configuration



Serial Port 1 Configuration

Serial Port

This item enables or disables Serial Port (COM).

Options: Enabled (Default) / Disabled

Change Settings

This item allows you to select an optimal setting for Super IO device.

Options: Auto (Default) / IO=3F8h; IRQ=4 / IO=3F8h; IRQ=3, 4, 5, 6, 7, 9, 10, 11, 12 / IO=2F8h; IRQ=3, 4, 5, 6, 7, 9, 10, 11, 12 / IO=3E8h; IRQ=3, 4, 5, 6, 7, 9, 10, 11, 12 / IO=2E8h; IRQ=3, 4, 5, 6, 7, 9, 10, 11, 12

Watch Dog Degree

This item allows you to determine the functional degree of Watch Dog.

Options: Second (Default) / Minute

Watch Dog Timer

Options: 0 for disabled (Default) / Min=1, Max=65535

4.2.2.2 Hardware Monitor

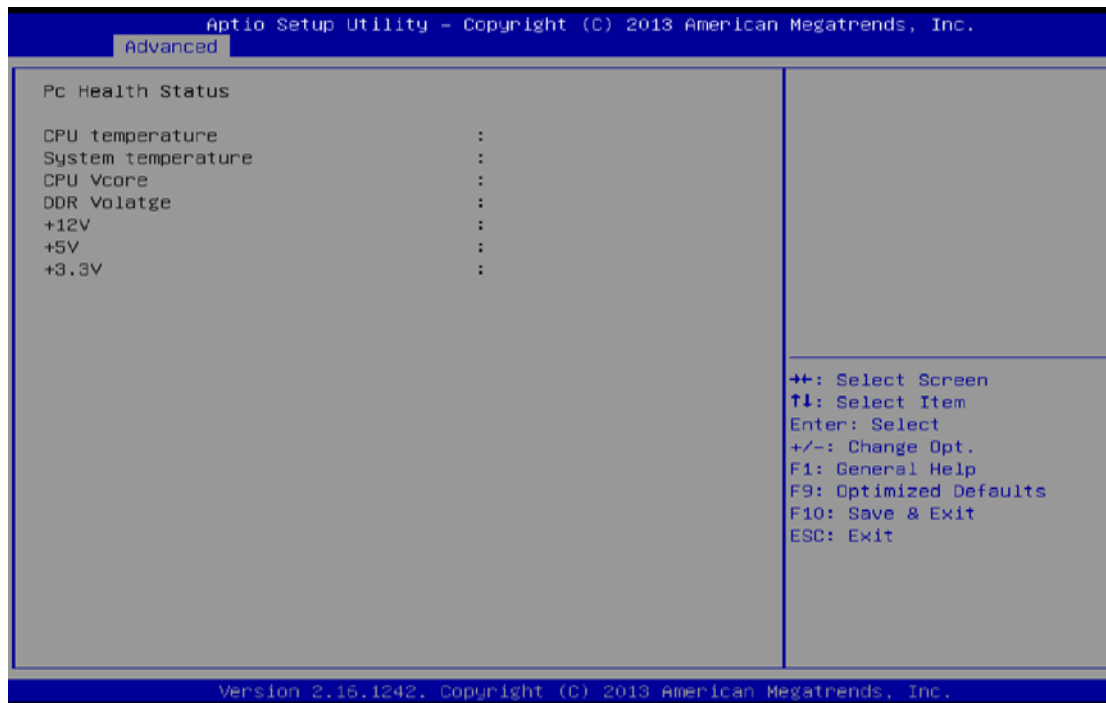

4.2.2.3 CPU Configuration

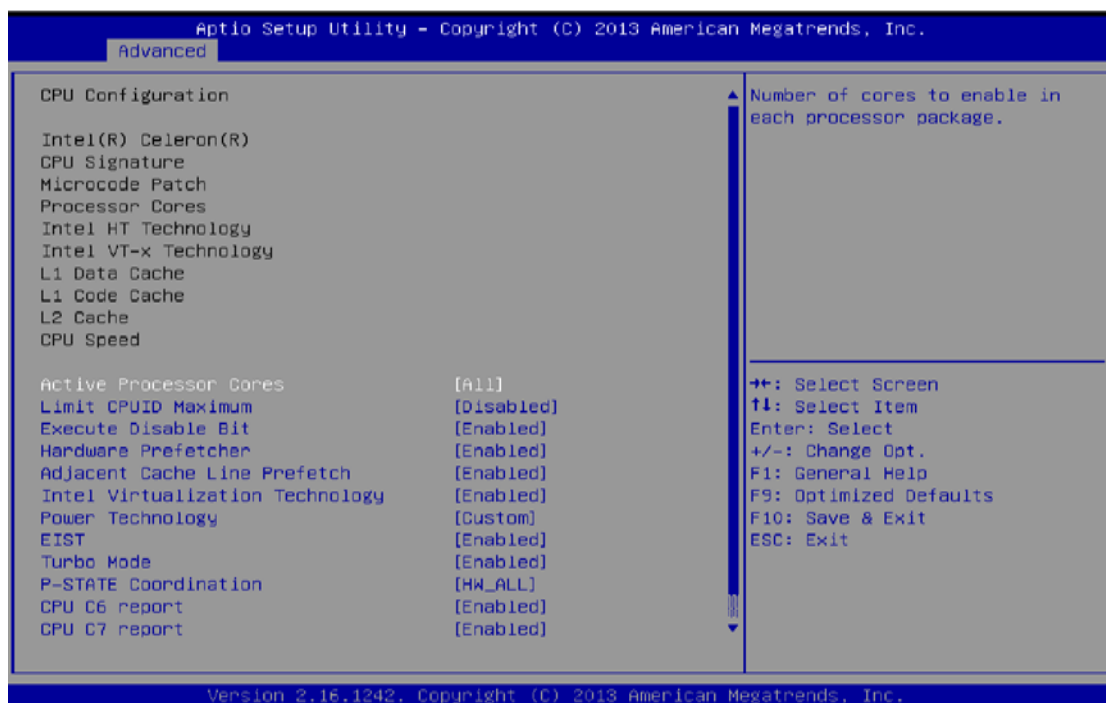

Active Processor Cores

This item sets number of cores to enable in each processor package

Options: All (Default) / 1

Limit CPUID Maximum

When the computer is booted up, the operating system executes the CPUID instruction to identify the processor and its capabilities. Before it can do so, it must first query the processor to find out the highest input value CPUID recognizes. This determines the kind of basic information CPUID can provide the operating system.

Options: Disabled (Default) / Enabled

Execute-Disable Bit

XD can prevent certain classes of malicious buffer overflow attacks when combined with a supporting OS (Windows Server 2003 SP1, Windows XP SP2, SuSE Linux 9.2, RedHat Enterprise 3 Update 3.).

Options: Enabled (Default) / Disabled

Hardware Prefetcher

The processor has a hardware prefetcher that automatically analyzes its requirements and prefetches data and instructions from the memory into the Level 2 cache that are likely to be required in the near future. This reduces the latency associated with memory reads.

Options: Enabled (Default) / Disabled

Adjacent Cache Line Prefetch

The processor has a hardware adjacent cache line prefetch mechanism that automatically fetches an extra 64-byte cache line whenever the processor requests for a 64-byte cache line. This reduces cache latency by making the next cache line immediately available if the processor requires it as well.

Options: Enabled (Default) / Disabled

Intel Virtualization Technology

Virtualization Technology can virtually separate your system resource into several parts, thus enhance the performance when running virtual machines or multi interface systems.

Options: Enabled (Default) / Disabled

Power Technology

This item enables or disables the power management features.

Options: Custom (Default) / Disable / Energy Efficient

EIST

This item enables or disables Intel SpeedSteps.

Options: Enabled (Default) / Disabled

Turbo Mode

This item enables or disables Turbo Mode

Options: Enabled (Default) / Disabled

P-STATE Coordination

This item changes P-STATE Coordination.

Options: HW_ALL (Default) / SW_ALL / SW_ANY

CPU C6 Report

This item enables or disables CPU C6 (ACPI C3) report to OS.

Options: Enabled (Default) / Disabled

CPU C7 Report

This item enables or disables CPU C7 (ACPI C3) report to OS.

Options: Enabled (Default) / Disabled

Package C state limit

This item enables or disables package C state limit

Options: No Limit (Default) / C0 / C1 / C3 / C6 / C7

4.2.2.4 PPM Configuration

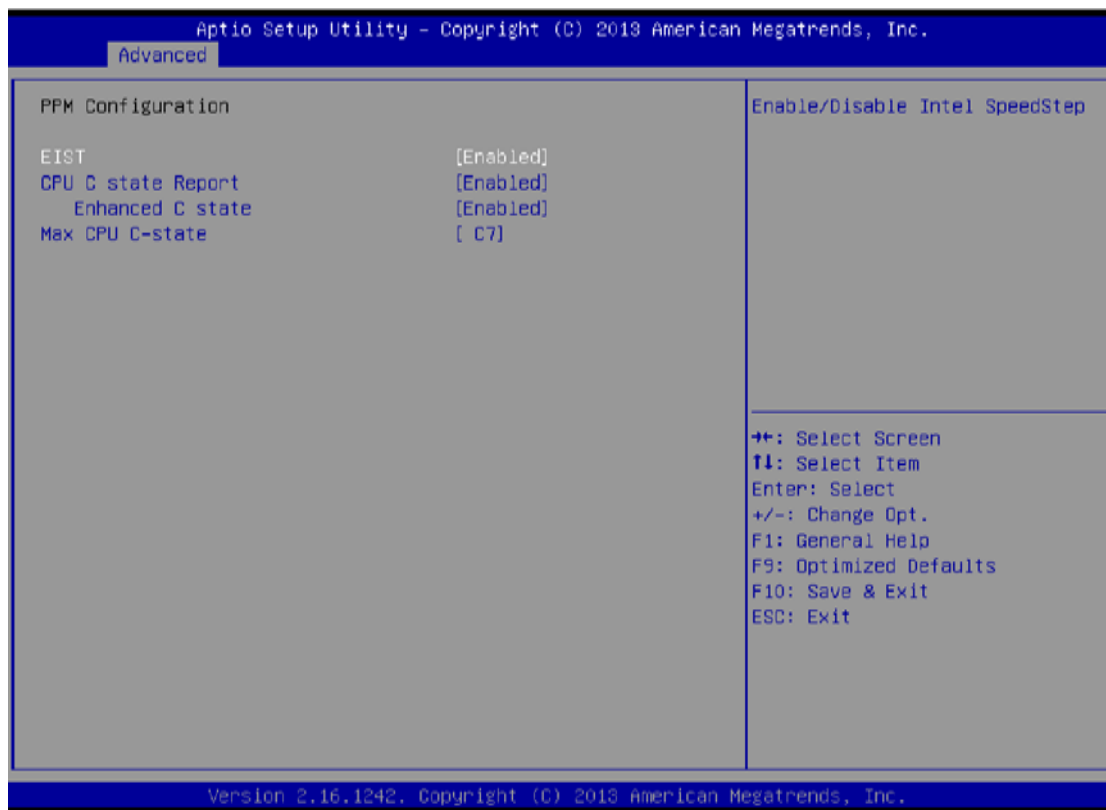

EIST

This item enables or disables Intel SpeedSteps.

Options: Enabled (Default) / Disabled

CPU C state Report

This item enables or disables CPU C state report to OS.

Options: Enabled (Default) / Disabled

Enhanced C state

This item enables or disables Enhanced CPU C state

Options: Enabled (Default) / Disabled

Max CPU C-state

This option controls Max C state that the processor will support.

Options: C7 (Default) / C6 / C1

4.2.2.5 SATA Configuration

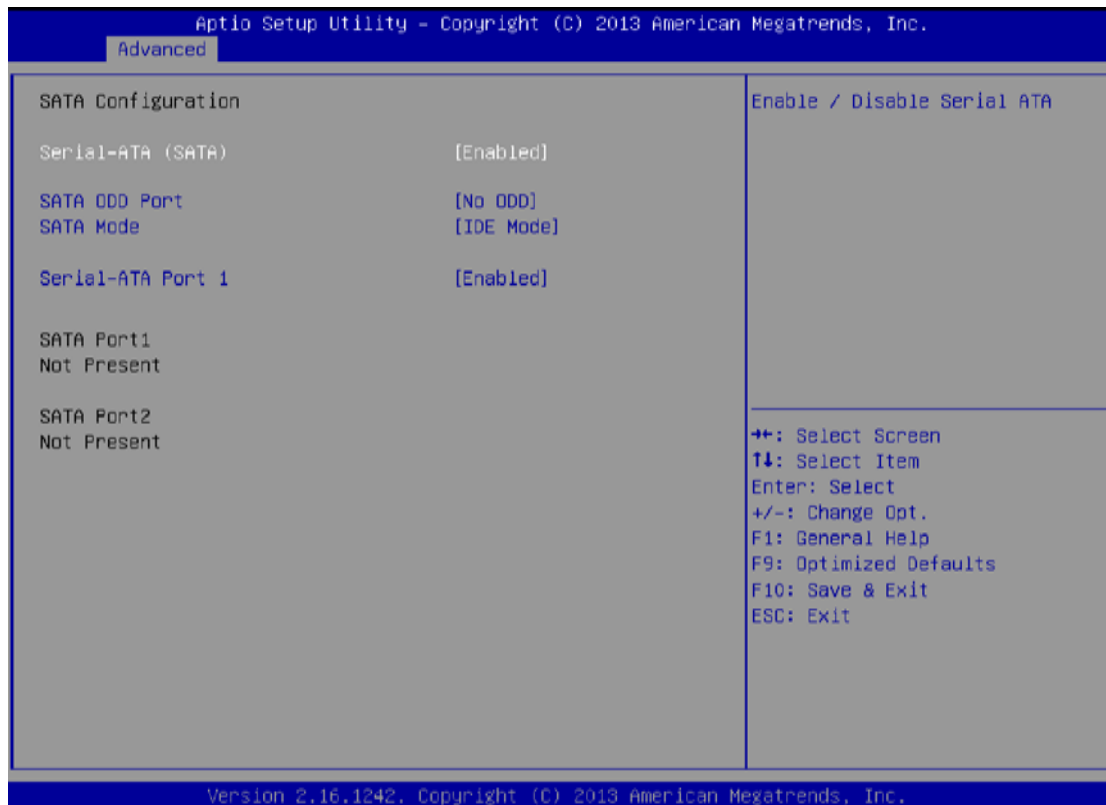

Serial-ATA (SATA)

This item enables/disables Serial ATA Device.

Options: Enabled (Default) / Disabled

SATA ODD Port

This item selects SATA ODD Port

Options: No ODD (Default) / Port0 ODD / Port1 ODD

SATA Mode

This item determines how SATA controller(s) operate.

Options: IDE (Default) / AHCI

Serial-ATA Port 1

This item enables/disables Serial ATA Port 1

Options: Enabled (Default) / Disabled

4.2.2.6 Network Stack Configuration



Network Stack

This item enables or disables UEFI network stack

Options: Disabled (Default) / Enabled

Note: The following items appear only when you set the Network Stack function to [Enabled]

IPv4 PXE Support

This item enables or disables IPv4 PXE Boot Support. If disabled IPv4 boot option will not be created.

Options: Enabled (Default) / Disabled

IPv6 PXE Support

This item enables or disables IPv6 PXE Boot Support. If disabled IPv6 boot option will not be created.

Options: Enabled (Default) / Disabled

PXE boot wait time

Wait time to press ESC key to abort the PXE boot.

4.2.2.7 CSM Configuration

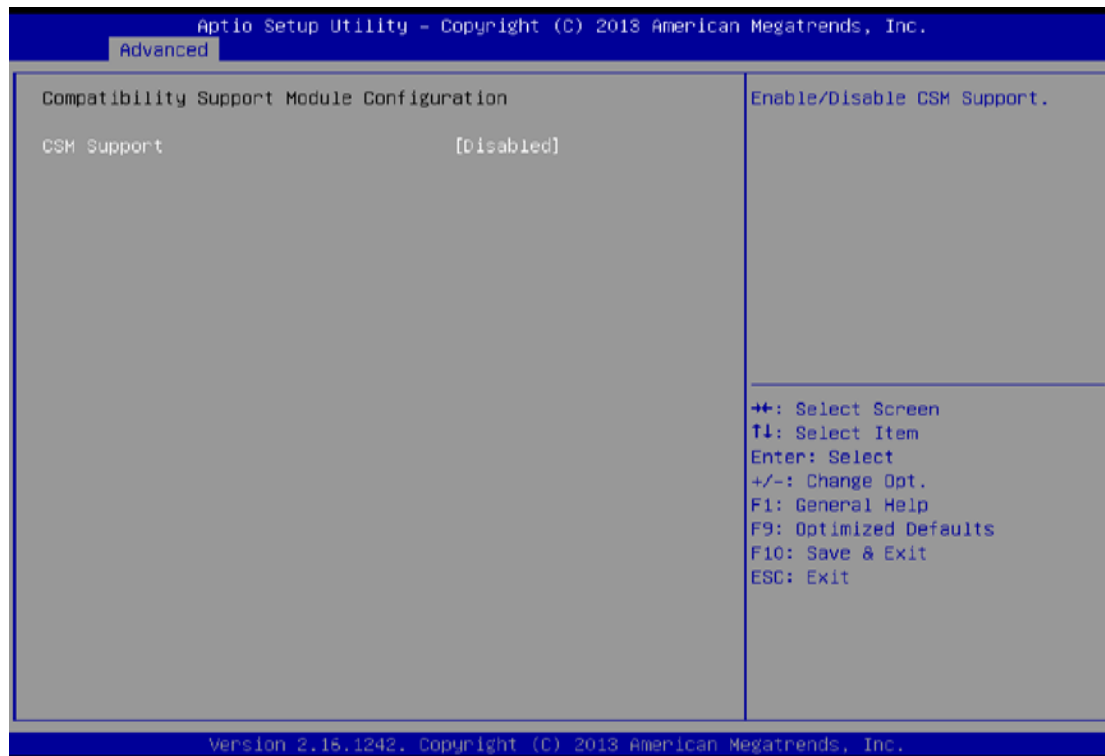

CSM Support

This item enables or disables CSM Support

Options: Disabled (Default) / Enabled

Note: The following items appear only when you set the CSM Support to [Enabled]

GateA20 Active

Upon Request – FA20 can be disabled using BIOS services. Always – do not allow disabling GA20; this option is useful when any RT code is executed above 1MB

Options: Upon Request (Default) / Always

Option ROM Messages

This item sets the display mode for option ROM.

Options: Force BIOS (Default) / Keep Current

INT19 Trap Response

BIOS reaction on INT19 trapping by Option ROM: IMMEDIATE – execute the trap right away; POSTPONED–execute the trap during legacy boot.

Options: Immediate (Default) / Postponed

Boot option filter

This option controls what devices system can boot to.

Options: Legacy only (Default) / UEFI and Legacy / UEFI only

Network

This option controls the execution of UEFI and Legacy PXE OpROM

Options: Legacy only (Default) / Do not launch / UEFI only / Legacy first / UEFI first

Storage

This option controls the execution of UEFI and Legacy Storage OpROM

Options: Legacy only (Default) / Do not launch / UEFI only / Legacy first / UEFI first

Video

This option controls the execution of UEFI and Legacy Video OpROM

Options: Legacy only (Default) / Do not launch / UEFI only / Legacy first / UEFI first

Other PCI devices

For PCI devices other than Network, Mass storage or video defines which OpROM to launch.

Options: Legacy only (Default) / UEFI first

4.2.2.8 USB Configuration

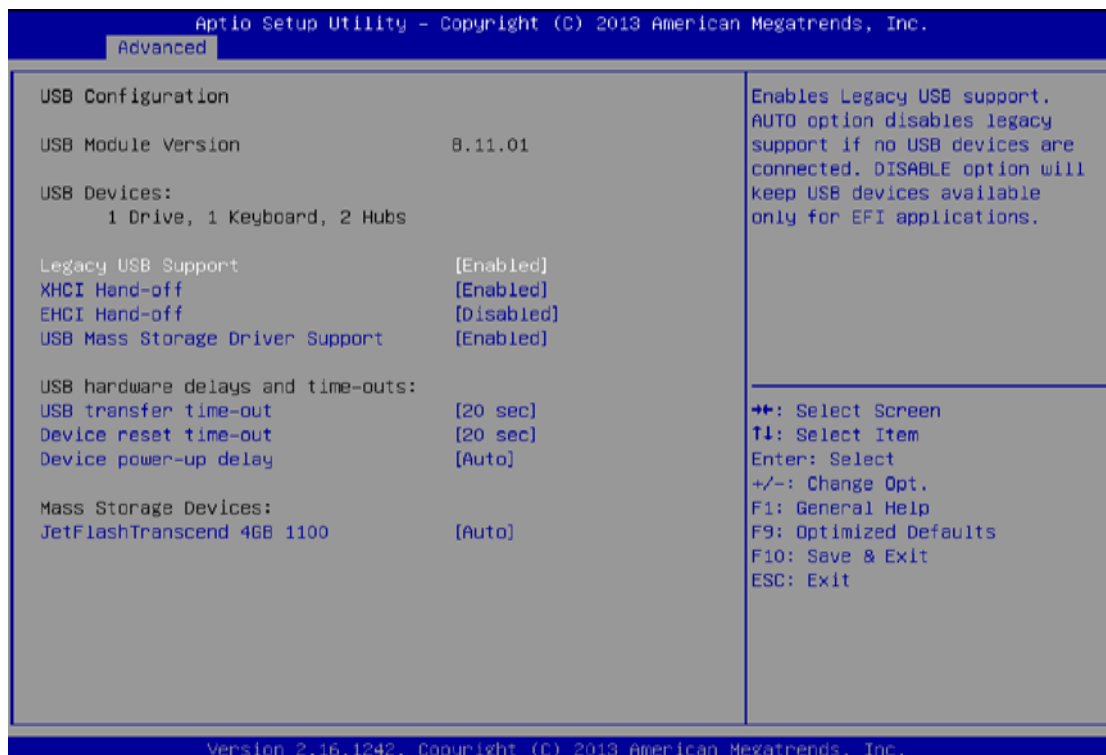

Legacy USB Support

This item determines if the BIOS should provide legacy support for USB devices like the keyboard, mouse, and USB drive. This is a useful feature when using such USB devices with operating systems that do not natively support USB (e.g. Microsoft DOS or Windows NT).

Options: Enabled (Default) / Disabled / Auto

XHCI Hand-Off

This is a workaround for OSeS without XHCI hand-off support. The XHCI ownership change should be claimed by XHCI driver.

Options: Enabled (Default) / Disabled

EHCI Hand-Off

This is a workaround for OSeS without EHCI hand-off support. The EHCI ownership change should be claimed by EHCI driver.

Options: Disabled (Default) / Enabled

USB Mass Storage Driver Support

The item allows you to enable or disable USB Mass Storage Driver Support.

Options: Enabled (Default) / Disabled

USB transfer time-out

The time-out value for Control, Bulk, and Interrupt transfers.

Options: 20 sec (Default) / 1 sec / 5 sec / 10 sec

Device reset time-out

The item sets USB mass storage device Start Unit command time-out.

Options: 20 sec (Default) / 10 sec / 30 sec / 40 sec

Device power-up delay

“Auto” uses default value: for a Root port it is 100ms, for a Hub port the delay is taken from Hub descriptor.

Options: Auto (Default) / Manual

Device power-up delay in seconds

Delay range is 1 ~ 40 seconds, in one second increments.

Options: 5 (Default)

4.2.3 Chipset Menu

This section describes configuring the PCI bus system. PCI, or Personal Computer Interconnect, is a system which allows I/O devices to operate at speeds nearing the speed of the CPU itself uses when communicating with its own special components.

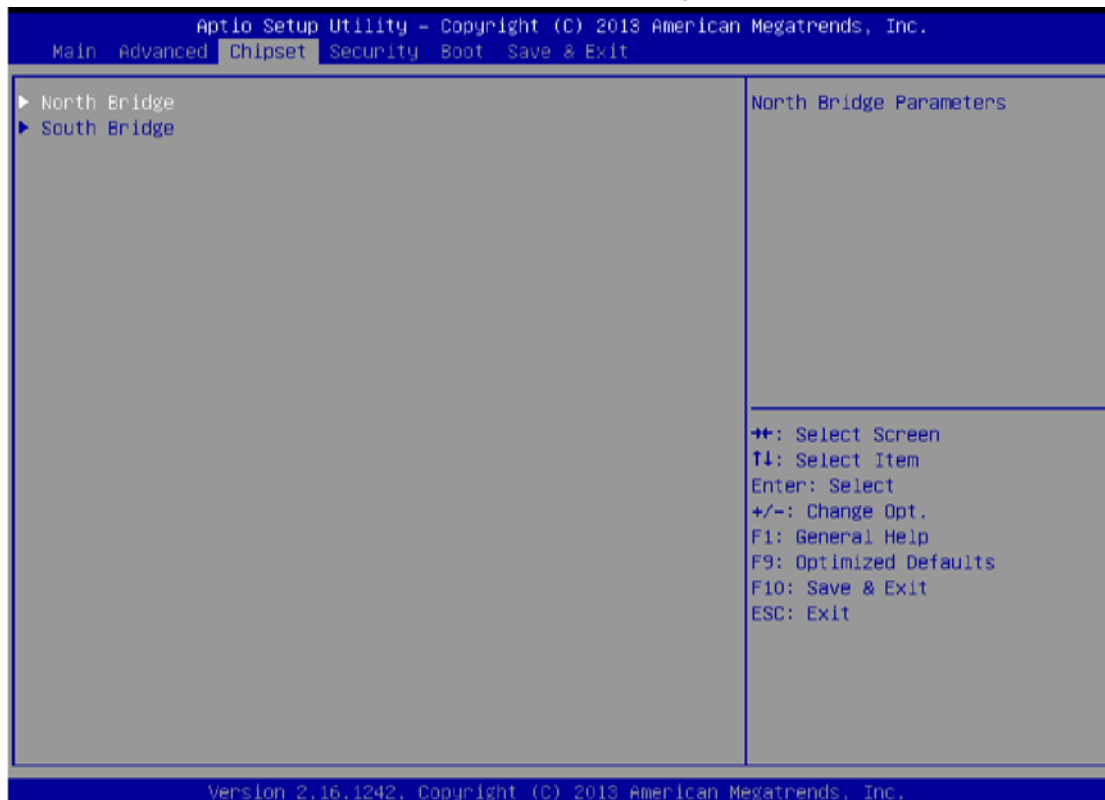

4.2.3.1 North Bridge

Intel IGD Configuration

Integrated Graphics Device

Enable: Enable Integrated Graphics Device (IGD) when selected as the Primary Video Apaptor.

Disable: Always disable IGD.

Options: Enabled (Default) / Disabled

IGD Turbo Enable

Enable: Enable IGD Turbo Enable. Disable: Enable IGD Turbo Disable.

Options: Enabled (Default) / Disabled

Primary Display

This item selects which of IGD/PCI Graphics device should be Primary Display.

Options: IGD (Default) / Auto / PCI / SG

GFX Boost

This item enables or disables GFX Boost.

Options: Disabled (Default) / Enabled

PAVC

This item enables or disables Protected Audio Video Control

Options: LITE Mode (Default) / Disabled / SERPENT Mode

DVMT Pre-Allocated

This item selects DVMT 5.0 Pre-Allocated (Fixed) Graphics Memory size used by the Internal Graphics Device

Options: 64M (Default) / 96M / 128M / 160M / 192M / 224M / 256M / 288M / 320M / 352M / 384M / 416M / 448M / 480M / 512M

DVMT Total Gfx Mem

This item selects DVMT5.0 Total Graphic Memory size used by the Internal Graphics Device.

Options: 256MB (Default) / 128MB / MAX

Aperture Size

This item selects the Aperature Size.

Options: 256MB (Default) / 128MB / 512MB

GTT Size

This item selects the GTT Size.

Options: 2MB (Default) / 1MB

VCC_Vnn Config for Power state2

This item enables or disables Vcc Vnn Config for power state2

Options: Disabled (Default) / Enabled

RC6 (Render Standby)

This item enables or disables render standby support.

Options: Enabled (Default) / Disabled

LCD Control

Boot Display Device

This item allows you to select the display device.

Options: Auto (Default)

Max TOLUD

This item sets maximum value of TOLUD.

Options: Dynamic (Default) / 1GB / 1.25GB / 1.5GB / 1.75GB / 2GB / 2.25GB / 2.5GB / 2.75GB / 3GB

4.2.3.2 South Bridge



Azalia HD Audio

Azalia Controller

This item controls detection of the Azalia device. Disabled = Azalia will be unconditionally disabled. Enabled = Azalia will be unconditionally Enabled. Auto = Azalia will be enabled if present, disabled otherwise.

Options: Enabled (Default) / Disabled

Azalia HDMI Codec

This item enables or disables internal HDMI codec for Azalia.

Options: Enabled (Default) / Disabled

HDMI Port B/C

This item enables or disables HDMI Port B/C.

Options: Enabled (Default) / Disabled

Audio AMP output

This item selects Audio AMP output dB value.

Options: 11dB (Default) / 14dB / 19dB / 25dB

USB Configuration

XHCI Mode

The item selects Mode of operation of xHCI controller.

Options: Smart Auto (Default) / Auto / Enabled / Disabled

USB 2.0(EHCI) Support

This item controls the USB EHCI (USB 2.0) functions. One EHCI controller must always be enabled.

Options: Disabled (Default) / Enabled

USB Per Port Control

Control each of the USB ports (0-3). Enable: Enable USB per port; Disable: Use USB port X settings.

Options: Enabled (Default) / Disabled

USB Port 0/1/2/3

This item enables or disables USB Port 0.

Options: Enabled (Default) / Disabled

PCI Express Configuration

Onboard LAN

This item enables or disables Onboard PCIE LAN.

Options: Enabled (Default) / Disabled

Onboard LAN Option ROM

This item enables or disables the Boot Option for Legacy Network Devices.

Options: Disabled (Default) / Enabled

High Precision Timer

This item enables or disables the High Precision Event Timer.

Options: Enabled (Default) / Disabled

4.2.4 Security Menu

This section allows to configure and improve system, and set up some system features according to your preferences.

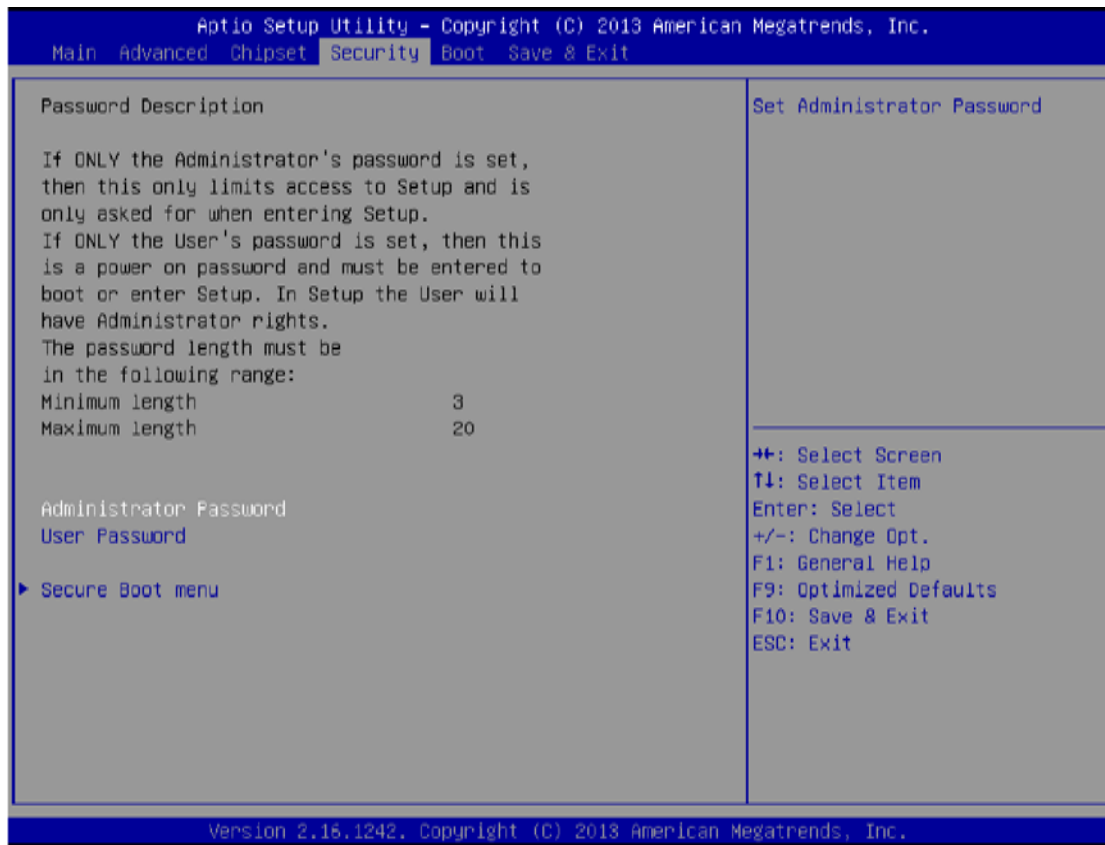

Administrator Password

This item sets Administrator Password.

User Password

This item sets User Password.

Secure Boot

Secure Boot can be enabled if 1. System running in user mode with enrolled Platform Key(PK)2.CSM function is disabled.

Options: Disable (Default) / Enabled

Key Management

Enroll All Factory Default Keys

It allows you to immediately load/clear the default Security Boot keys, Platform key (PK), Key-exchange Key (KEK), Signature database (db), and Revoked Signatures (dbx). The Platform Key (PK) state will change from Unloaded mode to Loaded mode. The settings are applied after reboot or at the next reboot.

Platform Key (PK)

Delete PK – Allows you to delete the PK file from your system.

Set new PK – Allows you set new PK file.

Key Exchange Key Database (KEK)

Delete KEK – Allows you to delete the KEK file from your system.

Set new KEK – Allows you set new KEK file.

Append Var to KEK – Allows you append Var to KEK.

Authorized Signature Database (DB)

Delete DB – Allows you to delete the DB file from your system.

Set new DB – Allows you set new DB file.

Append Var to DB – Allows you append Var to DB.

Authorized Timestamps Database (DBT)

Delete DBT – Allows you to delete the DBT file from your system.

Set new DBT – Allows you set new DBT file.

Append Var to DBT – Allows you append Var to DBT.

Forbidden Signature Database (DBX)

Delete DBX – Allows you to delete the DBX file from your system.

Set new DBX – Allows you set new DBK file.

Append Var to DBX – Allows you append Var to DBX.

4.2.5 Boot Menu

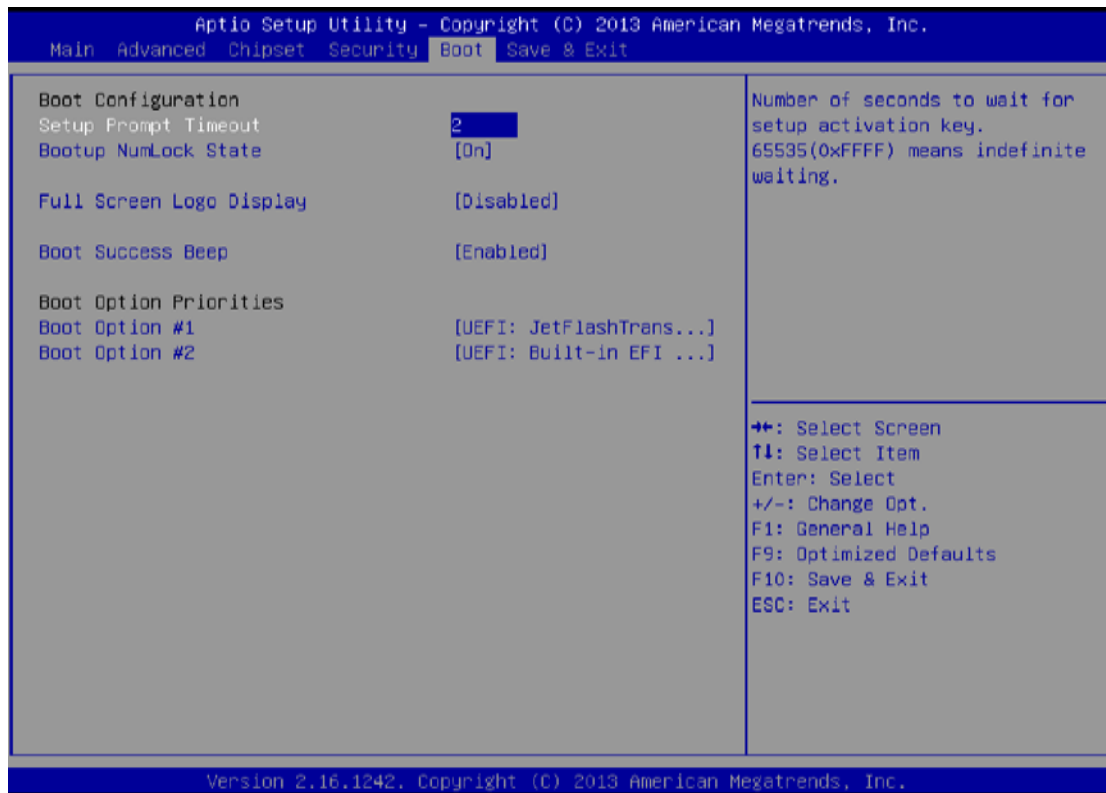

Setup Prompt Timeout

This item sets number of seconds to wait for setup activation key.

Options: 2 (Default)

Bootup NumLock State

This item selects the keyboard NumLock state.

Options: On (Default) / Off

Full Screen Logo Display

This item allows you to enable/disable Full Screen Logo Show function.

Options: Disabled (Default) / Enabled

Boot Success Beep

When this item is set to Enabled, BIOS will let user know boot success with beep.

Options: Enabled (Default) / Disabled

Boot Option

The items specify the boot device priority sequence from the available devices.

The number of device items that appears on the screen depends on the number of devices installed in the system.

4.2.6 Exit Menu

This menu allows you to load the optimal default settings, and save or discard the changes to the BIOS items.

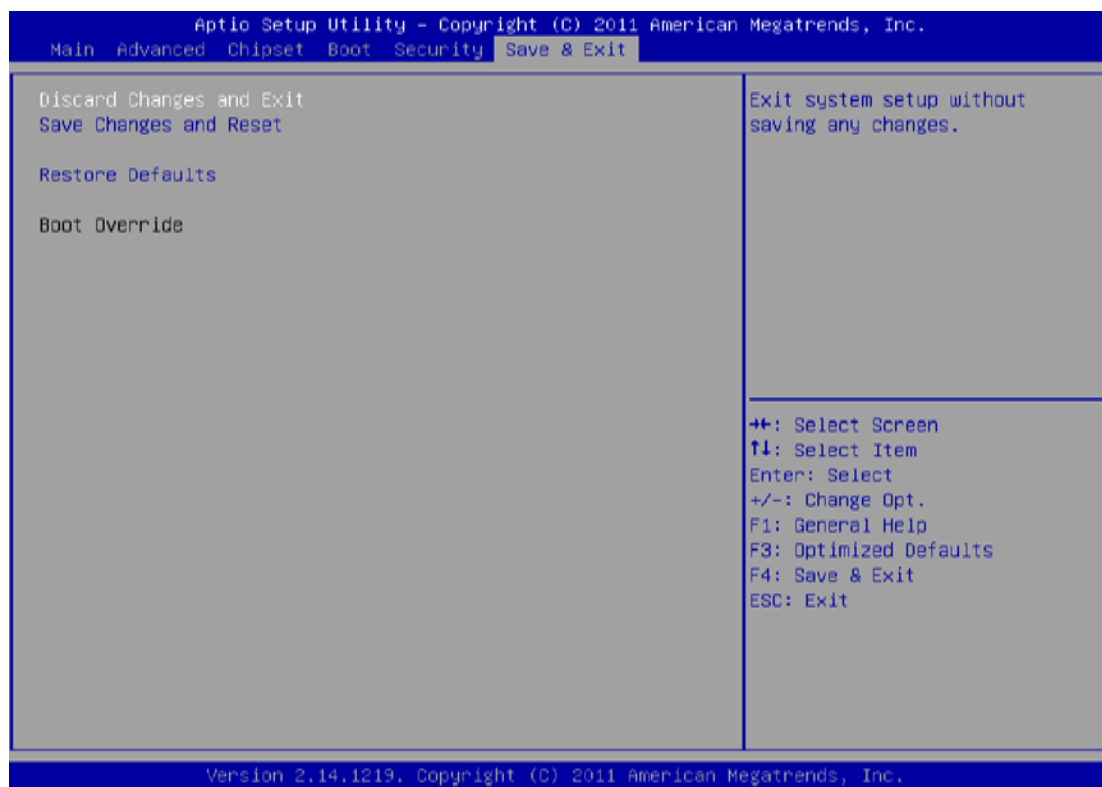

Discard Changes and Exit

Abandon all changes made during the current session and exit setup.

Save Changes and Reset

Reset the system after saving the changes.

Restore Defaults

This selection allows you to reload the BIOS when problem occurs during system booting sequence. These configurations are factory settings optimized for this system.

Appendix

Appendix A: Product Specifications

	Model Name	
	R15IE3S-PTC3	W15IE3S-PTA3
Display		
Size	15"	15.6"
Resolution	1024 x 768	1920 x 1080
Panel Brightness	350 cd/m^2	400 cd/m^2
Contrast Ratio	800:1 (typ.)	800:1 (typ.)
View Angles	~80~80 (H); ~70~80 (V)	-85~85(H);-85~85(V)
Touch/Glass	Projected Capacitive Multi Touch Screen Anti-glare Coating (Optional)	Projected Capacitive Multi Touch Screen
Active Area	304.128x228.096 mm	344.16x193.59 mm
Mechanical		
Dimensions	352.5 x 276.7 x 45 (mm)	388 x 233 x 40 mm
Mounting	VESA mount	VESA mount
Cooling System	Fanless Design	Fanless
Enclosure	Plastic	Plastic casing
IO Ports		
Serial Port	1 x RS-232/422/485, 1 x CANBUS (DB9)	1 x RS232(Default)/422/485
USB Port	1 x USB 2.0 1 x USB OTG – Connect to PC for Client Use and Update Image 1 x Mini USB– For Linux Debug	2 x USB3.2 Gen1x1 (Type-A)
LAN	1 x RJ45-10/100/1000 Mbps 1 x RJ45-10/100/1000 Mbps with PoE (Optional)	2 x Intel® Ethernet Controller
Audio	2 x Speaker	2 x 1W Speakers
SD Card Slot	1 x Micro SD Card Reader	
Indicator	Power LED Indicator	
Power Requirements		
Power Rating	12V DC with Terminal Block	12V DC
PoE	Power Device (PD), follows IEEE 802.3at (25 W)	
System Specification		
Processor	NXP i.MX6 Dual Core, 1.0GHz	Intel® Celeron® N6211 (1.5M Cache, up to 3.0GHz) Intel® Celeron® N6210 (1.5M Cache, up to 2.6GHz) (Optional)
System Memory	1GB 2GB (Optional)	1 x SO-DIMM, DDR4 3200 MHz, 4GB 8GB (Optional) 16GB (Optional)
Storage	eMMC: Onboard 16 GB eMMC: Onboard 32 GB (Optional)	1 x M.2 2242 B-key SSD 128GB M.2 2242 B-key SSD up to 512GB (Optional) 1 x SATA III for 2.5" SSD/HDD up to 1TB (Optional)
Ethernet controller		2 x Intel® Ethernet Controller
Security		TPM 2.0
Operating System	Linux Ubuntu 18.04 (Optional) Android 6.0 (Optional) Debian 7.0 (Optional)	Windows 11 IoT Enterprise SAC (64 bit) (Optional) Windows 10 IoT Enterprise (64 bit)

	Linux 4.1.15 QT 5.5 (Optional)	(Optional) Linux Ubuntu 22.04 (Optional)
WLAN	Support (Optional)	
BT	Support (Optional)	
Environment		
Operating Humidity	10% to 90% RH, Non-Condensing	
Operating Temperature	0°C to 50°C	
Storage Temperature	-10°C to 60°C	
IP rating	Front IP65	
Control		
Button	1 x Power Button 1 x Reset Button	
Accessory		
Accessory	Quick Start Guide(Hardcopy) AC Adapter 12V/50W Power Cord Terminal Block to DC Jack	
Certification		
Safety	CE, FCC	

	Model Name	
	W22IE3S-PTA3	W24IE3S-PTA2
Display		
Size	21.5"	23.8"
Resolution	1920 x 1080	1920 x 1080
Panel Brightness	250 <i>cd/m²</i>	250 <i>cd/m²</i>
Contrast Ratio	3000:1 (typ.)	3000:1 (typ.)
View Angles	~89~89 (H); ~89~89 (V)	-89~89(H);-89~89(V)
Touch/Glass	Projected Capacitive Multi Touch Screen	Projected Capacitive Multi Touch Screen
Active Area	476.64x268.11 mm	527.04x296.46 mm
Mechanical		
Dimensions	530 x 322 x 56 mm	588 x 358 x 60 mm
Mounting	VESA mount	VESA mount
Cooling System	Fanless Design	Fanless Design
Enclosure	Plastic	Plastic
IO Ports		
Serial Port	1 x RS232(Default)/422/485	
USB Port	2 x USB3.2 Gen1x1 (Type-A)	
LAN	2 x RJ45-10/100/1000 Mbps	
Video	1 x HDMI 2.0 (Optional)	
Audio	2 x Speaker (Optional)	
Indicator	Power LED Indicator	
Power Requirements		
Power Rating	12V DC in	
System Specification		
Processor	Intel® Celeron® N6211 (1.5M Cache, up to 3.0GHz) Intel® Celeron® N6210 (1.5M Cache, up to 2.6GHz) (Optional)	
System Memory	1 x SO-DIMM, DDR4 3200 MHz, 4GB 8GB (Optional) 16GB (Optional)	
Storage	1 x M.2 2242 B-key SSD 128GB	

	M.2 2242 B-key SSD up to 512GB (Optional) 1 x SATA III for 2.5" SSD/HDD up to 1TB (Optional)
Ethernet controller	2 x Intel® Ethernet Controller
Security	TPM 2.0
Operating System	Windows 11 IoT Enterprise SAC (64 bit) (Optional) Windows 10 IoT Enterprise (64 bit) (Optional) Linux Ubuntu 22.04 (Optional)
Environment	
Operating Humidity	10% to 90% RH, Non-Condensing
Operating Temperature	0°C to 50°C
Storage Temperature	-10°C to 60°C
IP rating	Front IP65
Control	
Button	1 x Power Button 1 x Reset Button
Accessory	
Accessory	Quick Start Guide(Hardcopy) AC Adapter 12V/50W Power Cord
Certification	
Certification	CE, FCC

Appendix B: Cleaning the LCD Monitor

Before cleaning:

- Make sure the device is turned off.
- Disconnect the power cable from any AC outlet.

When cleaning:

- Never spray or pour any liquid directly on the screen or case.
- Wipe the screen with a clean, soft, lint-free cloth. This removes dust and other particles.
- The display area is highly prone to scratching. Do not use ketene type material (ex. Acetone), Ethyl alcohol, toluene, ethyl acid or Methyl chloride to clear the panel. It may permanently damage the panel and void the warranty.
- If it is still not clean enough, apply a small amount of non-ammonia, non-alcohol based glass cleaner onto a clean, soft, lint-free cloth, and wipe the screen.
- Don not use water or oil directly on the display screen. If droplets are allowed to drop on the screen, permanent staining or discoloration may occur.

Appendix C: Technical Support

Winmate provides the following Drivers, SDK and Update Guide:

Item	Driver	Description
1	Utility	Watchdog Utility

To find the Drivers and SDK, please refer to the Driver CD that comes in the package or contact us. Also, you can download drivers from [Winmate Download Center](#)

Winmate Inc.
9F, No.111-6, Shing-De Rd., San-Chung District,
New Taipei City 24158, Taiwan, R.O.C
www.winmate.com