

QBiX-WHLA8565H-A1/ QBiX-WHLA8265H-A1/ QBiX-WHLA8145H-A1

QBiX Industrial Embedded System
Quick Start Guide

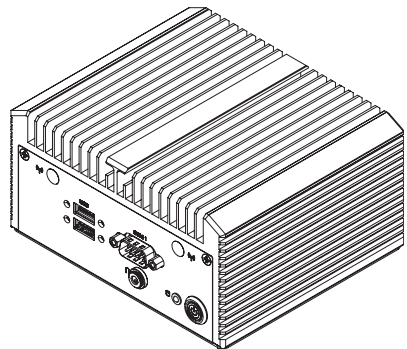
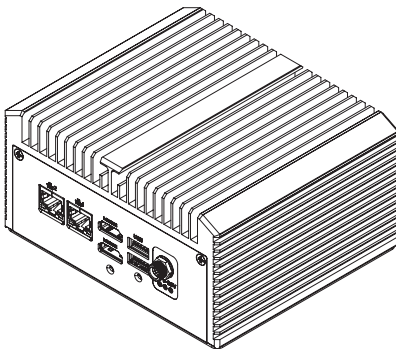

Copyright Notice

This document is copyrighted, 2019. All rights are reserved. The original manufacturer reserves the right to make improvements to the products described in this manual at any time without notice.

No part of this manual may be reproduced, copied, translated, or transmitted in any form or by any means without the prior written permission of the original manufacturer. Information provided in this manual is intended to be accurate and reliable. However, the original manufacturer assumes no responsibility for its use, or for any infringements upon the rights of third parties that may result from its use.

The material in this document is for product information only and is subject to change without notice. While reasonable efforts have been made in the preparation of this document to assure its accuracy, GIGAIPC assumes no liabilities resulting from errors or omissions in this document, or from the use of the information contained herein.

GIGAIPC reserves the right to make changes in the product design without notice to its users.

Acknowledgement

All other products' name or trademarks are properties of their respective owners.

- AMD is trademark of Advanced Micro Devices.
- Microsoft Windows is a registered trademark of Microsoft Corp.
- Intel, Pentium, Celeron, and Xeon are registered trademarks of Intel Corporation
- Core, Atom are trademarks of Intel Corporation
- ITE is a trademark of Integrated Technology Express, Inc.
- IBM, PC/AT, PS/2, and VGA are trademarks of International Business Machines Corporation.

All other product names or trademarks are properties of their respective owners.

Packing List

Before setting up your product, please make sure the following items have been shipped:

Item	Quantity
System kit	1
19V / 90W (65W) adapter	1
Power cord (May vary based on local distribution)	1
Wall Mount Bracket	2
HDD screw, M3 x 8L	4
SATA Cable	1
SATA Power Cable	1
Thermal pad for HDD	2
Thermal PAD DDR2	1

If any of these items are missing or damaged, please contact your distributor or sales representative immediately.

About this Document

This User's Manual contains all the essential information, such as detailed descriptions and explanations on the product's hardware and software features (if any), its specifications, dimensions, jumper/connector settings/definitions, and driver installation instructions (if any), to facilitate users in setting up their product.

Users may refer to the GIGAIPC.com for the latest version of this document.

Safety Precautions

Please read the following safety instructions carefully. It is advised that you keep this manual for future references

1. All cautions and warnings on the device should be noted.
2. Make sure the power source matches the power rating of the device.
3. Position the power cord so that people cannot step on it. Do not place anything over the power cord.
4. Always completely disconnect the power before working on the system's hardware.
5. No connections should be made when the system is powered as a sudden rush of power may damage sensitive electronic components.
6. If the device is not to be used for a long time, disconnect it from the power supply to avoid damage by transient over-voltage.
7. Always disconnect this device from any AC supply before cleaning.
8. While cleaning, use a damp cloth instead of liquid or spray detergents.
9. Make sure the device is installed near a power outlet and is easily accessible.
10. Keep this device away from humidity.
11. Place the device on a solid surface during installation to prevent falls
12. Do not cover the openings on the device to ensure optimal heat dissipation.

13. Watch out for high temperatures when the system is running.
14. Do not touch the heat sink or heat spreader when the system is running
15. Never pour any liquid into the openings. This could cause fire or electric shock.
16. As most electronic components are sensitive to static electrical charge, be sure to ground yourself to prevent static charge when installing the internal components. Use a grounding wrist strap and contain all electronic components in any static-shielded containers.
17. If any of the following situations arises, please the contact our service personnel:
 - i. Damaged power cord or plug
 - ii. Liquid intrusion to the device
 - iii. Exposure to moisture
 - iv. Device is not working as expected or in a manner as described in this manual
 - v. The device is dropped or damaged
 - vi. Any obvious signs of damage displayed on the device
18. This product requires connection to protective earth by means of powercord(s) connected to socket-outlet(s) with protective earthing connection .
- 19. DO NOT LEAVE THIS DEVICE IN AN UNCONTROLLED ENVIRONMENT WITH TEMPERATURES BEYOND THE DEVICE'S PERMITTED STORAGE TEMPERATURES (SEE CHAPTER 1) TO PREVENT DAMAGE.**

FCC Statement

Warning!



This device complies with Part 15 FCC Rules. Operation is subject to the following two conditions: (1) this device may not cause harmful interference, and (2) this device must accept any interference received including interference that may cause undesired operation.

Caution:

There is a danger of explosion if the battery is incorrectly replaced. Replace only with the same or equivalent type recommended by the manufacturer. Dispose of used batteries according to the manufacturer's instructions and your local government's recycling or disposal directives.

Attention:

Il y a un risque d'explosion si la batterie est remplacée de façon incorrecte. Ne la remplacer qu'avec le même modèle ou équivalent recommandé par le constructeur. Recycler les batteries usées en accord avec les instructions du fabricant et les directives gouvernementales de recyclage.

VCCI Statement

この装置は、クラスA機器です。この装置を住宅環境で使用すると電波妨害を引き起こすことがあります。この場合には使用者が適切な対策を講ずるよう要求されることがあります。

VCCI - A

Table Contents

QBiX Industrial Embedded System	1
Quick Start Guide	
Copyright Notice	2
Acknowledgement	3
Packing List.....	4
About this Document	5
Safety Precautions	6
FCC Statement.....	8
VCCI Statement	8
Chapter 1 - Product Specifications	12
1.1 Specifications	14
Chapter 2 – QBiX Industrial Embedded System Kit	16
2.1 Dimension	17
2.2 Getting Familiar with Your Unit.....	18
2.3 A) Wireless Module : How to safely install the Module (Wireless Module inclusion may vary based on local distribution)	20
2.4 B) Memory Installation: DDR4 SO-DIMM	21
2.5 Antenna Installation (Antenna inclusion may vary based on local distribution)	22
2.6 RAL	23
2.7 Support	24
2.8 Safety and Regulatory Information.....	25

Chapter 3 – Hardware Information 26

3.1	Jumpers and Connectors	27
3.2.1	ATX_IN (ATX IN Connector)	30
3.2.2	SATA_PWR (SATA power / eDP power header)	31
3.2.3	EDP (Embedded Display Port Connector)	32
3.2.4	SATA0 (SATA 6.0 Gb/s connector)	33
3.2.5	BATTERY (Battery connector)	34
3.2.6	M2E (E-key, Supports NGFF-2230 (WiFi/BT) Slot).....	35
3.2.7	M2M (M-key, Supports NGFF-2280 (PCIe x4, SATA 6Gb/s)	36
3.2.8	F_USB2_1 (USB 2.0 Header).....	37
3.2.9	USB3_1 (Vertical USB 3.2 Gen 1 connector).....	38
3.2.10	LPC_CN (LPC header, support TPM)	39
3.2.11	F_PANEL (Front panel Connector).....	40
3.2.12	FP_AUDIO (Front panel audio header).....	41
3.2.13	SODIMM1, SODIMM2 (DDR4 SO-DIMM Slot).....	42
3.2.14	CPU FAN (CPU FAN connector)	43
3.2.15	COM (Serial port connector, RS-232/422/485).....	44
3.2.16	FUSB31_1 (Front USB 3.2 Gen 2x1 connector).....	45
3.2.17	DC_IN (Screw type DC Jack connector)	46
3.2.18	USB31_1 (Front USB 3.2 Gen 2x1 connector).....	47
3.2.19	HDMI_21 (HDMI connector).....	48
3.2.20	LAN1, LAN2 (GbE LAN port connector)	49

Chapter 4 – BIOS	50
4.1 Introduction	51
4.2 The Main Menu.....	52
4.3 Advanced	53
4.3.1 TPM Configuration.....	54
4.3.2 SATA And RST Configuration.....	56
4.3.3 CPU Configuration	57
4.3.4 Super I/O Configuration	58
4.3.5 Hardware Monitor	59
4.3.6 S5 RTC Wake Settings	60
4.3.7 AMI Graphic Output Protocol Policy.....	61
4.3.8 CSM Configuration.....	62
4.3.9 NVMe Configuration.....	63
4.3.10 Offboard SATA Controller Configuration	64
4.4 Chipset	65
4.5 Security	66
4.6 Boot.....	69
4.7 Save & Exit	70

Chapter 1

Chapter 1 - Product Specifications

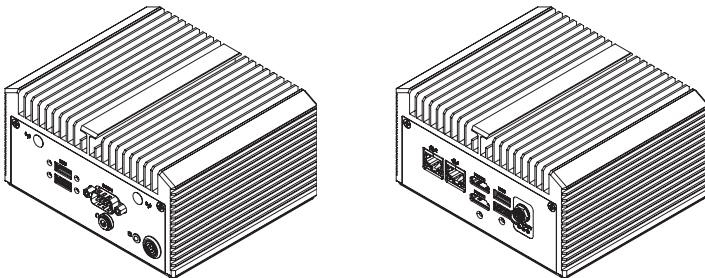

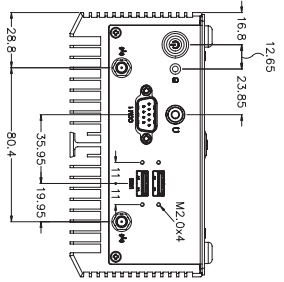
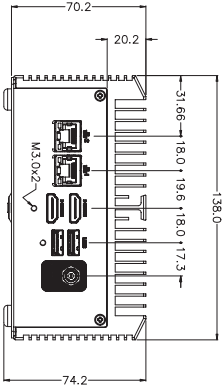
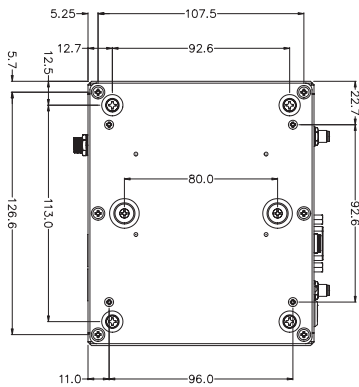
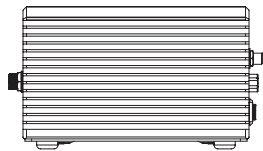
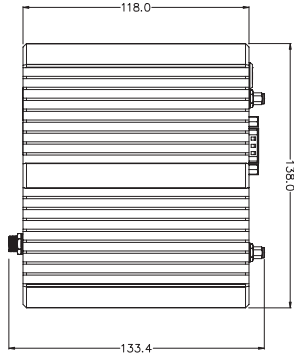
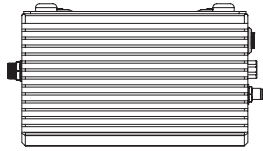

1.1 Specifications

	QBiX- WHLA8565H-A1 (QB-8565A)	QBiX- WHLA8265H-A1 (QB-8265A)	QBiX- WHLA8145H-A1 (QB-8145A)
Dimension	System Size : 138W x 118D x 74.2H (mm)		
CPU	Intel® Core™ i7-8565U Processor 14nm, 4 cores, 8 threads, up to 4.6 GHz, TDP 15W	Intel® Core™ i5-8265U Processor 14nm, 4 cores, 8 threads, up to 3.9 GHz, TDP 15W	Intel® Core™ i3-8145UE Processor 14nm, 2 cores, 4 threads, up to 3.9 GHz, TDP 15W
Chipset	SoC		
Memory	2 x DDR4 SO-DIMM socket, Max. Capacity 64 GB Support Dual Channel DDR4 2400 MHz memory modules		
Ethernet	1 x GbE LAN Port (Intel® I219V) 1 x GbE LAN Port (Realtek® RTL8111HS)		
Graphic support	Integrated Graphics Processor - Intel® UHD Graphics 620: 2 x HDMI 1.4 port, supporting a maximum resolution of 4096x2160 @30Hz (2 independent display outputs)		
Audio	Realtek® Audio Codec		
Storage	1 x 2.5" HDD/SSD (SATA 6 Gb/s)		
Expansion Slots	1 x 2280 M.2 M-Key (PCIe x4, SATA 6Gb/s) 1 x 2230 M.2 E-Key (WiFi/BT) 1 x Vertical USB 3.2 Gen 1		
Front I/O	2 x USB 3.2 Gen 2x1 1 x Power button with LED 2 x External Antenna Holes (Optional) 1 x HDD LED 1 x COM Port (RS-232/422/845) 1 x Headphone Jack		
Rear I/O	2 x HDMI 2 x RJ45 LAN Ports 2 x USB 3.2 Gen 2x1 1 x Screw type DC Jack		
Side I/O	—		
Power	+9V~36VDC (Adapter 19V/90W)		

	QBiX- WHLA8565H-A1 (QB-8565A)	QBiX- WHLA8265H-A1 (QB-8265A)	QBiX- WHLA8145H-A1 (QB-8145A)
Operation temperature	Operating temperature: 0°C to 50°C Operating humidity: 0-90% (non-condensing) Non-operating temperature:-40°C to 85°C Non-operating humidity: 0%-95% (non-condensing) Use wide temperature range memory and storage		
Vibration During Operation	Operation: IEC 60068-2-64, 5 Grms, random, 5 ~ 500 Hz, 1 hr / Per Axis, With SSD Non-operation: IEC 60068-2-6, 2 G, Sine, 10 ~ 500 Hz, 1 Oct/min, 1 hr / Per Axis		
Shock During Operation	Operation: IEC 60068-2-27, 50 G, half sine, 11 ms duration, With SSD		
Packaging Content	Carton size: 416 x 409 x 296 (mm) Packing Capacity: 6pcs Including: PSU ADP 19V 90W 100-240VAC x 1 (P/N: 25EP4-10090A-F3S) Power Cord : Optional (by region) Wall Mount Bracket (P/N: 25HB2-CGAA20-CHR) Screw I Head for 25HDD M3x8L x 4 (P/N: 25KSG-130081-K1R) Thermal PAD HDD x 2 (P/N: 25ST3-200052-T5R) Thermal PAD DRAM x 2 (P/N: 25ST3-200051-T5R) SATA Power cable x 1 (P/N: 25CRI-075630-S9R) SATA cable x 1 (P/N: 25CF4-075500-S9R)		
Order Information	System: 6BQB8565AMR-SI	System: 6BQB8265AMR-SI	System: 6BQB8145AMR-SI

Chapter 2

Chapter 2 – QBiX Industrial Embedded System Kit

2.1 Dimension

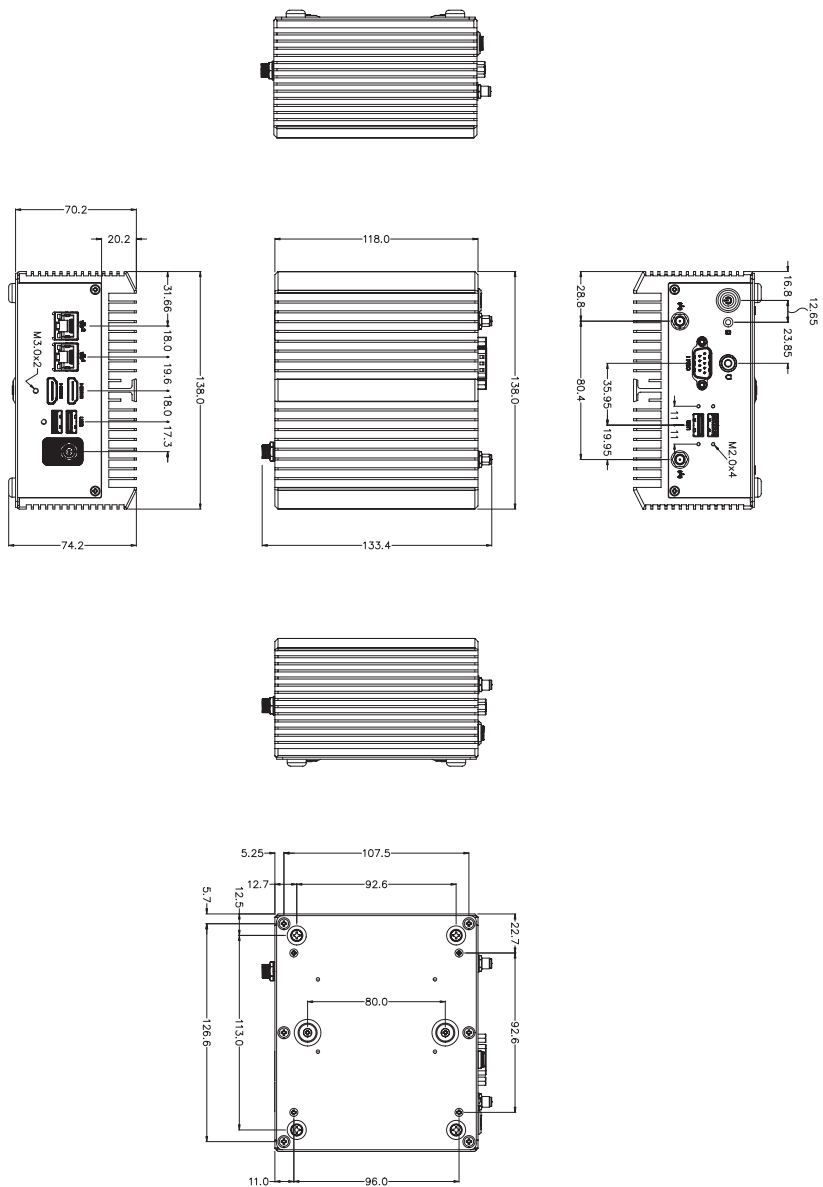

2.2 Getting Familiar with Your Unit

[Front Side]

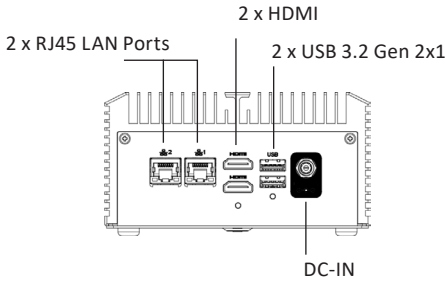

[Left Side]

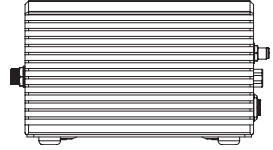

[Rear Side]

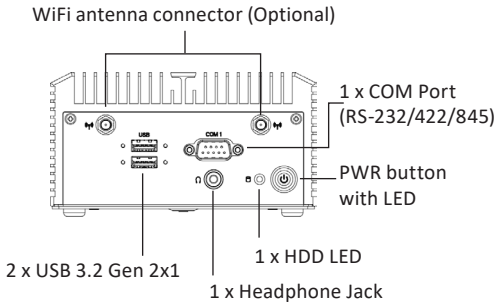

[Right Side]

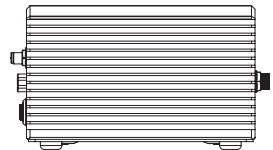

[Bottom Side]

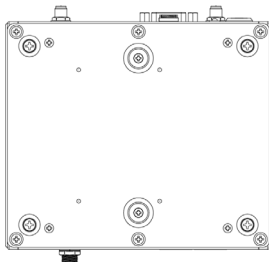

[Install]

- * Before opening the case, make sure to unplug the power cord.
- * 打開機殼前，請確實移除電源。
- * Before Connecting the power, make sure to fasten the case securely.
- * 接上電源前，請確實將機殼完整鎖附。

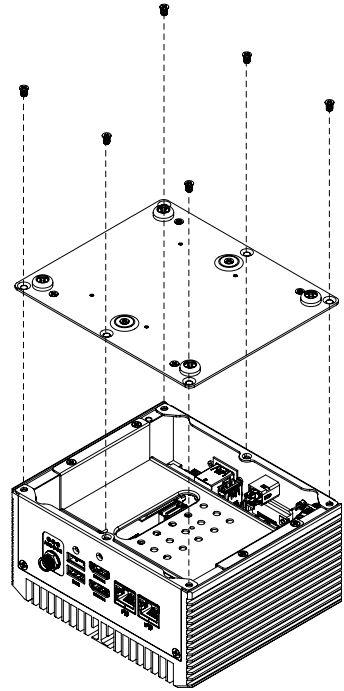

[Bottom PCB Side]

Information	
A	1 x M.2 slot (Support NGFF-2280 SATA/PCIe x4)
B	1 x M.2 slot (Support NGFF-2230 Wifi/BT)
C	2 x DDR4 SO-DIMM socket, Max. Capacity 32 GB

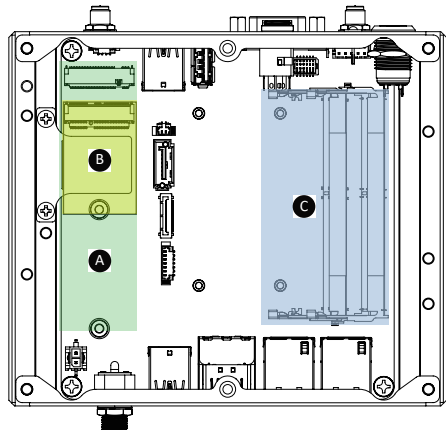

2.3 A) Wireless Module : How to safely install the Module (Wireless Module inclusion may vary based on local distribution)

1

Carefully insert the wireless module into the M.2 slot

小心地將無線模組安裝於M.2插槽中。

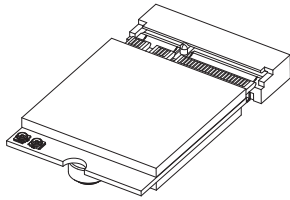

2

Lock the screw in the middle.

鎖入固定於無線模組中央頂端的螺絲。

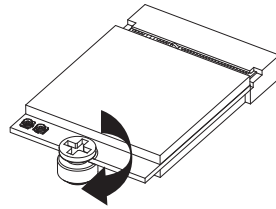

3

Install the antenna on the left side of the connection wireless module down.

向下安裝連結於無線模組左側頂端天線。

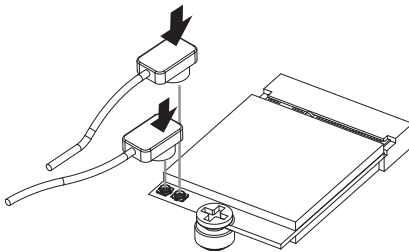

2.4 B) Memory Installation: DDR4 SO-DIMM

①

Carefully insert SO-DIMM memory modules.

小心地由下至上將 SO-DIMM 記憶體安裝於記憶體插槽。

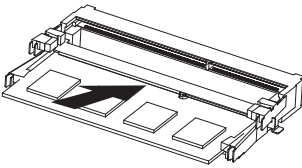

②

Push down until the modules click into place.

當記憶體固定於插槽後，再輕輕下壓至定點。

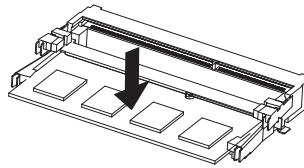

③

Carefully insert SO-DIMM memory modules.

安裝下層記憶體後，重覆前述動作安裝上層記憶體。

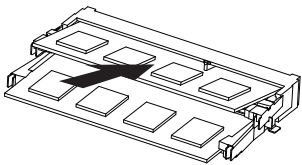

④

Push down until the modules click into place.

當記憶體固定於插槽後，再輕輕下壓至定點。

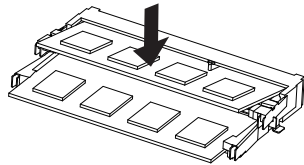

2.5 Antenna Installation (Antenna inclusion may vary based on local distribution)

①

Carefully insert the antennas into the connectors.
小心地將天線插入天線插孔中。

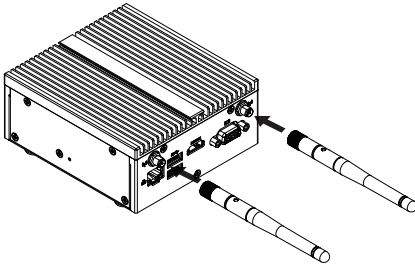

②

Turn the antennas clockwise until they are completely secure on the connectors.
握住天線接頭底端，按順時針方向將天線旋入插孔中牢牢固定。

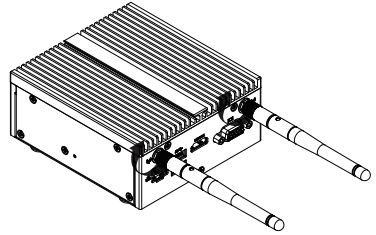

③

Flip up the antenna heads so that they are perpendicular to the machine.
栓緊後請將天線拉起朝上呈垂直狀。

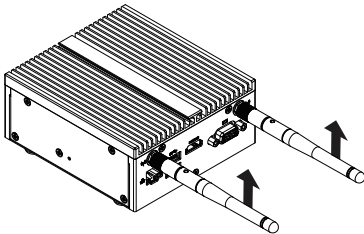

2.6 RAL

This equipment is intended to be used in Restrict Access Location. The access can only be gained by Skilled person.
Only authorized by well trained professional person can access the restrict access location.

2.7 Support

- For a list of tested memory, M.2, 2.5" SSD, wireless adapters and OS supported, go to: <http://www.gigaipc.com>
- To download the latest drivers and BIOS updates, go to: <http://www.gigaipc.com>
- For product support, go to: <http://www.gigaipc.com>

2.8 Safety and Regulatory Information

Risk of explosion if the battery is replaced with an incorrect type. Batteries should be recycled where possible.

Disposal of used Batteries must be in accordance with local environmental regulations.

Failure to use the included Power Adapter may violate regulatory compliance and may expose the user to safety hazards.

HDMI™
HIGH DEFINITION MULTIMEDIA INTERFACE



At the end of its serviceable life, this product should not be treated as household or general waste. It should be handed over to the applicable collection point for the recycling of electrical and electronic equipment, or returned to the supplier for disposal.

Chapter 3

Chapter 3 – Hardware Information

3.1 Jumpers and Connectors

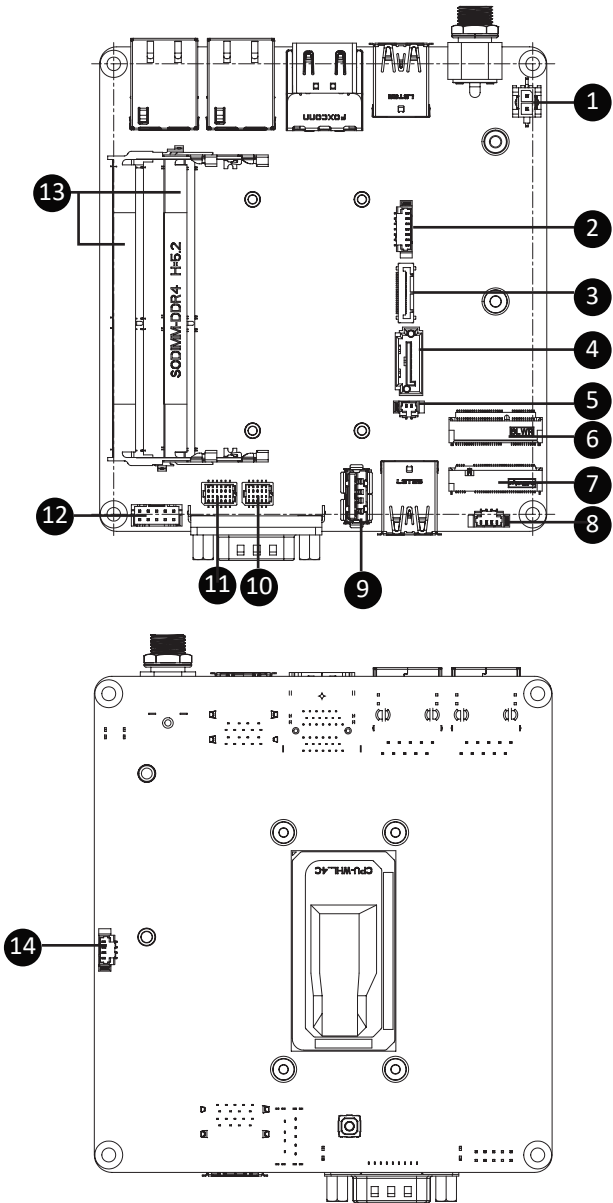

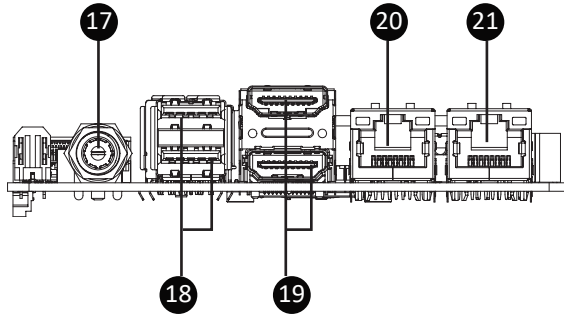
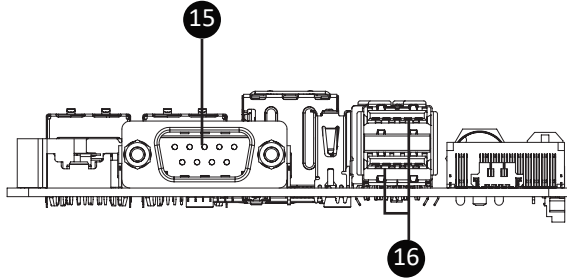

No	Code	Description
1	ATX_IN	ATX IN Connector
2	SATA_PWR	1 x SATA power / eDP power header
3	EDP	Embedded Display Port Connector
4	SATA0	SATA 6.0 Gb/s Connector
5	BATTERY	Battery Cable Connector
6	M2E	E-key, Supports NGFF-2230 (WiFi/BT)
7	M2M	M-key, SATA 6.0 Gb/s, PCIe x4, Supports NGFF-2280 card

No	Code	Description
8	F_USB2_1	USB 2.0 header
9	USB3_1	Vertical USB 3.2 Gen 1 connector
10	LPC_CN	LPC header, support TPM
11	F_PANEL	Front panel header
12	FP_AUDIO	Front panel audio header
13	SODIMM1 SODIMM2	DDR4 SO-DIMM Slot
14	CPU_FAN	CPU FAN Connector
15	COM	Serial port connector (RS-232/422/485)
16	FUSB31_1	Front USB 3.2 Gen 2x1 Port x 2
17	DC_IN	Screw type DC Jack
18	USB31_1	Front USB 3.2 Gen 2x1 Port x 2
19	HDMI_21	HDMI Port
20	LAN1	GbE LAN Port
21	LAN2	GbE LAN Port

3.2.1 ATX_IN (ATX IN Connector)

1

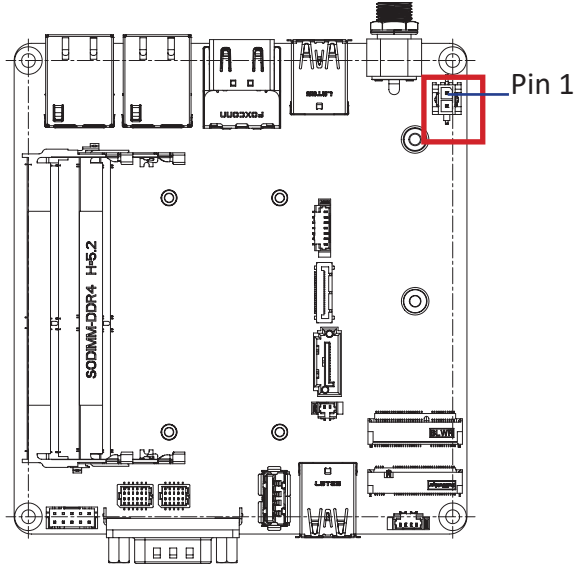

ATX IN Connector

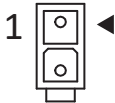

Connector PN

99-01740-B004-A

Vendor

TCONN

Pin No.

Definition

Pin No.	Definition
1	GND
2	DC_IN
G1	GND
G2	GND

3.2.2 SATA_PWR (SATA power / eDP power header)

2

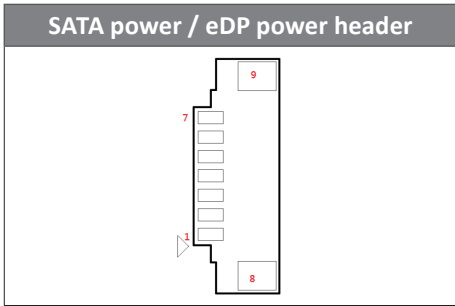
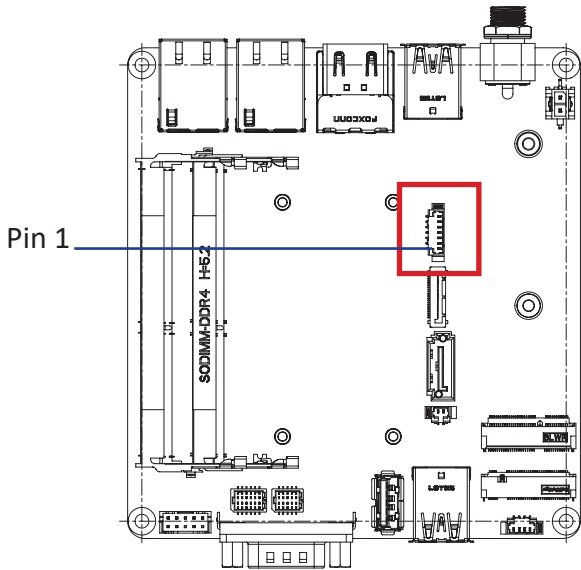

Pin No.	Definition
1	5V
2	5V
3	3V
4	GND
5	GND
6	12V
7	12V
8	GND
9	GND

Connector PN	Vendor
85205-0770N	ACES
A1250WV-S-07PC	JOINT-TECH

Note: *The header will automatically detect its eDP or SATA power function. Please make sure eDP cable PIN 16 must connect to GND.

3.2.3 EDP (Embedded Display Port Connector)

3

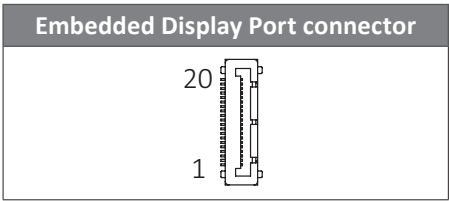
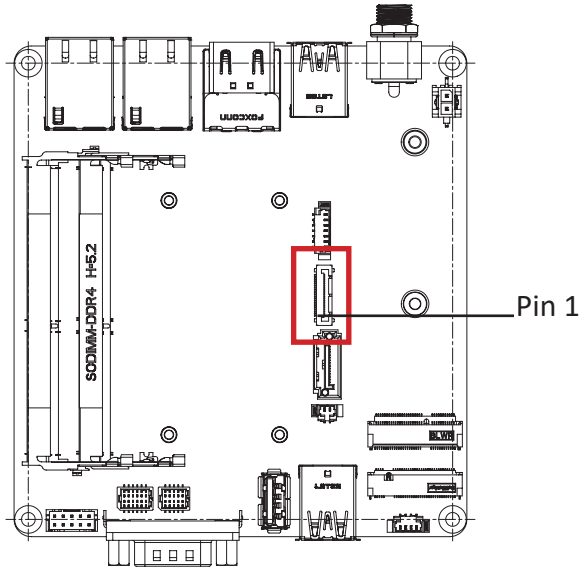

Pin No.	Definition
18	EDP_BKLTEN
19	EDP_VDDEN
20	EDP_BKLTCTL

Pin No.	Definition
1	GND
2	EDP_TX0-
3	EDP_TX0+
4	GND
5	EDP_TX1-
6	EDP_TX1+
7	GND
8	EDP_TX2-
9	EDP_TX2+
10	GND
11	EDP_TX3-
12	EDP_TX3+
13	GND
14	EDP_AUX-
15	EDP_AUX+
16	GND
17	EDP_HPDP

Connector PN	Vendor
115B20-100020-G4-R	STARCONN
CNTH252B2012	CONNECTER

Note: *Please make sure eDP cable PIN 16 must connect to GND.

3.2.4 SATA0 (SATA 6.0 Gb/s connector)

4

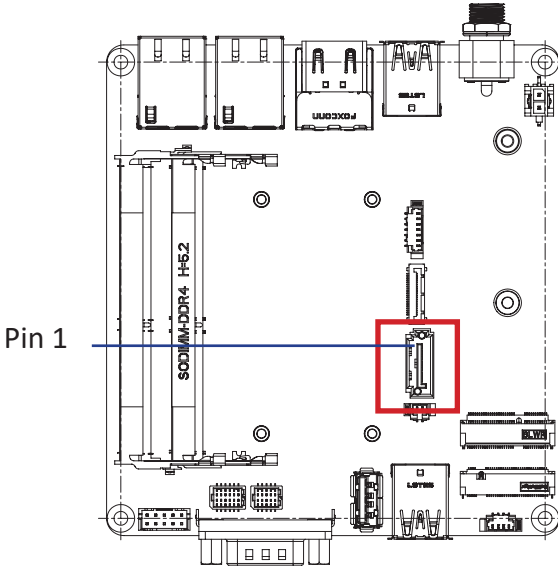

SATA 6.0 Gb/s connector

Connector PN	Vendor
WATF-07DBLBA1UW	WINWIN

Pin No.	Definition
1	GND
2	TXP
3	TXN
4	GND
5	RXN
6	RXP
7	GND

3.2.5 BATTERY (Battery connector)

5

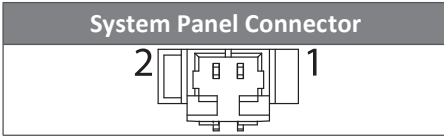
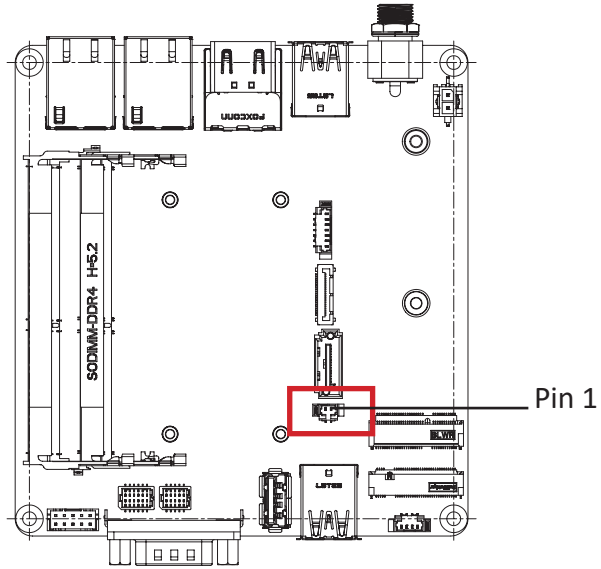

Pin No.	Definition
1	3.3V RTC
2	GND

3.2.6 M2E (E-key, Supports NGFF-2230 (WiFi/BT) Slot)

6

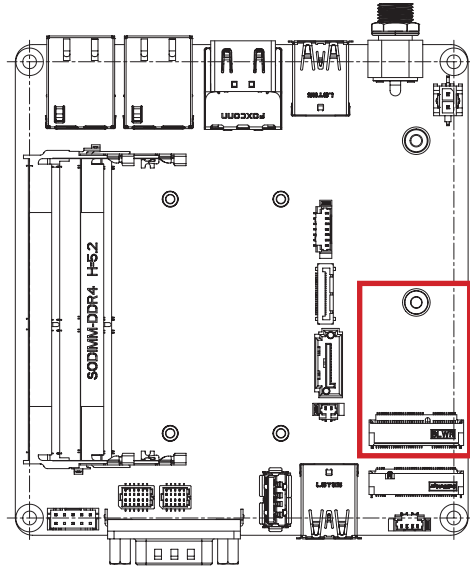

M.2 E Key Connector

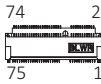

Pin No.	Definition	Pin No.	Definition
1	GND	2	3V
3	USB_D+	4	3V
5	USB_D-	6	NC
7	GND	8	NC
9	NC	10	NC
11	NC	12	NC
13	NC	14	NC
15	NC	16	NC
17	NC	18	GND
19	NC	20	BT_WAKE
21	NC	22	NC
23	NC		

Pin No.	Definition	Pin No.	Definition
33	GND	32	NC
35	WLAN_TXP	34	NC
37	WLAN_TXN	36	NC
39	GND	38	CL_RST#

41	WLAN_RXP	40	CL_DATA
43	WLAN_RXN	42	CL_CLK
45	GND	44	NC
47	CLK_DP	46	NC
49	CLK_DN	48	NC
51	GND	50	SUSCLK
53	CLK_REQ	52	PLT_RST#
55	PCIE_WAKE	54	BT_Disable#
57	GND	56	WIFI_Disable#
59	NC	58	NC
61	NC	60	NC
63	GND	62	NC
65	NC	64	NC
67	NC	66	NC
69	GND	68	NC
71	NC	70	NC
73	NC	72	3V
75	GND	74	3V

Connector PN	Vendor
80152-4221	BELLWETHER

3.2.7 M2M (M-key, Supports NGFF-2280 (PCIe x4, SATA 6Gb/s))

7

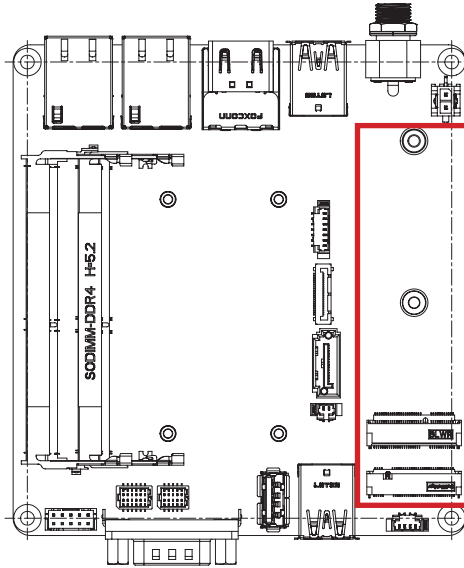

M.2 M Key Connector



Pin No.	Definition	Pin No.	Definition
1	GND	2	3.3V
3	GND	4	3.3V
5	NC	6	NC
7	NC	8	NC
9	GND	10	M2_LED
11	NC	12	3.3V
13	NC	14	3.3V
15	GND	16	3.3V
17	NC	18	3.3V
19	NC	20	NC
21	GND	22	NC
23	NC	24	NC
25	NC	26	NC
27	GND	28	NC
29	PCI_E_RXN	30	NC
31	PCI_E_RXP	32	NC
33	GND	34	NC

Pin No.	Definition	Pin No.	Definition
35	PCI_E_TXN	36	NC
37	PCI_E_TXP	38	DEVSLP
39	GND	40	SMB Clock
41	SATA_RXP	42	SMB DATA
43	SATA_RXN	44	SMB ALERT
45	GND	46	NC
47	SATA_TXN	48	NC
49	SATA_TXP	50	PLT_RST
51	GND	52	CK_REQ
53	CLK_N	54	PCI_E_WAKE#
55	CLK_P	56	NC
57	GND	58	NC

Pin No.	Definition	Pin No.	Definition
67	NC	68	SUSCLK
69	M2_SSD_Detect	70	3.3V
71	GND	72	3.3V
73	GND	74	3.3V
75	GND		

Connector PN	Vendor
80159-8521	BELLWETHER

3.2.8 F_USB2_1 (USB 2.0 Header)

8

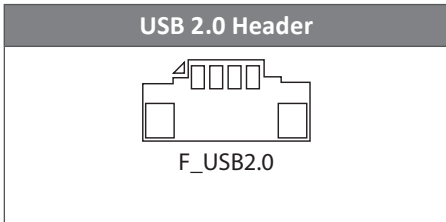
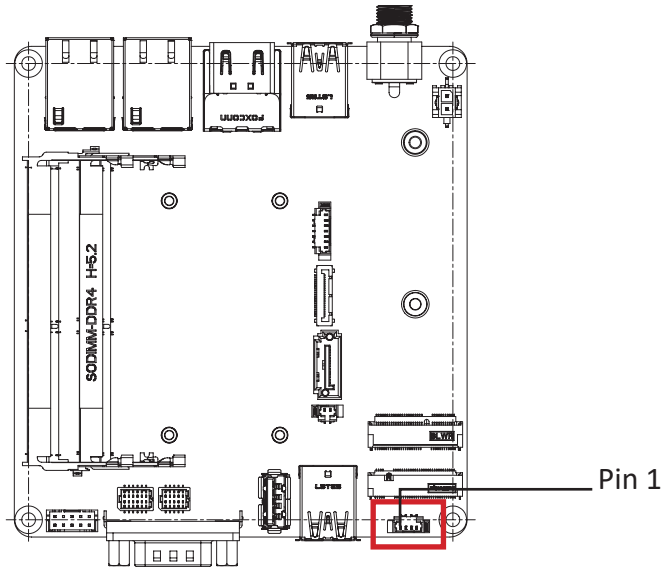

Connector PN	Vendor
A1250WV-S-04PNLBT1T00L	JOINT-TECH
50273-0047N-001	ACES

Pin No.	Definition
1	VCC
2	D- (USBN)
3	D+ (USBP)
4	GND

3.2.9 USB3_1 (Vertical USB 3.2 Gen 1 connector)

9

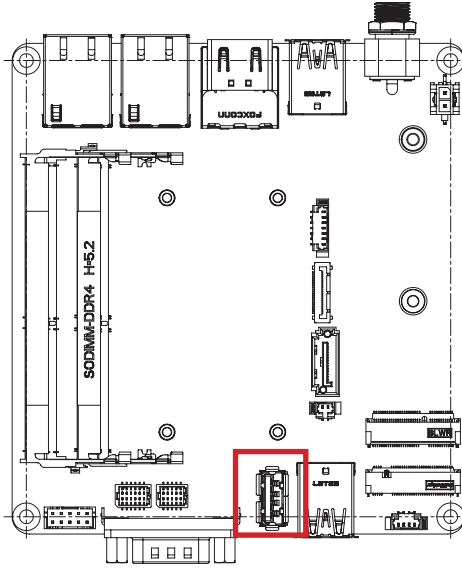

Vertical USB 3.2 Gen 1 connector



Connector PN

ABA-USB-126-P01

Vendor

LOTES

Pin No.	Definition	Pin No.	Definition
1	5V	10	5V
2	USB_D-	11	USB_D-
3	USB_D+	12	USB_D+
4	GND	13	GND
5	USB3_RX-	14	USB3_RX-
6	USB3_RX+	15	USB3_RX+
7	GND	16	GND
8	USB3_TX-	17	USB3_TX-
9	USB3_TX+	18	USB3_TX+

3.2.10 LPC_CN (LPC header, support TPM)

10

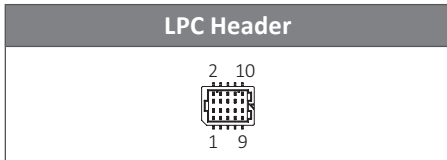
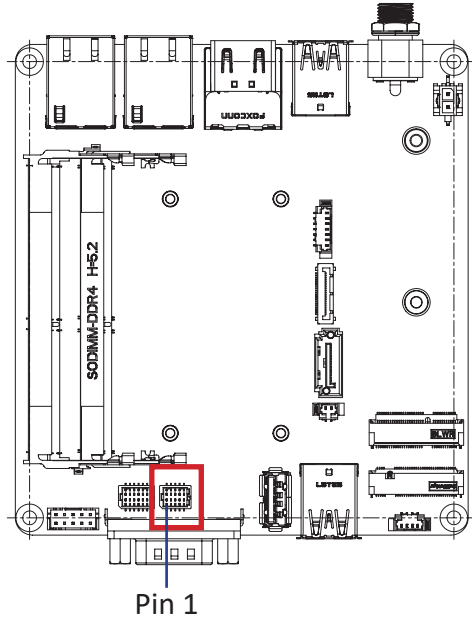

Connector PN	Vendor
87216-1004-06	ACES

Pin No.	Definition
1	CK_LPC1_80H
2	GND
3	LFRAME#
4	LAD0
5	PLT_RST_80H
6	LAD1
7	LAD3
8	LAD2
9	3.3V
10	SERIRQ

3.2.11 F_PANEL (Front panel Connector)

11

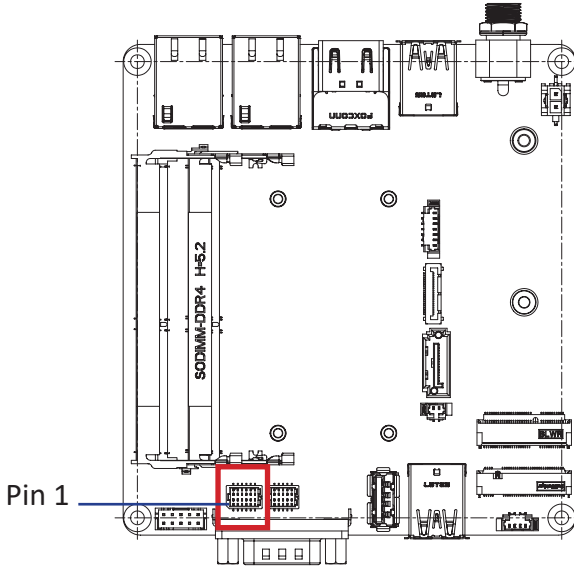

Front Panel Connector

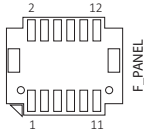

Connector PN

87216-1206-06

Vendor

ACES

Pin No.	Definition
1	SATA_LED_P (3.3V)
2	MPD+
3	GND
4	MPD-
5	GND
6	Panshw_D
7	PMU_RSTBTN_N_D
8	GND
9	5V
10	3.3V
11	5V
12	NC

3.2.12 FP_AUDIO (Front panel audio header)

12

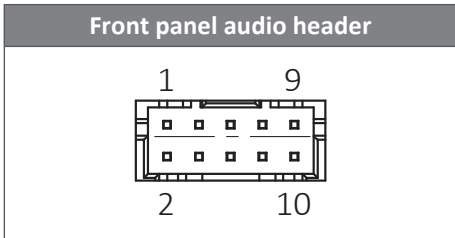
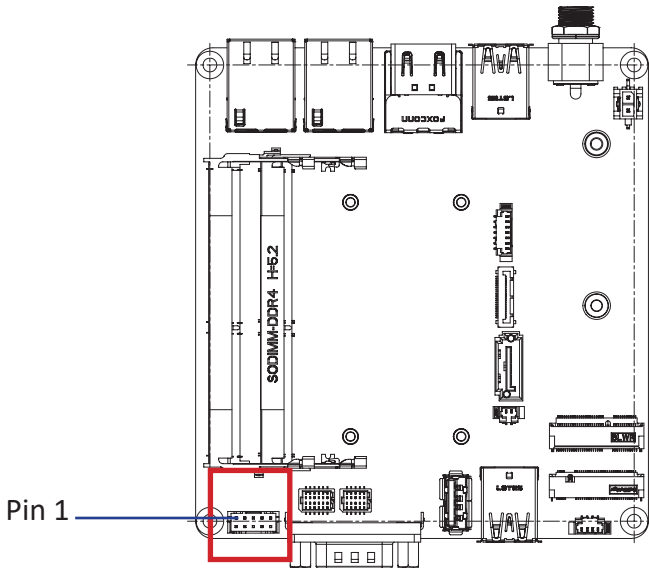

Connector PN	Vendor
725-81-10TW00	PINREX
A2004WV-2X05P46	JOINT-TECH

Pin No.	Definition	Pin No.	Definition
1	F_MIC_L	2	AUD_AGND
3	F_MIC_R	4	NC
5	F_HP_R	6	F_MIC_JD_SENSE
7	FAUDIO_JD_C	8	NC
9	F_HP_L	10	F_HP_JD_SENSE

3.2.14 CPU FAN (CPU FAN connector)

14

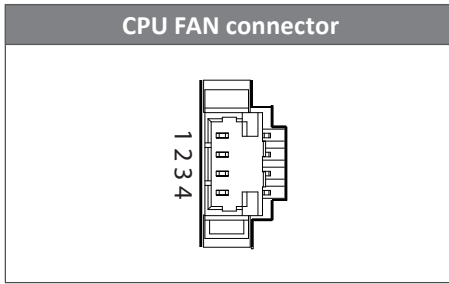
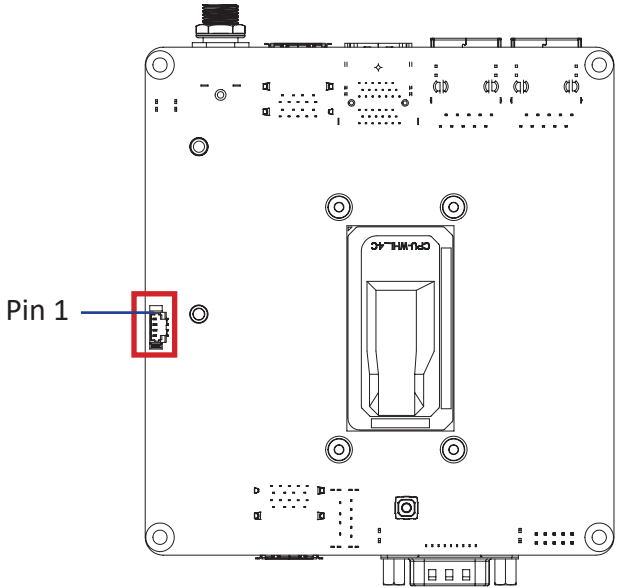

Connector PN	Vendor
85205-0470N	ACES
A1250WV-S-04PC	JOINT-TECH

Pin No.	Definition
1	GND
2	12V
3	TACH_PWRFAN1
4	Speed Control

3.2.15 COM (Serial port connector, RS-232/422/485)

15

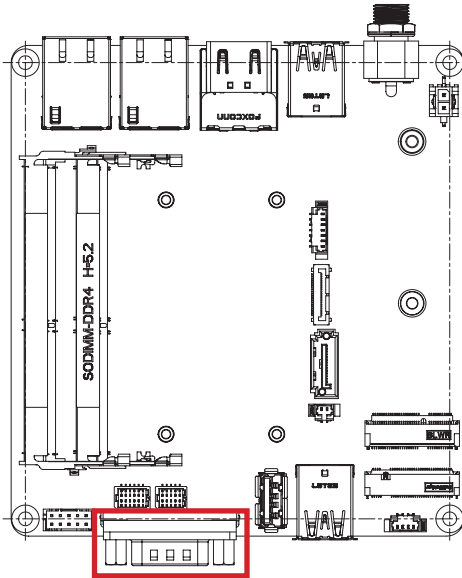

Serial port Connector

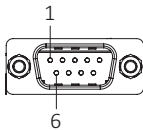

Connector PN

SM41D1P1122N33N1

Vendor

FENYING

Pin No.	RS-232	RS-422 Full Duplex	RS-485 Half Duplex
1	DCD	TXD-	D-
2	RXD	TXD+	D+
3	TXD	RXD+	-
4	DTR	RXD-	-
5	GND		
6	DSR	-	-
7	RTS	-	-
8	CTS	-	-
9	RI	-	-

3.2.16 FUSB31_1 (Front USB 3.2 Gen 2x1 connector)

16

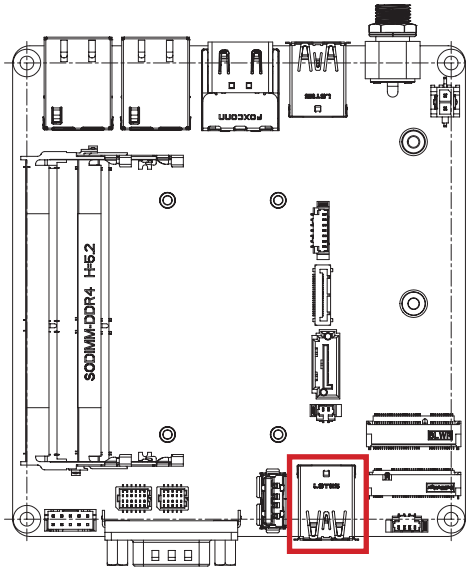

USB 3.2 Gen 2x1 connector

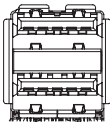

Connector PN

UAA111C-841R1-4H

Vendor

FOXCONN

Pin No.	Definition	Pin No.	Definition
1	5V	10	5V
2	USB_D-	11	USB_D-
3	USB_D+	12	USB_D+
4	GND	13	GND
5	USB3_RX-	14	USB3_RX-
6	USB3_RX+	15	USB3_RX+
7	GND	16	GND
8	USB3_TX-	17	USB3_TX-
9	USB3_TX+	18	USB3_TX+

3.2.17 DC_IN (Screw type DC Jack connector)

17

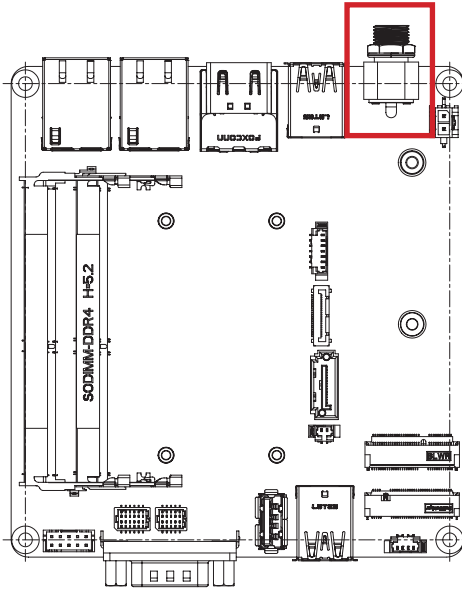

Screw Type DC Jack Connector

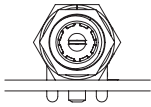

Connector PN	Vendor
655-360-000	SHEN-MING

3.2.18 USB31_1 (Front USB 3.2 Gen 2x1 connector)

18

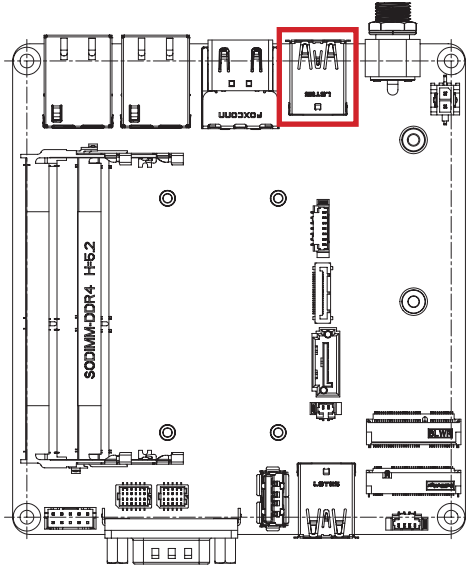

USB 3.2 Gen 2x1 connector

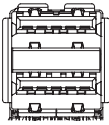

Connector PN

UAA111C-841R1-4H

Vendor

FOXCONN

Pin No.	Definition	Pin No.	Definition
1	5V	10	5V
2	USB_D-	11	USB_D-
3	USB_D+	12	USB_D+
4	GND	13	GND
5	USB3_RX-	14	USB3_RX-
6	USB3_RX+	15	USB3_RX+
7	GND	16	GND
8	USB3_TX-	17	USB3_TX-
9	USB3_TX+	18	USB3_TX+

3.2.19 HDMI_21 (HDMI connector)

19

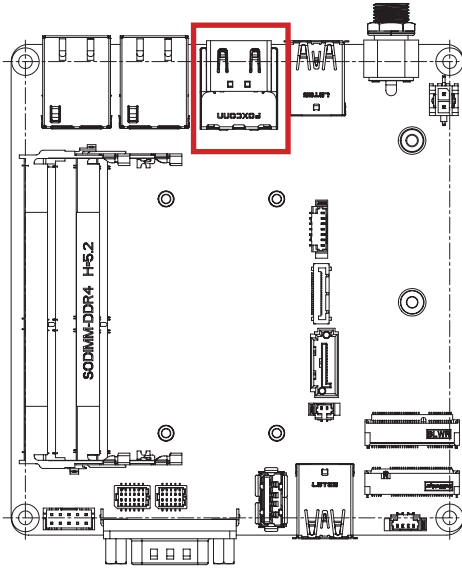

HDMI Connector

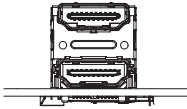

Connector PN

QJ11191-DFB1-4F

Vendor

FOXCONN

Pin No.	Definition	Pin No.	Definition
1	HDMI_D2+	13	NC
2	GND	14	NC
3	HDMI_D2-	15	HDMI_SCL
4	HDMI_D1+	16	HDMI_SDA
5	GND	17	GND
6	HDMI_D1-	18	5V
7	HDMI_D0+	19	HDMI_HPD
8	GND		
9	HDMI_D0-		
10	HDMI_CLK+		
11	GND		
12	HDMI_CLK-		

3.2.20 LAN1, LAN2 (GbE LAN port connector)

20 21

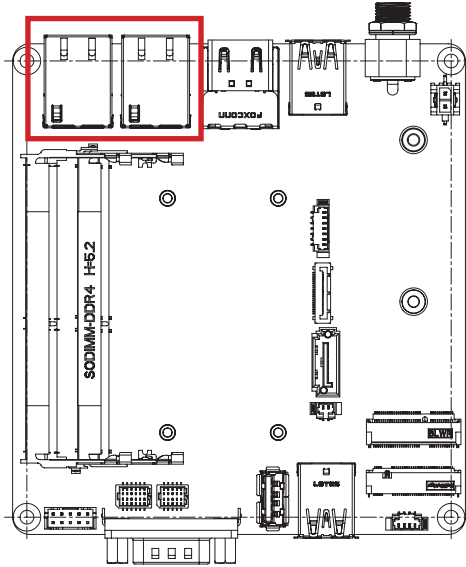

LAN Connector

Link / Activity LED Connection / Speed LED

Pin No.	Definition
1	TX+ _D1
2	TX- _D1
3	RX+ _D2
4	BI+ _D3
5	BI- _D3
6	RX- _D2
7	BI+ _D4
8	BI- _D4

State	Description
Orange On	1Gbps data rate
Green On	100Mbps data rate
Off	10Mbps data rate

Connector PN	Vendor
RT7-GB-0003	UDE

Chapter 4

Chapter 4 – BIOS

4.1 Introduction

BIOS (Basic input/output system) provides hardware detailed information and boot-up options, which include firmware to control, set-up and test all hardware settings. Therefore, BIOS is the communication bridge between OS/application software and hardware.

4.1.1 How to Entering into BIOS menu

Once the system is power on, press the key as soon as possible to access into BIOS Setup program.

4.1.2 Function Keys to setup in BIOS Setup program

Function keys	Description
→←	Select Screen
↑↓	Select Item
Enter	Execute command or enter the submenu
+	Increase the numeric value or make changes
—	Decrease the numeric value or make changes
F1	General Help
F2	Previous Values
F3	Load Optimized Defaults Settings
F4	Save changes & Exit the BIOS Setup program
ESC	Exit the BIOS Setup program

4.2 The Main Menu

The main menu shows the basic system information. Use arrow keys to move among the items.

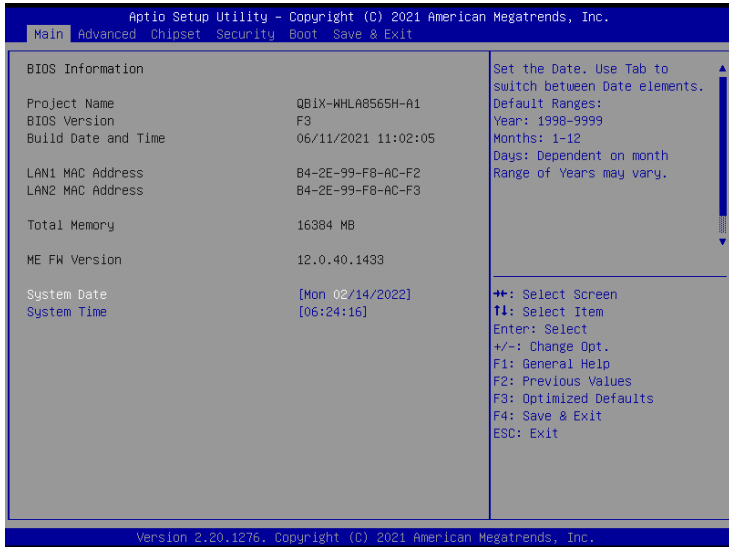

Items	Description
Project Name	Shows Project name information
BIOS Version	Shows the BIOS version of the system
Build Date and Time	Shows the Build Date and Time when the BIOS was created.
LAN1 MAC Address	Shows LAN 1 MAC Address information
LAN2 MAC Address	Shows LAN 2 MAC Address information
Total Memory	Shows the total memory size of the installed memory
ME FW version	Shows ME firmware version
System Date	Set the Date for the system (Format : Week - Month - Day - Year)
System Time	Set the time for the system (Format : Hour - Minute - Second)

4.3 Advanced

The Advanced menu is to configure the functions of hardware settings through submenu. Use arrow keys to move among the items, and press <Enter> to access into the related submenu.

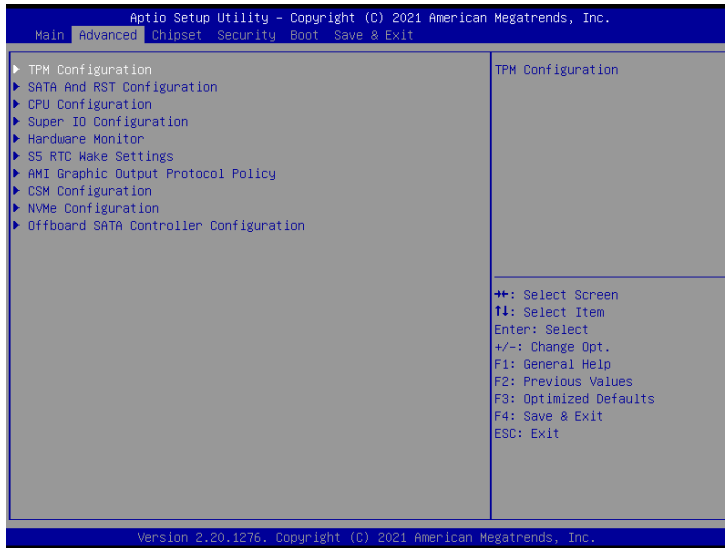

4.3.1 TPM Configuration

Use TPM Configuration submenu to choose TPM interface.

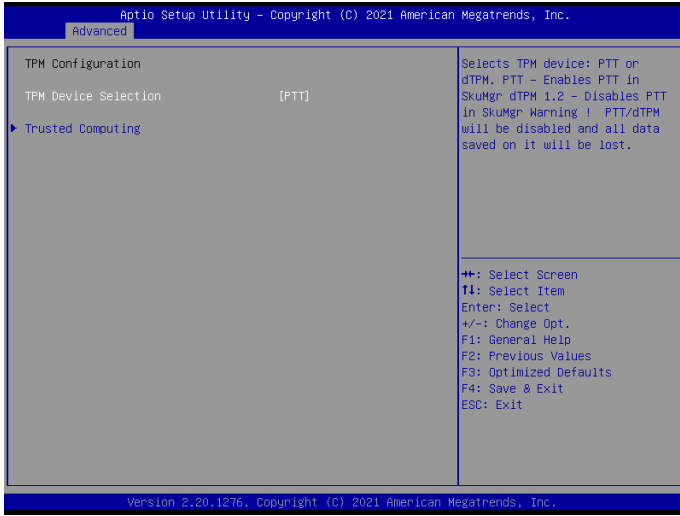

Item	Description
<p>TPM Device Selection</p>	<p>PTT : Internal TPM (Default setting) dTPM : External TPM (When using External TPM module or having TPM chip on MB)</p>

Trusted Computing : Shows TPM information, and TPM module configuration setting.

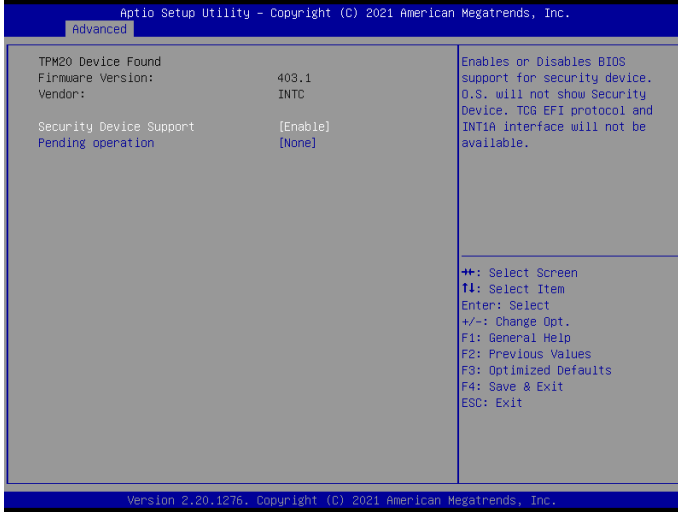

Item	Description
Security Device support	Enabled : Enables TPM feature (Default setting) Disabled : Disables TPM feature
Item	Description
Pending operation	None : No execution will be conducted (Default setting) TPM clear : Set to clear data on TPM

4.3.2 SATA And RST Configuration

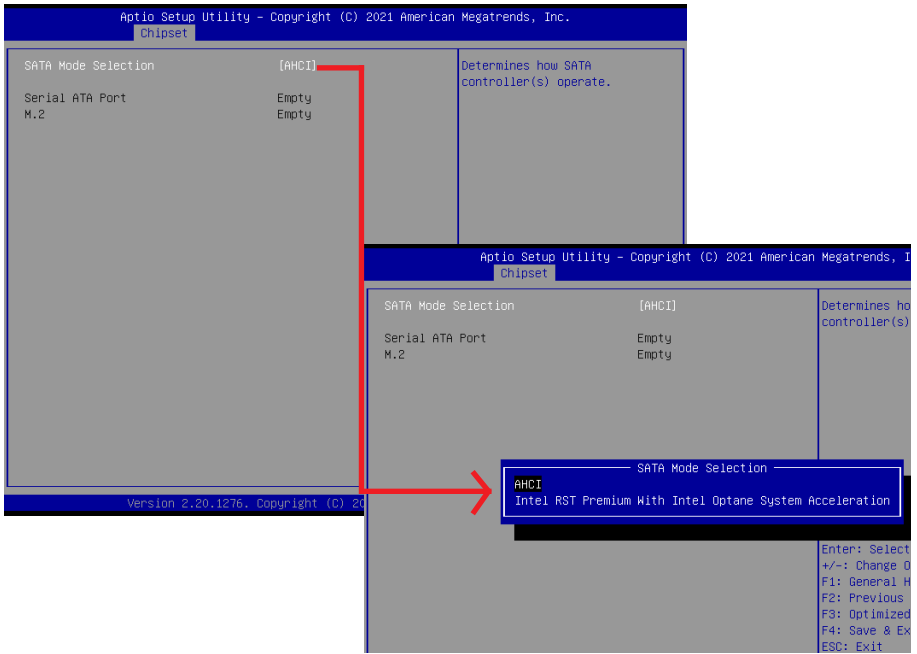

Item	Description
SATA Mode Selection	AHCI : Configures the SATA controllers to AHCI mode. (Default setting) Intel RST Premium With Intel Optane System Acceleration : Enables RAID mode for the SATA controller
Serial ATA Port	shows 2.5" SATA HDD/SSD information
M.2	shows M.2 SATA interface SSD information

4.3.3 CPU Configuration

This submenu shows detailed CPU informations.

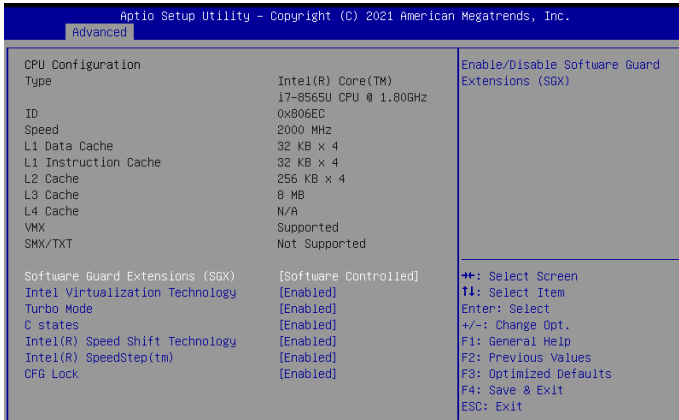

Item	Description
Software Guard Extensions (SGX)	Disabled : Disables Software Guard Extensions (SGX) Enabled : Enables Software Guard Extensions (SGX) Software Controlled : If this item is selected, SGX will be controlled by SGX application for UEFI boot OS (Default setting)
Intel (VMX) Virtualization Technology	Virtualization enhanced by Intel® Virtualization Technology will allow a platform to run multiple operating systems and applications in independent partitions. With virtualization, one computer system can function as multiple virtual systems. Enabled : Enables Intel Virtualization Technology (Default setting) Disabled : Disables Intel Virtualization Technology
Turbo Mode	Enabled : Enables Turbo Mode (Default setting) Disabled : Disables Turbo Mode
C states	Command CPU to enter into low power consumption mode when CPU is under idle mode. Enabled : Enables C states (Default setting) Disabled : Disables C states
Intel(R) Speed Shift Technology	To speed up CPU frequency transition time from basic frequency to maximum frequency. Enabled : Enables Intel(R) Speed Shift Technology Interrupt control (Default setting) Disabled : Disables Intel(R) Speed Shift Technology Interrupt control
Intel(R) SpeedStep(tm)	According to Intel CPU loading, Intel SpeedStep Technology will automatically adjust the CPU voltage and core frequency to decrease heat and power consumption for power saving. Enabled : Enables Intel SpeedStep Technology (Default setting) Disabled : Disables Intel SpeedStep Technology
CFG Lock	Enabled : Configure MSR 0xE2[15] , CFG Lock bit (Default setting) Disabled : Disables CFG Lock

4.3.4 Super I/O Configuration

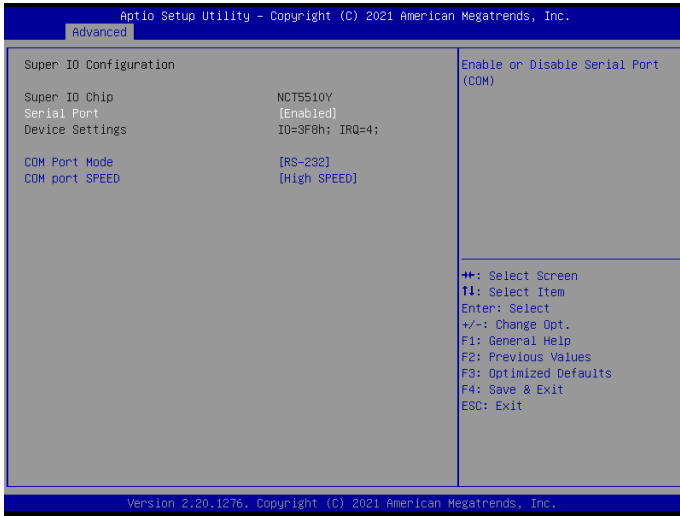

Item	Description
Super IO Chip	Shows Super I/O chip model
Serial Port	Enable or Disable Serial Port Enabled : Enables allows you to configure the serial port settings Disabled : if Disabled, displays no configuration for the serial port
Device settings	Display the specified Serial Port base I/O address and IRQ
COM Port Mode	Choose RS-232, RS-422, or RS-485 feature
COM port SPEED	Choose COM Port Speed Low Speed : 250Kbps for RS-232/422/485 High Speed : 1.5Mbps for RS-232, 10Mbps for RS-422/485 (Default setting)

4.3.5 Hardware Monitor

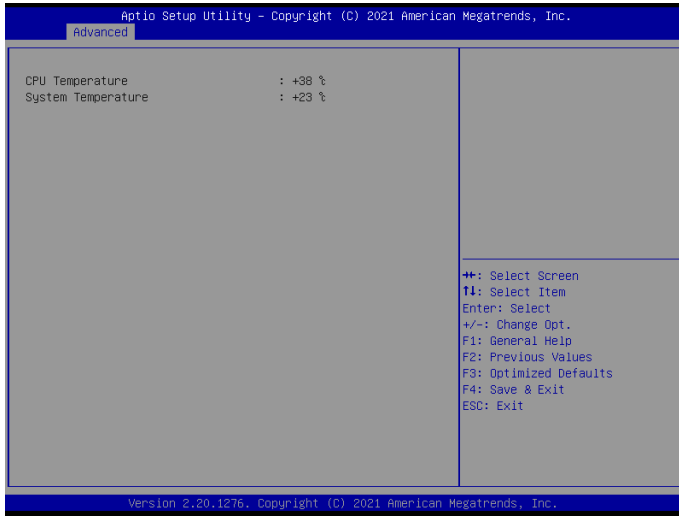

Item	Description
CPU temperature	Shows current CPU temperature
System temperature	Shows current system temperature

4.3.6 S5 RTC Wake Settings

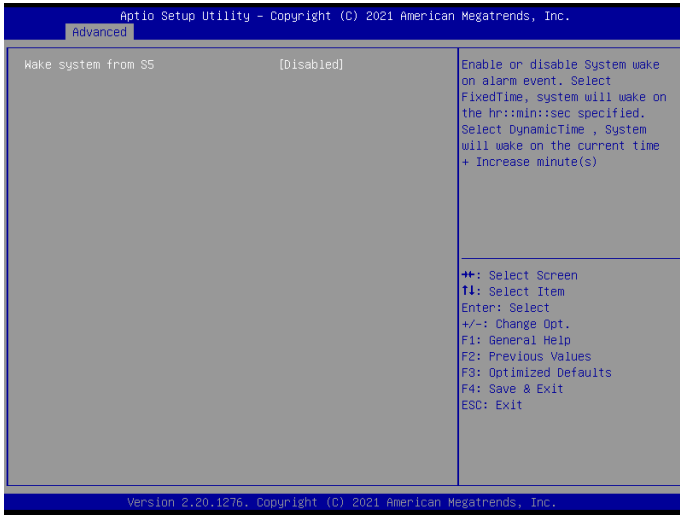

Item	Description
Wake system from S5	Enable or Disable System to wake on a specific time. Disabled : Disables system to wake on a specific time (Default setting) Fixed Time : Enables system to wake on a specific time (Format : hr : min : sec)

4.3.7 AMI Graphic Output Protocol Policy

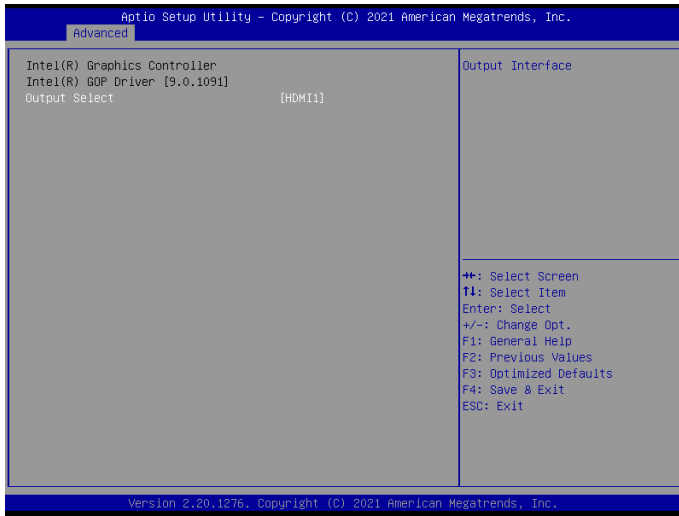

Item	Description
Output Select	Choose default monitor output when there are more than one monitor plugged on the motherboard.

4.3.8 CSM Configuration

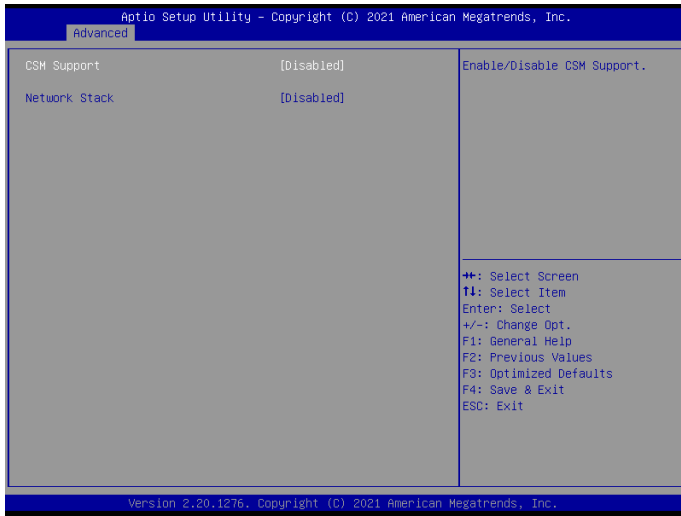

Item	Description
CSM Support	Choose UEFI or Legacy Mode Disabled : UEFI Mode only (Default setting) Enabled : Enables Legacy Mode feature
Network Stack	When system is power on, install LAN driver under UEFI mode Disabled : Disables UEFI Network Stack (Default setting) Enabled : Enables UEFI Network Stack

4.3.9 NVMe Configuration

NVMe Configuration shows information when your M.2 NVMe PCIe SSD is installed.

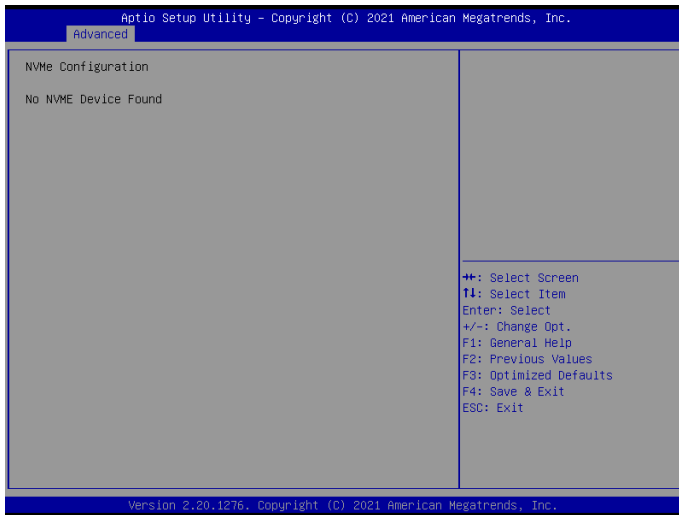

4.3.10 Offboard SATA Controller Configuration

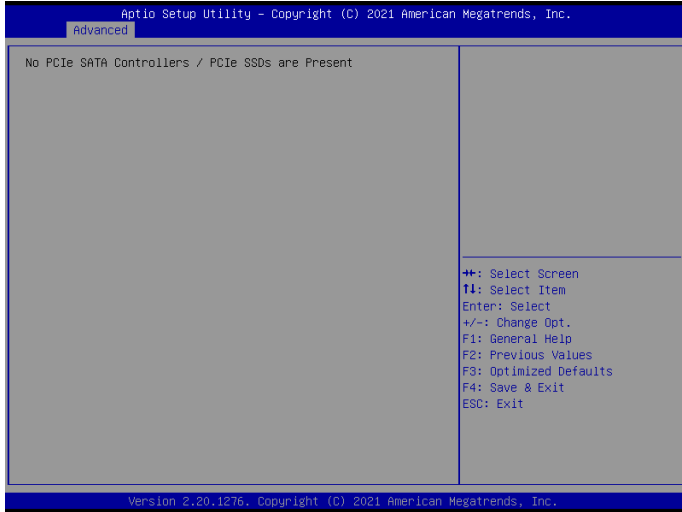

4.4 Chipset



Item	Description
VT-d	Enabled : Enables VT-d function (Default setting) Disabled : Disables VT-d function
DVMT Pre-Allocated	Use DVMT Pre-Allocated to set the amount of system memory which is installed to the integrated graphics processor Option items : 32M , 64M(Default setting)
Onboard LAN1 Onboard LAN2	Enable/Disable onboard LAN controller Enabled : Enables onboard LAN controller (Default setting) Disabled : Disables onboard LAN controller
Onboard Audio	Enable/Disable onboard audio controller Enabled : Enables onboard audio controller (Default setting) Disabled : Disables onboard audio controller
ERP Lowest Power State Mode	Enable/Disable power saving function Enabled : Enables ERP Lowest Power State Mode Disabled : Disabled ERP Lowest Power State Mode (Default setting)
Restore AC Power Loss	To set which option the system should returns if a sudden power loss occurred Power off : Do not power on when the power is back (Default setting) Power on : System power on when the power is back Last state : Restore the system to the state before power loss occurs
XHCI Hand-off	Enable/Disable XHCI Hand-off function Enabled : Enables XHCI Hand-off function (Default setting) Disabled : Disables XHCI Hand-off function
Watchdog Timer	Enable/Disable Watchdog Timer function Enabled : Enables Watchdog Timer function Disabled : Disabled Watchdog Timer function (Default setting)
BIOS Lock	Enable/Disable BIOS Lock function Enabled : Enables BIOS Lock function (Default setting) Disabled : Disabled BIOS Lock function

4.5 Security

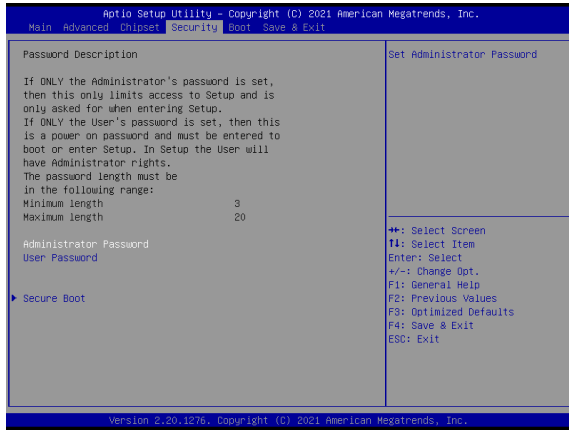

Item	Description
Administrator Password	To set up Administrator's password Minimum length : 3 Maximum length : 20
User Password	To set up User's password Minimum length : 3 Maximum length : 20
Secure Boot	Press <Enter> to configure the advanced items

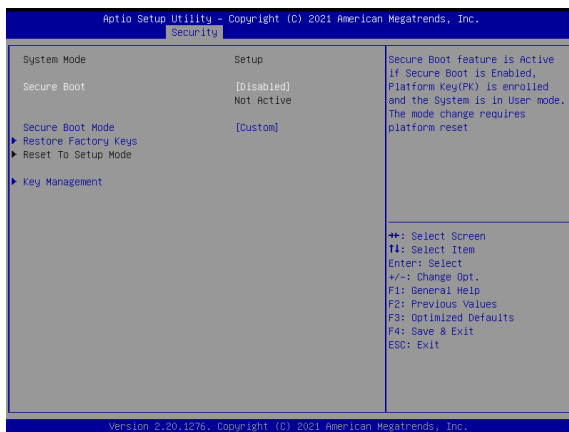

Item	Description
Secure Boot	Secure Boot requires all the applications that are running during the booting process to be pre-signed with valid digital certificates Enabled : Enables Secure Boot function Disabled : Disables Secure Boot function (Default setting)
Secure Boot Mode	Standard : Standard mode Custom : Custom mode (Default setting)
Restore Factory Keys	To restore factory settings Yes : Agree to restore factory settings No : Cancel to restore factory settings
Reset To Setup Mode	Yes : Agree to setup mode No : Cancel to setup mode
Key Management	Enables expert users to modify Secure boot policy variables without full authentication Press <Enter> to configure the advanced items

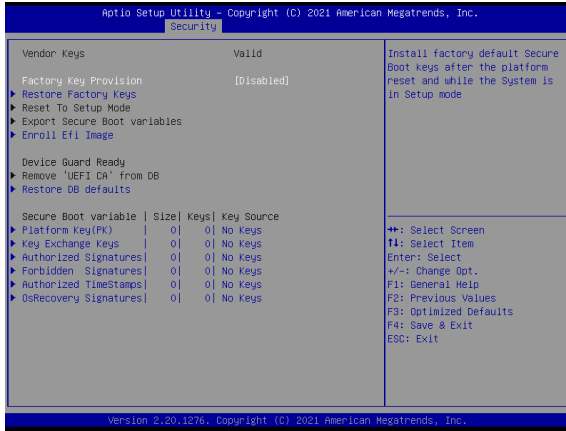

Item	Description	Item	Description
Factory Key Provision	Install factory default Secure Boot keys after the platform reset and while the system is in Setup mode Enabled : Enables Factory Key Provision (Default setting) Disabled : Disables Factory Key Provision	Platform Key (PK)	These items allows you to enroll factory defaults or load Certificates from a file.
		Key Exchange Keys	
Restore Factory Keys	To restore factory settings Yes : Agree to restore factory settings No : Cancel to restore factory settings	Authorized Signatures	
		Forbidden Signatures	
Reset To Setup Mode	Yes : Agree to setup mode No : Cancel to setup mode	Authorized TimeStamps	
Export Secure Boot variables	Copy NVRAM content of Secure Boot variables to files in a root folder on a file system device	OsRecovery Signatures	
Enroll Efi Image	Allow the image to run in Secure Boot mode		
Remove 'UEFI CA' from DB	To remove 'UEFI CA' from database Yes : Agree to remove 'UEFI CA' from database No : Cancel to remove 'UEFI CA' from database		
Restore DB defaults	Restore DB variables to factory defaults Yes : Agree to restore DB defaults No : Cancel to restore DB defaults		

4.6 Boot

This Boot menu allows you to set/change system boot options

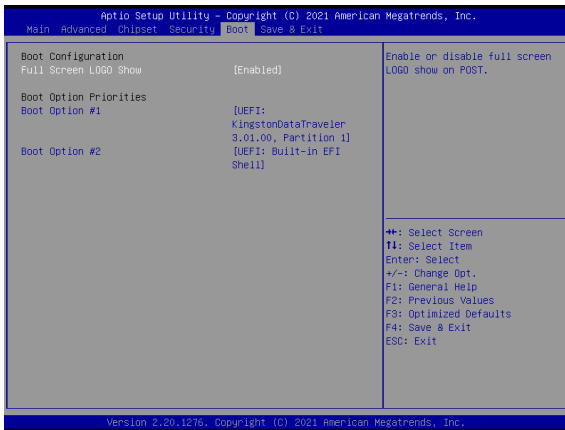

Item	Description
Full Screen LOGO Show	Enable/Disable full screen LOGO show on POST screen Enabled : Enables Full screen LOGO Show on POST screen Disabled : Disables Full screen LOGO Show on POST screen (Default setting)
Boot Option #1 Boot Option #2	Shows the information of the storage that be installed in the system Choose/set the boot priority

4.7 Save & Exit

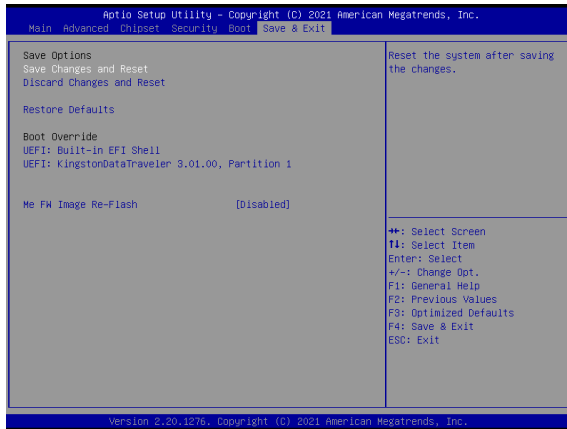

Item	Description
Save Changes and Reset	After configuring all the options that you wish to change, choose this option to save all the changes and reboot the system Yes : Agree to save and reset No : Cancel to save and reset
Discard Changes and Reset	Choose this option to reboot the system without saving any changes Yes : Agree to discard changes and reset No : Cancel to discard changes and reset
Restore Defaults	Restore/Load default values for all the setup options Yes : Agree to load optimized defaults No : Cancel to load optimized defaults
Me FW Image Re-Flahs	Enable/Disable Me FW image re-flash function Enabled : Enables Me FW image re-flash function Disabled : Disables Me FW image re-flash function (Default setting)