



# EC51x-CS

Box PC

User's Manual

## Copyright

This publication contains information that is protected by copyright. No part of it may be reproduced in any form or by any means or used to make any transformation/adaptation without the prior written permission from the copyright holders.

This publication is provided for informational purposes only. The manufacturer makes no representations or warranties with respect to the contents or use of this manual and specifically disclaims any express or implied warranties of merchantability or fitness for any particular purpose. The user will assume the entire risk of the use or the results of the use of this document. Further, the manufacturer reserves the right to revise this publication and make changes to its contents at any time, without obligation to notify any person or entity of such revisions or changes.

Changes after the publication's first release will be based on the product's revision. The website will always provide the most updated information.

© 2021. All Rights Reserved.

## Trademarks

Product names or trademarks appearing in this manual are for identification purpose only and are the properties of the respective owners.

## FCC and DOC Statement on Class B

This equipment has been tested and found to comply with the limits for a Class B digital device, pursuant to Part 15 of the FCC rules. These limits are designed to provide reasonable protection against harmful interference when the equipment is operated in a residential installation.

This equipment generates, uses and can radiate radio frequency energy and, if not installed and used in accordance with the instruction manual, may cause harmful interference to radio communications. However, there is no guarantee that interference will not occur in a particular installation. If this equipment does cause harmful interference to radio or television reception, which can be determined by turning the equipment off and on, the user is encouraged to try to correct the interference by one or more of the following measures:

- Reorient or relocate the receiving antenna.
- Increase the separation between the equipment and the receiver.
- Connect the equipment into an outlet on a circuit different from that to which the receiver is connected.
- Consult the dealer or an experienced radio TV technician for help.

## Notice:

1. The changes or modifications not expressly approved by the party responsible for compliance could void the user's authority to operate the equipment.
2. Shielded interface cables must be used in order to comply with the emission limits.

# Table of Contents

Chapter 1 - Introduction.....	6
Panel Overview .....	9
Chapter 2 - Hardware Installation.....	10
System Memory .....	10
Installing the SO-DIMM Module .....	11
Chapter 3 - BIOS Settings.....	12
Overview .....	12
Main.....	13
Advanced .....	13
RC ACPI Configuration.....	14
CPU Configuration.....	14
Power & Performance.....	15
PCH-FW Configuration .....	15
Trusted Computing.....	18
NCT6116D Super IO Configuration .....	18
NCT6116D HW Monitor .....	19
Serial Port Console Redirection .....	20
USB Configuration .....	21
CSM Configuration .....	22
USB Power Control.....	22
Network Stack Configuration.....	23
Chipset .....	24
Graphics Configuration .....	24
PEG Port Configuration.....	25
PCH-IO Configuration.....	26
PCI Express Configuration .....	26
SATA And RST Configuration .....	27
HD Audio Configuration .....	27
Security .....	28
Secure Boot.....	28
Boot .....	29
Save & Exit .....	29
Updating the BIOS.....	30
Notice: BIOS SPI ROM.....	30
Chapter 4 - Intel AMT Settings.....	31
Overview .....	31
Enable Intel® AMT in the AMI BIOS .....	31
Entering Management Engine BIOS Extension (MEBX) .....	32
MEBX.....	33
Main Menu .....	33
Intel(R) ME General Settings .....	33
Intel(R) AMT Configuration.....	35
Chapter 5 - RAID.....	46
RAID Levels Explanation.....	46
Setup Procedure.....	46

## About this Manual

This manual can be downloaded from the website. The manual is subject to change and update without notice, and may be based on editions that do not resemble your actual products. Please visit our website or contact our sales representatives for the latest editions.

## Warranty

1. Warranty does not cover damages or failures that arised from misuse of the product, inability to use the product, unauthorized replacement or alteration of components and product specifications.
2. The warranty is void if the product has been subjected to physical abuse, improper installation, modification, accidents or unauthorized repair of the product.
3. Unless otherwise instructed in this user's manual, the user may not, under any circumstances, attempt to perform service, adjustments or repairs on the product, whether in or out of warranty. It must be returned to the purchase point, factory or authorized service agency for all such work.
4. We will not be liable for any indirect, special, incidental or consequential damages to the product that has been modified or altered.

## Static Electricity Precautions

It is quite easy to inadvertently damage your PC, system board, components or devices even before installing them in your system unit. Static electrical discharge can damage computer components without causing any signs of physical damage. You must take extra care in handling them to ensure against electrostatic build-up.

1. To prevent electrostatic build-up, leave the system board in its anti-static bag until you are ready to install it.
2. Wear an antistatic wrist strap.
3. Do all preparation work on a static-free surface.
4. Hold the device only by its edges. Be careful not to touch any of the components, contacts or connections.
5. Avoid touching the pins or contacts on all modules and connectors. Hold modules or connectors by their ends.



### Important:

Electrostatic discharge (ESD) can damage your processor, disk drive and other components. Perform the upgrade instruction procedures described at an ESD workstation only. If such a station is not available, you can provide some ESD protection by wearing an antistatic wrist strap and attaching it to a metal part of the system chassis. If a wrist strap is unavailable, establish and maintain contact with the system chassis throughout any procedures requiring ESD protection.

## Safety Precautions

- Use the correct DC / AC input voltage range.
- Unplug the power cord before removing the system chassis cover for installation or servicing. After installation or servicing, cover the system chassis before plugging in the power cord.
- There is danger of explosion if battery incorrectly replaced.
- Replace only with the same or equivalent specifications of batteries recommend by the manufacturer.
- Dispose of used batteries according to local ordinance.
- Keep this system away from humid environments.
- Make sure the system is placed or mounted correctly and stably to prevent the chance of dropping or falling may cause damage.
- The openings on the system shall not be blocked and shall be kept in distance from

other objects to make sure of proper air ventilation to protect the system from overheating.

- Dress the cables, especially the power cord, so they will not be stepped on, in contact with high temperature surfaces, or cause any tripping hazards.
- Do not place anything on top of the power cord. Use a power cord that has been approved for use with the system and is compliant with the voltage and current ranges required by the system's electrical specifications.
- If the system is to be unused or stored for a long time, disconnect it from the power source to avoid damage by transient overvoltage.
- If one of the following occurs, consult a service personnel:
  - The power cord or plug is damaged.
  - Liquid has penetrated the system.
  - The system has been exposed to moisture.
  - The system is not working properly.
  - The system is physically damaged.
- The unit uses a three-wire ground cable which is equipped with a third pin to ground the unit and prevent electric shock. Do not defeat the purpose of this pin. If your outlet does not support this kind of plug, contact your electrician to replace the outlet.
- Disconnect the system from the electricity outlet before cleaning. Use a damp cloth for cleaning the surface. Do not use liquid or spray detergents for cleaning.
- The equipment power supply cord shall be connected to a socket-outlet with earthing connection.
- This product is intended to be supplied by a UL listed (Certificate) power supply, output rated 24Vdc, 11.67A minimum, Tma 60 degree C minimum and altitude 2000m, if need further assistance, please contact manufacture or UL File owner or brand owner further information.

## Chapter 1 - Introduction

### SPECIFICATION

<b>SYSTEM</b>	<b>Processor</b>	8th/9th Generation Intel® Core™ Processors, LGA 1151 Intel® Core™ i7-9700TE , Octa Cores, 12M Cache, up to 3.8 GHz, 35W Intel® Core™ i5-9500TE , Hexa Cores, 9M Cache, up to 3.6 GHz, 35W Intel® Core™ i3-9100TE, Quad Cores, 6M Cache, up to 3.2 GHz, 35W Intel® Core™ i7-8700T Processor, Hexa Core, 12M Cache, 2.4GHz (4GHz), 35W Intel® Core™ i5-8500T Processor, Hexa Core, 9M Cache, 2.1GHz (3.5GHz), 35W Intel® Core™ i3-8100T Processor, Quad Core, 6M Cache, 3.1GHz, 35W Intel® Pentium® Processor G5400T, Dual Core, 4M Cache, 3.1GHz, 35W Intel® Celeron® Processor G4900T, Dual Core, 2M Cache, 3.1GHz, 35W	
	<b>Chipset</b>	Intel® Q370/H310 Chipset	
	<b>Memory</b>	Two 260-pin DDR4 2400/2666MHz SODIMM up to 64GB	
	<b>BIOS</b>	AMI SPI 128Mbit	
<b>GRAPHICS</b>	<b>Controller</b>	Intel® HD Graphics	
	<b>Feature</b>	OpenGL up to 5.0, DirectX 11, OpenCL 2.1 HW Decode: HEVC/H.265, H.264, M/JPEG, MPEG2, VC1/WMV9, VP8 (8-bit), VP9 (10-bit) HW Encode: HEVC/H.265, M/JPEG, MPEG2, VP8	
	<b>Display</b>	-EC51x-CS6G86E-Q/EC51x-CS6G86-Q 1 x VGA 2 x HDMI/DP++ (auto detection) -EC51x-CS98A1-H 1 x VGA 1 x HDMI/DP++ (auto detection)	VGA: resolution up to 1920x1200 @ 60Hz HDMI: resolution up to 4096x2160 @ 30Hz DP++: resolution up to 4096x2304 @ 60Hz
	<b>Double/Triple Displays</b>	-EC51x-CS6G86E-Q/EC51x-CS6G86-Q VGA + 2 x HDMI/DP++ (auto detection) -EC51x-CS98A1-H VGA + 1 x HDMI/DP++ (auto detection)	
<b>STORAGE</b>	<b>Interface</b>	2 x 2.5" SATA 3.0 drive bay support RAID 0/1 (EC51x-CS6G86E-Q/EC51x-CS6G86-Q)	

<b>EXPANSION</b>	<b>Interface</b>	-EC510-CS6G86E-Q/EC510-CS6G86-Q 1 x M.2 2230 E key (PCIe/USB 2.0) 1 x M.2 2280 M key (PCIe x4 NVMe/SATA) 1 x M.2 3042/3052 B key (PCIe/USB 3.0) 1 x PCI slot -EC510-CS98A1-H 1 x M.2 2230 E key (PCIe/USB 2.0) 1 x M.2 2280 M key (SATA) 1 x M.2 3042/3052 B key (PCIe) 1 x PCI slot -EC511-CS6G86E-Q/EC511-CS6G86-Q 1 x M.2 2230 E key (PCIe/USB 2.0) 1 x M.2 2280 M key (PCIe x4 NVMe/SATA) 1 x M.2 3042/3052 B key (PCIe/USB 3.0) 1 x PCIe x16 slot -EC511-CS98A1-H 1 x M.2 2230 E key (PCIe/USB 2.0) 1 x M.2 2280 M key (SATA) 1 x M.2 3042/3052 B key (PCIe) 1 x PCIe x16 slot
	<b>AUDIO</b>	ALC888
	<b>ETHERNET</b>	<b>Controller</b> -EC51x-CS6G86E-Q/EC51x-CS6G86-Q 1 x Intel® I210AT PCIe (10/100/1000Mbps) 1 x Intel® I219LM with iAMT11.0 PCIe (10/100/1000Mbps) (only Core i7/i5 supports iAMT) -EC51x-CS98A1-H 1 x Intel® I210AT PCIe (10/100/1000Mbps) 1 x Intel® I219V with iAMT11.0 PCIe (10/100/1000Mbps) (only Core i7/i5 supports iAMT)
<b>LED</b>	<b>Indicators</b>	1 x Status LED 1 x HDD LED
<b>FRONT I/O</b>	<b>Serial</b>	4 x RS-232/422/485 (DB-9)
	<b>USB</b>	2 x USB 2.0 (type A)
	<b>Buttons</b>	1 x Power button 1 x Reset button
<b>REAR I/O</b>	<b>Antenna</b>	4 x Antenna hole (WiFi)
	<b>Ethernet/PoE</b>	-EC51x-CS6G86E-Q 2 x GbE (RJ-45) 4 x PoE (RJ-45) -EC51x-CS6G86-Q 6 x GbE (RJ-45) -EC51x-CS98A1-H 2 x GbE (RJ-45)
	<b>COM</b>	-EC51x-CS6G86E-Q/EC51x-CS6G86-Q 2 x RS232 -EC51x-CS98A1-H 3 x RS232/422/485 2 x RS232

<b>REAR I/O</b>	<b>Ethernet/PoE</b>	-EC51x-CS6G86E-Q 2 x GbE (RJ-45) 4 x PoE (RJ-45) -EC51x-CS6G86-Q 6 x GbE (RJ-45) -EC51x-CS98A1-H 2 x GbE (RJ-45)
	<b>COM</b>	-EC51x-CS6G86E-Q/EC51x-CS6G86-Q 2 x RS232 -EC51x-CS98A1-H 3 x RS232/422/485 2 x RS232
	<b>USB</b>	-EC51x-CS6G86E-Q/EC51x-CS6G86-Q 4 x USB 3.1(Gen.2) 2 x USB2.0 -EC51x-CS98A1-H 4 x USB 3.1(Gen.2) 4 x USB 3.1(Gen.1)
	<b>DIO</b>	-EC51x-CS6G86E-Q/EC51x-CS6G86-Q 16 bits DIO -EC51x-CS98A1-H 8 bits DIO
	<b>Display</b>	-EC51x-CS6G86E-Q/EC51x-CS6G86-Q VGA + 2 x HDMI/DP++ (auto detection) -EC51x-CS6G86E-Q/EC51x-CS6G86-Q VGA + 1 x HDMI/DP++ (auto detection)
	<b>Audio</b>	1 x Line-out 1 x Mic-in
	<b>WATCHDOG TIMER</b>	<b>Output &amp; Interval</b>
<b>SECURITY</b>	<b>TPM</b>	TPM 2.0
<b>POWER</b>	<b>Type</b>	Wide range 9~36V
	<b>Connector</b>	3-pole terminal block 2-pin power extension switch connector
<b>OS SUPPORT</b>	<b>OS Support</b>	Windows 10 IoT Enterprise 64 Bit Linux (available upon request)
<b>ENVIRONMENT</b>	<b>Operating Temperature</b>	-20 to 60°C (2.5" SSD or M.2 SSD)
	<b>Storage Temperature</b>	-20 to 85°C
	<b>Relative Humidity</b>	5 to 95% RH (non-condensing)
<b>MECHANICAL</b>	<b>Construction</b>	Metal + Aluminum
	<b>Mounting</b>	Wall mount
	<b>Dimensions (W x H x D)</b>	255.3 x 124.6 x 224mm
	<b>Weight</b>	5.1 kg
<b>STANDARDS AND CERTIFICATIONS</b>	<b>Shock</b>	Half sine wave 3G, 11ms, 3 shock per axis
	<b>Vibration</b>	IEC68-2-64
	<b>Certifications</b>	CE, FCC Class A



► Panel Overview

Front View

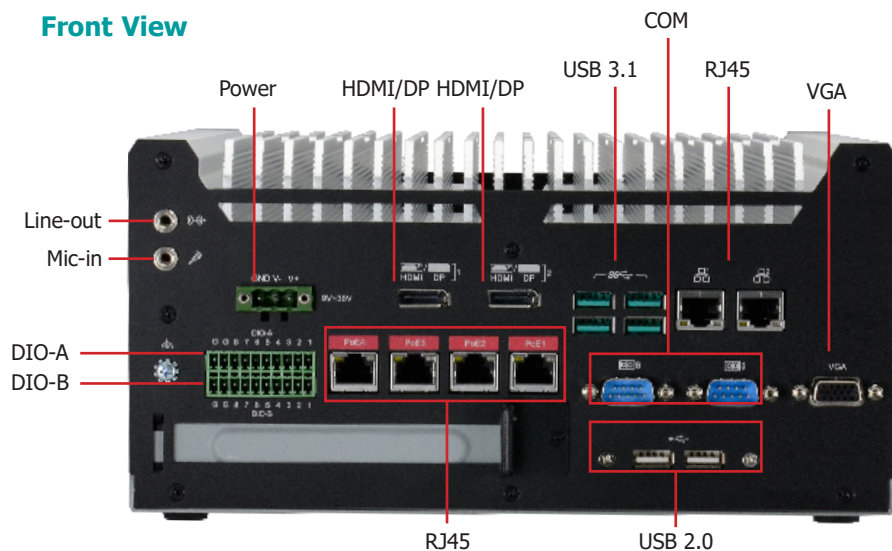

Rear View

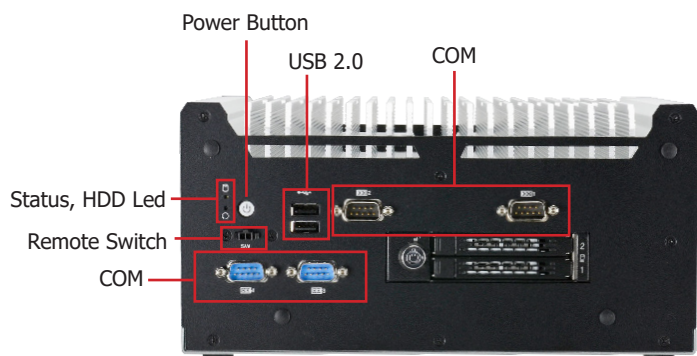

**Notes:**

1. Please gently press the power button to avoid possible damages.
2. The HDMI is a DP/HDMI combo port but can only transmit HDMI signals (unless wired as a DP port by request). Please plug in an HDMI cable with the right orientation and alignment to avoid damage to the connector. You should feel resistance (due to a pin on the right) if the cable is not inserted correctly.

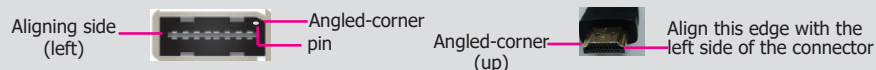

I/O Ports

**Power Button with LED (Green)**

Press to power on or power off the system.

**Reset Button**

Press to reset the system.

**HDD LED (Red)**

Indicates the status of disk drives.

HDD LED		
HDD State	Disk access activity	Disk drives present or not present
LED Behavior	Blink	Off

**Status LED (Orange)**

Indicates system status as below.

Status LED				
Suspend Mode	S0	S1	S3	S4, S5
LED Behavior	Always ON	Quick Blink (cycle 1 sec)	Slow Blink (cycle >1 sec)	Off

**SATA 1 /SATA 2**

Install SATA drives into the system.

**Remote Power-on/Power-off Switch Connector**

Connects distant power on/off switch.

**USB 3.1 Ports**

Connect to USB 3.1 as well as devices based on previous USB versions.

**COM and DIO Ports**

All COM ports can be selected among RS232, RS422 and RS485.

COM1~COM2 and COM4~COM5 can be selected between RS232 and RS232 with power via jumper settings; COM3 and COM6 are normal RS232 ports.

The DIO port provides 8-bit digital input/output.

**HDMI / VGA Connector**

Connects the HDMI / VGA connector of an LCD monitor.

**Line-out and Microphone Ports**

Connect audio devices such as microphones and speakers.

**Gigabit LAN Ports**

Connect the system to a local area network.

**DC-in**

DC 9~36V power input via a terminal block connector.

## Chapter 2 - Hardware Installation

### ► System Memory

The system board supports the following memory interface.

#### Single Channel (SC)

Data will be accessed in chunks of 64 bits from the memory channels.

#### Dual Channel (DC)

Data will be accessed in chunks of 128 bits from the memory channels. Dual channel provides better system performance because it doubles the data transfer rate.

#### Single Channel

DIMMs are on the same channel. DIMMs in a channel can be identical or completely different. However, we highly recommend using identical DIMMs. Not all slots need to be populated.

#### Dual Channel

DIMMs of the same memory configuration are on different channels.

#### Features

- Two 260-pin SODIMM up to 32GB
- Dual Channel DDR4, 2400MHz

To install the system memory, please remove the bottom cover first, then reverse the box pc and remove 12 screws marked in red rectangle at each side:

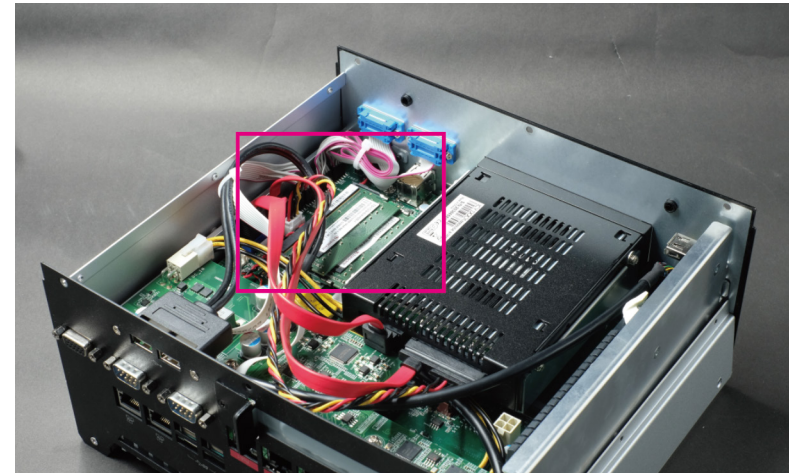

The slots of memory module are located in the pink rectangle.

► System Memory

Installing the SO-DIMM Module

Before installing the memory module, please make sure that the following safety cautions are well-attended.

1. Make sure the PC and all other peripheral devices connected to it has been powered down.
2. Disconnect all power cords and cables.
3. Locate the SO-DIMM socket on the system board
4. Make sure the notch on memory card is aligned to the key on the socket.

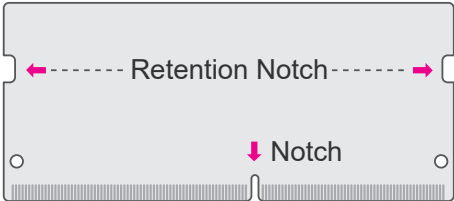

«« DDR4 SO-DIMM

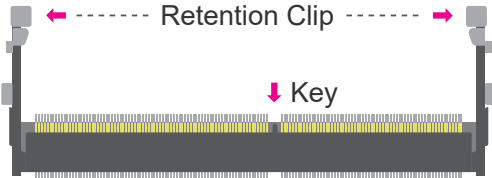

«« Socket Top View

Please follow the steps below to install the memory card into the socket.

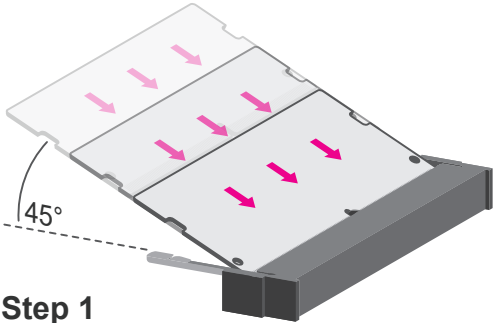

Step 1

**Step 1:**  
 Insert the memory card into the slot while making sure 1) the notch and the key are aligned, and 2) the non-connector end rises approximately 45 degrees horizontally. Press the card firmly into the socket while applying and maintaining even pressure on both ends.

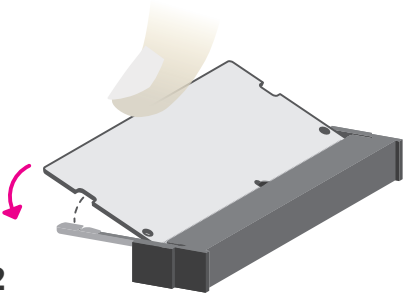

Step 2

**Step 2:**  
 Press the end of the card far from the socket down while making sure the retention notch and the clip align as indicated by the dotted line in the illustration. If the retention notch and the clip do not align, please remove the card and re-insert it. Press the card all the way down.

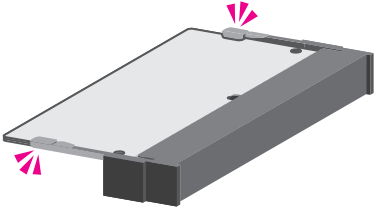

Step 3

**Step 3:**  
 The clips snap automatically and abruptly to the retention notches of the card sounding a distinctive click, and lock the card in place. Inspect that the clip sits in the notch. If not, please pull the clips outward, release and remove the card, and mount it again.

## Chapter 3 - BIOS Settings

### ► Overview

The BIOS is a program that takes care of the basic level of communication between the CPU and peripherals. It contains codes for various advanced features found in this system board.

The BIOS allows you to configure the system and save the configuration in a battery-backed CMOS so that the data retains even when the power is off. In general, the information stored in the CMOS RAM of the EEPROM will stay unchanged unless a configuration change has been made such as a hard drive replaced or a device added.



#### Note:

The BIOS is constantly updated to improve the performance of the system board; therefore the BIOS screens in this chapter may not appear the same as the actual one. These screens are for reference purpose only.

It is possible that the CMOS battery will fail causing CMOS data loss. If this happens, you need to install a new CMOS battery and reconfigure the BIOS settings.

#### Default Configuration

Most of the configuration settings are either predefined according to the Load Optimal Defaults settings which are stored in the BIOS or are automatically detected and configured without requiring any actions. There are a few settings that you may need to change depending on your system configuration.

#### Entering the BIOS Setup Utility

The BIOS Setup Utility can only be operated from the keyboard and all commands are keyboard commands. The commands are available at the right side of each setup screen.

The BIOS Setup Utility does not require an operating system to run. After you power up the system, the BIOS message appears on the screen and the memory count begins. After the memory test, the message "Press DEL to run setup" will appear on the screen. If the message disappears before you respond, restart the system or press the "Reset" button. You may also restart the system by pressing the <Ctrl> <Alt> and <Del> keys simultaneously.

#### Legends

Keys	Function
Right / Left arrow	Move the highlight left or right to select a menu
Up / Down arrow	Move the highlight up or down between submenus or fields
<Enter>	Enter the highlighted submenu
+ (plus key)/F6	Scroll forward through the values or options of the highlighted field
- (minus key)/F5	Scroll backward through the values or options of the highlighted field
<F1>	Display general help
<F9>	Optimized defaults
<F10>	Save and Exit
<Esc>	Return to previous menu

#### Scroll Bar

When a scroll bar appears to the right of the setup screen, it indicates that there are more available fields not shown on the screen. Use the up and down arrow keys to scroll through all the available fields.

#### Submenu

When "►" appears on the left of a particular field, it indicates that a submenu which contains additional options are available for that field. To display the submenu, move the highlight to that field and press <Enter>.

► Main

The Main menu is the first screen that you will see when you enter the BIOS Setup Utility.

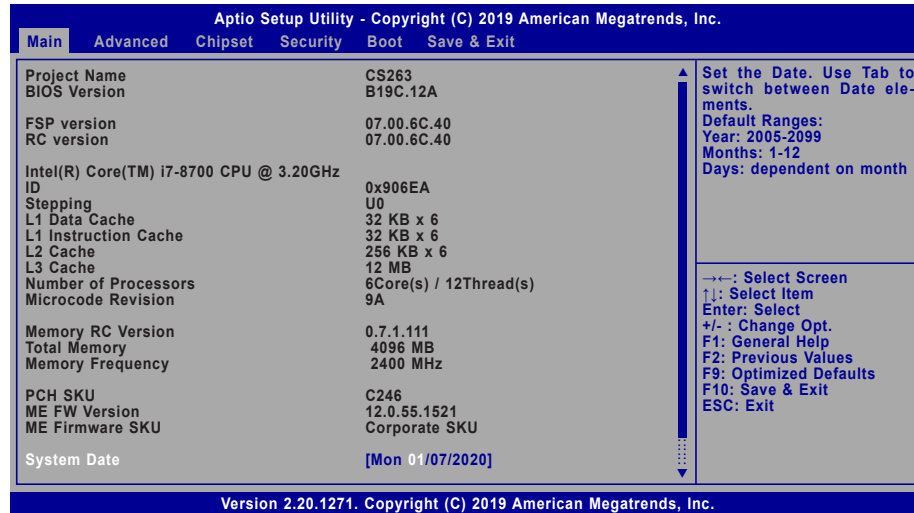

**System Date**

The date format is <month>, <date>, <year>. Press "Tab" to switch to the next field and press "-" or "+" to modify the value.

**System Time**

The time format is <hour>, <minute>, <second>. The time is based on the 24-hour military-time clock. For example, 1 p.m. is 13:00:00. Hour displays hours from 00 to 23. Minute displays minutes from 00 to 59. Second displays seconds from 00 to 59.

► Advanced

The Advanced menu allows you to configure your system for basic operation. Some entries are defaults required by the system board, while others, if enabled, will improve the performance of your system or let you set some features according to your preference.



**Important:**  
Setting incorrect field values may cause the system to malfunction.

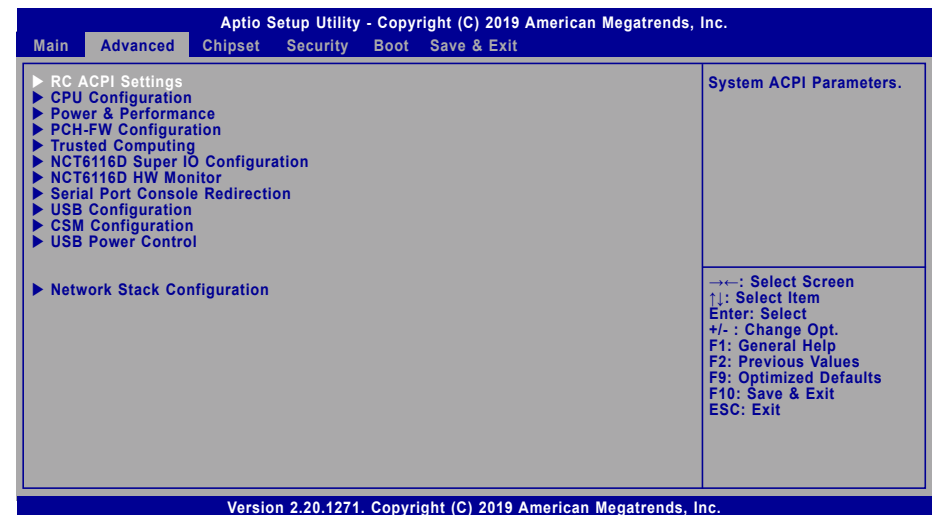

► Advanced

### RC ACPI Configuration

Aptio Setup Utility - Copyright (C) 2019 American Megatrends, Inc.		
Advanced		
<b>RC ACPI Configuration</b>		Enable or disable System wake on alarm event. When enabled, System will wake on the hr:min::sec specified
Wake system from S5 via RTC	[Enabled]	
Wake up hour	0	→←: Select Screen ↑↓: Select Item Enter: Select +/-: Change Opt. F1: General Help F2: Previous Values F9: Optimized Defaults F10: Save & Exit ESC: Exit
Wake up minute	0	
Wake up second	0	
State After G3	[S0 State]	
Version 2.20.1271. Copyright (C) 2019 American Megatrends, Inc.		

#### Wake system from S5 via RTC

When Enabled, the system will automatically power up at a designated time every day. Once it's switched to [Enabled], please set up the time of day — hour, minute, and second — for the system to wake up.

#### State After G3

Select between S0 State, and S5 State. This field is used to specify what state the system is set to return to when power is re-applied after a power failure (G3 state).

- S0 State**     The system automatically powers on after power failure.
- S5 State**     The system enter soft-off state after power failure. Power-on signal input is required to power up the system.
- Last State**    The system returns to the last state right before power failure.

► Advanced

### CPU Configuration

Aptio Setup Utility - Copyright (C) 2019 American Megatrends, Inc.		
Advanced		
<b>CPU Configuration</b>		When enabled, a VMM can utilize the additional hardware capabilities provided by Vanderpool Technology.
Intel (VMX) Virtualization Technology	[Enable]	
Active Processor Cores	[All]	→←: Select Screen ↑↓: Select Item Enter: Select +/-: Change Opt. F1: General Help F2: Previous Values F9: Optimized Defaults F10: Save & Exit ESC: Exit
Hyper-Threading	[Enable]	
Version 2.20.1271. Copyright (C) 2019 American Megatrends, Inc.		

#### Intel (VMX) Virtualization Technology

When this field is set to Enabled, the VMM can utilize the additional hardware capabilities provided by Vanderpool Technology.

#### Active Processor Cores

Select number of cores to enable in each processor package: all or 1.

#### Hyper-threading

Enables this field for Windows XP and Linux which are optimized for Hyper-Threading technology. Select disabled for other OSes not optimized for Hyper-Threading technology. When disabled, only one thread per enabled core is enabled.



**Note:**  
Some of the fields may not be available when the features are not supported by the equipped CPU.

▶ Advanced

Power & Performance

Aptio Setup Utility - Copyright (C) 2019 American Megatrends, Inc.		
Advanced		
<b>Power &amp; Performance</b>		Allows more than two frequency ranges to be supported.
Intel(R) SpeedStep(tm)	[Enabled]	
Turbo Mode	[Enabled]	
C states	[Enabled]	
<b>Configurable TDP Settings</b>		
Power Limit 1	35.0W (MSR:35.0)	
Power Limit 2	0	
Power Limit 1	92.0W (MSR:92.0)	
Power Limit 2	0	
		→←: Select Screen ↑↓: Select Item Enter: Select +/- : Change Opt. F1: General Help F2: Previous Values F9: Optimized Defaults F10: Save & Exit ESC: Exit
Version 2.20.1271. Copyright (C) 2019 American Megatrends, Inc.		

**Intel(R) SpeedStep(tm)**

This field is used to enable or disable the Intel SpeedStep® Technology, which helps optimize the balance between system’s power consumption and performance. After it is enabled in the BIOS, EIST features can then be enabled via the operating system’s power management.

**Turbo Mode**

Enable or disable turbo mode of the processor. This field will only be displayed when EIST is enabled.

**C states**

Enable or disable CPU Power Management. It allows CPU to enter "C states" when it’s idle and nothing is executing.

**Power Limit 1/2**

Adjust power limit of the CPU.

▶ Advanced

PCH-FW Configuration

Aptio Setup Utility - Copyright (C) 2019 American Megatrends, Inc.		
Advanced		
ME State	[Enabled]	When Disabled ME will be put into ME Temporarily Disabled Mode.
Manageability Features State	[Enabled]	
AMT BIOS Features	[Enabled]	
▶ AMT Configuration		
ME Unconfig on RTC Clear	[Enabled]	
▶ Firmware Update Configuration		
		→←: Select Screen ↑↓: Select Item Enter: Select +/- : Change Opt. F1: General Help F2: Previous Values F9: Optimized Defaults F10: Save & Exit ESC: Exit
Version 2.20.1271. Copyright (C) 2019 American Megatrends, Inc.		

**ME State**

When this field is set to Disabled, ME will be put into ME Temporarily Disabled Mode.

**Manageability Features State**

Enable or disable Intel(R) Manageability features. This option disables/enables Manageability Features support in FW. To disable, support platform must be in an unprovisioned state first.

**AMT BIOS Features**

When disabled, AMT BIOS features are no longer supported and user is no longer able to access MEBx Setup. This option does not disable manageability features in FW.

**ME Unconfig on RTC Clear**

When disabled, ME will not be unconfigured on RTC Clear.



**Note:**  
The sub-menus are detailed in following sections.

▶ Advanced ▶ PCH-FW Configuration

▶ AMT Configuration

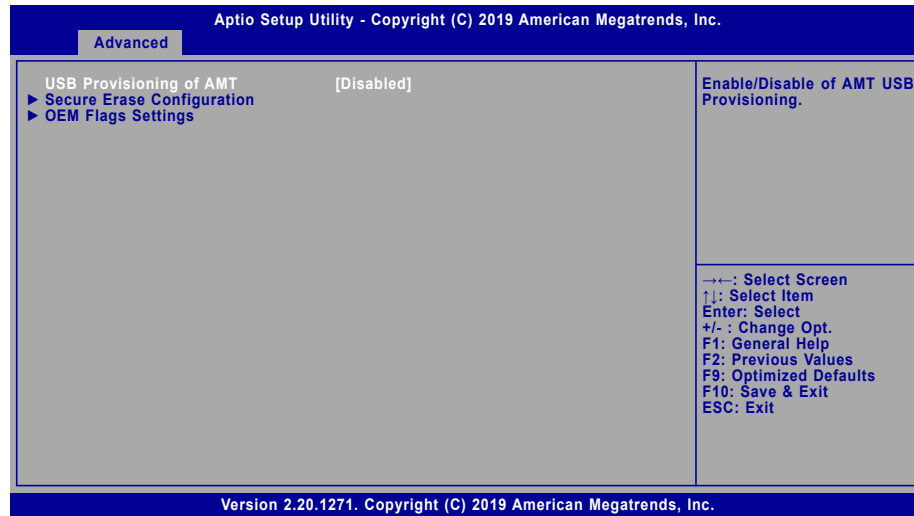

**USB Provisioning of AMT**

Enable or disable AMT USB Provisioning.

▶ Advanced ▶ PCH-FW Configuration

▶ AMT Configuration ▶ Secure Erase Configuration

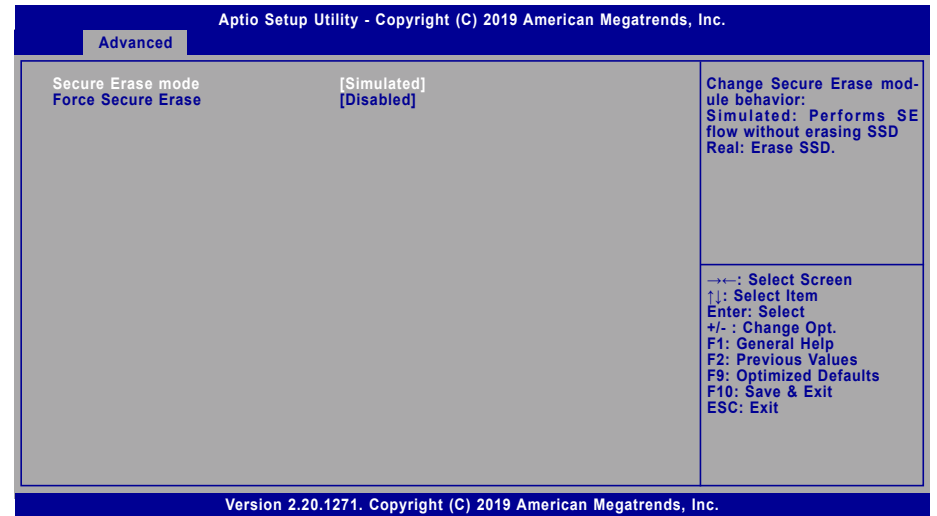

**Secure Erase Mode**

Select Secure Erase module behavior: Simulated or Real.

**Force Secure Erase**

Enable or disable Force Secure Erase on next boot.



▶ Advanced ▶ PCH-FW Configuration

▶ AMT Configuration ▶ OEM Flags Settings

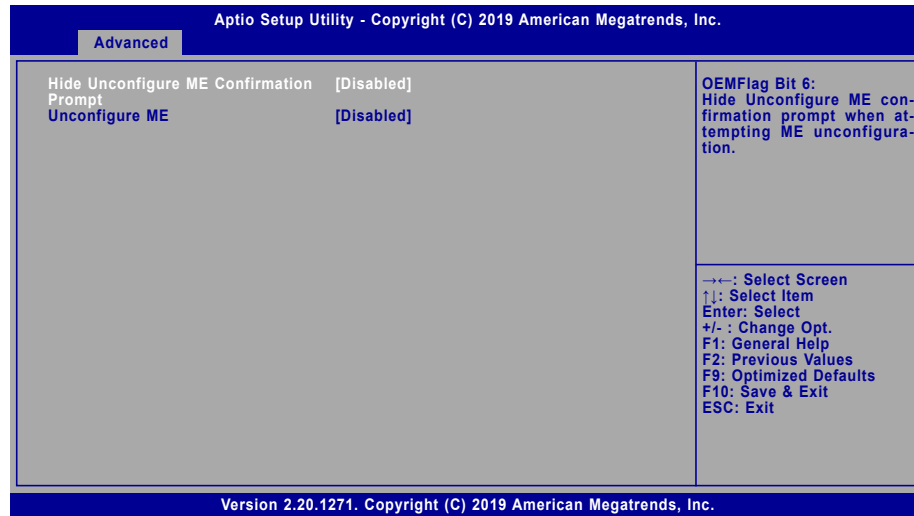

**Hide Unconfigure ME Confirmation Prompt**

Enable or disable to hide unconfigure ME confirmation prompt when attempting ME unconfiguration.

**Unconfigure ME**

Enable or disable to unconfigure ME with resetting MEBx password to default.

▶ Advanced ▶ PCH-FW Configuration

▶ Firmware Update Configuration

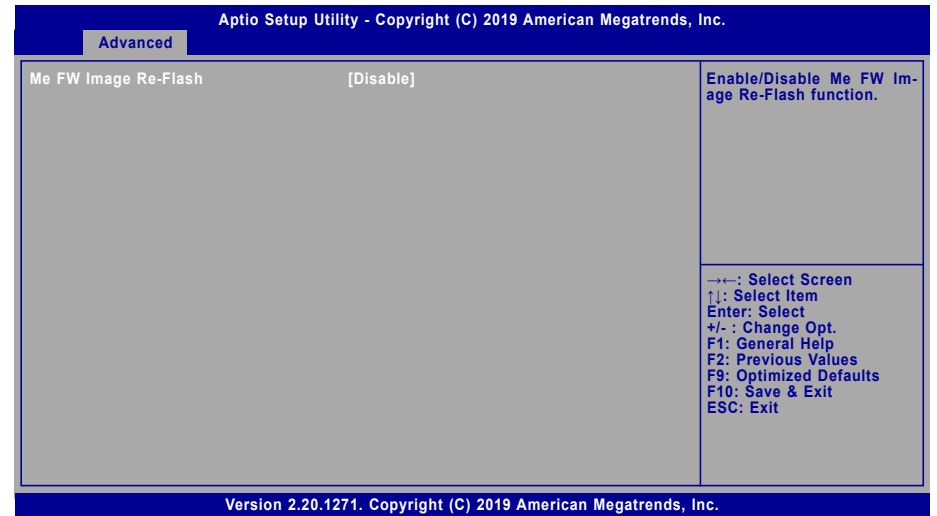

**Me FW Image Re-Flash**

This field is used to enable or disable the ME FW Image Re-Flash function, which allows the user to update the ME firmware.

▶ Advanced

Trusted Computing

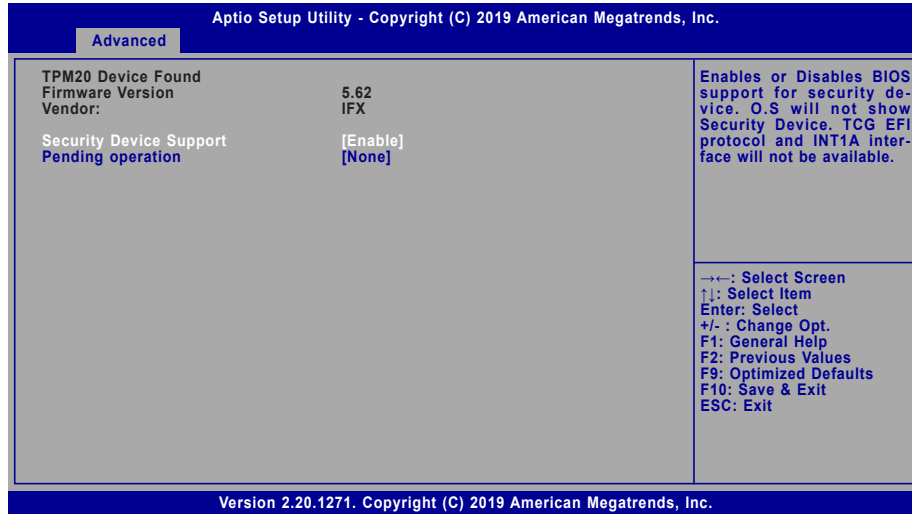

**Security Device Support**

This field is used to enable or disable BIOS support for the security device such as an TPM 2.0 to achieve hardware-level security via cryptographic keys.

**Pending operation**

To clear the existing TPM encryption, select "TPM Clear" and restart the system. This field is not available when "Security Device Support" is disabled.

▶ Advanced

NCT6116D Super IO Configuration

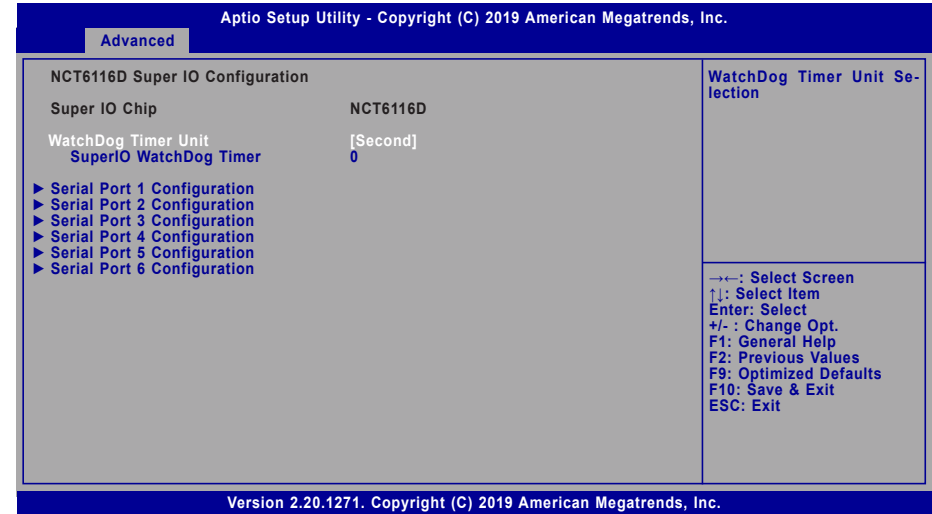

**WatchDog Timer Unit**

Select WatchDog Timer Unit — Second or Minute.

**SuperIO WatchDog Timer**

Set SuperIO WatchDog Timer Timeout value. The range is from 0 (disabled) to 255.



**Note:**  
The sub-menus are detailed in following sections.

▶ Advanced ▶ NCT6116D Super IO Configuration

▶ Serial Port 1/2/3/4/5/6 Configuration

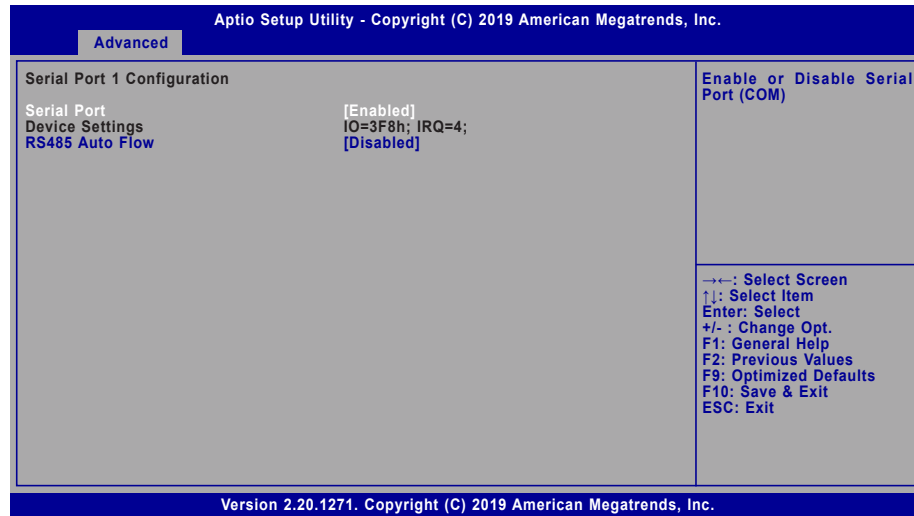

**Serial Port**

Enable or disable the current serial COM port.

**RS485 Auto Flow**

Enable or disable RS485 auto flow. This field is only available for COM ports that support RS485 mode.

▶ Advanced

NCT6116D HW Monitor

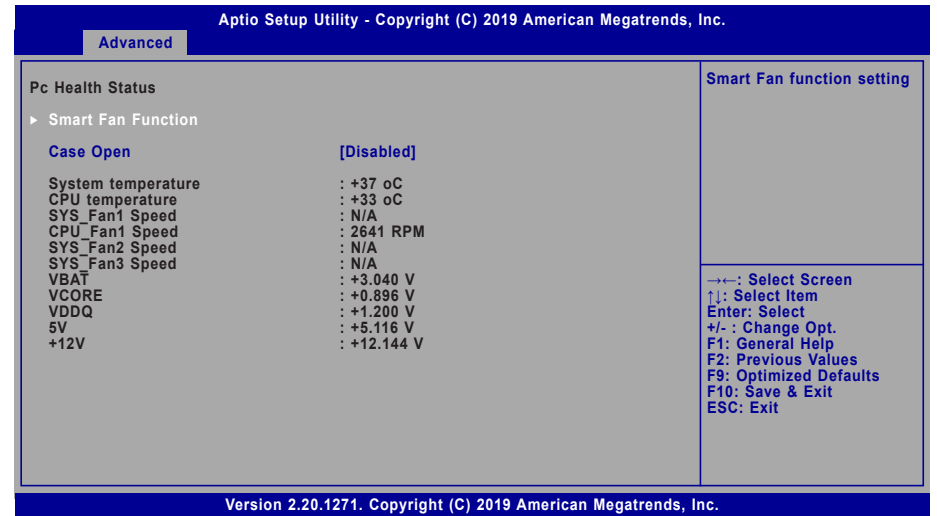

This section displays the system's health information, i.e. voltage readings, CPU and system temperatures, and fan speed readings.

**Case Open**

Enable or disable the case open detection function.

▶ Smart Fan Function

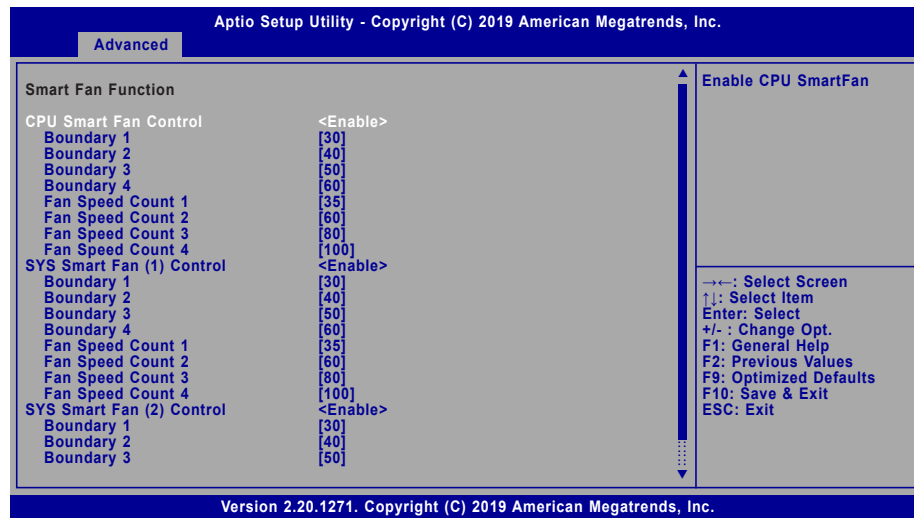

Smart Fan is a fan speed moderation strategy dependent on the current system temperature. When the system temperature goes higher than the Boundary setting, the fan speed will be turned up to the setting of the Fan Speed Count that bears the same index as the Boundary field.

▼ **SYS Smart Fan/CPU Smart Fan Control = [Enabled]**

**Boundary 1 to Boundary 4**

Set the boundary temperatures that determine the fan speeds accordingly, the value ranging from 0-127°C. For example, when the system temperature reaches Boundary 1 setting, the fan speed will be turned up to the designated speed of the Fan Speed Count 1 field.

**Fan Speed Count 1 to Fan Speed Count 4**

Set the fan speed, the value ranging from 1-100%, 100% being full speed. The fans will operate according to the specified boundary temperatures above-mentioned.

▼ **SYS Smart Fan/CPU Smart Fan Control = [Disabled]**

**Fix Fan Speed Count**

Set the fan speed, the value ranging from 1-100%, 100% being full speed. The fans will always operate at the specified speed regardless of gauged temperatures.

Serial Port Console Redirection

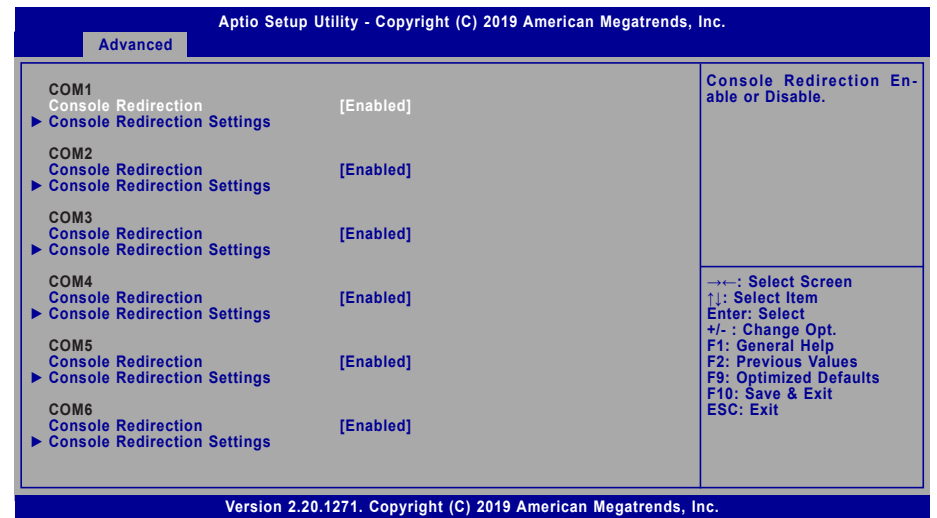

**Console Redirection**

By enabling Console Redirection of a COM port, the sub-menu of console redirection settings will become available for configuration as detailed in the following.

▶ Console Redirection Settings

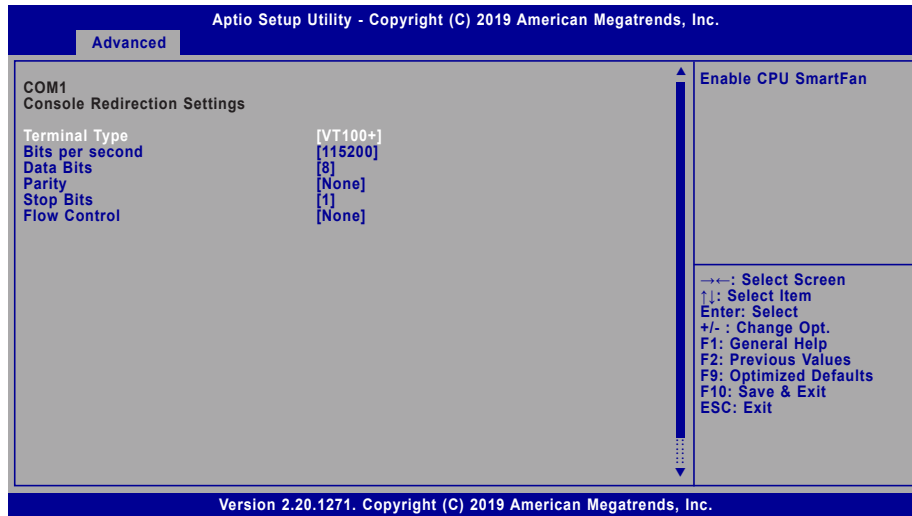

Configure the serial settings of the current COM port.

**Terminal Type**

Select terminal type: VT100, VT100+, VT-UTF8 or ANSI.

**Bits per second**

Select serial port transmission speed: 9600, 19200, 38400, 57600 or 115200.

**Data Bits**

Select data bits: 7 bits or 8 bits.

**Parity**

Select parity bits: None, Even, Odd, Mark or Space.

**Stop Bits**

Select stop bits: 1 bit or 2 bits.

**Flow Control**

Select flow control type: None or Hardware RTS/CTS. Flow Control is for RS485 mode and is only supported by Serial Port 1 (COM1).

USB Configuration

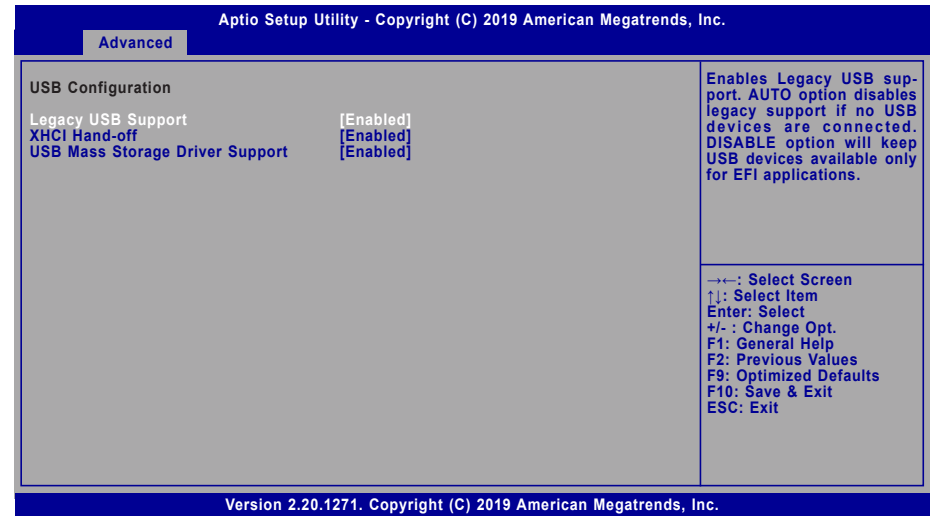

**Legacy USB Support**

- Enabled**      Enable Legacy USB support.
- Disabled**    Keep USB devices available only for EFI applications.
- Auto**          Disable Legacy support if no USB devices are connected.

**XHCI Hand-off**

Enable or disable XHCI Hand-off.

**USB Mass Storage Driver Support**

Enable or disable USB Mass Storage Driver Support.

► Advanced

### CSM Configuration

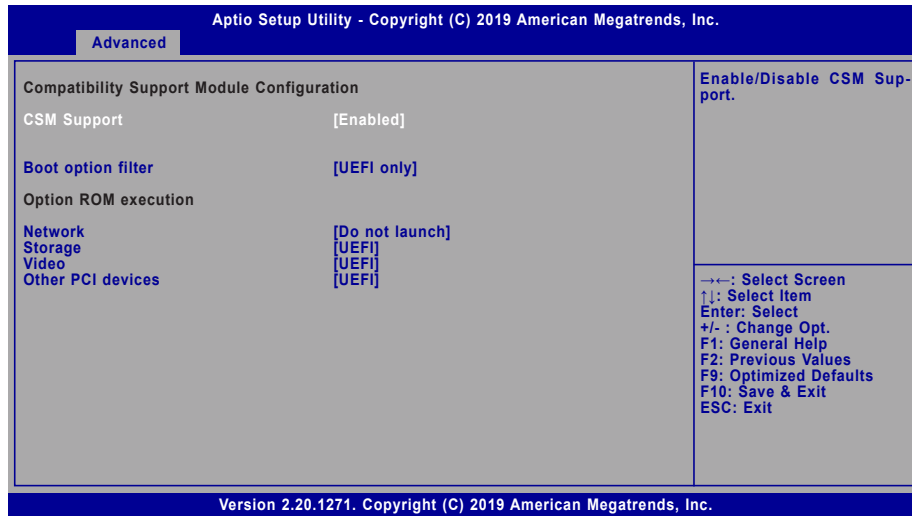

#### CSM Support

This section is used to enable or disable CSM Support. The following fields are only available when "CSM Support" is enabled.

#### Boot option filter

This field controls Legacy/UEFI ROMs priority. Select among UEFI and Legacy, Legacy only or UEFI only.

#### Network

This field controls the execution of UEFI and Legacy Network OpROM.

#### Storage

This field controls the execution of UEFI and Legacy Storage OpROM.

#### Video

This field controls the execution of UEFI and Legacy Video OpROM.

#### Other PCI devices

This field determines OpROM execution policy for devices other than Network, Storage or Video.

► Advanced

### USB Power Control

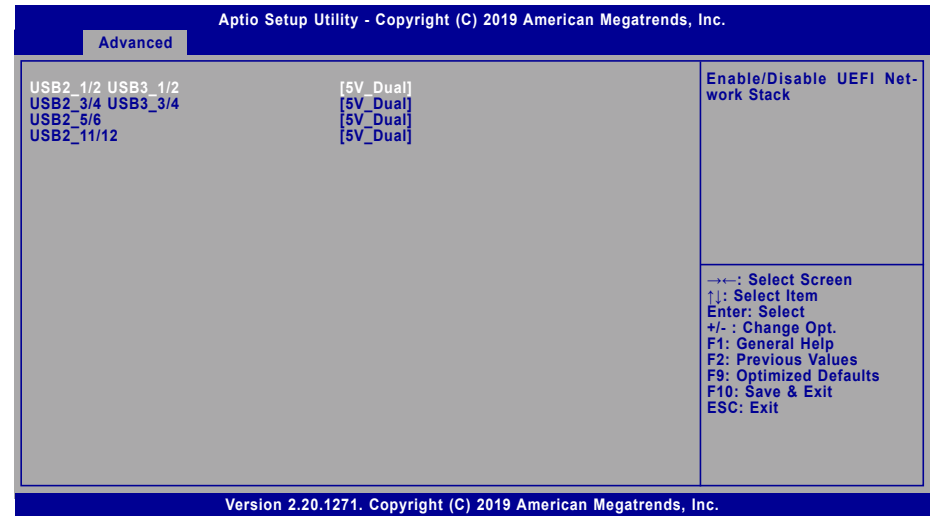

Select between 5V\_Dual (5VDU) and 5V for the USB power channel of each USB connector. To support Wake-on-USB, please select 5V\_Dual.

► **Advanced**

**Network Stack Configuration**

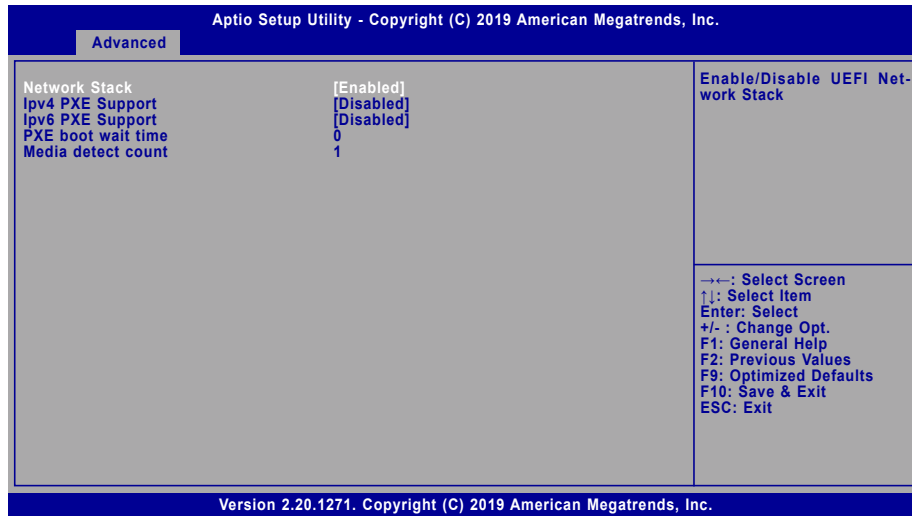

**Network Stack**

Enable or disable UEFI network stack. The following fields will appear when this field is enabled.

**Ipv4 PXE Support**

Enable or disable IPv4 PXE boot support. If disabled, IPv4 PXE boot support will not be available.

**Ipv6 PXE Support**

Enable or disable IPv6 PXE boot support. If disabled, IPv6 PXE boot support will not be available.

**PXE boot wait time**

Set the wait time in seconds to press ESC key to abort the PXE boot. Use either +/- or numeric keys to set the value.

**Media detect count**

Set the number of times the presence of media will be checked. Use either +/- or numeric keys to set the value.

► Chipset

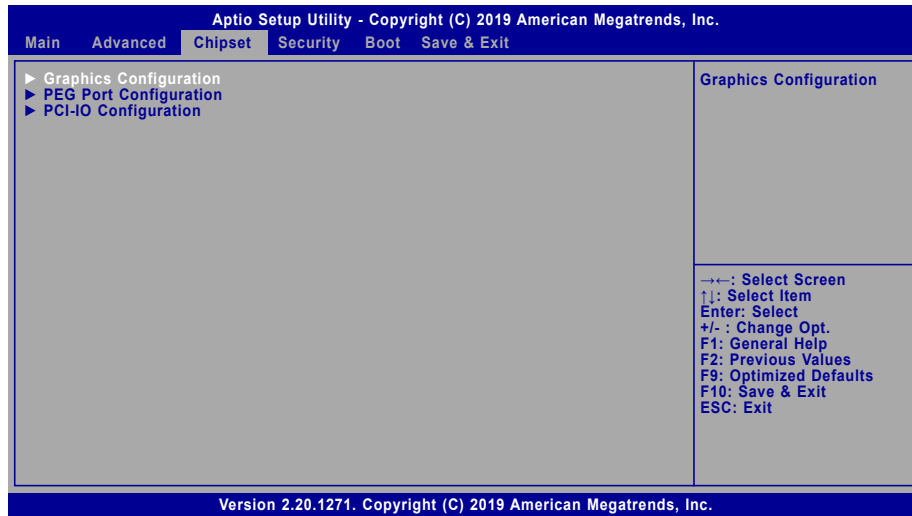

Please select a submenu and press Enter. The submenus are detailed in the following pages.

► Chipset

Graphics Configuration

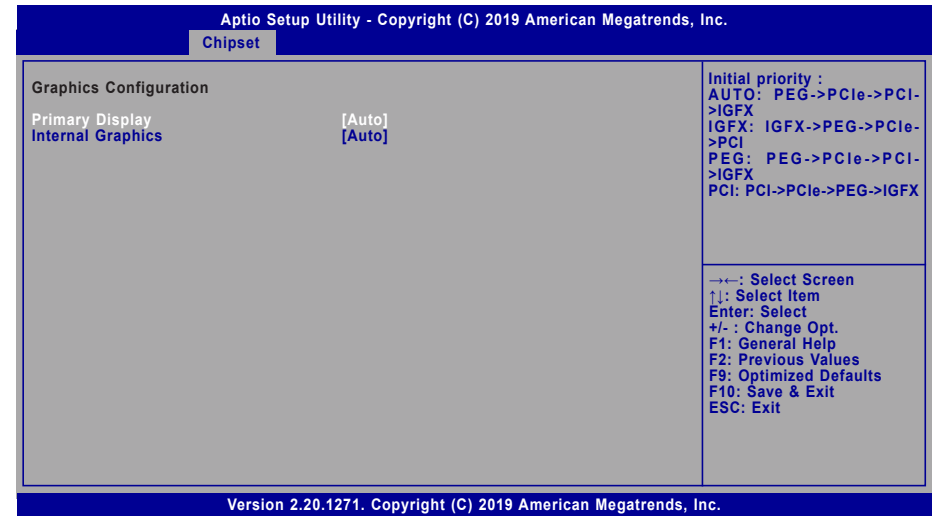

**Primary Display**

Select which of IGFX/PEG/PCI Graphics device to be the primary display.

**Internal Graphics**

Keep IGFX "Enabled" or "Disabled" based on the setup options, or select "Auto" for auto-detection.



► Chipset

PEG Port Configuration

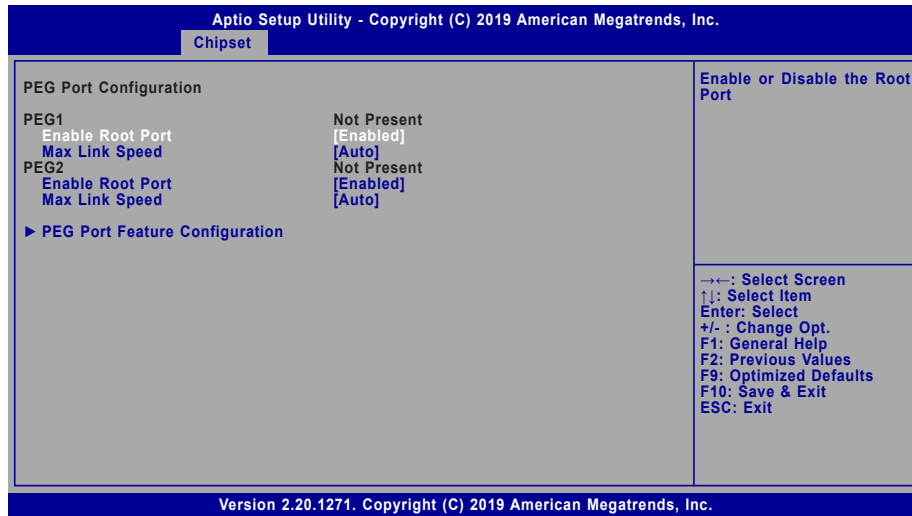

**Enable Root Port**

Enable or disable the root port, or select "Auto" for auto-detection.

**Max Link Speed**

Configure PEG1/PEG3 port's Max Speed: Auto, Gen1, Gen2 or Gen3.

► PEG Port Feature Configuration

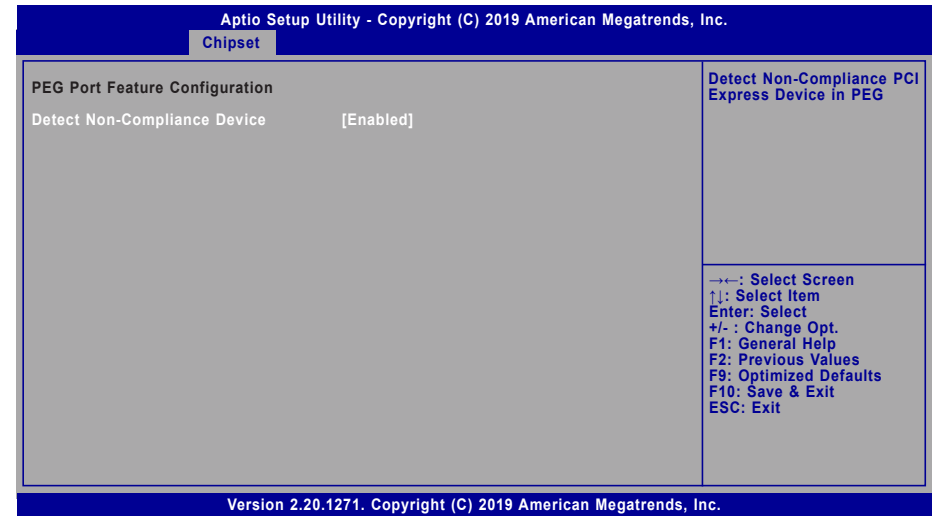

**Detect Non-Compliance Device**

Enable or disable this field to detect non-compliance PCIe devices in the PEG.

► Chipset

PCH-IO Configuration

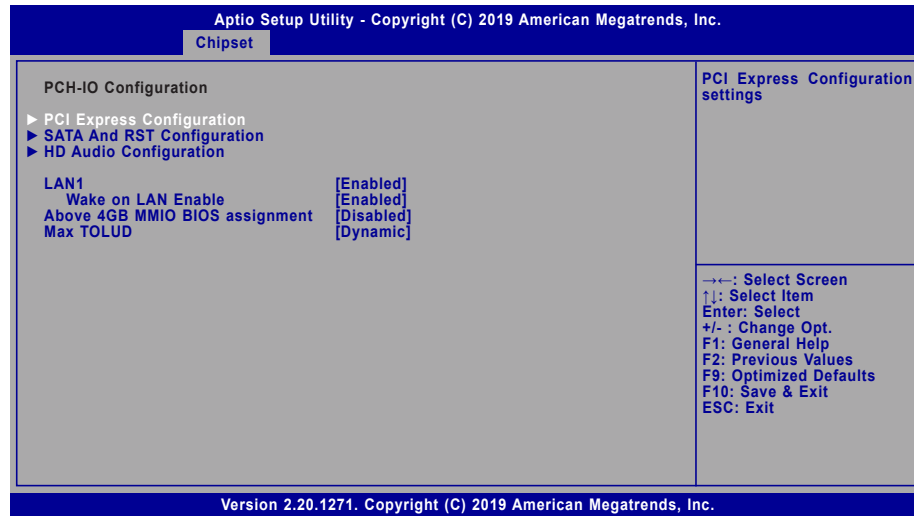

**LAN1(I219)**

Enable or disable onboard NIC.

**Wake on LAN Enable**

Enable or disable integrated LAN to wake the system.

**Above 4GB MMIO BIOS assignment**

Enable/Disable above 4GB MemoryMappedIO BIOS assignment. This is enabled automatically when Aperture Size is set to 2048MB.

**Max TOLUD**

Assign the maximum value of Top Of Lower Usable DRAM (TOLUD). Select to specify a fixed value, or select "Dynamic" so that the assignment would adjust TOLUD automatically based on largest MMIO length of installed graphic controller.



**Note:**

The sub-menus are detailed in following sections.

► Chipset ► PCH-IO Configuration

PCI Express Configuration

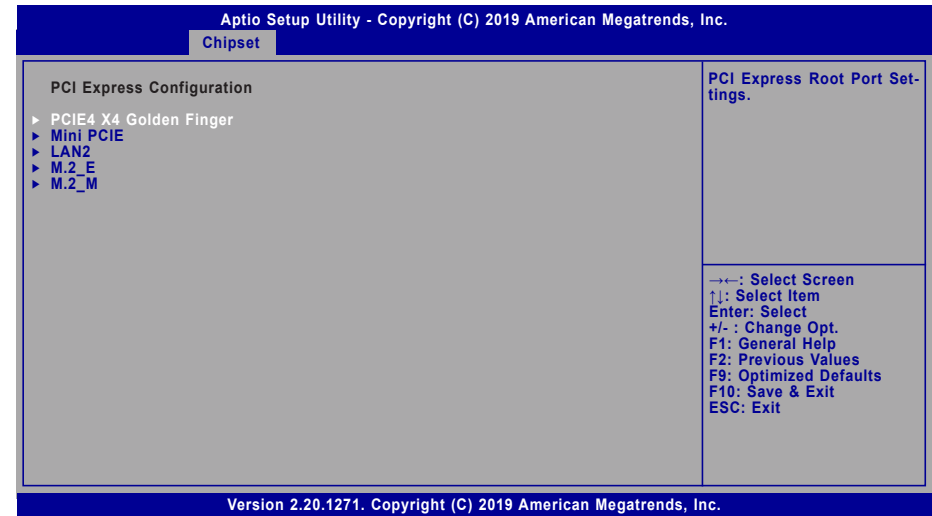

Select one of the PCI Express channels and press enter to configure the following settings.

**PCI Express Devices**

Enable or disable the PCI Express Root Port. The following fields are only available when the PCIe root port is enabled.

**PCIe Speed**

Select PCIe Speed of the current port — AUTO, Gen1, Gen 2, or Gen3. This field may not appear when the speed of the port is not configurable.

**Hot Plug**

Enable or disable hot plug function of the port. This field may not appear when the port does not support hot plug.

**Detect Non-Compliance Device**

Enable or disable this field to detect non-compliance PCIe devices in the PEG. This field may not appear when the port does not support Non-compliant device detection.

### SATA And RST Configuration

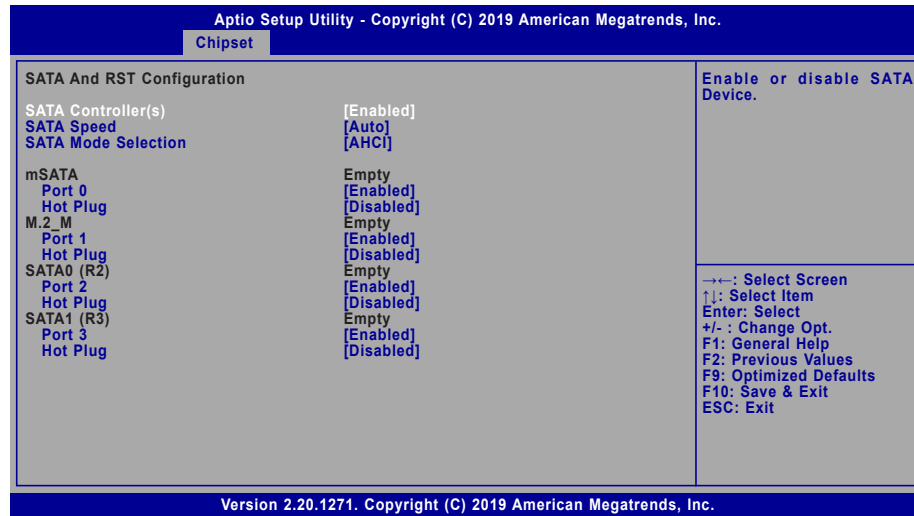

#### SATA Controller(s)

This field is used to enable or disable the Serial ATA controller.

#### SATA Speed

This field is used to select SATA speed generation limit: Auto, Gen1, Gen2 or Gen3.

#### SATA Mode Selection

The mode selection determines how the SATA controller(s) operates.

**AHCI** This option allows the Serial ATA controller(s) to use AHCI (Advanced Host Controller Interface).

**Intel RST Premium With Intel Optane System Acceleration** This option allows you to create RAID or Intel Rapid Storage configuration along with Intel® Optane™ system acceleration on Serial ATA devices.

#### Use RST Legacy OROM

This field shows up when SATA Mode Selection is set to Intel RST Premium With Intel Optane System Acceleration. Enable or disable to use RST Legacy OROM when CSM is enabled.

#### Ports and Hot Plug

Enable or disable the Serial ATA port and its hot plug function.

### HD Audio Configuration

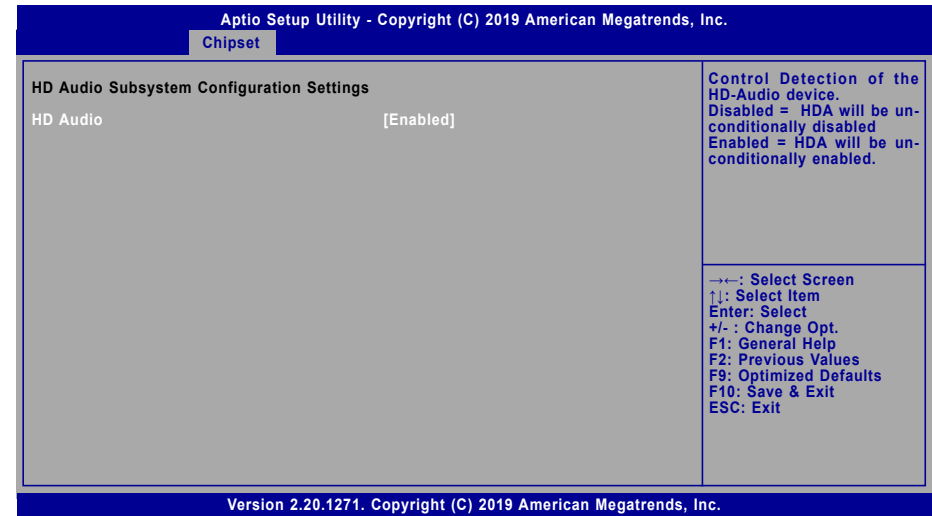

#### HD Audio

Control the detection of the HD Audio device.

**Disabled** HDA will be unconditionally disabled.

**Enabled** HDA will be unconditionally enabled.

► Security

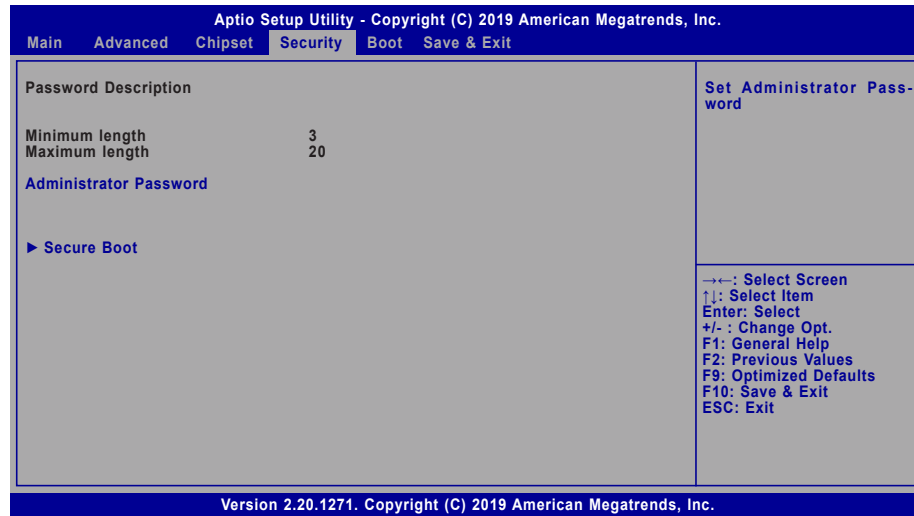

**Administrator Password**

Set the administrator password. To clear the password, input nothing and press enter when a new password is asked. Administrator Password will be required when entering the BIOS.

**User Password**

Set the user password. To clear the password, input nothing and press enter when a new password is asked. User Password will be required when powering up the system.

► Security

Secure Boot

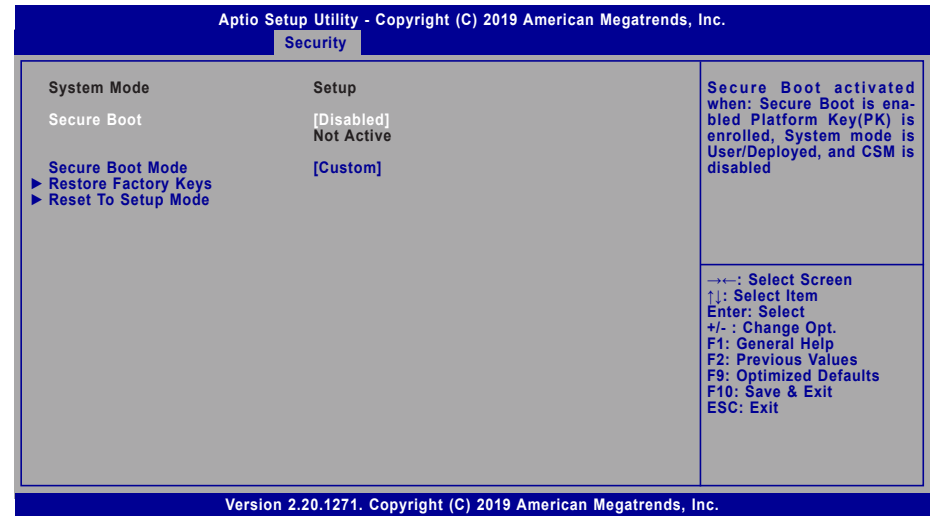

**Secure Boot**

The Secure Boot store a database of certificates in the firmware and only allows the OSeS with authorized signatures to boot on the system. To activate Secure Boot, please make sure that "Secure Boot" is "[Enabled]", Platform Key (PK) is enrolled, "System Mode" is "User", and CSM is disabled. After enabling/disabling Secure Boot, please save the configuration and restart the system. When configured and activated correctly, the Secure Boot status will be "Active".

**Secure Boot Customization**

Select the secure boot mode – Standard or Custom. When set to Custom, the following fields will be configurable for the user to manually modify the key database.

**Restore Factory Keys**

Force system to User Mode. Load OEM-defined factory defaults of keys and databases onto the Secure Boot. Press Enter and a prompt will show up for you to confirm.

**Reset To Setup Mode**

Clear the database from the NVRAM, including all the keys and signatures installed in the Key Management menu. Press Enter and a prompt will show up for you to confirm.

► **Boot**

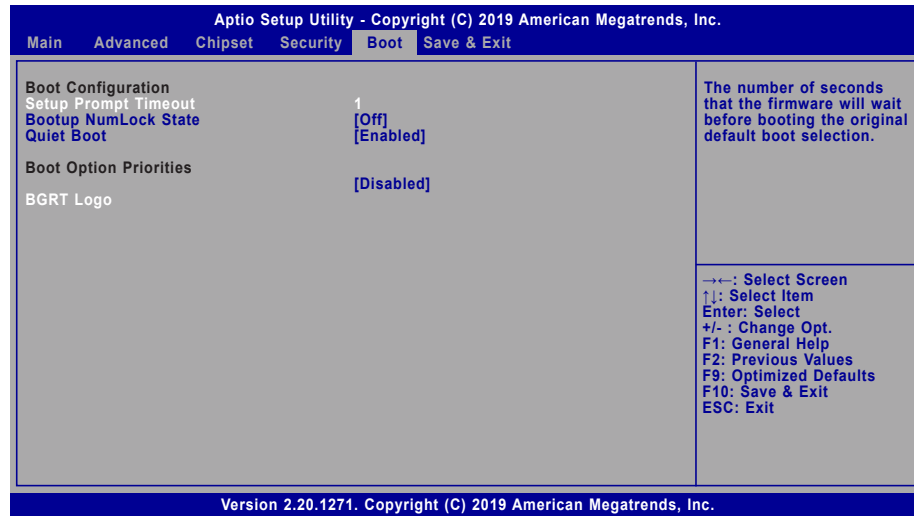

**Setup Prompt Timeout**

Set the number of seconds to wait for the setup activation key. 65535 (0xFFFF) denotes indefinite waiting.

**Bootup NumLock State**

Select the keyboard NumLock state: On or Off.

**Quiet Boot**

This section is used to enable or disable quiet boot option.

**Boot Option Priorities**

Rearrange the system boot order of available boot devices.

**BGRT Logo**

It is used to enable or disable to support display logo with ACPI BGRT table.



**Note:**

If "Boot option filter" of "CSM Configuration" is set to "UEFI and Legacy" or "UEFI only", and "Quiet Boot" is set to enabled, "BGRT Logo" will show up for configuration. Refer to the Advanced > CSM Configuration submenu for more information.

► **Save & Exit**

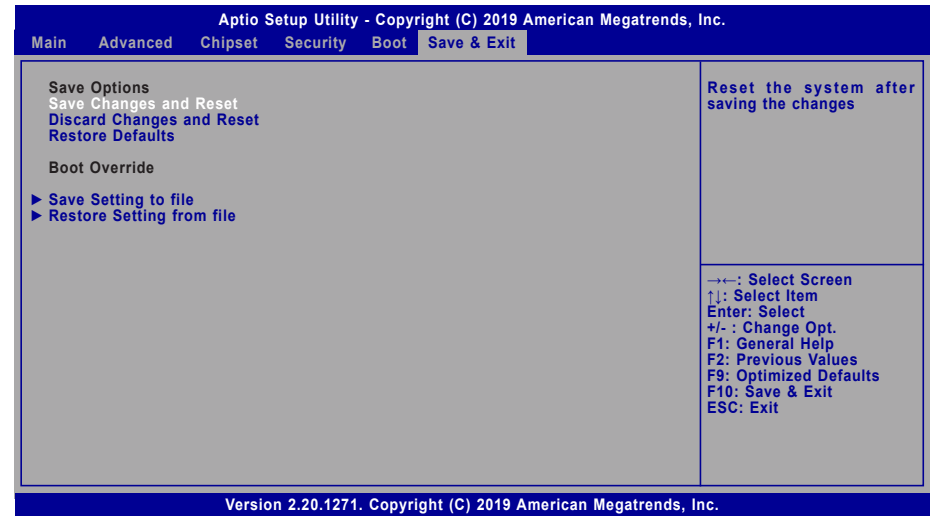

**Save Changes and Reset**

To save the changes, select this field and then press <Enter>. A dialog box will appear. Select Yes to reset the system after saving all changes made.

**Discard Changes and Reset**

To discard the changes, select this field and then press <Enter>. A dialog box will appear. Select Yes to reset the system setup without saving any changes.

**Restore Defaults**

To restore and load the optimized default values, select this field and then press <Enter>. A dialog box will appear. Select Yes to restore the default values of all the setup options.

**Boot Override**

Move the cursor to an available boot device and press Enter, and then the system will immediately boot from the selected boot device. The Boot Override function will only be effective for the current boot. The "Boot Option Priorities" configured in the Boot menu will not be changed.

► **Save Setting to file**

Select this option to save BIOS configuration settings to a USB flash device.

► **Restore Setting from file**

This field will appear only when a USB flash device is detected. Select this field to restore setting from the USB flash device.

## ► Updating the BIOS

To update the BIOS, you will need the new BIOS file and a flash utility. Please contact technical support or your sales representative for the files and specific instructions about how to update BIOS with the flash utility. For updating AMI BIOS in UEFI mode, you may refer to the how-to video at <https://www.dfi.com/Knowledge/Video/5>.

## ► Notice: BIOS SPI ROM

1. The Intel® Management Engine has already been integrated into this system board. Due to the safety concerns, the BIOS (SPI ROM) chip cannot be removed from this system board and used on another system board of the same model.
2. The BIOS (SPI ROM) on this system board must be the original equipment from the factory and cannot be used to replace one which has been utilized on other system boards.
3. If you do not follow the methods above, the Intel® Management Engine will not be updated and will cease to be effective.



**Note:**

- a. You can take advantage of flash tools to update the default configuration of the BIOS (SPI ROM) to the latest version anytime.
- b. When the BIOS IC needs to be replaced, you have to populate it properly onto the system board after the EEPROM programmer has been burned and follow the technical person's instructions to confirm that the MAC address should be burned or not.

## Chapter 4 - Intel AMT Settings

### ► Overview

Intel Active Management Technology (Intel® AMT) combines hardware and software solution to provide maximum system defense and protection to networked systems. The hardware and software information are stored in non-volatile memory. With its built-in manageability and latest security applications, Intel® AMT provides the following functions.

#### Discover

Allows remote access and management of networked systems even while PCs are powered off; significantly reducing desk-side visits.

#### Repair

Remotely repair systems after OS failures. Alerting and event logging help detect problems quickly to reduce downtime.

#### Protect

Intel AMT's System Defense capability remotely updates all systems with the latest security software. It protects the network from threats at the source by proactively blocking incoming threats, reactively containing infected clients before they impact the network, and proactively alerting when critical software agents are removed.

### ► Enable Intel® AMT in the AMI BIOS

1. Power-on the system then press <Del> to enter the main menu of the AMI BIOS.
2. In the **Advanced** menu, select **PCH-FW Configuration**.

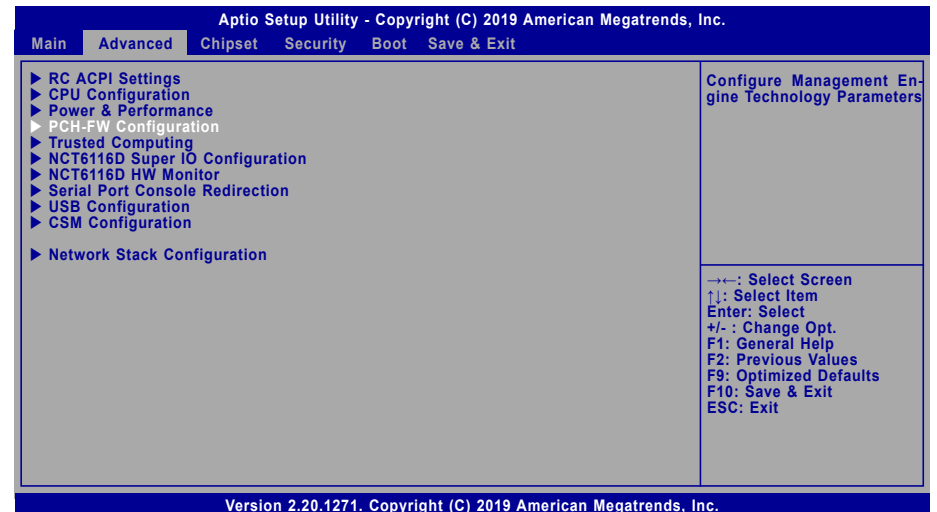

3. Set the **AMT BIOS Features** field to **Enabled**.

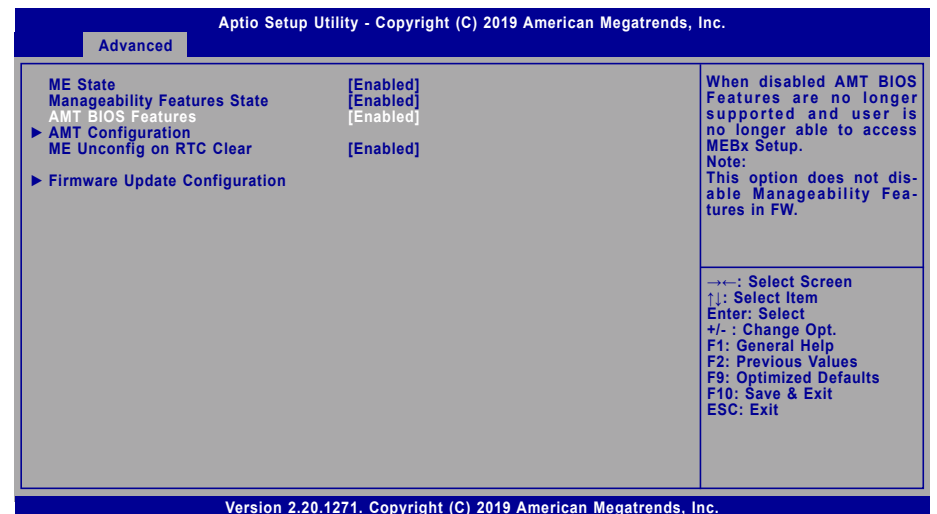

► **Enable Intel® AMT in the AMI BIOS**

4. Press F4, or go to the **Save & Exit** menu, select **Save Changes and Reset** and then press <Enter>. A dialog box will appear. Select **Yes** and press Enter to reset the system after saving all changes made.

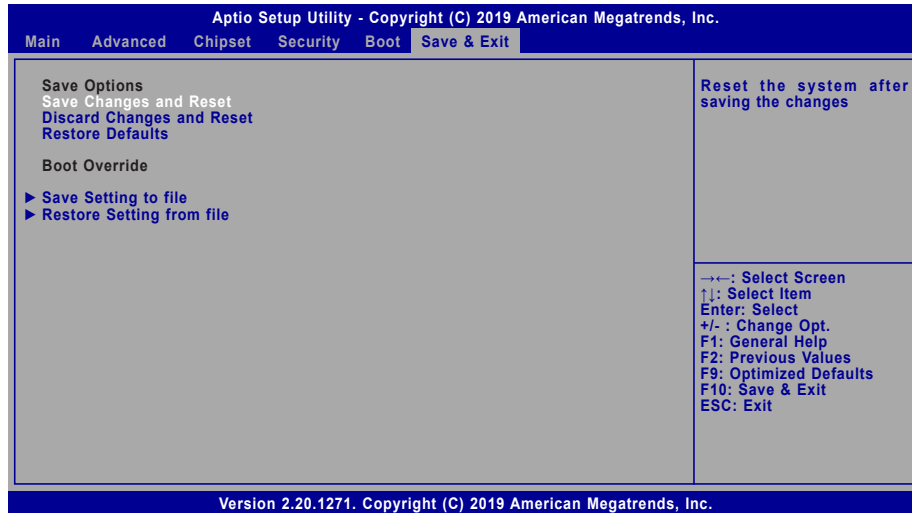

► **Entering Management Engine BIOS Extension (MEBX)**

When the system reboots, the following message will be displayed. Press **<Ctrl + P>** as soon as the message is displayed. This message will only be displayed very briefly.

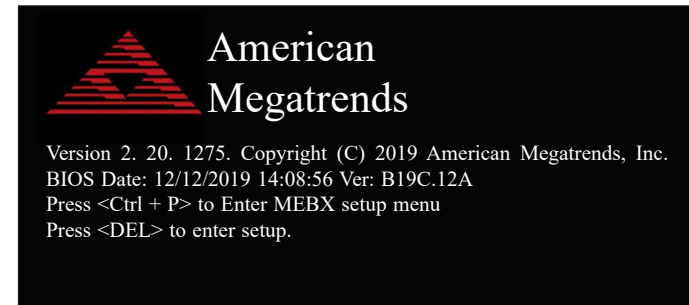



► **MEBX**

Main Menu

Select **MEBx Login** under Main Menu and press Enter. A prompt that requires password input will show up.

1. Enter the default password “**admin**”.

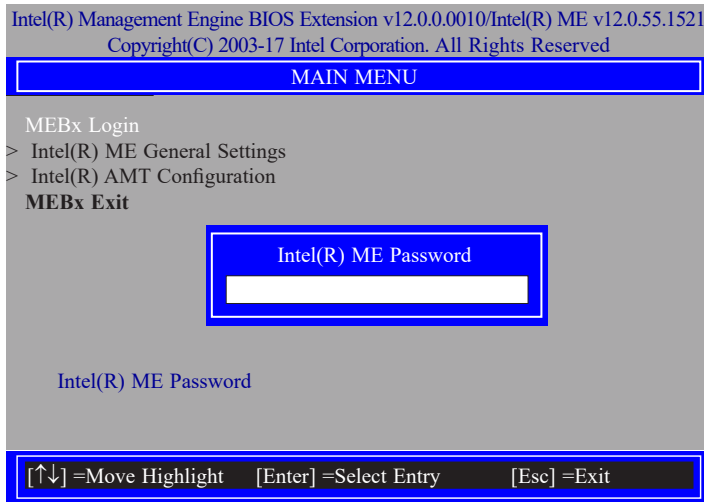

2. Enter a new password and then press Enter. The password must include
  - 8-32 characters;
  - Strong 7-bit ASCII characters excluding : , and " characters;
  - At least one digit character (0, 1, ...9);
  - At least one 7-bit ASCII non alpha-numeric character, above 0x20, (e.g. !, \$, );
  - At least one lower case and one upper case characters.
3. Enter the new password again to verify the new password.

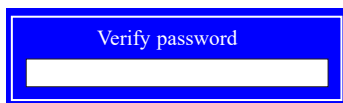

Intel(R) ME General Settings

Select **Intel(R) ME General Settings** under Main Menu and then press Enter.

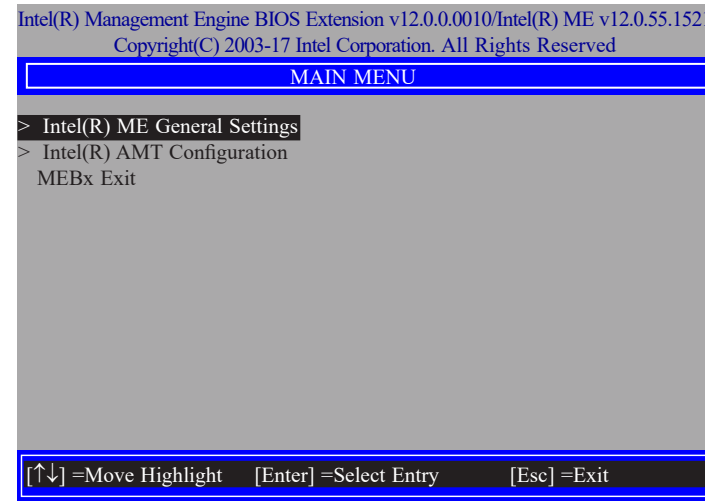

### Change ME Password

If you want to change ME password, select **Change ME Password** and then press Enter. A prompt that requires password input will show up.

1. Enter the current password and then press Enter.

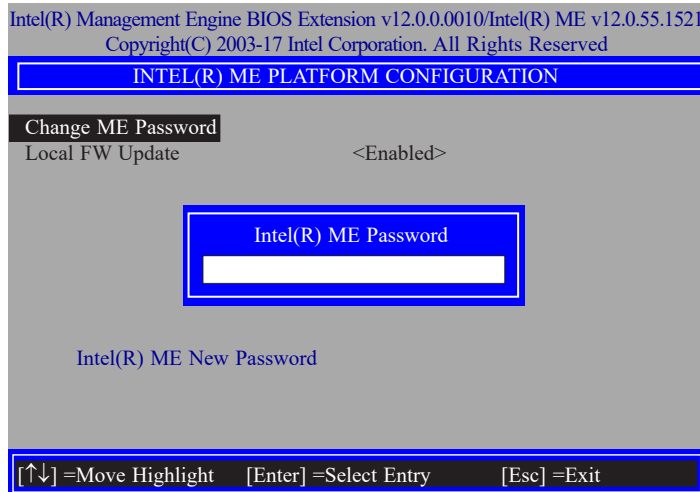

2. Enter a new password and then press Enter. The password must include
  - 8-32 characters;
  - Strong 7-bit ASCII characters excluding : , and " characters;
  - At least one digit character (0, 1, ...9);
  - At least one 7-bit ASCII non alpha-numeric character, above 0x20, (e.g. !, \$, ,);
  - At least one lower case and one upper case characters.
3. Enter the new password again to verify the new password.



### Local FW Update

Select **Local FW Update** then press Enter. Select **Enabled** or **Disabled** or **Password Protected** then press Enter.

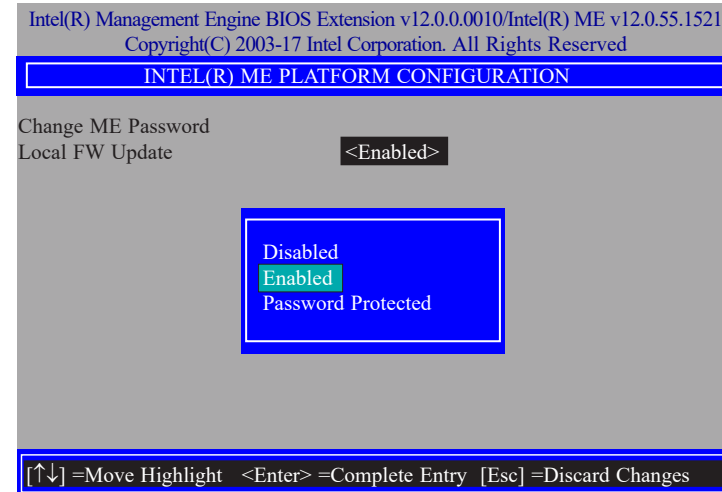

► MEBX

### Intel(R) AMT Configuration

Select Intel(R) AMT Configuration under Main Menu and then press Enter.

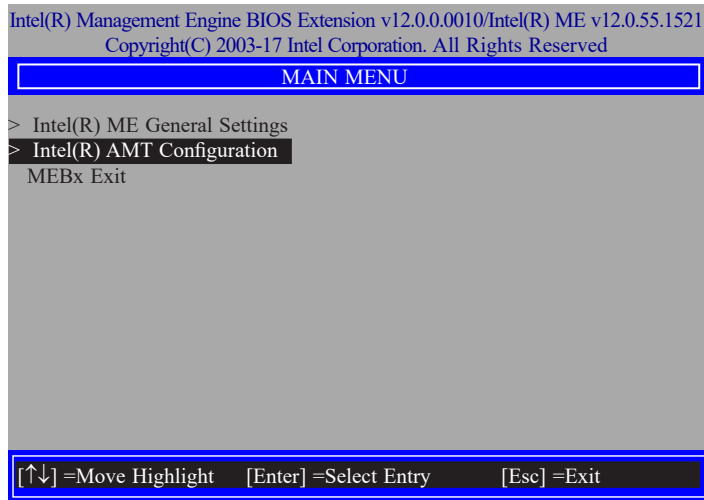

#### Manageability Feature Selection

Select **Enabled** or **Disabled** then press Enter. When disabled, all the following fields will be hidden. After disabling the field, system restart is required.

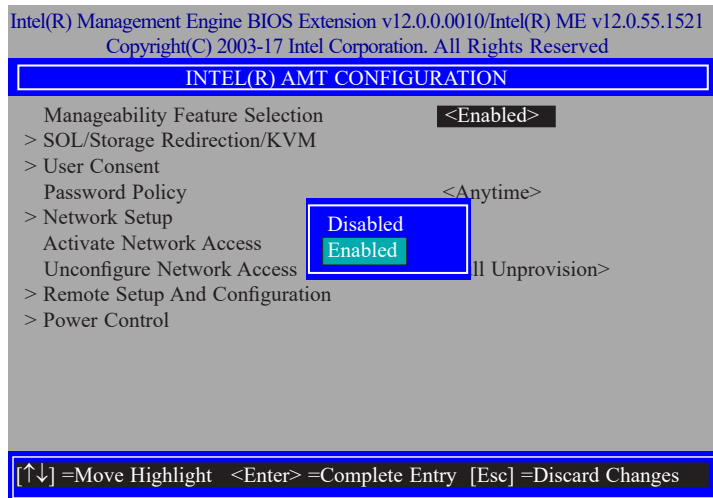

#### > SOL/Storage Redirection/KVM

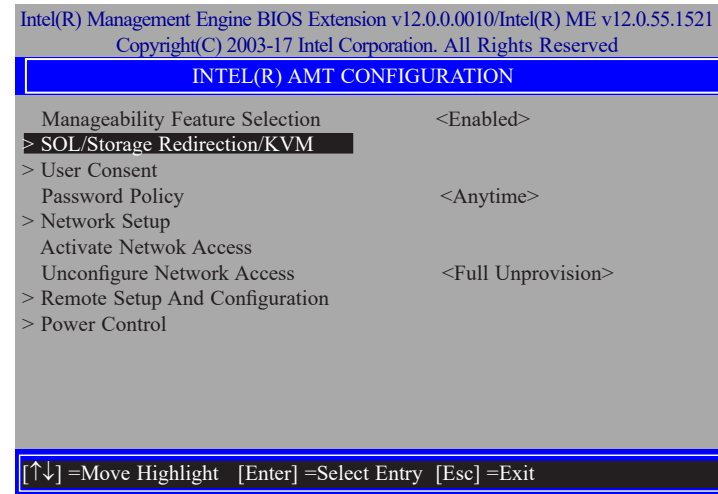

Press Enter to enter the submenu.

> SOL/Storage Redirection/KVM

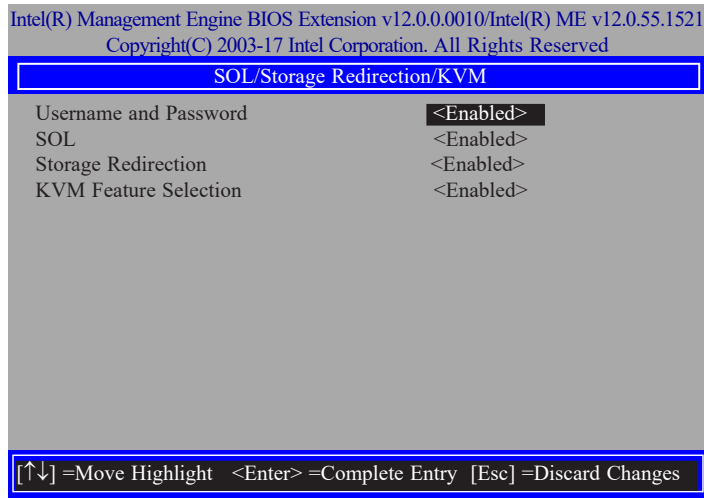

Move the cursor to select a field and press Enter to display options.

**Username and Password**

Select Enabled or Disabled then press Enter.

**SOL**

Select Enabled or Disabled then press Enter.

**Storage Redirection**

Select Enabled or Disabled then press Enter.

**KVM Feature Selection**

Select Enabled or Disabled then press Enter.



> User Consent

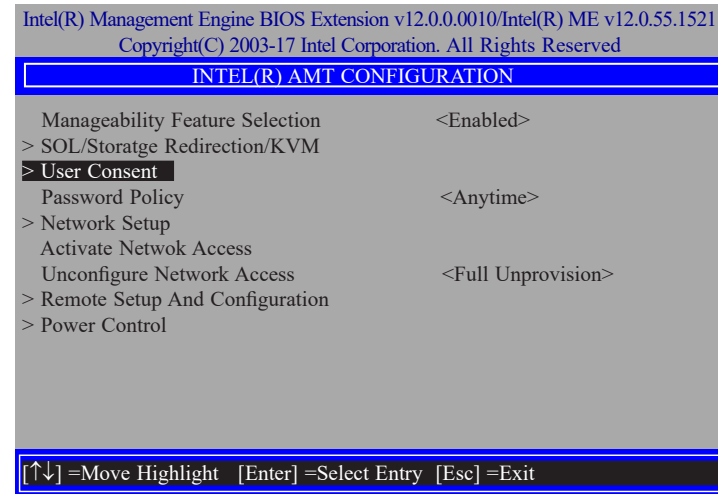

Press Enter to enter the submenu.

> User Consent

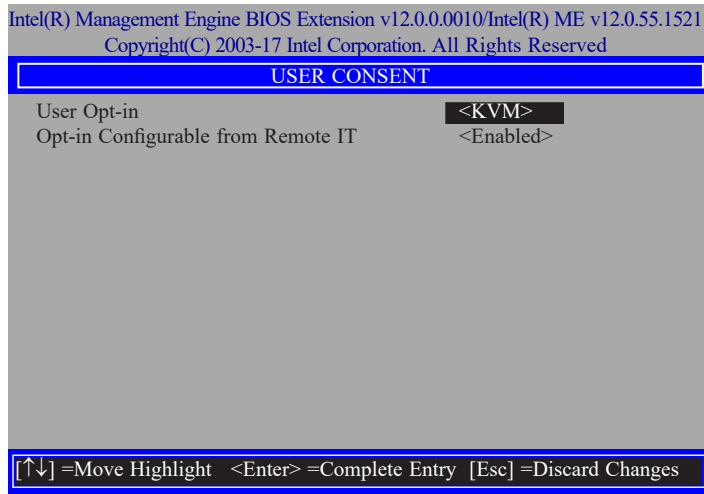

Move the cursor to select a field and press Enter to display options.

**User Opt-in**

Select **NONE** or **KVM** or **ALL** then press Enter.



**Opt-in Configurable from Remote IT**

Select **Enabled** or **Disabled** then press Enter.



Password Policy

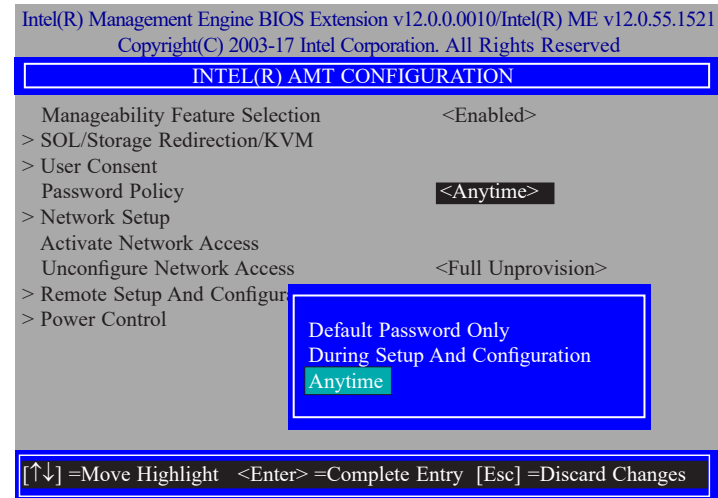

Under the **Intel(R) AMT Configuration** menu, select **Password Policy** then press Enter. You may choose to use a password only during setup and configuration or to use a password anytime the system is being accessed.

> Network Setup

Under the **Intel(R) AMT Configuration** menu, select **Network Setup** and then press Enter.

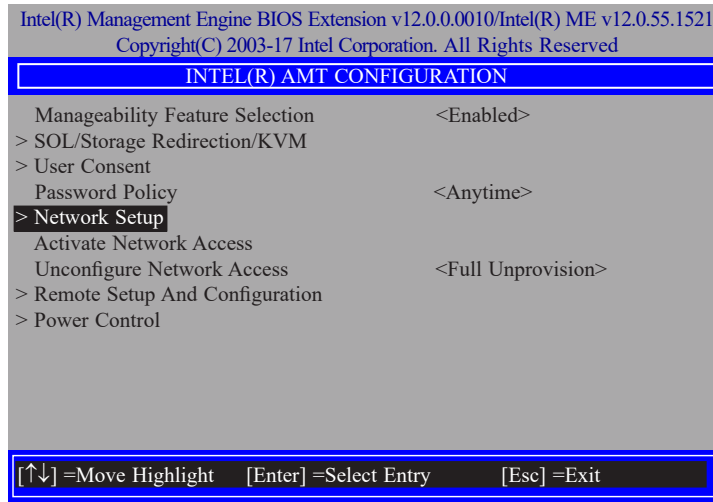

> Intel(R) ME Network Name Settings

Under the **Intel(R) ME Network Setup** menu, select **Intel(R) ME Network Name Settings** and then press Enter.

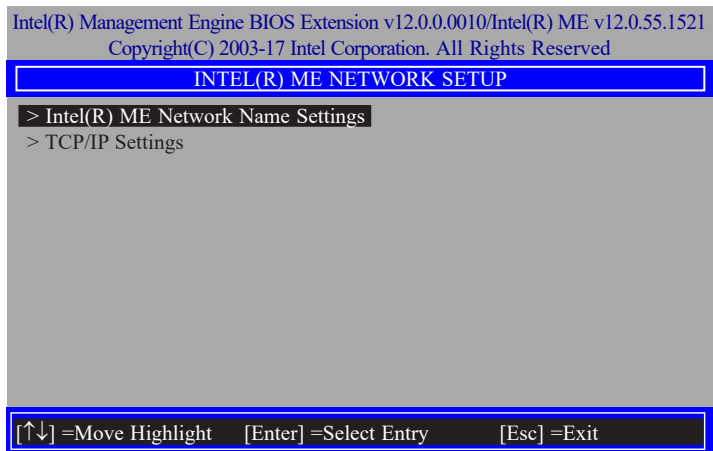

Move the cursor to select a field and press Enter to display options.

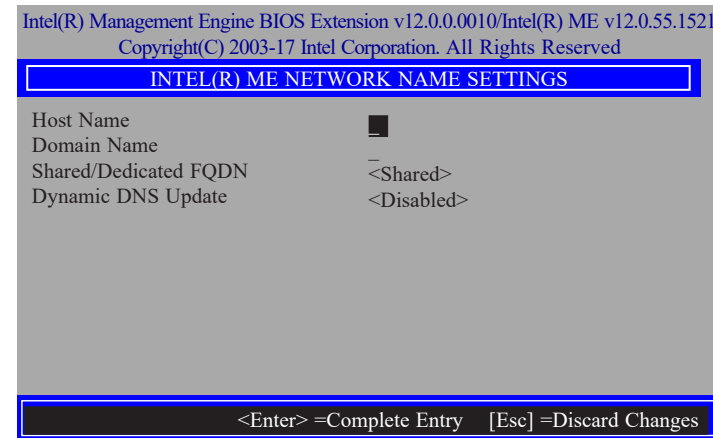

**Host Name**

Enter the computer's host name and then press Enter.



**Domain Name**

Enter the computer's domain name and then press Enter.



**Shared/Dedicated FQDN**

Select **Shared** or **Dedicated** and then press Enter.



### Dynamic DNS Update

Select Enabled or Disabled then press Enter. When Dynamic DNS Update is Enabled, the following fields will show up.



### Periodic Update Interval

Enter a value and then press Enter.

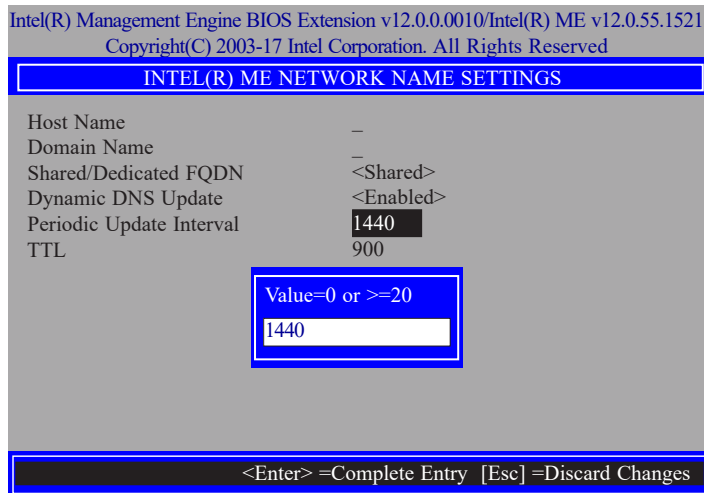

### TTL

Enter a value for the Time-to-live (TTL) field and then press Enter.

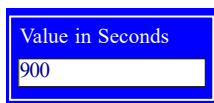

### > TCP/IP Settings

Under the Intel(R) ME Network Setup menu, select TCP/IP Settings and then press Enter.

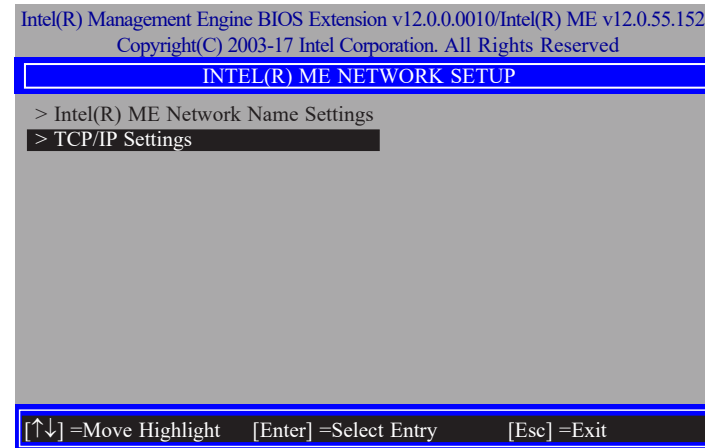

### > Wired LAN IPV4 Configuration

Under **TCP/IP Settings**, select **Wired LAN IPV4 Configuration** and then press Enter.

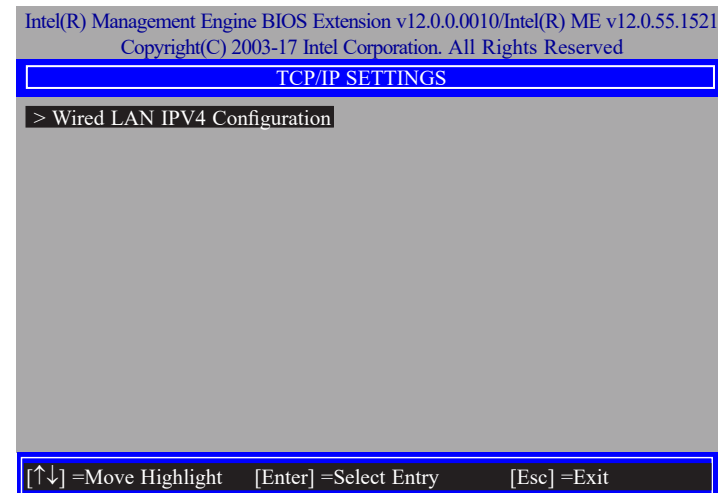

### DHCP Mode

Select **Enabled** or **Disabled** then press Enter. Please make sure there is a DHCP server in the network when this field is enabled.

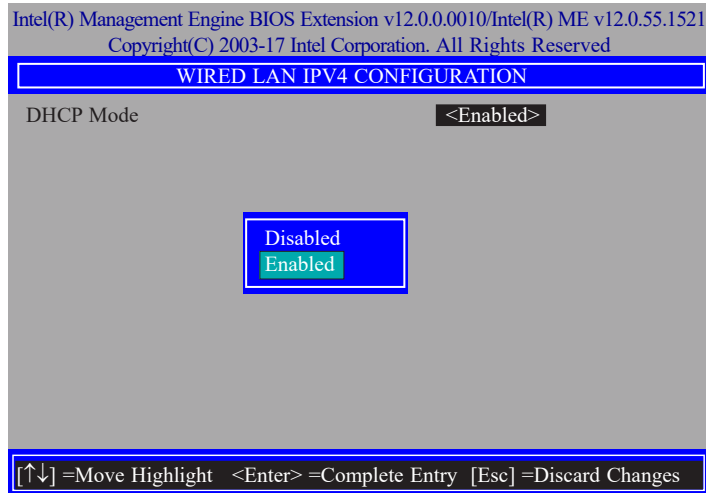

When DHCP is **Disabled**, please manually input a static route by configuring the fields as shown below.

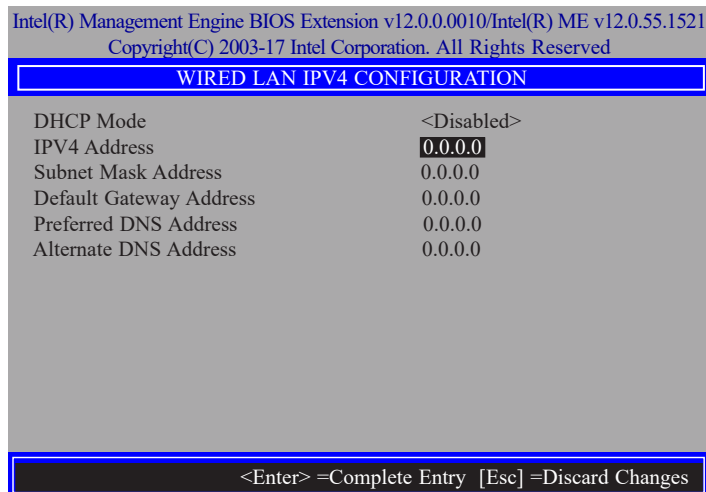

### IPv4 Address

Assign a valid and available IP address to the system. Insert a value from 0.0.0.0 to 255.255.255.255 in IPv4 format.

IP address (e.g. 123.123.123.100)

### Subnet Mask Address

Insert a value from 0.0.0.0 to 255.255.255.255 in IPv4 format.

Subnet mask (e.g. 255.255.255.0)

### Default Gateway Address

Insert a value from 0.0.0.0 to 255.255.255.255 in IPv4 format.

Default Gateway address

### Preferred DNS Address

Insert a value from 0.0.0.0 to 255.255.255.255 in IPv4 format.

Preferred DNS address

### Alternate DNS Address

Insert a value from 0.0.0.0 to 255.255.255.255 in IPv4 format.

Alternate DNS address



### Activate Network Access

Under the **Intel(R) AMT Configuration** menu, select **Activate Network Access** and press Enter, and then press Y to activate the ME network connection with the settings configured previously, or press N to abort.

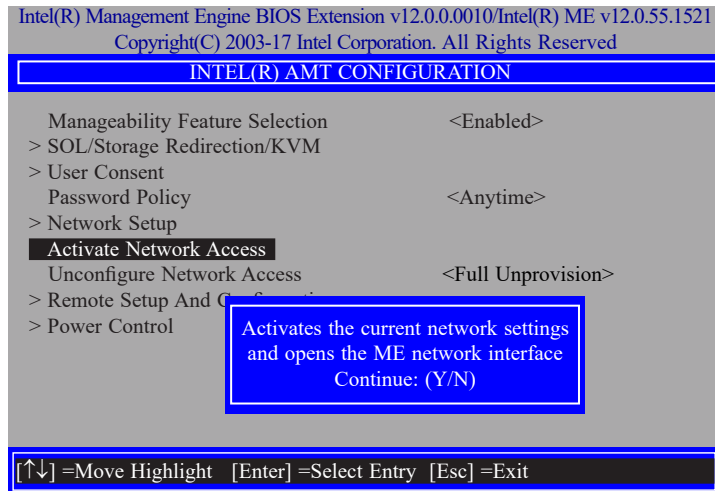

### Unconfigure Network Access

Under the **Intel(R) AMT Configuration** menu, select **Unconfigure Network Access** and press Enter, and then press Enter to fully deactivate the ME network connection and reset configuration to factory default. Press Y to confirm or N to abort.

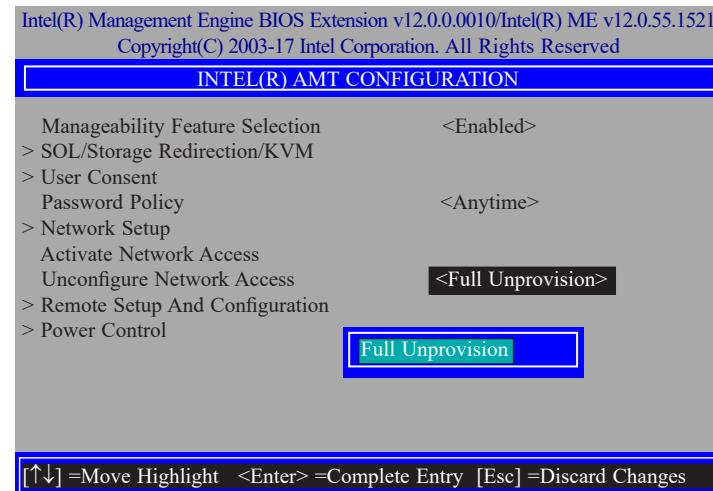

> Remote Setup And Configuration

Under the **Intel(R) AMT Configuration** menu, select **Remote Setup And Configuration** then press Enter.

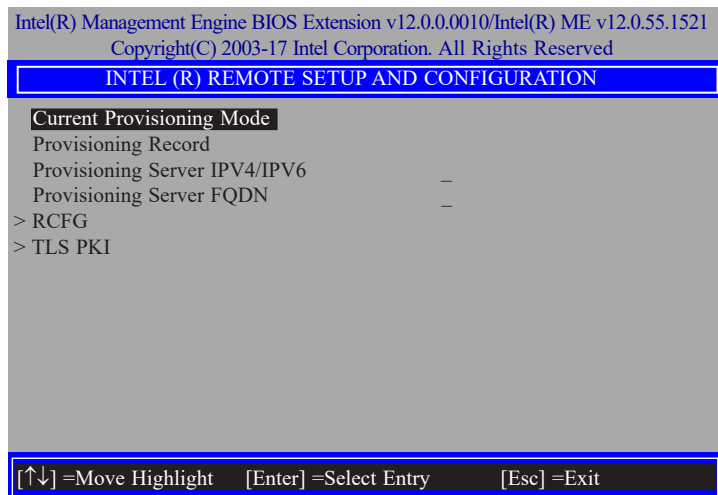
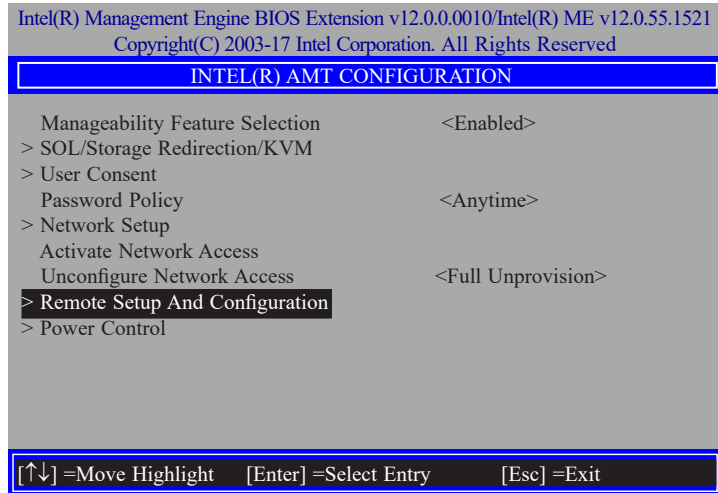

**Current Provisioning Mode**

The current mode – Public Key Infrastructure (PKI) – is displayed.



**Provisioning Record**

Press Enter to view the record.



**Provisioning Server IPV4/IPV6**

Enter the address of the server then press Enter, and then insert the TCP/UDP port number.

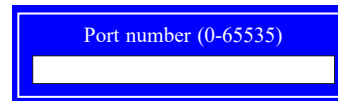
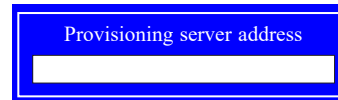

**Provisioning Server FQDN**

Enter the Fully Qualified Domain Name (FQDN) of the server and then press Enter.



> **RCFG**

Press Enter, select **Start Configuration**, and then press Enter to activate Remote Configuration (RCFG). Press Y to confirm or N to abort.

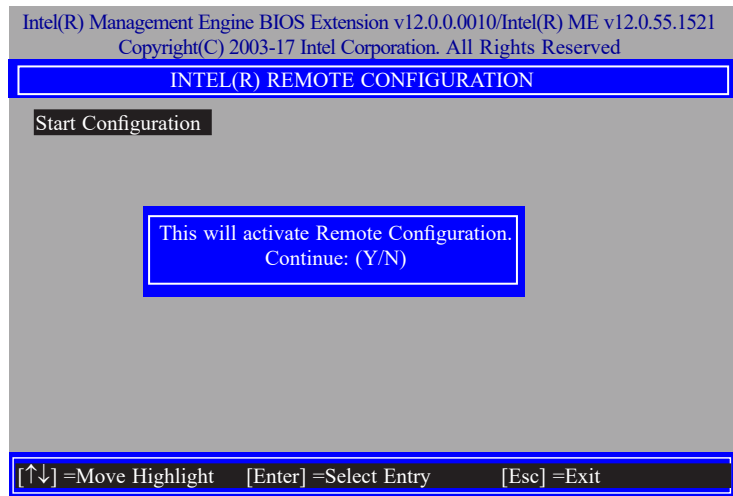

> **TLS PKI**

The system adopts PKI for encryption and authentication, and the TLS protocol for communication security to ensure remote configuration safety.

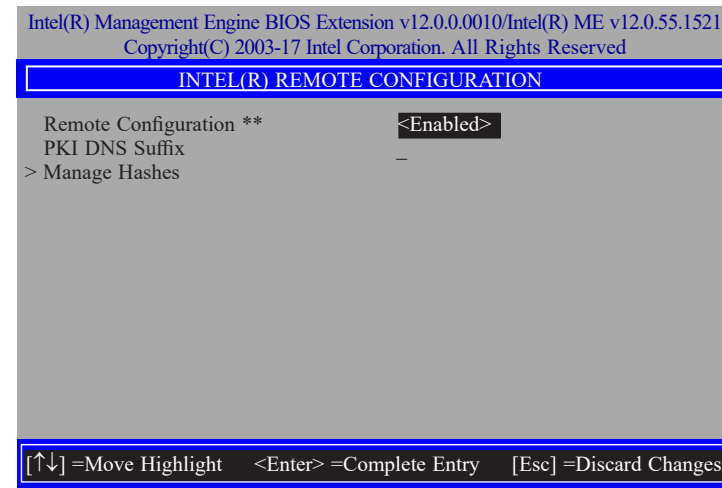

**Remote Configuration \*\***

Select **Enabled** or **Disabled** then press Enter.



**PKI DNS Suffix**

Specify the DNS Suffix of the PKI server, and then press Enter.



> Manage Hashes

Select a hash name and then press the following keys to execute a function.

- Insert – enter a custom hash certificate name,
- Delete – delete a hash
- Enter – view hash information
- + – activate or deactivate a hash
- Esc – exit

Intel(R) Management Engine BIOS Extension v12.0.0.0010/Intel(R) ME v12.0.55.1521  
Copyright(C) 2003-17 Intel Corporation. All Rights Reserved

**INTEL(R) REMOTE CONFIGURATION**

Hash Name	Active	Default	Algorithm
VeriSign Class 3	Active: [*]	Default: [*]	SHA256
VeriSign Class 3	Active: [*]	Default: [*]	SHA256
Go Daddy Class 2	Active: [*]	Default: [*]	SHA256
Comodo AAA CA	Active: [*]	Default: [*]	SHA256
Starfield Class 2	Active: [*]	Default: [*]	SHA256
VeriSign Class 3	Active: [*]	Default: [*]	SHA256
VeriSign Class 3	Active: [*]	Default: [*]	SHA256
VeriSign Class 3	Active: [*]	Default: [*]	SHA256
GTE CyberTrust G1	Active: [*]	Default: [*]	SHA256
Baltimore Cyber Tr	Active: [*]	Default: [*]	SHA256
Cyber Trust Global	Active: [*]	Default: [*]	SHA256
Verizon Global Ro	Active: [*]	Default: [*]	SHA256
Entrust. net CA (2	Active: [*]	Default: [*]	SHA256
Entrust Root CA	Active: [*]	Default: [*]	SHA256
VeriSign Universa	Active: [*]	Default: [*]	SHA256
Go Daddy Root CA	Active: [*]	Default: [*]	SHA256
Entrust Root CA -	Active: [*]	Default: [*]	SHA256
Startfield Root CA	Active: [*]	Default: [*]	SHA256

[Ins] =Add New Hash    [Delete] =Delete Hash    [+] =Activate Hash  
[↑↓] =Move Highlight    [Enter] =View Hash    [Esc] =Exit

> Power Control

Under the Intel(R) AMT Configuration menu, select Power Control then press Enter.

Intel(R) Management Engine BIOS Extension v12.0.0.0010/Intel(R) ME v12.0.55.1521  
Copyright(C) 2003-17 Intel Corporation. All Rights Reserved

**INTEL(R) AMT POWER CONTROL**

These configurations are effective only after AMT provisioning has started

Intel(R) AMT ON in Host Sleep States <Desktop: ON in S0, ME Wake in S3, S4-5>

Idle Timeout 65535

[↑↓] =Move Highlight    <Enter> =Complete Entry    [Esc] =Discard Changes

Intel(R) AMT ON in Host Sleep States

Select an option and then press Enter.

Desktop: ON in S0  
Desktop: ON in S0, ME Wake in S3, S4-5

Idle Timeout

Enter a timeout value and press Enter.

Timeout Value (1-65535)  
65535

► **MEBX**

**MEBx Exit**

Under the Main Menu, select MEBx Exit and then press Enter. Press Y to confirm or N to abort.

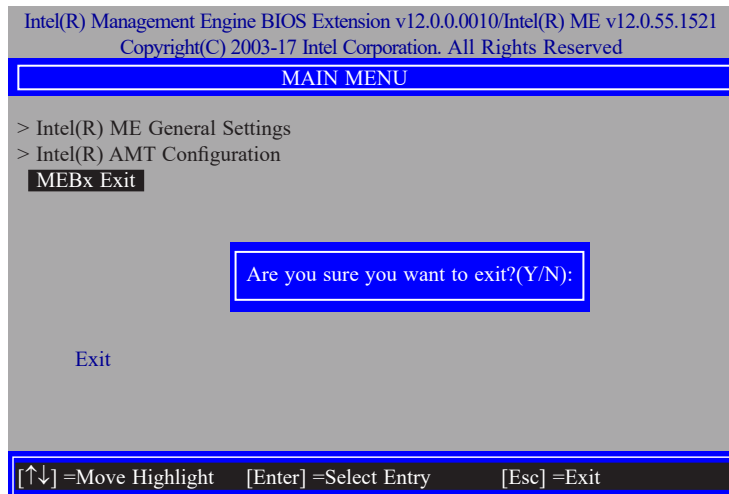

## Chapter 5 - RAID

The system board allows configuring RAID on Serial ATA drives. It supports RAID 0, RAID 1.

### ► RAID Levels Explanation

#### RAID 0 (Striped Disk Array without Fault Tolerance)

RAID 0 uses two new identical hard disk drives to read and write data in parallel, interleaved stacks. Data is divided into stripes and each stripe is written alternately between two disk drives. This improves the I/O performance of the drives at different channel; however it is not fault tolerant. A failed disk will result in data loss in the disk array.

#### RAID 1 (Mirroring Disk Array with Fault Tolerance)

RAID 1 copies and maintains an identical image of the data from one drive to the other drive. If a drive fails to function, the disk array management software directs all applications to the other drive since it contains a complete copy of the drive's data. This enhances data protection and increases fault tolerance to the entire system. Use two new drives or an existing drive and a new drive but the size of the new drive must be the same or larger than the existing drive.

#### RAID 5

RAID 5 stripes data and parity information across hard drives. It is fault tolerant and provides better hard drive performance and more storage capacity.

#### RAID 10 (Mirroring and Striping)

RAID 10 is a combination of data striping and data mirroring providing the benefits of both RAID 0 and RAID 1. Use four new drives or an existing drive and three new drives for this configuration.

RAID Level	Min. Drives	Protection	Description
RAID 0	2	None	Data striping without redundancy
RAID 1	2	Single Drive Failure	Disk mirroring
RAID 5	3	Single Drive Failure	Block-level data striping with distributed parity
RAID 10	4	1 Disk Per Mirrored Stripe (not same mirror)	Combination of RAID 0 (data striping) and RAID 1 (mirroring)

### ► Setup Procedure

To enable the RAID function, the following settings are required.

1. Install SATA drives.
2. Enable RAID in the Insyde BIOS.
3. Create a RAID volume.
4. Install the Intel Rapid Storage Technology Utility.

#### Step 1: Install SATA Drives

Refer to chapter 2 for details on connecting the Serial ATA drives.



#### Important:

1. Please make sure the SATA drives that you are to create a RAID volume with are connected and powered, and are able to be detected by the system. Otherwise, the RAID BIOS utility would not be accessible.
2. While creating a RAID volume, please make sure the system, drives, and cables are perfectly steady and mounted correctly. Disturbance during creating a RAID volume will result in irreversible data corruption stored on the drive.

#### Step 2: Enable RAID in the AMI BIOS

1. Power-on the system then press <Del> to enter the main menu of the AMI BIOS.
2. Go to "Chipset" menu and select the "PCH-IO Configuration" menu then "SATA And RST Configuration" menu.
3. Change the "SATA Mode Selection" to "Intel RST Premium With Intel Optane System Acceleration" mode.
4. Press F10 to save the changes.
5. Reboot the system.

### Step 3: Create a RAID Volume

1. Go to the “Advanced” menu of the AMI BIOS and select “Intel(R) Rapid Storage Technology”.

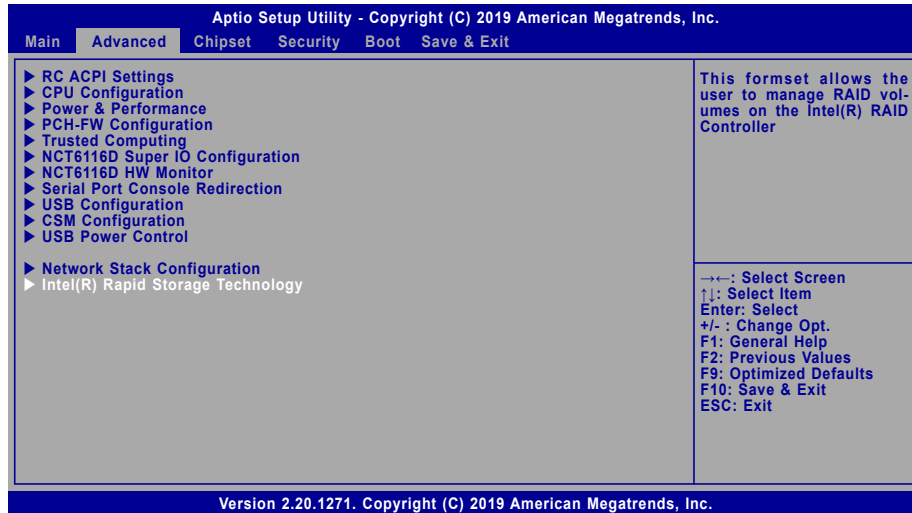

2. The screen displays all available drives. Select “Create RAID volume” to create a RAID volume”.
3. Use the up or down arrow keys to select the RAID level and press <Enter>.
4. Use the up or down arrow keys to scroll through the list of hard drives and press <Enter> to select the drive.
5. Press <Enter>.
6. Use the up or down arrow keys to select the strip size and press <Enter>.
7. Enter the volume size and press <Enter>.
8. At the prompt, press <Y> to confirm volume creation.

### Step 4: Install the Intel Rapid Storage Technology Utility

The Intel Rapid Storage Technology Utility can be installed from within Windows. It allows RAID volume management (create, delete, migrate) from within the operating system. It will also display useful SATA device and RAID volume information. The user interface, tray icon service and monitor service allow you to monitor the current status of the RAID volume and/or SATA drives. It enables enhanced performance and power management for the storage subsystem.