



APLEX



ARCHMI-8XXB Series

7", 8", 10.1", 12.1", 12.1W", 15", 15.6", 17", 18.5", 19", 21.5" and 23.8"

Intel Elkhart Lake

Fanless Industrial Compact Size Panel PC

User Manual

Release Date

Oct.2023

Revision

V1.0

©2023 Aplex Technology, Inc.

All Rights Reserved.

Published in Taiwan

Aplex Technology, Inc.

15F-1, No.186, Jian Yi Road, Zhonghe District, New Taipei City 235, Taiwan

Tel: 886-2-82262881 Fax: 886-2-82262883 Email: aplex@aplex.com URL: <http://www.aplex.com>

Revision History

Reversion	Date	Description
1.0	2023/10/19	Initiation

Warning!

This equipment generates uses and can radiate radio frequency energy and if not installed and used in accordance with the instructions manual, it may cause interference to radio communications. It has been tested and found to comply with the limits for a Class A computing device pursuant to FCC Rules, which are designed to provide reasonable protection against such interference when operated in a commercial environment. Operation of this equipment in a residential area is likely to cause interference in which case the user at his own expense will be required to take whatever measures may be required to correct the interference.

Electric Shock Hazard – Do not operate the machine with its back cover removed. There are dangerous high voltages inside.

Caution

Risk of explosion if the battery is replaced with an incorrect type.

Batteries should be recycled where possible. Disposal of used batteries must be in accordance with local environmental regulations.

Disclaimer

This information in this document is subject to change without notice. In no event shall Apex Technology Inc. be liable for damages of any kind, whether incidental or consequential, arising from either the use or misuse of information in this document or in any related materials.

Safety Precautions

Follow the messages below to prevent your systems from damage:

- ◆ Avoid your system from static electricity on all occasions.
- ◆ Prevent electric shock. Don't touch any components of this card when the card is power-on. Always disconnect power when the system is not in use.
- ◆ Disconnect power when you change any hardware devices. For instance, when you connect a jumper or install any cards, a surge of power may damage the electronic components or the whole system.

Table of Contents

Revision History	1
Warning!	2
Safety Precautions	3
Chapter 1 System Product	6
1.1 Features	6
1.2 Specifications	6
1.3 Display	9
Standard LCD	9
High Brightness LCD	10
1.4 System Mechanism Information	11
1.5 Power Consumption and PoE Application	11
1.6 Dimensions	12
1.7 Brief Description of ARCHMI-8XXB Series	18
1.8 VESA Mounting	30
1.9 Panel Mounting	30
Chapter 2 Hardware	31
2.1 Specifications	31
2.2 Board Dimensions	33
2.3 Jumpers and Connectors Location	34
2.4 Jumpers Setting and Connectors	35
Chapter 3 BIOS Setup Description	52
3.1 Operations after POST Screen	52
3.2 BIOS SETUP UTILITY	52
3.3 Main Settings	53
3.4 Advanced Settings	54
3.5 Chipset Settings	71
3.6 Security Settings	108
3.7 Boot Settings	109
3.8 Save & Exit Settings	110
Chapter 4 Installation of Drivers	112
4.1 Intel Chipset	113
4.2 Intel® HD Graphics Chipset	116
4.3 Realtek HD Audio Driver Installation	119
4.4 Intel® Management Engine Interface	121
4.5 LAN Driver	124
4.6 Touch Screen Installation	127

Figures

Figure 1: Dimensions of ARCHMI-807BP/BR(H).....	14
Figure 2: Dimensions of ARCHMI-808BP/BR(H).....	14
Figure 3: Dimensions of ARCHMI-810BP/BR(H).....	15
Figure 4: Dimensions of ARCHMI-812BP/BR(H).....	15
Figure 5: Dimensions of ARCHMI-812WBP/WBR(H).....	16
Figure 6: Dimensions of ARCHMI-815BP/BR(H).....	16
Figure 7: Dimensions of ARCHMI-816BP/BR(H).....	17
Figure 8: Dimensions of ARCHMI-817BP/BR(H).....	17
Figure 9: Dimensions of ARCHMI-818BP/BR(H).....	18
Figure 10: Dimensions of ARCHMI-819BP/BR(H).....	18
Figure 11: Dimensions of ARCHMI-821BP/BR(H).....	19
Figure 12: Dimensions of ARCHMI-824BP(H).....	19
Figure 13: Front View of ARCHMI-807BP/BR(H).....	21
Figure 14: Rear View of ARCHMI-807BP/BR(H).....	21
Figure 15: Front View of ARCHMI-808BP/BR(H).....	22
Figure 16: Rear View of ARCHMI-808BP/BR(H).....	22
Figure 17: Front View of ARCHMI-810BP/BR(H).....	23
Figure 18: Rear View of ARCHMI-810BP/BR(H).....	23
Figure 19: Front View of ARCHMI-812BP/BR(H).....	24
Figure 20: Rear View of ARCHMI-812BP/BR(H).....	24
Figure 21: Front View of ARCHMI-812WBP/WBR(H).....	25
Figure 22: Rear View of ARCHMI-812WBP/WBR(H).....	25
Figure 23: Front View of ARCHMI-815BP/BR(H).....	26
Figure 24: Rear View of ARCHMI-815BP/BR(H).....	26
Figure 25: Front View of ARCHMI-816BP/BR(H).....	27
Figure 26: Rear View of ARCHMI-816BP/BR(H).....	27
Figure 27: Front View of ARCHMI-817BP/BR(H).....	28
Figure 28: Rear View of ARCHMI-817BP/BR(H).....	28
Figure 29: Front View of ARCHMI-818BP/BR(H).....	29
Figure 30: Rear View of ARCHMI-818BP/BR(H).....	29
Figure 31: Front View of ARCHMI-819BP/BR(H).....	30
Figure 32: Rear View of ARCHMI-819BP/BR(H).....	30
Figure 33: Front View of ARCHMI-821BP/BR(H).....	31
Figure 34: Rear View of ARCHMI-821BP/BR(H).....	31
Figure 35: Front View of ARCHMI-824BP(H).....	31
Figure 36: Rear View of ARCHMI-824BP(H).....	31
Figure 37: ARCHMI-8XXB VESA Mounting.....	32
Figure 38: ARCHMI-8XXB Panel Mounting.....	32

1.1 Features

- Industrial Compact Size Panel PC
- Flat front panel touch screen
- Fanless Design
- Onboard Intel Atom x6000 series, Pentium & Celeron N and J Series Processors(by project)
- One SO-DIMM Slot up to 32GB DDR4 3200MHz SDRAM
- DC 9~36V wide-ranging power input
- IP66 compliant front panel
- Optional projected capacitive touchscreen support 7H anti-scratch surface
- Support High brightness LCD

1.2 Specifications

ARCHMI-8XXB	
System	
CPU	Intel®Atom®x6425E (1.8GHz/3.0GHz, 1.5MB L2 cache, 12W TDP) (option by project) Intel®Atom®x6413E (1.5GHz/3.0GHz, 1.5MB L2 cache, 9W TDP) (option by project) Intel®Atom®x6211E (1.2GHz/3.0GHz, 1.5MB L2 cache, 6W TDP) (option by project) Intel®Celeron®J6412 (1.8GHz/2.60GHz, 1.5MB L2 cache, 10W TDP) (default)
Chipset	SoC
Memory	Up to 64GB DDR4-3200 SDRAM (one SO-DIMM slot)
Graphic	Intel® Elkhart Lake SoC integrated Graphics
IO Port	
USB	2 x USB 3.2 Gen2 type A 2 x USB2.0, type A
Serial/Parallel	1 x RS-232/422/485 (Default RS-232, pin9 RI(default)/5V/12V, select via BIOS, DB9 (COM1))
Audio	1 x Audio Line Out
LAN	2 x 2.5GbE LAN RJ-45
DP	1 x DP Port (v1.4, support DP++, up to 4096x2160@60Hz)
Power	1 x 3-pin DC Power Input terminal 1 x 2-pin connector for power on/off button
Option	TB-528 Series: 1. 4 x USB2.0 type A (TB-528U4) 2. 4 x USB2.0 type A + 1 x Mini-PCIe + 1 x SIM slot (TB-528U4ME1) 3. 1 x COM(RS-232) + 2 x USB2.0 + 1 x Power Button(TB-528C1U2P1) 4. 1 x COM(RS-232) + 2 x USB2.0 + 1 x Mini PCIe slot(TB-528C1U2P1ME1)

	<p>5. 2 x CAN (TB-528CAN2)</p> <p>6. 2 x COM(RS-232) + 1 x Mini-PCIe slot (TB-528C2ME1)</p> <p>7. 2 x COM(RS-232) (TB-528C2)</p> <p>8. 1 x COM(RS-232) + 2 x USB2.0 (TB-528C1U2)</p> <p>9. 2 x COM(RS-422/485, isolated) (TB-528C2I)</p> <p>10. 1 x LAN +2 x USB 2.0 type A (TB-528E1U2)</p> <p>Smart battery (Turbo OFF in BIOS; new PCBA PB-434 must be installed with smart battery, keep the system working at least 30 mins, depend on different size)</p> <p>Speaker (Through TB-38)</p> <p>Auto Dimming (Through TB-38)</p> <p>GPIO (4xDI, 4xDO, through TB-542)</p> <p>WIFI (Through M.2 converter to mPCIe module, or through mPCIe WiFi module)</p> <p>LTE 4G, WWAN module</p> <p>(I/O Board TB-528 Series and UPS can only be either one choice in 12.1" models)</p> <p>*MB for POE and Backup Battery are different from Standard MB version</p>
--	--

Storage Space

Storage	<p>1 x M.2 B Key (SATA III), for 2242/2280 (7" and 8" only 2242)</p> <p>1 x 2.5" SATAIII HDD (Option)</p> <p>*2280 and 2.5" SSD are exclusive with 528 series</p>
---------	---

Expansion

Expansion Slot	<p>1 x Internal Mini-PCIe slot full size (reserved for mSATA, mPCIe module)</p> <p>1 x M.2 2230 E-Key socket support PCIe/USB Wi-Fi/BT module</p> <p>1 x Nano SIM card/Micro SD card holder</p>
----------------	---

Touch Screen – Resistive Touch Window Type (not for 23.8")

TS Control	PenMount 6000 on Board
Interface	USB
Light Transmission	80%

Touch Screen – Projected Capacitive Type

Interface	USB
Light Transmission	90%

Wireless LAN , WWAN and Antenna

Wireless LAN	M.2 module card (option)
WWAN	LTE via Mini-PCIe module card full-size(option)
Antenna	2 x SMA-female connector's holes for external antenna

Watchdog Timer

Watchdog Timer	1-255 levels
----------------	--------------

Power

Power Input	<p>DC 9~36V (onboard, w/terminal block) (7~23.8")</p> <p>Power on AT/ATX supported, default AT mode</p> <ul style="list-style-type: none"> ● AT: Directly PWR on as power input ready ● ATX: Press button to PWR on after power input ready
-------------	---

	23.8" with 120W power adapter input Support POE++ through TB-528E1U2UPOE (depends on real power consumption)
Backup Battery	
Backup battery	21W(option) *When the Backup battery is installed; it cannot run full loading program; it may cause the system shut-down
Mechanical	
Mechanical Construction	Aluminum die-casting chassis
Front Bezel Metal	Aluminum/Panel Mounting
Mounting	Panel Mount/VESA Mount
Chassis Color	RAL 9007
IP Rating	Front Panel IP66 compliance
Operating System Support	
OS Support	Windows 10 IoT Enterprise; Windows 11 Linux Ubuntu 20.04 above
Environmental	
Operating Temperature	0~50°C(21.5" above) -20°C to 60°C optional
Storage Temperature	-20~60°C
Humidity	10 to 95% @ 40°C, non-condensing
Certification	CE / FCC Class B

1.3 Display

Standard LCD

	ARCHMI-807BP/R	ARCHMI-808BP/R	ARCHMI-810BP/R	ARCHMI-812BP/R	ARCHMI-812WBP/R
Display Type	7" TFT LCD	8" TFT LCD	10" TFT LCD	12.1" TFT LCD	12.1W" TFT LCD
Max. Resolution	800 x 480	800 x 600	1280 x 800	800 x 600 1024 x 768	1280 x 800
Max. Color	262K	262K	16.7M	16.2M	16.7M
Luminance(cd/m ²)	350	450	350	450-HD 500-XGA	600
Contrast Ratio	1000:1	500:1	800:1	1000:1	1000:1
Viewing angle(H/V)	160 /160	140 /130	170 / 170	176 / 176 178 / 178	170 / 170
Backlight Lifetime (Hrs)	40,000	40,000	30,000	50,000 30,000	50,000

	ARCHMI-815BP/R	ARCHMI-816BP/R	ARCHMI-817BP/R	ARCHMI-818BP/R	ARCHMI-819BP/R
Display Type	15" TFT LCD	15.6" TFT LCD	17" TFT LCD	18.5" TFT LCD	19" TFT LCD
Max. Resolution	1024 x 768	1366 x 768 1920 x 1080	1280 x 1024	1366 x 768 1920 x 1080	1280 x 1024
Max. Color	16.2M/16.7M	16.7M	16.2M/16.7M	16.7M	16.7M
Luminance(cd/m ²)	300/350	400 500	350	250 300/350	350
Contrast Ratio	2000:1/1000:1	500:1 1000:1	1000:1	1000:1	1000:1
Viewing angle(H/V)	170/170	170/160 178/178	160/140	170/160 178/178	170/160
Backlight Lifetime (Hrs)	70,000/50,000	50,000	50,000	50,000	50,000

	ARCHMI-821BP/R	ARCHMI-824BP/R
Display Type	21.5" TFT LCD	23.8" TFT LCD
Max. Resolution	1920 x 1080	1920 x 1080
Max. Color	16.7M	16.7M
Luminance(cd/m ²)	250	250
Contrast Ratio	3000:1	3000:1
Viewing angle(H/V)	178/178	178/178
Backlight Lifetime (Hrs)	30,000	30,000

High Brightness LCD

	ARCHMI-807BP/RH	ARCHMI-808BP/RH	ARCHMI-810BP/RH	ARCHMI-812BP/RH	ARCHMI-812WBP/RH
Display Type	7" TFT LCD	8" TFT LCD	10" TFT LCD	12.1" TFT LCD	12.1W" TFT LCD
Max. Resolution	800 x 480	800 x 600	1280 x 800	800 x 600 1024 x 768	1280 x 800
Max. Color	262K	262K	16.2M	16.7M/16.2M	16.7M
Luminance(cd/m ²)	1000				
Contrast Ratio	1000:1	500:1	1300:1	1000:1	1000:1
Viewing angle(H/V)	160 /160	140 /130	168 / 168	170 / 160	178 / 178
Backlight Lifetime (Hrs)	40,000	40,000	50,000	50,000	30,000

	ARCHMI-815BP/RH	ARCHMI-816BP/RH	ARCHMI-817BP/RH	ARCHMI-818BP/RH	ARCHMI-819BP/RH
Display Type	15" TFT LCD	15.6" TFT LCD	17" TFT LCD	18.5" TFT LCD	19" TFT LCD
Max. Resolution	1024 x 768	1366 x 768 1920 x 1080	1280 x 1024	1366 x 768 1920 x 1080	1280 x 1024
Max. Color	16.7M	16.7M	16.7M	16.7M	16.7M
Luminance(cd/m ²)	1000				
Contrast Ratio	1000:1	1000:1	3000:1	3000:1	3000:1
Viewing angle(H/V)	170/170	170/160	178/178	178/178	178/178
Backlight Lifetime (Hrs)	50,000	50,000	30,000	30,000	30,000

	ARCHMI-821BP/RH	ARCHMI-824BP/RH
Display Type	21.5" TFT LCD	23.8" TFT LCD
Max. Resolution	1920x1080	1920 x 1080
Max. Color	16.7M	16.7M
Luminance(cd/m ²)	1000	
Contrast Ratio	1000:1	1000:1
Viewing angle(H/V)	170/170	170/160
Backlight Lifetime (Hrs)	50,000	50,000

1.4 System Mechanism Information

	ARCHMI-807B(H)	ARCHMI-808B(H)	ARCHMI-810B(H)	ARCHMI-812B(H)	ARCHMI-812WB(H)
Mounting	VESA Mount 75 x 75 mm		VESA Mount 100 x 100 mm		
Dimensions(mm)	202x149x40	231.1x176.1x50	285x189x48.9	319x245x51.7	328x227x57.6
Net Weight(Kg)	1.1	1.8	1.85	2.73	3.03
	ARCHMI-815B(H)	ARCHMI-816B(H)	ARCHMI-817B(H)	ARCHMI-818B(H)	ARCHMI-819B(H)
Mounting	VESA Mount 100 x 100				
Dimensions(mm)	410x310x54.67	412x277.5x58.9	439x348x64.8	499.6x314.6x65.4	460x380x64.8
Net Weight	4.53	3.92	6.07	6.55	TBD
	ARCHMI-821B(H)	ARCHMI-824B(H)			
Mounting	VESA Mount 100 x 100				
Dimensions(mm)	557.3x362.3x64.8	640x395x65.1			
Net Weight	7.11	TBD			

1.5 Power Consumption and PoE Application

Max power consumption of each model

Model	Max Power Consumption	PoE+(30W)	PoE++(45W)
ARCHMI-807B	30W	n	n
ARCHMI-808B	32W	n	n
ARCHMI-810B	34W	n	Y
ARCHMI-812B	40W	n	Y
ARCHMI-812WB	TBD	n	Y
ARCHMI-815B	40W	n	Y
ARCHMI-816B	40W	n	Y
ARCHMI-817B	46W	n	n
ARCHMI-818B	50W	n	n
ARCHMI-819B	TBD	n	n
ARCHMI-821B	50W	n	n
ARCHMI-824B	TBD	n	n

* Max Power Consumption: Backlight bright setting 100%,+Turbo on+ System full loading with full rear IO connectors.

* Power consumption may have 10% tolerance difference due to different MB, parts, test instrument, and so on.

* y* means: system turbo off+ rear IO no loading+ LED backlight down to 70%, and the PSE cable connect to the system needs to be shorter than 50m. If you need some IO loading, please find your sales representative to discuss.

* y* does not apply in Linux OS.

* We suggest to use the adapter that Apex approved. If you would like to adopt your own power supply or adapter, please add another 20-30% from the above power consumption to make sure the system can work correctly.

1.6 Dimensions

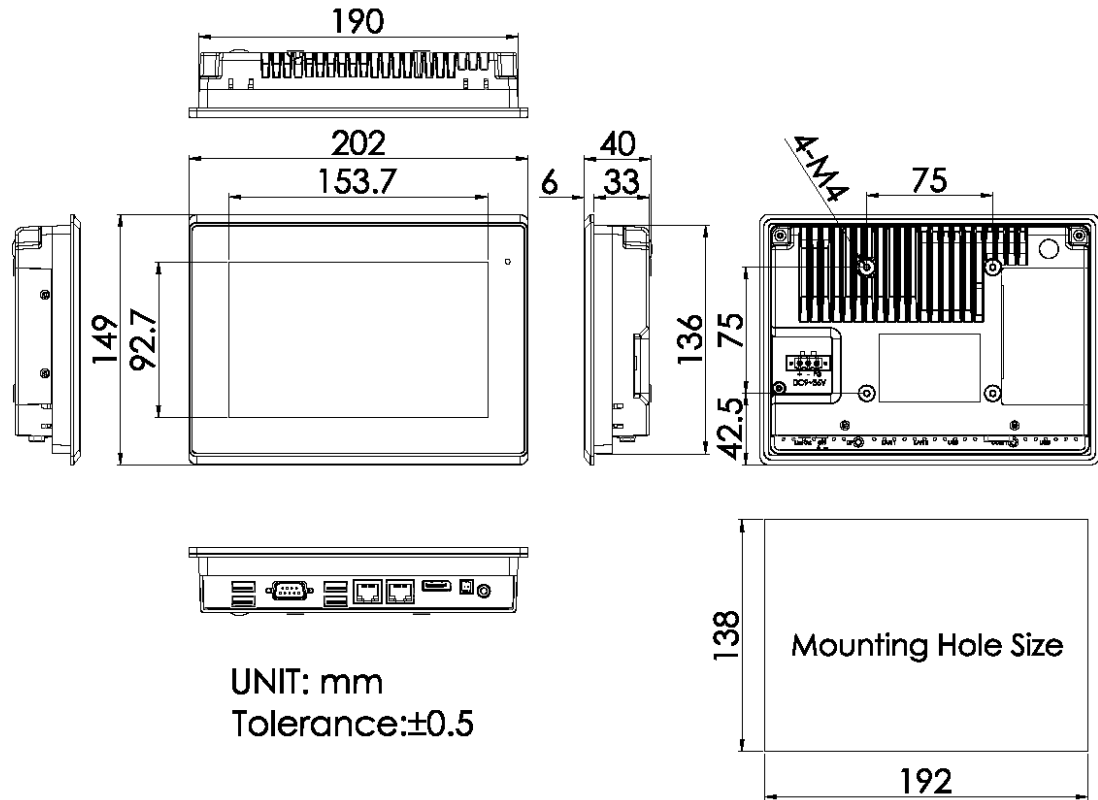

Figure 1 Dimensions of ARCHMI-807BP/BR(H)

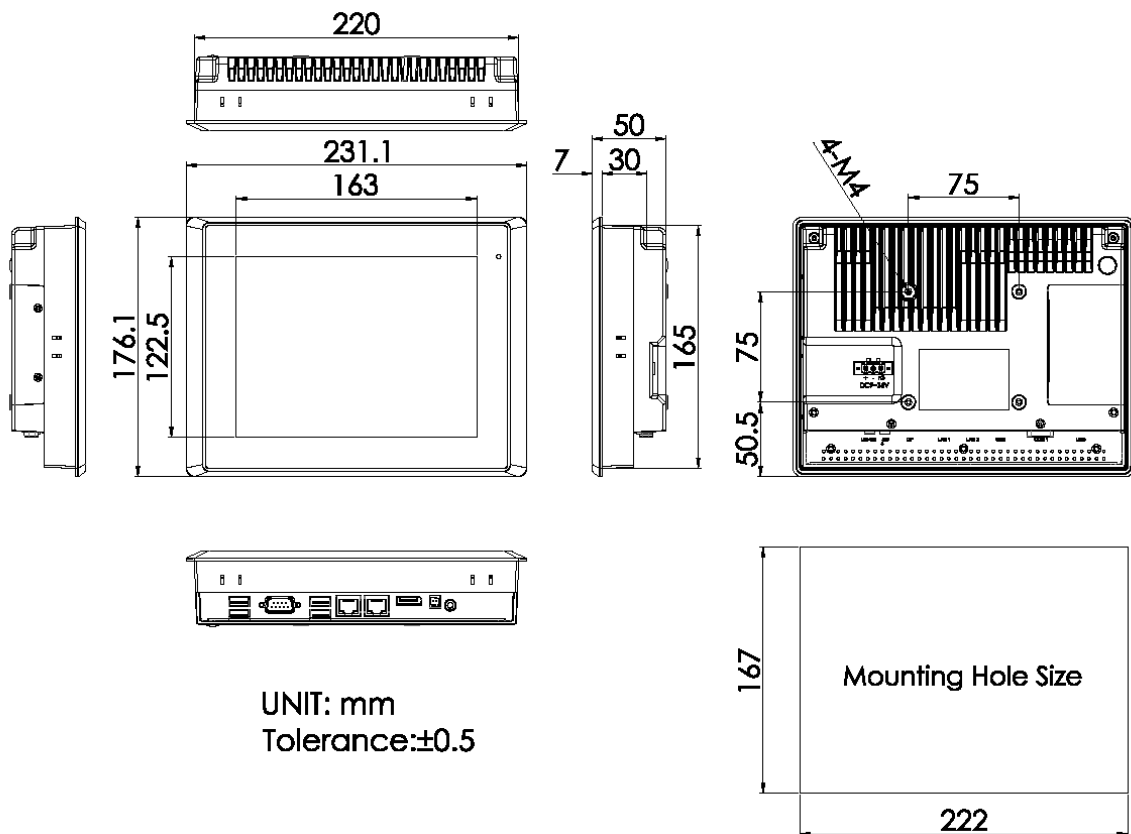

Figure 2 Dimensions of ARCHMI-808BP/BR(H)

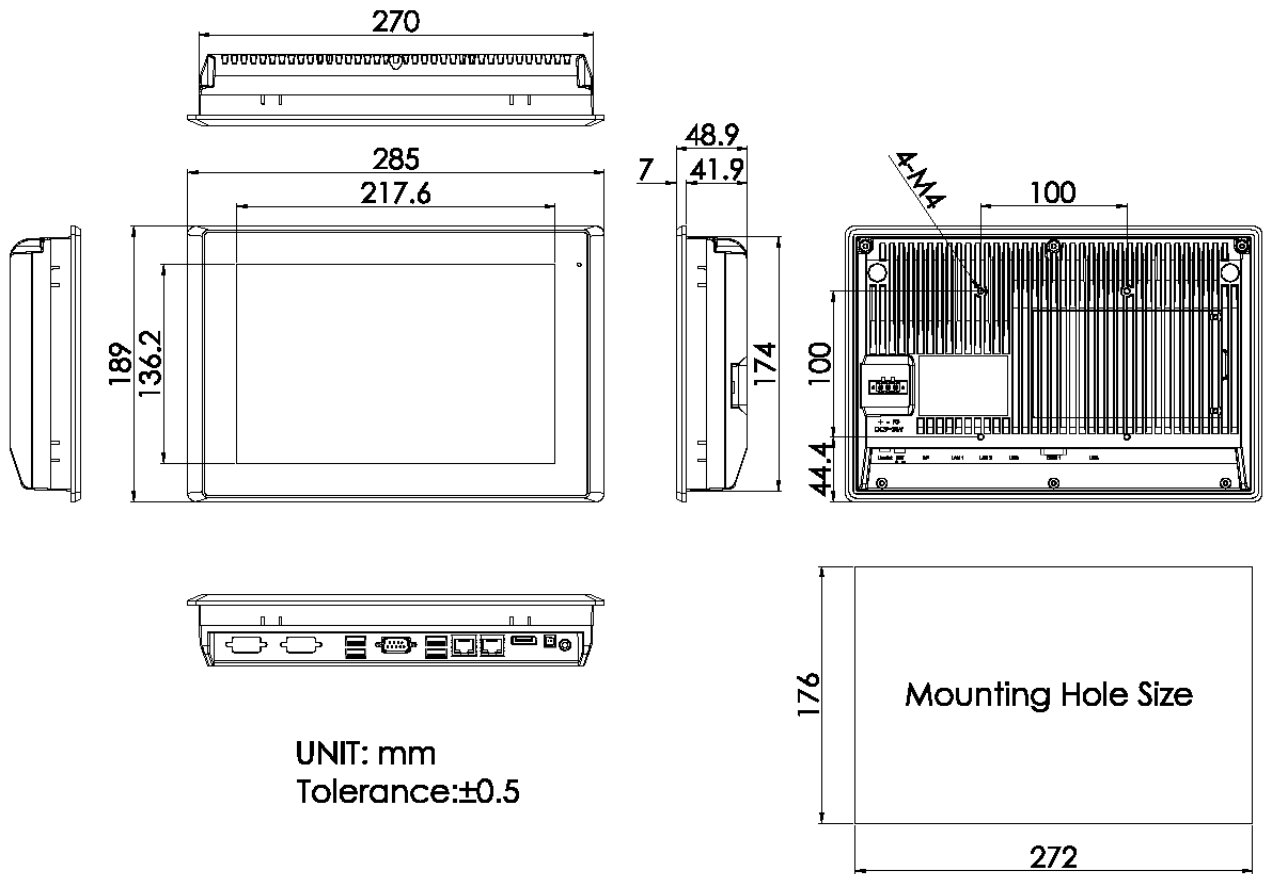

Figure 3 Dimensions of ARCHMI-810BP/BR(H)

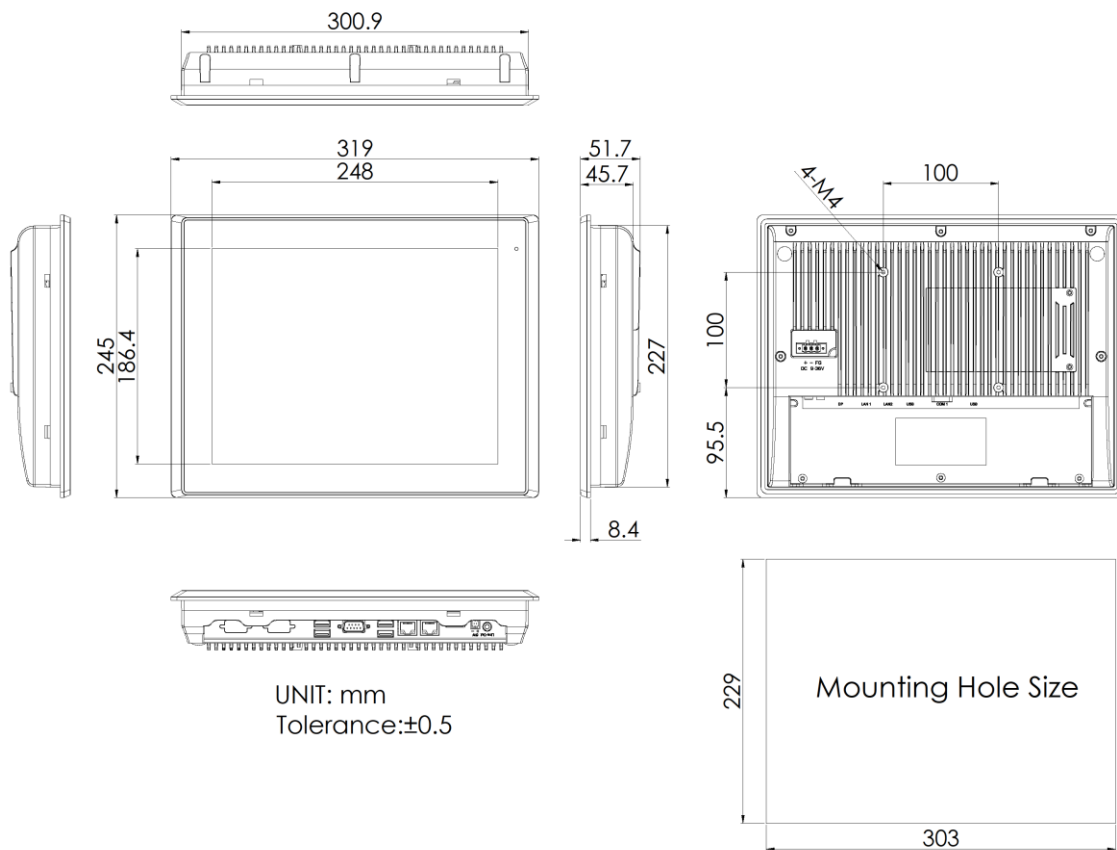

Figure 4 Dimensions of ARCHMI-812BP/BR(H)

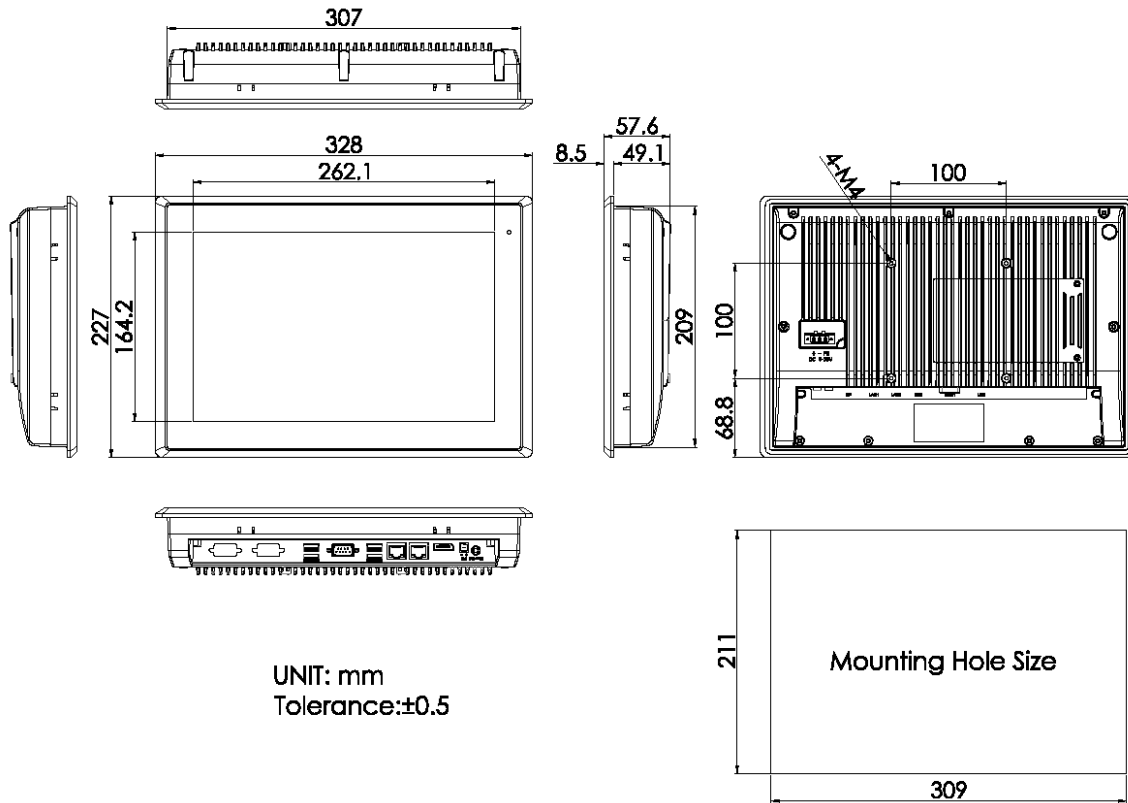

Figure 5 Dimensions of ARCHMI-812WBP/BR(H)

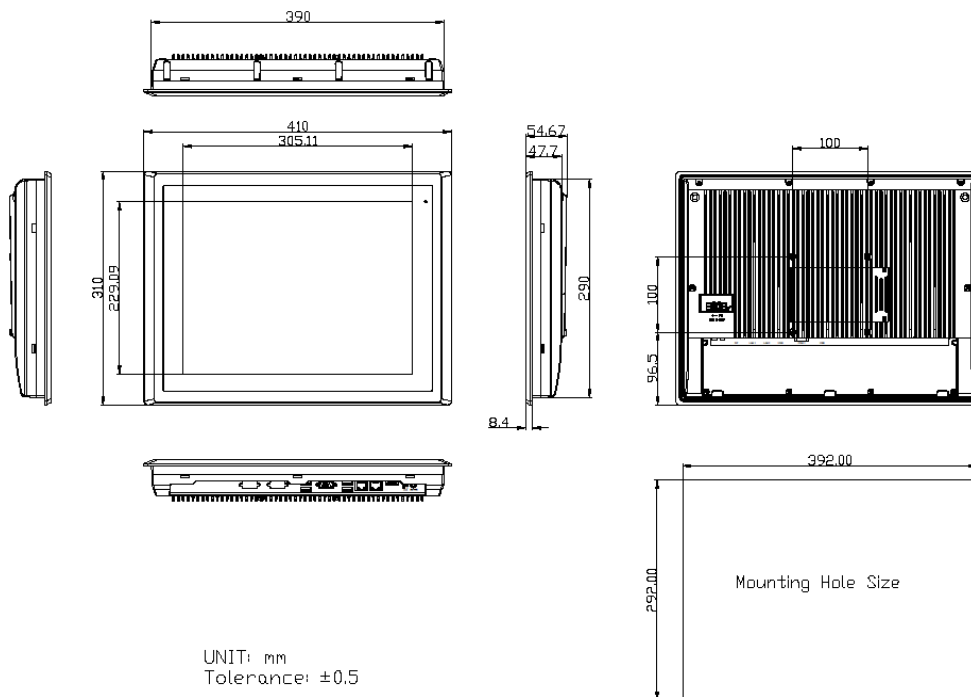

Figure 6 Dimensions of ARCHMI-815BP/BR(H)

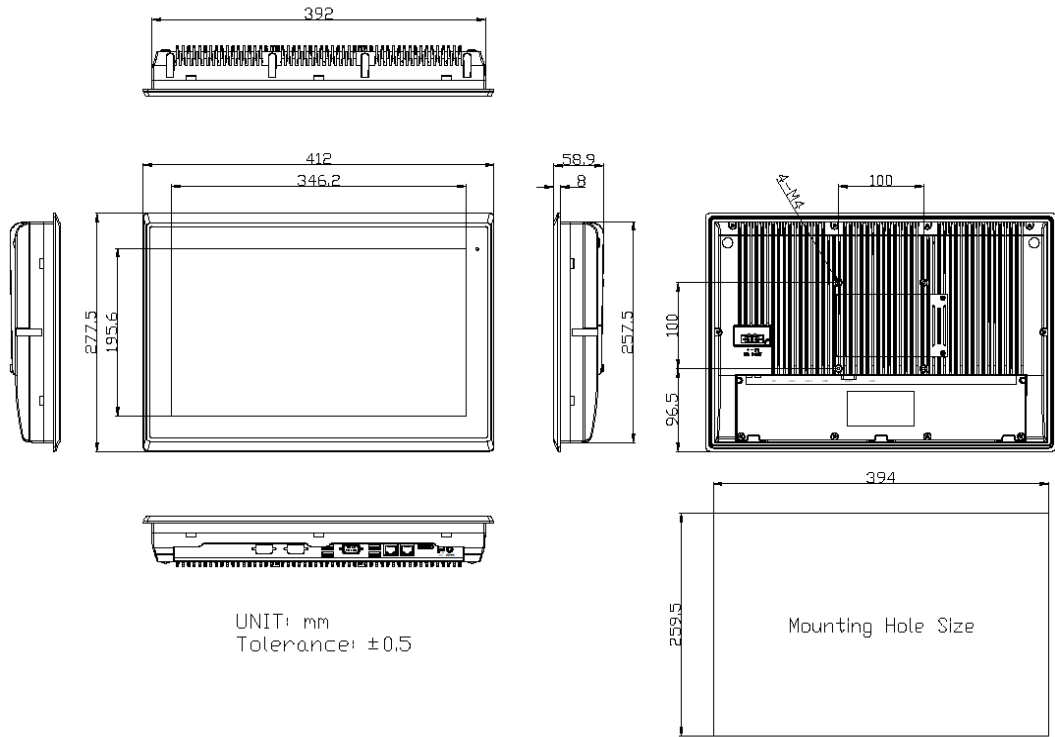

Figure 7 Dimensions of ARCHMI-816BP/BR(H)

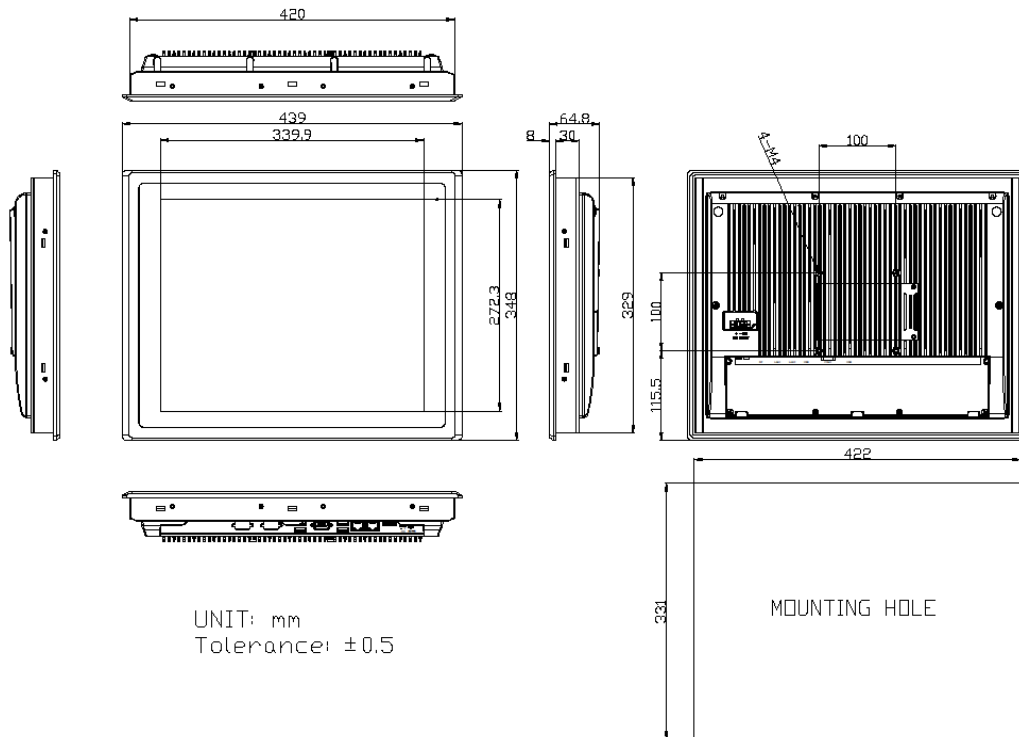

Figure 8 Dimensions of ARCHMI-817BP/BR(H)

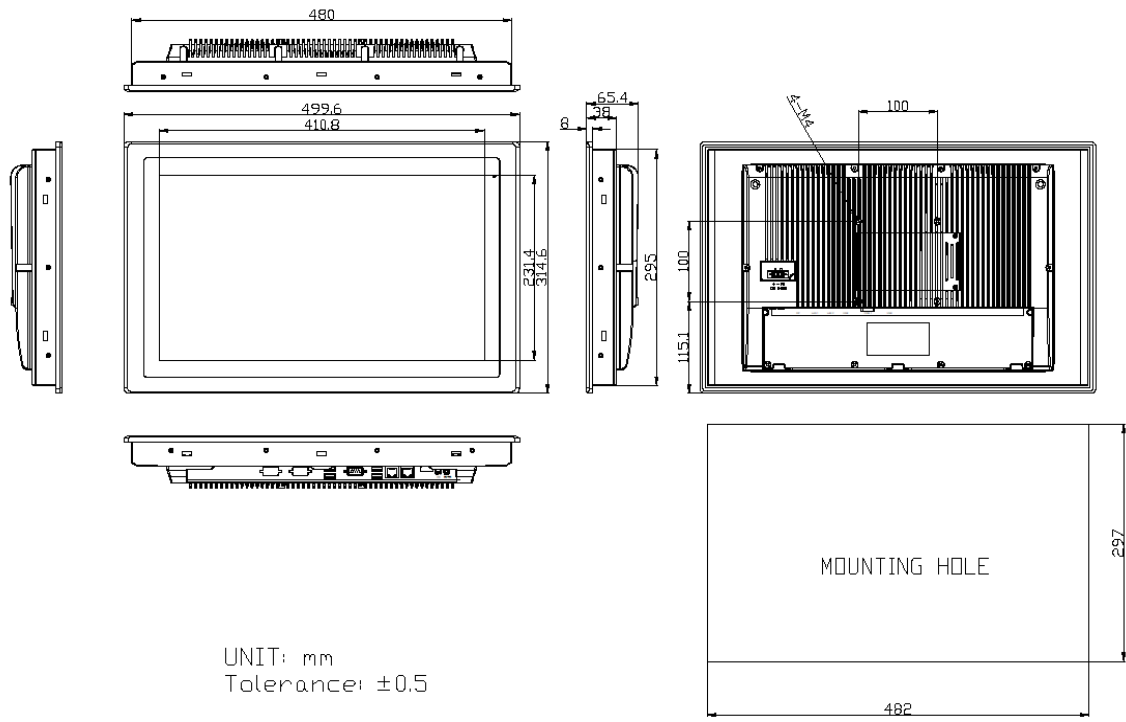

Figure 9 Dimensions of ARCHMI-818BP

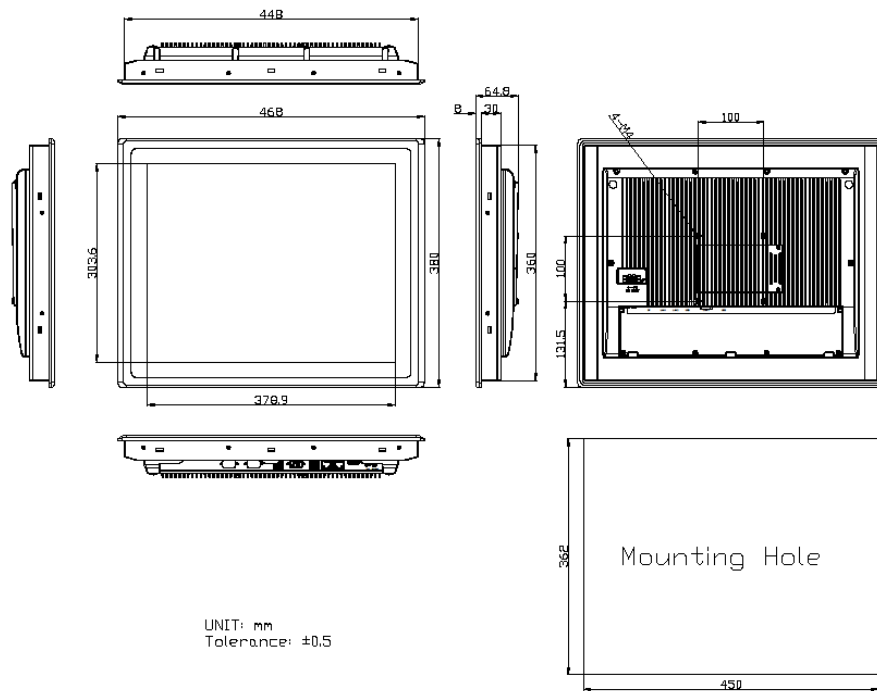

Figure 10 Dimensions of ARCHMI-819BP

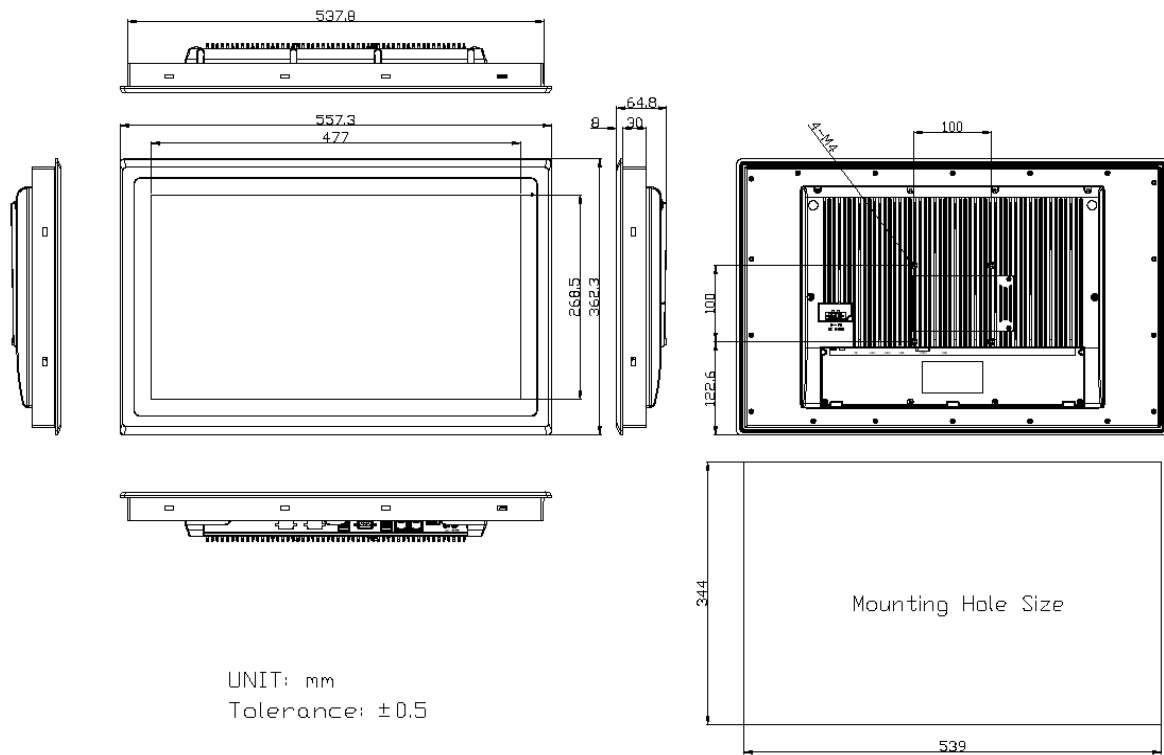

Figure 11 Dimensions of ARCHMI-821BP

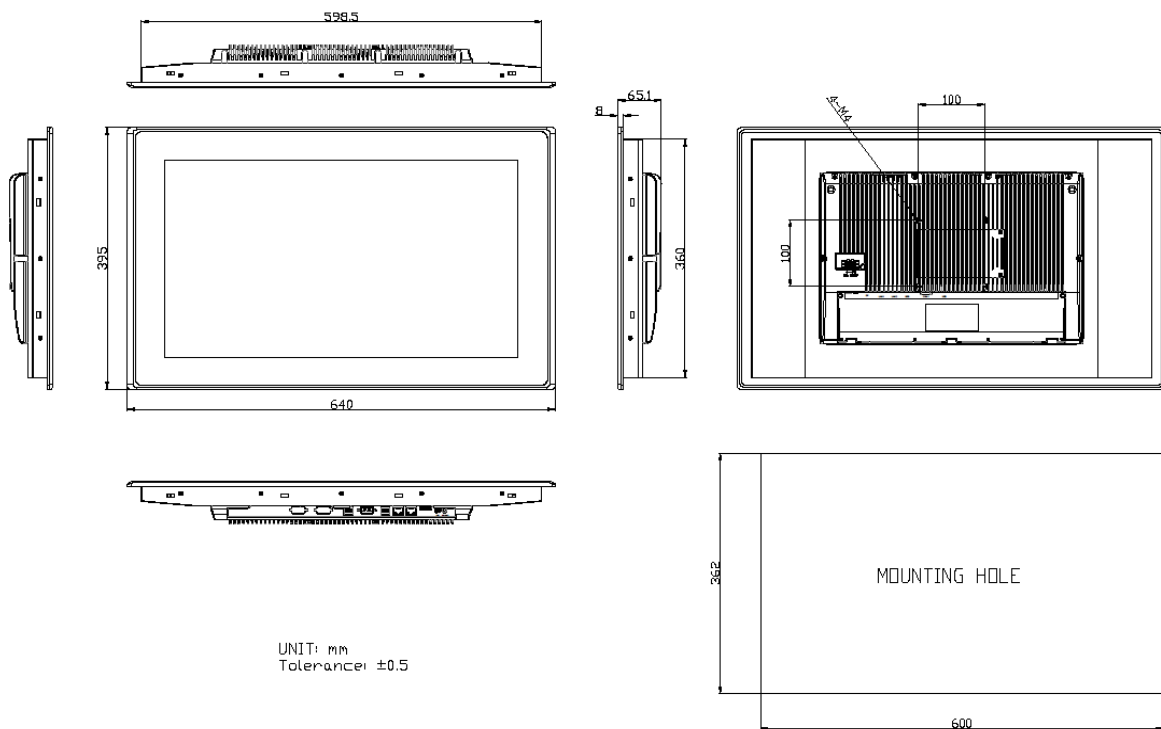

Figure 12 Dimensions of ARCHMI-824BP

1.7 Brief Description of ARCHMI-8XXB Series

There are 7" ~ 23.8" Industrial Compact Size Panel PC in ARCHMI-8XXB series, which comes with flat front panel touch screen and fanless design. It is powered by Intel Elkhart Lake Processors with one SO-DIMM DDR4 slot, up to 64GB 3200 MHz. These systems support DC 9~36V wide-ranging power input and IP66 compliant front panel. Projected capacitive touch support 7H anti-scratch surface is ideal for use as PC-based controller for Industrial Automation & Factory Automation. Furthermore, ARCHMI-8xxB Series are capable of expanding the function by option expansion I/O boards, TB-528 series, includes Mini-PCIe, CAN bus, POE, USB, and isolation I/O module to improve competitive advantage through providing critical flexibility and expansibility for the variety of application and requirement.



Figure 13 Front View of ARCHMI-807BP/BR(H)



Figure 14 Rear View of ARCHMI-807BP/BR(H)



Figure 15 Front View of ARCHMI-808BP/BR(H)



Figure 16 Rear View of ARCHMI-808BP/BR(H)

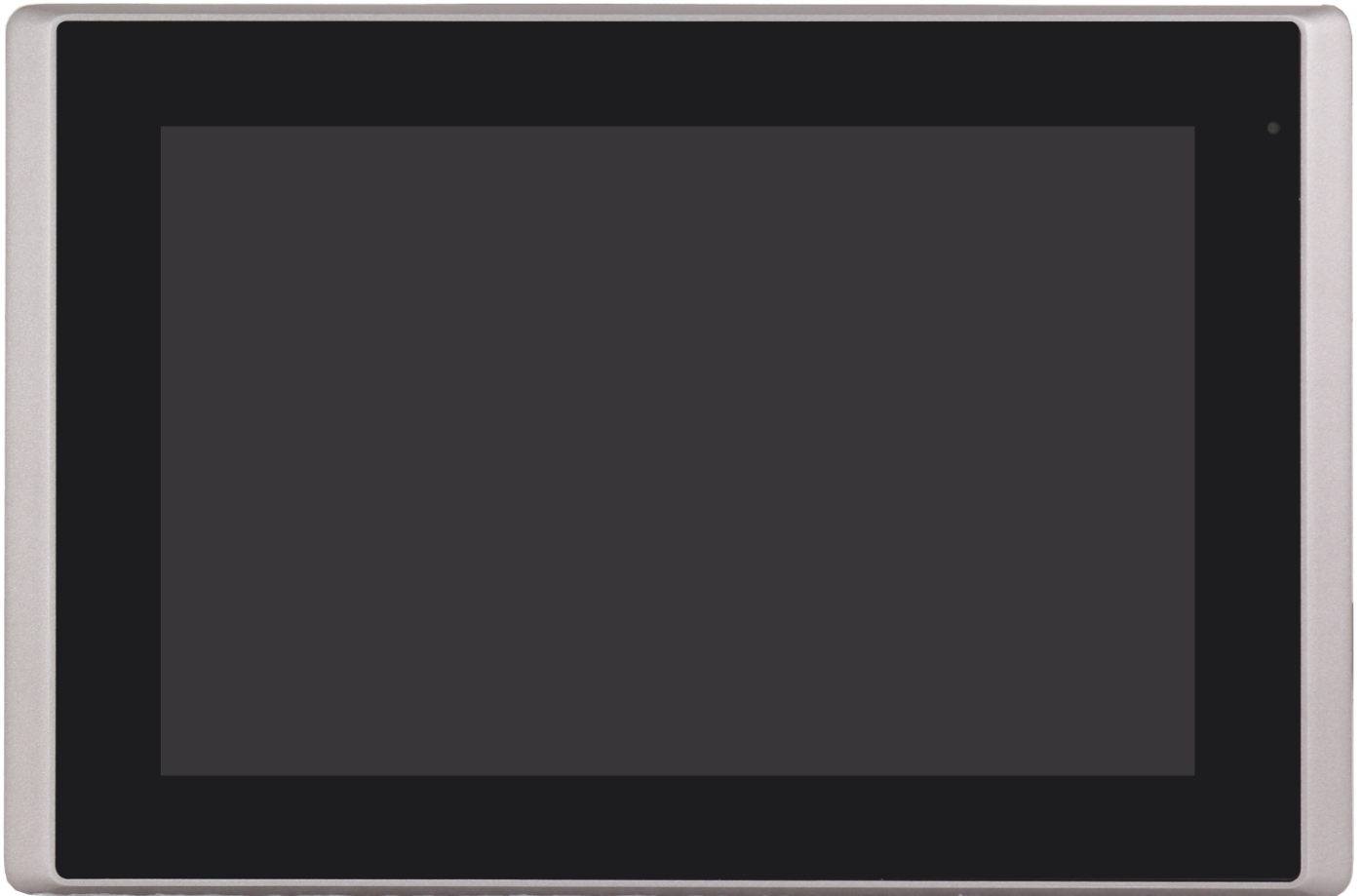

Figure 17 Front View of ARCHMI-810BP/BR(H)



Figure 18 Rear View of ARCHMI-810BP/BR(H)

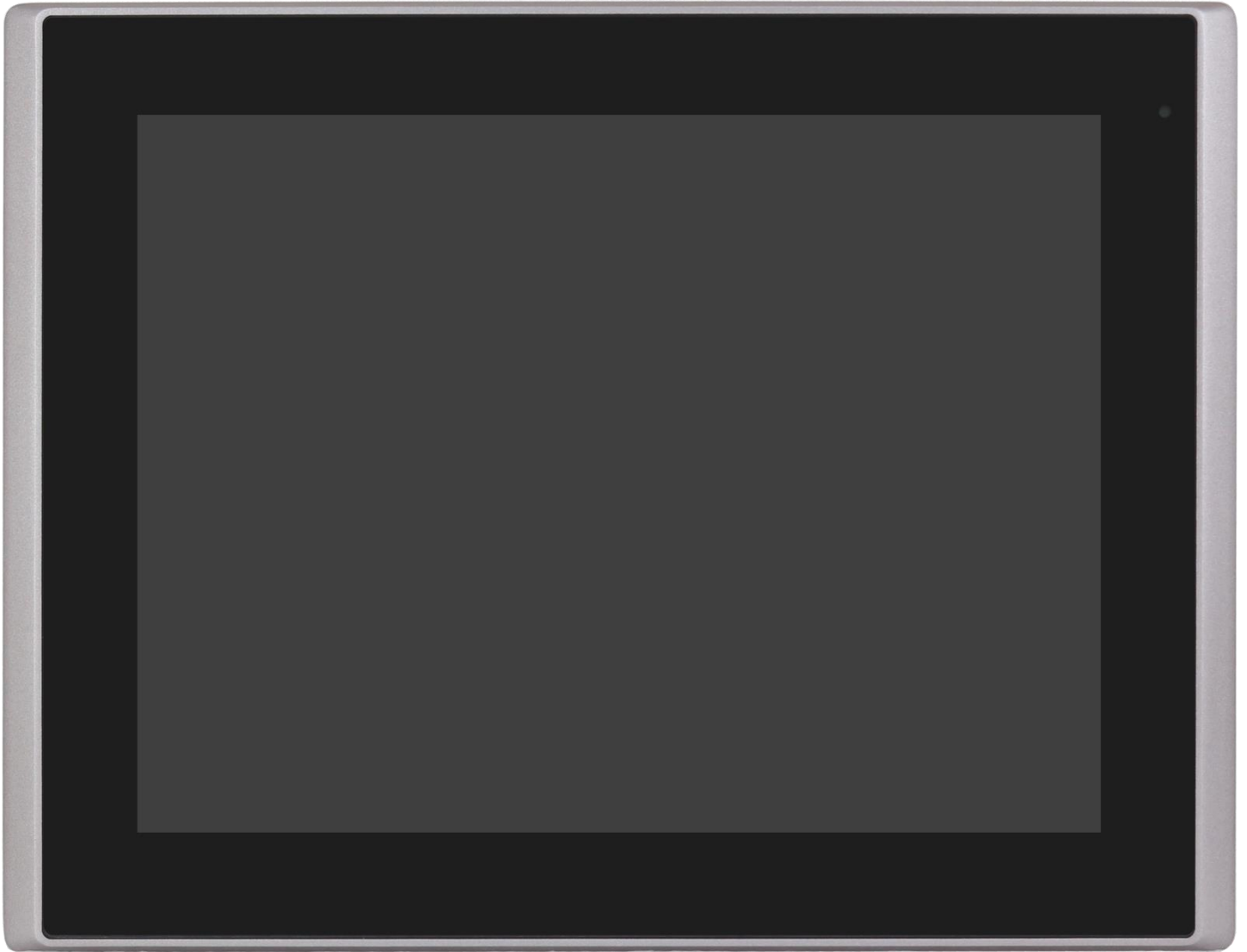

Figure 19 Front View of ARCHMI-812BP/BR(H)



Figure 20 Rear View of ARCHMI-812BP/BR(H)



Figure 21 Front View of ARCHMI-812WBP/812WBR(H)



Figure 22 Rear View of ARCHMI-812WBP/812WBR(H)



Figure 23 Front View of ARCHMI-815BP/BR(H)



Figure 24 Rear View of ARCHMI-815BP/BR(H)

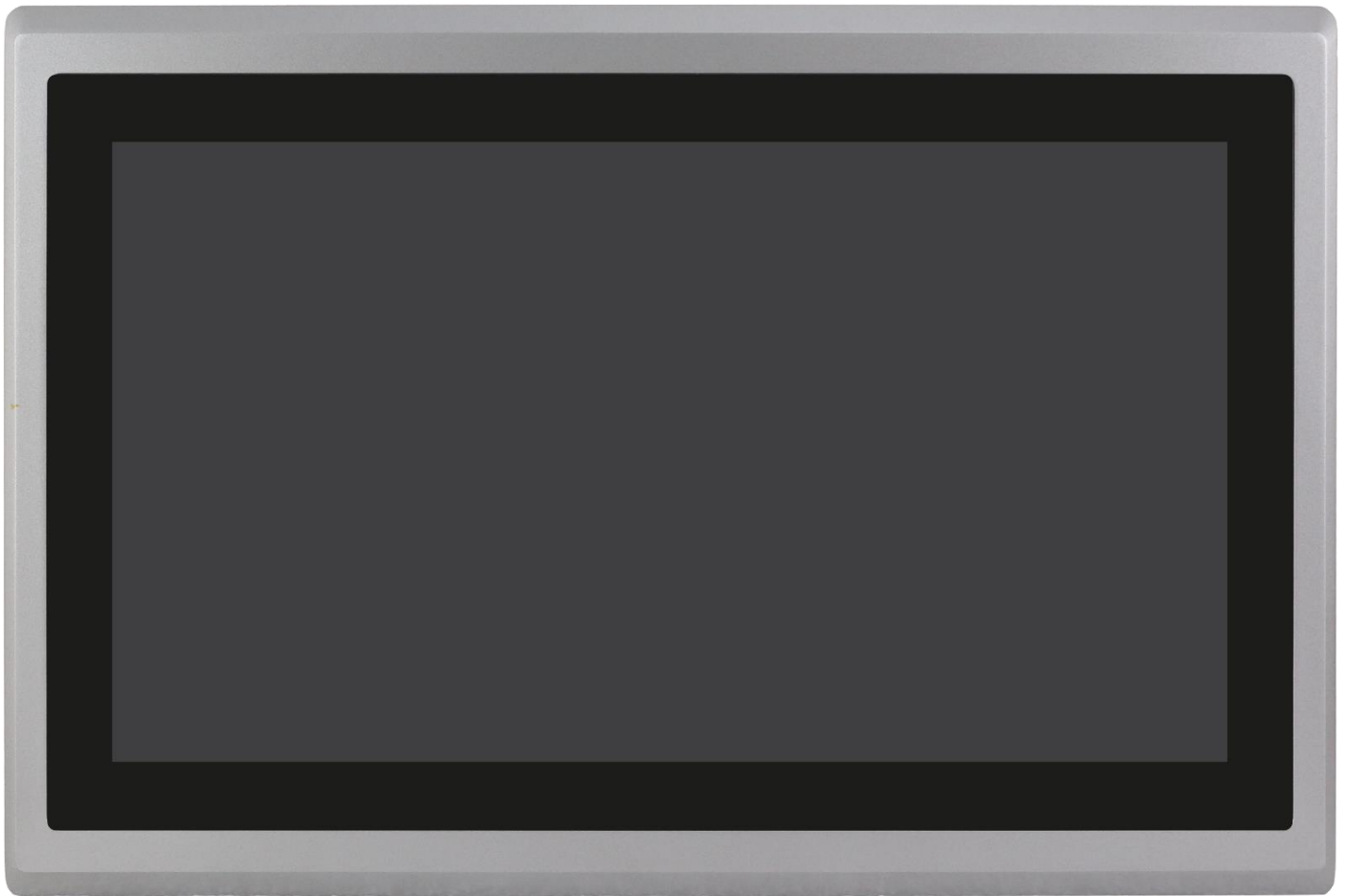

Figure 25 Front View of ARCHMI-816BP/BR(H)



Figure 26 Rear View of ARCHMI-816BP/BR(H)



Figure 27 Front View of ARCHMI-817BP/BR(H)



Figure 28 Rear View of ARCHMI-817BP/BR(H)

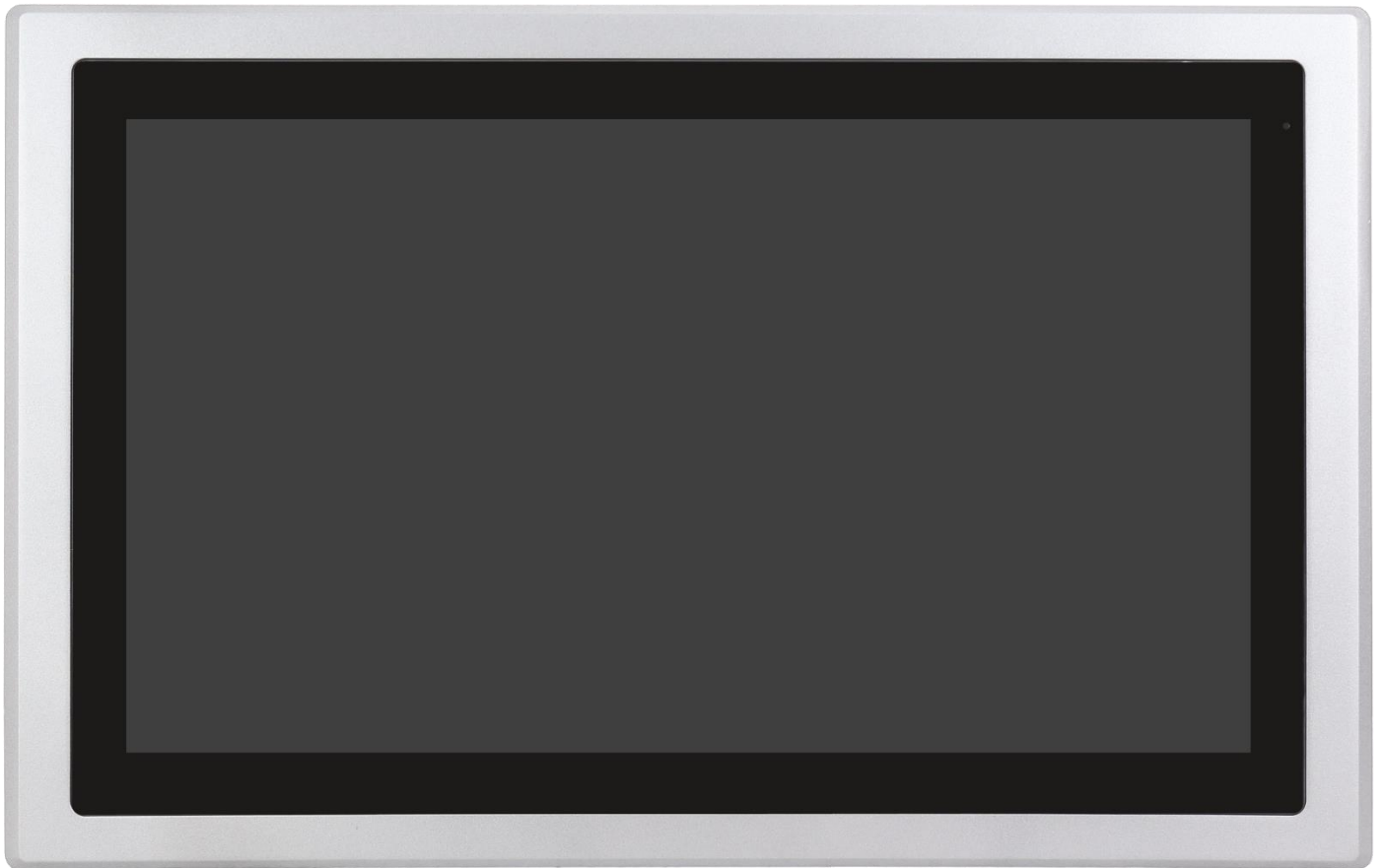

Figure 29 Front View of ARCHMI-818BP/818BR(H)



Figure 30 Rear View of ARCHMI-818BP/BR(H)



Figure 31 Front View of ARCHMI-819BP/819BR(H)



Figure 32 Front View of ARCHMI-819BP/819BR(H)



Figure 33 Front View of ARCHMI-821BP/821BR(H)



Figure 34 Front View of ARCHMI-821BP/821BR(H)

Figure 35 Front View of ARCHMI-824BP(H)--TBD

Figure 36 Front View of ARCHMI-824BP(H)--TBD

1.8 VESA Mounting

The ARCHMI-8xxB series is designed to be VESA mounted as shown in Picture. Just carefully place the unit through the hole and tighten the given screws from the rear to secure the mounting.

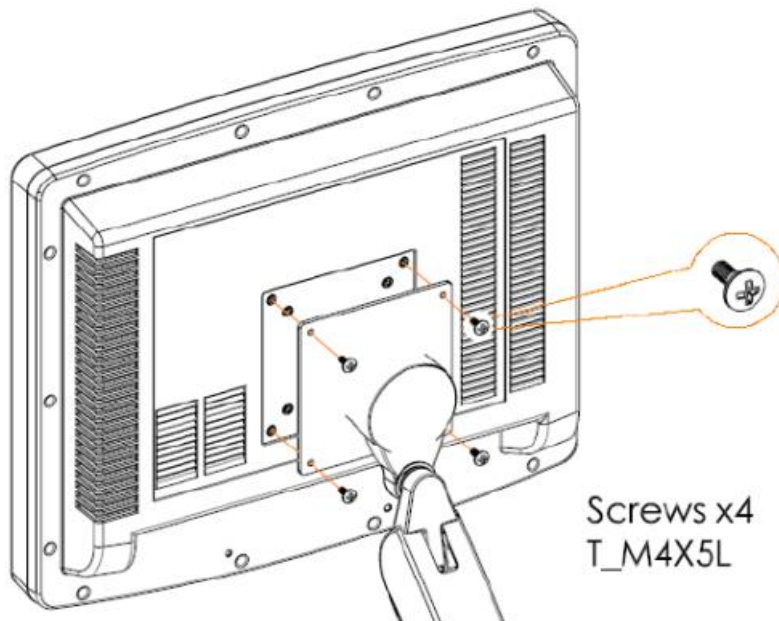

Figure 37 ARCHMI-8XXB VESA MOUNTING

1.9 Panel Mounting

There are four holes located along the four sides of the HMI. Insert the clamp from the four sides and tighten them with the nuts provided.

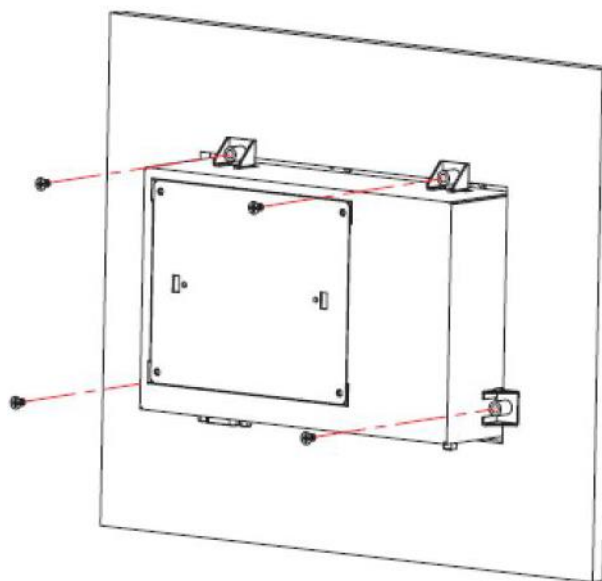

Figure 38 ARCHMI-8XXB PANEL MOUNTING

SBC-7130 is a 4" industrial motherboard developed on the basis of Intel Elkhart Lake, which provides abundant peripheral interfaces to meet the needs of different customers. Also, it features dual GbE ports, 2-COM ports and one M.2 B-Key and one M.2 E-Key and one mPCIe slot configuration, one DP port, one LVDS interface. To satisfy the special needs of high-end customers, CN2 and CN3 richer extension functions. The product is widely used in various sectors of industrial control.

2.1 Specifications

Specifications	
Board Size	170mm x 113mm
CPU Support	Intel Celeron J6412 Processor, 2.0GHz up to 2.60GHz, 10W Intel Atom x6425E Processor, 2.0GHz up to 3.00GHz, 12W (option)
Chipset	SOC
Memory Support	1x SO-DIMM (260pins), up to 32GB DDR4 3200MT/s
Graphics	Integrated Intel UHD Graphics 400/800 MHz (J6412) Integrated Intel UHD Graphics 500/750 MHz (x6425E)
Display Mode	1x DP++ 1.4 via DP Port 1 x LVDS (18/24-bit dual LVDS, option)
Support Resolution	Up to 4096 x 2160 @60Hz for DP1 Up to 1920 x 1200 for LVDS (PS8625)
Double Display	DP + LVDS (option)
Super I/O	ITE IT8786E-I/HX
BIOS	AMI/UEFI BIOS
Storage	1x SATAIII via 90 SATA 7pin connector
M.2	1x M.2 B-Key(SATA III/PCIe auto detect), 2242 for Storage 1x M.2 E-Key(PCIex1, USB2.0), 2230 for WIFI/BT Module
Ethernet	2x 2.5 GbE ports by RJ45 with intel I226-LM controller (PXE/WoL)
USB	2x USB3.1, Type-A stack ports(USB3_1/USB3_2, USB2_3/USB2_4) 2x USB2.0, Type-A stack ports(USB_56) 2x USB2.0 via pitch2.0mm, pin header for CN3 (USB1/USB2) 1x USB2.0 for M2_E1(USB7) 1x USB2.0 for M-PCIE1(USB10) 1x USB2.0 via pitch2.0mm, DF13-30 for CN2 (USB8) 1x USB2.0 for PM6000 (USB9, co-lay, Switch select, option)

	1x USB2.0 via pitch2.0mm, DF13-30 for CN1(USB9,co-lay,option)
Serial	1x RS232/422/485,DB9,Pin9 with 5V/13.5V/RI (COM1) 1x RS232,2x5Pin header,Pin10 with 5V/13.5V/RI (COM2,option) 2x UART for CN3 (COM3,COM4) 2x RS422/485 header for CN2 (COM5/COM6)
GPIO	8-bit digital I/O by Pin header (CN2) 4-bit digital Input 4-bit digital Output 4-bit digital I/O by Pin header (CN3) 2-bit digital Input 2-bit digital Output
Audio	Support Audio via Realtek ALC888S-VD2 HD audio codec 1x Line out by Jack for external Support Line-in,Line-out,MIC by 2x6-pin header
Touch Ctrl	1x Touch ctrl header for TCH1 (USB9)
Expansion Bus	1 x mini-PCI-express slot for M-PCIE1 1 x PCI-express for CN3
SIM	1x Nano-SIM Slot by SIM1
FAN	1x 4-pin FAN Wafer (option)
Watchdog Timer	Software programmable 1–255 level
TPM	-SLB9672VU2.0 -Support fTPM, select via BIOS
Switches and LED Indicators	1 x Power on/off switch (BT1/CN2/CN3) 1 x Reset (CN2) 1 x HDD LED status (CN2) 1 x Power LED status (CN1) 1 x Buzzer
Battery	Support CR2477 Li battery by 2-pin header (1000mAh)
Smart battery & PoE Power Input	1 x Smart battery / PoE Power Input (option) -Connect to smart battery charger board & PoE power input via pitch1.25mm DF13-30P -Support 3 Serial Li battery by 9-pin header (PB-434 R1.00 / PB-434 2.00)
Power Management	1x 3-pin power input connector (Wide range DC+9V~36V)
External I/O port	1 x COM Port (COM1) 2 x USB 3.1 Gen1 Ports (stack)

	2 x RJ45 GbE LAN Ports 1 x DP Port 1 x Audio Jack (Line out) 1 x Power on/off connector (BT1)
Temperature	Operating: -20°C to 70°C Storage: -40°C to 85°C
Humidity	10% - 90%, non-condensing, operating
Power Consumption	DC24V/1.05A (Intel J6412 2.00 GHz Processor with 8GB DDR4/HDD)
EMI/EMS	Meet CE/FCC class A

2.2 Board Dimensions

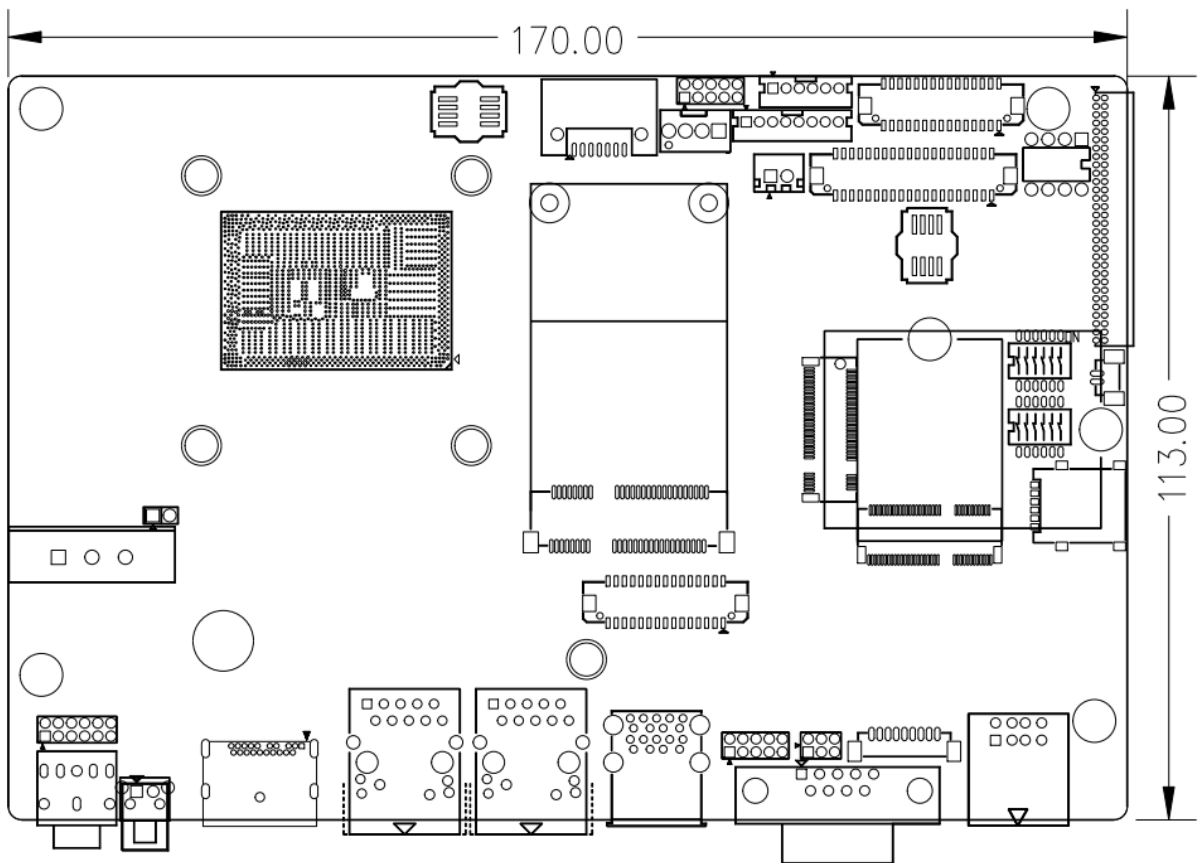

(units :mm)

Figure 2.1: Board Dimension of SBC-7130

2.3 Jumpers and Connectors Location

Board Top

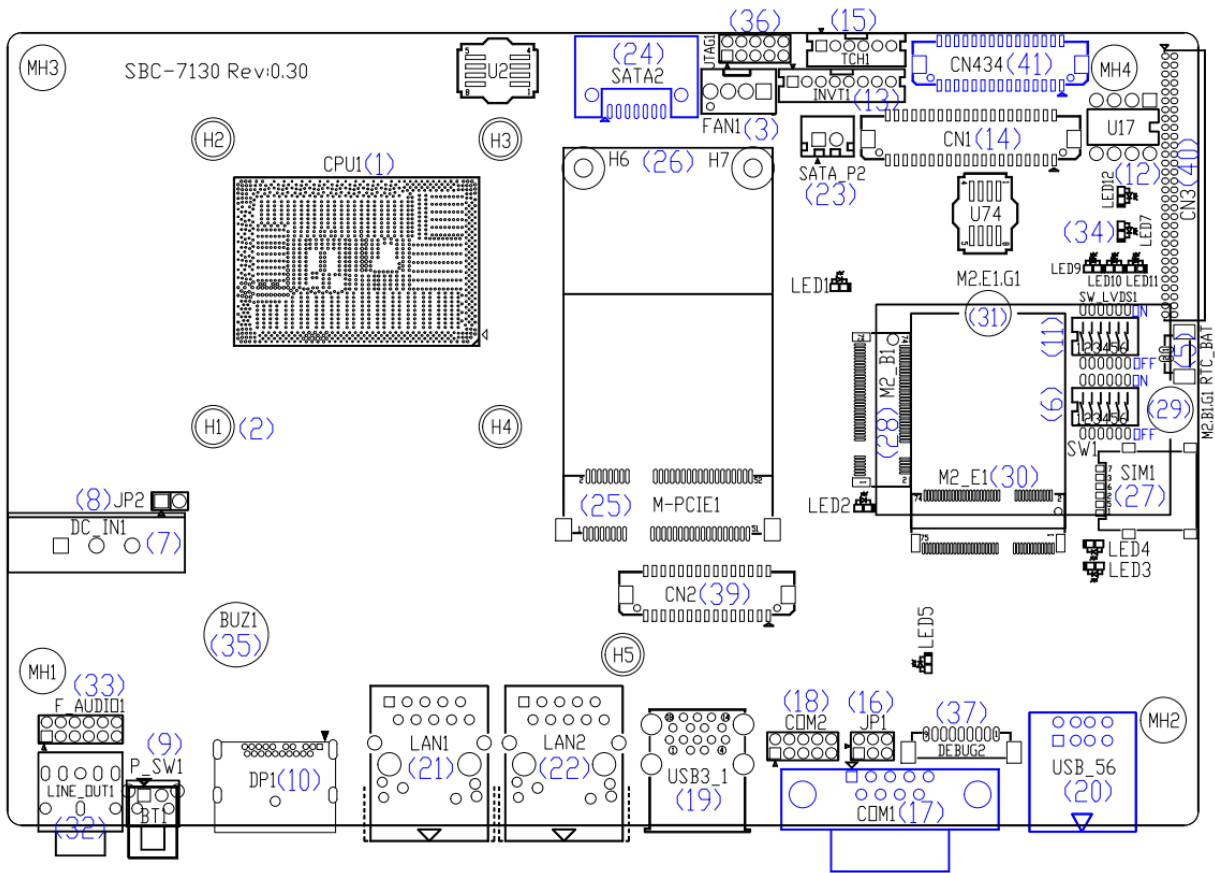

Board Bottom

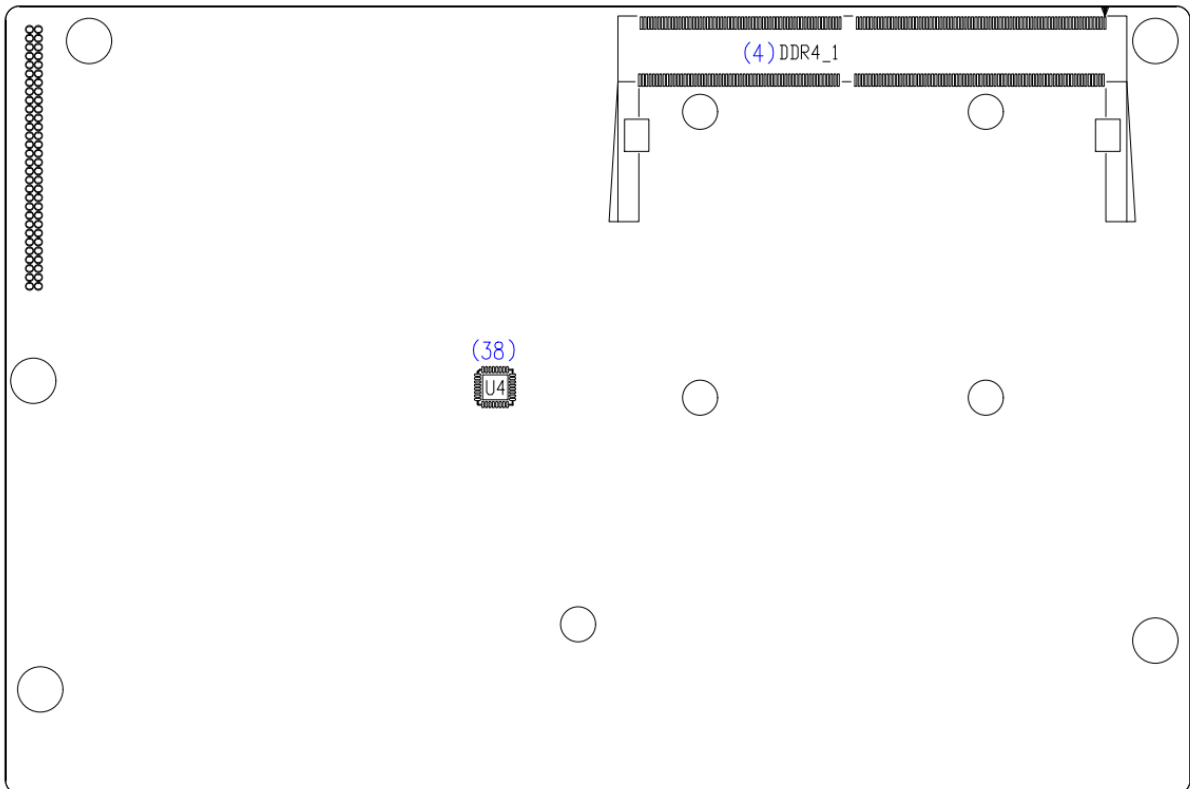

2.4 Jumpers Setting and Connectors

1. CPU1:

(FCBGA1493), onboard Intel Elkhart Lake Processors.

Model	Processor				
	Number	PBF	Cores/ Threads	TDP	Remarks
SBC-7130-J6412	J6412	2.0~2.6GHz	4 / 4	10W	Default
SBC-7130P-J6412	J6412	2.0~2.6GHz	4 / 4	10W	option
SBC-7130C-J6412	J6412	2.0~2.6GHz	4 / 4	10W	option
SBC-7130-X6425E	X6425E	2.0~3.0GHz	4 / 4	12W	option
SBC-7130C-X6425E	X6425E	2.0~3.0GHz	4 / 4	12W	option

2. H1/H2/H3/H4 (CPU SCREW HOLES):

CPU FAN SCREW HOLES, four screw holes for fixed CPU Cooler assemble.

3. FAN1 (option):

(2.54mm Pitch 1x4 Pin Header), Fan connector, cooling fans can be connected directly for use. You may set the rotation condition of cooling fan in menu of BIOS CMOS Setup.

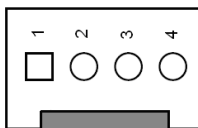

Pin#	Signal Name
1	Ground
2	VCC(12V_S0)
3	SYS_FANTACH
4	SYS_FANPWM



Note:

Output power of cooling fan must be limited under 5W.

4. DDR4_1:

(SO-DIMM 260Pin slot), DDR4 memory socket, the socket is located at the top of the board and supports 260Pin 1.2V DDR4 SO-DIMM memory module up to 32GB.

Max Memory Size (dependent on memory type).

5. RTC_BAT :

(1.25mm Pitch 1x2 wafer Pin Header) 3.0V Li battery is embedded to provide power for CMOS.

Pin#	Signal Name
Pin1	Ground
PIN2	VCC_RTC

6. SW1:

(Switch DIP-6Pin), PoE mode and CHG-BAT and AT/ATX mode and CMOS and auto Power on jumper setting.

SW1	Mode
Pin1 (ON)	PoE Mode (for PB-434)
Pin1 (OFF)	No PoE Mode
Pin4 (ON)	No CHG-BAT (option)
Pin4 (OFF)	For CHG-BAT ON (Default)
Pin5 (ON)	Reserve
Pin5 (OFF)	(Default)
Pin6 (ON)	Auto PS-ON on (option)
Pin6 (OFF)	Power button on (Default)

CMOS clear switch, CMOS clear operation will permanently reset old BIOS settings to factory defaults.

SW1	CMOS
Pin2 (OFF)	Normal (Default)
Pin2 (ON)	Clear CMOS (option)
Pin3 (OFF)	Normal (Default)
Pin3 (ON)	Enabled PWRBTN Clear CMOS



Procedures of CMOS clear:

- a) Turn off the system and unplug the power cord from the power outlet.
- b) To clear the CMOS settings, use the switch to Pin2 on for about 1 seconds then move the switch Pin2 off.
- c) Power on the system again.
- d) When entering the POST screen, press the key to enter CMOS Setup Utility to load optimal defaults.
- e) After the above operations, save changes and exit BIOS Setup.

7. DC_IN1:

(5.08mm Pitch 1x3 Pin Connector), DC9~36V System power input connector.

Pin#	Power Input
Pin1	DC_IN+ (DC+9V~36V)
Pin2	DC_IN- (Ground)
Pin3	FG

Model	DC_IN1
SBC-7130-J6412	180°Connector
SBC-7130P-J6412	45°Connector
SBC-7130C-J6412	180°Connector
SBC-7130-X6425E	180° Connector
SBC-7130C-X6425E	180° Connector

8. JP2 (NC):

(2.54mm Pitch 1x2 Pin Header), Power input setting.

JP2	Power Adapter input (DC_IN1)
Open	DC+9V~36V input (Default)
Short	-

9. BT1/P_SW1 (option) :

Power on/off button, is used to connect power switch button. The two pins are disconnected under normal condition. You may short them temporarily to realize system startup & shutdown or awaken the system from sleep state.

Model	BT1	P_SW1
SBC-7130-J6412	●	-
SBC-7130P-J6412	●	-
SBC-7130C-J6412	●	-
SBC-7130-X6425E	●	-
SBC-7130C-X6425E	●	-

10. DP1:

(DP Connector), Display Port Interface connector.

The DisplayPort* is a digital communication interface that uses differential signaling to achieve a high-bandwidth bus interface designed to support connections between PCs and monitors, projectors, and TV displays.

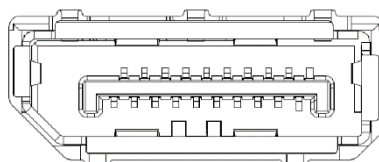

11. SW_LVDS1:

(Switch DIP-6Pin), LVDS jumper setting.

S_LVDS(Switch)	Function (CN1)
Pin1 (ON)	3.3V Level
Pin1 (OFF)	5V Level
Pin2 (ON)	Single channel LVDS
Pin2 (OFF)	Dual channel LVDS
Pin3 (ON)	8/24 bit
Pin3 (OFF)	6/18 bit
Pin4 (ON)	DC Mode
Pin4 (OFF)	PWM Mode
Pin5 (ON)	Disable PS8625
Pin5 (OFF)	Enable PS8625
Pin6 (ON)	Onboard USB Touch
Pin6 (OFF)	CN1 USB Touch

12. U17:

AT24C02-DIP8, The EEPROM IC (U11) is the set of LVDS resolution.

If you need other resolution settings, please upgrade U11 data.

Model	LVDS resolution
SBC-7130-J6412 SBC-7130P-J6412 SBC-7130C-J6412 SBC-7130-X6425E SBC-7130C-X6425E	1280*1024 (Default)
	800*480 (option)
	800*600 (option)
	1024*768 (option)
	1920*1080 (option)

13. INVT1:

(2.0mm Pitch 1x8 wafer Pin Header), Backlight control connector for LVDS.

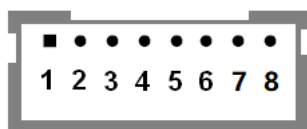

Pin#	Signal Name
1	13V+BAT_S0 (DC10.5V~13.5V)
2	13V+BAT_S0 (DC10.5V~13.5V)
3	Ground
4	Ground
5	BKLT_EN_OUT
6	BKLT_CTRL
7	DC+9V~36V input (DC_IN1)
8	DC+9V~36V input (DC_IN1)

Power Input	Power output (INVT1/CN1 : Pin1/Pin2)
DC_IN1	DC13.5V
PB-434(option)	DC10.5~13.5V

14. CN1:

(1.25mm Pitch 2x20 Connector, DF13-40P), for 18/24-bit LVDS output connector, fully supported by Parad PS8625(DP to LVDS), the interface features dual channel 24-bit output. Low Voltage Differential Signaling, A high speed, low power data transmission standard used for display connections to LCD panels.

Function	Signal Name	Pin#	Signal Name	Function	
DC10.5~13.5V	13V+BAT_S0	2	1	13V+BAT_S0	DC10.5~13.5V
LVDS Signal	BKLT_EN_OUT	4	3	BKLT_CTRL	LVDS Signal
	Ground	6	5	Ground	
	LVDS_VDD5	8	7	LVDS_VDD5	
	LVDS_VDD3	10	9	LVDS_VDD3	
	Ground	12	11	Ground	
	LA_D0_P	14	13	LA_D0_N	
	LA_D1_P	16	15	LA_D1_N	
	LA_D2_P	18	17	LA_D2_N	
	LA_D3_P	20	19	LA_D3_N	
	LA_CLKP	22	21	LA_CLKN	
	LB_D0_P	24	23	LB_D0_N	
	LB_D1_P	26	25	LB_D1_N	
	LB_D2_P	28	27	LB_D2_N	
	LB_D3_P	30	29	LB_D3_N	
LB_CLKP	32	31	LB_CLKN		
USB9 (option)	Ground	34	33	Ground	USB9 (option)
	CN1_USB9_P	36	35	CN1_USB9_N	
	5V_S5	38	37	5V_S5	
Power LED+	PWR_LED+	40	39	Ground	Power LED-

15. TCH1:

(2.0mm Pitch 1x6 wafer Pin Header), internal Touch controller connector.

Pin#	Signal Name
1	SENSE
2	X+
3	X-
4	Y+
5	Y-
6	GND_EARCH

16. JP1:

(2.0mm Pitch 2x3 Pin Header), COM1 jumper setting, pin 1~6 are used to select signal out of pin 9 of COM1 port.

JP1 Pin#	Function
Close 1-2	COM1 Pin9 RI (Ring Indicator, Default)
Close 3-4	COM1 Pin9 = +5V/1A (option)
Close 5-6	COM1 Pin9 = +10.5~13.5V/1A (option)

Power Input	Power output (COM1:Pin9 , COM2:Pin10)
DC_IN1	DC13.5V
PB-434(option)	DC10.5~13.5V

17. COM1:

(Type DB9M), Serial port, standard DB9 Male serial port is provided to make a direct connection to serial devices. COM1 port is controlled by pins No.1~6 of JP1, select output Signal RI or 5V or 13.5V, for details, please refer to description of JP1 setting.

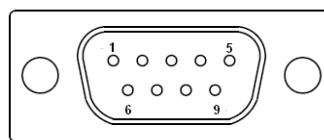

RS232 (Default):	
Pin#	Signal Name
1	DCD# (Data Carrier Detect)
2	RXD (Received Data)
3	TXD (Transmit Data)
4	DTR (Data Terminal Ready)
5	Ground

6	DSR (Data Set Ready)
7	RTS (Request To Send)
8	CTS (Clear To Send)
9	JP1 select Setting (RI/5V/+10.5~13.5V)
BIOS Setup : Serial Port 1 Configuration 【RS-232】	

RS422 (option):	
Pin#	Signal Name
1	422_TX-
2	422_TX+
3	422_RX+
4	422_RX-
5	Ground
6	NC
7	NC
8	NC
9	NC
BIOS Setup : Serial Port 1 Configuration 【RS-422】	

RS485 (option):	
Pin#	Signal Name
1	485-
2	485+
3	NC
4	NC
5	Ground
6	NC
7	NC
8	NC
9	NC
BIOS Setup : Serial Port 1 Configuration 【RS-485】	

18. COM2:

(2.0mm Pitch 2x5 Pin Header),COM2 Port, standard RS232 port are provided. They can be used directly via COM cable connection.

COM2: RS232:			
Signal Name	Pin#	Pin#	Signal Name
DCD	1	2	RXD
TXD	3	4	DTR
Ground	5	6	DSR
RTS	7	8	CTS
RI	9	10	13V+BAT_S0(DC10.5~13.5V)

BIOS Setup : Serial Port 2 Configuration 【RS-232】

19. USB3_1:

USB3-1/USB3-2 : (Double stack USB typeA),Rear USB3.1 connector, it provides up to 2 USB3.1 ports,USB3.1 allows data transfers up to 5.0Gb/s,support USB2.0 and full-speed and low-speed signaling.

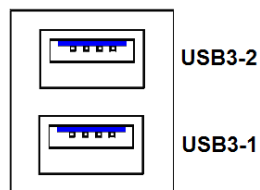

Each USB Type A Receptacle (2 Ports) Current limited value is **2.0A**.

If the external USB device current exceeds 2.0A, please separate connectors into different Receptacle.

20. USB_56 (option):

USB2_5/USB2_6 : (Double stack USB type A),Rear USB 2.0 connector, it provides up to 2 USB2.0 ports, USB 2.0 allows data transfers up to 480 Mb/s, support USB2.0 and full-speed and low-speed signaling.

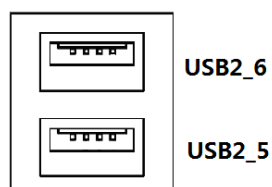

Each USB Type A Receptacle (2 Ports) Current limited value is **2.0A**.

If the external USB device current exceeds 2.0A, please separate connectors into different Receptacle.



Note:

Output current of the connector must not be above 1A.

21. LAN1:

(RJ45 Connector), Rear LAN port, one standard 10/100/1000/2500Mbps RJ45 Ethernet port are provided. Used Intel I226-LM chipset.

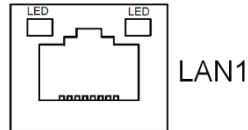

22. LAN2:

(RJ45 Connector), Rear LAN port, one standard 10/100/1000/2500Mbps RJ45 Ethernet port are provided. Used Intel I226-LM chipset.

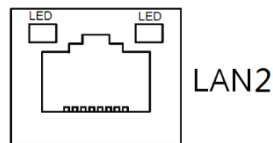

23. SATA_P2:

(2.5mm Pitch 1x2 Wafer Pin Header), One onboard 5V output connectors are reserved to provide power for SATA devices.

Pin#	Signal Name
1	+DC5V_S0
2	Ground



Note:

Output current of the connector must not be above 1A.

24. SATA2:

(SATA 7Pin, 90° Connector), SATA Connector, one SATA connector are provided, SATA2 transfer speed up to 6.0Gb/s.

25. M-PCIE1:

(Socket 52Pin), mini PCIe socket, it is located at the top, it supports mini PCIe devices with USB2.0 and SIM and SMBUS signal. MPCle card size is 30x50.95mm.

Function	Support	Remarks
mini PCIe (PCIe 02)	●	
SMbus	●	
SIMbus	●	
USB2.0 (USB10)	●	

26. H6/H7:

M-PCIE1 SCREW HOLES, H6/H7 for mini PCIe card (30mmx50.95mm) assemble.

27. SIM1:

(Nano-SIM Slot), Support nano SIM Card devices.

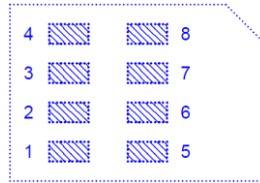

Pin#	Signal Name
1	SIM_VCC
2	SIM_RST
3	SIM_CLK
5	Ground
6	SIM_VCC_R(NC)
7	SIM_IO

28. M2_B1:

(M.2 Socket), M.2 B-Key, it is located at the top, it supports M.2 B-Key devices with one USB3.1/SATAIII auto detect. support 2242 SSD.

Function	Support
SATAIII signal	Auto detect
USB3.0 signal	
USB2.0 signal	Co-lay, NC

29. M2.B1.G1:

M2_B1 SCREW HOLES, M2.B1.G1 for M2_B1 card assemble.

30. M2_E1:

(M.2 Socket), M.2 E-Key, it is located at the top, it supports M.2 E-Key devices with one PCIe and USB2.0 signal. support 2230 size WIFI/BT module.

31. M2.E1.G1:

M2_E1 SCREW HOLES, M2.B1.G1 for M2_E1 card assemble.

32. LINE_OUT1:

(Diameter 3.5mm Jack), High Definition Audio port, An onboard Realtek ALC888S codec is used to provide high quality audio I/O ports.



Line out

33. F_AUDIO1:

(2.0mm Pitch 2x6 Pin Header), Front Audio, an onboard Realtek ALC888S codec is used to provide high-quality audio I/O ports. Line Out can be connected to a headphone or amplifier. Line In is used for the connection of external audio source via a Line in cable. MIC is the port for microphone input audio.

Signal Name	Pin#	Pin#	Signal Name
+5V_F_AUDIO	1	2	GND_AUD
LINE-OUT-L	3	4	LINE-OUT-R
FRONT_JD	5	6	LINE_JD
LINE-IN-L	7	8	LINE-IN-R
MIC-IN-L	9	10	MIC-IN-R
GND_AUD	11	12	MIC1_JD

34. LED1, LED3, LED4, LED5, LED7, LED9, LED10, LED11, LED12:

LED1 STATUS. Blue LED for PM6000 Power status.

LED3 STATUS. Blue LED for M2E_BT_LED- status.

LED4 STATUS. Blue LED for M2E_WLAN_LED- status.

LED10 STATUS. Blue LED for ECD1_PWR_LED2 status.

LED12 STATUS. Blue LED for ECA3_DCH1_LED2 status.

LED5 STATUS. Green LED for Motherboard PM_RSM_RST- status.

LED6 STATUS. Green LED for Motherboard CPU_CATERR- status.

LED7 STATUS. Green LED for Motherboard PM_PCH_PWROK- status.

LED9 STATUS. Green LED for ECD0_PWR_LED1 status.

LED11 STATUS. Green LED for ECA2_CHG1_LED1 status.

35. BUZZER1:

Onboard buzzer

36. JTAG1(option):

(2.0mm Pitch 2x5 Pin Header), Joint Test Action Group port.

Signal Name	Pin#	Pin#	Signal Name
EC_SPI_CS-	1	2	3P3V_ALLS
EC_SPI_MISO	3	4	NC
EC_SPI_CLK	5	6	M2940A_SCL
EC_SPI_MOSI	7	8	Ground
Ground	9	10	M2940A_SDA

37. DEBUG2 (option):

(1.25mm Pitch 1x9 Pin Header), it supports ESPI signal.

Pin#	Signal Name
1	3P3V_S5
2	ESPI_IO3
3	ESPI_IO2
4	ESPI_IO1
5	ESPI_IO0
6	ESPI_CLK
7	ESPI_CS0-
8	RLTRST_3P3V-
9	Ground

38. U4(option):

Infineon's Trusted Platform Module (TPM2.0) SLB9672VU2.0 is a fully standard compliant TPM based on the latest Trusted Computing Group (TCG) specification 2.0.

*Note: Only support Windows 10 IOT.

Model	TPM Function	
	U4(SLB9672VU2.0)	fTPM (BIOS)
SBC-7130-J6412	●	●
SBC-7130P-J6412	●	●
SBC-7130C-J6412	●	●
SBC-7130-X6425E	●	●
SBC-7130C-X6425E	●	●

39. CN2:

(DF13-30P Connector).For expand output connector, It provides eight GPIO,two RS422 or RS485,one USB2.0,one Power on/off, one Reset.

Function	Signal Name	Pin#	Signal Name	Function	
DC5V	5V_S5	2	1	5V_S5	DC5V
F75111_GP26	GPIO_IN2	4	3	GPIO_IN1	F75111_GP27
F75111_GP24	GPIO_IN4	6	5	GPIO_IN3	F75111_GP25
F75111_GP22	GPIO_OUT2	8	7	GPIO_OUT1	F75111_GP23
F75111_GP20	GPIO_OUT4	10	9	GPIO_OUT3	F75111_GP21
	Ground	12	11	Ground	
485 or 422 (COM5)	485+_422TX5+	14	13	485-_422TX5-	485 or 422 (COM5)
	422_RX5+	16	15	422_RX5-	
485 or 422 (COM6)	485+_422TX6+	18	17	485-_422TX6-	485 or 422 (COM6)
	422_RX6+	20	19	422_RX6-	

5V	5V_S0	22	21	HDD_LED+	HDD LED
USB2.0	5V_S5	24	23	5V_S5	USB2.0
	USB8_DP	26	25	USB8_DN	
	Ground	28	27	FP_RST-	RESET
Power auto on	FP_PWRBTN	30	29	Ground	
COM5 BIOS Setup : Serial Port 5 Configuration 【RS-422】 Serial Port 5 Configuration 【RS-485】					
COM6 BIOS Setup : Serial Port 6 Configuration 【RS-422】 Serial Port 6 Configuration 【RS-485】					

40. CN3:

(1.27mm Pitch 2x30 Female Header).For expand output connector, It provides four GPIO,two USB 2.0, one SPI, two Uart,one PCIe1,one SMBus, connected to the TB-528 riser Card.

Function	Signal Name	Pin#		Signal Name	Function
	5V_S5	1	2	5V_S5	
	5V_S5	3	4	5V_S5	
	USB2_OC0_12-	5	6	PS_ON_ALL-	
USB1	USB1_N	7	8	USB1_P	USB1
USB2	USB2_N	9	10	USB2_P	USB2
	Ground	11	12	Ground	
SPI	PCH_SPI1_CLK	13	14	SPI1_MISO_PCH	SPI
	PCH_SPI1_CS0-	15	16	PCH_SPI1_MOSI	
COM4 (UART)	GP91_RI4-	17	18	GP66_DCD4-	COM4 (UART)
	GP96_TXD4	19	20	GP97_RXD4	
	GP93_DTR4-	21	22	GP94_RTS4-	
	GP95_DSR4-	23	24	GP92_CTS4-	
	Ground	25	26	Ground	
COM3 (UART)	GP14_RI3-	27	28	GP63_DCD3-	COM3 (UART)
	GPA2_TXD3	29	30	GP90_RXD3	
	GPA0_DTR3-	31	32	GPA1_RTS3-	
	GP34_DSR3-	33	34	GP13_CTS3-	
GPIO	F75111_GPIO30	35	36	F75111_GPIO31	GPIO
	F75111_GPIO32	37	38	F75111_GPIO33	
	Ground	39	40	Ground	
PCIe1	PCIE1_USB3_TX_N	41	42	PCIE1_USB3_TX_P	PCIe1
	PCIE1_USB3_RX_N	43	44	PCIE1_USB3_RX_P	
	Ground	45	46	Ground	
	CLK_100M_PE4_N	47	48	CLK_100M_PE4_P	

	PM_PCIE_WAKE-	49	50	PLT_RST_BUF2-	
SMBus	SMB_CLK_S0	51	52	SMB_DATA_S0	SMBus
PCIe	CLKREQ_PE4-	53	54	Ground	
	3P3V_S5	55	56	FP-PWRBTN-	Power Auto on
	3P3V_S5	57	58	3P3V_S5	
DC10.5~13.5V	13V+BAT_S0	59	60	13V+BAT_S0	DC10.5~13.5V

Power Input	Power output (CN3:Pin59/Pin60)
DC_IN1	DC13.5V
PB-434(option)	DC10.5~13.5V

41. CN434(option):

(1.25mm Pitch, DF13-30P), Connector for smart battery charger board & PoE power input. Connect the CN434 Connector of SBC-7130C to the CN_434 connector of PB-434 R1.00 or PB-434 R2.00.

If you need technical support, please contact your sales or dealer window for technical support.

Signal Name	Pin#	Pin#	Signal Name
13V+BAT_S5	2	1	Ground
13V+BAT_S5	4	3	Ground
13V+BAT_S5	6	5	Ground
13V+BAT_S5	8	7	Ground
13V+BAT_S5	10	9	Ground
13V+BAT_S5	12	11	13V_12V_DC
13V+BAT_S5	14	13	13V_12V_DC
Ground	16	15	POE_ON
NC	18	17	ECH3_SEL_BAT1
FP_PWRBTN-	20	19	ECA1_CHG1_UP
3P3V_ALLS	22	21	ECH4_EN_CHG1
3P3V_ALLS	24	23	ECH5_EN_BAT1
SMB_DAT_BAT1	26	25	SMB_CLK_BAT1
VCC_BAT1	28	27	BAT1_TEMP-
VCC_BAT1	30	29	Ground

Model	CN434 Function
SBC-7130-J6412	-
SBC-7130P-J6412	-
SBC-7130-X6425E	-
SBC-7130C-J6412	Smart battery or PoE Power Input
SBC-7130C-X6425E	Smart battery or PoE Power Input

42. PB-434 R1.00(option):

This is the smart battery charger board. The size of this board is: 60 x 30mm.

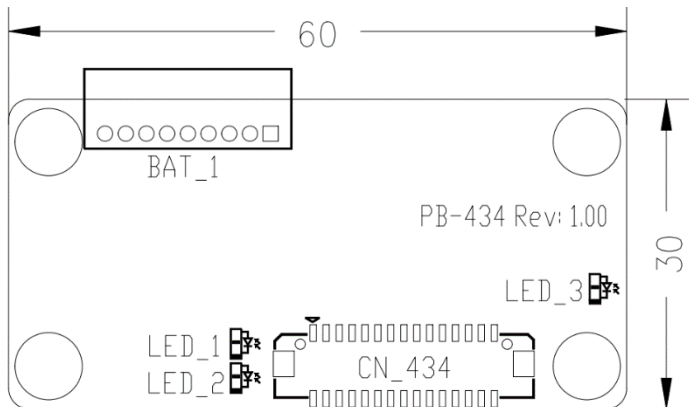

CN_434:

(1.25mm Pitch, DF13-30P), Connect the CN_434 Connector of PB-434 R1.00 to the CN434 connector of SBC-7130C-XX R0.30.

Signal Name	Pin#	Pin#	Signal Name
13V+BAT_S5	2	1	Ground
13V+BAT_S5	4	3	Ground
13V+BAT_S5	6	5	Ground
13V+BAT_S5	8	7	Ground
13V+BAT_S5	10	9	Ground
13V+BAT_S5	12	11	13V_12V_DC
13V+BAT_S5	14	13	13V_12V_DC
Ground	16	15	POE_ON
RSV	18	17	RSV
FP_PWRBTN-	20	19	ECA1_CHG1_UP
3P3V_ALLS	22	21	ECH4_EN_CHG1
3P3V_ALLS	24	23	ECH5_EN_BAT1
SMB_DAT_BAT1	26	25	SMB_CLK_BAT1
VCC_BAT1	28	27	BAT1_TEMP-
VCC_BAT1	30	29	Ground

BAT_1:

(1.25mm Pitch 1x9 Pin Header). Connection to 3S1P Smart Battery charger.

Pin#	Signal Name	Remarks
1	VCC_BAT1	Voltage : DC12.6V
2	VCC_BAT1	
3	VCC_BAT1	

4	SMB_DAT_CN1	
5	SMB_CLK_CN1	
6	BAT1_TEMP-	
7	Ground	
8	Ground	
9	Ground	

Function	Specifications
Nominal voltage (3S1P)	11.1~12.6V
Charge voltage	12.6V
Charge current	0.5C

LED_1 STATUS. Green LED for CHG1_STAT1 status.

LED_2 STATUS. Blue LED for CHG1_STAT2 status.

LED_3 STATUS. Green LED for 3P3V_BAT status.

43. PB-434 R2.00(option):

This is the smart battery charger board. The size of this board is: 90 x 20mm.

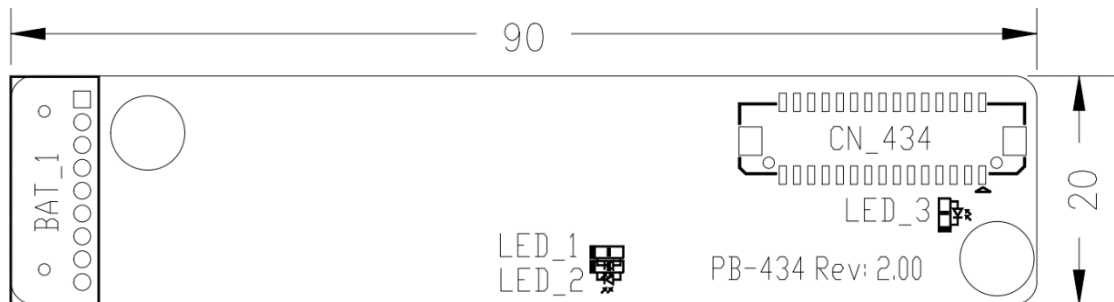

CN_434:

(1.25mm Pitch, DF13-30P), Connect the CN_434 Connector of PB-434 R2.00 to the CN434 connector of SBC-7130C-XX R0.30.

Signal Name	Pin#	Pin#	Signal Name
13V+BAT_S5	2	1	Ground
13V+BAT_S5	4	3	Ground
13V+BAT_S5	6	5	Ground
13V+BAT_S5	8	7	Ground
13V+BAT_S5	10	9	Ground
13V+BAT_S5	12	11	13V_12V_DC
13V+BAT_S5	14	13	13V_12V_DC
Ground	16	15	POE_ON
RSV	18	17	RSV
FP_PWRBTN-	20	19	ECA1_CHG1_UP

3P3V_ALLS	22	21	ECH4_EN_CHG1
3P3V_ALLS	24	23	ECH5_EN_BAT1
SMB_DAT_BAT1	26	25	SMB_CLK_BAT1
VCC_BAT1	28	27	BAT1_TEMP-
VCC_BAT1	30	29	Ground

BAT_1:

(1.25mm Pitch 1x9 Pin Header). Connection to 3S1P Smart Battery charger.

Pin#	Signal Name	Remarks
1	VCC_BAT1	BAT1 Voltage : 12.6V
2	VCC_BAT1	
3	VCC_BAT1	
4	SMB_DAT_CN1	
5	SMB_CLK_CN1	
6	BAT1_TEMP-	
7	Ground	
8	Ground	
9	Ground	

Function	Specifications
Nominal voltage (3S1P)	11.1~12.6V
Charge voltage	12.6V
Charge current	0.5C

LED_1 STATUS. Green LED for CHG1_STAT1 status.

LED_2 STATUS. Blue LED for CHG1_STAT2 status.

LED_3 STATUS. Green LED for 3P3V_BAT status.

Chapter 3 BIOS Setup Description

3.1 Operations after POST Screen

After CMOS discharge or BIOS flashing operation. Press [Delete] key to enter CMOS Setup.



After optimizing and exiting CMOS Setup

3.2 BIOS SETUP UTILITY

Press [Delete] key to enter BIOS Setup utility during POST, and then a main menu containing system summary information will appear.

3.3 Main Settings

Aptio Setup - AMI					
Main	Advanced	Chipset	Security	Boot	Save & Exit
BIOS Information Project Version 7130V002 EC VERSION 7130E005 Build Date and Time 06/14/2023 16:22:58 Compute Die Information Name ElkhartLake ULX Type Intel(R) Celeron(R) J6412 @ 2.00GHz Speed 2000MHz Number of Processors 4Core(s) / 4 Thread(s) Total Memory 8192 MB Memory Date Rate 3200 MTPS					Choose the system default language
System Language [English]					→←: Select Screen ↑↓ : Select Item Enter : Select +/- : Charge Opt. F1 : General Help F2 : Previous Values F3 : Optimized Defaults F4 : Save and Exit ESC : Exit
System Date [Fri 01/01/2021]					
System Time [00:12:29]					

Version 2.22.1282. Copyright (C) 2023 AMI

System Time:

Set the system time, the time format is:

Hour : 0 to 23
 Minute : 0 to 59
 Second : 0 to 59

System Date:

Set the system date, the date format is:

Day: Note that the 'Day' automatically changes when you set the date.
Month: 01 to 12
Date: 01 to 31
Year: 1998 to 2099

3.4 Advanced Settings

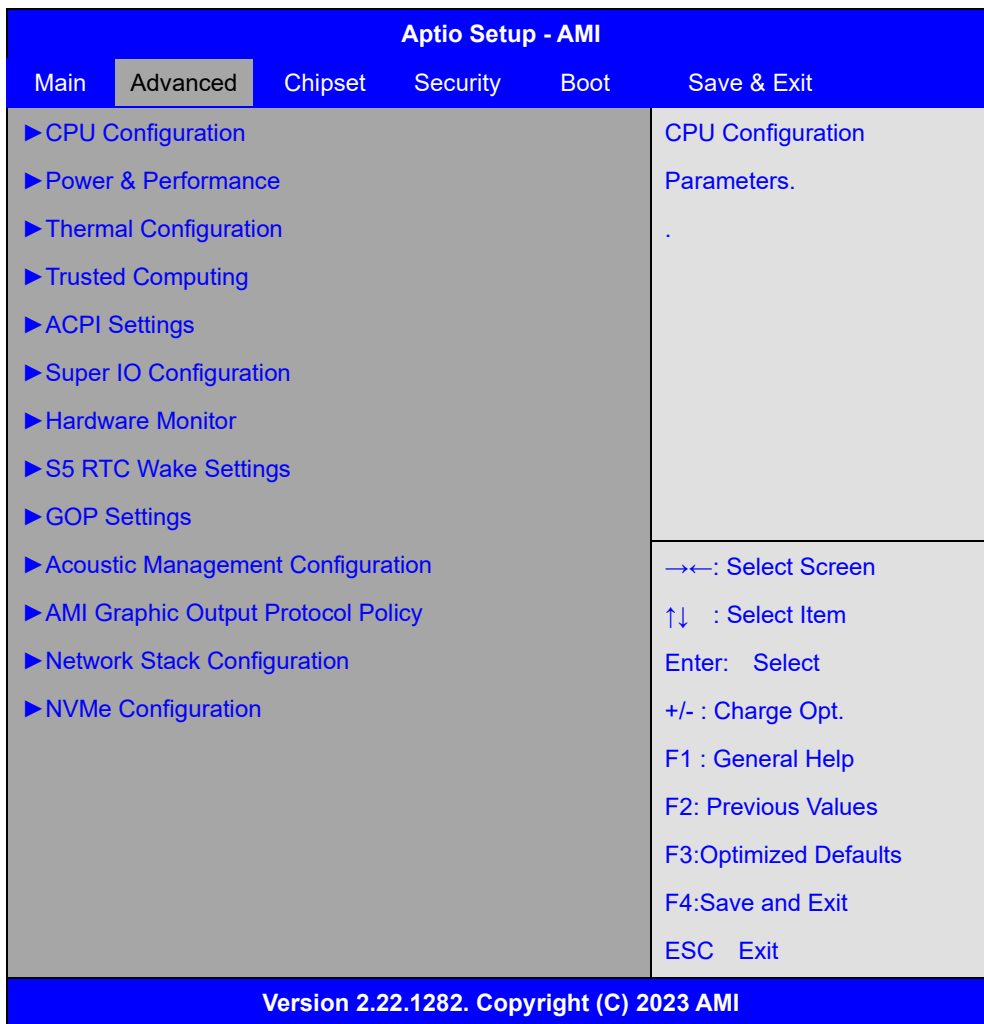

3.4.1 CPU Configuration

Type	Intel® Celeron® J6412@ 2.00GHz
ID	0x90661
Speed	2000 MHz
L1 Data Cache	32 KB x 4
L1 Instruction Cache	32 KB x 4
L2 Cache	1536 KB x 4
L3 Cache	4 MB
L4 Cache	N/A
VMX	Supported
SMX/TXT	Not Supported
CPU Flex Ratio Override:	[Disabled] [Enabled]
CPU Flex Ratio Settings	20

Hardware Prefetcher:	[Disabled] [Enabled]
Intel (VNX) Virtualization Technology:	[Disabled] [Enabled]
PECI:	[Disabled] [Enabled]
Active Processor Cores:	[ALL] [1] [2] [3]
BIST:	[Disabled] [Enabled]
AP threads Idle Manner:	[HALT Loop] [MWAIT Loop] [RUN Loop]
AES:	[Disabled] [Enabled]
MachineCheck:	[Disabled] [Enabled]
MonitorMWait:	[Disabled] [Enabled]
CPU SMM Enhancement CPU SMM Enhancement	
SMM Use Delay Indication:	[Disabled] [Enabled]
SMM Use Block Indication:	[Disabled] [Enabled]
SMM Use SMM en-US Indication:	

[Disabled]

[Enabled]

#AC Split Lock:

[Enabled]

[Disabled]

3.4.2 Power & Performance

Power & Performance

CPU – Power Management Control

CPU – Power Management Control

P0 Fused Max Core Ratio N/A

P1 Fused Max Core Ratio N/A

P2 Fused Max Core Ratio N/A

P3 Fused Max Core Ratio N/A

Boot performance mode:

[Max Battery]

[Max Non-Turbo Performance]

[Turbo Performance]

Intel (R) SpeedStep(tm):

[Disabled]

[Enabled]

Race To Halt (RTH):

[Disabled]

[Enabled]

Intel (R) Speed Shift Technology:

[Disabled]

[Enabled]

HWP Autonomous EPP Grouping:

[Disabled]

[Enabled]

EPB override over PECl:

[Disabled]

[Enabled]

HWP Fast MSR Support:

[Disabled]

[Enabled]

HDC Control:

[Disabled]

[Enabled]

Turbo Mode:

[Disabled]

[Enabled]

View/Configure Turbo Options

Current Turbo Settings

Max Turbo Power Limit	4095.875
Min Turbo Power Limit	0.0
Package TDP Limit	10.0
Power Limit 1	10.0
Power Limit 2	20.0
1-core Turbo Ratio	26
2- core Turbo Ratio	26
3- core Turbo Ratio	26
4- core Turbo Ratio	26

Energy Efficient P-state:

[Disabled]

[Enabled]

Package Power Limit MSR Lock:

[Disabled]

[Enabled]

Power Limit 1 Override:

[Disabled]

[Enabled]

Power Limit 2 Override:

[Disabled]

[Enabled]

Power Limit 2	0
1-Core Ratio Limit Override	26
2-Core Ratio Limit Override	26
3-Core Ratio Limit Override	26
4-Core Ratio Limit Override	26

Energy Efficient Turbo:

[Disabled]

[Enabled]

CPU VR Settings

CPU VR Ssttings

PSYS Slope	0
PSYS Offset	0
PSYS Prefix:	

[+]

		[-]
PSYS PMax Power	0	
Acoustic Noise Settings		
Acoustic Noise Settings		
Acoustic Noise Mitigation:		
		[Disabled]
		[Enabled]
Vccln VR Domain		
Disable Fast PKG C State Ramp for Vccln Domain:		
		[FALSE]
		[TRUE]
Slow Slew Rate for Vccln Domain:		
		[Fast/2]
		[Fast/4]
		[Fast/8]
		[Fast/16]
Vccln VR Settings		
Vccln VR Domain		
VR Config Enable:		
		[Disabled]
		[Enabled]
AC Loadline	880	
DC Loadline	860	
PS Current Threshold1	0	
PS Current Threshold2	0	
PS Current Threshold3	0	
PS3 Enable:		
		[Disabled]
		[Enabled]
PS4 Enable:		
		[Disabled]
		[Enabled]
IMON Slope	100	
IMON Offset	1	
IMON Prefix		[+]
VR Current Limit	90	
TDC Enable:		
		[Disabled]
		[Enabled]
TDC Current Limit	112	

TDC Time Window:

- [1 ms]
- [2 ms]
- [3 ms]
- [4 ms]
- [5 ms]
- [6 ms]
- [7 ms]
- [8 ms]
- [9 ms]
- [10 ms]

TDC Lock:

- [Disabled]
- [Enabled]

RFI Settings

RFI Domain

- RFI Current Frequency 139.200MHz
- RFI Frequency 0
- RFI Spread Spectrum 15

Platform PL1 Enable:

- [Disabled]
- [Enabled]

Platform PL2 Enable:

- [Disabled]
- [Enabled]

Power Limit 4 Override:

- [Disabled]
- [Enabled]

C states:

- [Disabled]
- [Enabled]

Enhanced C-states:

- [Disabled]
- [Enabled]

C-state Auto Demotion [C1]

C-state Un-demotion [C1]

Package C-State Demotion:

- [Disabled]
- [Enabled]

Package C-State Un-demotion:

	[Disabled]
	[Enabled]
CState Pre-Wake:	
	[Disabled]
	[Enabled]
IO MWAIT Redirection:	
	[Disabled]
	[Enabled]
Package C State Limit	[C3]
C6/C7 Short Latency Control(MSR 0x60B)	
Time Unit	[1024 ns]
Latency	0
C6/C7 Short Latency Control(MSR 0x60C)	
Time Unit	[1024 ns]
Latency	0
C8 Latency Control(MSR 0x633)	
Time Unit	[1024 ns]
Latency	0
C9 Latency Control(MSR 0x634)	
Time Unit	[1024 ns]
Latency	0
C10 Latency Control(MSR 0x635)	
Time Unit	[1024 ns]
Latency	0
Thermal Monitor:	
	[Disabled]
	[Enabled]
Interrupt Redirection Mode Selection:	
	[Fixed Priority]
	[Round robin]
	[Hash Vector]
	[No Change]
Timed MWAIT:	
	[Disabled]
	[Enabled]
Custom P-state Table	
Custom P-state Table	
Number of P states	0
EC Turbo Control Mode:	
	[Disabled]
	[Enabled]

Energy Performance Gain:

[Disabled]

[Enabled]

EPG DIMM Idd3N

26

EFG DIMM Idd3P

11

Power Limit 3 Settings

CPU Lock Configuration

CFG Lock:

[Disabled]

[Enabled]

Overclocking Lock:

[Disabled]

[Enabled]

GT – Power Management Control

GT – Power Management Control

Maximum GT frequency:

[Default Max Frequency]

[100Mhz]

[150Mhz]

[200Mhz]

[250Mhz]

[300Mhz]

[350Mhz]

[400Mhz]

[450Mhz]

[500Mhz]

[550Mhz]

[600Mhz]

[650Mhz]

[700Mhz]

[750Mhz]

[800Mhz]

[850Mhz]

[900Mhz]

[950Mhz]

[1000Mhz]

[1050Mhz]

[1100Mhz]

[1150Mhz]

[1200Mhz]

Disable Turbo GT frequency:

[Enabled]

[Disabled]

3.4.3 Thermal Configuration

Thermal Configuration

Enable All Thermal Funcations:

[Disabled]

[Enabled]

CPU Thermal Configuration

Cpu Thermal Configuration

DTS SMM:

[Disabled]

[Enabled]

[Critical Temp Reporting(Out of spec)]

Tcc Activation Offset

25

Tcc Offset Time Window:

[Disabled]

[5ms]

[10 ms]

[55 ms]

[156 ms]

[375 ms]

[500 ms]

[750 ms]

[1 sec]

[2 sec]

[3 sec]

[4 sec]

[5 sec]

[6 sec]

[7 sec]

[8 sec]

[10 sec]

[12 sec]

[14 sec]

[16 sec]

[20 sec]

[24 sec]

[28 sec]

[32 sec]

[40 sec]
[48 sec]
[56 sec]
[64 sec]
[80 sec]
[96 sec]
[112 sec]
[128 sec]
[160 sec]
[192 sec]
[224 sec]
[256 sec]
[320 sec]

Tcc Offset Clamp Enable:

[Disabled]
[Enabled]

Tcc Offset Lock Enable:

[Disabled]
[Enabled]

Bi-directional PROCHOT#:

[Disabled]
[Enabled]

Disable PROCHOT# Output:

[Disabled]
[Enabled]

Disable VR Thermal Alert:

[Disabled]
[Enabled]

PROCHOT Response:

[Disabled]
[Enabled]

PROCHOT Lock:

[Disabled]
[Enabled]

ACPI T-States:

[Disabled]
[Enabled]

Platform Thermal Configuration
Platform Thermal Configuration

Critical Trip Point:

[15 C]
[23 C]
[31 C]
[39 C]
[47 C]
[55 C]
[63 C]
[71 C]
[79 C]
[87 C]
[95 C]
[100 C]
[103 C]
[111 C]
[119 C (POR)]
[127 C]
[130 C]

Active Trip Point 0:

[Disabled]
[15 C]
[23 C]
[31 C]
[39 C]
[47 C]
[55 C]
[63 C]
[71 C]
[79 C]
[87 C]
[95 C]
[103 C]
[111C]
[119 C (POR)]

Active Trip Point 0 Fan Speed: 100

Active Trip Point 1:

[Disabled]
[15 C]
[23 C]
[31 C]
[39 C]
[47 C]
[55 C]

	[63 C]
	[71 C]
	[79 C]
	[87 C]
	[95 C]
	[103 C]
	[111C]
	[119 C (POR)]
Active Trip Point 1 Fan Speed:	75
Passive Trip Point :	
	[Disabled]
	[15 C]
	[23 C]
	[31 C]
	[39 C]
	[47 C]
	[55 C]
	[63 C]
	[71 C]
	[79 C]
	[87 C]
	[95 C]
	[103 C]
	[111C]
	[119 C (POR)]
Passive TC1 Value	1
Passive TC2 Value	5
Passive TSP Value	10
Active Trip Points:	
	[Disabled]
	[Enabled]
Passive Trip Points:	
	[Disabled]
	[Enabled]
CriticalTrip Points:	
	[Disabled]
	[Enabled]
PCH Temp Read:	
	[Disabled]
	[Enabled]

CPU Energy Read:	[Disabled]
	[Enabled]
CPU Temp Read:	[Disabled]
	[Enabled]
Alert Enable Lock:	[Disabled]
	[Enabled]
CPU Temp	72
CPU Fan Speed	65
DPTF Configuration	
DPTF Configuration	
Hardware Health Monitor	
Hardware Health Monitor	
Thermal Sensor 1 Temp	0.0 C
Thermal Sensor 2 Temp	0.0 C
Thermal Sensor 3 Temp	0.0 C
Thermal Sensor 4 Temp	0.0 C
CPU Fan Speed	0 rpm

3.4.4 Trusted Computing

Configuration

Security Device Support:	[Disabled]
	[Enabled]
NO Security Device Found	

3.4.5 ACPI Settings

ACPI Settings

Enable Hibernation:	[Disabled]
	[Enabled]
ACPI Sleep State:	[Suspend]
	[S3 (Suspend to RAM)]

3.4.6 Super IO Configuration

Super IO Configuration

Super IO Chip IT8786

Serial Port 1 Configuration

Serial Port 1 Configuration

Serial Port:

[Disabled]

[Enabled]

Device Settings IO=3F8h; IRQ=4;

Change Settings:

[Auto]

[IO=3F8h; IRQ=4]

[IO=3F8h; IRQ=3,4,5,6,7,9,10,11,12;]

[IO=2F8h; IRQ=3,4,5,6,7,9,10,11,12;]

[IO=3E8h; IRQ=3,4,5,6,7,9,10,11,12;]

[IO=2E8h; IRQ=3,4,5,6,7,9,10,11,12;]

COM1 Config:

[RS232 mode]

[RS485 mode]

[RS422 mode]

Serial Port 2 Configuration

Serial Port 2 Configuration

Serial Port:

[Disabled]

[Enabled]

Device Settings IO=2F8h; IRQ=4;

Change Settings:

[Auto]

[IO=2F8h; IRQ=4]

[IO=3F8h; IRQ=3,4,5,6,7,9,10,11,12;]

[IO=2F8h; IRQ=3,4,5,6,7,10,11,12;]

[IO=3E8h; IRQ=3,4,5,6,7,9,10,11,12;]

[IO=2E8h; IRQ=3,4,5,6,7,9,10,11,12;]

Serial Port 3 Configuration

Serial Port 3 Configuration

Serial Port:

[Disabled]

[Enabled]

Device Settings IO=3E8h; IRQ=4;

Change Settings:
 [Auto]

Serial Port 4 Configuration
 Serial Port 4 Configuration
 Serial Port:
 [Disabled]
 [Enabled]

Device Settings IO=2E8h; IRQ=4;

Change Settings:
 [Auto]

Serial Port 5 Configuration
 Serial Port 5 Configuration
 Serial Port:
 [Disabled]
 [Enabled]

Device Settings IO=2F0h; IRQ=4;

Change Settings:
 [Auto]

COM5 Config:
 [RS485 mode]
 [RS422 mode]

Serial Port 6 Configuration
 Serial Port 6 Configuration
 Serial Port:
 [Disabled]
 [Enabled]

Device Settings IO=2F0h; IRQ=4;

Change Settings:
 [Auto]

COM6 Config:
 [RS485 mode]
 [RS422 mode]

3.4.7 Hardware Monitor

Pc Health Status

System temperature1 : +39 C
 Fan1 Speed : 6887 RPM

CPU_CORE_VIN	: +1.653 V
+1.2V	: +1.236 V
+12V	: +13.120 V
+5V	: +5.123 V
Smart Fan Function	
Fan 1 Setting	
Fan 1 Setting	
Smart Fan 1 Mode:	[Software Mode] [Automatic Mode]
Fan 1 Type:	[PWM] [RPM]
Temperature select:	[TMPIN1] [TMPIN2] [TMPIN3]
Fan off temperature limit:	0
Fan start temperature limit:	30
Fan full speed temperature limit:	90
Fan start PWM:	75
PWM SLOPE SETTING:	3
Temperature:	4

3.4.8 S5 RTC Wake Settings

Wake system from S5:

[Disabled]
[Fixed Time]
[Dynamic Time]

3.4.9 GOP Settings

LCD Panel Type [Auto]

3.4.10 Acoustic Management Configuration

Acoustic Management Configuration
HDD not found
HDD not found

3.4.11 AMI Graphic Output Protocol Configuration

Intel® Graphics Controller
Intel® GOP Driver [18.0.1034]
Output Select:

[EDP1]

[DP1]

Brightness Setting

255

BIST Enable:

[Disabled]

[Enabled]

3.4.12 Network Stack Configuration

Network Stack:

[Disabled]

[Enabled]

3.4.13 NVME Configuration

NVMe Configuration

No NVME Device Found

3.5 Chipset Settings

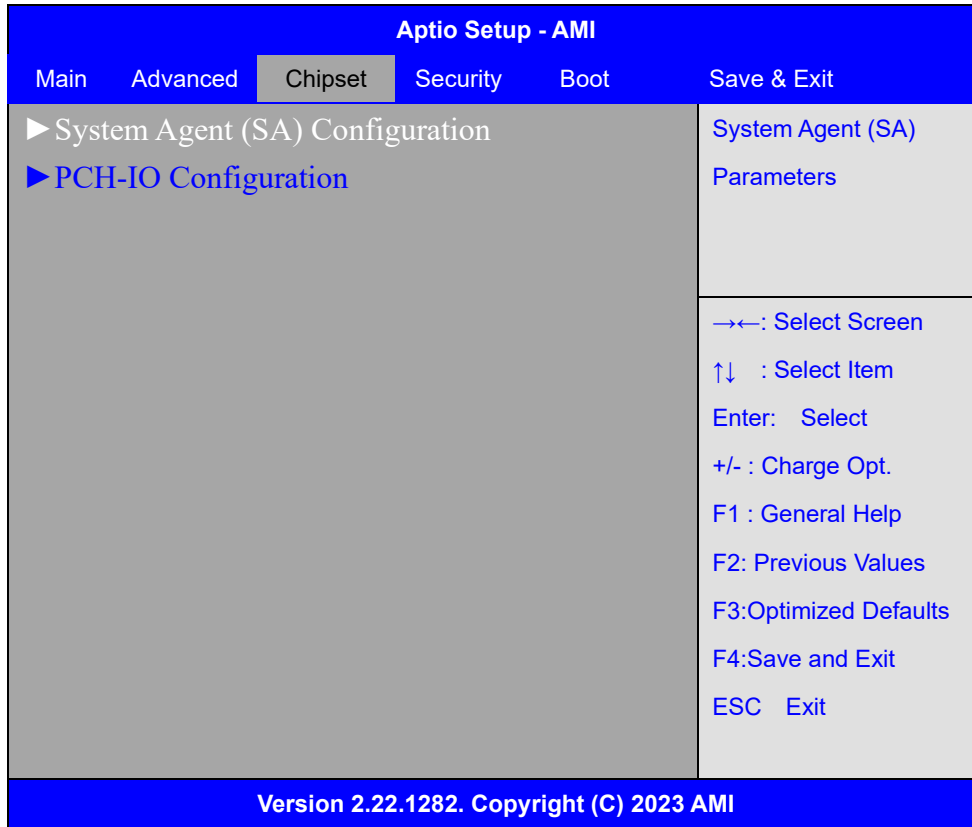

3.5.1 System Agent (SA) Configuration

System Agent (SA) Configuration

Memory Configuration

Memory Thermal Configuration

Memory Thermal Configuration

Memory Power and Thermal Throttling

Memory Power and Thermal Throttling

DDR PowerDown and idle counter:

[PCODE]

[BIOS]

FOR LPDDR Only: DDR PowerDown and Idle counter

[PCODE]

[BIOS]

REFRESH_2X_MODE:

[Disabled]

[1- Enabled for WARM or HOT]

LPDDR Thermal Sensor:

[Disabled]

[Enabled]

SelfRefresh Enable:

[Disabled]

[Enabled]

SelfRefresh IdleTimer:

512

Throttler CKEMin Defeature:

[Enabled]

[Disabled]

Throttler CKKEMin Timer:

48

For LPDDR Only: Throttler CKEMin Defeature:

[Enabled]

[Disabled]

For LPDDR Only: Throttler CKEMin Timer: 64

Dram Power Meter

Dram Power Meter

Use user provided power weights,
Scale factor, and channel power

Floor values:

[Disabled]

[Enabled]

Energy Scale Factor

4

Idle Energy Ch0Dimm0

10

PowerDown Energy Ch0Dimm0

6

Activate Energy Ch0Dimm0

172

Read Energy Ch0Dimm0

212

Write Energy Ch0Dimm0

221

Idle Energy Ch0Dimm1

10

PowerDown Energy Ch0Dimm1

6

Activate Energy Ch0Dimm1

172

Read Energy Ch0Dimm1

212

Write Energy Ch0Dimm1

221

Idle Energy Ch1Dimm0

10

PowerDown Energy Ch1Dimm0

6

Activate Energy Ch1Dimm0

172

Read Energy Ch1Dimm0

212

Write Energy Ch1Dimm0	221
Idle Energy Ch1Dimm1	10
PowerDown Energy Ch1Dimm1	6
Activate Energy Ch1Dimm1	172
Read Energy Ch1Dimm1	212
Write Energy Ch1Dimm1	221
Memory Thermal Reporting	
Lock Thermal Management Registers:	
	[Disabled]
	[Enabled]
Memory Thermal Reporting	
Extern Therm Status:	
	[Disabled]
	[Enabled]
Closed Loop Therm Manage:	
	[Disabled]
	[Enabled]
Open Loop Therm Manage:	
	[Disabled]
	[Enabled]
Thermal Threshold Settings	
Warm Threshold Ch0 Dimm0	255
Warm Threshold Ch0 Dimm1	255
Hot Threshold Ch0 Dimm0	255
Hot Threshold Ch0 Dimm1	255
Warm Threshold Ch1 Dimm0	255
Warm Threshold Ch1 Dimm1	255
Hot Threshold Ch1 Dimm0	255
Hot Threshold Ch1 Dimm1	255
Thermal Throttle Budget Settings	
Warm Budget Ch0 Dimm0	255
Warm Budget Ch0 Dimm1	255
Hot Budget Ch0 Dimm0	255
Hot Budget Ch0 Dimm1	255
Warm Budget Ch1 Dimm0	255
Warm Budget Ch1 Dimm1	255

Hot Budget Ch1 Dimm0	255
Hot Budget Ch1 Dimm1	255
Memory RAPL	
Memory RAPL	
Rap1 Power Floor Ch0	0
Rap1 Power Floor Ch1	0
RAPL PL Lock:	[Disabled] [Enabled]
RAPL PL 1 enable:	[Disabled] [Enabled]
RAPL PL 1 Power	0
RAPL PL 1 WindowX	0
RAPL PL 1 WindowY	0
RAPL PL 2 enable:	[Disabled] [Enabled]
RAPL PL 2 Power	222
RAPL PL 2 WindowX	1
RAPL PL 2 WindowY	10
Memory Thermal Management:	[Disabled] [Enabled]
Memory Training Algorithms:	
Early Command Training:	[Disabled] [Enabled]
SenseAmp Offset Training:	[Disabled] [Enabled]
Early ReadMPR Timing Centering 2D:	[Disabled] [Enabled]
Read MPR Training:	[Disabled] [Enabled]
Receive Enable Training:	

	[Disabled]
	[Enabled]
Jedec Write Leveling:	
	[Disabled]
	[Enabled]
LPDDR4 Write DQ DQS Retraining:	
	[Disabled]
	[Enabled]
Early Write Time Centering 2D:	
	[Disabled]
	[Enabled]
Early Read Time Centering 2D:	
	[Disabled]
	[Enabled]
Write Timing Centering 1D:	
	[Disabled]
	[Enabled]
Write Voltage Centering 1D:	
	[Disabled]
	[Enabled]
Read Timing Centering 1D:	
	[Disabled]
	[Enabled]
Dimm ODT Training* :	
	[Disabled]
	[Enabled]
Max RTT_WR:	
	[ODT Off]
	[120 Ohms]
DIMM RON Training*:	
	[Disabled]
	[Enabled]
Write Drive Strength/Equalization 2D*:	
	[Disabled]
	[Enabled]
Write Slew Rate Training*:	
	[Disabled]
	[Enabled]
Read ODT Training*:	
	[Disabled]
	[Enabled]
Read Equalization Training*:	

	[Disabled]
	[Enabled]
Read Amplifier Training*:	
	[Disabled]
	[Enabled]
Write Timing Centering 2D:	
	[Disabled]
	[Enabled]
Read Timing Centering 2D:	
	[Disabled]
	[Enabled]
Command Voltage Centering:	
	[Disabled]
	[Enabled]
Write Voltage Centering 2D:	
	[Disabled]
	[Enabled]
Read Voltage Centering 2D:	
	[Disabled]
	[Enabled]
Late Command Training:	
	[Disabled]
	[Enabled]
Round Trip Latency:	
	[Disabled]
	[Enabled]
Turn Around Timing Training:	
	[Disabled]
	[Enabled]
Rank Margin Tool:	
	[Disabled]
	[Enabled]
Rank Margin Tool Per Bit:	
	[Disabled]
	[Enabled]
Margin Check Limit:	
	[Disabled]
	[L1]
	[L2]
	[Both]
Margin Limit Check L2:	100
Memory Test:	

	[Disabled]
	[Enabled]
DIMM SPD Alias Test:	
	[Disabled]
	[Enabled]
Receive Enable Centering 1D:	
	[Disabled]
	[Enabled]
Retrain Margin Check:	
	[Disabled]
	[Enabled]
Write Drive Strength Up/ Dn independently:	
	[Disabled]
	[Enabled]
Command Slew Rate Training:	
	[Disabled]
	[Enabled]
Command Drive Strength and Equalization:	
	[Disabled]
	[Enabled]
Command Normalization:	
	[Disabled]
	[Enabled]
Early DQ Write Drive Strength and Equalization Training:	
	[Disabled]
	[Enabled]
Read Voltage Centering 1D:	
	[Disabled]
	[Enabled]
Write TC0 Comp Training:	
	[Disabled]
	[Enabled]
Clock TC0 Comp Training:	
	[Disabled]
	[Enabled]
Dimm ODT CA Training:	
	[Disabled]
	[Enabled]
Write TC0 Dqs Training:	

	[Disabled]
	[Enabled]
Duty Cycle Correction:	
	[Disabled]
	[Enabled]
DQ DFE Training:	
	[Disabled]
	[Enabled]
Sense Amplifier Correction Training:	
	[Disabled]
	[Enabled]
Memory Configuration	
Memory RC Version	0.0.4.104
Memory Data Rate	3200 MTPS
Memory Timings (tCL-tRCD-tRP-tRAS)	22-22-22-52
Channel 0 Slot 0	Not Populated / Disabled
Channel 0 Slot 1	Not Populated / Disabled
Channel 1 Slot 0	Populated & Enabled
Size	8192 MB (DDR4)
Number of Ranks	1
Manufacturer	Samsung
Channel 1 Slot 1	Not Populated / Disabled
Memory ratio/reference clock	
Options moved to	
Overclock->Memory->Custom Profile	
Menu	
MRC ULT Safe Config:	
	[Disabled]
	[Enabled]
Safe Mode Support:	
	[Disabled]
	[Enabled]
Maximum Memory Frequency:	
	[Auto]
	[1067]
	[1200]
	[1333]
	[1400]
	[1600]

	[1800]
	[1867]
	[2000]
	[2133]
	[2200]
	[2400]
	[2600]
	[2667]
	[2800]
	[2933]
	[3000]
	[3200]
	[3467]
	[3600]
	[3733]
	[4000]
	[4200]
	[4267]
HOB Buffer Size:	[Auto]
	[1B]
	[1KB]
	[Max (assuming 63KB total HOB size)]
Max TOLUD:	[Dynamic]
	[1 GB]
	[1.25 GB]
	[1.5 GB]
	[1.75 GB]
	[2 GB]
	[2.25 GB]
	[2.5 GB]
SA GV:	[Disabled]
	[Fixed Low]
	[Fixed Mid]
	[Fixed High]
	[Enabled]
DDR Speed Control:	[Auto]
	[Manual]
Retrain on Fast Fail:	

	[Disabled]
	[Enabled]
DDR4_1DPC:	
	[Disabled]
	[Enabled on DIMM0 only]
	[Enabled on DIMM1 only]
	[Enabled]
Enable RH Prevention:	
	[Disabled]
	[Enabled]
REFRESH_PANIC_WM:	9
REFRESH_HP_WM:	8
Exit On Failure (MRC):	
	[Disabled]
	[Enabled]
Enable/Disable IED (Intel Enhanced Debug):	
	[Enabled]
	[Disabled]
Ch Hash Support:	
	[Disabled]
	[Enabled]
Ch Hash Mask:	12492
Ch Hash Interleaved Bit:	
	[BIT6]
	[BIT7]
	[BIT8]
	[BIT9]
	[BIT10]
	[BIT11]
	[BIT12]
	[BIT13]
Extended Bank Hashing:	
	[Disabled]
	[Enabled]
Per Bank Refresh:	
	[Disabled]
	[Enabled]
Power Down Mode:	
	[Auto]
	[No Power Down]
	[APD]

	[PPD-DLLoff]
Page Close Idle Timeout:	[Enabled] [Disabled]
Memory Scrambler:	[Enabled] [Disabled]
Force ColdReset:	[Enabled] [Disabled]
Channel 0 DIMM Control:	[Enable both DIMMs] [Disable DIMM0] [Disable DIMM1] [Disable both DIMMs]
Channel 1 DIMM Control:	[Enable both DIMMs] [Disable DIMM0] [Disable DIMM1] [Disable both DIMMs]
Force Single Rank:	[Disabled] [Enabled]
Force Single Sub Channel:	[Disabled] [Enabled]
MRC TASK Debug Print Enable:	0
Memory Remap:	[Enabled] [Disabled]
Time Measure:	[Disabled] [Enabled]
DLL Weak Lock Support:	[Disabled] [Enabled]
Fast Boot:	[Disabled] [Enabled]
Train On Warm boot:	[Disabled] [Enabled]

Rank Margin Tool Per Task:	[Disabled] [Enabled]
Training Tracing:	[Disabled] [Enabled]
Lpddr Mem WL Set:	[Set A] [Set B]
BDAT Memory Test Type	[Rank Margin Tool Rank]
Rank Margin Tool Loop Count:	0
Low Supply for LPDDR4 Data:	[Disabled] [Enabled]
Low Supply for LPDDR4 Clock/Command/Control:	[Disabled] [Enabled]
Memory Test on Warm Boot:	[Disabled] [Enabled]
Graphics Configuration	
Graphics Configuration	
Primary Display:	[Auto] [IGFX] [PEG] [PCI]
External Gfx Card Primary Display Configuration	
External Gfx Card Primary Display Configuration	
Primary PCIE:	[Auto] [PCIE 1] [PCIE 2] [PCIE 3] [PCIE 4] [PCIE 5] [PCIE 6] [PCIE 7]

	[PCIE 8]
	[PCIE 9]
	[PCIE 10]
	[PCIE 11]
	[PCIE 12]
	[PCIE 13]
	[PCIE 14]
	[PCIE 15]
	[PCIE 16]
	[PCIE 17]
	[PCIE 18]
	[PCIE 19]
Internal Graphics:	[Auto]
	[Disabled]
	[Enabled]
GTT Size:	[2 MB]
	[4 MB]
	[8 MB]
Aperture Size:	[128 MB]
	[256 MB]
	[512 MB]
	[1024 MB]
	[2048 MB]
PSMI SUPPORT:	[Disabled]
	[Enabled]
DVMT- Pre-Allocated:	[0M]
	[32M]
	[64M]
	[96M]
	[128M]
	[160M]
	[4M]
	[8M]
	[12M]
	[16M]
	[20M]
	[24M]

	[28M]
	[32M/F7]
	[36M]
	[40M]
	[44M]
	[48M]
	[52M]
	[56M]
	[60M]
DVMT Total Gfx Mem:	
	[128M]
	[256M]
	[MAX]
DISM Size:	
	[0GB]
	[1GB]
	[2GB]
	[3GB]
	[4GB]
	[5GB]
	[6GB]
	[7GB]
Intel Graphics Pei Display Peim:	
	[Enabled]
	[Disabled]
VDD Enable:	
	[Disabled]
	[Enabled]
Configure GT for use:	
	[Enabled]
	[Disabled]
PAVP Enable:	
	[Enabled]
	[Disabled]
Cdynmax Clamping Enable:	
	[Enabled]
	[Disabled]
Cd Clock Frequency:	
	[172.8 Mhz]
	[307.2 Mhz]
	[556.8 Mhz]
	[652.8 Mhz]

[Max CdClock freq based on Reference C1k]

Skip Full CD Clock Init:

[Enabled]

[Disabled]

VBT Select:

[eDP]

[MIPI]

IUER Button Enable:

[Disabled]

[Enabled]

Intel(R) Ultrabook Event Support:

Intel(R) Ultrabook Event Support

IUER Slate Enable:

[Disabled]

[Enabled]

IUER Dock Enable:

[Disabled]

[Enabled]

VT-d:

[Disabled]

[Enabled]

3.5.2 PCH-IO Configuration

PCH-IO Configuration

PCI Express Configuration

PCI Express Configuration

DMI Link ASPM Control:

[Disabled]

[L0s]

[L1]

[L0sL1]

[Auto]

PCIE Port assigned to LAN Disabled

Port8xh Decode:

[Disabled]

[Enabled]

Peer Memory write Enable:

[Disabled]

[Enabled]

Compliance Test Mode:

[Disabled]

[Enabled]

PCH PCI Express Clock Gating:

[Platform-POR]

[Enabled]

[Disabled]

PCIe function swap:

[Disabled]

[Enabled]

PCIe EQ settings

PCIe EQ override:

[Disabled]

[Enabled]

PCIe Express Root Port 1

PCIe Express Root Port 1:

[Disabled]

[Enabled]

Connection Type:

[Built - in]

[Slot]

ASPM:

	[Disabled]
	[L0s]
	[L1]
	[L0sL1]
	[Auto]
L1 Substates:	
	[Disabled]
	[L1.1]
	[L1.1 & L1.2]
ACS:	
	[Disabled]
	[Enabled]
PTM:	
	[Disabled]
	[Enabled]
DPC:	
	[Disabled]
	[Enabled]
EDPC:	
	[Disabled]
	[Enabled]
URR:	
	[Disabled]
	[Enabled]
FER:	
	[Disabled]
	[Enabled]
NFER:	
	[Disabled]
	[Enabled]
CER:	
	[Disabled]
	[Enabled]
SEFE:	
	[Disabled]
	[Enabled]
SENF:	
	[Disabled]
	[Enabled]
SECE:	
	[Disabled]
	[Enabled]

PME SCI:	[Disabled]
	[Enabled]
Hot Plug:	[Disabled]
	[Enabled]
Advanced Error Reporting:	[Disabled]
	[Enabled]
PCIe Speed:	[Auto]
	[Gen1]
	[Gen2]
	[Gen3]
Transmitter Half Swing:	[Disabled]
	[Enabled]
Detect Timeout:	0
Extra Bus Reserved:	0
Reserved Memory:	10
Reserved I/O:	4
PCH PCIe LTR Configuration	
LTR:	[Disabled]
	[Enabled]
Snoop Latency Override:	[Disabled]
	[Manual]
	[Auto]
Non Snoop Latency Override:	[Disabled]
	[Manual]
	[Auto]
Force LTR Override:	[Disabled]
	[Enabled]
LTR Lock:	[Disabled]
	[Enabled]
Extra options	
Detect Non-Compliance Device:	

	[Disabled]
	[Enabled]
Prefetchable Memory:	10
Reserved Memory	
Alignment:	1
Prefetchable Memory	
Alignment:	1
PCIe Express Root Port 2	
PCIe Express Root Port 2:	
	[Disabled]
	[Enabled]
Connection Type:	
	[Built - in]
	[Slot]
ASPM:	
	[Disabled]
	[L0s]
	[L1]
	[L0sL1]
	[Auto]
L1 Substates:	
	[Disabled]
	[L1.1]
	[L1.1 & L1.2]
ACS:	
	[Disabled]
	[Enabled]
PTM:	
	[Disabled]
	[Enabled]
DPC:	
	[Disabled]
	[Enabled]
EDPC:	
	[Disabled]
	[Enabled]
URR:	
	[Disabled]
	[Enabled]
FER:	
	[Disabled]
	[Enabled]

NFER:	[Disabled] [Enabled]
CER:	[Disabled] [Enabled]
SEFE:	[Disabled] [Enabled]
SENF:	[Disabled] [Enabled]
SECE:	[Disabled] [Enabled]
PME SCI:	[Disabled] [Enabled]
Hot Plug:	[Disabled] [Enabled]
Advanced Error Reporting:	[Disabled] [Enabled]
PCIe Speed:	[Auto] [Gen1] [Gen2] [Gen3]
Transmitter Half Swing:	[Disabled] [Enabled]
Detect Timeout:	0
Extra Bus Reserved:	0
Reserved Memory:	10
Reserved I/O:	4
PCH PCIe LTR Configuration	
LTR:	[Disabled] [Enabled]
Snoop Latency Override:	

	[Disabled]
	[Manual]
	[Auto]
Non Snoop Latency Override:	
	[Disabled]
	[Manual]
	[Auto]
Force LTR Override:	
	[Disabled]
	[Enabled]
LTR Lock:	
	[Disabled]
	[Enabled]
Extra options	
Detect Non-Compliance Device:	
	[Disabled]
	[Enabled]
Prefetchable Memory:	10
Reserved Memory	
Alignment:	1
Prefetchable Memory	
Alignment:	1
PCIe Express Root Port 3	
PCIe Express Root Port 3:	
	[Disabled]
	[Enabled]
Connection Type:	
	[Built - in]
	[Slot]
ASPM:	
	[Disabled]
	[L0s]
	[L1]
	[L0sL1]
	[Auto]
L1 Substates:	
	[Disabled]
	[L1.1]
	[L1.1 & L1.2]
ACS:	
	[Disabled]
	[Enabled]

PTM:	[Disabled] [Enabled]
DPC:	[Disabled] [Enabled]
EDPC:	[Disabled] [Enabled]
URR:	[Disabled] [Enabled]
FER:	[Disabled] [Enabled]
NFER:	[Disabled] [Enabled]
CER:	[Disabled] [Enabled]
SEFE:	[Disabled] [Enabled]
SENF:	[Disabled] [Enabled]
SECE:	[Disabled] [Enabled]
PME SCI:	[Disabled] [Enabled]
Hot Plug:	[Disabled] [Enabled]
Advanced Error Reporting:	[Disabled] [Enabled]
PCIe Speed:	[Auto] [Gen1]

	[Gen2]
	[Gen3]
Transmitter Half Swing:	
	[Disabled]
	[Enabled]
Detect Timeout:	0
Extra Bus Reserved:	0
Reserved Memory:	10
Reserved I/O:	4
PCH PCIe LTR Configuration	
LTR:	
	[Disabled]
	[Enabled]
Snoop Latency Override:	
	[Disabled]
	[Manual]
	[Auto]
Non Snoop Latency Override:	
	[Disabled]
	[Manual]
	[Auto]
Force LTR Override:	
	[Disabled]
	[Enabled]
LTR Lock:	
	[Disabled]
	[Enabled]
Extra options	
Detect Non-Compliance Device:	
	[Disabled]
	[Enabled]
Prefetchable Memory:	10
Reserved Memory	
Alignment:	1
Prefetchable Memory	
Alignment:	1
PCIe Express Root Port 4	
PCIe Express Root Port 4:	
	[Disabled]
	[Enabled]

Connection Type:	[Built - in] [Slot]
ASPM:	[Disabled] [L0s] [L1] [L0sL1] [Auto]
L1 Substates:	[Disabled] [L1.1] [L1.1 & L1.2]
ACS:	[Disabled] [Enabled]
PTM:	[Disabled] [Enabled]
DPC:	[Disabled] [Enabled]
EDPC:	[Disabled] [Enabled]
URR:	[Disabled] [Enabled]
FER:	[Disabled] [Enabled]
NFER:	[Disabled] [Enabled]
CER:	[Disabled] [Enabled]
SEFE:	[Disabled] [Enabled]
SENF:	[Disabled]

	[Enabled]
SECE:	[Disabled]
	[Enabled]
PME SCI:	[Disabled]
	[Enabled]
Hot Plug:	[Disabled]
	[Enabled]
Advanced Error Reporting:	[Disabled]
	[Enabled]
PCIe Speed:	[Auto]
	[Gen1]
	[Gen2]
	[Gen3]
Transmitter Half Swing:	[Disabled]
	[Enabled]
Detect Timeout:	0
Extra Bus Reserved:	0
Reserved Memory:	10
Reserved I/O:	4
PCH PCIe LTR Configuration	
LTR:	[Disabled]
	[Enabled]
Snoop Latency Override:	[Disabled]
	[Manual]
	[Auto]
Non Snoop Latency Override:	[Disabled]
	[Manual]
	[Auto]
Force LTR Override:	[Disabled]
	[Enabled]
LTR Lock:	[Disabled]

	[Enabled]
Extra options	
Detect Non-Compliance Device:	[Disabled]
	[Enabled]
Prefetchable Memory:	10
Reserved Memory	
Alignment:	1
Prefetchable Memory	
Alignment:	1
	USB/SATA/UFS
PCI Express Root Port 5	
PCI Express Root Port 5:	[Disabled]
	[Enabled]
Connection Type:	[Built-in]
	[Slot]
ASPM:	[Disabled]
	[L0s]
	[L1]
	[L0sL1]
	[Auto]
L1 Substates:	[Disabled]
	[L1.1]
	[L1.1 & L1.2]
ACS:	[Disabled]
	[Enabled]
Multi-VC:	[Disabled]
	[Enabled]
VC to TC Mapping	
TC0:	VC0
TC1:	[VC0]
	[VC1]
TC2:	[VC0]
	[VC1]

TC3:	[VC0] [VC1]
TC4:	[VC0] [VC1]
TC5:	[VC0] [VC1]
TC6:	[VC0] [VC1]
TC7:	[VC0] [VC1]
PTM:	[Disabled] [Enabled]
DPC:	[Disabled] [Enabled]
EDPC:	[Disabled] [Enabled]
URR:	[Disabled] [Enabled]
FER:	[Disabled] [Enabled]
NFER:	[Disabled] [Enabled]
CER:	[Disabled] [Enabled]
SEFE:	[Disabled] [Enabled]
SENFE:	[Disabled] [Enabled]

SECE:	[Disabled] [Enabled]
PME SCI:	[Disabled] [Enabled]
Hot Plug:	[Disabled] [Enabled]
Advanced Error Reporting:	[Disabled] [Enabled]
PCIe Speed:	[Auto] [Gen1] [Gen2] [Gen3]
Transmitter Half Swing:	[Disabled] [Enabled]
Detect Timeout:	0
Extra Bus Reserved:	0
Reserved Memory:	10
Reserved I/O:	4
PCH PCIe LTR Configuration	
LTR:	[Disabled] [Enabled]
Snoop Latency Override:	[Disabled] [Manual] [Auto]
Non Snoop Latency Override:	[Disabled] [Manual] [Auto]
Force LTR Override:	[Disabled] [Enabled]
LTR Lock:	[Disabled]

	[Enabled]
Extra options	
Detect Non-Compliance Device:	
	[Disabled]
	[Enabled]
Prefetchable Memory:	10
Reserved Memory	
Alignment:	1
Prefetchable Memory	
Alignment:	1
PCI Express Root Port 6	Lane configured as USB/SATA/UFS
PCI Express Root Port 7	
PCI Express Root Port 7:	
	[Disabled]
	[Enabled]
Connection Type:	
	[Built-in]
	[Slot]
ASPM:	
	[Disabled]
	[L0s]
	[L1]
	[L0sL1]
	[Auto]
L1 Substates:	
	[Disabled]
	[L1.1]
	[L1.1 & L1.2]
ACS:	
	[Disabled]
	[Enabled]
Multi-VC:	
	[Disabled]
	[Enabled]
VC to TC Mapping	
TC0:	VC0
TC1:	
	[VC0]
	[VC1]
TC2:	
	[VC0]
	[VC1]

TC3:	[VC0] [VC1]
TC4:	[VC0] [VC1]
TC5:	[VC0] [VC1]
TC6:	[VC0] [VC1]
TC7:	[VC0] [VC1]
PTM:	[Disabled] [Enabled]
DPC:	[Disabled] [Enabled]
EDPC:	[Disabled] [Enabled]
URR:	[Disabled] [Enabled]
FER:	[Disabled] [Enabled]
NFER:	[Disabled] [Enabled]
CER:	[Disabled] [Enabled]
SEFE:	[Disabled] [Enabled]
SENFE:	[Disabled] [Enabled]

SECE:	[Disabled] [Enabled]
PME SCI:	[Disabled] [Enabled]
Hot Plug:	[Disabled] [Enabled]
Advanced Error Reporting:	[Disabled] [Enabled]
PCIe Speed:	[Auto] [Gen1] [Gen2] [Gen3]
Transmitter Half Swing:	[Disabled] [Enabled]
Detect Timeout:	0
Extra Bus Reserved:	0
Reserved Memory:	10
Reserved I/O:	4
PCH PCIe LTR Configuration LTR:	[Disabled] [Enabled]
Snoop Latency Override:	[Disabled] [Manual] [Auto]
Non Snoop Latency Override:	[Disabled] [Manual] [Auto]
Force LTR Override:	[Disabled] [Enabled]
LTR Lock:	[Disabled] [Enabled]

Extra options

Detect Non-Compliance Device:

[Disabled]

[Enabled]

Prefetchable Memory: 10

Reserved Memory

Alignment: 1

Prefetchable Memory

Alignment: 1

PCIE clocks

Clock0 assignment:

[Platform-POR]

[Enabled]

[Disabled]

ClkReq for Clock0:

[Platform-POR]

[Disabled]

Clock1 assignment:

[Platform-POR]

[Enabled]

[Disabled]

ClkReq for Clock1:

[Platform-POR]

[Disabled]

Clock2 assignment:

[Platform-POR]

[Enabled]

[Disabled]

ClkReq for Clock2:

[Platform-POR]

[Disabled]

Clock3 assignment:

[Platform-POR]

[Enabled]

[Disabled]

ClkReq for Clock3:

[Platform-POR]

[Disabled]

Clock4 assignment:

[Platform-POR]

[Enabled]

	[Disabled]
ClkReq for Clock4:	[Platform-POR] [Disabled]
Clock5 assignment:	[Platform-POR] [Enabled] [Disabled]
ClkReq for Clock5:	[Platform-POR] [Disabled]
SATA Configuration	
SATA Configuration	
SATA Controller(s):	[Enabled] [Disabled]
SATA Mode Selection:	AHCI
SATA Ports Multiplier:	[Enabled] [Disabled]
SATA Test Mode:	[Enabled] [Disabled]
Software Feature Mask Configuration	
Software Feature Mask Configuration	
HDD Unlock:	[Disabled] [Enabled]
LED Locate:	[Disabled] [Enabled]
Aggressive LPM Support:	[Disabled] [Enabled]
Serial ATA Port 0	Empty
Software Preserve	unknown
Port 0:	[Disabled] [Enabled]
Hot Plug:	[Disabled]

	[Enabled]
Configured as eSATA External:	Hot Plug supported
	[Disabled]
	[Enabled]
Spin Up Device:	
	[Disabled]
	[Enabled]
SATA Device Type:	
	[Hard Disk Drive]
	[Solid State Drive]
Topology:	
	[Unknown]
	[ISATA]
	[Direct Connect]
	[Flex]
	[M2]
SATA Port 0 DevSlp:	
	[Disabled]
	[Enabled]
SATA Port 0 RxPolarity:	
	[Disabled]
	[Enabled]
DITO Configuration:	
	[Disabled]
	[Enabled]
DITO Value	625
DM Value	15
Serial ATA Port 1 Software Preserve Port 1:	Empty unknown
	[Disabled]
	[Enabled]
Hot Plug:	
	[Disabled]
	[Enabled]
Configured as eSATA External:	Hot Plug supported
	[Disabled]
	[Enabled]

Spin Up Device:	[Disabled] [Enabled]
SATA Device Type:	[Hard Disk Drive] [Solid State Drive]
Topology:	[Unknown] [ISATA] [Direct Connect] [Flex] [M2]
SATA Port 1 DevSlp:	[Disabled] [Enabled]
SATA Port 1 RxPolarity:	[Disabled] [Enabled]
DITO Configuration:	[Disabled] [Enabled]
DITO Value	625
DM Value	15
Serial ATA Port 2 Software Preserve Port 2:	Empty unknown [Disabled] [Enabled]
Hot Plug:	[Disabled] [Enabled]
Configured as eSATA External:	Hot Plug supported [Disabled] [Enabled]
Spin Up Device:	[Disabled] [Enabled]
SATA Device Type:	[Hard Disk Drive] [Solid State Drive]

Topology:	[Unknown] [ISATA] [Direct Connect] [Flex] [M2]
SATA Port 2 DevSlp:	[Disabled] [Enabled]
SATA Port 2 RxPolarity:	[Disabled] [Enabled]
DITO Configuration:	[Disabled] [Enabled]
DITO Value	625
DM Value	15
USB Configuration	
USB Configuration	
XHCI Compliance Mode:	[Disabled] [Enabled]
xDCI Support:	[Disabled] [Enabled]
USB2 PHY Sus Well Power Gating:	[Disabled] [Enabled]
USB3 Link Speed Selection:	[GEN1] [GEN2]
USB PDO Programming:	[Disabled] [Enabled]
USB Overcurrent:	[Disabled] [Enabled]
USB Internal Pullup resistor:	[Disabled] [Enabled]

USB Overcurrent Lock:	[Disabled] [Enabled]
USB Port Disable Override:	[Disabled] [Select Per-Pin]
USB Device/HOST Mode Override:	[Disabled] [Select Per-Pin]
USB UCSI ACPI device:	[Disabled] [Enabled]
SCS Configuration	
eMMC 5.1 Controller:	[Disabled] [Enabled]
eMMC 5.1 HS400 Mode:	[Disabled] [Enabled]
Enable HS400 software tuning:	[Disabled] [Enabled]
Enable HS400 software tuning:	[33 0hm] [40 0hm] [50 0hm]
SDCard 3.0 Controller:	[Disabled] [Enabled]
State After G3:	[S0 State] [S5 State]

3.6 Security Settings

Aptio Setup - AMI					
Main	Advanced	Chipset	Security	Boot	Save & Exit
<p>Password Description</p> <p>If ONLY the Administrator's password is set, then this only limits access to Setup and is only asked for when entering Setup.</p> <p>If ONLY the User's password is set, then this Is a power on password and must be entered to Boot or enter Setup. In Setup the User will Have Administrator rights.</p> <p>The password length must be</p> <p>In the following range:</p> <p>Minimum length 3</p> <p>Maximum length 20</p> <p>Administrator Password</p> <p>User Password</p>				<p>Set Administrator Password</p>	
				<p>→←: Select Screen</p> <p>↑↓ : Select Item</p> <p>Enter: Select</p> <p>+/- : Charge Opt.</p> <p>F1 : General Help</p> <p>F2: Previous Values</p> <p>F3:Optimized Defaults</p> <p>F4:Save and Exit</p> <p>ESC Exit</p>	
Version 2.22.1282. Copyright (C) 2023 AMI					

3.6.1 Administrator Password



3.6.2 User Password



3.7 Boot Settings



Setup Prompt Timeout	[1]
Bootup Numlock State:	[On] [off]
Quiet Boot:	[Disabled] [Enabled]
Fast Boot:	[Disabled] [Enabled]

3.8 Save & Exit Settings



Save Changes and Exit

Save & Exit Setup save Configuration and exit ?

[Yes]

[No]

Discard Changes and Exit

Exit Without Saving Quit without saving?

[Yes]

[No]

Save Changes and Reset

Reset the system after Saving The changes?

[Yes]

[No]

Discard Changes and Reset

Reset system setup without Saving any changes?

[Yes]

[No]

Save Changes

Save Setup done so far to any of the setup options?

[Yes]

[No]

Discard Changes

Discard Changes done so far to any of the setup options?

[Yes]

[No]

Restore Defaults

Restore /Load Defaults values for all the setup options?

[Yes]

[No]

Save as user Defaults

Save the changes done so far as User Defaults?

[Yes]

[No]

Restore user Defaults

Restore the User Defaults to all the setup options?

[Yes]

[No]

Chapter 4

Installation of Drivers

This chapter describes the installation procedures for software and drivers under the windows 10. The software and drivers are included with the motherboard. The contents include **Intel Chipset, Graphics chipset driver, Audio driver, Intel® management engine interface, and LAN driver; the resistive touch driver.** The instructions are as below.

Important Note:

After installing your Windows operating system, you must install first the Intel Chipset Software Installation Utility before proceeding with the installation of drivers.

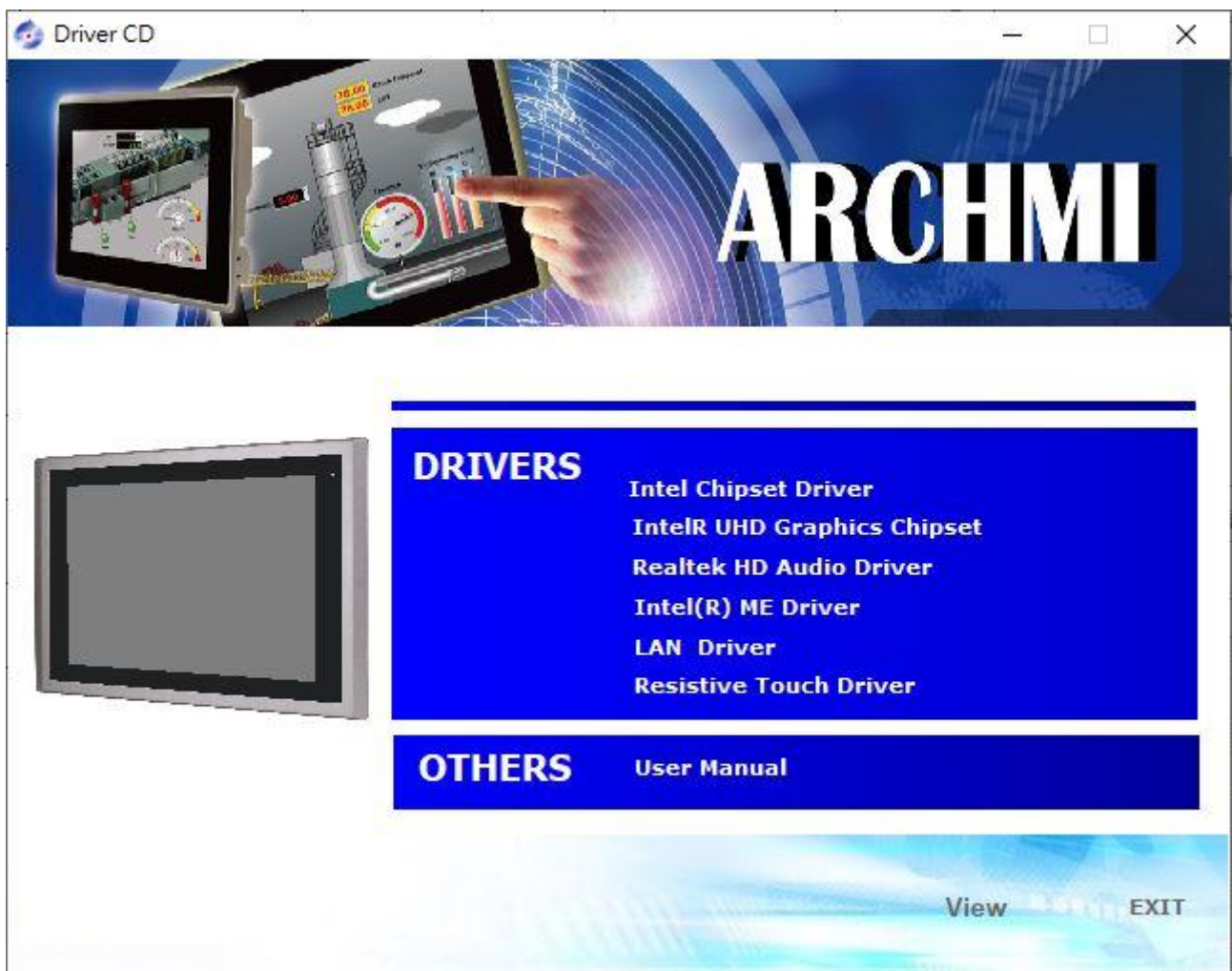

4.1 Intel Chipset

To install the Intel chipset driver, please follow the steps below.

Step 1. Select **Intel Chipset** from the list

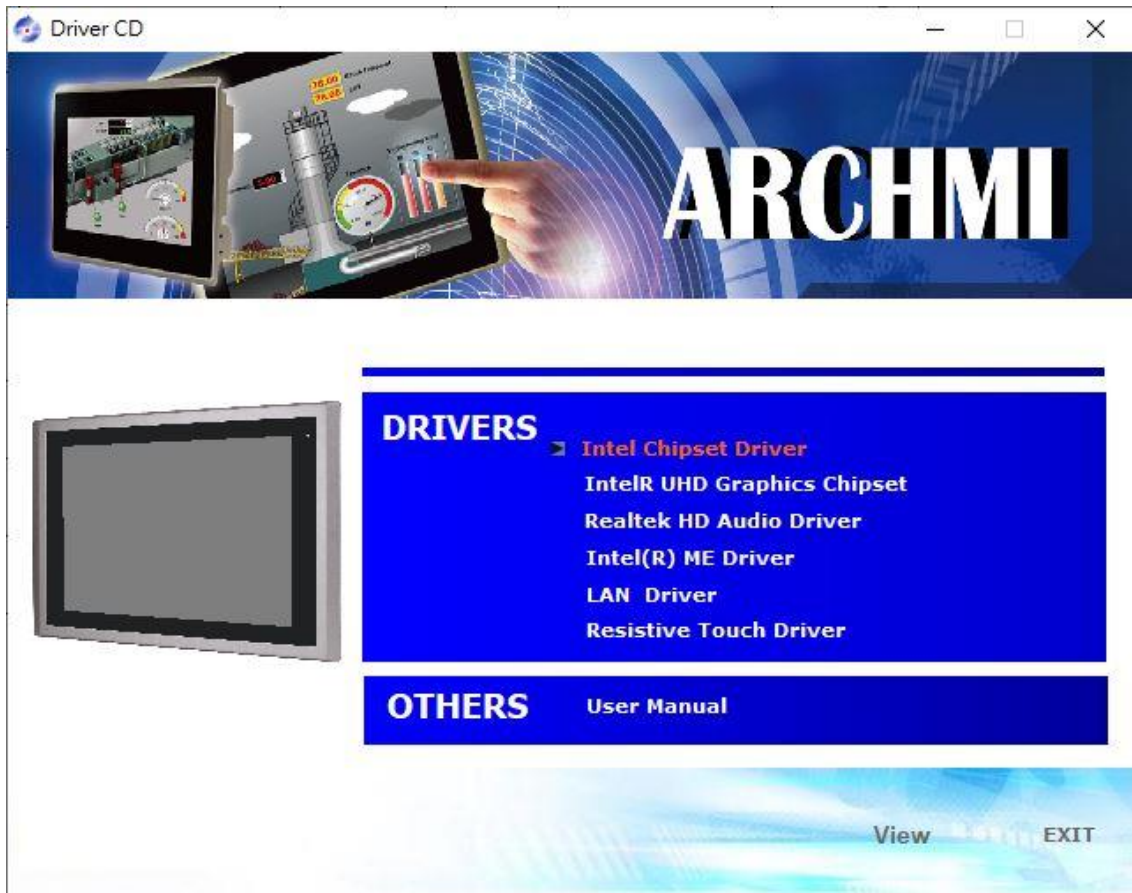

Step 2. Here is welcome page. Please make sure you save and exit all programs before install. Click **Next**.

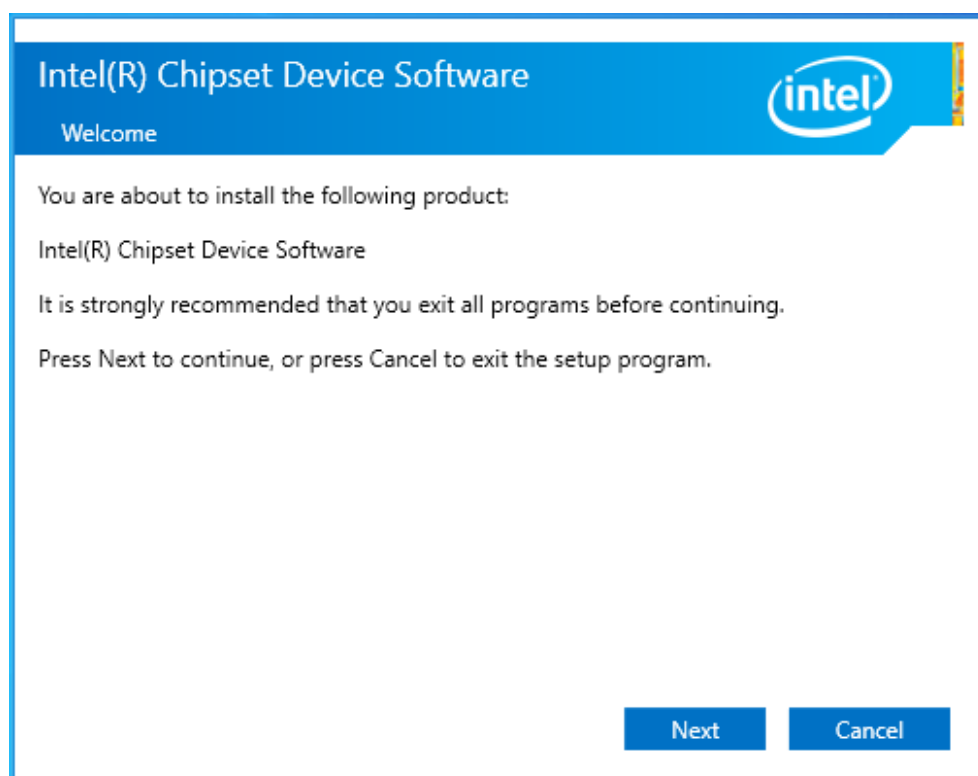

Step 3. Read the license agreement. Click **Accept** to accept all of the terms of the license agreement.



Step 4. Click **Install** to begin the installation.

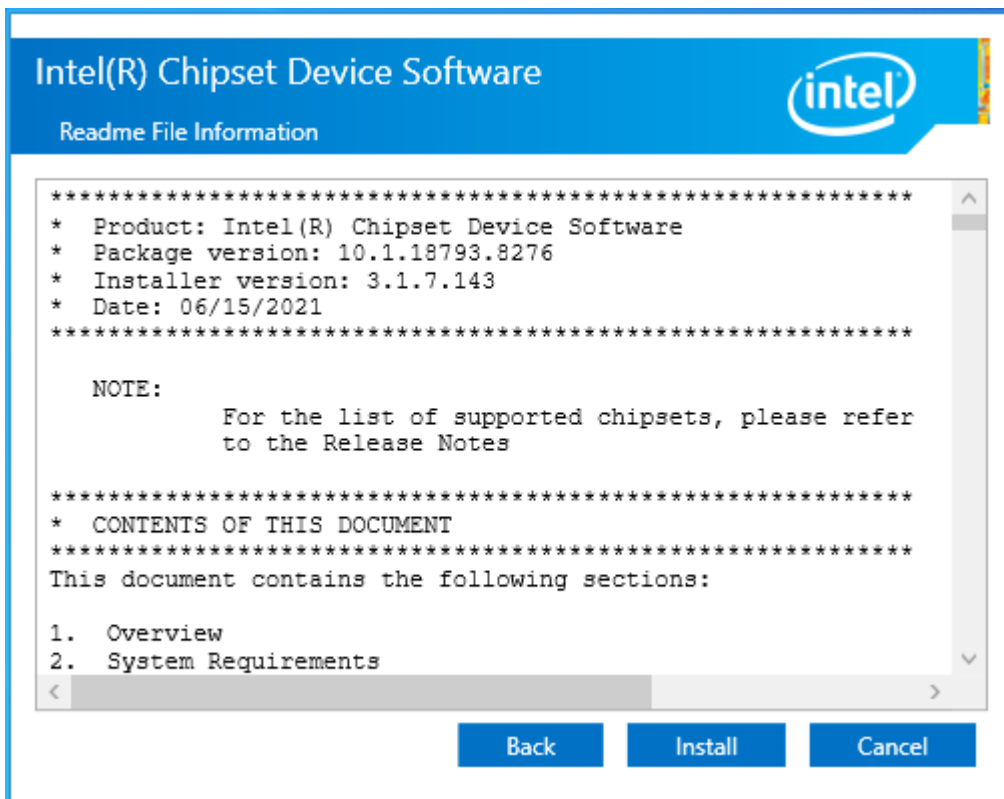

Step 5. Select **Restart Now** to reboot your computer for the changes to take effect.

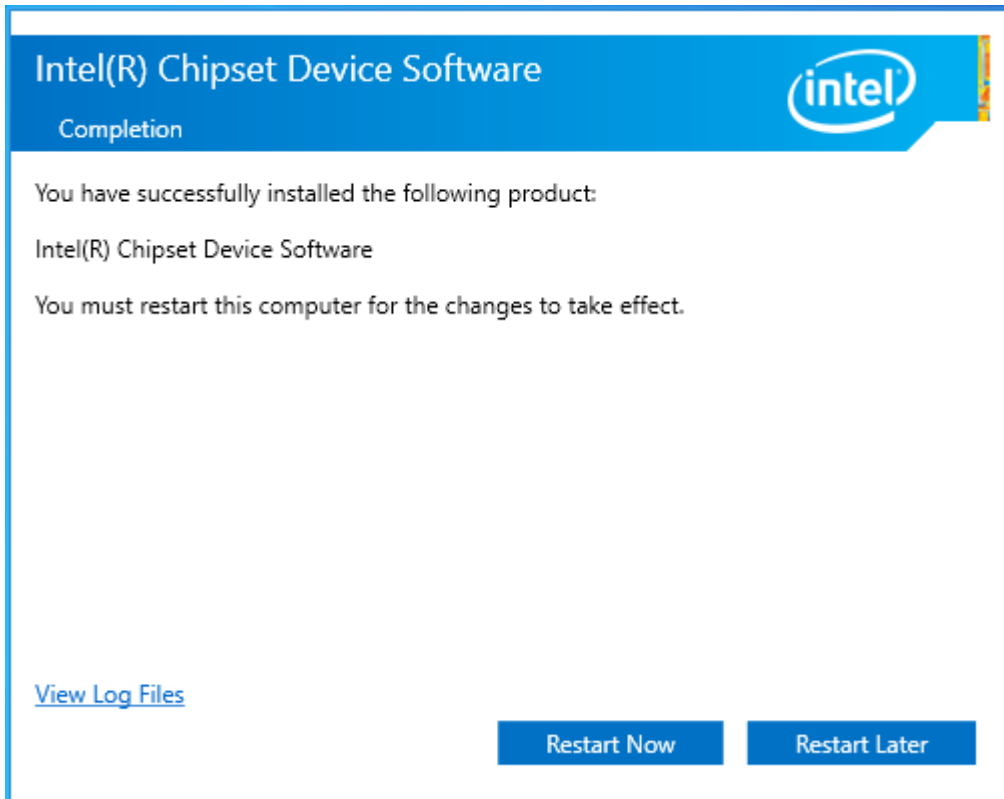

4.2 Intel® HD Graphics Chipset

To install the Intel® HD Graphics Chipset, please follow the steps below.

Step 1. Select Intel® UHD Graphics Chipset from the list.



Step 2. Click Begin installation.



Step 3. Read the license agreement. Click **Yes** to accept all of the terms of the license agreement. And Click **Next** to setup program

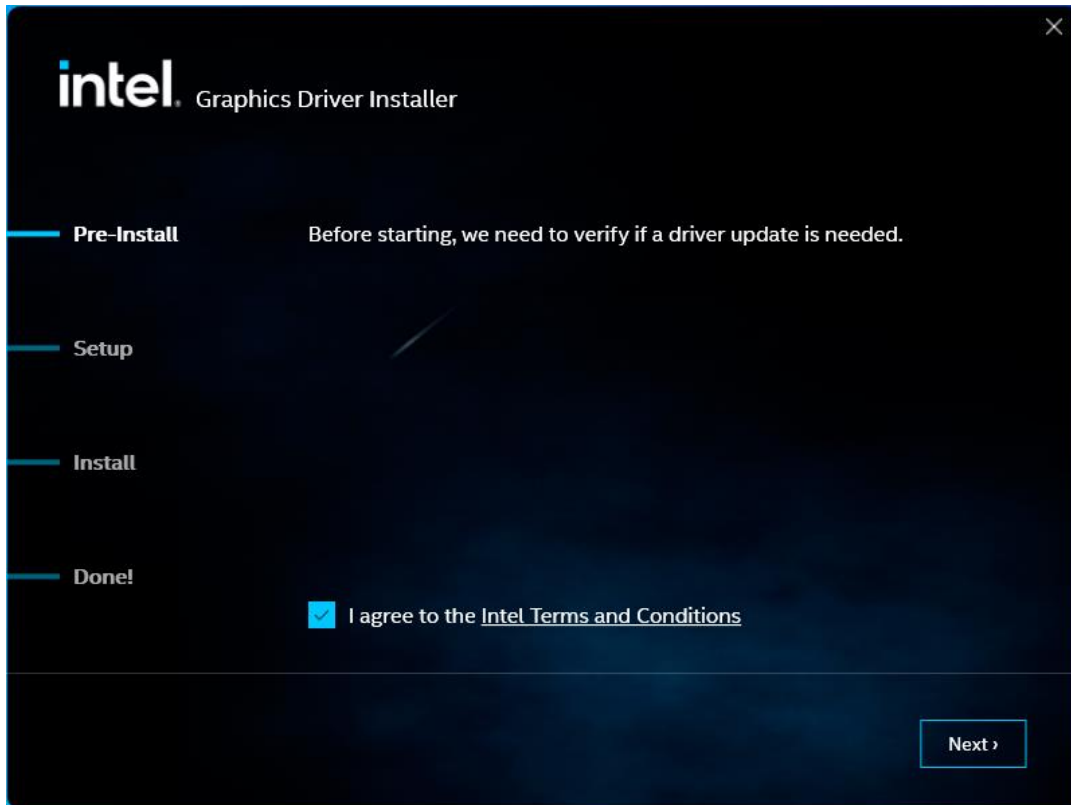

Step 4. Choose **Install** function and Click **Start** to setup program.

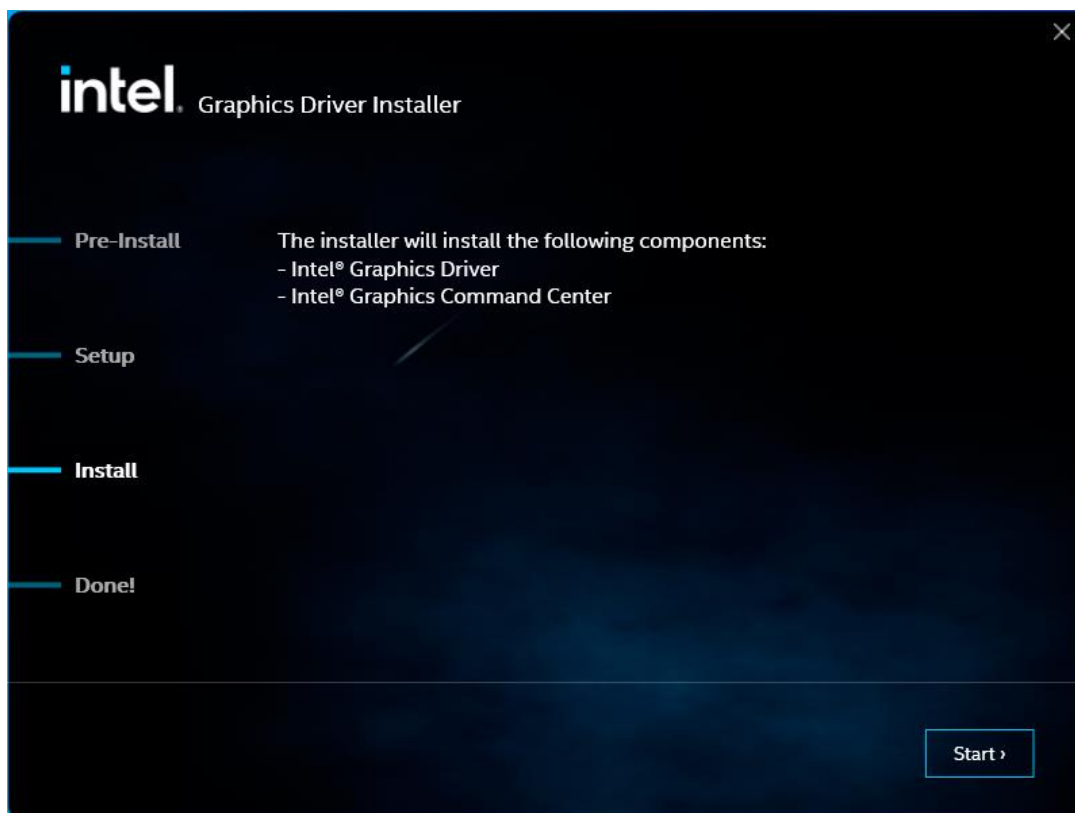

Step 5. Click **Finish** to complete installation.

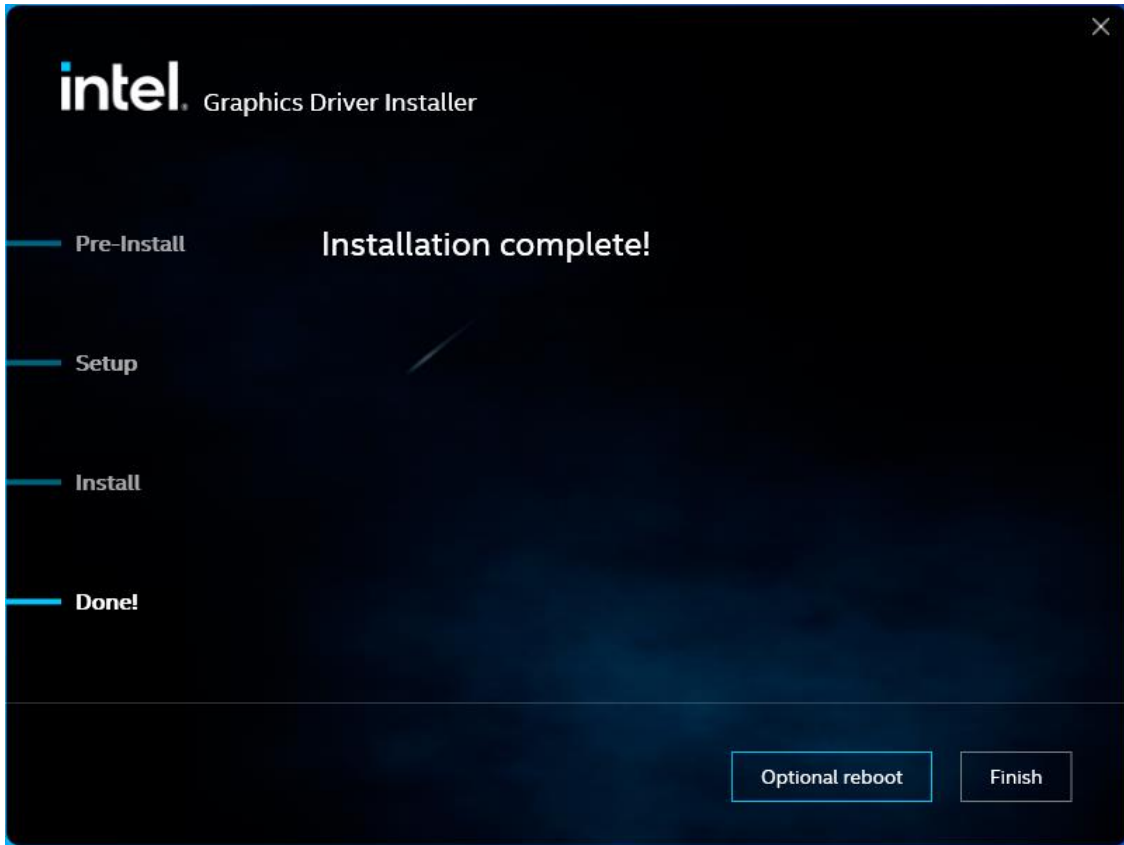

4.3 Realtek HD Audio Driver Installation

To install the Realtek HD Audio Driver, please follow the steps below.

Step 1. Select **Realtek HD Audio Driver** from the list



Step 2. Click **Next** to continue.

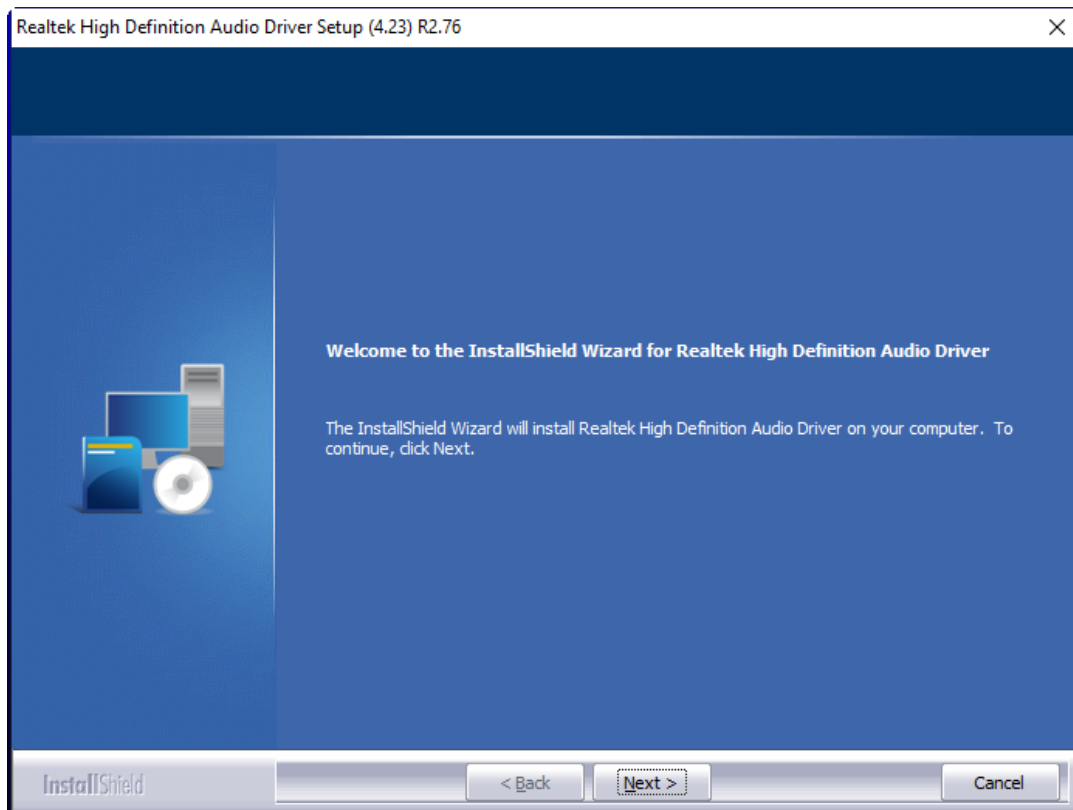

Step 3. Click Yes, I want to restart my computer now. Click **Finish** to complete the installation.

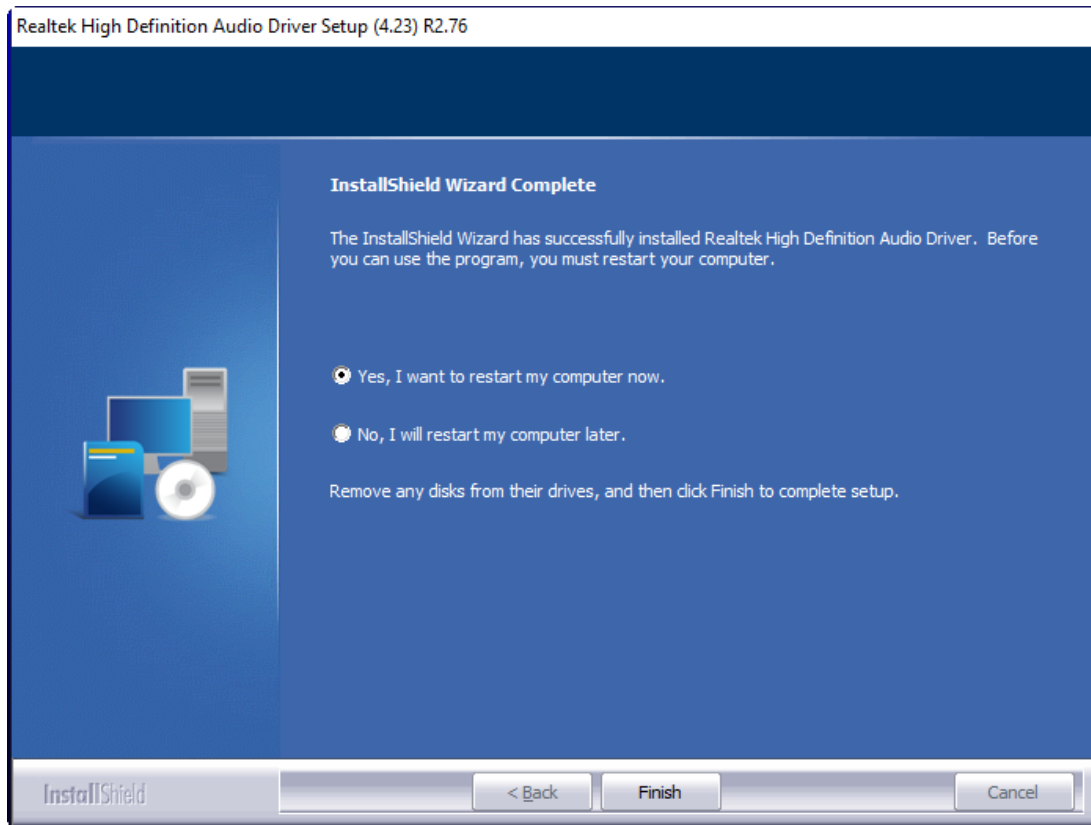

4.4 Intel® Management Engine Interface

To install the Intel® Management Engine Interface, please follow the steps below.

Step 1. Select **Intel® Management Engine Interface** from the list



Step 2. Select setup language you need. Click **Next** to continue.

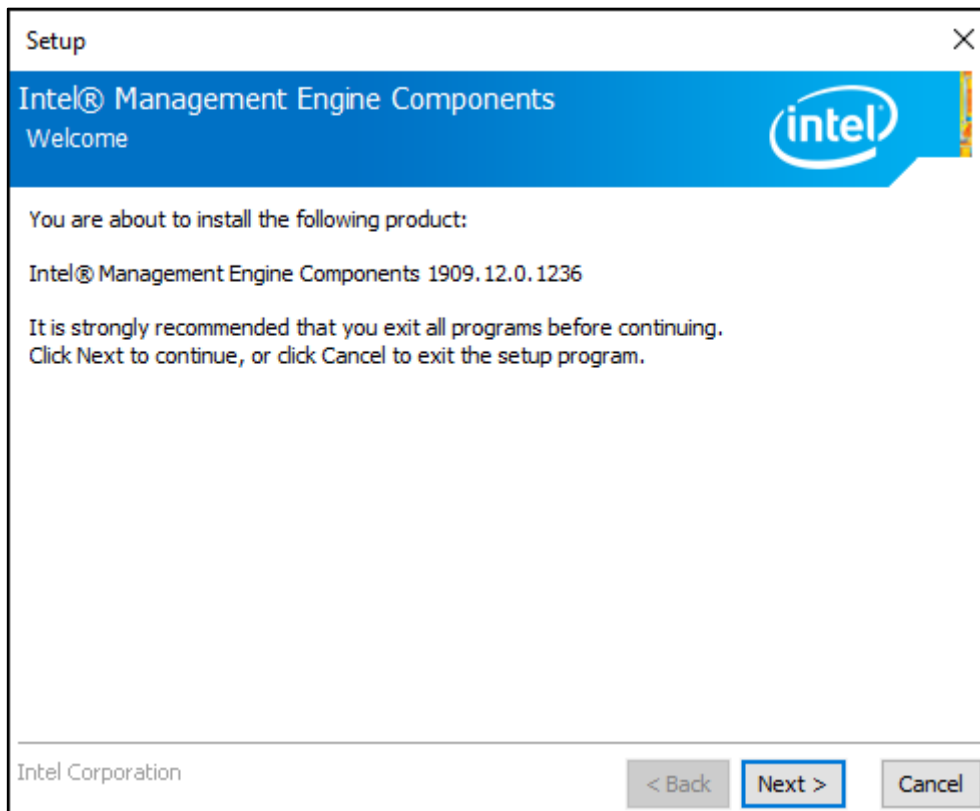

Step 3. Choose **I accept the terms in the License Agreement** and click **Next** to begin the installation.

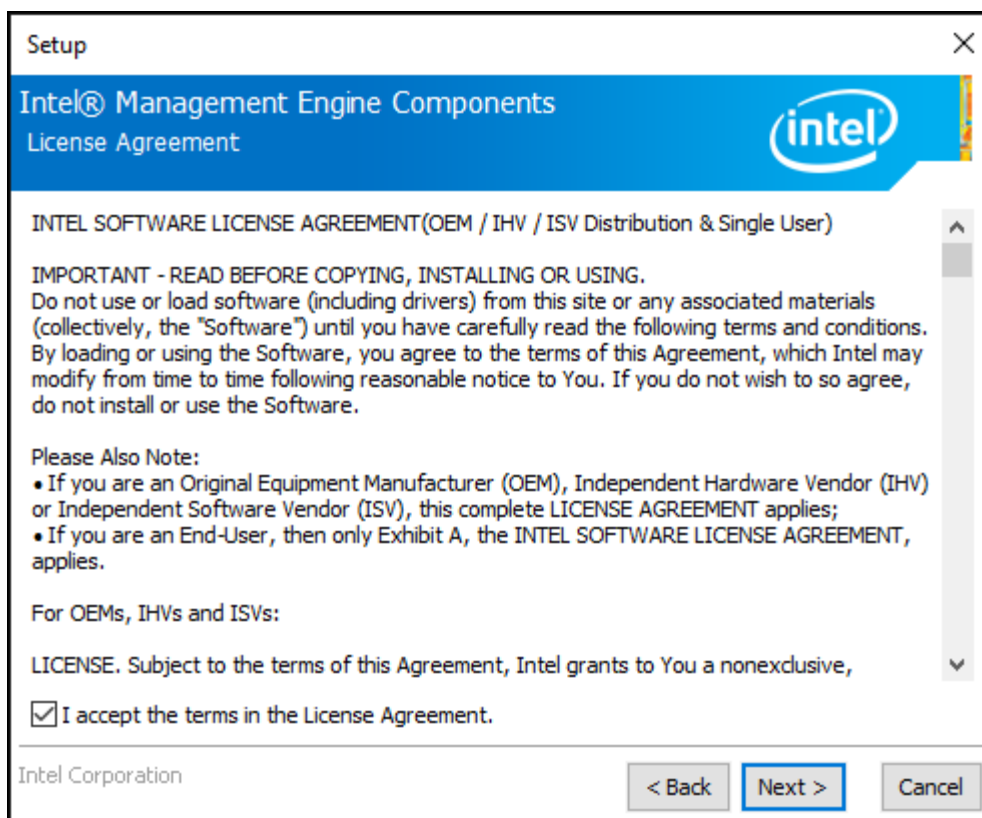

Step 4. Click **Next** to continue.

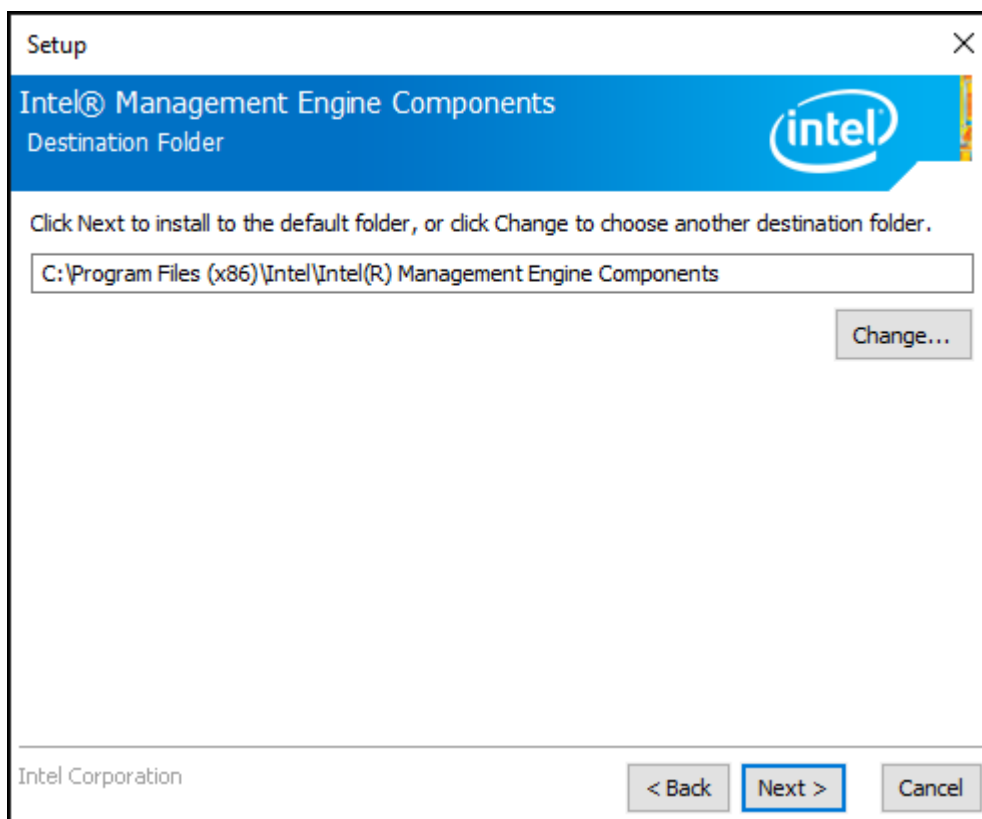

Step 5. Click **Finish** to complete the installation.

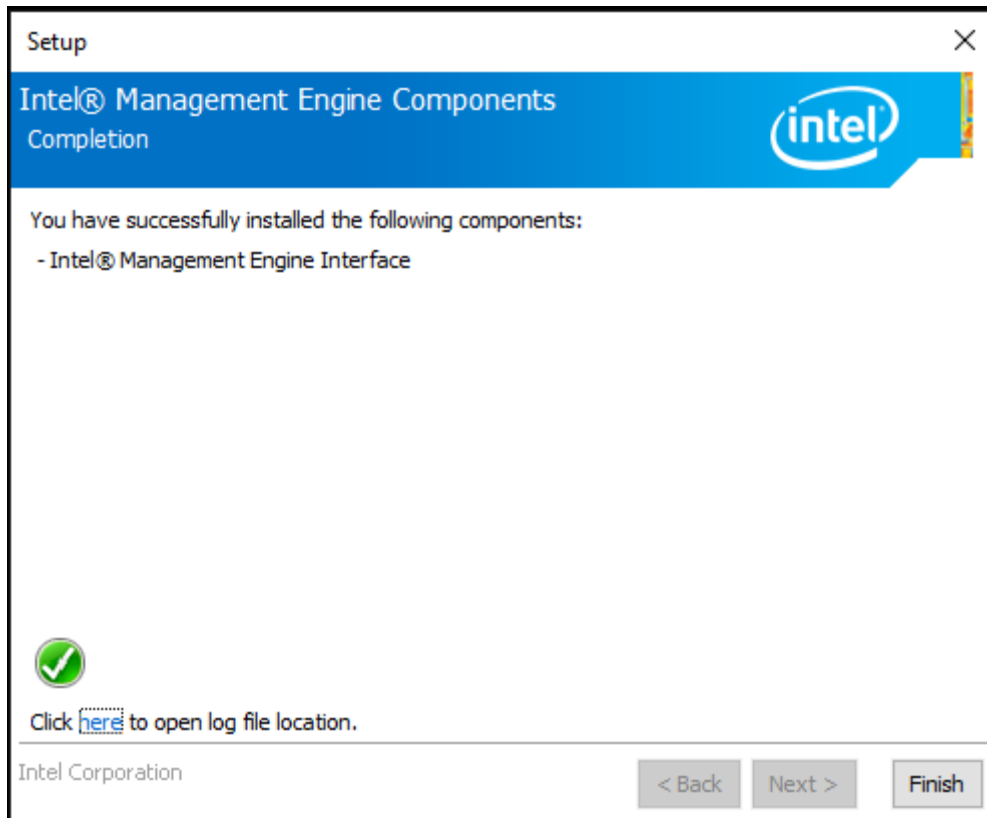

4.5 LAN Driver

To install the LAN driver, please follow the steps below.

Step 1. Select **LAN Driver** from the list

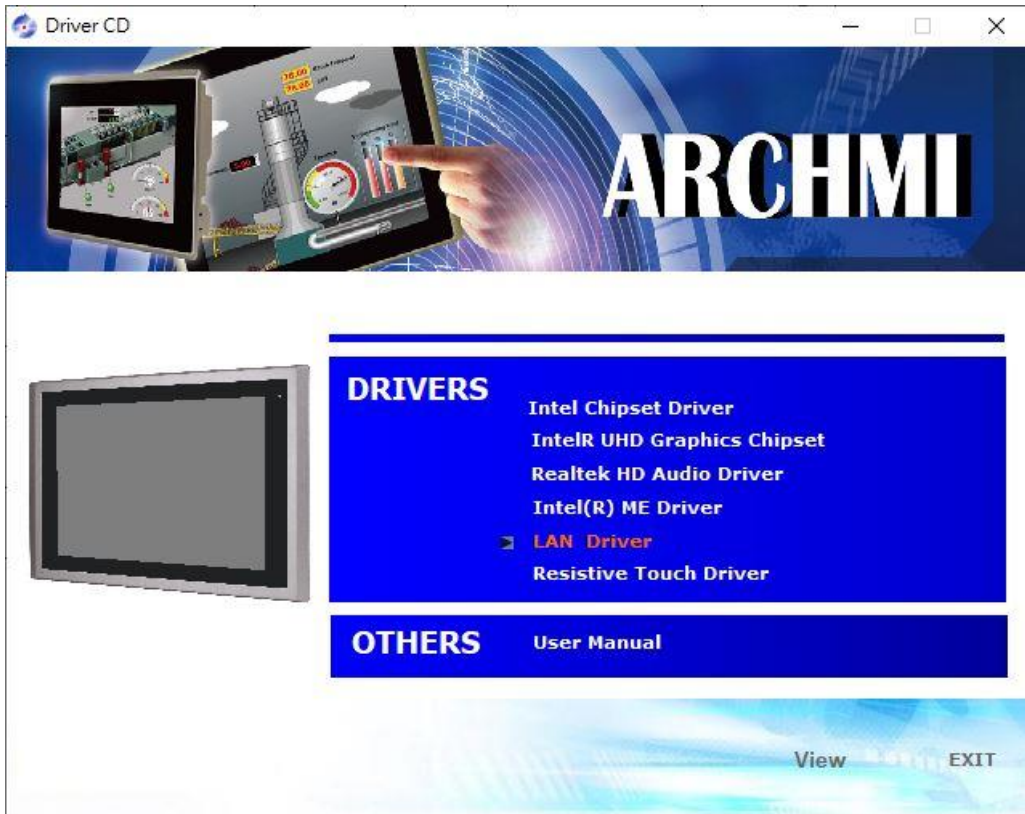

Step 2. Click **Next** to continue.

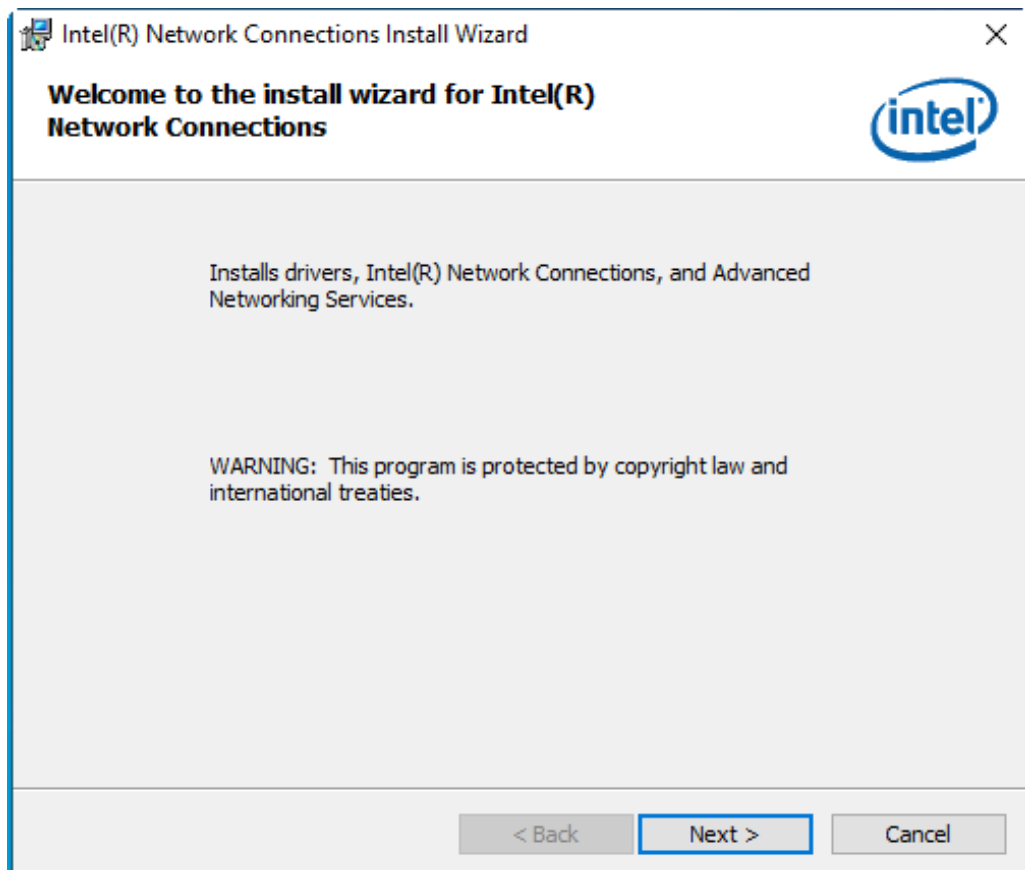

Step 3. Choose **I accept the terms in the License Agreement** and click **Next** to begin the installation.

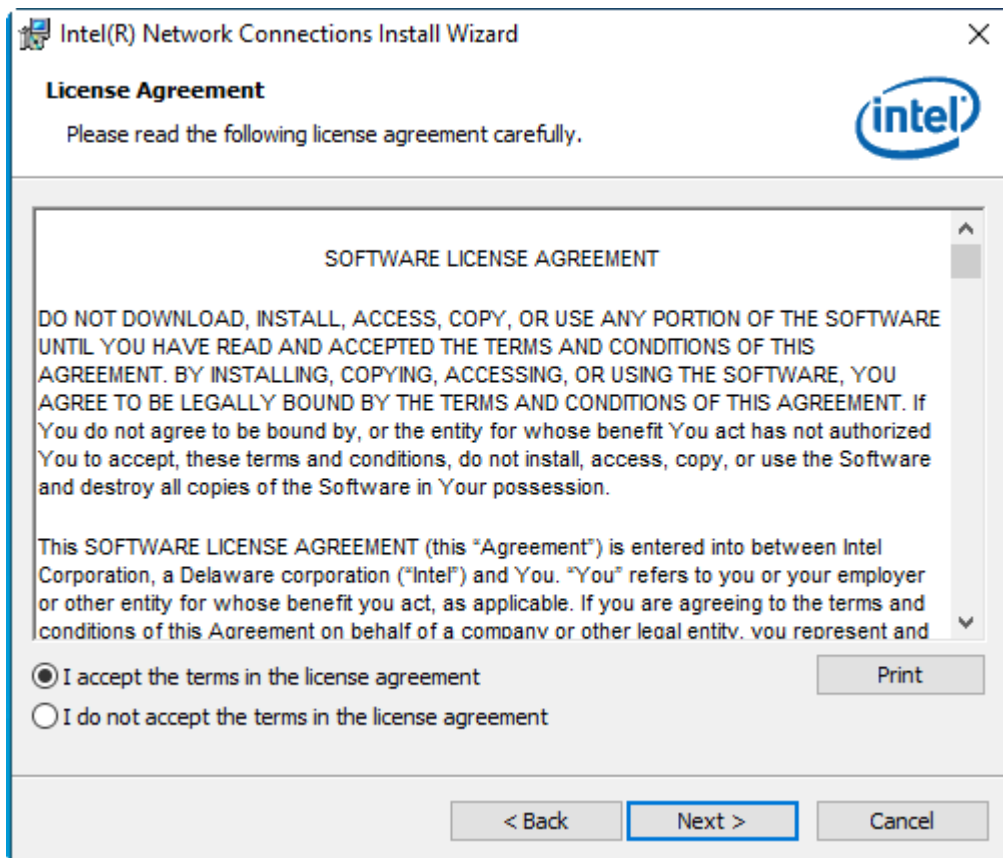

Step 4. Click **Next** to continue.

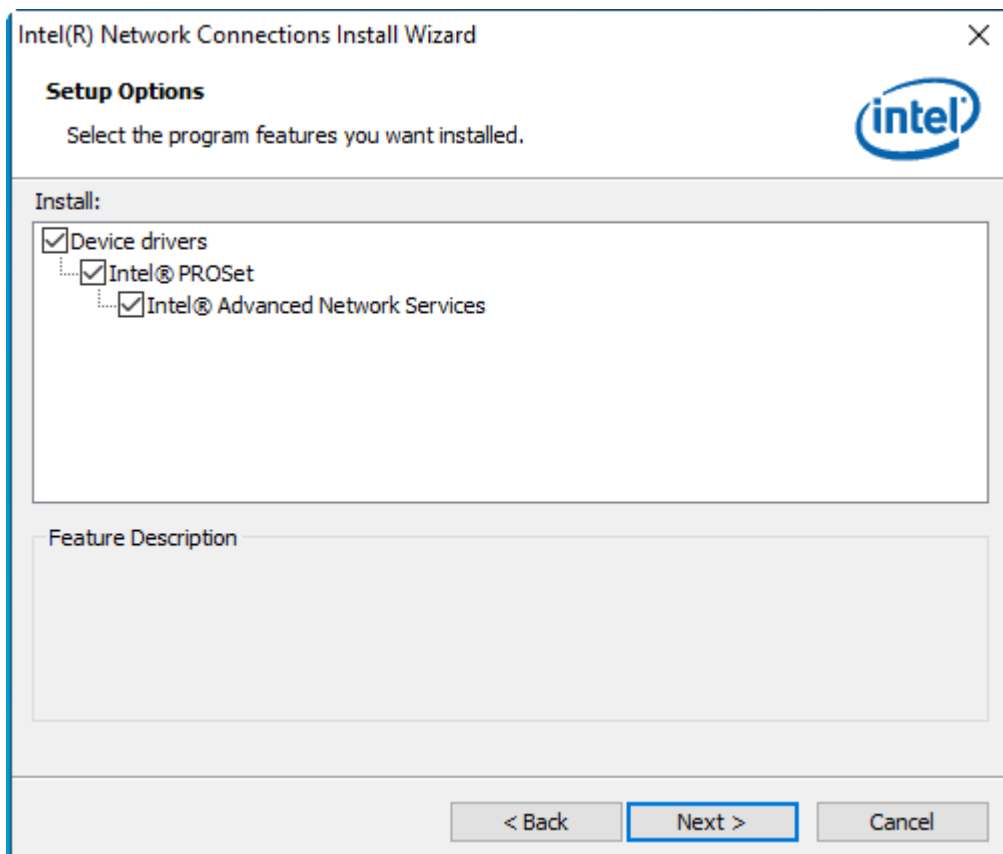

Step 5. Click **Install** to begin the installation.

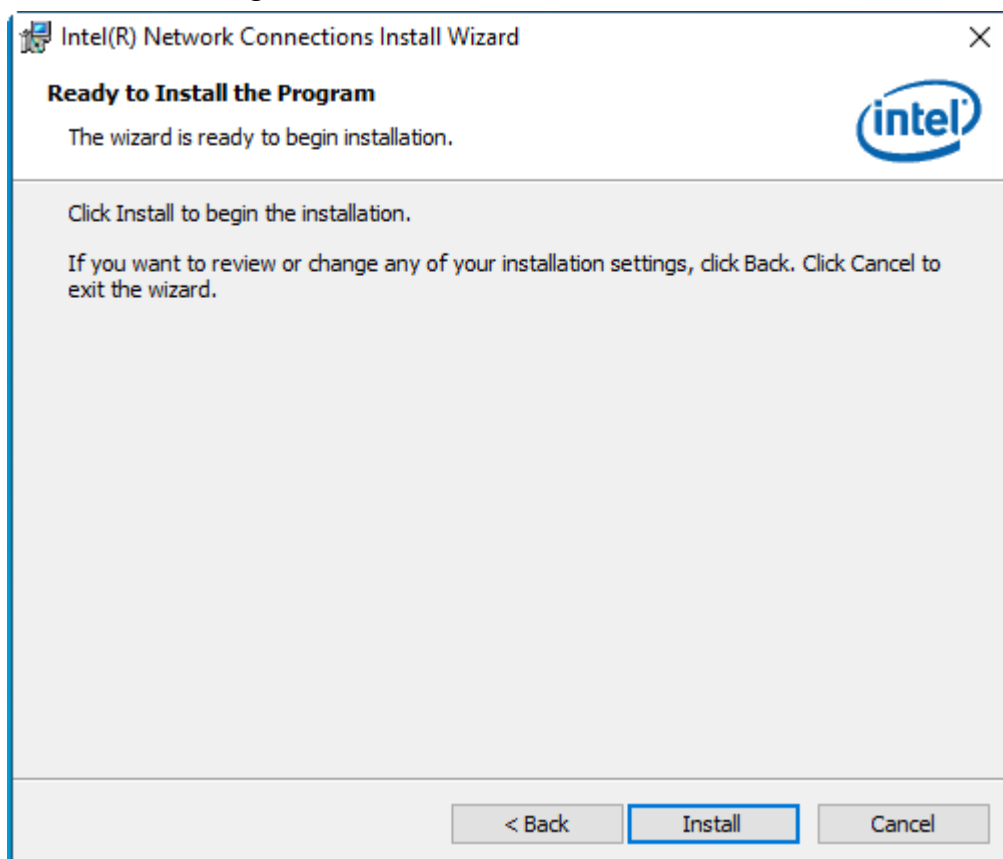

4.6 Touch Screen Installation

This chapter describes how to install drivers and other software that will allow your touch screen work with different operating systems.

4.6.1 Windows 10 Universal Driver Installation for PenMount 6000 Series

Before installing the Windows 10 driver software, you must have the Windows 10 system installed and running on your computer. You must also have one of the following PenMount 6000 series controller or control boards installed: PM6500, PM6300.

Resistive Touch

If you have an older version of the PenMount Windows 7 driver installed in your system, please remove it first. Follow the steps below to install the PenMount DMC6000 driver.

Step 1. Insert the product CD, the screen below would appear. Click **Touch Panel Driver** from the list.



Step 2. Click **Next** to continue.



Step 3. Read the license agreement. Click **I Agree** to agree the license agreement.

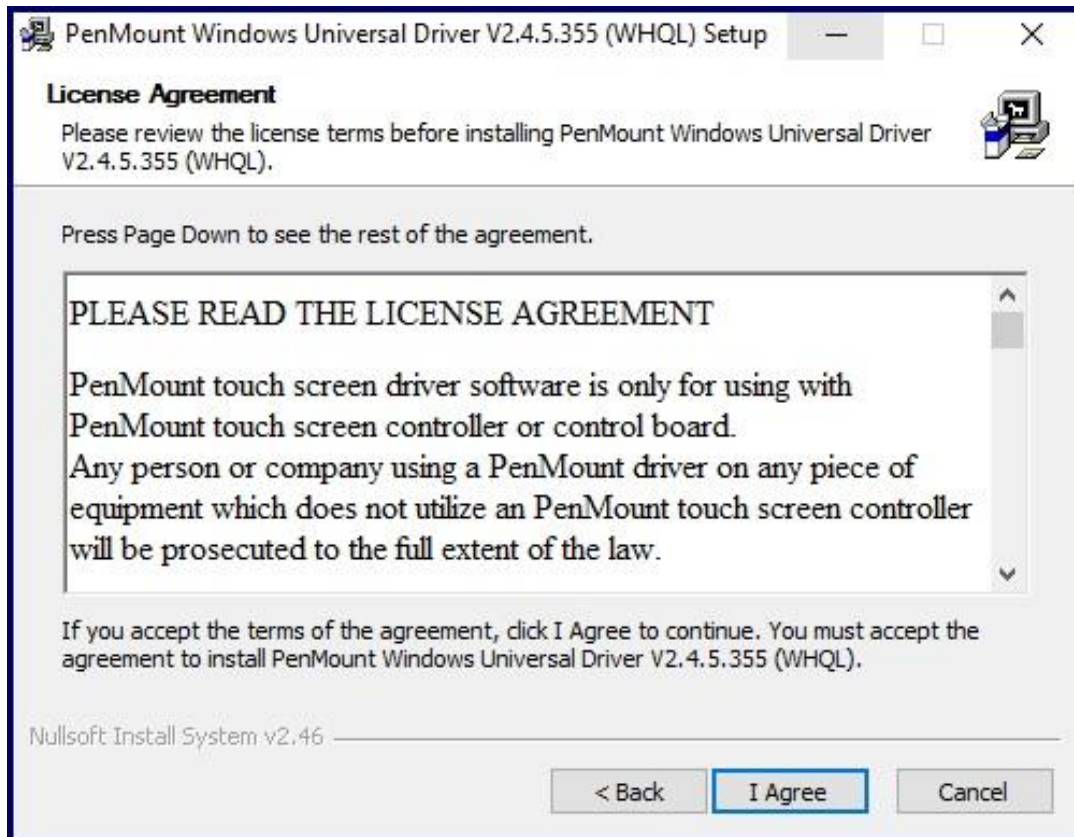

Step 4. Choose the folder in which to install PenMount Windows Universal Driver. Click **Install** to start the installation.

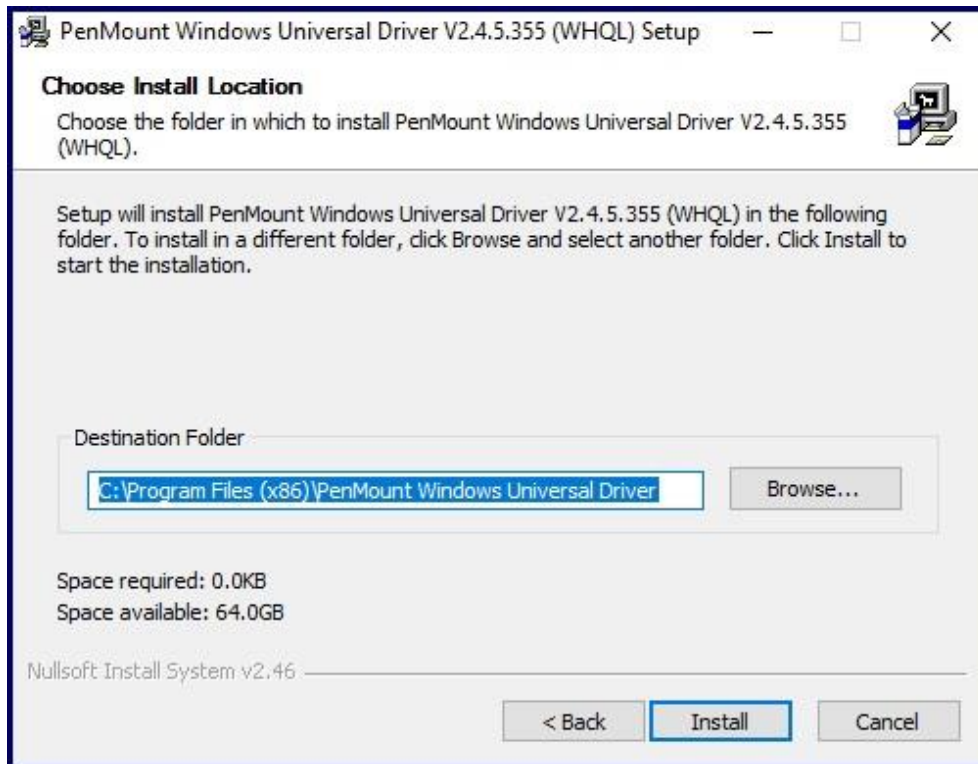

Step 5. Click **Yes** to continue.

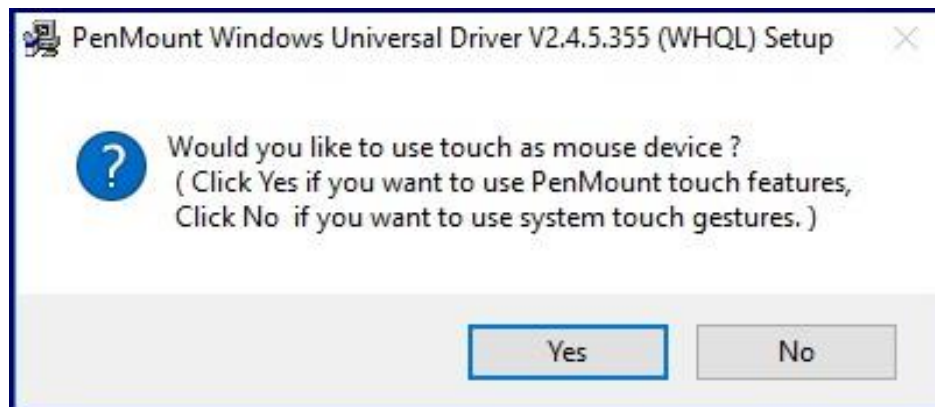

Step 6. Click **Finish** to complete installation.

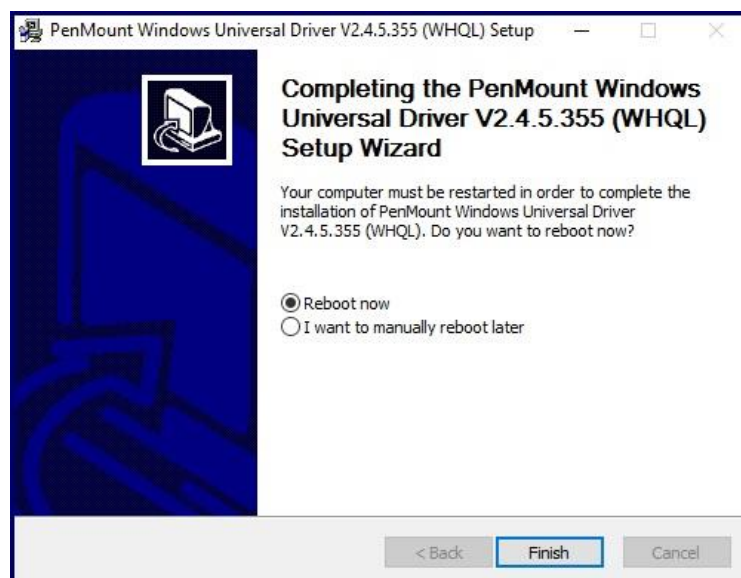

4.6.2 Software Functions

Resistive Touch

Upon rebooting, the computer automatically finds the new 6000 controller board. The touch screen is connected but not calibrated. Follow the procedures below to carry out calibration.

1. After installation, click the PenMount Monitor icon “PM” in the menu bar.
2. When the PenMount Control Panel appears, select a device to “Calibrate.”

PenMount Control Panel (Resistive Touch)

The functions of the PenMount Control Panel are **Device**, **Multiple Monitors**, **Tools** and **About**, which are explained in the following sections.

Device

In this window, you can find out that how many devices be detected on your system.

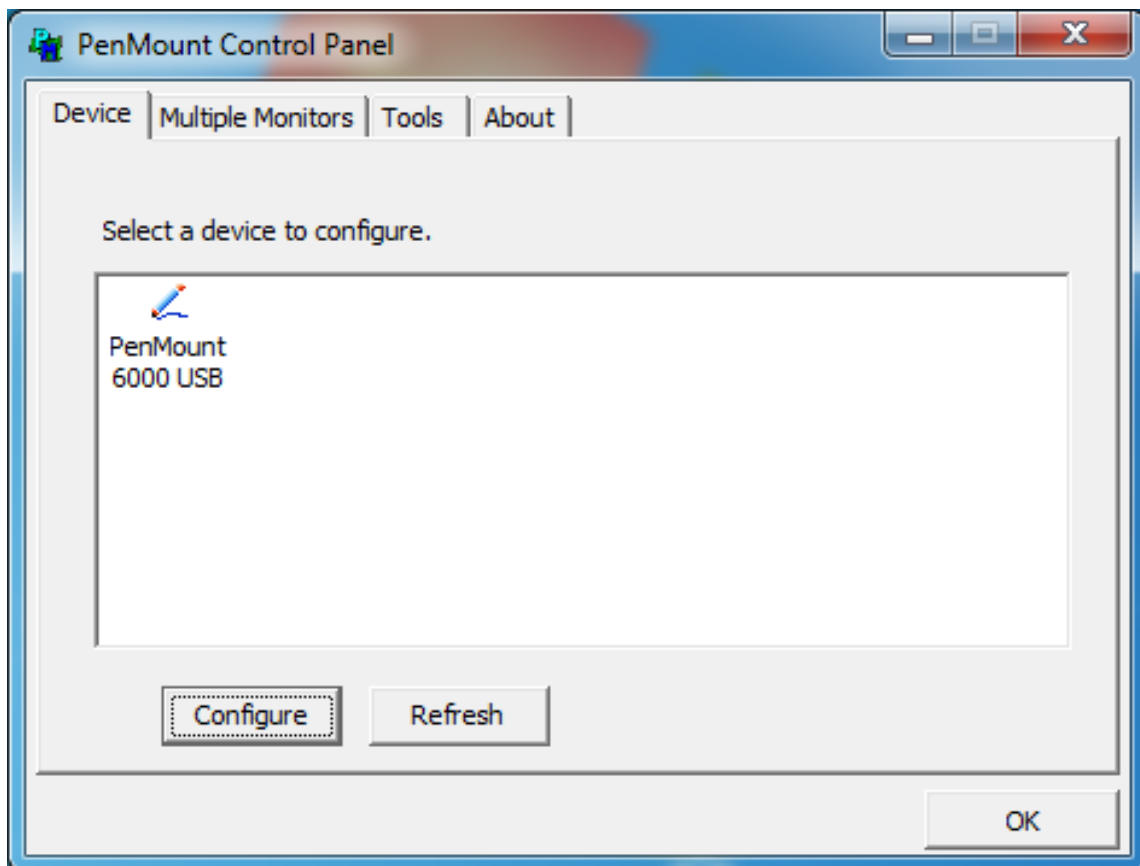

Calibrate

This function offers two ways to calibrate your touch screen. 'Standard Calibration' adjusts most touch screens. 'Advanced Calibration' adjusts aging touch screens.

Standard Calibration	Click this button and arrows appear pointing to red squares. Use your finger or stylus to touch the red squares in sequence. After the fifth red point calibration is complete. To skip, press 'ESC'.
Advanced Calibration	Advanced Calibration uses 4, 9, 16 or 25 points to effectively calibrate touch panel linearity of aged touch screens. Click this button and touch the red squares in sequence with a stylus. To skip, press ESC'.

Step 1. Please select a device then click "Configure". You can also double click the device too.

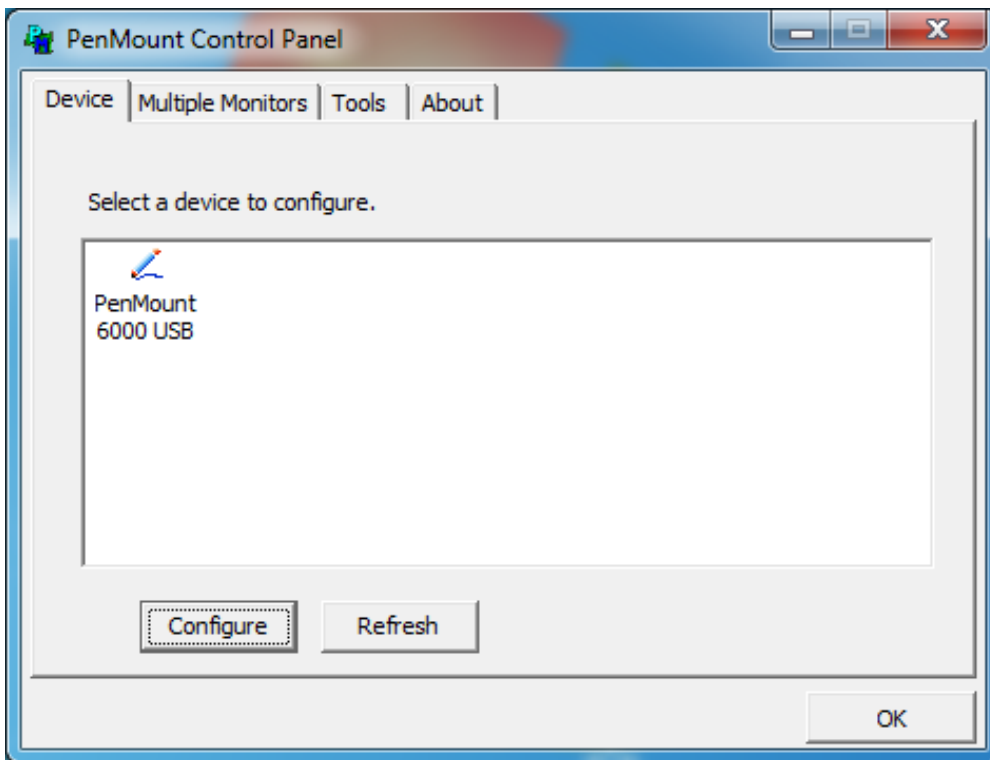

Step 2.Click “Standard Calibration” to start calibration procedure

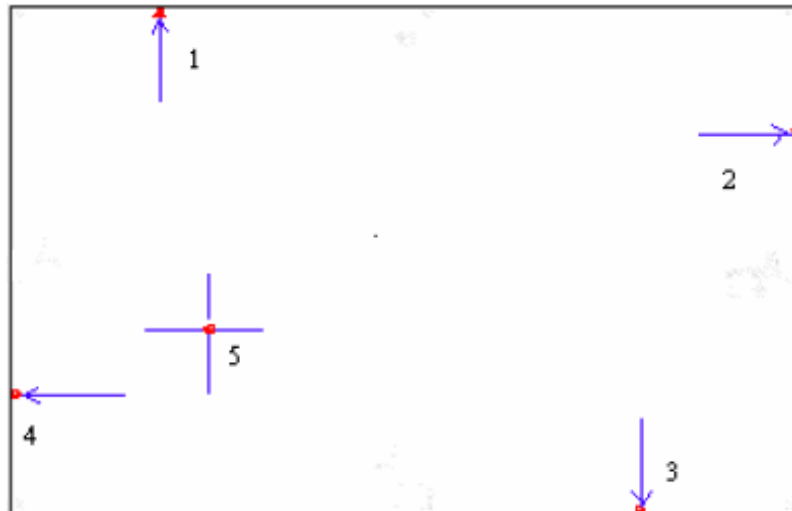
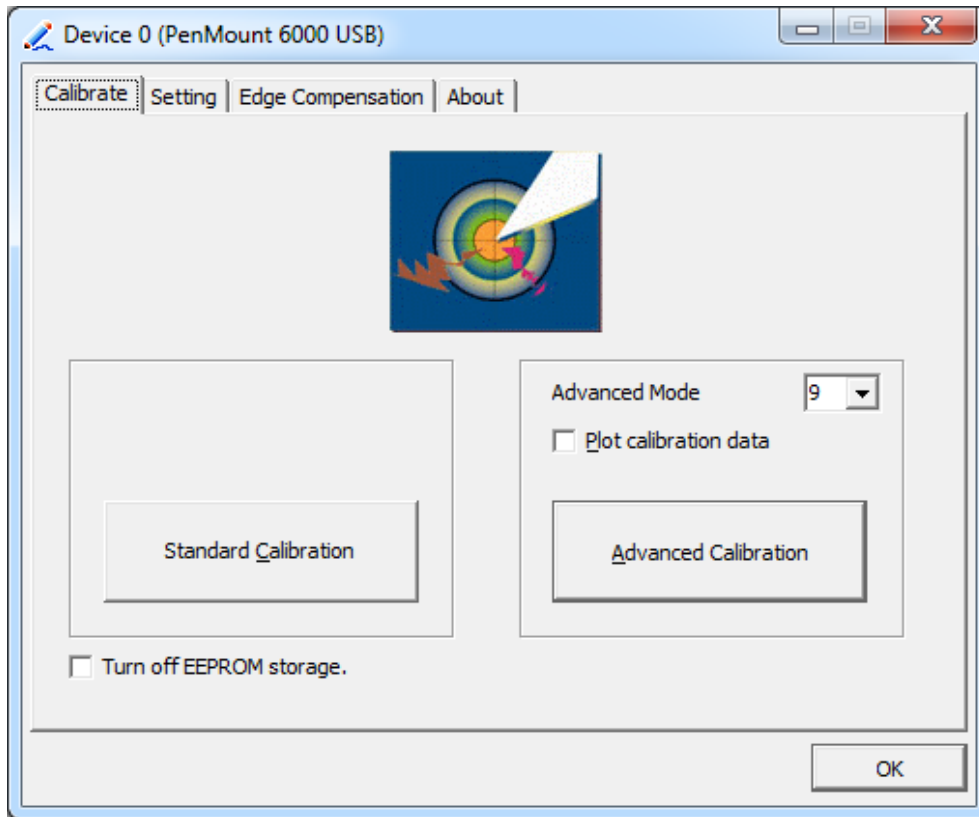

NOTE: The older the touch screen, the more Advanced Mode calibration points you need for an accurate calibration. Use a stylus during Advanced Calibration for greater accuracy. Please follow the step as below:

Step 3. Select **Device** to calibrate, then you can start to do **Advanced Calibration**.

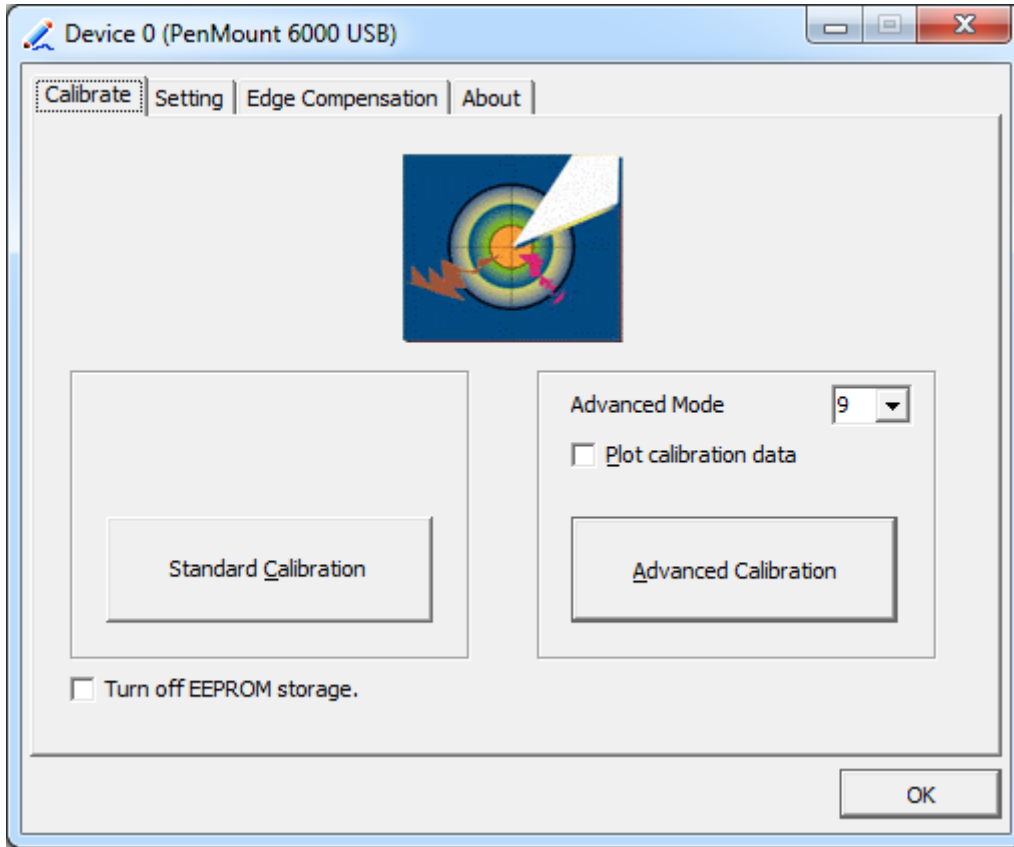

NOTE: Recommend to use a stylus during Advanced Calibration for greater accuracy.



Plot Calibration Data	Check this function and a touch panel linearity comparison graph appears when you have finished Advanced Calibration. The blue lines show linearity before calibration and black lines show linearity after calibration.
Turn off EEPROM storage	The function disable for calibration data to write in Controller. The default setting is Enable.

Setting

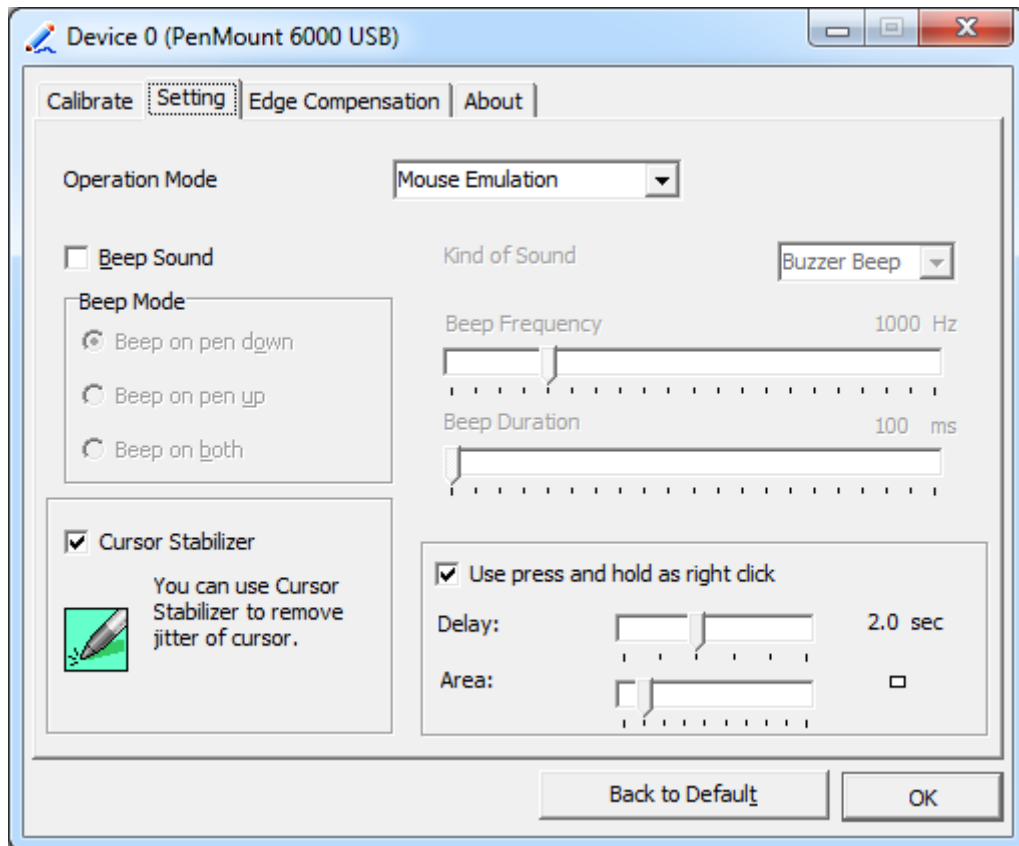

Touch Mode	<p>This mode enables and disables the mouse’s ability to drag on-screen icons – useful for configuring POS terminals.</p> <p>Mouse Emulation – Select this mode and the mouse functions as normal and allows dragging of icons.</p> <p>Click on Touch – Select this mode and mouse only provides a click function, and dragging is disables.</p>
Beep Sound	<p>Enable Beep Sound – turns beep function on and off</p> <p>Beep on Pen Down – beep occurs when pen comes down</p> <p>Beep on Pen Up – beep occurs when pen is lifted up</p> <p>Beep on both – beep occurs when comes down and lifted up</p> <p>Beep Frequency – modifies sound frequency</p> <p>Beep Duration – modifies sound duration</p>
Cursor Stabilizer	<p>Enable the function support to prevent cursor shake.</p>
Use press and hold as right click	<p>You can set the time out and area for you need.</p>

Edge Compensation

You can use Edge Compensation to calibrate more subtly.

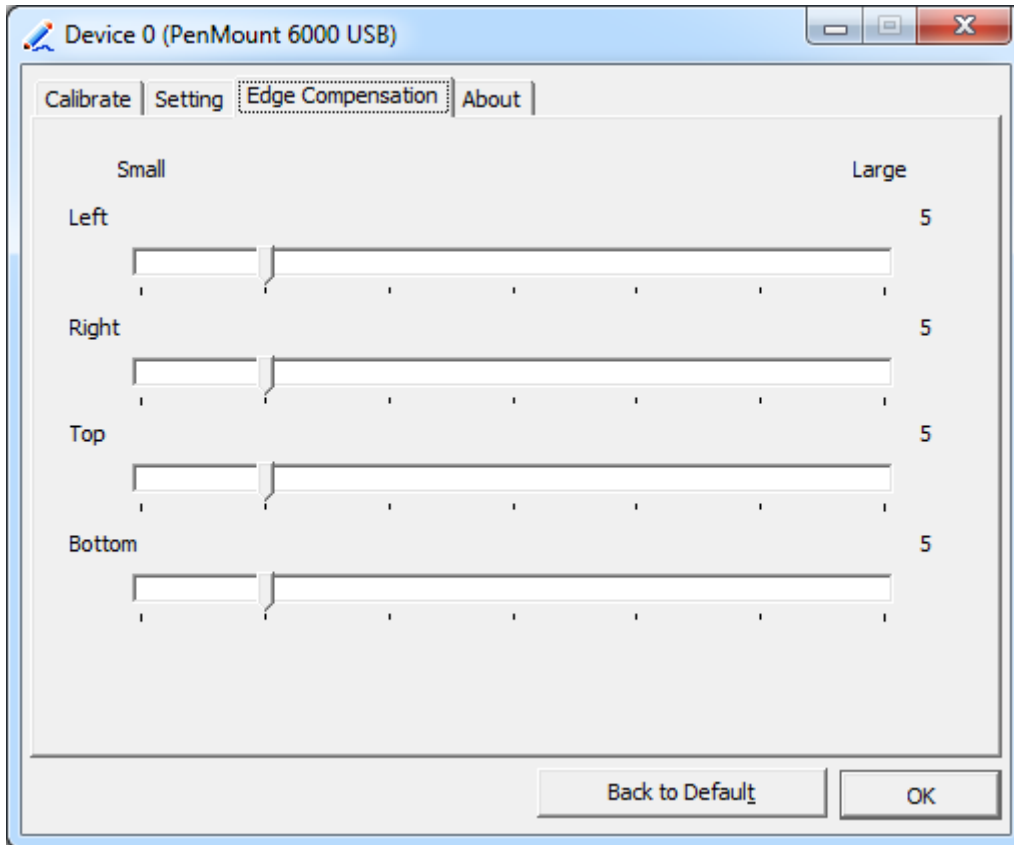

About

This panel displays information about the PenMount controller and driver version.

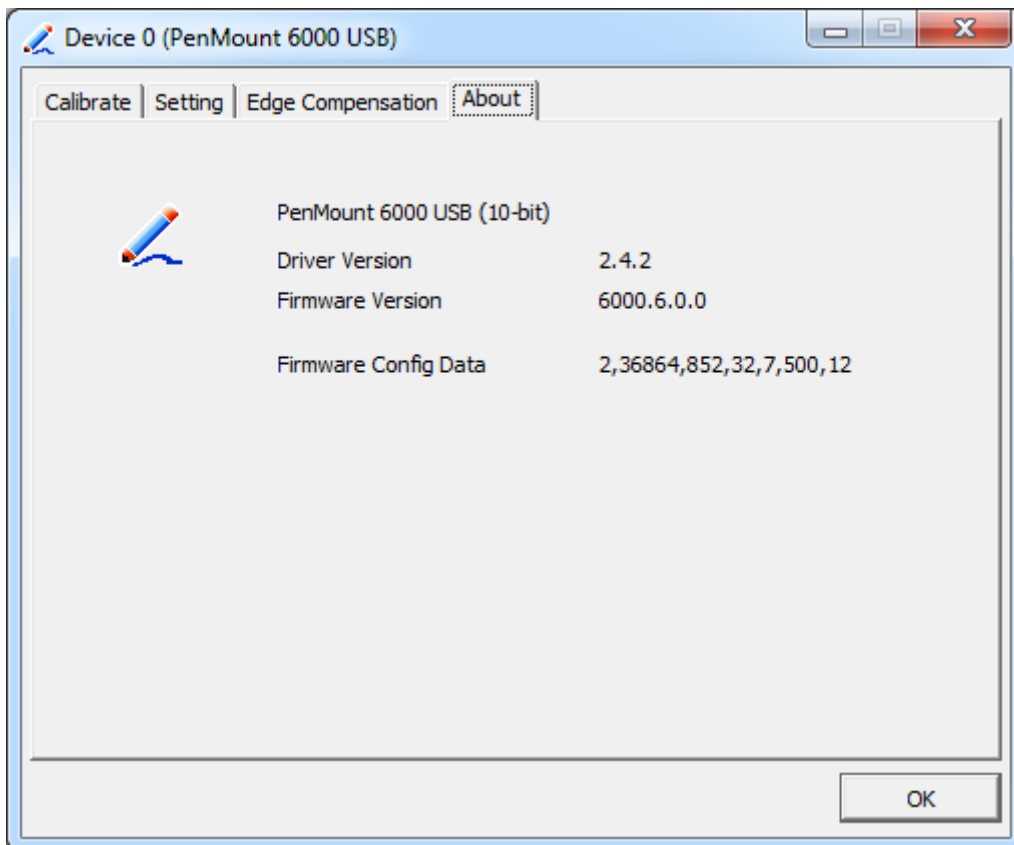

Multiple Monitors

Multiple Monitors support from two to six touch screen displays for one system. The PenMount drivers for Windows 7/8/8.1 support Multiple Monitors. This function supports from two to six touch screen displays for one system. Each monitor requires its own PenMount touch screen control board, either installed inside the display or in a central unit. The PenMount control boards must be connected to the computer COM ports via the USB interface. Driver installation procedures are the same as for a single monitor. Multiple Monitors support the following modes:
Windows Extends Monitor Function
Matrox DualHead Multi-Screen Function
nVidia nView Function

NOTE: The Multiple Monitor function is for use with multiple displays only. Do not use this function if you have only one touch screen display. Please note once you turn on this function the rotating function is disabled.

Enable the multiple display function as follows:

1. Check the **Enable Multiple Monitor Support** box; then click **Map Touch Screens** to assign touch controllers to displays.

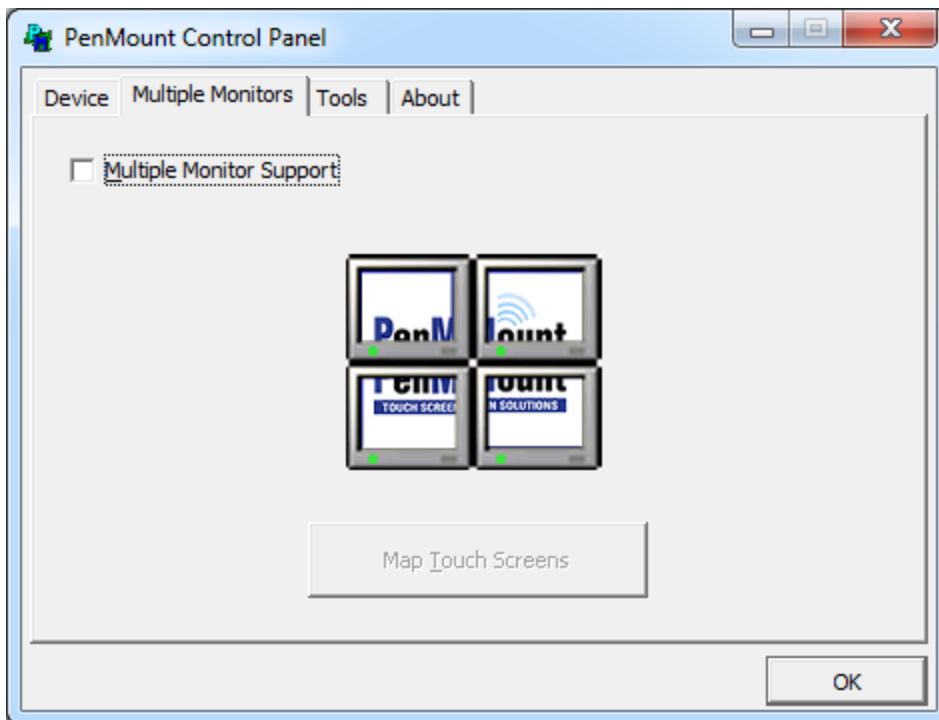

2. When the mapping screen message appears, click **OK**.
3. Touch each screen as it displays "Please touch this monitor". Following this sequence and touching each screen is called **mapping the touch screens**.



4. Touching all screens completes the mapping and the desktop reappears on the monitors.
5. Select a display and execute the "Calibration" function. A message to start calibration appears. Click **OK**.

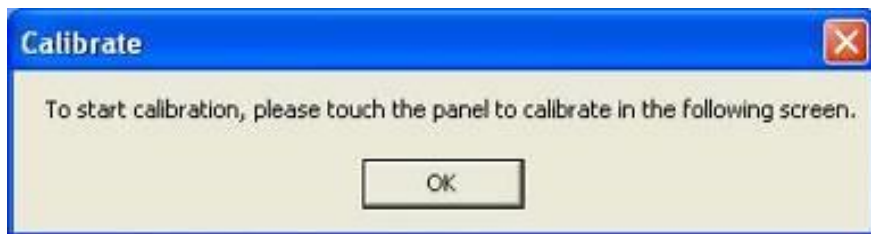

6. "Touch this screen to start its calibration" appears on one of the screens. Touch the screen.
7. "Touch the red square" messages appear. Touch the red squares in sequence.
8. Continue calibration for each monitor by clicking **Standard Calibration** and touching the red squares.

NOTES:

1. If you use a single VGA output for multiple monitors, please do not use the **Multiple Monitor** function. Just follow the regular procedure for calibration on each of your desktop monitors.
2. The Rotating function is disabled if you use the Multiple Monitor function.
3. If you change the resolution of display or screen address, you have to redo **Map Touch Screens**, so the system understands where the displays are.

About

This panel displays information about the PenMount controller and this driver version.

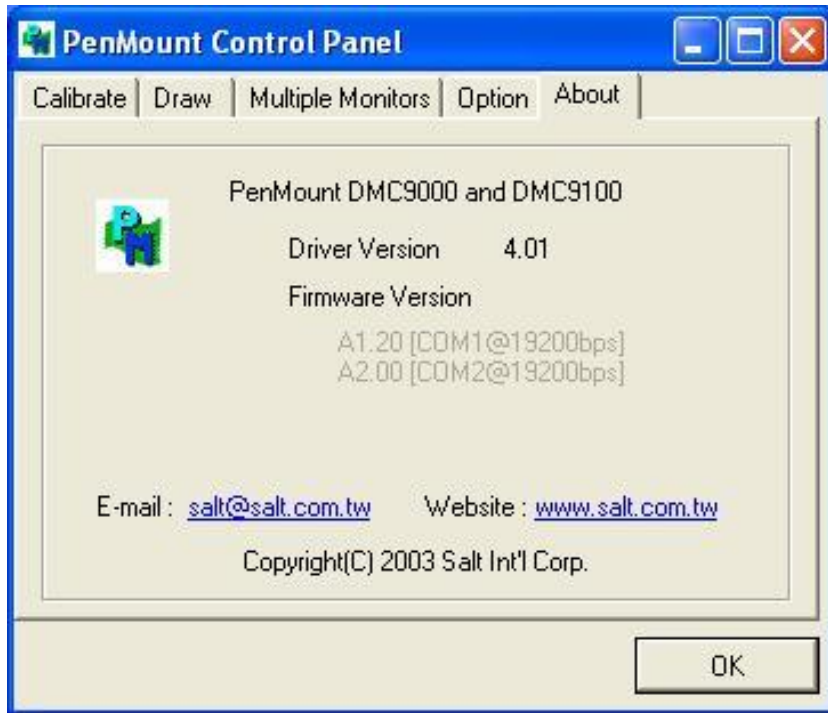

PenMount Monitor Menu Icon

The PenMount monitor icon (PM) appears in the menu bar of Windows 7/8/8.1 system when you turn on PenMount Monitor in PenMount Utilities.



PenMount Monitor has the following function



Control Panel	Open Control Panel Windows
Beep	Setting Beep function for each device
Right Button	When you select this function, a mouse icon appears in the right-bottom of the screen. Click this icon to switch between Right and Left Button functions. 
Exit	Exits the PenMount Monitor function.

Configuring the Rotate Function

1. Install the rotation software package.
2. Choose the rotate function (0°, 90°, 180°, 270°) in the 3rd party software. The calibration screen appears automatically. Touch this point and rotation is mapped.

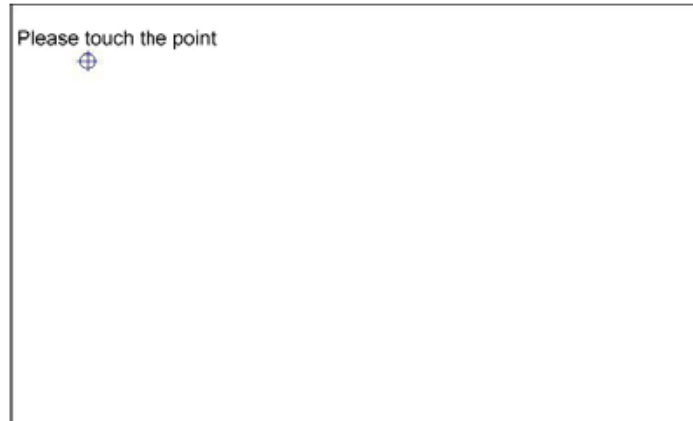

NOTE: The Rotate function is disabled if you use Monitor Mapping