

SATADOM-SH

3IE7 Series

Ultra iSLC

Customer: _____

Customer

Part Number: _____

Innodisk

Part Number: _____

Innodisk

Model Name: _____

Date: _____

Innodisk Approver	Customer Approver

**Total Solution For
Industrial Flash Storage**

Table of contents

- 1. PRODUCT OVERVIEW7**
 - 1.1 INTRODUCTION OF INNO DISK SATADOM-SH 3IE77**
 - 1.2 PRODUCT VIEW AND MODELS7**
 - 1.3 SATA INTERFACE.....7**

- 2. PRODUCT SPECIFICATIONS8**
 - 2.1 CAPACITY AND DEVICE PARAMETERS.....8**
 - 2.2 PERFORMANCE8**
 - 2.3 ELECTRICAL SPECIFICATIONS8**
 - 2.3.1 Power Requirement8**
 - 2.3.2 Power Consumption9**
 - 2.4 ENVIRONMENTAL SPECIFICATIONS9**
 - 2.4.1 Temperature Ranges9**
 - 2.4.2 Humidity.....9**
 - 2.4.3 Shock and Vibration9**
 - 2.4.4 Mean Time between Failures (MTBF)9**
 - 2.5 CE AND FCC COMPATIBILITY10**
 - 2.6 RoHS COMPLIANCE10**
 - 2.7 RELIABILITY10**
 - 2.8 TRANSFER MODE10**
 - 2.9 PIN ASSIGNMENT11**
 - 2.10 MECHANICAL DIMENSIONS.....11**
 - 2.11 ASSEMBLY WEIGHT12**
 - 2.12 SEEK TIME12**
 - 2.13 HOT PLUG.....12**
 - 2.14 NAND FLASH MEMORY.....12**

- 3. THEORY OF OPERATION13**
 - 3.1 OVERVIEW.....13**
 - 3.2 SATA III CONTROLLER13**
 - 3.3 ERROR DETECTION AND CORRECTION.....13**
 - 3.4 WEAR-LEVELING14**
 - 3.5 BAD BLOCKS MANAGEMENT14**
 - 3.6 iDATA GUARD.....14**
 - 3.7 GARBAGE COLLECTION.....14**
 - 3.8 TRIM14**
 - 3.9 iPOWER GUARD.....15**
 - 3.10 DIE RAID15**

- 4. INSTALLATION REQUIREMENTS16**

- 4.1 SATADOM-SH 3IE7 PIN DIRECTIONS..... 16**
- 4.2 ELECTRICAL CONNECTIONS FOR SATADOM-SH 3IE7 16**
- 4.3 DEVICE DRIVE 16**
- 4.4 POWER SUPPLY FOR SATADOM..... 16**
 - 4.4.1 Power Cable 16*
 - 4.4.2 Pin8 and Pin7 VCC..... 17*
- 5. PART NUMBER RULE18**
- 6. APPENDIX19**

REVISION HISTORY

Revision	Description	Date
V1.0	First Released	Feb., 2024

List of Tables

TABLE 1: DEVICE PARAMETERS.....8

TABLE 2: PERFORMANCE8

TABLE 3: INNODISK SATADOM-SH 3IE7 POWER REQUIREMENT.....8

TABLE 4: POWER CONSUMPTION – 112 LAYERS 3D TLC.....9

TABLE 5: TEMPERATURE RANGE FOR SATADOM-SH 3IE79

TABLE 6: SHOCK/VIBRATION TESTING FOR SATADOM-SH 3IE79

TABLE 7: SATADOM-SH 3IE7 MTBF10

TABLE 8: SATADOM-SH 3IE7 TBW10

TABLE 9: INNODISK SATADOM-SH 3IE7 PIN ASSIGNMENT11

List of Figures

FIGURE 1: INNODISK SATADOM-SH 3IE7 7

FIGURE 2: INNODISK SATADOM-SH 3IE7 MECHANICAL DIAGRAM..... 11

FIGURE 3: INNODISK SATADOM-SH 3IE7 BLOCK DIAGRAM..... 13

FIGURE 4: SIGNAL SEGMENT AND POWER SEGMENT..... 16

FIGURE 5: STANDARD POWER CABLE 16

FIGURE 6: PIN 8 / PIN 7 HOST DESIGN IN REFERENCE CIRCUIT 17

1. Product Overview

1.1 Introduction of InnoDisk SATADOM-SH 3IE7

Innodisk SATADOM-SH 3IE7 is characterized by L³ architecture with the latest SATA III (6.0GHz) Marvell NAND controller. Innodisk's exclusive L³ architecture is L² architecture multiplied LDPC (Low Density Parity Check). L² (Long Life) architecture is a 4K mapping algorithm that reduces WAF and features a real-time wear leveling algorithm to provide high performance and prolong lifespan with exceptional reliability. Innodisk SATADOM-SH 3IE7 is designed for industrial field, and supports several standard features, including TRIM, NCQ, and S.M.A.R.T. In addition, Innodisk's exclusive industrial-oriented firmware provides a flexible customization service, making it perfect for a variety of industrial applications.

CAUTION *TRIM must be enabled.*

TRIM enables SSD's controller to skip invalid data instead of moving. It can free up significant amount of resources, extends the lifespan of SSD by reducing erase, and write cycles on the SSD. Innodisk's handling of garbage collection along with TRIM command improves write performance on SSDs.

1.2 Product View and Models

Innodisk SATADOM-SH 3IE7 is available in follow capacities within 3D TLC flash ICs.

[SATADOM-SH 3IE7 20GB](#)

[SATADOM-SH 3IE7 40GB](#)

[SATADOM-SH 3IE7 80GB](#)

[SATADOM-SH 3IE7 160GB](#)



Figure 1: Innodisk SATADOM-SH 3IE7

1.3 SATA Interface

Innodisk SATADOM-SH 3IE7 supports SATA III interface, and compliant with SATA I and SATA II.

2. Product Specifications

2.1 Capacity and Device Parameters

SATADOM-SH 3IE7 device parameters are shown in Table 1.

Table 1: Device parameters

Capacity	Cylinders	Heads	Sectors	LBA	User Capacity(MB)
20GB	16383	16	63	39091248	19088
40GB	16383	16	63	78161328	38165
80GB	16383	16	63	156301488	76319
160GB	16383	16	63	312581808	152627

2.2 Performance

Burst Transfer Rate: 6.0Gbps

Table 2: Performance

Capacity	Unit	20GB	40GB	80GB	160GB
Sequential* Read (Q32T1)	MB/s	270	440	550	490
Sequential* Write (Q32T1)		160	290	480	460
4KB Random** Read (Q32T1)	IOPS	24,000	43,000	80,000	83,000
4KB Random** Write (Q32T1)		39,000	60,000	75,000	75,000

Note: * Sequential performance is based on CrystalDiskMark 6.0.2 with file size 1000MB

** Random performance is based on IO meter with Queue Depth 32

2.3 Electrical Specifications

2.3.1 Power Requirement

Table 3: Innodisk SATADOM-SH 3IE7 Power Requirement

Item	Symbol	Rating	Unit
Input voltage	V _{IN}	+5 DC +- 5%	V

2.3.2 Power Consumption

Table 4: Power Consumption – 112 Layers 3D TLC

Mode	Power Consumption (W)
Read	1.4
Write	1.5
Idle	0.8
Pin 7/ Pin8 VCC Initial*	3

Target: 160GB SATADOM-SH 3IE7

***To design in Pin7/8 VCC on motherboard, 5V with 1A power supply is requested.**

2.4 Environmental Specifications

2.4.1 Temperature Ranges

Table 5: Temperature range for SATADOM-SH 3IE7

Temperature	Range
Operating	Standard Grade: 0°C to +70°C
	Industrial Grade: -40°C to +85°C
Storage	-55°C to +95°C

2.4.2 Humidity

Relative Humidity: 10-95%, non-condensing

2.4.3 Shock and Vibration

Table 6: Shock/Vibration Testing for SATADOM-SH 3IE7

Reliability	Test Conditions	Reference Standards
Vibration	7 Hz to 2K Hz, 20G, 3 axes	IEC 68-2-6
Mechanical Shock	Duration: 0.5ms, 1500 G, 3 axes	IEC 68-2-27

2.4.4 Mean Time between Failures (MTBF)

Table 7 summarizes the MTBF prediction results for various SATADOM-SH 3IE7 configurations. The analysis was performed using a RAM Commander™ failure rate prediction.

- **Failure Rate:** The total number of failures within an item population, divided by the total number of life units expended by that population, during a particular measurement interval under stated condition.
-
- **Mean Time between Failures (MTBF):** A basic measure of reliability for repairable items: The mean number of life units during which all parts of the item perform within their specified limits, during a particular measurement interval under stated conditions.

Table 7: SATADOM-SH 3IE7 MTBF

Product	Condition	MTBF (Hours)
Innodisk SATADOM-SH 3IE7	Telcordia SR-332 GB, 25°C	>3,000,000

2.5 CE and FCC Compatibility

SATADOM-SH 3IE7 conforms to CE and FCC requirements.

2.6 RoHS Compliance

SATADOM-SH 3IE7 is fully compliant with RoHS directive.

2.7 Reliability

Table 8: SATADOM-SH 3IE7 TBW

Parameter		Value
Read Cycles		Unlimited Read Cycles
Flash endurance		100,000 P/E cycles
Wear-Leveling Algorithm		Support
Bad Blocks Management		Support
Error Correct Code		Support
TBW* (Total Bytes Written) Unit: TB		
Capacity	Sequential workload	Client workload
20GB	1775	533
40GB	3551	1066
80GB	7102	2132
160GB	14204	4264
<p>* Note:</p> <ol style="list-style-type: none"> 1. Sequential: Mainly sequential write, tested by Vdbench. 2. Client: Follow JESD218 Test method and JESD219A Workload, tested by ULINK. (The capacity lower than 64GB client workload is not specified in JEDEC219A, the values are estimated.) 3. Based on out-of-box performance. 		

2.8 Transfer Mode

SATADOM-SH 3IE7 support following transfer mode:

Serial ATA I 1.5Gbps

Serial ATA II 3.0Gbps

Serial ATA III 6.0Gbps

2.9 Pin Assignment

Innodisk SATADOM-SH 3IE7 uses a standard SATA pin-out. See Table 8 for SATADOM-SH 3IE7 pin assignment.

Table 9: Innodisk SATADOM-SH 3IE7 Pin Assignment

Name	Type	Description
Pin 0	GND	Shielding
Pin 1	GND	Shielding
Pin 2	A+	Differential signal to A
Pin 3	A-	Differential signal to A-
Pin 4	GND	Shielding
Pin 5	B-	Differential signal to B-
Pin 6	B+	Differential signal to B
Pin 7	GND/ Vcc*	Shielding/ +5V Power*
Pin 8	VCC	+5V Power

* SATADOM-SH 3IE7 default power supply through pin 8 or extra power cable.

Pin 7 power supply as an optional function with separated PN end of B.

2.10 Mechanical Dimensions

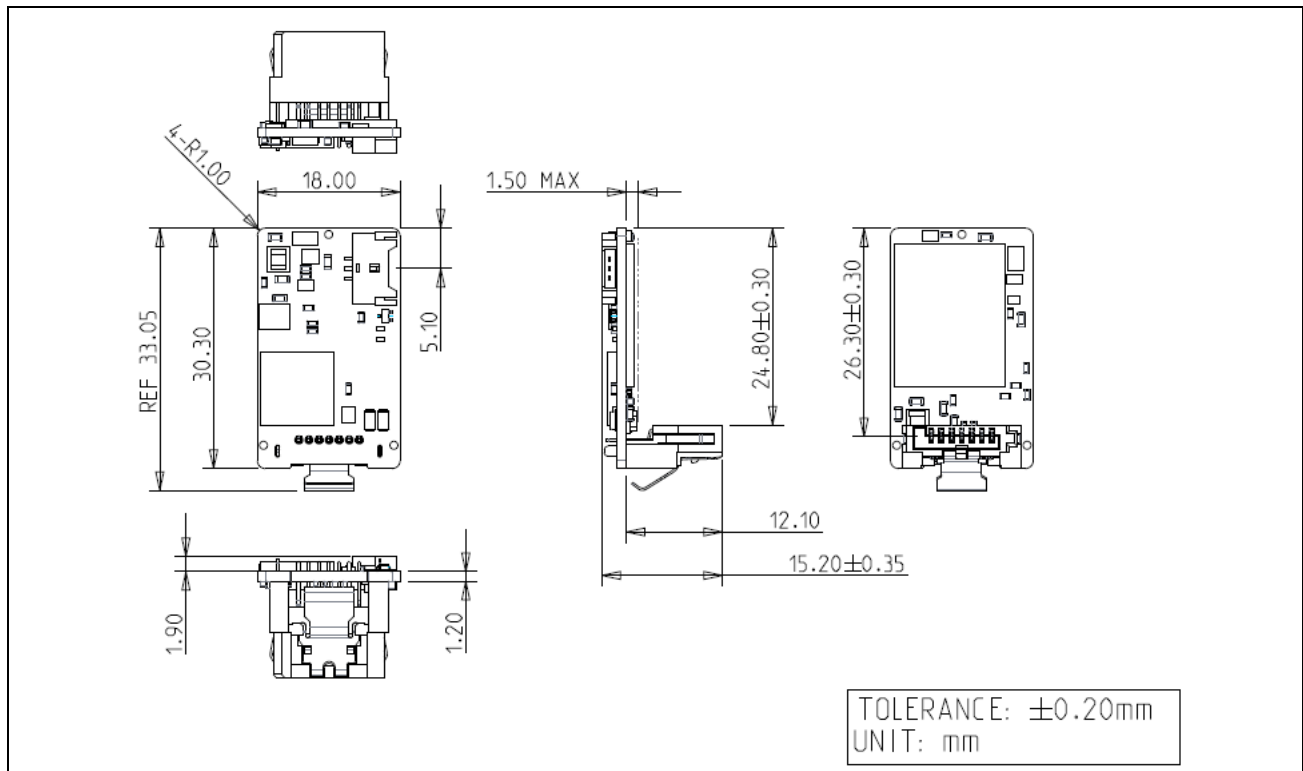

Figure 2: Innodisk SATADOM-SH 3IE7 mechanical diagram

2.11 Assembly Weight

An Innodisk SATADOM-SH 3IE7 within flash ICs, 32GB's weight is 7 grams approximately.

2.12 Seek Time

Innodisk SATADOM-SH 3IE7 is not a magnetic rotating design. There is no seek or rotational latency required.

2.13 Hot Plug

The SSD support hot plug function and can be removed or plugged-in during operation. User has to avoid hot plugging the SSD which is configured as boot device and installed operation system.

Surprise hot plug: The insertion of a SATA device into a backplane (combine signal and power) that has power present. The device powers up and initiates an OOB sequence.

Surprise hot removal: The removal of a SATA device from a powered backplane, without first being placed in a quiescent state.

2.14 NAND Flash Memory

Innodisk SATADOM-SH 3IE7 uses 3D TLC NAND flash memory, which is non-volatility, high reliability and high speed memory storage. Each cell stores 3 bits or holds four states per cell. Read or Write data to flash memory for SSD is control by microprocessor.

3. Theory of Operation

3.1 Overview

Figure 3 shows the operation of Innodisk SATADOM-SH 3IE7 from the system level, including the major hardware blocks.

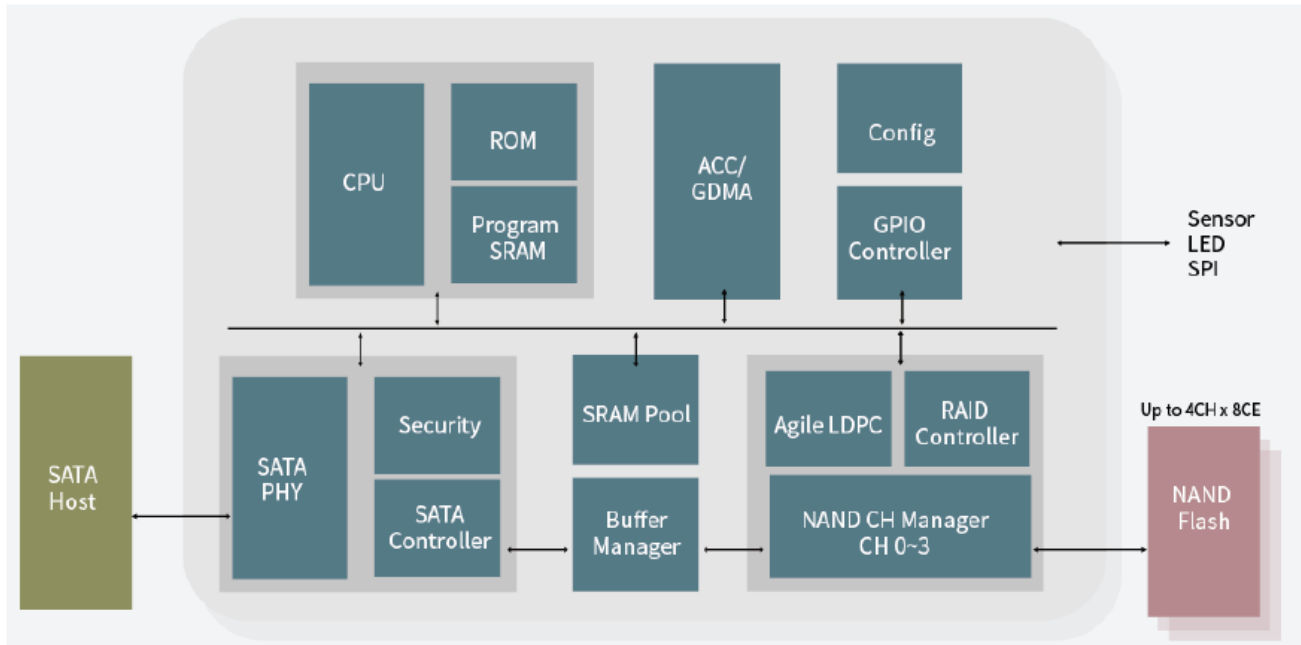

Figure 3: Innodisk SATADOM-SH 3IE7 Block Diagram

Innodisk SATADOM-SH 3IE7 integrates a SATA III controller and NAND flash memories. Communication with the host occurs through the host interface, using the standard ATA protocol. Communication with the flash device(s) occurs through the flash interface.

3.2 SATA III Controller

Innodisk SATADOM-SH 3IE7 is designed with ID 301, a SATA III 6.0Gbps (Gen. 3) controller. The Serial ATA physical, link and transport layers are compliant with Serial ATA Gen 1, Gen 2 and Gen 3 specification (Gen 3 supports 1.5Gbps/3.0Gbps/6.0Gbps data rate). The controller has 2 channels for flash interface.

3.3 Error Detection and Correction

Innodisk SATADOM-SH 3IE7 is designed with hardware LDPC ECC engine with hard-decision and soft-decision decoding. Low-density parity-check (LDPC) codes have excellent error correcting performance close to the Shannon limit when decoded with the belief-propagation (BP) algorithm using soft-decision information.

3.4 Wear-Leveling

Flash memory can be erased within a limited number of times. This number is called the **erase cycle limit** or **write endurance limit** and is defined by the flash array vendor. The erase cycle limit applies to each individual erase block in the flash device.

Innodisk SATADOM-SH 3IE7 uses a static wear-leveling algorithm to ensure that consecutive writes of a specific sector are not written physically to the same page/block in the flash. This spreads flash media usage evenly across all pages, thereby extending flash lifetime.

3.5 Bad Blocks Management

Bad Blocks are blocks that contain one or more invalid bits whose reliability are not guaranteed. The Bad Blocks may be presented while the SSD is shipped, or may develop during the life time of the SSD. When the Bad Blocks is detected, it will be flagged, and not be used anymore. The SSD implement Bad Blocks management, Bad Blocks replacement, Error Correct Code to avoid data error occurred. The functions will be enabled automatically to transfer data from Bad Blocks to spare blocks, and correct error bit.

3.6 iData Guard

Innodisk's iData Guard is a comprehensive data protection mechanism that functions before and after a sudden power outage to SSD. Low-power detection terminates data writing before an abnormal power-off, while table-remapping after power-on deletes corrupt data and maintains data integrity. Innodisk's iData Guard provides effective power cycling management, preventing data stored in flash from degrading with use.

3.7 Garbage Collection

Garbage collection is used to maintain data consistency and perform continual data cleansing on SSDs. It runs as a background process, freeing up valuable controller resources while sorting good data into available blocks, and deleting bad blocks. It also significantly reduces write operations to the drive, thereby increasing the SSD's speed and lifespan.

3.8 TRIM

The TRIM command is designed to enable the operating system to notify the SSD which pages no longer contain valid data due to erases either by the user or operating system itself. During a delete operation, the OS will mark the sectors as free for new data and send a TRIM command to the SSD to mark them as not containing valid data. After that the SSD knows not to preserve the contents of the block when writing a page, resulting in less write amplification with fewer writes to the flash, higher write speed, and increased drive life.

3.9 iPower Guard

iPower Guard technology is a set of preventive measures that protect the SSD in an unstable power supply environment. This comprehensive package comprises safeguards for startup and shutdown to maintain device performance and ensure data integrity.

3.10 Die RAID

Die RAID is a controller function which leveraged user capacity to back up the data in NAND flash. Die RAID supported can ensure the user data in the NAND Flash more consistent in certain scenario. Innodisk SATADOM-SH 3IE7 series is default enable the Die RAID function for the industrial application.

4. Installation Requirements

4.1 SATADOM-SH 3IE7 Pin Directions

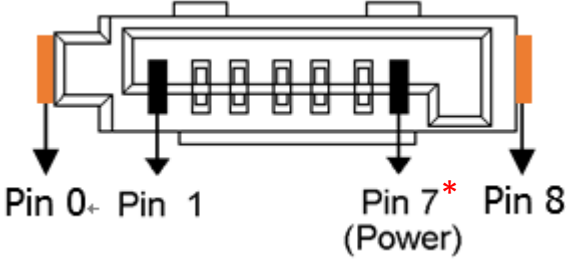

Figure 4: Signal Segment and Power Segment

*** SATADOM-SH 3IE7 default power supply through pin 8 or extra power cable.**

Pin 7 power supply as an optional function with separate PN end of B.

4.2 Electrical Connections for SATADOM-SH 3IE7

A Serial ATA device may be either directly connected to a host or connected to a host through a cable. For connection via cable, the cable should be no longer than 1meter. The SATA interface has a separate connector for the power supply. Please refer to the pin description for further details.

4.3 Device Drive

No additional device drives are required. The Innodisk SATADOM-SH 3IE7 can be configured as a boot device.

4.4 Power Supply for SATADOM

4.4.1 Power Cable

A power cable is shipped with each SATADOM product, which has standard 4 pins power connector and special 3 pins power connector for SATADOM. The male and female power connector of SATADOM have foolproof design to avoid misconnection, please check it before power on. Innodisk also can customize the power connector for different host power socket design.

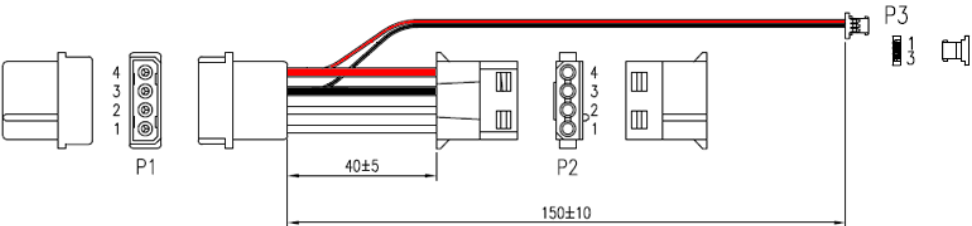

Figure 5: Standard power cable

4.4.2 Pin8 and Pin7 VCC

Innodisk’s SATADOM SSDs provide an elegant, compact option for SSD storage in embedded systems, industrial PCs and server motherboards with their small form factor that connects directly to the SATA connector on the motherboard. This simplified SSD design not only frees up a precious drive bay for other storage options but eliminates messy, obtrusive SATA data cabling. Innodisk’s patented Pin7 and Pin 8 SATA Power technologies take the cable-less concept to the next step by also eliminating the need for power cables for a 100% cable-less, shock resistant, space saving plug-and-play storage solution that optimizes airflow and makes the best use of limited board space in embedded and rackmount server systems.

SATADOM-SH 3IE7 series with Pin8/Pin7 VCC, it is defined Pin8/Pin7 as VCC on the SATA connector. Thus the power would come from SATA connector Pin8/Pin7 VCC. Customers DO NOT have to use the power cable for power supply. Such a cable-less design of SATADOM-SH 3IE7 series with Pin8/Pin7 VCC brings more convenience to customers’ system. The followings are the points customers have to be careful of while designing in SATADOM-SH 3IE7 series with Pin8/Pin7 VCC.

When customers use SATADOM with Pin8/Pin7 VCC and the host SATA socket does not have power on Pin8/Pin7, external power must be provided to the SATADOM from the 3pin connector on the side. To have the advantages of SATADOM-SH 3IE7 series with Pin8/Pin7 VCC, and to avoid any potential damage on customer’s board designed with VCC power supply. Innodisk suggests that customers MUST design their board with a fuse which should be designed before the SATA socket Pin8/Pin7 VCC. In other words, customers are suggested NOT TO layout 5V VCC to SATA socket Pin8/Pin7 VCC on board directly. A circuit diagram example to explain this is shown as below.

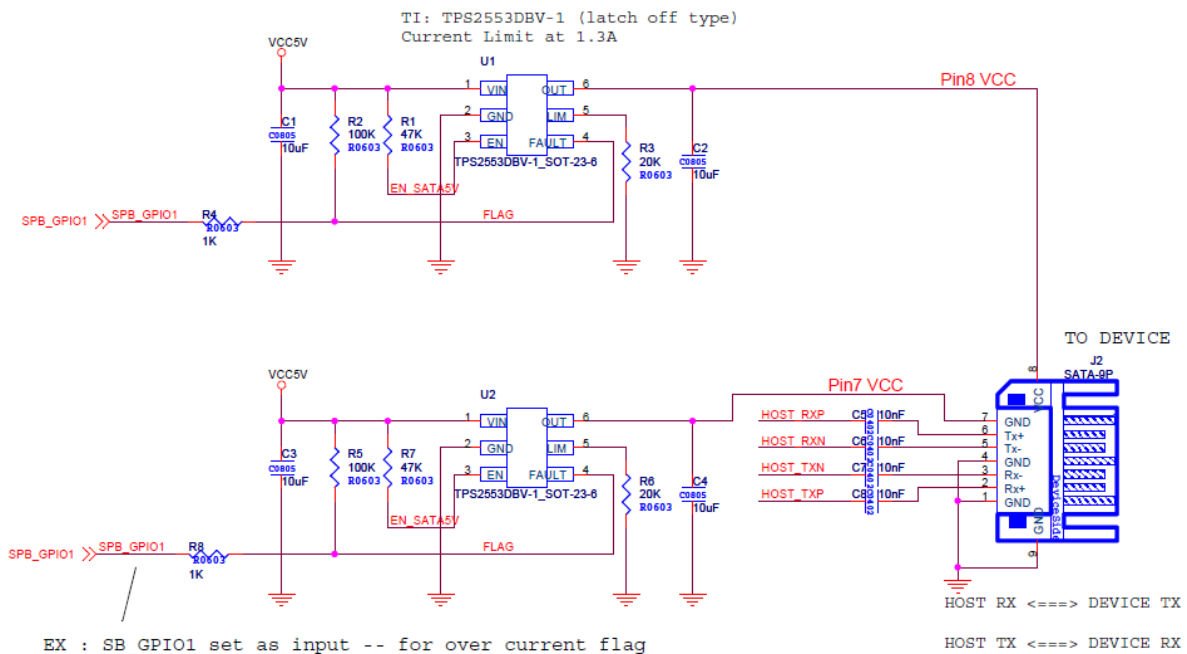

Figure 6: Pin 8 / Pin 7 host design in reference circuit

5. Part Number Rule

CODE	1	2	3	4	5	6	7	8	9	10	11	12	13	14	15	16	17	18	19	20	21
	D	H	S	S	H	-	4	0	G	D	K	1	K	C	A	D	F	A	-	X	X
Definition																					
Code 1st (Disk)											Code 14th (Operation Temperature)										
D: Disk											C: Standard Grade (0°C~ +70°C)										
Code 2nd (Feature set)											W: Industrial Grade (-40°C~ +85°C)										
H: iSLC											Code 15th (Internal control)										
Code 3rd ~5th (Form factor)											1~9: TSOP PCB version.										
SSH: SATADOM-SH											A~Z: BGA PCB version										
Code 7th ~9th (Capacity)											Code 16th (Channel of data transfer)										
S: Single Channel											D: Dual channel										
20G: 20GB	40G: 40GB	80G: 80GB	A60: 160GB																		
Code 10th ~12th (Controller)											Code 17th (Flash Type)										
DK1: SATA 3IE7 series											F: Kioxia 3D TLC										
Code 13th (Flash mode)											Code 18th (pin7 type)										
A: Pin8 version / Standard version											B: Pin8 & Pin7 version										
K: 112 layers 3D TLC																					
Code 20th~21st (Customize code)																					

6. Appendix

CE

International Standards Laboratory <http://www.isl.com.tw>

Certificate

Issue Date: August 3, 2015
Ref. Report No. ISL-15LE336CE

Product Name : SATADOM-SH
Model(s) : SATADOM-SH 3\$*#-&
(\$:Flash type: (S:SLC,I:SLC,M:MLC);
*:Product line: (E:Embedded, G:EverGreen, R:InnoRobust);
#:Controller: (empty:106/107/167/170, 2:201/ 202, 3:108/109);
&:Product feature: (P:with DRAM, empty:without DRAM))

Responsible Party : Innodisk Corporation
Address : 5F.No.237, Sec. 1, Datong Rd., Xizhi Dist., New Taipei City 221, Taiwan (R.O.C.)

We, International Standards Laboratory, hereby certify that:

The device bearing the trade name and model specified above has been shown to comply with the applicable technical standards as indicated in the measurement report and was tested in accordance with the measurement procedures specified in European Council Directive- EMC Directive 2004/108/EC. The device was passed the test performed according to :

CE

Standards:
EN 55022: 2010+AC2011 and CISPR 22: 2008 (modified)
EN 61000-3-2: 2006+A1:2009 +A2:2009 and IEC 61000-3-2: 2005+A1:2008 +A2:2009
EN 61000-3-3: 2013 and IEC 61000-3-3: 2013
EN 55024: 2010 and CISPR 24: 2010
EN 61000-4-2: 2009 and IEC 61000-4-2: 2008
EN 61000-4-3: 2006+A1: 2008 +A2: 2010 and
IEC 61000-4-3:2006+A1: 2007+A2: 2010
EN 61000-4-4:2012 and IEC 61000-4-4:2012

I attest to the accuracy of data and all measurements reported herein were performed by me or were made under my supervision and are correct to the best of my knowledge and belief. I assume full responsibility for the completeness of these measurements and vouch for the qualifications of all persons taking them.

International Standards Laboratory

Hsi-Chih LAB:
No. 65, Gu Dai Keng Street, Hsi-Chih Dist.,
New Taipei City 221, Taiwan
Tel: 886-2-2646-2550; Fax: 886-2-2646-4641

Lung-Tan LAB:
No. 120, Lane 180, Hsin Ho Rd., Lung-Tan Dist.,
Tao Yuan City 325, Taiwan
Tel: 886-3-407-1718; Fax: 886-3-407-1738

Jim Chu / Director

FCC

International Standards Laboratory http://www.isl.com.tw

Certificate

Issue Date: August 3, 2015
Ref. Report No. ISL-15LE336FB

Product Name : SATADOM-SH
Model(s) : SATADOM-SH 3\$*#-&
(\$:Flash type: (S:SLC,I:iSLC,M:MLC);
*:Product line: (E:Embedded, G:EverGreen, R:InnoRobust);
#:Controller: (empty:106/107/167/170, 2:201/ 202, 3:108/109);
&:Product feature: (P:with DRAM, empty:without DRAM))
Applicant : Innodisk Corporation
Address : 5F No.237, Sec. 1, Datong Rd., Xizhi Dist., New Taipei City 221, Taiwan (R.O.C.)

We, International Standards Laboratory, hereby certify that:

The device bearing the trade name and model specified above has been shown to comply with the applicable technical standards as indicated in the measurement report and was tested in accordance with the measurement procedures specified. (refer to Test Report if any modifications were made for compliance).



Standards:

FCC CFR Title 47 Part 15 Subpart B: 2014- Section 15.107 and 15.109
ANSI C63.4-2009
Industry Canada Interference-Causing Equipment Standard ICES-003 Issue 5: 2012

Class B

I attest to the accuracy of data and all measurements reported herein were performed by me or were made under my supervision and are correct to the best of my knowledge and belief. I assume full responsibility for the completeness of these measurements and vouch for the qualifications of all persons taking them.

International Standards Laboratory

Jim Chu
Jim Chu / Director

Hsi-Chih LAB:
No. 65, Gu Dai Keng Street, Hsi-Chih Dist.,
New Taipei City 221, Taiwan
Tel: 886-2-2646-2550; Fax: 886-2-2646-4641



Lung-Tan LAB:
No. 120, Lane 180, Hsin Ho Rd., Lung-Tan Dist.,
Tao Yuan City 325, Taiwan
Tel: 886-3-407-1718; Fax: 886-3407-1738



REACH

宜鼎國際股份有限公司
Innodisk Corporation
REACH Declaration

Tel:(02)7703-3000 Fax:(02) 7703-3555 Internet: <http://www.innodisk.com/>

We hereby confirm that the product(s) delivered to

Innodisk P/N	Description
All Innodisk EM Flash and Dram Products	

- contain(s) **no** hazardous substances or constituents exceeding the defined threshold 0.1 % by weight in homogenous material if not otherwise specified, as described in the candidate list table currently including 191 substances and shown on the ECHA website (<http://echa.europa.eu/de/candidate-list-table>).
- contain(s) one or more hazardous substances or constituents exceeding 0.1 % by weight in homogenous material if not otherwise specified in candidate list table. Where the threshold value is exceeded, the substances in question are to be declared in accompanying Appendix A & B.
- Comply with REACH Annex XVII.

Guarantor

Company name 公司名稱：Innodisk Corporation 宜鼎國際股份有限公司

Company Representative 公司代表人：Randy Chien 簡川勝

Company Representative Title 公司代表人職稱：Chairman 董事長

Date 日期：2018 / 02 / 08

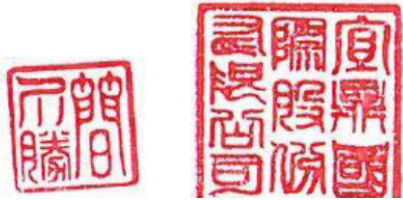

RoHS 自我宣告書 (RoHS Declaration of Conformity)

Manufacturer Product: All Innodisk EM Flash and Dram products

- 一、 宜鼎國際股份有限公司（以下稱本公司）特此保證售予貴公司之所有產品，皆符合歐盟 2011/65/EU 及 (EU) 2015/863 關於 RoHS 之規範要求。

Innodisk Corporation declares that all products sold to the company, are complied with European Union RoHS Directive (2011/65/EU) and (EU) 2015/863 requirement.

- 二、 本公司同意因本保證書或與本保證書相關事宜有所爭議時，雙方宜友好協商，達成協議。

Innodisk Corporation agrees that both parties shall settle any dispute arising from or in connection with this Declaration of Conformity by friendly negotiations.

Name of hazardous substance	Limited of RoHS ppm (mg/kg)
鉛 (Pb)	< 1000 ppm
汞 (Hg)	< 1000 ppm
鎘 (Cd)	< 100 ppm
六價鉻 (Cr 6+)	< 1000 ppm
多溴聯苯 (PBBs)	< 1000 ppm
多溴二苯醚 (PBDEs)	< 1000 ppm
鄰苯二甲酸二(2-乙基己基)酯 (DEHP)	< 1000 ppm
鄰苯二甲酸丁酯苯甲酯 (BBP)	< 1000 ppm
鄰苯二甲酸二丁酯 (DBP)	< 1000 ppm
鄰苯二甲酸二異丁酯 (DIBP)	< 1000 ppm

立保證書人 (Guarantor)

Company name 公司名稱：Innodisk Corporation 宜鼎國際股份有限公司

Company Representative 公司代表人：Randy Chien 簡川勝

Company Representative Title 公司代表人職稱：Chairman 董事長

Date 日期：2018 / 07 / 01



MSL

MSL Declaration of Conformity

1. Purpose: MSL (Moisture Sensitivity Levels) specification statement for all Innodisk products

2. Scope: For All Innodisk finish goods

3. Responsibilities: QA

4. Reference:

4.1 JEDEC, S-STD-020

4.2 JEDEC, J-STD-033

5. Description

5.1 Innodisk Products Level: All Innodisk products meet MSL Level 1

5.2 Floor Life Time: Refer following table

Level	Soak Requirements					
	Floor Life		Standard		Accelerated	
	Time	Cond degC/%RH	Time (hrs)	Cond degC/%RH	Time (hrs)	Cond degC/%RH
1	unlimited	<=30/85%	168+5/-0	85/85	n/a	n/a
2	1 year	<=30/60%	168+5/-0	85/60	n/a	n/a
2a	4 weeks	<=30/60%	696+5/-0	30/60	120+1/-0	60/60
3	168 hours	<=30/60%	192+5/-0	30/60	40+1/-0	60/60
4	72 hours	<=30/60%	96+2/-0	30/60	20+0.5/-0	60/60
5	48 hours	<=30/60%	72+2/-0	30/60	15+0.5/-0	60/60
5a	24 hours	<=30/60%	48+2/-0	30/60	10+0.5/-0	60/60
6	TOL	<=30/60%	TOL	30/60	n/a	60/60

**Innodisk Corporation
Quality Assurance Div
Manager
Yi Chuan Chen
Date: 2018.09.21**



數位簽署者: Yi Chuan Chen
DN : cn=Yi Chuan Chen, o=Innodisk Corporation, ou=QA Div, email=yichuan_chen@innodisk.com, c=TW
日期: 2018.09.21 13:39:10 +08'00'