

MODEL:
KINO-AQ170

Mini-ITX SBC Supports LGA 1151 Intel® Core™ i7/i5/i3, Pentium® or Celeron® CPU with Intel® Q170, HDMI 2.0, DP, VGA, Dual PCIe GbE, PCIe Mini, PCIe x8, SATA 6Gb/s, USB 3.2 Gen 1, HD Audio, and RoHS

User Manual

Revision

Date	Version	Changes
October 15, 2021	1.01	Updated Section 2.3: Packing List Updated Section 3.3.5: HDMI/DP Connector Updated Chapter 6: Software Drivers Changed audio IC to ALC888S
June 20, 2016	1.00	Initial release

Copyright

COPYRIGHT NOTICE

The information in this document is subject to change without prior notice in order to improve reliability, design and function and does not represent a commitment on the part of the manufacturer.

In no event will the manufacturer be liable for direct, indirect, special, incidental, or consequential damages arising out of the use or inability to use the product or documentation, even if advised of the possibility of such damages.

This document contains proprietary information protected by copyright. All rights are reserved. No part of this manual may be reproduced by any mechanical, electronic, or other means in any form without prior written permission of the manufacturer.

TRADEMARKS

All registered trademarks and product names mentioned herein are used for identification purposes only and may be trademarks and/or registered trademarks of their respective owners.

Manual Conventions



WARNING

Warnings appear where overlooked details may cause damage to the equipment or result in personal injury. Warnings should be taken seriously.



CAUTION

Cautionary messages should be heeded to help reduce the chance of losing data or damaging the product.



NOTE

These messages inform the reader of essential but non-critical information. These messages should be read carefully as any directions or instructions contained therein can help avoid making mistakes.

Table of Contents

1 INTRODUCTION.....	1
1.1 INTRODUCTION.....	2
1.2 FEATURES.....	3
1.3 CONNECTOR.....	4
1.4 DIMENSIONS.....	6
1.5 DATA FLOW	7
1.6 TECHNICAL SPECIFICATIONS	8
2 UNPACKING	11
2.1 ANTI-STATIC PRECAUTIONS	12
2.2 UNPACKING PRECAUTIONS.....	12
2.3 PACKING LIST.....	13
2.4 OPTIONAL ITEMS	14
3 CONNECTORS	16
3.1 PERIPHERAL INTERFACE CONNECTORS.....	17
3.1.1 KINO-AQ170 Layout	17
3.1.2 Peripheral Interface Connectors	19
3.1.3 External Interface Panel Connectors.....	20
3.2 INTERNAL PERIPHERAL CONNECTORS	21
3.2.1 +12V DC-IN Power Connector	21
3.2.2 ATX Power Connector	21
3.2.3 Audio Connector	23
3.2.4 Battery Connector.....	24
3.2.5 Buzzer Connector.....	25
3.2.6 Chassis Intrusion Connector.....	26
3.2.7 Debug Connector.....	27
3.2.8 Digital I/O Connector	28
3.2.9 EC Debug Connector.....	29
3.2.10 Fan Connectors.....	30
3.2.11 Front Panel Connector.....	31

3.2.12 I ² C Connector	32
3.2.13 Internal DisplayPort Connector	33
3.2.14 LAN LED Connectors	34
3.2.15 PCI Express x8 Slot.....	35
3.2.16 PCIe Mini Card Slot	37
3.2.17 Power Button	39
3.2.18 RS-232 Serial Port Connectors.....	40
3.2.19 RS-232/422/485 Serial Port Connectors	41
3.2.20 SATA 6Gb/s Drive Connectors.....	42
3.2.21 SMBus Connector	43
3.2.22 SPI Flash Connector, BIOS.....	44
3.2.23 SPI Flash Connector, EC.....	45
3.2.24 USB Connectors.....	46
3.2.25 VGA Firmware Update Connector	47
3.3 EXTERNAL PERIPHERAL INTERFACE CONNECTOR PANEL	48
3.3.1 Audio Connector	49
3.3.2 Keyboard/Mouse and USB 2.0 Combo Connector	49
3.3.3 Ethernet and USB 3.2 Gen 1 Combo Connectors.....	50
3.3.4 HDMI 2.0 Connector	52
3.3.5 HDMI/DP Connector.....	53
3.3.6 VGA Connector	55
4 INSTALLATION	56
4.1 ANTI-STATIC PRECAUTIONS	57
4.2 INSTALLATION CONSIDERATIONS.....	57
4.3 SOCKET LGA1151 CPU INSTALLATION	59
4.4 SOCKET LGA1151 COOLING KIT INSTALLATION	62
4.5 SO-DIMM INSTALLATION	64
4.6 PCIe MINI CARD INSTALLATION	65
4.6.1 Full-size PCIe Mini Card Installation	65
4.6.2 Half-size PCIe Mini Card Installation.....	67
4.7 SYSTEM CONFIGURATION.....	69
4.7.1 AT/ATX Mode Select Switch.....	69
4.7.2 Clear CMOS Button.....	70
4.7.3 Flash Descriptor Security Override Jumper.....	71

KINO-AQ170 Industrial Motherboard

4.7.4 HDMI/DP Select Switch.....	72
4.7.5 mSATA Module Detection Jumper	73
4.7.6 USB Power Selection	73
4.8 CHASSIS INSTALLATION.....	74
4.8.1 Airflow.....	74
4.8.2 Motherboard Installation.....	74
4.9 INTERNAL PERIPHERAL DEVICE CONNECTIONS.....	75
4.9.1 SATA Drive Connection	75
4.9.2 RS-232 Cable Connection (Optional).....	76
4.10 INTEL® AMT SETUP PROCEDURE.....	78
4.11 WINDOWS 7 INSTALLATION–USB 3.2 GEN 1 CREATOR UTILITY	79
5 BIOS.....	80
5.1 INTRODUCTION.....	81
5.1.1 Starting Setup.....	81
5.1.2 Using Setup	81
5.1.3 Getting Help.....	82
5.1.4 Unable to Reboot after Configuration Changes	82
5.1.5 BIOS Menu Bar.....	82
5.2 MAIN.....	83
5.3 ADVANCED.....	84
5.3.1 ACPI Settings.....	85
5.3.2 AMT Configuration	86
5.3.3 Super IO Configuration	87
5.3.3.1 Serial Port n Configuration	88
5.3.3.1.1 Serial Port 1 Configuration	88
5.3.3.1.2 Serial Port 2 Configuration	89
5.3.3.1.3 Serial Port 3 Configuration	90
5.3.3.1.4 Serial Port 4 Configuration	91
5.3.3.1.5 Serial Port 5 Configuration	92
5.3.3.1.6 Serial Port 6 Configuration	93
5.3.4 iWDD H/W Monitor.....	94
5.3.4.1 Smart Fan Mode Configuration	96
5.3.5 RTC Wake Settings.....	99
5.3.6 Serial Port Console Redirection	100

5.3.6.1 Legacy Console Redirection Settings	101
5.3.6.2 Console Redirection Settings	102
5.3.7 CPU Configuration	104
5.3.8 SATA Configuration	106
5.3.9 NVMe Configuration	108
5.3.10 USB Configuration	109
5.3.11 IEI Feature	110
5.4 CHIPSET	111
5.4.1 System Agent (SA) Configuration	111
5.4.1.1 Graphics Configuration	112
5.4.1.2 PEG Port Configuration	114
5.4.1.3 Memory Configuration	116
5.4.2 PCH-IO Configuration	116
5.4.2.1 PCI Express Configuration	118
5.4.2.2 HD Audio Configuration	119
5.5 SECURITY	120
5.6 BOOT	121
5.7 SAVE & EXIT	123
6 SOFTWARE DRIVERS	125
6.1 AVAILABLE DRIVERS	126
6.2 DRIVER DOWNLOAD	126
A REGULATORY COMPLIANCE	128
B PRODUCT DISPOSAL	130
C BIOS MENU OPTIONS	132
D DIGITAL I/O INTERFACE	136
D.1 INTRODUCTION	137
D.2 ASSEMBLY LANGUAGE SAMPLE 1	138
D.3 ASSEMBLY LANGUAGE SAMPLE 2	138
E WATCHDOG TIMER	139
F ERROR BEEP CODE	142
F.1 PEI BEEP CODES	143

KINO-AQ170 Industrial Motherboard

F.2 DXE BEEP CODES	143
G HAZARDOUS MATERIALS DISCLOSURE	144
G.1 RoHS II DIRECTIVE (2015/863/EU).....	145
G.2 CHINA RoHS	146

List of Figures

Figure 1-1: KINO-AQ170 Industrial Motherboard	2
Figure 1-2: Connectors (Front Side)	4
Figure 1-3: Connectors (Solder Side)	5
Figure 1-4: Dimensions (mm)	6
Figure 1-5: Data Flow Diagram	7
Figure 3-1: Connector and Jumper Locations (Front Side)	17
Figure 3-2: Connector and Jumper Locations (Solder Side)	18
Figure 3-3: +12V DC-IN Power Connector Location	21
Figure 3-4: ATX Power Connector Location	22
Figure 3-5: Audio Connector Location	23
Figure 3-6: Battery Connector Location	24
Figure 3-7: Buzzer Connector Location	25
Figure 3-8: Chassis Intrusion Connector Location	26
Figure 3-9: Debug Connector Location	27
Figure 3-10: Digital I/O Connector Location	28
Figure 3-11: EC Debug Connector Location	29
Figure 3-12: Fan Connector Locations	30
Figure 3-13: Front Panel Connector Location	31
Figure 3-14: I ² C Connector Location	32
Figure 3-15: Internal DisplayPort Connector Location	33
Figure 3-16: LAN LED Connector Locations	34
Figure 3-17: PCIe x8 Slot Location	35
Figure 3-18: PCIe Mini Card Slot Location	38
Figure 3-19: Power Button Location	39
Figure 3-20: RS-232 Connector Locations	40
Figure 3-21: RS-232/422/485 Connector Locations	41
Figure 3-22: SATA 6Gb/s Drive Connector Locations	42
Figure 3-23: SMBus Connector Location	43
Figure 3-24: SPI Flash Connector Location	44
Figure 3-25: SPI Flash Connector Location	45
Figure 3-26: USB Connector Locations	46

KINO-AQ170 Industrial Motherboard

Figure 3-27: VGA Firmware Update Connector Location	47
Figure 3-28: External Peripheral Interface Connector	48
Figure 3-29: Audio Connector	49
Figure 3-30: Keyboard/Mouse and USB 2.0 Combo Connector	50
Figure 3-31: Ethernet Connector.....	51
Figure 3-32: HDMI Connector Pinout Locations.....	52
Figure 3-33: HDMI/DP Connector Pinout Locations.....	54
Figure 3-34: VGA Connector	55
Figure 4-1: Disengage the CPU Socket Load Lever.....	59
Figure 4-2: Remove Protective Cover.....	60
Figure 4-3: Insert the Socket LGA1151 CPU.....	61
Figure 4-4: Close the Socket LGA1151.....	61
Figure 4-5: Cooling Kit Support Bracket.....	62
Figure 4-6: SO-DIMM Installation	64
Figure 4-7: Removing the Retention Screw and Standoff for a Half-size PCIe Mini Card.....	65
Figure 4-8: Removing the Retention Screw	65
Figure 4-9: Inserting the Full-size PCIe Mini Card into the Slot at an Angle	66
Figure 4-10: Securing the Full-size PCIe Mini Card	66
Figure 4-11: Removing Retention Screw	67
Figure 4-12: Inserting the Half-size PCIe Mini Card into the Slot at an Angle.....	67
Figure 4-13: Securing the Half-size PCIe Mini Card	68
Figure 4-14: AT/ATX Mode Select Switch Location	69
Figure 4-15: Clear CMOS Button Location.....	70
Figure 4-16: Flash Descriptor Security Override Jumper Location	71
Figure 4-17: HDMI/DP Select Switch Location.....	72
Figure 4-18: mSATA Module Detection Jumper Location	73
Figure 4-19: SATA Drive Cable Connection.....	75
Figure 4-20: SATA Power Drive Connection.....	76
Figure 4-21: Single RS-232 Cable Installation	77
Figure 6-1: IEI Resource Download Center.....	126

List of Tables

Table 1-1: Technical Specifications	10
Table 3-1: Peripheral Interface Connectors	20
Table 3-2: Rear Panel Connectors	20
Table 3-3: +12V DC-IN Power Connector Pinouts	21
Table 3-4: ATX Power Connector Pinouts.....	22
Table 3-5: Audio Connector Pinouts	23
Table 3-6: Battery Connector Pinouts	25
Table 3-7: Buzzer Connector Pinouts.....	25
Table 3-8: Chassis Intrusion Connector Pinouts	26
Table 3-9: Debug Connector Pinouts	27
Table 3-10: Digital I/O Connector Pinouts.....	28
Table 3-11: EC Debug Connector Pinouts	29
Table 3-12: Fan Connector Pinouts	30
Table 3-13: Front Panel Connector Pinouts.....	31
Table 3-14: I ² C Connector Pinouts.....	32
Table 3-15: Internal DisplayPort Connector Pinouts	33
Table 3-16: LAN LED Connector Pinouts	34
Table 3-17: PCIe x8 Slot Pinouts.....	37
Table 3-18: PCIe Mini Card Slot Pinouts	39
Table 3-19: RS-232 Connector Pinouts	40
Table 3-20: RS-232/422/485 Connector Pinouts	41
Table 3-21: DB-9 RS-422/485 Pinouts	42
Table 3-22: SMBus Connector Pinouts	43
Table 3-23: SPI Flash Connector Pinouts	44
Table 3-24: SPI Flash Connector Pinouts	45
Table 3-25: USB Connector Pinouts	46
Table 3-26: VGA Firmware Update Connector Pinouts	47
Table 3-27: USB 2.0 Port Pinouts.....	49
Table 3-28: Keyboard/Mouse Connector Pinouts	50
Table 3-29: Ethernet Connector Pinouts	51
Table 3-30: Connector LEDs.....	51

KINO-AQ170 Industrial Motherboard

Table 3-31: USB 3.2 Gen 1 Port Pinouts	51
Table 3-32: HDMI Connector Pinouts	52
Table 3-33: HDMI/DP Connector Pinouts	54
Table 3-34: VGA Connector Pinouts	55
Table 4-1: AT/ATX Mode Select Switch Settings	69
Table 4-2: Flash Descriptor Security Override Jumper Settings	71
Table 4-3: HDMI/DP Select Switch Settings	72
Table 4-4: mSATA Module Detection Jumper Settings	73
Table 4-5: BIOS Options and Configured USB Ports	73
Table 4-6: USB Power Source Setup	74
Table 5-1: BIOS Options and Configured USB Ports	118

List of BIOS Menus

BIOS Menu 1: Main	83
BIOS Menu 2: Advanced	84
BIOS Menu 3: ACPI Settings	85
BIOS Menu 4: AMT Configuration	86
BIOS Menu 5: Super IO Configuration.....	87
BIOS Menu 6: Serial Port n Configuration	88
BIOS Menu 7: iWDD H/W Monitor	95
BIOS Menu 8: Smart Fan Mode Configuration	96
BIOS Menu 9: RTC Wake Settings	99
BIOS Menu 10: Serial Port Console Redirection	100
BIOS Menu 11: Legacy Console Redirection Settings	101
BIOS Menu 12: Console Redirection Settings	102
BIOS Menu 13: CPU Configuration	104
BIOS Menu 14: SATA Configuration	106
BIOS Menu 15: NVMe Configuration.....	108
BIOS Menu 16: USB Configuration	109
BIOS Menu 17: IEI Feature	110
BIOS Menu 18: Chipset	111
BIOS Menu 19: System Agent (SA) Configuration	111
BIOS Menu 20: Graphics Configuration	112
BIOS Menu 21: PEG Port Configuration.....	114
BIOS Menu 22: Memory Configuration.....	116
BIOS Menu 23: PCH-IO Configuration	116
BIOS Menu 24: PCI Express Configuration	118
BIOS Menu 25: HD Audio Configuration	119
BIOS Menu 26: Security	120
BIOS Menu 27: Boot	121
BIOS Menu 28: Exit.....	123

Chapter

1

Introduction

1.1 Introduction



Figure 1-1: KINO-AQ170 Industrial Motherboard

The KINO-AQ170 series is a Mini-ITX form factor industrial motherboard. It has an LGA 1156 socket that supports Intel® Core™ i7/i5/i3, Pentium® or Celeron® processor. It also equipped with two 260-pin 2133 MHz dual-channel DDR4 SDRAM SO-DIMM slots supporting up to 64 GB of memory.

The KINO-AQ170 series includes an internal DisplayPort connector, an HDMI 2.0 port, an HDMI/DP port and a VGA connector for triple independent display.

Expansion and I/O include one full-size/half-size PCIe Mini slot supporting mSATA modules, one PCIe x8 slot for expansion, four USB 3.2 Gen 1 (5Gb/s) connectors plus two USB 2.0 connectors on the rear panel and four SATA 6Gb/s connectors. Serial device connectivity is provided by four internal RS-232 connectors and two internal RS-232/422/485 connectors. Two RJ-45 GbE connectors provide the system with smooth connections to an external LAN.

KINO-AQ170 Industrial Motherboard

1.2 Features

Some of the KINO-AQ170 motherboard features are listed below:

- Mini-ITX motherboard supports Intel® Core™ i7/i5/i3, Pentium® or Celeron® processor
- Two 2133 MHz DDR4 SO-DIMM slots support up to 64 GB of memory
- Triple independent display via HDMI 2.0, HDMI/DP 1.2, VGA and iDP interface
- Supports HDMI 2.0 (4096x2160 @ 60Hz)
- Dual Intel® GbE port supporting Intel® AMT 11.0
- One full-size/half-size PCIe Mini card slot supports mSATA module
- Four SATA 6Gb/s connectors with RAID 0/1/5/10 support
- Four USB 3.2 Gen 1 (5Gb/s) external connectors
- Four internal RS-232 connectors and two internal RS-232/422/485 connector
- IEI One Key Recovery solution allows you to create rapid OS backup and recovery

1.3 Connector

The connectors on the KINO-AQ170 are shown in the figures below.

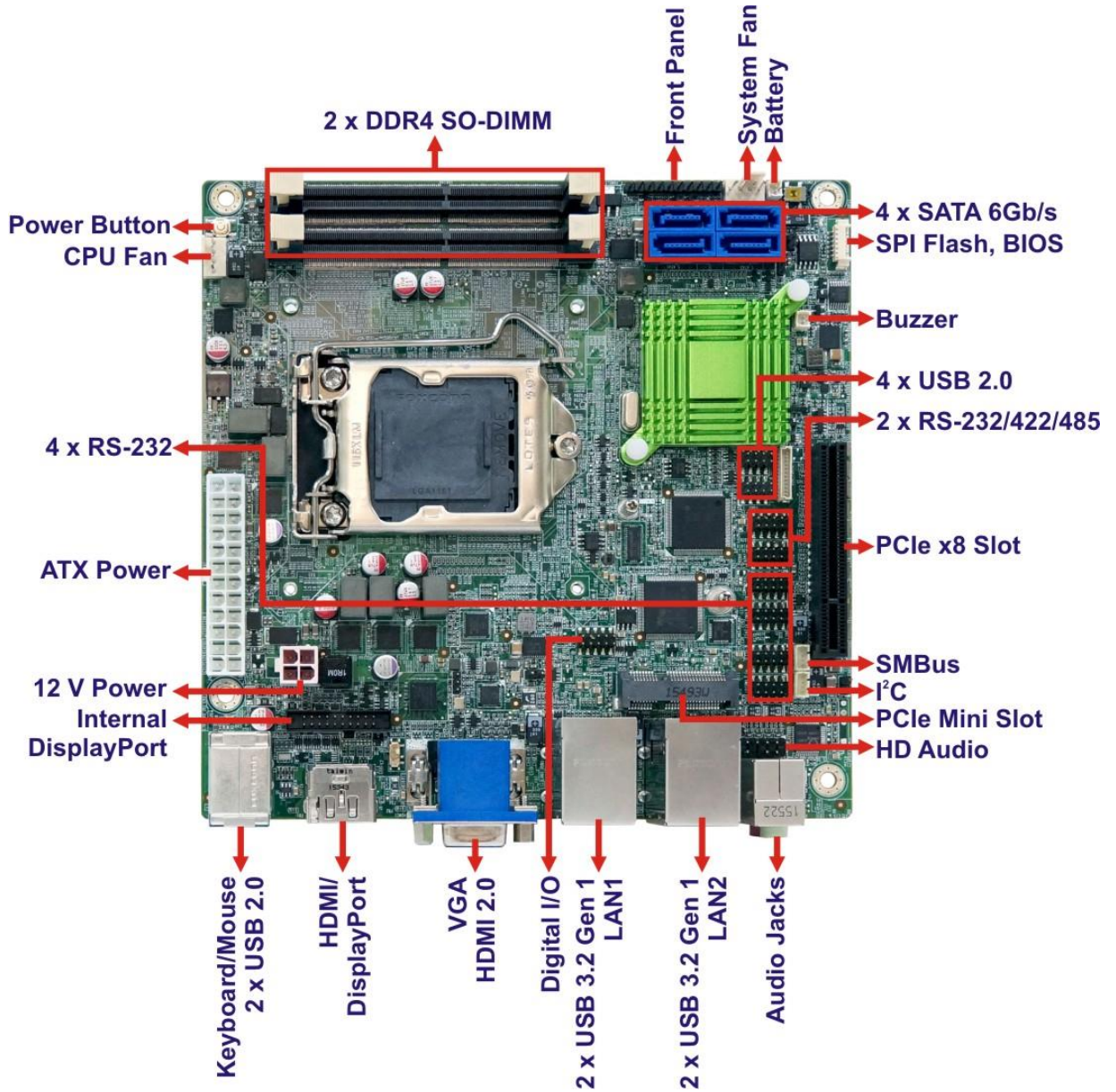

Figure 1-2: Connectors (Front Side)

KINO-AQ170 Industrial Motherboard

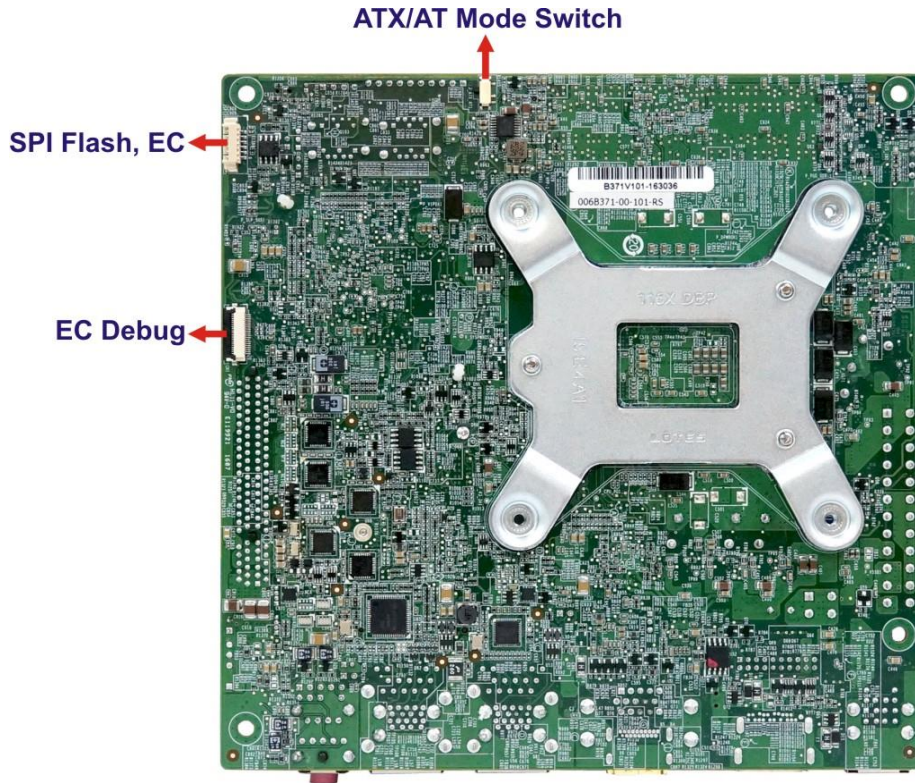

Figure 1-3: Connectors (Solder Side)

1.4 Dimensions

The dimensions of the board are listed below:

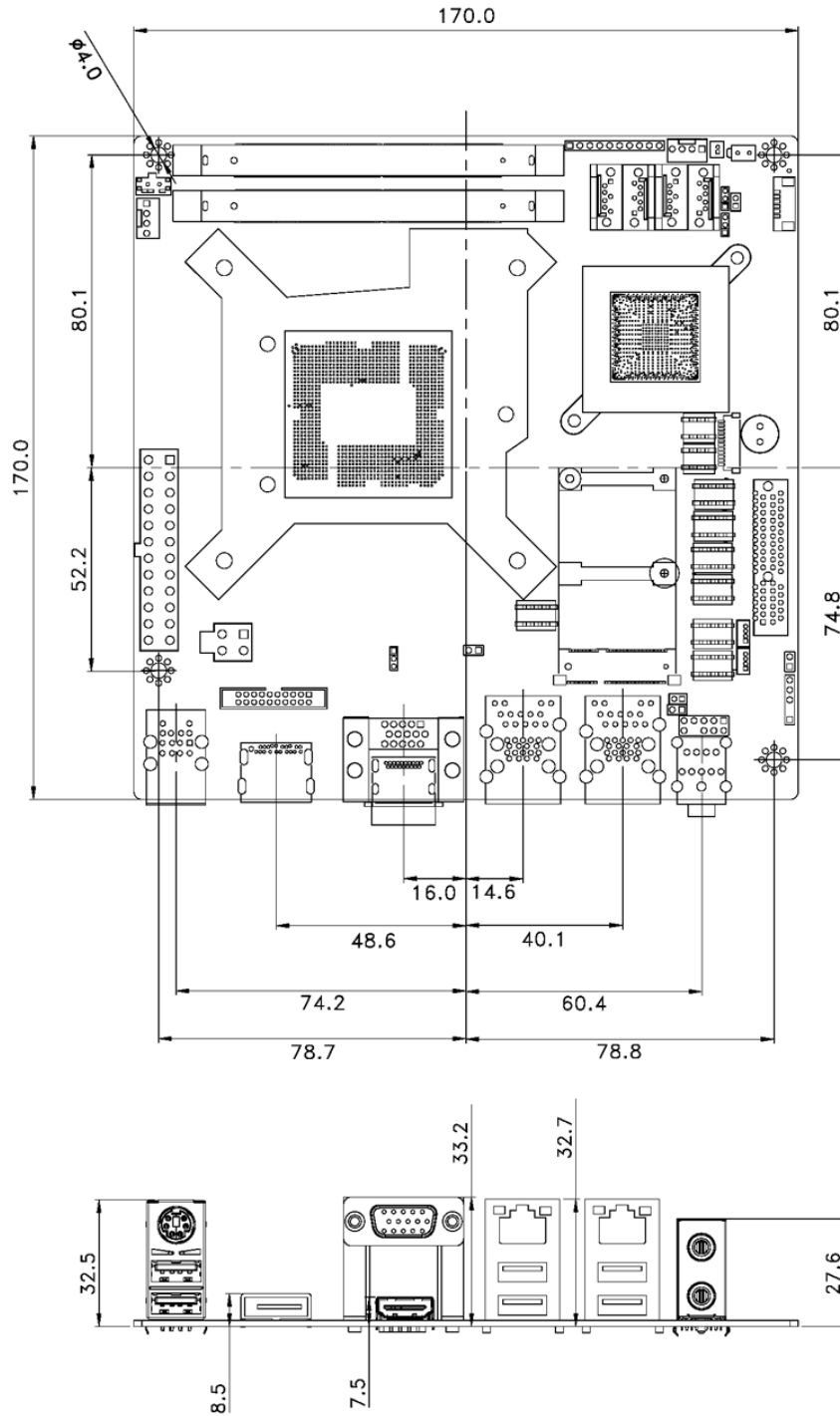

Figure 1-4: Dimensions (mm)

KINO-AQ170 Industrial Motherboard

1.5 Data Flow

Figure 1-5 shows the data flow between the system chipset, the CPU and other components installed on the motherboard.

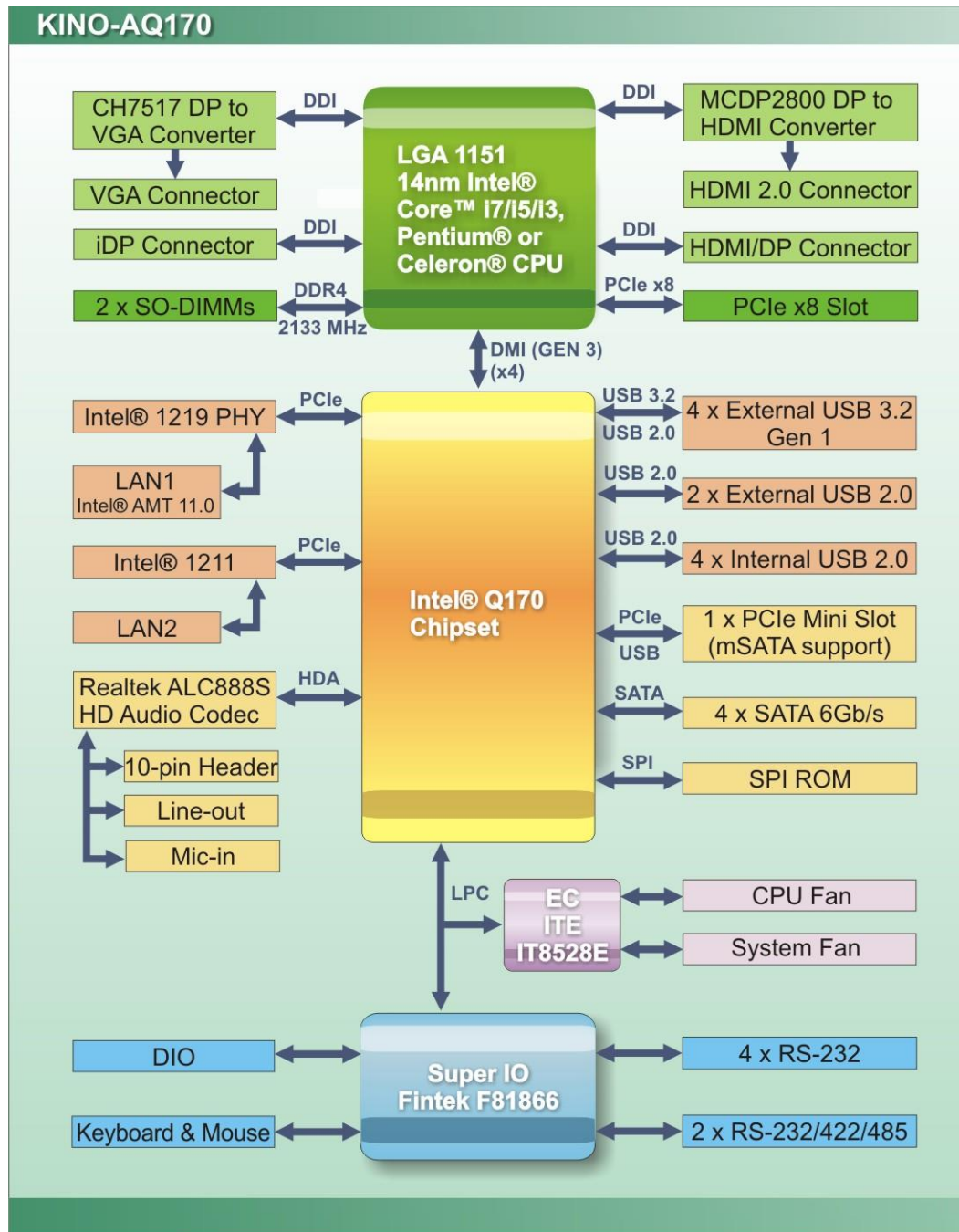

Figure 1-5: Data Flow Diagram

1.6 Technical Specifications

KINO-AQ170 technical specifications are listed below.

Specification	KINO-AQ170
Form Factor	Mini-ITX
CPU	LGA 1151 socket supports 6 th generation Intel® Core™ i7/i5/i3, Pentium® and Celeron® processors
Chipset	Intel® Q170
BIOS	AMI BIOS
Memory	Two 260-pin 2133 MHz dual-channel DDR4 SO-DIMM slots (system max. 64 GB)
Graphics	9 th generation Intel® HD Graphics with 16 low-power execution units, supporting DX11, DX12, OpenGL 4.3/4.4 and ES 2.0 decode/encode for HEVC, VP8, VP9, VDENC
Display Output	<p>Triple independent display</p> <p>1 x HDMI 2.0 by MCDP2800-BB DP to HDMI converter (up to 4096x2160 @ 60Hz)</p> <p>1 x HDMI/DP (DP 1.2 up to 3840x2160 @ 60Hz; HDMI 1080p)*</p> <p>1 x VGA by CH7517 DP to VGA converter (up to 1920x1200)</p> <p>1 x iDP interface for HDMI, LVDS, VGA, DVI, DP (up to 2560x1600 @ 60Hz)</p>
Ethernet	<p>LAN1: Intel® I219-LM PHY with Intel® AMT 11.0 support</p> <p>LAN2: Intel® I211-AT PCIe GbE controller with NCSI support</p>
Super IO	Fintek F81866D-I
Embedded Controller	ITE IT8528E/FX
Audio	Realtek ALC888S HD codec
Watchdog Timer	Software programmable support 1~255 sec. system reset
I/O Interface	
Audio Connector	<p>2 x Audio jacks (line-out and mic-in)</p> <p>1 x Audio connector by 10-pin (2x5) header</p>

KINO-AQ170 Industrial Motherboard

Specification	KINO-AQ170
Digital I/O	8-bit digital I/O by 10-pin (2x5) header
Ethernet	2 x RJ-45 GbE port
Keyboard/Mouse	1 x PS/2 keyboard/mouse connector
Serial Ports	4 x RS-232 by 10-pin (2x5) header 2 x RS-232/422/485 by 10-pin (2x5) header
USB Ports	4 x USB 3.2 Gen 1 (5Gb/s) on rear I/O 2 x USB 2.0 on rear I/O 4 x USB 2.0 by 8-pin (2x4) header
Front Panel	1 x Front panel connector by 10-pin (1x10) wafer (supports power LED, HDD LED, speaker, power button and reset button)
LAN LED	2 x LAN link LED connector by 2-pin header
Fan	1 x CPU fan connector by 4-pin (1x4) wafer 1 x System fan connector by 4-pin (1x4) wafer
SMBus	1 x SMBus connector by 4-pin (1x4) wafer
I²C	1 x I ² C connector by 4-pin (1x4) wafer
Storage	4 x SATA 6Gb/s port (with RAID 0/1/5/10 support)
Expansion	1 x Full-size/Half-size PCIe Mini card slot (with mSATA support) 1 x PCIe x8 slot (PCIe Spec. 3.0)
Environmental and Power Specifications	
Power Supply	AT/ATX power
Power Consumption	3.3V@1.62A, 5V@3.54A, 12V@8.17A, 5VSB@3.6A (Intel® Core™ i7 6700K 4.0GHz CPU with 16 GB (two 8 GB) 2133 MHz DDR4 memory)
Operating Temperature	-20°C ~ 60°C
Storage Temperature	-30°C ~ 70°C
Humidity	5% ~ 95%, non-condensing
Physical Specifications	

Specification	KINO-AQ170
Dimensions	170 mm x 170 mm
Weight GW/NW	900 g / 450 g
<i>*Be sure to refer to Section 3.3.5 for HDMI cable connection.</i>	

Table 1-1: Technical Specifications

Chapter

2

Unpacking

2.1 Anti-static Precautions



WARNING!

Static electricity can destroy certain electronics. Make sure to follow the ESD precautions to prevent damage to the product, and injury to the user.

Make sure to adhere to the following guidelines:

- **Wear an anti-static wristband:** Wearing an anti-static wristband can prevent electrostatic discharge.
- **Self-grounding:** Touch a grounded conductor every few minutes to discharge any excess static buildup.
- **Use an anti-static pad:** When configuring any circuit board, place it on an anti-static mat.
- **Only handle the edges of the PCB:** Don't touch the surface of the motherboard. Hold the motherboard by the edges when handling.

2.2 Unpacking Precautions

When the KINO-AQ170 is unpacked, please do the following:

- Follow the antistatic guidelines above.
- Make sure the packing box is facing upwards when opening.
- Make sure all the packing list items are present.

KINO-AQ170 Industrial Motherboard





2.3 Packing List



NOTE:

If any of the components listed in the checklist below are missing, do not proceed with the installation. Contact the IEI reseller or vendor the KINO-AQ170 was purchased from or contact an IEI sales representative directly by sending an email to sales@ieiworld.com.

The KINO-AQ170 is shipped with the following components:



Quantity	Item and Part Number	Image
1	KINO-AQ170 industrial motherboard	
2	SATA cable, 500 mm	
1	I/O shielding	
1	Quick Installation Guide	

2.4 Optional Items

The following are optional components which may be separately purchased:

Item and Part Number	Image
Dual USB cable (wo bracket), 210 mm, p=2.0 (P/N: 32001-008600-200-RS)	
RS-232 cable, 230 mm (P/N : 32205-002700-200-RS)	
LGA1155/LGA1156 Cooler kit (45W) (P/N: CF-115XC-R10)	
LGA1155/LGA1156 Cooler kit (65W) (P/N: CF-115XD-R10)	
LGA1155/LGA1156 cooler kit (95W) (P/N: CF-115XE-R10)	
DisplayPort to DisplayPort converter board for IEI iDP connector (P/N: DP-DP-R10)	
DisplayPort to DVI-D converter board for IEI iDP connector (P/N: DP-DVI-R10)	

KINO-AQ170 Industrial Motherboard

Item and Part Number	Image
DisplayPort to 24-bit dual-channel LVDS converter board for IEI iDP connector (P/N: DP-LVDS-R10)	
DisplayPort to VGA converter board for IEI iDP connector (P/N: DP-VGA-R10)	
DisplayPort to HDMI converter board for IEI iDP connector (P/N: DP-HDMI-R10)	

Chapter

3

Connectors

KINO-AQ170 Industrial Motherboard

3.1 Peripheral Interface Connectors

This chapter details all the jumpers and connectors.

3.1.1 KINO-AQ170 Layout

The figures below show all the connectors and jumpers.

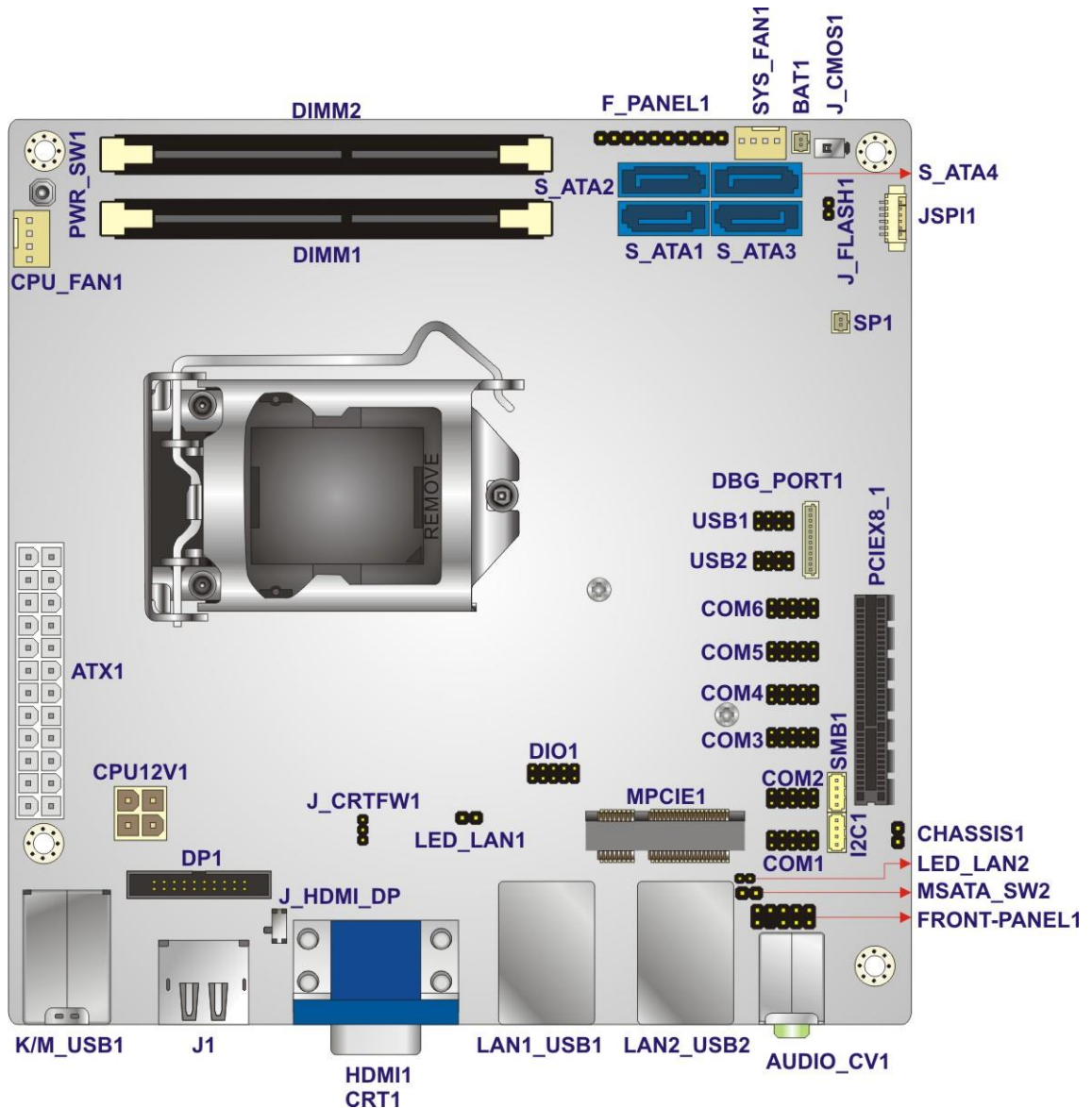

Figure 3-1: Connector and Jumper Locations (Front Side)

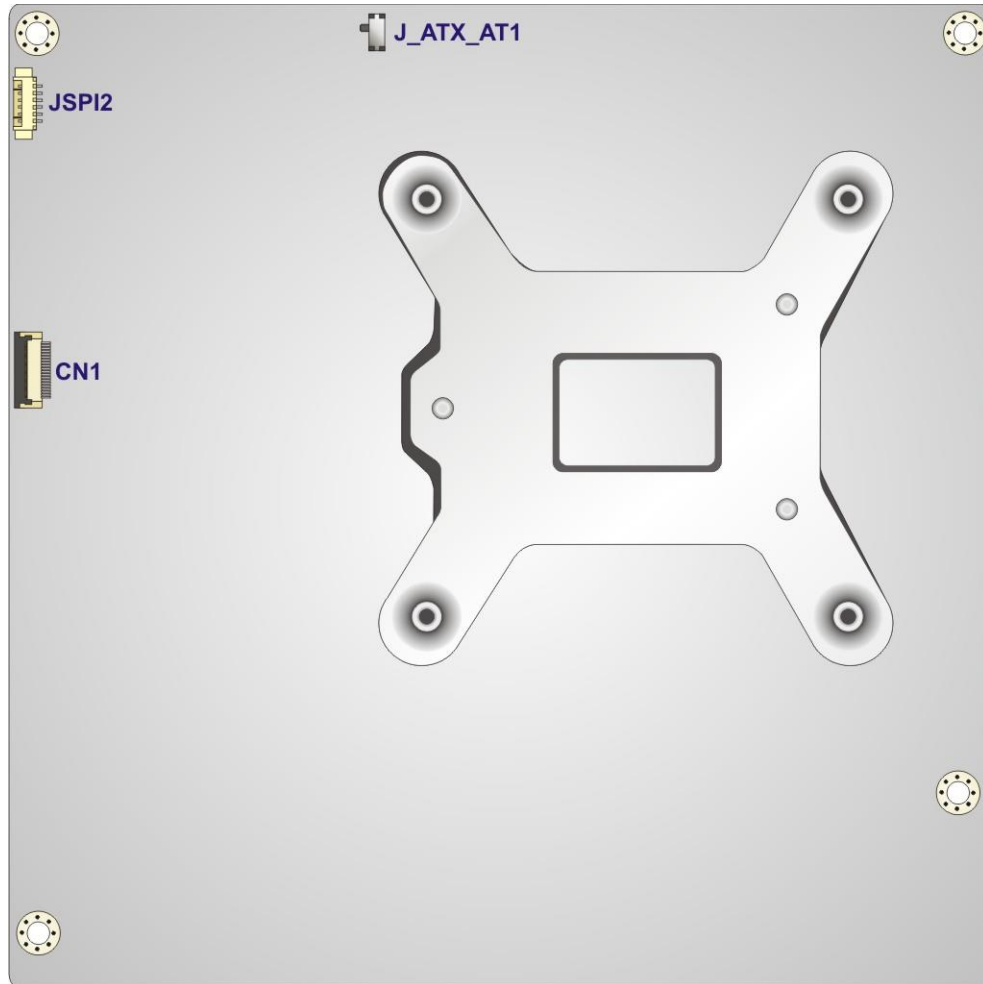

Figure 3-2: Connector and Jumper Locations (Solder Side)

KINO-AQ170 Industrial Motherboard

3.1.2 Peripheral Interface Connectors

The table below lists all the connectors on the board.

Connector	Type	Label
+12V DC-IN power connector	4-pin Molex	CPU12V1
ATX power connector	24-pin connector	ATX1
Audio connector	10-pin header	FRONT-PANEL1
Battery connector	2-pin wafer	BAT1
Buzzer connector	2-pin wafer	SP1
Chassis intrusion connector	2-pin header	CHASSIS1
Debug connector	12-pin wafer	DBG_PORT1
Digital I/O connector	10-pin header	DIO1
EC debug connector	20-pin FPC	CN1
Fan connector, CPU	4-pin wafer	CPU_FAN1
Fan connector, system	4-pin wafer	SYS_FAN1
Front panel connector	10-pin header	F_PANEL1
I ² C connector	4-pin wafer	I2C1
Internal DisplayPort connector	20-pin box header	DP1
LAN link LED connectors	2-pin header	LED_LAN1, LED_LAN2
Memory slot	260-pin DDR4 SO-DIMM	DIMM1, DIMM2
PCIe x8 slot	PCIe x8 slot	PCIEX8_1
PCIe Mini card slot	PCIe Mini slot	MPCIE1
Power button (on board)	Push button	PWR_SW1
RS-232 connectors	10-pin header	COM1, COM2,

		COM3, COM4
RS-232/422/485 connectors	10-pin header	COM5, COM6
SATA 6Gb/s drive connectors	7-pin SATA connector	S_ATA1, S_ATA2, S_ATA3, S_ATA4
SMBus connector	4-pin wafer	SMB1
SPI flash connector, BIOS	6-pin wafer	JSPI1
SPI flash connector, EC	6-pin wafer	JSPI2
USB 2.0 connectors	8-pin header	USB1, USB2
VGA firmware update connector	3-pin header	J_CRTFW1

Table 3-1: Peripheral Interface Connectors

3.1.3 External Interface Panel Connectors

The table below lists the connectors on the external I/O panel.

Connector	Type	Label
Audio jacks	Audio jacks	AUDIO_CV1
Keyboard/Mouse and USB 2.0 connectors	PS/2 and USB Type-A combo connector	K/M_USB1
Ethernet and USB 3.2 Gen 1 connectors	RJ-45 and USB Type-A combo connector	LAN1_USB1, LAN2_USB2
HDMI 2.0 connector	HDMI 2.0 connector	HDMI1
HDMI/DP connector	HDMI+DP connector	J1
VGA connector	15-pin D-sub female connector	CRT1

Table 3-2: Rear Panel Connectors

KINO-AQ170 Industrial Motherboard

3.2 Internal Peripheral Connectors

The section describes all of the connectors on the KINO-AQ170.

3.2.1 +12V DC-IN Power Connector

- CN Label:** CPU12V1
- CN Type:** 4-pin Molex, p=4.2 mm
- CN Location:** See **Figure 3-3**
- CN Pinouts:** See **Table 3-3**

The connector supports the +12V power supply.

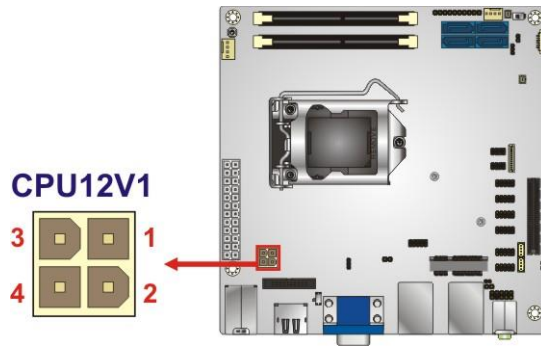

Figure 3-3: +12V DC-IN Power Connector Location

PIN NO.	DESCRIPTION	PIN NO.	DESCRIPTION
1	GND	2	GND
3	+12V	4	+12V

Table 3-3: +12V DC-IN Power Connector Pinouts

3.2.2 ATX Power Connector

- CN Label:** ATX1
- CN Type:** 24-pin connector, p=4.2 mm
- CN Location:** See **Figure 3-4**
- CN Pinouts:** See **Table 3-4**

The ATX power connector connects to an ATX power supply.

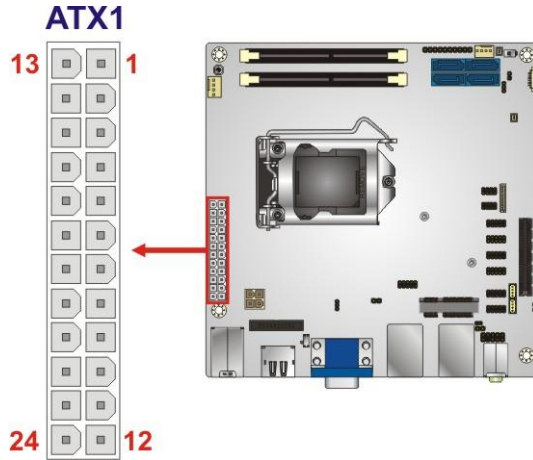

Figure 3-4: ATX Power Connector Location

Pin	Description	Pin	Description
1	+3.3 V	13	+3.3 V
2	+3.3 V	14	-12 V
3	GND	15	GND
4	+5 V	16	PS-ON
5	GND	17	GND
6	+5 V	18	GND
7	GND	19	GND
8	Power good	20	-5 V
9	5VSB	21	+5 V
10	+12 V	22	+5 V
11	+12 V	23	+5 V
12	+3.3 V	24	GND

Table 3-4: ATX Power Connector Pinouts

KINO-AQ170 Industrial Motherboard

3.2.3 Audio Connector

- CN Label:** FRONT-PANEL1
- CN Type:** 10-pin header, p=2.54 mm
- CN Location:** See **Figure 3-5**
- CN Pinouts:** See **Table 3-5**

The audio connector is connected to external audio devices including speakers and microphones for the input and output of audio signals to and from the system.

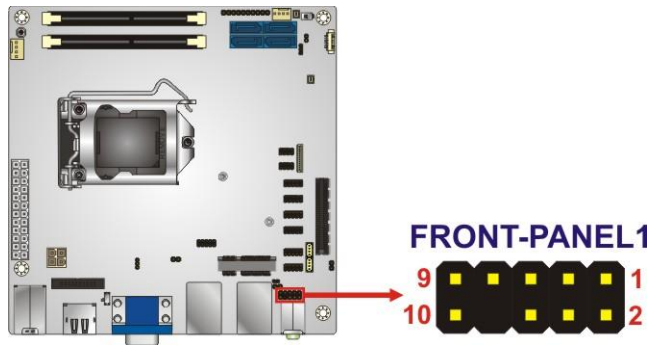

Figure 3-5: Audio Connector Location

PIN NO.	DESCRIPTION	PIN NO.	DESCRIPTION
1	LMIC2-L	2	AUD_GND
3	LMIC2-R	4	PRESENCE#
5	LLINE2-R	6	MIC2-JD
7	FRONT-IO	8	NC
9	LLINE2-L	10	LINE2-JD

Table 3-5: Audio Connector Pinouts

3.2.4 Battery Connector

**CAUTION:**

Risk of explosion if battery is replaced by an incorrect type. Only certified engineers should replace the on-board battery.

Dispose of used batteries according to instructions and local regulations.

CN Label:	BAT1
CN Type:	2-pin wafer, p=1.25 mm
CN Location:	See Figure 3-6
CN Pinouts:	See Table 3-6

The battery connector is connected to the system battery. The battery provides power to the system clock to retain the time when power is turned off. **NOTE:** It is recommended to attach the RTC battery onto the system chassis in which the KINO-AQ170 is installed.

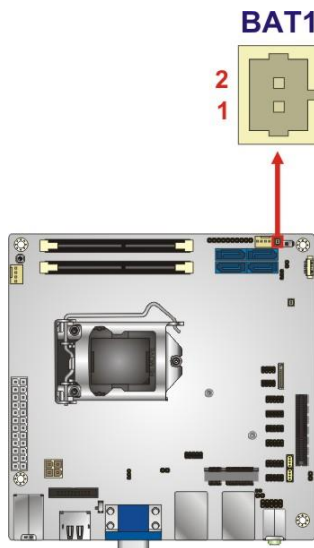

Figure 3-6: Battery Connector Location

KINO-AQ170 Industrial Motherboard

Pin	Description
1	VBAT+
2	GND

Table 3-6: Battery Connector Pinouts

3.2.5 Buzzer Connector

- CN Label:** SP1
- CN Type:** 2-pin wafer, p=1.25 mm
- CN Location:** See **Figure 3-7**
- CN Pinouts:** See **Table 3-7**

The buzzer connector is connected to the buzzer. **NOTE:** If you cannot find a good place to put a buzzer on the KINO-AQ170, it is recommended to attach the buzzer onto the system chassis in which the KINO-AQ170 is installed.

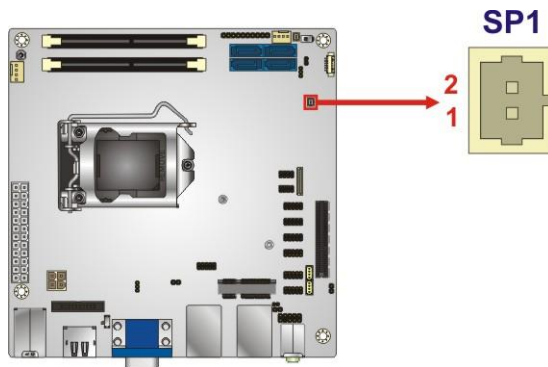

Figure 3-7: Buzzer Connector Location

Pin	Description
1	Buzzer+
2	Buzzer-

Table 3-7: Buzzer Connector Pinouts

3.2.6 Chassis Intrusion Connector

- CN Label:** CHASSIS1
- CN Type:** 2-pin header, p=2.54 mm
- CN Location:** See **Figure 3-8**
- CN Pinouts:** See **Table 3-8**

The chassis intrusion connector is for a chassis intrusion detection sensor or switch that detects if a chassis component is removed or replaced.

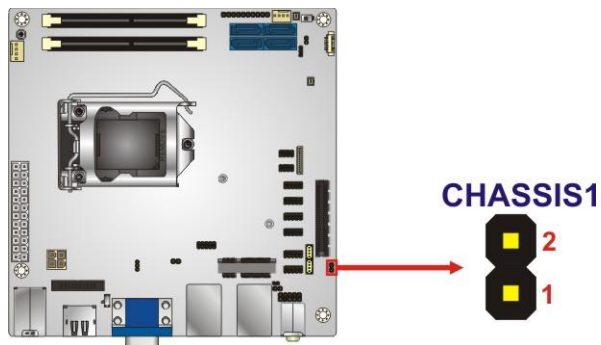

Figure 3-8: Chassis Intrusion Connector Location

Pin	Description
1	+3.3VSB
2	Chassis open

Table 3-8: Chassis Intrusion Connector Pinouts

KINO-AQ170 Industrial Motherboard

3.2.7 Debug Connector

- CN Label:** **DBG_PORT1**
- CN Type:** 12-pin wafer, p=1.00 mm
- CN Location:** See **Figure 3-9**
- CN Pinouts:** See **Table 3-9**

The debug connector is used for debug.

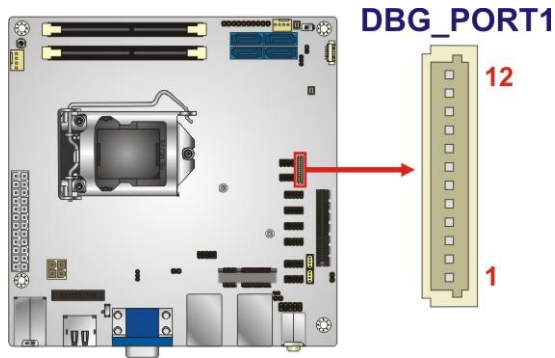

Figure 3-9: Debug Connector Location

Pin	Description	Pin	Description
1	+5V	7	LPC_AD1
2	+3.3V	8	LPC_AD0
3	GND	9	LPC_FRAME#
4	INT_SERIRQ	10	PLT_GATED_RST#_X8
5	LPC_AD3	11	CLK_PCI_TPM
6	LPC_AD2	12	GND

Table 3-9: Debug Connector Pinouts

3.2.8 Digital I/O Connector

- CN Label:** DIO1
- CN Type:** 10-pin header, p=2.00 mm
- CN Location:** See **Figure 3-10**
- CN Pinouts:** See **Table 3-10**

The 8-bit digital I/O connector provides programmable input and output for external devices.

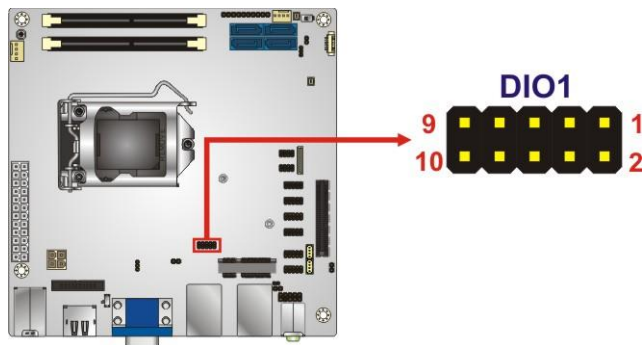

Figure 3-10: Digital I/O Connector Location

PIN NO.	DESCRIPTION	PIN NO.	DESCRIPTION
1	GND	2	VCC
3	DOUT3	4	DOUT2
5	DOUT1	6	DOUT0
7	DIN3	8	DIN2
9	DIN1	10	DIN0

Table 3-10: Digital I/O Connector Pinouts

KINO-AQ170 Industrial Motherboard

3.2.9 EC Debug Connector

- CN Label:** CN1
- CN Type:** 20-pin FPC, p=0.5 mm
- CN Location:** See **Figure 3-11**
- CN Pinouts:** See **Table 3-11**

The EC debug connector is used for EC debug.

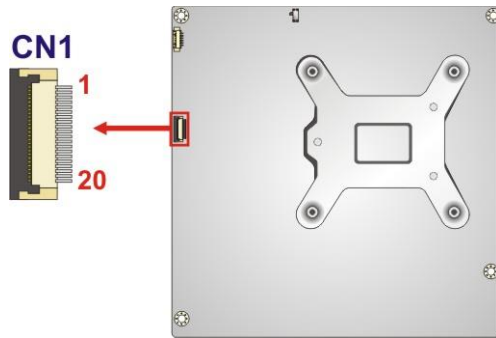

Figure 3-11: EC Debug Connector Location

Pin	Description	Pin	Description
1	EC_EPP_STB#	11	EC_EPP_BUSY
2	EC_EPP_PD0	12	EC_EPP_KSI5
3	EC_EPP_PD1	13	EC_EPP_KSI4
4	EC_EPP_PD2	14	EC_EPP_AFD#
5	EC_EPP_PD3	15	NC
6	EC_EPP_PD4	16	EC_EPP_INIT#
7	EC_EPP_PD5	17	EC_EPP_SLIN#
8	EC_EPP_PD6	18	GND
9	EC_EPP_PD7	19	GND
10	NC	20	GND

Table 3-11: EC Debug Connector Pinouts

3.2.10 Fan Connectors

CN Label: CPU_FAN1, SYS_FAN1

CN Type: 4-pin wafer, p=2.54 mm

CN Location: See **Figure 3-12**

CN Pinouts: See **Table 3-12**

The fan connector attaches to a cooling fan.

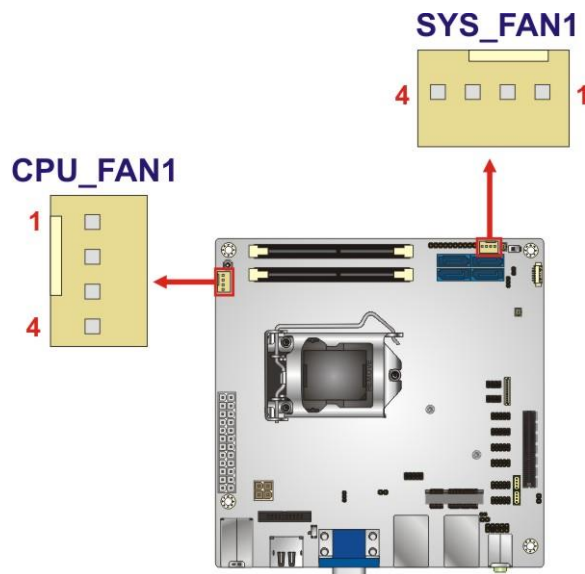

Figure 3-12: Fan Connector Locations

Pin	Description
1	GND
2	+12V
3	FANIO
4	PWM

Table 3-12: Fan Connector Pinouts

KINO-AQ170 Industrial Motherboard

3.2.11 Front Panel Connector

- CN Label:** F_PANEL1
- CN Type:** 10-pin header, p=2.54 mm
- CN Location:** See **Figure 3-13**
- CN Pinouts:** See **Table 3-13**

The front panel connector connects to the indicator LEDs and buttons on the computer's front panel.

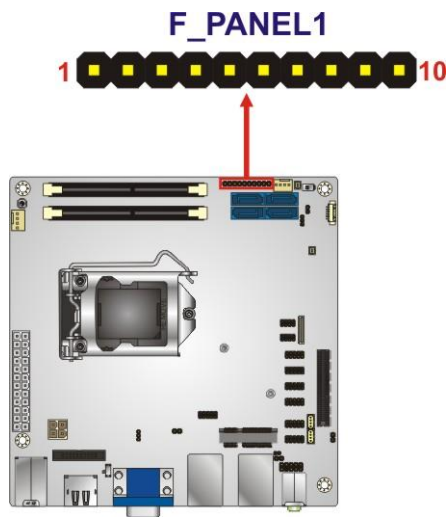

Figure 3-13: Front Panel Connector Location

Function	Pin	Description	Function	Pin	Description
	1	NC	Power LED	6	PWR_LED+
Power Button	2	PWR_BTN+		7	PWR_LED+
	3	PWR_BTN-		8	PWR_LED-
HDD LED	4	HDD_LED+	Reset	9	RESET+
	5	HDD_LED-		10	RESET-

Table 3-13: Front Panel Connector Pinouts

3.2.12 I²C Connector

- CN Label:** I2C1
- CN Type:** 4-pin wafer, p=1.25 mm
- CN Location:** See **Figure 3-14**
- CN Pinouts:** See **Table 3-14**

The I²C connector is used to connect I²C-bus devices to the motherboard.

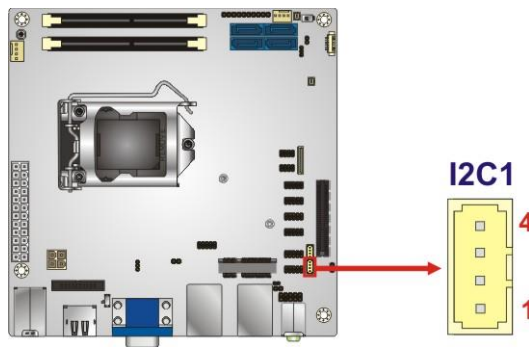

Figure 3-14: I²C Connector Location

Pin	Description
1	GND
2	I2C_DAT
3	I2C_CLK
4	+5V

Table 3-14: I²C Connector Pinouts

KINO-AQ170 Industrial Motherboard

3.2.13 Internal DisplayPort Connector

- CN Label:** DP1
- CN Type:** 20-pin box header, p=2.00 mm
- CN Location:** See **Figure 3-15**
- CN Pinouts:** See **Table 3-15**

The internal DisplayPort (iDP) connector supports HDMI, LVDS, VGA, DVI and DisplayPort devices with up to 2560x1600 resolutions.

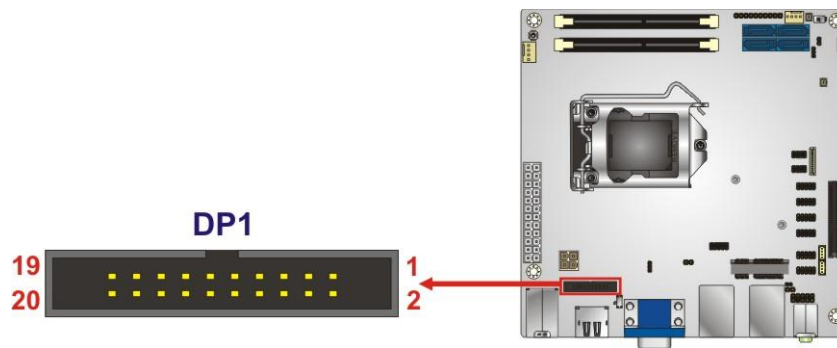

Figure 3-15: Internal DisplayPort Connector Location

Pin	Description	Pin	Description
1	+5V	11	AUXP
2	LANE1N	12	AUXN
3	LANE1P	13	GND
4	GND	14	LANE2P
5	LANE3N	15	LANE2N
6	LANE3P	16	GND
7	GND	17	LANE0P
8	AUX_CTRL_DET_D	18	LANE0N
9	GND	19	+3.3V
10	HPD	20	NC

Table 3-15: Internal DisplayPort Connector Pinouts

3.2.14 LAN LED Connectors

CN Label: LED_LAN1, LED_LAN2

CN Type: 2-pin header, p=2.54 mm

CN Location: See **Figure 3-16**

CN Pinouts: See **Table 3-16**

The LAN LED connectors connect to the LAN link LEDs on the system.

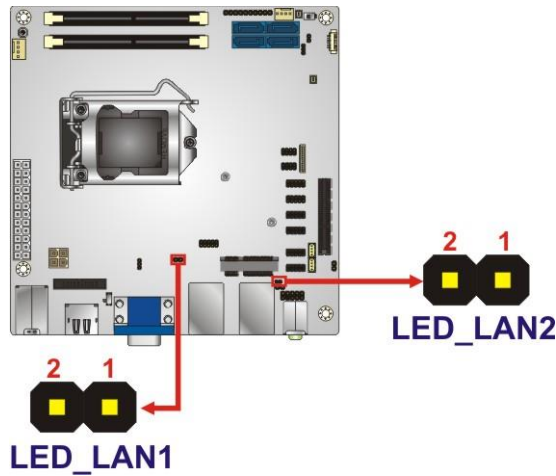

Figure 3-16: LAN LED Connector Locations

Pin	Description
1	+3.3V
2	LAN_LED_LINK#_ACT

Table 3-16: LAN LED Connector Pinouts

KINO-AQ170 Industrial Motherboard

3.2.15 PCI Express x8 Slot

- CN Label:** **PCIEX8_1**
- CN Type:** **PCIe x8 slot**
- CN Location:** **See Figure 3-17**
- CN Pinouts:** **See Table 3-17**

The PCIe x8 expansion card slot is for PCIe x8 expansion cards.

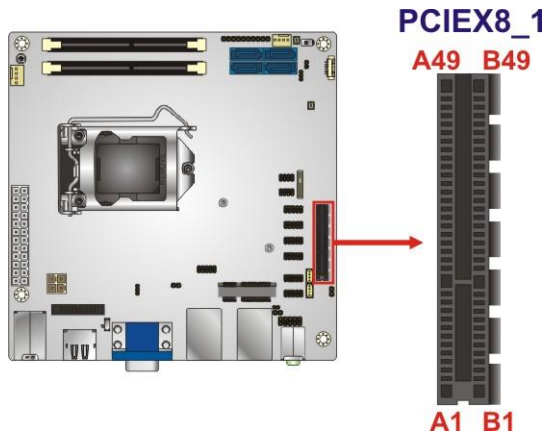

Figure 3-17: PCIe x8 Slot Location

Pin	Description	Pin	Description
A1	+12V	B1	PRSNT#1
A2	+12V	B2	+12V
A3	+12V	B3	+12V
A4	GND	B4	GND
A5	SMCLK	B5	JTAG2
A6	SMDAT	B6	JTAG3
A7	GND	B7	JTAG4
A8	+3.3V	B8	JTAG5
A9	JTAG1	B9	+3.3V
A10	3.3 Vaux	B10	+3.3V
A11	WAKE#	B11	PWRGD
A12	RSVD	B12	GND

Pin	Description	Pin	Description
A13	GND	B13	REFCLK+
A14	HSOp(0)	B14	REFCLK-
A15	HSOn(0)	B15	GND
A16	GND	B16	HSIp(0)
A17	PRSNT#2	B17	HSIn(0)
A18	GND	B18	GND
A19	HSOp(1)	B19	RSVD
A20	HSOn(1)	B20	GND
A21	GND	B21	HSIp(1)
A22	GND	B22	HSIn(1)
A23	HSOp(2)	B23	GND
A24	HSOn(2)	B24	GND
A25	GND	B25	HSIp(2)
A26	GND	B26	HSIn(2)
A27	HSOp(3)	B27	GND
A28	HSOn(3)	B28	GND
A29	GND	B29	HSIp(3)
A30	RSVD	B30	HSIn(3)
A31	PRSNT#2	B31	GND
A32	GND	B32	RSVD
A33	HSOp(4)	B33	RSVD
A34	HSOn(4)	B34	GND
A35	GND	B35	HSIp(4)
A36	GND	B36	HSIn(4)
A37	HSOp(5)	B37	GND
A38	HSOn(5)	B38	GND
A39	GND	B39	HSIp(5)
A40	GND	B40	HSIn(5)
A41	HSOp(6)	B41	GND
A42	HSOn(6)	B42	GND
A43	GND	B43	HSIp(6)
A44	GND	B44	HSIn(6)

KINO-AQ170 Industrial Motherboard

Pin	Description	Pin	Description
A45	HSOp(7)	B45	GND
A46	HSOn(7)	B46	GND
A47	GND	B47	HSIp(7)
A48	PRSNT#2	B48	HSIn(7)
A49	GND	B49	GND

Table 3-17: PCIe x8 Slot Pinouts

3.2.16 PCIe Mini Card Slot

CN Label:	MPCIE1
CN Type:	Full-size/Half-size PCIe Mini card slot
CN Location:	See Figure 3-18
CN Pinouts:	See Table 3-18

The PCIe Mini card slot supports PCIe Mini cards with USB interface, including mSATA modules.



NOTE:

If the mSATA module installed on the KINO-AQ170 can not be automatically detected, please set MPCIE1 as an mSATA slot manually by using the MSATA_SW2 jumper. Please refer to **Section 4.7.5**.

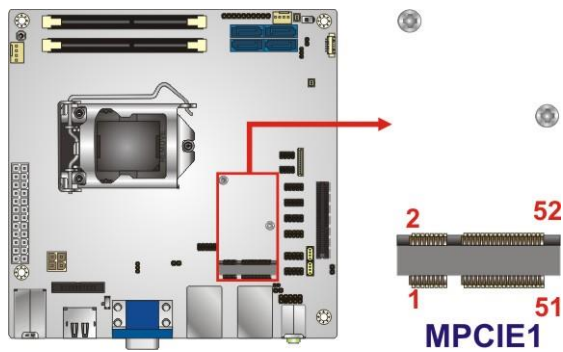

Figure 3-18: PCIe Mini Card Slot Location

Pin	Description	Pin	Description
1	PCIE_WAKE#	2	VCC3
3	N/C	4	GND
5	N/C	6	1.5V
7	N/C	8	N/C
9	GND	10	N/C
11	PCIE_CLK#	12	N/C
13	PCIE_CLK	14	N/C
15	GND	16	N/C
17	N/C	18	GND
19	N/C	20	N/C
21	GND	22	PCIRST#
23	PCIE_RXN	24	VCC3
25	PCIE_RXP	26	GND
27	GND	28	1.5V
29	GND	30	SMBCLK
31	PCIE_TXN	32	SMBDATA
33	PCIE_TXP	34	GND
35	GND	36	USBD-
37	GND	38	USBD+
39	VCC3	40	GND
41	VCC3	42	N/C
43	GND	44	N/C

KINO-AQ170 Industrial Motherboard

Pin	Description	Pin	Description
45	N/C	46	N/C
47	N/C	48	1.5V
49	N/C	50	GND
51	M-SATA Detect	52	VCC3

Table 3-18: PCIe Mini Card Slot Pinouts

3.2.17 Power Button

CN Label: PWR_SW1

CN Type: Push button

CN Location: See **Figure 3-19**

The on-board power button controls system power.

PWR_SW1

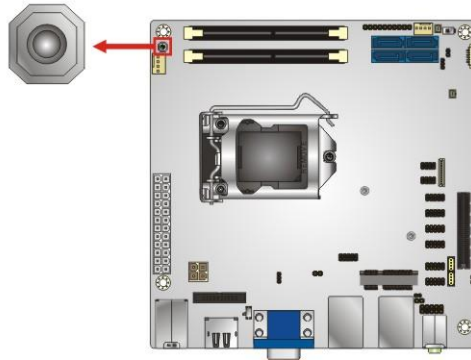

Figure 3-19: Power Button Location

3.2.18 RS-232 Serial Port Connectors

CN Label: COM1, COM2, COM3, COM4

CN Type: 10-pin header, p=2.00 mm

CN Location: See **Figure 3-20**

CN Pinouts: See **Table 3-19**

The serial connector provides RS-232 connection.

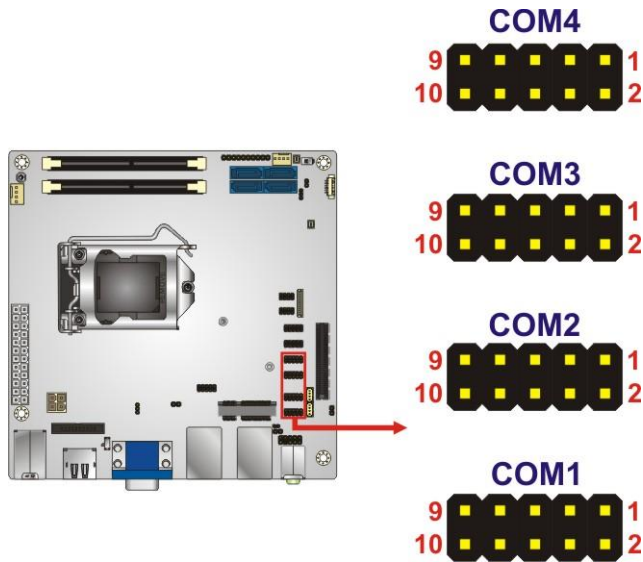

Figure 3-20: RS-232 Connector Locations

PIN NO.	DESCRIPTION	PIN NO.	DESCRIPTION
1	DCD	2	DSR
3	RXD	4	RTS
5	TXD	6	CTS
7	DTR	8	RI
9	GND	10	GND

Table 3-19: RS-232 Connector Pinouts

KINO-AQ170 Industrial Motherboard

3.2.19 RS-232/422/485 Serial Port Connectors

- CN Label:** COM5, COM6
- CN Type:** 10-pin header, p=2.00 mm
- CN Location:** See **Figure 3-21**
- CN Pinouts:** See **Table 3-20**

This connector provides RS-232, RS-422 or RS-485 communications. The default mode is set to RS-232 in BIOS. To configure the connector as RS-422 or RS-485, please refer to **Section 5.3.3.1.5 (COM5)** and **Section 5.3.3.1.6 (COM6)**.

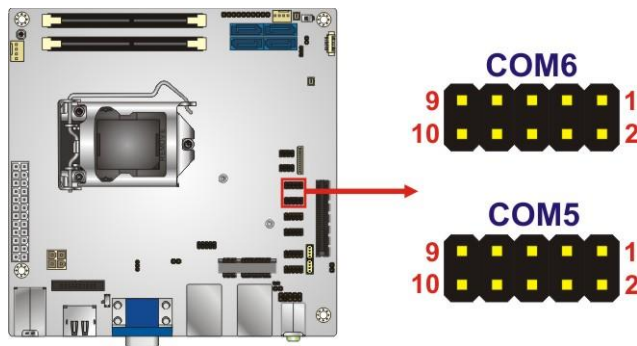

Figure 3-21: RS-232/422/485 Connector Locations

PIN NO.	DESCRIPTION	PIN NO.	DESCRIPTION
1	DCD	2	DSR
3	RXD	4	RTS
5	TXD	6	CTS
7	DTR	8	RI
9	GND	10	GND

Table 3-20: RS-232/422/485 Connector Pinouts

Use the optional RS-232/422/485 cable to connect to a serial device. The pinouts of the DB-9 connector are listed below.

RS-232 Pinouts	RS-422 Pinouts	RS-485 Pinouts

Table 3-21: DB-9 RS-422/485 Pinouts

3.2.20 SATA 6Gb/s Drive Connectors

CN Label: S_ATA1, S_ATA2, S_ATA3, S_ATA4

CN Type: 7-pin SATA connector

CN Location: See **Figure 3-22**

The SATA 6Gb/s drive connector is connected to a SATA 6Gb/s drive. The SATA 6Gb/s drive transfers data at speeds as high as 6Gb/s.

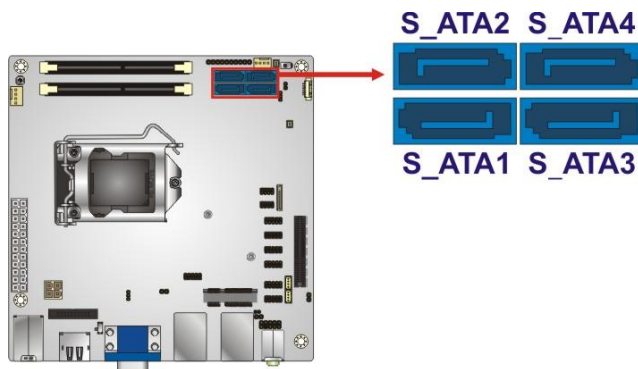

Figure 3-22: SATA 6Gb/s Drive Connector Locations

KINO-AQ170 Industrial Motherboard

3.2.21 SMBus Connector

- CN Label:** SMB1
- CN Type:** 4-pin wafer, p=1.25 mm
- CN Location:** See **Figure 3-23**
- CN Pinouts:** See **Table 3-22**

The SMBus (System Management Bus) connector provides low-speed system management communications.

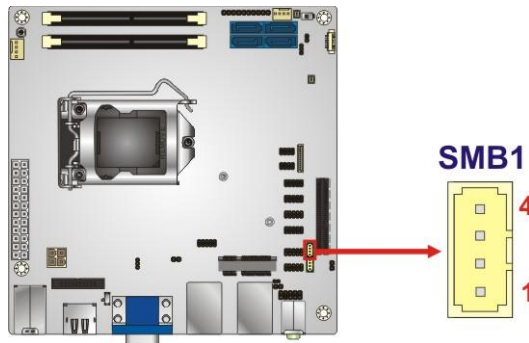

Figure 3-23: SMBus Connector Location

Pin	Description
1	GND
2	SMB_DATA
3	SMB_CLK
4	+5V

Table 3-22: SMBus Connector Pinouts

3.2.22 SPI Flash Connector, BIOS

- CN Label:** JSPI1
- CN Type:** 6-pin wafer, p=1.25 mm
- CN Location:** See **Figure 3-24**
- CN Pinouts:** See **Table 3-23**

The 6-pin SPI Flash connector is used to flash the BIOS.

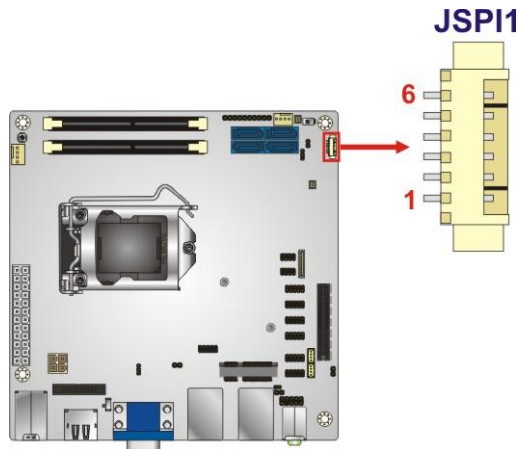

Figure 3-24: SPI Flash Connector Location

Pin	Description
1	+3.3VA
2	SPI_CS
3	SPI_SO_SW
4	SPI_CLK_SW
5	SPI_SI_SW
6	GND

Table 3-23: SPI Flash Connector Pinouts

KINO-AQ170 Industrial Motherboard

3.2.23 SPI Flash Connector, EC

- CN Label:** JSPI2
- CN Type:** 6-pin wafer, p=1.25 mm
- CN Location:** See **Figure 3-25**
- CN Pinouts:** See **Table 3-24**

The 6-pin SPI Flash connector is used to flash the embedded controller.

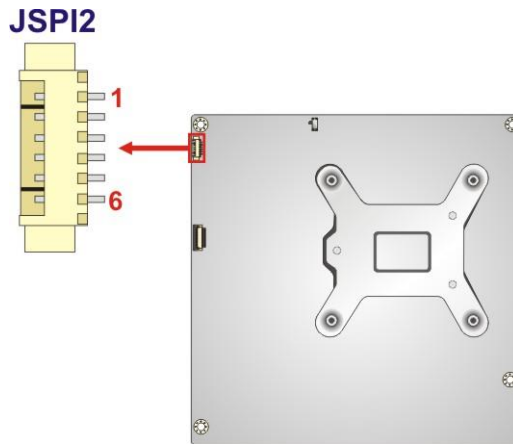

Figure 3-25: SPI Flash Connector Location

Pin	Description
1	+3.3VA
2	SPI_CS#0_CN_EC
3	SPI_SO_SW_EC
4	SPI_CLK_SW_EC
5	SPI_SI_SW_EC
6	GND

Table 3-24: SPI Flash Connector Pinouts

3.2.24 USB Connectors

- CN Label:** USB1, USB2
- CN Type:** 8-pin header, p=2.00 mm
- CN Location:** See **Figure 3-26**
- CN Pinouts:** See **Table 3-25**

The USB connector provides two USB 2.0 ports by dual-port USB cable.

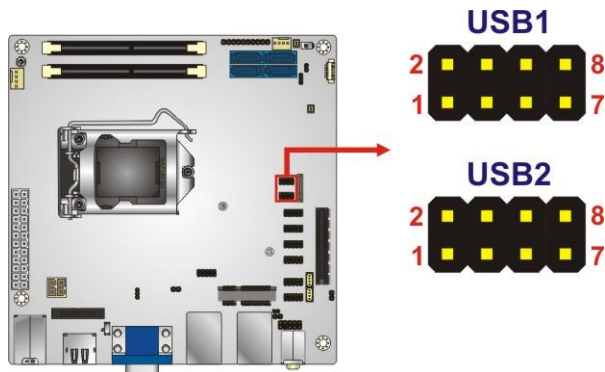

Figure 3-26: USB Connector Locations

PIN NO.	DESCRIPTION	PIN NO.	DESCRIPTION
1	VCC	2	GND
3	USB_DATA-	4	USB_DATA+
5	USB_DATA+	6	USB_DATA-
7	GND	8	VCC

Table 3-25: USB Connector Pinouts

KINO-AQ170 Industrial Motherboard

3.2.25 VGA Firmware Update Connector

- CN Label:** J_CRTFW1
- CN Type:** 3-pin header, p=2.00 mm
- CN Location:** See **Figure 3-27**
- CN Pinouts:** See **Table 3-26**

The 3-pin connector is used to update the VGA firmware.

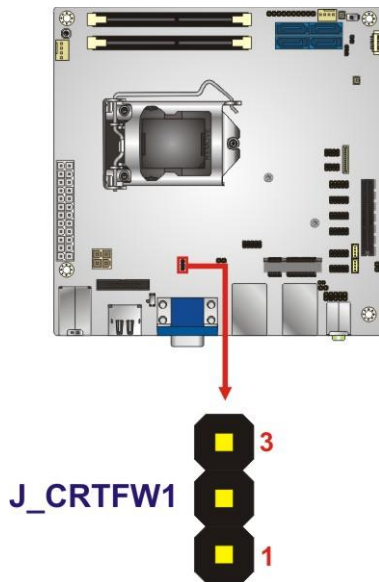

Figure 3-27: VGA Firmware Update Connector Location

Pin	Description
1	SMB_CLK
2	SMB_DATA
3	GND

Table 3-26: VGA Firmware Update Connector Pinouts

3.3 External Peripheral Interface Connector Panel

Figure 3-28 shows the KINO-AQ170 external peripheral interface connector (EPIC) panel.

The EPIC panel consists of the following:

- 2 x Audio jacks (line-out, mic-in)
- 2 x GbE connector
- 1 x Keyboard/Mouse connector
- 1 x HDMI 2.0 connector
- 1 x HDMI/DP connector
- 2 x USB 2.0 connector
- 4 x USB 3.2 Gen 1 (5Gb/s) connector
- 1 x VGA connector

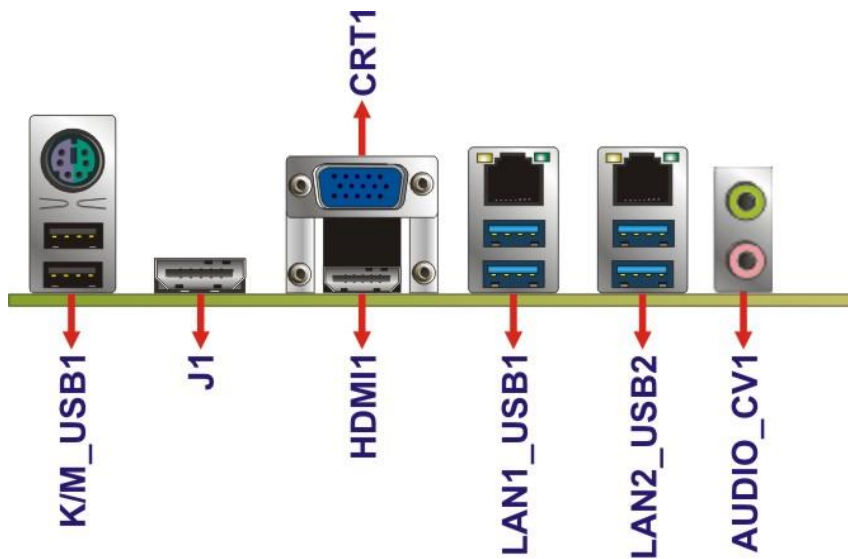

Figure 3-28: External Peripheral Interface Connector

KINO-AQ170 Industrial Motherboard

3.3.1 Audio Connector

- CN Label:** AUDIO_CV1
CN Type: Audio jacks
CN Location: See **Figure 3-28**

The audio jacks connect to external audio devices.

- **Line Out port (Lime):** Connects to a headphone or a speaker. With multi-channel configurations, this port can also connect to front speakers.
- **Microphone (Pink):** Connects a microphone.



Figure 3-29: Audio Connector

3.3.2 Keyboard/Mouse and USB 2.0 Combo Connector

- CN Label:** K/M_USB1
CN Type: PS/2 and USB 2.0 connector
CN Location: See **Figure 3-28**
CN Pinouts: See **Table 3-27** and **Table 3-28**

The USB 2.0 connector can be connected to a USB device.

Pin	Description	Pin	Description
1	VCC	5	VCC
2	USB_DATA-	6	USB_DATA-
3	USB_DATA+	7	USB_DATA+
4	GND	8	GND

Table 3-27: USB 2.0 Port Pinouts

The keyboard and mouse connector is a standard PS/2 connector.

Pin	Description
9	GND
10	KB DATA
11	MS DATA
12	VCC
13	KB CLOCK
14	MS CLOCK

Table 3-28: Keyboard/Mouse Connector Pinouts

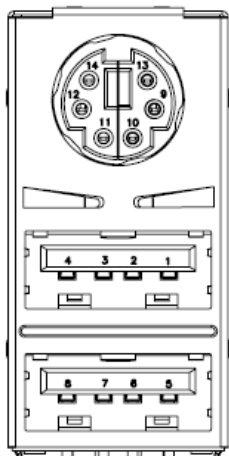

Figure 3-30: Keyboard/Mouse and USB 2.0 Combo Connector

3.3.3 Ethernet and USB 3.2 Gen 1 Combo Connectors

- CN Label:** LAN1_USB1, LAN2_USB2
- CN Type:** RJ-45 and USB Type-A connector
- CN Location:** See **Figure 3-28**
- CN Pinouts:** See **Table 3-29** and **Table 3-31**

A 10/100/1000 Mb/s connection can be made to a Local Area Network.

Pin	Description	Pin	Description
1	LAN1_MDI0P	5	LAN1_MDI2P

KINO-AQ170 Industrial Motherboard

Pin	Description	Pin	Description
2	LAN1_MDI0N	6	LAN1_MDI2N
3	LAN1_MDI1P	7	LAN1_MDI3P
4	LAN1_MDI1N	8	LAN1_MDI3N

Table 3-29: Ethernet Connector Pinouts

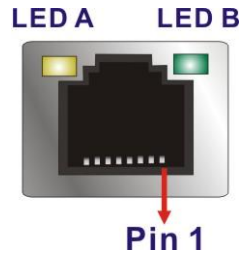

Figure 3-31: Ethernet Connector

LED	Description	LED	Description
A	on: linked blinking: data is being sent/received	B	off: 10 Mb/s green: 100 Mb/s orange: 1000 Mb/s

Table 3-30: Connector LEDs

The USB 3.2 Gen 1 (5Gb/s) connector can be connected to a USB device.

Pin	Description	Pin	Description
1	VCC	10	VCC
2	USB_DATA-	11	USB_DATA-
3	USB_DATA+	12	USB_DATA+
4	GND	13	GND
5	USB3_RX-	14	USB3_RX-
6	USB3_RX+	15	USB3_RX+
7	GND	16	GND
8	USB3_TX-	17	USB3_TX-
9	USB3_TX+	18	USB3_TX+

Table 3-31: USB 3.2 Gen 1 Port Pinouts

3.3.4 HDMI 2.0 Connector

- CN Label:** HDMI1
- CN Type:** HDMI 2.0 connector
- CN Location:** See **Figure 3-28**
- CN Pinouts:** See **Table 3-32**

The HDMI 1 connector supports HDMI 2.0 devices.

Pin	Description	Pin	Description
1	HDMI_DATA2	2	GND
3	HDMI_DATA2#	4	HDMI_DATA1
5	GND	6	HDMI_DATA1#
7	HDMI_DATA0	8	GND
9	HDMI_DATA0#	10	HDMI_CLK
11	GND	12	HDMI_CLK#
13	N/C	14	N/C
15	HDMI_SCL	16	HDMI_SDA
17	GND	18	+5V
19	HDMI_HPD		

Table 3-32: HDMI Connector Pinouts

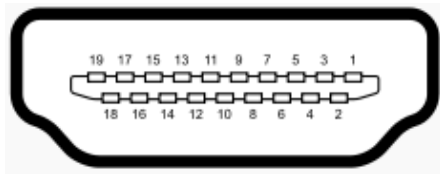

Figure 3-32: HDMI Connector Pinout Locations

KINO-AQ170 Industrial Motherboard

3.3.5 HDMI/DP Connector

CN Label:	J1
CN Type:	HDMI+DP connector
CN Location:	See Figure 3-28
CN Pinouts:	See Table 3-33

The DisplayPort and HDMI combo connector can connect to a DisplayPort (default) or HDMI device. The selection is made through a switch (J_HDMI_DP) on the board. Please refer to **Section 4.7.4** for detailed information. The HDMI/DP connector supports DisplayPort 1.2 and HDMI devices. The maximum output resolution of HDMI is 1920x1080.



WARNING:

This HDMI/DP connector has a mistake-proofing design (see Figure 3-33) to ensure the pins on the HDMI cable can be correctly matched with those on the connector when connected.

Be sure to keep aligning the right side of the connector while plugging or unplugging an HDMI cable into it. Do not force the cable if it does not plug in. Failure to do so may damage the mistake-proofing pin and the HDMI cable.

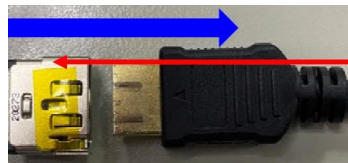

For DP connection, just plug in as normal because the connector size is the same as the DisplayPort cable.

Pin	HDMI	Display Port
1	TMDS DATA2+	L0P
2	GND	GND
3	TMDS DATA2-	L0N
4	TMDS DATA1+	L1P
5	GND	GND
6	TMDS DATA1-	L1N
7	TMDS DATA0+	L2P
8	GND	GND
9	TMDS DATA0-	L2N
10	TMDS CLK+	L3P
11	GND	GND
12	TMDS CLK-	L3N
13	CEC	GND
14	NC	GND
15	SCL	AUXP
16	SDA	GND
17	GND	AUXN
18	HDMI PWR	HPD
19	HPD	PWR RTN
20	NC	DP PWR

Table 3-33: HDMI/DP Connector Pinouts

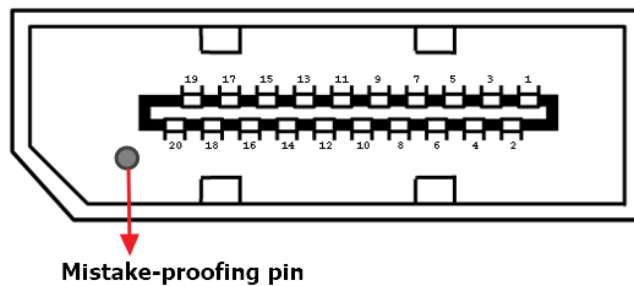

Figure 3-33: HDMI/DP Connector Pinout Locations

KINO-AQ170 Industrial Motherboard

3.3.6 VGA Connector

- CN Label:** CRT1
CN Type: 15-pin Female
CN Location: See **Figure 3-28**
CN Pinouts: See **Table 3-34**

The VGA connector connects to a monitor that accepts a standard VGA input.

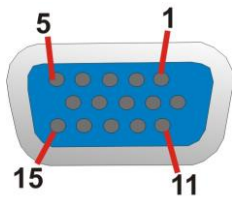

Figure 3-34: VGA Connector

Pin	Description	Pin	Description
1	RED	2	GREEN
3	BLUE	4	NC
5	GND	6	GND
7	GND	8	GND
9	VCC / NC	10	GND
11	NC	12	DDC DAT
13	HSYNC	14	VSYNC
15	DDCCLK		

Table 3-34: VGA Connector Pinouts



NOTE:

The VGA connector does not support hot plug function. The user must connect the VGA cable to the monitor and the KINO-AQ170 before powering up the KINO-AQ170.

Chapter

4

Installation

KINO-AQ170 Industrial Motherboard

4.1 Anti-static Precautions



WARNING:

Failure to take ESD precautions during the installation of the KINO-AQ170 may result in permanent damage to the KINO-AQ170 and severe injury to the user.

Electrostatic discharge (ESD) can cause serious damage to electronic components, including the KINO-AQ170. Dry climates are especially susceptible to ESD. It is therefore critical that whenever the KINO-AQ170 or any other electrical component is handled, the following anti-static precautions are strictly adhered to.

- **Wear an anti-static wristband:** Wearing a simple anti-static wristband can help to prevent ESD from damaging the board.
- **Self-grounding** Before handling the board, touch any grounded conducting material. During the time the board is handled, frequently touch any conducting materials that are connected to the ground.
- **Use an anti-static pad:** When configuring the KINO-AQ170, place it on an anti-static pad. This reduces the possibility of ESD damaging the KINO-AQ170.
- **Only handle the edges of the PCB:** When handling the PCB, hold the PCB by the edges.

4.2 Installation Considerations



NOTE:

The following installation notices and installation considerations should be read and understood before installation. All installation notices must be strictly adhered to. Failing to adhere to these precautions may lead to severe damage and injury to the person performing the installation.

**WARNING:**

The installation instructions described in this manual should be carefully followed in order to prevent damage to the KINO-AQ170, KINO-AQ170 components and injury to the user.

Before and during the installation please **DO** the following:

- Read the user manual:
 - The user manual provides a complete description of the KINO-AQ170 installation instructions and configuration options.
- Wear an electrostatic discharge cuff (ESD):
 - Electronic components are easily damaged by ESD. Wearing an ESD cuff removes ESD from the body and helps prevent ESD damage.
- Place the KINO-AQ170 on an antistatic pad:
 - When installing or configuring the motherboard, place it on an antistatic pad. This helps to prevent potential ESD damage.
- Turn all power to the KINO-AQ170 off:
 - When working with the KINO-AQ170, make sure that it is disconnected from all power supplies and that no electricity is being fed into the system.

Before and during the installation of the KINO-AQ170 **DO NOT:**

- Remove any of the stickers on the PCB board. These stickers are required for warranty validation.
- Use the product before verifying all the cables and power connectors are properly connected.
- Allow screws to come in contact with the PCB circuit, connector pins, or its components.

KINO-AQ170 Industrial Motherboard

4.3 Socket LGA1151 CPU Installation



WARNING:

CPUs are expensive and sensitive components. When installing the CPU please be careful not to damage it in anyway. Make sure the CPU is installed properly and ensure the correct cooling kit is properly installed.

DO NOT touch the pins at the bottom of the CPU. When handling the CPU, only hold it on the sides.

To install the CPU, follow the steps below.

Step 1: Disengage the load lever by pressing the lever down and slightly outward to clear the retention tab. Fully open the lever. See **Figure 4-1**.

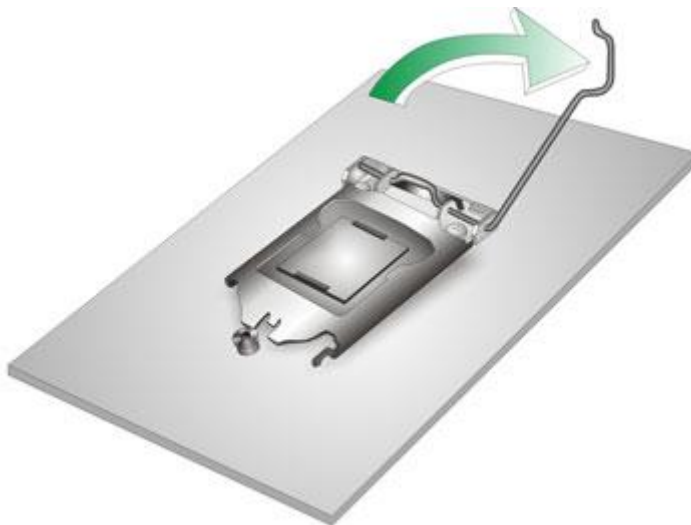

Figure 4-1: Disengage the CPU Socket Load Lever

Step 2: Open the socket and remove the protective cover. The black protective cover can be removed by pulling up on the tab labeled "Remove". See **Figure 4-2**.

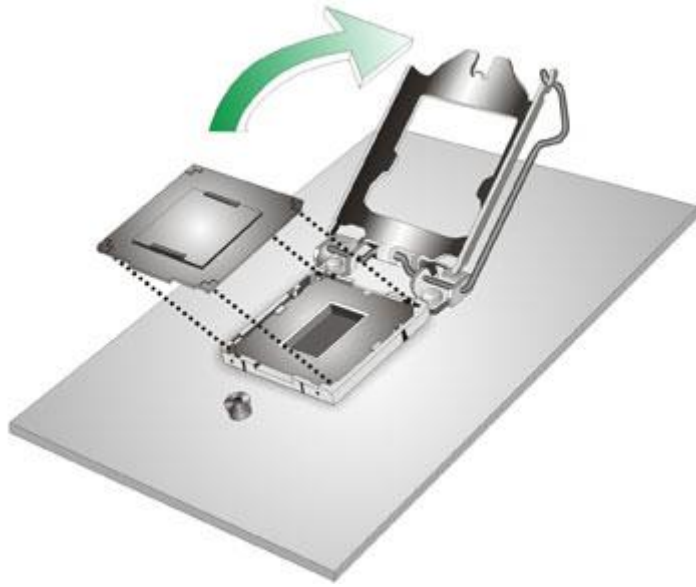

Figure 4-2: Remove Protective Cover

- Step 3: Inspect the CPU socket.** Make sure there are no bent pins and make sure the socket contacts are free of foreign material. If any debris is found, remove it with compressed air.
- Step 4: Orientate the CPU properly.** The contact array should be facing the CPU socket.
- Step 5: Correctly position the CPU.** Match the Pin 1 mark with the cut edge on the CPU socket.
- Step 6: Align the CPU pins.** Locate pin 1 and the two orientation notches on the CPU. Carefully match the two orientation notches on the CPU with the socket alignment keys.
- Step 7: Insert the CPU.** Gently insert the CPU into the socket. If the CPU pins are properly aligned, the CPU should slide into the CPU socket smoothly. See **Figure 4-3**.

KINO-AQ170 Industrial Motherboard

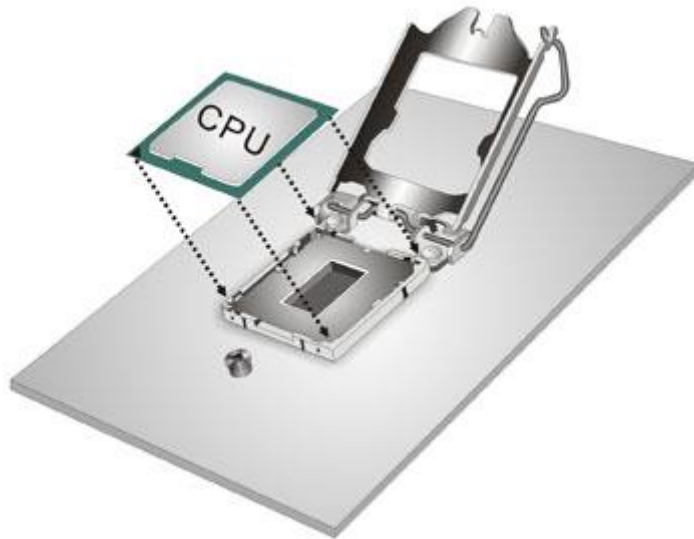

Figure 4-3: Insert the Socket LGA1151 CPU

Step 8: Close the CPU socket. Close the load plate and pull the load lever back a little to have the load plate be able to secure to the knob. Engage the load lever by pushing it back to its original position (**Figure 4-4**). There will be some resistance, but will not require extreme pressure.

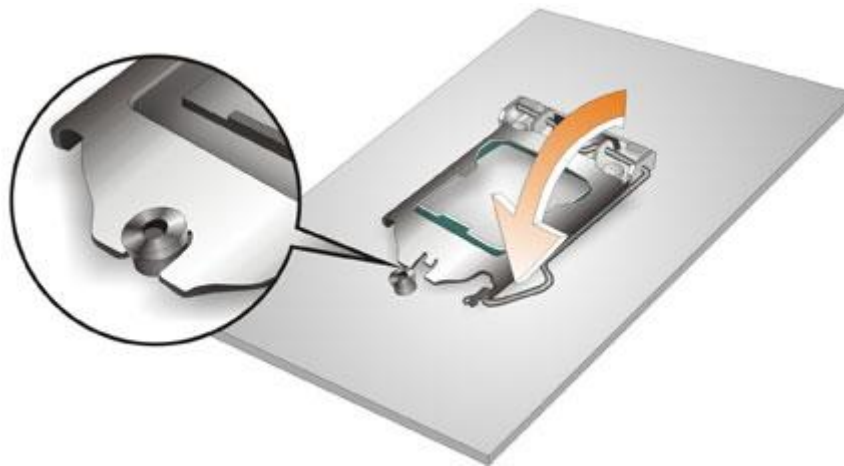

Figure 4-4: Close the Socket LGA1151

4.4 Socket LGA1151 Cooling Kit Installation



WARNING:

DO NOT attempt to install a push-pin cooling fan.

The pre-installed support bracket prevents the board from bending and is ONLY compatible with captive screw type cooling fans.



WARNING:

Do not wipe off (accidentally or otherwise) the pre-sprayed layer of thermal paste on the bottom of the heat sink. The thermal paste between the CPU and the heat sink is important for optimum heat dissipation.

The cooling kit can be bought from IEI. The cooling kit has a heatsink and fan. To install the cooling kit, follow the instructions below.

Step 1: A cooling kit bracket is pre-installed on the solder side of the motherboard.

See **Figure 4-5**.

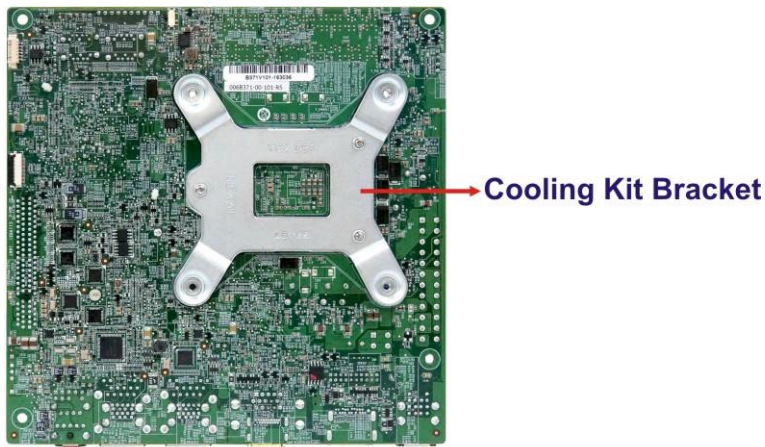

Figure 4-5: Cooling Kit Support Bracket

KINO-AQ170 Industrial Motherboard

- Step 2:** Place the cooling kit onto the socket LGA1151 CPU. Make sure the CPU cable can be properly routed when the cooling kit is installed.
- Step 3:** Mount the cooling kit. Gently place the cooling kit on top of the CPU. Make sure the four threaded screws on the corners of the cooling kit properly pass through the holes of the cooling kit bracket.
- Step 4:** Tighten the screws. Use a screwdriver to tighten the four screws. In a diagonal pattern, tighten each screw a few turns then move to the next one, until they are all secured. Do not over tighten the screws.
- Step 5:** Connect the fan cable. Connect the cooling kit fan cable to the fan connector on the KINO-AQ170. Carefully route the cable and avoid heat generating chips and fan blades.

4.5 SO-DIMM Installation

To install an SO-DIMM, please follow the steps below and refer to **Figure 4-6**.



CAUTION:

For dual channel configuration, always install two identical memory modules that feature the same capacity, timings, voltage, number of ranks and the same brand.

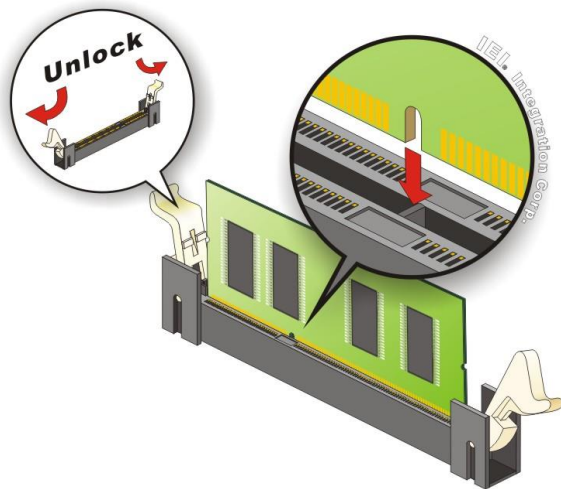

Figure 4-6: SO-DIMM Installation

- Step 1: Open the SO-DIMM socket handles.** Open the two handles outwards as far as they can. See **Figure 4-6**.
- Step 2: Align the SO-DIMM with the socket.** Align the SO-DIMM so the notch on the memory lines up with the notch on the memory socket. See **Figure 4-6**.
- Step 3: Insert the SO-DIMM.** Once aligned, press down until the SO-DIMM is properly seated. Clip the two handles into place. See **Figure 4-6**.
- Step 4: Removing a SO-DIMM.** To remove a SO-DIMM, push both handles outward. The memory module is ejected by a mechanism in the socket.

KINO-AQ170 Industrial Motherboard

4.6 PCIe Mini Card Installation

4.6.1 Full-size PCIe Mini Card Installation

To install a full-size PCIe Mini card, please follow the steps below.

Step 1: Locate the PCIe Mini card slot. See Chapter 3.

Step 2: Remove the retention screw and standoff for a half-size PCIe Mini card. To avoid interference of the board circuit, remove the retention screw and standoff for a half-size PCIe Mini card as shown in **Figure 4-7**.

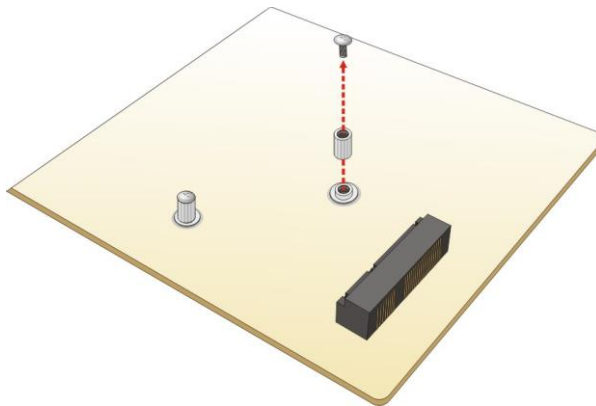

Figure 4-7: Removing the Retention Screw and Standoff for a Half-size PCIe Mini Card

Step 3: Remove the retention screw. Remove the retention screw as shown in **Figure 4-8**.

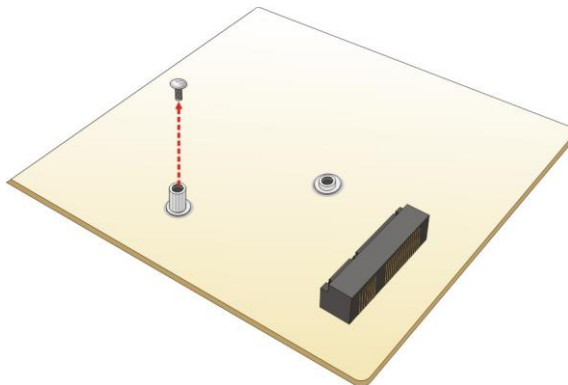

Figure 4-8: Removing the Retention Screw

Step 4: Insert into the socket at an angle. Line up the notch on the card with the notch on the slot. Slide the PCIe Mini card into the socket at an angle of about 20° (Figure 4-9).

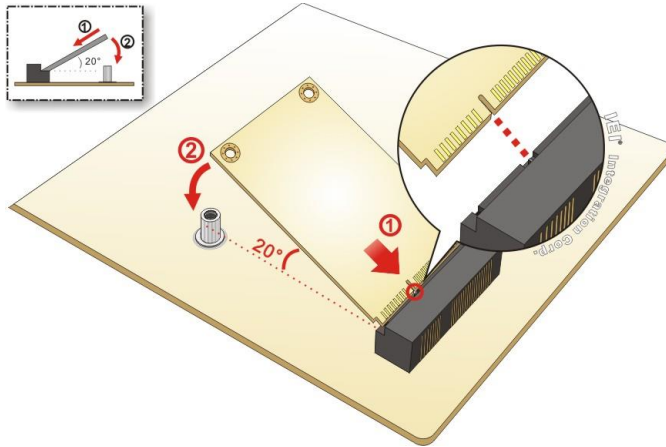

Figure 4-9: Inserting the Full-size PCIe Mini Card into the Slot at an Angle

Step 5: Secure the full-size PCIe Mini card. Secure the full-size PCIe Mini card with the retention screw previously removed (Figure 4-10).

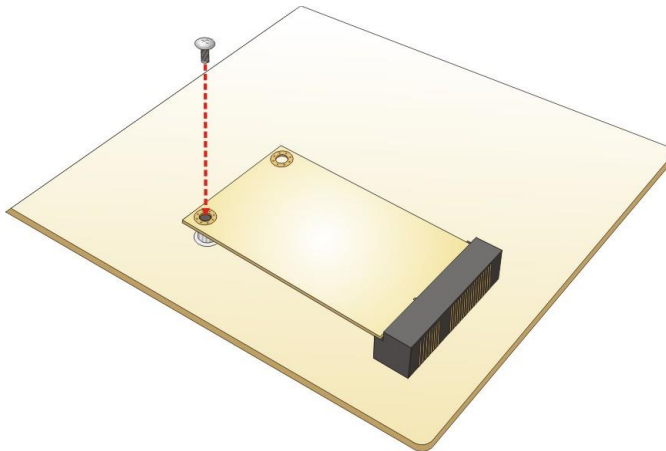

Figure 4-10: Securing the Full-size PCIe Mini Card

KINO-AQ170 Industrial Motherboard

4.6.2 Half-size PCIe Mini Card Installation

To install a half-size PCIe Mini card, please follow the steps below.

Step 1: Locate the PCIe Mini card slot. See Chapter 3.

Step 2: Remove the retention screw. See Figure 4-11.

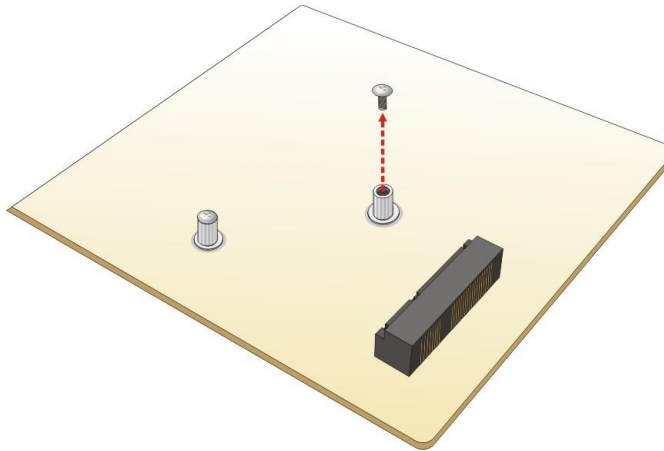

Figure 4-11: Removing Retention Screw

Step 3: Insert into the socket at an angle. Line up the notch on the card with the notch on the slot. Slide the PCIe Mini card into the slot at an angle of about 20° (Figure 4-12).

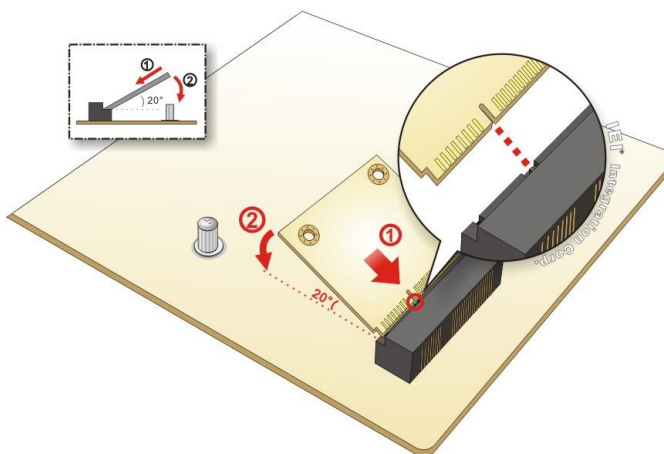

Figure 4-12: Inserting the Half-size PCIe Mini Card into the Slot at an Angle

Step 4: Secure the half-size PCIe Mini card. Secure the half-size PCIe Mini card with the retention screw previously removed (**Figure 4-13**).

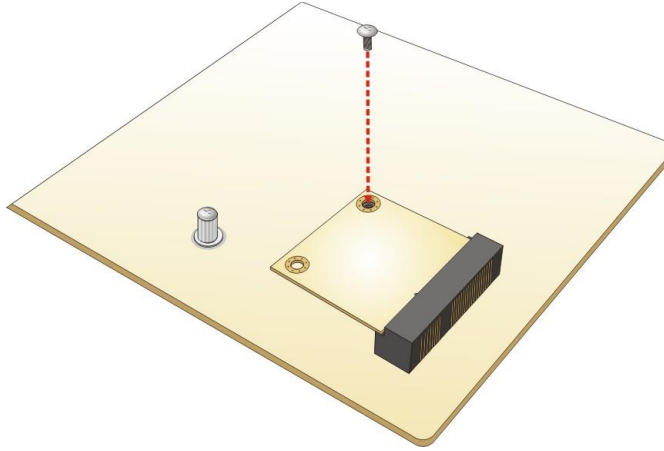

Figure 4-13: Securing the Half-size PCIe Mini Card

KINO-AQ170 Industrial Motherboard

4.7 System Configuration

The system configuration is controlled by buttons, jumpers and switches. The system configuration should be performed before installation.

4.7.1 AT/ATX Mode Select Switch

The AT/ATX mode select switch specifies the systems power mode as AT or ATX. AT/ATX mode select switch settings are shown in **Table 4-1**.

Setting	Description
Short 1-2	ATX Mode (Default)
Short 2-3	AT Mode

Table 4-1: AT/ATX Mode Select Switch Settings

The location of the AT/ATX mode select switch is shown in **Figure 4-14** below.

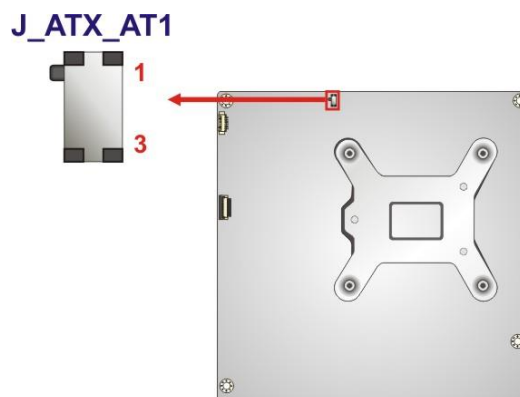

Figure 4-14: AT/ATX Mode Select Switch Location

4.7.2 Clear CMOS Button

If the KINO-AQ170 fails to boot due to improper BIOS settings, press the button for three seconds to clear the CMOS data and reset the system BIOS information. After updating to a new version of BIOS, the user has to follow the steps described below to boot up the system.

Step 1: Unplug the system power cord.

Step 2: Unplug the RTC battery for a while and re-plug it back in.

Step 3: Clear CMOS by pressing the clear CMOS button for three seconds or more.

Step 4: Boot up the system.

The location of the clear CMOS button is shown in **Figure 4-15**

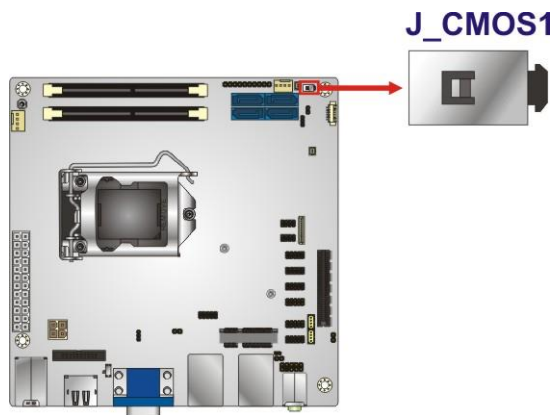

Figure 4-15: Clear CMOS Button Location

KINO-AQ170 Industrial Motherboard

4.7.3 Flash Descriptor Security Override Jumper

The Flash Descriptor Security Override jumper (J_FLASH1, p=2.00 mm) allows users to enable or disable the ME firmware update. Refer to **Figure 4-16** and **Table 4-2** for the jumper location and settings.

Setting	Description
Open	Disabled (default)
Short	Enabled

Table 4-2: Flash Descriptor Security Override Jumper Settings

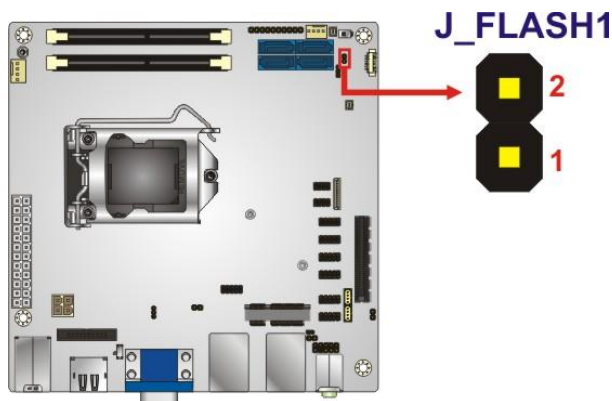

Figure 4-16: Flash Descriptor Security Override Jumper Location

To update the ME firmware, please follow the steps below.

- Step 1:** Before turning on the system power, short the Flash Descriptor Security Override jumper.
- Step 2:** Update the BIOS and ME firmware, and then turn off the system power.
- Step 3:** Remove the metal clip on the Flash Descriptor Security Override jumper to its default setting.
- Step 4:** Restart the system. The system will reboot 2 ~ 3 times to complete the ME firmware update.

4.7.4 HDMI/DP Select Switch

The HDMI/DP select switch specifies the external HDMI/DP connector as HDMI or DisplayPort. HDMI/DP select switch settings are shown in **Table 4-3**.

Setting	Description
Short 1-2	HDMI
Short 2-3	DisplayPort (Default)

Table 4-3: HDMI/DP Select Switch Settings

The location of the HDMI/DP select switch is shown in **Figure 4-17** below.

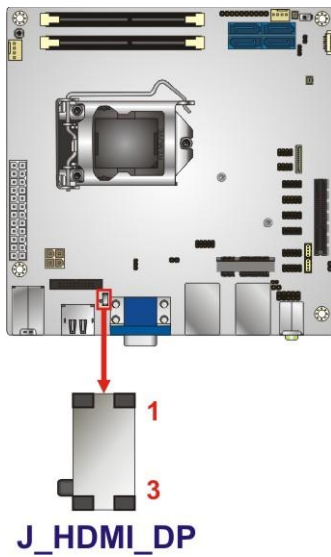

Figure 4-17: HDMI/DP Select Switch Location

KINO-AQ170 Industrial Motherboard

4.7.5 mSATA Module Detection Jumper

Use the **MSATA_SW2** jumper to select whether to automatically detect mSATA devices installed in the PCIe Mini slot (MPCIE1).

Setting	Description
Open	Automatically detect mSATA device (Default)
Short	Enable mSATA device

Table 4-4: mSATA Module Detection Jumper Settings

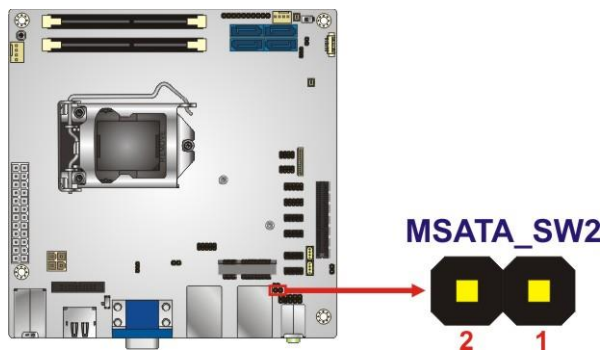

Figure 4-18: mSATA Module Detection Jumper Location

4.7.6 USB Power Selection

The USB power selection is made through the BIOS menu in “Chipset → PCH-IO Configuration”. Use the **USB Power SW1** and the **USB Power SW2** BIOS options to configure the correspondent USB ports (see **Table 4-5**) and refer to **Table 4-6** to select the USB power source.

BIOS Options	Configured USB Ports
USB Power SW1	K/M_USB1 (external USB 2.0 ports) LAN1_USB1 (external USB 3.2 Gen 1 ports) LAN2_USB2 (external USB 3.2 Gen 1 ports)
USB Power SW2	USB1 (internal USB 2.0 ports) USB2 (internal USB 2.0 ports)

Table 4-5: BIOS Options and Configured USB Ports

Options	Description
+5V DUAL	+5V dual (default)
+5V	+5V

Table 4-6: USB Power Source Setup

Please refer to **Section 5.4.2** for BIOS setup.

4.8 Chassis Installation

4.8.1 Airflow



WARNING:

Airflow is critical for keeping components within recommended operating temperatures. The chassis should have fans and vents as necessary to keep things cool.

The KINO-AQ170 must be installed in a chassis with ventilation holes on the sides allowing airflow to travel through the heat sink surface. In a system with an individual power supply unit, the cooling fan of a power supply can also help generate airflow through the board surface.

4.8.2 Motherboard Installation

To install the KINO-AQ170 motherboard into the chassis please refer to the reference material that came with the chassis.

KINO-AQ170 Industrial Motherboard

4.9 Internal Peripheral Device Connections

This section outlines the installation of peripheral devices to the on-board connectors

4.9.1 SATA Drive Connection

The KINO-AQ170 is shipped with two SATA drive cables. To connect the SATA drives to the connectors, please follow the steps below.

Step 1: Locate the connectors. The locations of the SATA drive connectors are shown in **Chapter 3**.

Step 2: Insert the cable connector. Insert the cable connector into the on-board SATA drive connector until it clips into place. See Figure 4-19.

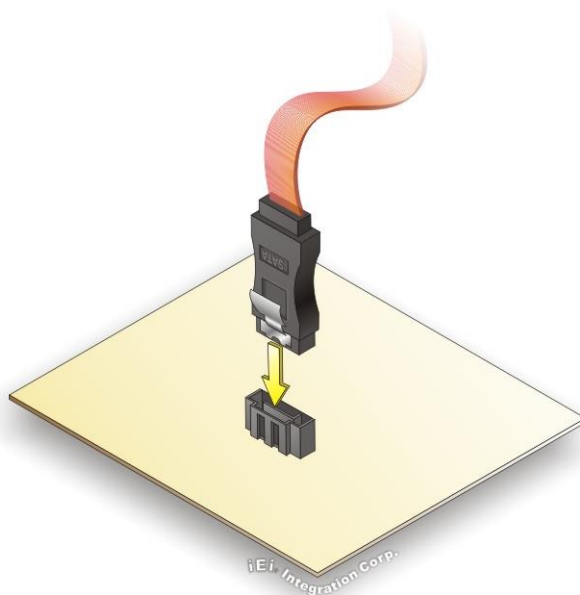

Figure 4-19: SATA Drive Cable Connection

Step 3: Connect the cable to the SATA disk. Connect the connector on the other end of the cable to the connector at the back of the SATA drive. See Figure 4-20.

Step 4: Connect the SATA power cable. Connect the SATA power connector to the back of the SATA drive. See Figure 4-20.

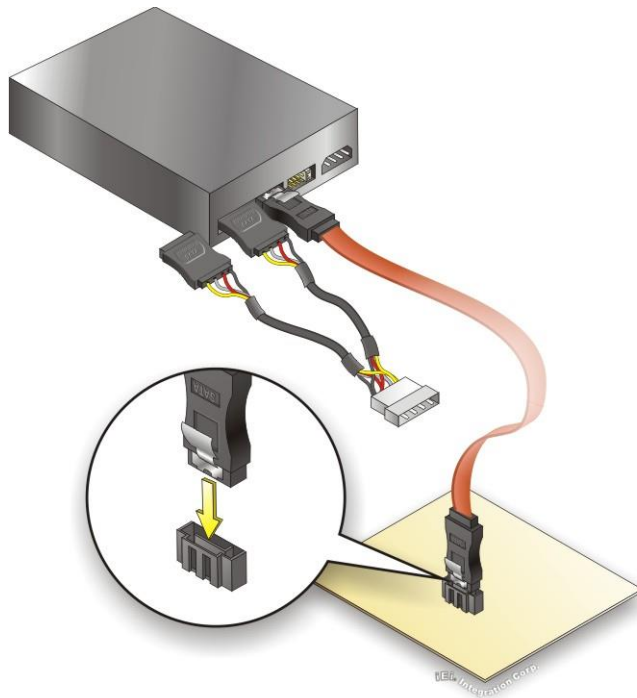

Figure 4-20: SATA Power Drive Connection

4.9.2 RS-232 Cable Connection (Optional)

The optional single RS-232 cable consists of one serial port connector attached to a serial communications cable that is then attached to a D-sub 9 male connector. To install the single RS-232 cable, please follow the steps below.

Step 1: Locate the connector. The location of the RS-232 connector is shown in Chapter 3.

Step 2: Insert the cable connector. Align the cable connector with the onboard connector. Make sure pin 1 on the board and connector line up. Pin 1 on the cable connector is indicated with a white dot. See Figure 4-21.

KINO-AQ170 Industrial Motherboard

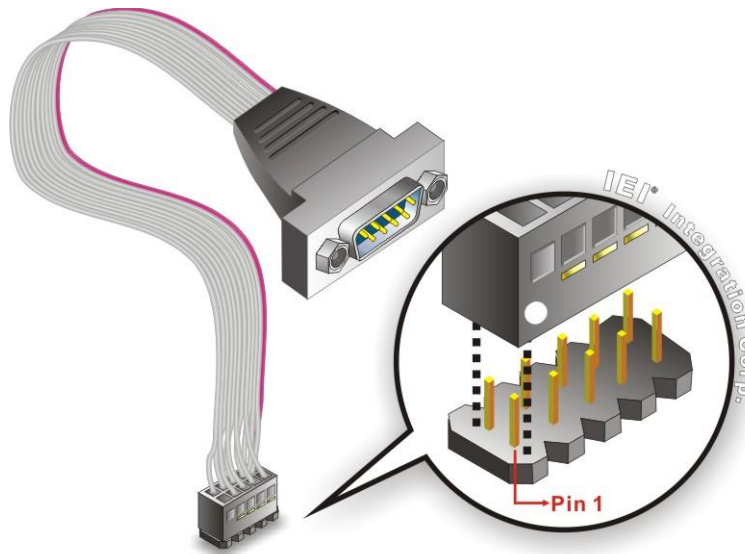

Figure 4-21: Single RS-232 Cable Installation

- Step 3: Secure the bracket.** The single RS-232 connector has two retention screws that must be secured to a chassis or bracket.
- Step 4: Connect the serial device.** Once the single RS-232 connector is connected to a chassis or bracket, a serial communications device can be connected to the system.

4.10 Intel® AMT Setup Procedure

The KINO-AQ170 is featured with the Intel® Active Management Technology (AMT). To enable the Intel® AMT function, follow the steps below.

- Step 1:** Make sure at least one of the memory sockets is installed with a DDR4 SO-DIMM.
- Step 2:** Connect an Ethernet cable to the RJ-45 connector labeled **LAN1_USB1**.
- Step 3:** The AMI BIOS options regarding the Intel® ME or Intel® AMT must be enabled.
- Step 4:** Properly install the Intel® Management Engine Components drivers from the iAMT Driver & Utility directory obtained from IEI Resource Download Center. See **Chapter 6**.
- Step 5:** Configure the Intel® Management Engine BIOS extension (MEBx). To get into the Intel® MEBx settings, press <Ctrl+P> after a single beep during boot-up process. Enter the Intel® current ME password as it requires (the Intel® default password is **admin**).



NOTE:

To change the password, enter a new password following the strong password rule (containing at least one upper case letter, one lower case letter, one digit and one special character, and be at least eight characters).

4.11 Windows 7 Installation – USB 3.2 Gen 1 Creator Utility

Microsoft Windows 7 installation media does not include native driver support for USB 3.2 Gen 1, so during installation, a keyboard/mouse connected to a USB 3.2 Gen 1 port does not respond. The Windows 7 USB 3.0 Creator Utility automates the steps to update a Windows 7 installation image so that it contains USB 3.2 Gen 1 drivers. To install Windows 7 from a USB drive onto the KINO-AQ170, please follow the steps described below.

- Step 1:** Create a USB flash drive installer. Use your Windows 7 DVD or ISO image to create a bootable USB flash drive. Instructions on how to do are found on [Microsoft's website](#).
- Step 2:** Download and unzip the [Windows 7 USB 3.0 Creator utility](#) to a temporary folder on the Admin system.
- Step 3:** Connect the USB device containing the Windows 7 image to the Admin system.
- Step 4:** Right-click the file "Installer_Creator.exe" and select Run as administrator.
- Step 5:** Browse to the root of the USB drive.
- Step 6:** Click "Create Image" to begin the creation process.
- Step 7:** Wait for the process to finish. It can take up to 15 minutes.
- Step 8:** Using the updated installer, proceed with the Windows 7 installation as you normally would.

Chapter

5

BIOS

KINO-AQ170 Industrial Motherboard

5.1 Introduction

The BIOS is programmed onto the BIOS chip. The BIOS setup program allows changes to certain system settings. This chapter outlines the options that can be changed.



NOTE:

Some of the BIOS options may vary throughout the life cycle of the product and are subject to change without prior notice.

5.1.1 Starting Setup

The UEFI BIOS is activated when the computer is turned on. The setup program can be activated in one of two ways.

1. Press the **DELETE** or **F2** key as soon as the system is turned on or
2. Press the **DELETE** or **F2** key when the “**Press Del to enter SETUP**” message appears on the screen.

If the message disappears before the **DELETE** or **F2** key is pressed, restart the computer and try again.

5.1.2 Using Setup

Use the arrow keys to highlight items, press **ENTER** to select, use the PageUp and PageDown keys to change entries, press **F1** for help and press **ESC** to quit. Navigation keys are shown in.

Key	Function
Up arrow	Move to previous item
Down arrow	Move to next item
Left arrow	Move to the item on the left hand side
Right arrow	Move to the item on the right hand side
+	Increase the numeric value or make changes

Key	Function
-	Decrease the numeric value or make changes
F1 key	General help, only for Status Page Setup Menu and Option Page Setup Menu
F2 key	Load previous values.
F3 key	Load optimized defaults
F4 key	Save changes and Exit BIOS
Esc key	Main Menu – Quit and not save changes into CMOS Status Page Setup Menu and Option Page Setup Menu -- Exit current page and return to Main Menu

5.1.3 Getting Help

When **F1** is pressed a small help window describing the appropriate keys to use and the possible selections for the highlighted item appears. To exit the Help Window press **Esc** or the **F1** key again.

5.1.4 Unable to Reboot after Configuration Changes

If the computer cannot boot after changes to the system configuration is made, CMOS defaults. Use the jumper described in **Section 4.7.2**.

5.1.5 BIOS Menu Bar

The **menu bar** on top of the BIOS screen has the following main items:

- Main – Changes the basic system configuration.
- Advanced – Changes the advanced system settings.
- Chipset – Changes the chipset settings.
- Security – Sets User and Supervisor Passwords.
- Boot – Changes the system boot configuration.
- Save & Exit – Selects exit options and loads default settings

The following sections completely describe the configuration options found in the menu items at the top of the BIOS screen and listed above.

KINO-AQ170 Industrial Motherboard

5.2 Main

The **Main** BIOS menu (**BIOS Menu 1**) appears when the **BIOS Setup** program is entered.

```

Aptio Setup Utility - Copyright (C) 2016 American Megatrends, Inc.
  Main  Advanced  Chipset  Security  Boot  Save & Exit
BIOS Information
BIOS Vendor                American Megatrends
Core Version                5.11
Compliancy                 UEFI 2.4; PI 1.3
Project Version            B371AR11.ROM
Build Date and Time        04/18/2016 17:39:50

iWDD Vendor                iEi
iWDD Version               371ER10e.bin
Access Level               Administrator

Processor Information
Name                       SkyLake DT
Brand String               Intel(R) Core(TM)
                           i5-6500 CPU @ 2.30GHz
Frequency                  2300 MHz
Processor ID               506E3
Stepping                   RO/S0/N0
Number of Processors       4Core(s) / 4Thread(s)
Microcode Revision         7C
GT Info                    GT2

IGFX VBIOS Version         1036
Memory RC Version          1.8.0.1
Total Memory                8192 MB
Memoery Frequency           2133 MHz

PCH Information
Name                       SKL PCH-H
PCH SKU                    PCH-H Desktop Q170 SKU
                           Premium SKU
Stepping                   31/D1
LAN PHY Revision           B2

ME FW Version              11.0.0.1205
ME Firmware SKU            Corporate SKU

SPI Clock Frequency        17 MHz
D0FR Support               Unsupported
Read Status Clock Frequency 48 MHz
Write Status Clock Frequency 48 MHz
Fast Read Status Clock Frequency 48 MHz

Access Level                Administrator

-----
<->: Select Screen
^ v: Select Item
EnterSelect
+/-: Change Opt.
F1: General Help
F2: Previous Values
F3: Optimized Defaults
F4: Save & Exit
ESC: Exit

Version 2.17.1255. Copyright (C) 2016 American Megatrends, Inc.
  
```

BIOS Menu 1: Main

5.3 Advanced

Use the **Advanced** menu (**BIOS Menu 2**) to configure the CPU and peripheral devices through the following sub-menus:



WARNING!

Setting the wrong values in the sections below may cause the system to malfunction. Make sure that the settings made are compatible with the hardware.

```

Aptio Setup Utility - Copyright (C) 2016 American Megatrends, Inc.
Main  Advanced  Chipset  Security  Boot  Save & Exit
-----
> ACPI Settings
> AMT Configuration
> Super IO Configuration
> iWDD H/W Monitor
> RTC Wake Settings
> Serial Port Console Redirection
> CPU Configuration
> SATA Configuration
> NVMe Configuration
> USB Configuration
> iEi Feature

System ACPI Parameters.

-----
<->: Select Screen
↑ ↓: Select Item
Enter>Select
F1  General Help
F2  Previous Values
F3  Optimized Defaults
F4  Save
ESC Exit

Version 2.17.1255. Copyright (C) 2016 American Megatrends, Inc.
    
```

BIOS Menu 2: Advanced

KINO-AQ170 Industrial Motherboard

5.3.1 ACPI Settings

The **ACPI Settings** menu (**BIOS Menu 3**) configures the Advanced Configuration and Power Interface (ACPI) options.

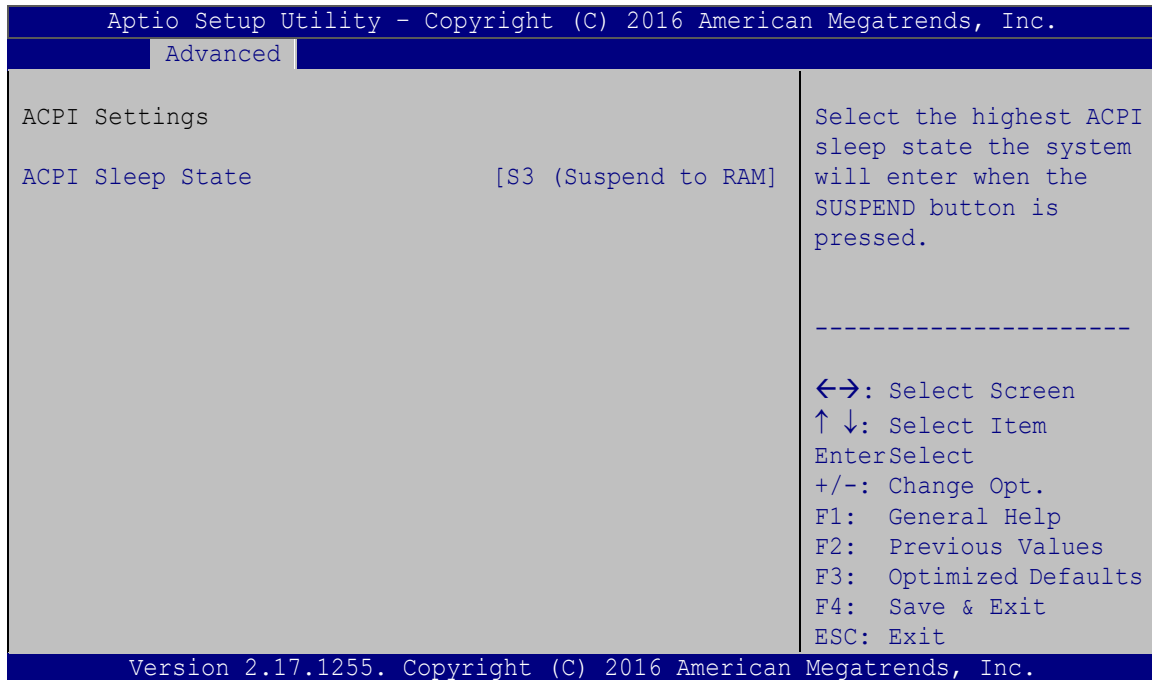

BIOS Menu 3: ACPI Settings

→ **ACPI Sleep State [S3 (Suspend to RAM)]**

Use the **ACPI Sleep State** option to specify the sleep state the system enters when it is not being used.

- **S3 (Suspend to DEFAULT RAM)** The caches are flushed and the CPU is powered off. Power to the RAM is maintained. The computer returns slower to a working state, but more power is saved.

5.3.2 AMT Configuration

The **AMT Configuration** menu (**BIOS Menu 4**) allows Intel® Active Management Technology (AMT) options to be configured.

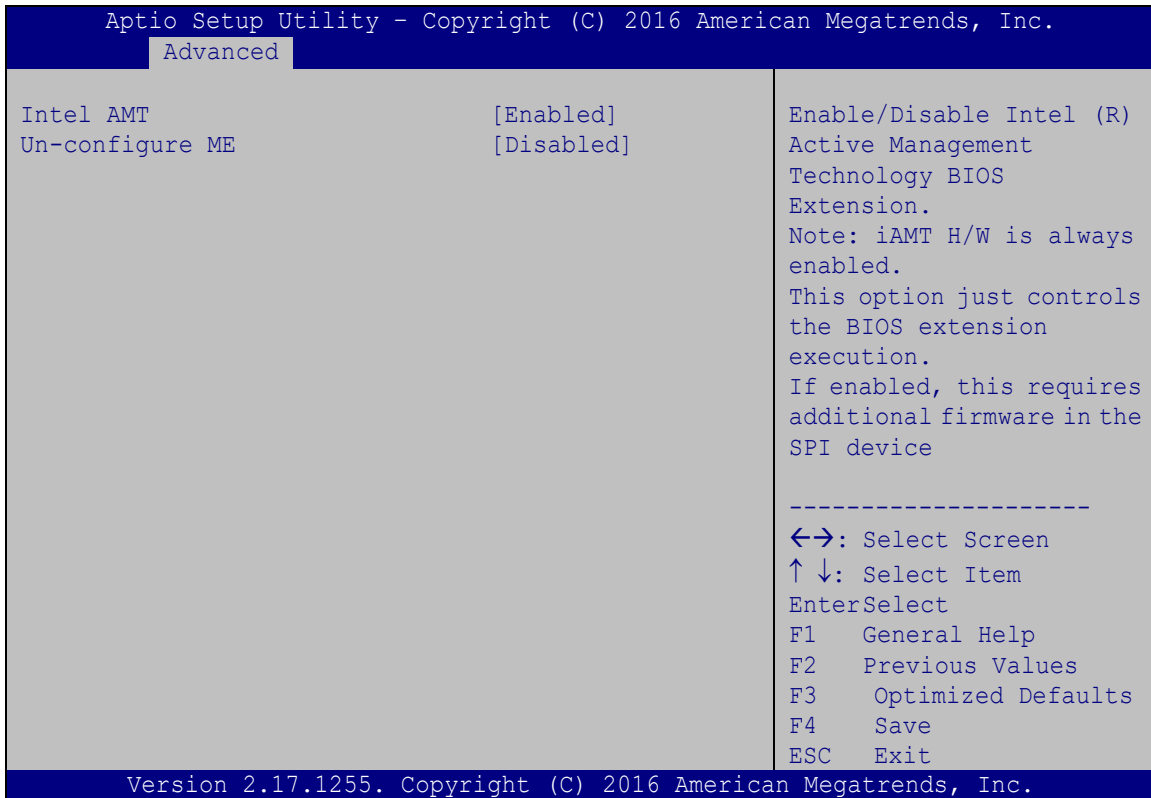

BIOS Menu 4: AMT Configuration

→ Intel AMT [Enabled]

Use **Intel AMT** option to enable or disable the Intel® AMT function.

- **Disabled** Intel® AMT is disabled
- **Enabled** **DEFAULT** Intel® AMT is enabled

→ Un-configure ME [Disabled]

Use the **Un-configure ME** option to perform ME unconfigure without password operation.

- **Disabled** **DEFAULT** Not perform ME unconfigure

KINO-AQ170 Industrial Motherboard

➔ **Enabled** To perform ME unconfigure

5.3.3 Super IO Configuration

Use the **Super IO Configuration** menu (**BIOS Menu 5**) to set or change the configurations for the serial ports.

```

Aptio Setup Utility - Copyright (C) 2016 American Megatrends, Inc.
  Advanced
F81866 Super IO Configuration
Super IO Chip                      F81866
> Serial Port 1 Configuration
> Serial Port 2 Configuration
> Serial Port 3 Configuration
> Serial Port 4 Configuration
> Serial Port 5 Configuration
> Serial Port 6 Configuration
Case Open Beep                     [Disabled]

Set Parameters of Serial
Port 1 (COMA)
-----
<=>: Select Screen
↑↓: Select Item
Enter>Select
F1  General Help
F2  Previous Values
F3  Optimized
Defaults
F4  Save
ESC Exit

Version 2.17.1255. Copyright (C) 2016 American Megatrends, Inc.
  
```

BIOS Menu 5: Super IO Configuration

➔ **Case Open Beep [Disabled]**

Use the **Case Open Beep** option to enable or disable the case open beep function.

➔ **Disabled** **DEFAULT** Disable the case open beep function

➔ **Enabled** Enable the case open beep function

5.3.3.1 Serial Port n Configuration

Use the **Serial Port n Configuration** menu (**BIOS Menu 6**) to configure the serial port n.

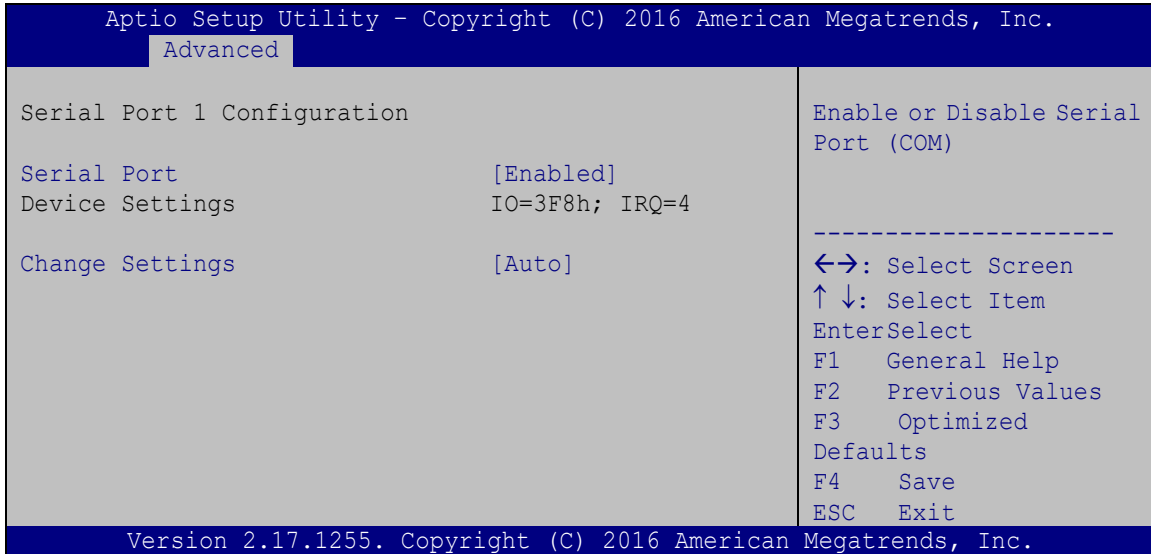

BIOS Menu 6: Serial Port n Configuration

5.3.3.1.1 Serial Port 1 Configuration

→ Serial Port [Enabled]

Use the **Serial Port** option to enable or disable the serial port.

- **Disabled** Disable the serial port
- **Enabled** **DEFAULT** Enable the serial port

→ Change Settings [Auto]

Use the **Change Settings** option to change the serial port IO port address and interrupt address.

- **Auto** **DEFAULT** The serial port IO port address and interrupt address are automatically detected.
- **IO=3F8h; IRQ=4** Serial Port I/O port address is 3F8h and the interrupt address is IRQ4

KINO-AQ170 Industrial Motherboard

- | | |
|----------------------------|---|
| → IO=3F8h; IRQ=3,
4, 11 | Serial Port I/O port address is 3F8h and the interrupt address is IRQ3, 4, 11 |
| → IO=2F8h; IRQ=3,
4, 11 | Serial Port I/O port address is 2F8h and the interrupt address is IRQ3, 4, 11 |
| → IO=3E8h; IRQ=3,
4, 11 | Serial Port I/O port address is 3E8h and the interrupt address is IRQ3, 4, 11 |
| → IO=2E8h; IRQ=3,
4, 11 | Serial Port I/O port address is 2E8h and the interrupt address is IRQ3, 4, 11 |
| → IO=2D0h; IRQ=3,
4, 11 | Serial Port I/O port address is 2D0h and the interrupt address is IRQ3, 4, 11 |
| → IO=2E0h; IRQ=3,
4, 11 | Serial Port I/O port address is 2E0h and the interrupt address is IRQ3, 4, 11 |

5.3.3.1.2 Serial Port 2 Configuration

→ Serial Port [Enabled]

Use the **Serial Port** option to enable or disable the serial port.

- | | |
|--------------------------|-------------------------|
| → Disabled | Disable the serial port |
| → Enabled DEFAULT | Enable the serial port |

→ Change Settings [Auto]

Use the **Change Settings** option to change the serial port IO port address and interrupt address.

- | | |
|----------------------------|---|
| → Auto DEFAULT | The serial port IO port address and interrupt address are automatically detected. |
| → IO=2F8h; IRQ=3 | Serial Port I/O port address is 2F8h and the interrupt address is IRQ3 |
| → IO=3F8h; IRQ=3,
4, 11 | Serial Port I/O port address is 3F8h and the interrupt address is IRQ3, 4, 11 |

- | | |
|-------------------------|---|
| → IO=2F8h; IRQ=3, 4, 11 | Serial Port I/O port address is 2F8h and the interrupt address is IRQ3, 4, 11 |
| → IO=3E8h; IRQ=3, 4, 11 | Serial Port I/O port address is 3E8h and the interrupt address is IRQ3, 4, 11 |
| → IO=2E8h; IRQ=3, 4, 11 | Serial Port I/O port address is 2E8h and the interrupt address is IRQ3, 4, 11 |
| → IO=2D0h; IRQ=3, 4, 11 | Serial Port I/O port address is 2D0h and the interrupt address is IRQ3, 4, 11 |
| → IO=2E0h; IRQ=3, 4, 11 | Serial Port I/O port address is 2E0h and the interrupt address is IRQ3, 4, 11 |

5.3.3.1.3 Serial Port 3 Configuration

→ Serial Port [Enabled]

Use the **Serial Port** option to enable or disable the serial port.

- | | |
|--------------------------|-------------------------|
| → Disabled | Disable the serial port |
| → Enabled DEFAULT | Enable the serial port |

→ Change Settings [Auto]

Use the **Change Settings** option to change the serial port IO port address and interrupt address.

- | | |
|-------------------------|---|
| → Auto DEFAULT | The serial port IO port address and interrupt address are automatically detected. |
| → IO=3E8h; IRQ=11 | Serial Port I/O port address is 3E8h and the interrupt address is IRQ11 |
| → IO=3F8h; IRQ=3, 4, 11 | Serial Port I/O port address is 3F8h and the interrupt address is IRQ3, 4, 11 |
| → IO=2F8h; IRQ=3, 4, 11 | Serial Port I/O port address is 2F8h and the interrupt address is IRQ3, 4, 11 |

KINO-AQ170 Industrial Motherboard

- ➔ **IO=3E8h; IRQ=3, 4, 11** Serial Port I/O port address is 3E8h and the interrupt address is IRQ3, 4, 11
- ➔ **IO=2E8h; IRQ=3, 4, 11** Serial Port I/O port address is 2E8h and the interrupt address is IRQ3, 4, 11
- ➔ **IO=2D0h; IRQ=3, 4, 11** Serial Port I/O port address is 2D0h and the interrupt address is IRQ3, 4, 11
- ➔ **IO=2E0h; IRQ=3, 4, 11** Serial Port I/O port address is 2E0h and the interrupt address is IRQ3, 4, 11

5.3.3.1.4 Serial Port 4 Configuration

➔ Serial Port [Enabled]

Use the **Serial Port** option to enable or disable the serial port.

- ➔ **Disabled** Disable the serial port
- ➔ **Enabled DEFAULT** Enable the serial port

➔ Change Settings [Auto]

Use the **Change Settings** option to change the serial port IO port address and interrupt address.

- ➔ **Auto DEFAULT** The serial port IO port address and interrupt address are automatically detected.
- ➔ **IO=2E8h; IRQ=11** Serial Port I/O port address is 2E8h and the interrupt address is IRQ11
- ➔ **IO=3F8h; IRQ=3, 4, 11** Serial Port I/O port address is 3F8h and the interrupt address is IRQ3, 4, 11
- ➔ **IO=2F8h; IRQ=3, 4, 11** Serial Port I/O port address is 2F8h and the interrupt address is IRQ3, 4, 11
- ➔ **IO=3E8h; IRQ=3, 4, 11** Serial Port I/O port address is 3E8h and the interrupt address is IRQ3, 4, 11

- | | |
|----------------------------|---|
| → IO=2E8h; IRQ=3,
4, 11 | Serial Port I/O port address is 2E8h and the interrupt address is IRQ3, 4, 11 |
| → IO=2D0h; IRQ=3,
4, 11 | Serial Port I/O port address is 2D0h and the interrupt address is IRQ3, 4, 11 |
| → IO=2E0h; IRQ=3,
4, 11 | Serial Port I/O port address is 2E0h and the interrupt address is IRQ3, 4, 11 |

5.3.3.1.5 Serial Port 5 Configuration

→ Serial Port [Enabled]

Use the **Serial Port** option to enable or disable the serial port.

- | | |
|--------------------------|-------------------------|
| → Disabled | Disable the serial port |
| → Enabled DEFAULT | Enable the serial port |

→ Change Settings [Auto]

Use the **Change Settings** option to change the serial port IO port address and interrupt address.

- | | |
|----------------------------|---|
| → Auto DEFAULT | The serial port IO port address and interrupt address are automatically detected. |
| → IO=2D0h; IRQ=11 | Serial Port I/O port address is 2D0h and the interrupt address is IRQ11 |
| → IO=3F8h; IRQ=3,
4, 11 | Serial Port I/O port address is 3F8h and the interrupt address is IRQ3, 4, 11 |
| → IO=2F8h; IRQ=3,
4, 11 | Serial Port I/O port address is 2F8h and the interrupt address is IRQ3, 4, 11 |
| → IO=3E8h; IRQ=3,
4, 11 | Serial Port I/O port address is 3E8h and the interrupt address is IRQ3, 4, 11 |
| → IO=2E8h; IRQ=3,
4, 11 | Serial Port I/O port address is 2E8h and the interrupt address is IRQ3, 4, 11 |

KINO-AQ170 Industrial Motherboard

- ➔ **IO=2D0h; IRQ=3, 4, 11** Serial Port I/O port address is 2D0h and the interrupt address is IRQ3, 4, 11
- ➔ **IO=2E0h; IRQ=3, 4, 11** Serial Port I/O port address is 2E0h and the interrupt address is IRQ3, 4, 11

➔ **Transfer Mode [RS232]**

Use the **Transfer Mode** option to select the Serial Port 5 signaling mode.

- ➔ **RS422** Serial Port 5 signaling mode is RS-422
- ➔ **RS232 DEFAULT** Serial Port 5 signaling mode is RS-232
- ➔ **RS485** Serial Port 5 signaling mode is RS-485

5.3.3.1.6 Serial Port 6 Configuration

➔ **Serial Port [Enabled]**

Use the **Serial Port** option to enable or disable the serial port.

- ➔ **Disabled** Disable the serial port
- ➔ **Enabled DEFAULT** Enable the serial port

➔ **Change Settings [Auto]**

Use the **Change Settings** option to change the serial port IO port address and interrupt address.

- ➔ **Auto DEFAULT** The serial port IO port address and interrupt address are automatically detected.
- ➔ **IO=2E0h; IRQ=11** Serial Port I/O port address is 2E0h and the interrupt address is IRQ11
- ➔ **IO=3F8h; IRQ=3, 4, 11** Serial Port I/O port address is 3F8h and the interrupt address is IRQ3, 4, 11

- ➔ **IO=2F8h; IRQ=3, 4, 11** Serial Port I/O port address is 2F8h and the interrupt address is IRQ3, 4, 11
- ➔ **IO=3E8h; IRQ=3, 4, 11** Serial Port I/O port address is 3E8h and the interrupt address is IRQ3, 4, 11
- ➔ **IO=2E8h; IRQ=3, 4, 11** Serial Port I/O port address is 2E8h and the interrupt address is IRQ3, 4, 11
- ➔ **IO=2D0h; IRQ=3, 4, 11** Serial Port I/O port address is 2D0h and the interrupt address is IRQ3, 4, 11
- ➔ **IO=2E0h; IRQ=3, 4, 11** Serial Port I/O port address is 2E0h and the interrupt address is IRQ3, 4, 11

➔ **Transfer Mode [RS232]**

Use the **Transfer Mode** option to select the Serial Port 6 signaling mode.

- ➔ **RS422** Serial Port 6 signaling mode is RS-422
- ➔ **RS232 DEFAULT** Serial Port 6 signaling mode is RS-232
- ➔ **RS485** Serial Port 6 signaling mode is RS-485

5.3.4 iWDD H/W Monitor

The **iWDD H/W Monitor** menu (**BIOS Menu 7**) contains the fan configuration submenus and displays operating temperature, fan speeds and system voltages.

KINO-AQ170 Industrial Motherboard

```

Aptio Setup Utility - Copyright (C) 2016 American Megatrends, Inc.
-----
Advanced
-----
PC Health Status
CPU temperature           :+44 °C
System temperature       :+33 °C

CPU_FAN1 Speed           :7000 RPM
SYS_FAN1 Speed           :N/A

CPU_CORE                  :+0.973 V
+5V                       :+5.052 V
+12V                      :+11.774 V
+DDR                      :+1.196 V
+5VSB                     :+5.052 V
+3.3V                     :+3.277 V
+3.3VSB                   :+3.343 V

> Smart Fan Mode Configuration

Smart Fan Mode Select

-----
<=>: Select Screen
↑↓: Select Item
Enter>Select
+ - Change Opt.
F1  General Help
F2  Previous Values
F3  Optimized Defaults
F4  Save & Exit
ESC Exit

Version 2.17.1255. Copyright (C) 2016 American Megatrends, Inc.

```

BIOS Menu 7: iWDD H/W Monitor

→ PC Health Status

The following system parameters and values are shown. The system parameters that are monitored are:

- System Temperatures:
 - CPU Temperature
 - System temperature
- Fan Speed:
 - CPU Fan Speed
 - System Fan Speed
- Voltages
 - CPU_CORE
 - +5V
 - +12V
 - +DDR
 - +5VSB
 - +3.3V
 - +3.3VSB

5.3.4.1 Smart Fan Mode Configuration

Use the **Smart Fan Mode Configuration** submenu (**BIOS Menu 8**) to configure fan temperature and speed settings.

```

Aptio Setup Utility - Copyright (C) 2016 American Megatrends, Inc.
-----
Advanced
-----
Smart Fan Mode Configuration
CPU_FAN1 Smart Fan Control      [Auto Mode]
Auto mode fan start temperature 50
Auto mode fan off temperature  40
Auto mode fan start PWM        30
Auto mode fan slope PWM        1
SYS_FAN1 Smart Fan Control      [Auto Mode]
Auto mode fan start temperature 50
Auto mode fan off temperature  40
Auto mode fan start PWM        30
Auto mode fan slope PWM        1

Smart Fan Mode Select
-----
<=>: Select Screen
↑ ↓: Select Item
EnterSelect
+ - Change Opt.
F1  General Help
F2  Previous Values
F3  Optimized Defaults
F4  Save & Exit
ESC Exit

Version 2.17.1255. Copyright (C) 2016 American Megatrends, Inc.
    
```

BIOS Menu 8: Smart Fan Mode Configuration

→ CPU_FAN1 Smart Fan Control [Auto Mode]

Use the **CPU_FAN1 Smart Fan Control** BIOS option to configure the CPU Smart Fan.

- **Manual Mode** **DEFAULT** The fan spins at the speed set in the Manual Mode option
- **Auto Mode** **DEFAULT** The fan adjusts its speed using these settings:
 - Auto mode fan start temperature
 - Auto mode fan off temperature
 - Auto mode fan start PWM
 - Auto mode fan slope PWM

KINO-AQ170 Industrial Motherboard

→ **SYS_FAN1 Smart Fan Control [Auto Mode]**

Use the **SYS_FAN1 Smart Fan Control** BIOS option to configure the system smart fan.

- | | | | |
|---|--------------------|----------------|---|
| → | Manual Mode | | The fan spins at the speed set in the Manual Mode option |
| → | Auto Mode | DEFAULT | The fan adjusts its speed using these settings: <ul style="list-style-type: none">Auto mode fan start temperatureAuto mode fan off temperatureAuto mode fan start PWMAuto mode fan slope PWM |

→ **Auto mode fan start temperature [50]**



WARNING:

Setting this value too high may cause the fan to rotate at full speed only when the CPU is at a very high temperature and therefore cause the system to be damaged.

The **Auto mode fan start temperature** option can only be set if the **SYS_FAN1 Smart Fan Control** option is set to **Auto Mode**. If the system temperature is between **Start Temperature** and **Off Temperature**, the fan speed change to be **Start PWM**. To set a value, select the **Auto mode fan start temperature** option and enter a decimal number between 1 and 100.

→ **Auto mode fan off temperature [40]**



WARNING:

Setting this value too high may cause the fan to speed up only when the CPU is at a very high temperature and therefore cause the system to be damaged.

The **Auto mode fan off temperature** option can only be set if the **SYS_FAN1 Smart Fan control** option is set to **Auto Mode**. If the system temperature is lower than **Auto mode fan off temperature**, the fan speed change to be lowest. To set a value, select the **Auto mode fan off temperature** option and enter a decimal number between 1 and 100.

→ **Auto mode fan start PWM [30]**

The **Auto mode fan start PWM** option can only be set if the **SYS_FAN1 Smart Fan control** option is set to **Auto Mode**. Use the **Auto mode fan start PWM** option to set the PWM start value. To set a value, select the **Auto mode fan start PWM** option and enter a decimal number between 1 and 100.

→ **Auto mode fan slope PWM [1]**

The **Auto mode fan slope PWM** option can only be set if the **SYS_FAN1 Smart Fan control** option is set to **Auto Mode**. Use the **Auto mode fan slope PWM** option to select the linear rate at which the PWM mode increases with respect to an increase in temperature. To set a value, select the **Auto mode fan slope PWM** option and enter a decimal number between 1 and 8.

KINO-AQ170 Industrial Motherboard

5.3.5 RTC Wake Settings

The **RTC Wake Settings** menu (**BIOS Menu 9**) configures RTC wake event.

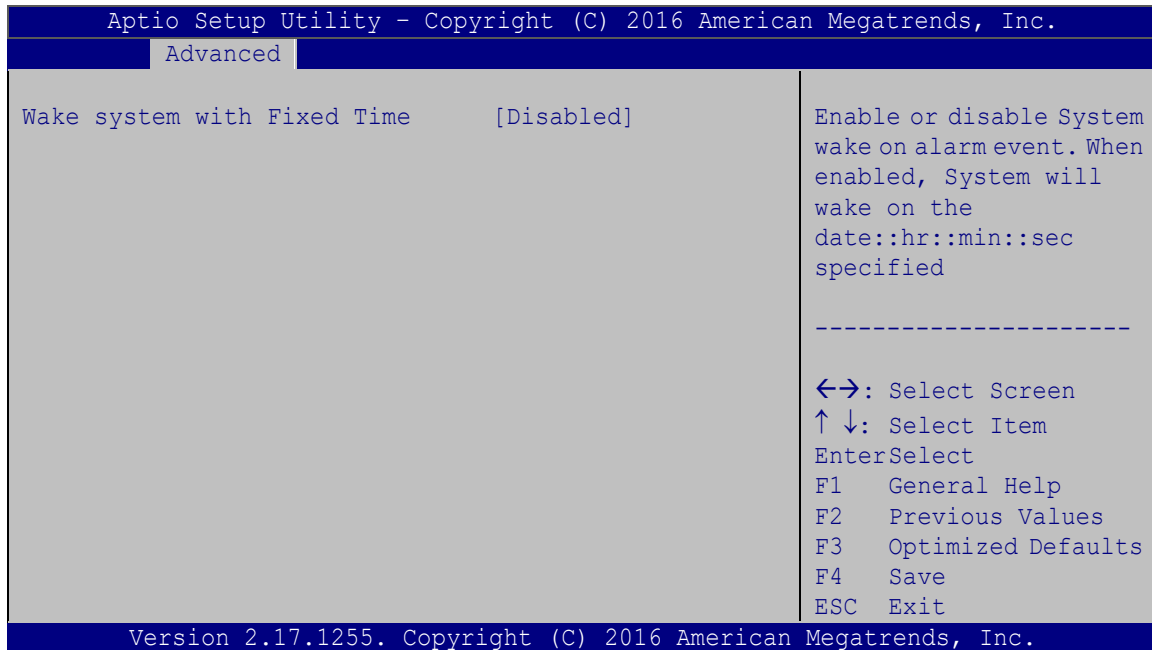

BIOS Menu 9: RTC Wake Settings

→ Wake system with Fixed Time [Disabled]

Use the **Wake system with Fixed Time** option to enable or disable the system wake on alarm event.

- **Disabled** **DEFAULT** The real time clock (RTC) cannot generate a wake event
- **Enabled** If selected, the **Wake up every day** option appears allowing you to enable to disable the system to wake every day at the specified time. Besides, the following options appear with values that can be selected:
 - Wake up date
 - Wake up hour
 - Wake up minute

Wake up second

After setting the alarm, the computer turns itself on from a suspend state when the alarm goes off.

5.3.6 Serial Port Console Redirection

The **Serial Port Console Redirection** menu (**BIOS Menu 10**) allows the console redirection options to be configured. Console redirection allows users to maintain a system remotely by re-directing keyboard input and text output through the serial port.

```

Aptio Setup Utility - Copyright (C) 2016 American Megatrends, Inc.
  Advanced
COM1
  Console Redirection [Disabled]
  > Console Redirection Settings
COM2
  Console Redirection [Disabled]
  > Console Redirection Settings
COM3
  Console Redirection [Disabled]
  > Console Redirection Settings
COM4
  Console Redirection [Disabled]
  > Console Redirection Settings
COM5
  Console Redirection [Disabled]
  > Console Redirection Settings
COM6
  Console Redirection [Disabled]
  > Console Redirection Settings
iAMT SOL
  COM7(Pci Bus0, Dev22, Func3)
  Console Redirection [Disabled]
  > Console Redirection Settings
  Legacy Console Redirection
  > Legacy Console Redirection Settings
  Console Redirection
  Enable or Disable
-----
<->: Select Screen
↑↓: Select Item
Enter>Select
F1  General Help
F2  Previous Values
F3  Optimized
Defaults
F4  Save
ESC  Exit
Version 2.17.1255. Copyright (C) 2016 American Megatrends, Inc.
  
```

BIOS Menu 10: Serial Port Console Redirection

KINO-AQ170 Industrial Motherboard

→ Console Redirection [Disabled]

Use **Console Redirection** option to enable or disable the console redirection function.

- **Disabled** **DEFAULT** Disabled the console redirection function
- **Enabled** Enabled the console redirection function

5.3.6.1 Legacy Console Redirection Settings

The **Legacy Console Redirection Settings** menu (**BIOS Menu 11**) allows the legacy console redirection options to be configured.

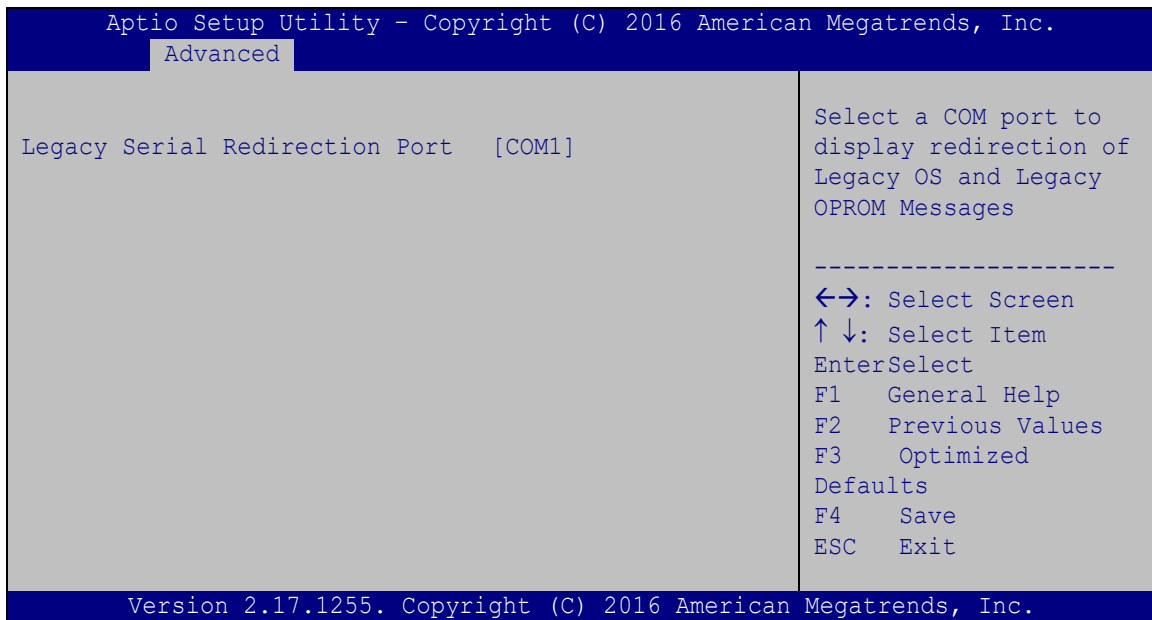

BIOS Menu 11: Legacy Console Redirection Settings

→ Legacy Serial Redirection Port [COM1]

Use the **Legacy Serial Redirection Port** option to specify a COM port to display redirection of legacy OS and legacy OPROM messages. The options include:

- COM1 **DEFAULT**
- COM2
- COM3
- COM4
- COM5

- COM6
- COM7 (Pci Bus0, Dev22, Func3)

5.3.6.2 Console Redirection Settings

The **Console Redirection Settings** menu (**BIOS Menu 12**) allows the console redirection options to be configured. The option is active when Console Redirection option is enabled.

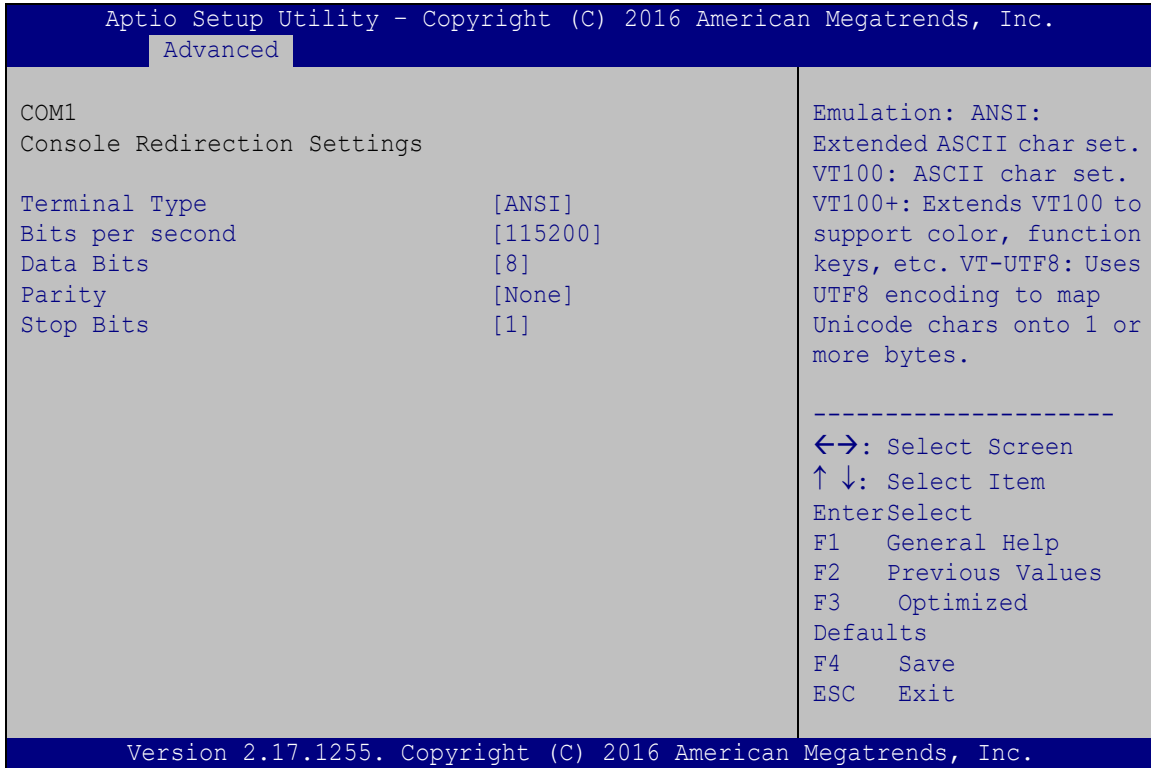

BIOS Menu 12: Console Redirection Settings

→ Terminal Type [ANSI]

Use the **Terminal Type** option to specify the remote terminal type.

- **VT100** The target terminal type is VT100
- **VT100+** The target terminal type is VT100+
- **VT-UTF8** The target terminal type is VT-UTF8
- **ANSI** **DEFAULT** The target terminal type is ANSI

KINO-AQ170 Industrial Motherboard

→ Bits per second [115200]

Use the **Bits per second** option to specify the serial port transmission speed. The speed must match the other side. Long or noisy lines may require lower speeds.

- | | | | |
|---|---------------|----------------|--|
| → | 9600 | | Sets the serial port transmission speed at 9600. |
| → | 19200 | | Sets the serial port transmission speed at 19200. |
| → | 57600 | | Sets the serial port transmission speed at 57600. |
| → | 115200 | DEFAULT | Sets the serial port transmission speed at 115200. |

→ Data Bits [8]

Use the **Data Bits** option to specify the number of data bits.

- | | | | |
|---|----------|----------------|--------------------------|
| → | 7 | | Sets the data bits at 7. |
| → | 8 | DEFAULT | Sets the data bits at 8. |

→ Parity [None]

Use the **Parity** option to specify the parity bit that can be sent with the data bits for detecting the transmission errors.

- | | | | |
|---|--------------|----------------|---|
| → | None | DEFAULT | No parity bit is sent with the data bits. |
| → | Even | | The parity bit is 0 if the number of ones in the data bits is even. |
| → | Odd | | The parity bit is 0 if the number of ones in the data bits is odd. |
| → | Mark | | The parity bit is always 1. This option does not provide error detection. |
| → | Space | | The parity bit is always 0. This option does not provide error detection. |

→ Stop Bits [1]

Use the **Stop Bits** option to specify the number of stop bits used to indicate the end of a serial data packet. Communication with slow devices may require more than 1 stop bit.

- 1 **DEFAULT** Sets the number of stop bits at 1.
- 2 Sets the number of stop bits at 2.

5.3.7 CPU Configuration

Use the **CPU Configuration** menu (**BIOS Menu 13**) to view detailed CPU specifications and configure the CPU.

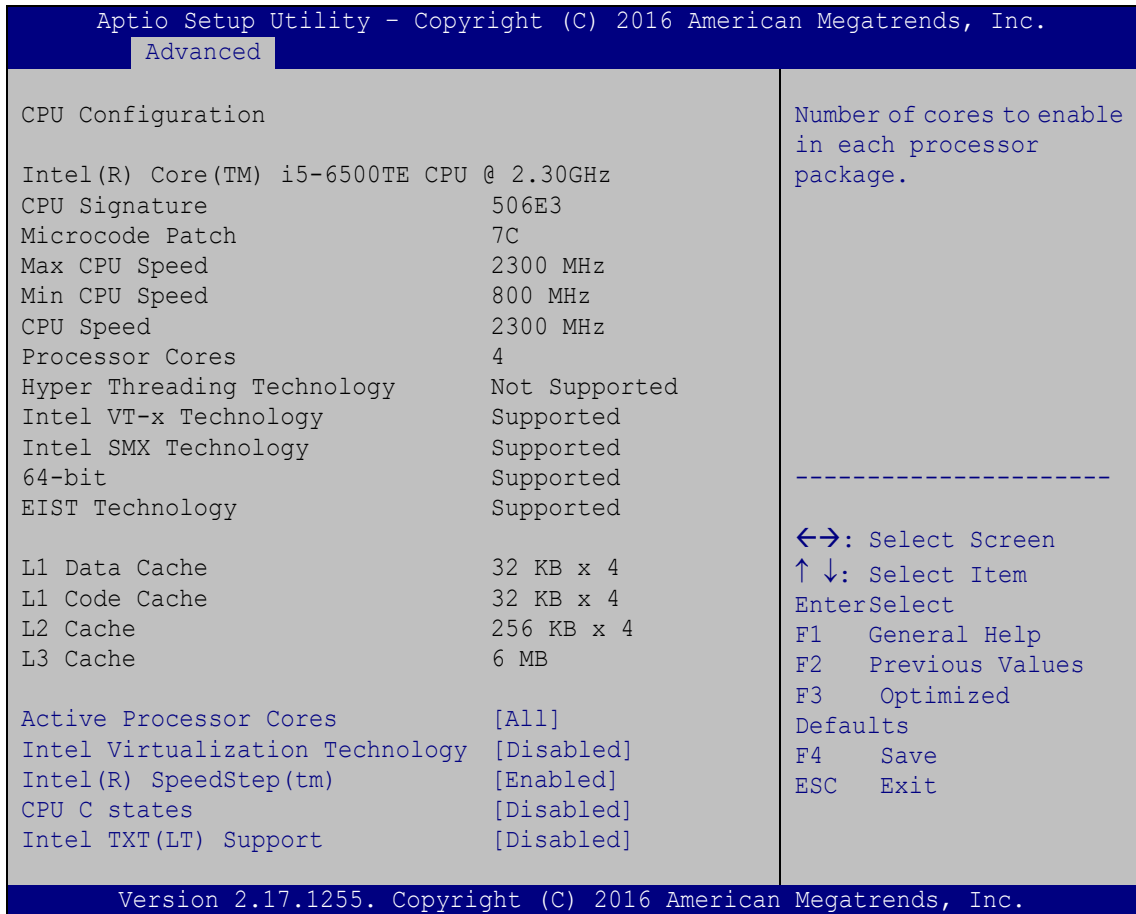

BIOS Menu 13: CPU Configuration

KINO-AQ170 Industrial Motherboard

→ Active Processor Cores [All]

Use the **Active Processor Cores** BIOS option to enable numbers of cores in the processor package.

- **All** **DEFAULT** Enable all cores in the processor package.
- **1** Enable one core in the processor package.
- **2** Enable two cores in the processor package.
- **3** Enable three cores in the processor package.

→ Intel® Virtualization Technology [Disabled]

Use the **Intel® Virtualization Technology** option to enable or disable virtualization on the system. When combined with third party software, Intel® Virtualization technology allows several OSs to run on the same system at the same time.

- **Disabled** **DEFAULT** Disables Intel® Virtualization Technology.
- **Enabled** Enables Intel® Virtualization Technology.

→ Intel® SpeedStep™ [Enabled]

Use the **Intel® SpeedStep™** option to enable or disable the Intel® SpeedStep Technology.

- **Disabled** Disables the Intel® SpeedStep Technology.
- **Enabled** **DEFAULT** Enables the Intel® SpeedStep Technology.

→ CPU C State [Disabled]

Use the **CPU C State** option to enable or disable CPU C state.

- **Disabled** **DEFAULT** Disables CPU C state.
- **Enabled** Enables CPU C state.

→ Intel TXT(LT) Support [Disabled]

Use the **Intel TXT(LT) Support** option to enable or disable the Intel® TXT (LT) support.

- **Disabled** **DEFAULT** Disables Intel® TXT (LT) support.
- **Enabled** Enables Intel® TXT (LT) support.

5.3.8 SATA Configuration

Use the **SATA Configuration** menu (**BIOS Menu 14**) to change and/or set the configuration of the SATA devices installed in the system.

```

Aptio Setup Utility - Copyright (C) 2016 American Megatrends, Inc.
  Advanced
-----
STAT Controller(s)          [Enabled]          Enable or disable SATA
SATA Mode Selection        [AHCI]             Device
-----
SATA1                      Empty
  Hot Plug                  [Disabled]
SATA2                      Empty
  Hot Plug                  [Disabled]
SATA3                      Empty
  Hot Plug                  [Disabled]
SATA4                      Empty
  Hot Plug                  [Disabled]
mSATA                      Empty
  Hot Plug                  [Disabled]
-----
                                  ←→: Select Screen
                                  ↑ ↓: Select Item
                                  Enter>Select
                                  F1  General Help
                                  F2  Previous Values
                                  F3  Optimized
                                  Defaults
                                  F4  Save
                                  ESC Exit
Version 2.17.1255. Copyright (C) 2016 American Megatrends, Inc.
  
```

BIOS Menu 14: SATA Configuration

→ STAT Controller(s) [Enabled]

Use the **STAT Controller(s)** option to enable or disable the SATA device.

- **Enabled** **DEFAULT** Enables the SATA device.
- **Disabled** Disables the SATA device.

KINO-AQ170 Industrial Motherboard

→ SATA Mode Selection [AHCI]

Use the **SATA Mode Selection** option to configure SATA devices as AHCI devices.

- **AHCI** **DEFAULT** Configures SATA devices as AHCI device.
- **RAID** Configures SATA devices as RAID device.



NOTE:

Before accessing the RAID configuration utility, ensure to set the **Option ROM Messages BIOS** option in the **Boot** menu to **Force BIOS**. This is to allow the “Press <CTRL+I> to enter Configuration Utility.....” message to appear during POST. Press Ctrl+I when prompted to enter the RAID configuration utility.

→ Hot Plug [Disabled]

Use the **Hot Plug** option to enable or disable the SATA device hot plug.

- **Disabled** **DEFAULT** Disables the SATA device hot plug.
- **Enabled** Enables the SATA device hot plug

5.3.9 NVMe Configuration

Use the **NVMe Configuration (BIOS Menu 15)** menu to display the NVMe controller and device information.

```
Aptio Setup Utility - Copyright (C) 2016 American Megatrends, Inc.
Advanced
NVMe controller and Drive information
No NVMe Device Found
-----
-><: Select Screen
↑↓: Select Item
Enter: Select
+/-: Change Opt.
F1: General Help
F2: Previous Values
F3: Optimized Defaults
F4: Save & Exit
ESC: Exit
Version 2.17.1255. Copyright (C) 2016 American Megatrends, Inc.
```

BIOS Menu 15: NVMe Configuration

KINO-AQ170 Industrial Motherboard

5.3.10 USB Configuration

Use the **USB Configuration** menu (**BIOS Menu 16**) to read USB configuration information and configure the USB settings.

```

Aptio Setup Utility - Copyright (C) 2016 American Megatrends, Inc.
  Advanced
USB Configuration
USB Controllers:
  1 XHCI
USB Devices:
  1 Keyboard
Legacy USB Support          [Enabled]
-----
←→: Select Screen
↑ ↓: Select Item
Enter>Select
F1   General Help
F2   Previous Values
F3   Optimized
     Defaults
F4   Save
ESC  Exit
Version 2.17.1255. Copyright (C) 2016 American Megatrends, Inc.

```

BIOS Menu 16: USB Configuration

→ USB Devices

The **USB Devices Enabled** field lists the USB devices that are enabled on the system

→ Legacy USB Support [Enabled]

Use the **Legacy USB Support** BIOS option to enable USB mouse and USB keyboard support. Normally if this option is not enabled, any attached USB mouse or USB keyboard does not become available until a USB compatible operating system is fully booted with all USB drivers loaded. When this option is enabled, any attached USB mouse or USB keyboard can control the system even when there is no USB driver loaded onto the system.

- ➔ **Enabled** **DEFAULT** Legacy USB support enabled
- ➔ **Disabled** Legacy USB support disabled
- ➔ **Auto** Legacy USB support disabled if no USB devices are connected

5.3.11 IEI Feature

Use the **IEI Feature** menu (**BIOS Menu 17**) to configure One Key Recovery function.

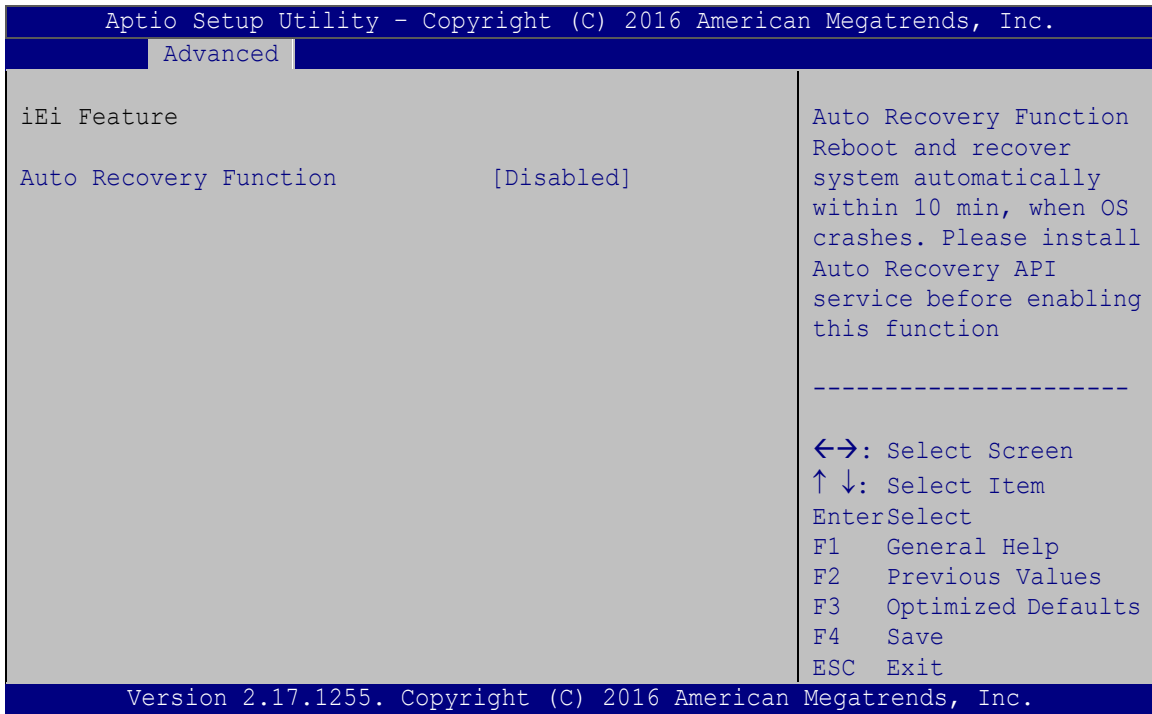

BIOS Menu 17: IEI Feature

➔ **Auto Recovery Function [Disabled]**

Use the **Auto Recovery Function** BIOS option to enable or disable the auto recovery function of the IEI One Key Recovery.

- ➔ **Disabled** **DEFAULT** Auto recovery function disabled
- ➔ **Enabled** Auto recovery function enabled

KINO-AQ170 Industrial Motherboard

5.4 Chipset

Use the **Chipset** menu (**BIOS Menu 18**) to configure the system chipset.

```

Aptio Setup Utility - Copyright (C) 2016 American Megatrends, Inc.
Main   Advanced  Chipset   Boot   Security  Save & Exit  Server Mgmt
-----
> System Agent (SA) Configuration
> PCH-IO Configuration

System Agent (SA)
Parameters

-----
<=>: Select Screen
↑↓: Select Item
Enter>Select
+ - Change Opt.
F1  General Help
F2  Previous Values
F3  Optimized Defaults
F4  Save & Exit
ESC Exit

Version 2.17.1255. Copyright (C) 2016 American Megatrends, Inc.
  
```

BIOS Menu 18: Chipset

5.4.1 System Agent (SA) Configuration

Use the **System Agent (SA) Configuration** menu (**BIOS Menu 19**) to configure the System Agent (SA) parameters.

```

Aptio Setup Utility - Copyright (C) 2016 American Megatrends, Inc.
-----
Chipset
-----
VT-d          Supported
VT-d          [Disabled]

> Graphics Configuration
> PEG Port Configuration
> Memory Configuration

VT-d capability

-----
<=>: Select Screen
↑↓: Select Item
Enter>Select
+ - Change Opt.
F1  General Help
F2  Previous Values
F3  Optimized Defaults
F4  Save & Exit
ESC Exit

Version 2.17.1255. Copyright (C) 2016 American Megatrends, Inc.
  
```

BIOS Menu 19: System Agent (SA) Configuration

→ VT-d [Disabled]

Use the **VT-d** option to enable or disable VT-d support.

- **Disabled** **DEFAULT** Disable VT-d support.
- **Enabled** Enable VT-d support.

5.4.1.1 Graphics Configuration

Use the **Graphics Configuration** menu (**BIOS Menu 20**) to configure the graphics settings.

```

Aptio Setup Utility - Copyright (C) 2016 American Megatrends, Inc.
Chipset
Graphics Configuration
Primary Display                [Auto]
Internal Graphics              [Enabled]
DVMT Pre-Allocated            [256M]
DVMT Total Gfx Mem            [MAX]
Primary IGFX Boot Display     [VBIOS Default]
HDMI_DP Switch Status        [Display Port(DP)]

Select which of
IGFX/PEG/PCI Graphics
device should be Primary
Display Or select SG for
Switchable Gfx.
-----
←→: Select Screen
↑↓: Select Item
Enter>Select
+ - Change Opt.
F1  General Help
F2  Previous Values
F3  Optimized Defaults
F4  Save & Exit
ESC Exit

Version 2.17.1255. Copyright (C) 2016 American Megatrends, Inc.
    
```

BIOS Menu 20: Graphics Configuration

→ Primary Display [Auto]

Use the **Primary Display** option to select the graphics controller used as the primary boot device. Configuration options are listed below:

- Auto **DEFAULT**
- IGFX
- PEG
- PCIE

KINO-AQ170 Industrial Motherboard

→ Internal Graphics [Enabled]

Use the **Internal Graphics** option to enable or disable the internal graphics device.

- **Auto** The internal graphics device is automatically detected and enabled.
- **Disabled** Disable the internal graphics device.
- **Enabled** **DEFAULT** Enable the internal graphics device. The following options/submenu appear with values that can be selected:

DVMT Pre-Allocated

DVMT Total Gfx Mem

LCD Control

→ DVMT Pre-Allocated [256M]

Use the **DVMT Pre-Allocated** option to set the amount of system memory allocated to the integrated graphics processor when the system boots. The system memory allocated can then only be used as graphics memory, and is no longer available to applications or the operating system. Configuration options are listed below:

- 32M
- 64M
- 128M
- 256M **DEFAULT**
- 512M

→ DVMT Total Gfx Mem [MAX]

Use the **DVMT Total Gfx Mem** option to select DVMT 5.0 total graphic memory size used by the internal graphics device. The following options are available:

- 128M
- 256M
- MAX **DEFAULT**

→ Primary IGFX Boot Display [VBIOS Default]

Use the **Primary IGFX Boot Display** option to select the display device used by the system when it boots.

- VBIOS Default **DEFAULT**
- HDMI 2.0
- CRT
- IDP
- DP1.2/HDMI

5.4.1.2 PEG Port Configuration

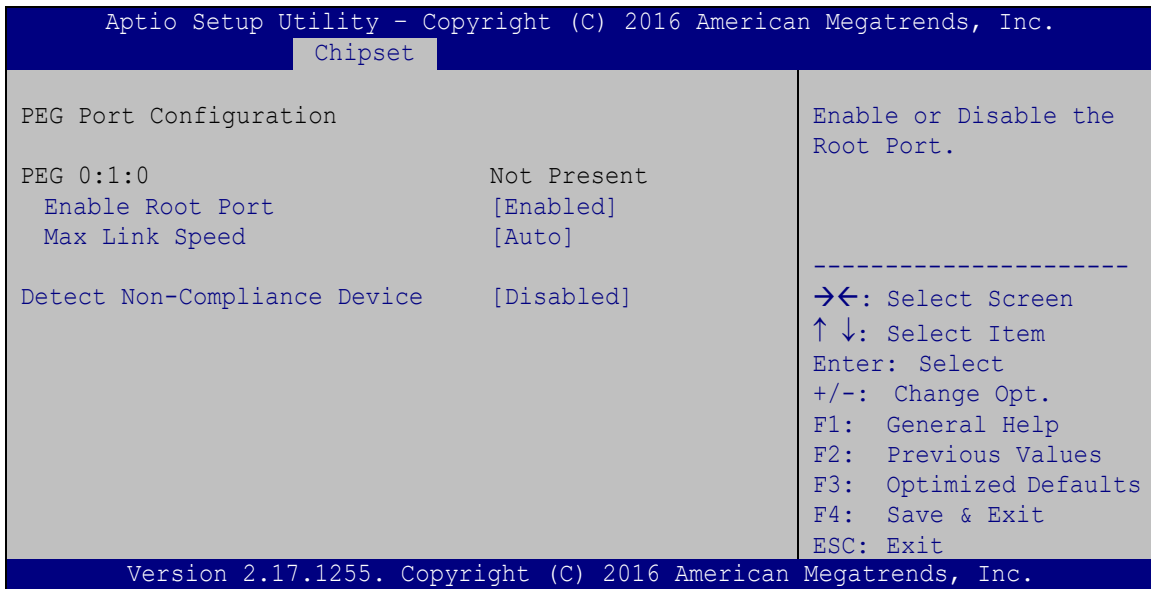

BIOS Menu 21: PEG Port Configuration

→ Enable Root Port [Enabled]

Use the **Enable Root Port** option to enable or disable the PCI Express (PEG) controller.

- **Disabled** Disables the PCI Express (PEG) controller.
- **Enabled** **DEFAULT** Enables the PCI Express (PEG) controller.

KINO-AQ170 Industrial Motherboard

→ Max Link Speed [Auto]

Use the **Max Link Speed** option to select the maximum link speed of the PCI Express slot.

The following options are available:

- Auto **Default**
- Gen1
- Gen2
- Gen3

→ Detect Non-Compliance Device [Disabled]

Use the **Detect Non-Compliance Device** option to enable or disable detecting if a non-compliance PCI Express device is connected to the PCI Express slot.

- **Disabled** **DEFAULT** Disables to detect if a non-compliance PCI Express device is connected to the PCI Express slot.

- **Enabled** Enables to detect if a non-compliance PCI Express device is connected to the PCI Express slot.

5.4.1.3 Memory Configuration

Use the **Memory Configuration** submenu (**BIOS Menu 22**) to display the memory information.

```

Aptio Setup Utility - Copyright (C) 2016 American Megatrends, Inc.
Chipset
Memory Information
Total Memory          8192 MB
DIMM#0                8192 MB
DIMM#2                Not Present
-----
<->: Select Screen
↑ ↓: Select Item
EnterSelect
+ - Change Opt.
F1  General Help
F2  Previous Values
F3  Optimized Defaults
F4  Save & Exit
ESC Exit

Version 2.17.1255. Copyright (C) 2016 American Megatrends, Inc.
  
```

BIOS Menu 22: Memory Configuration

5.4.2 PCH-IO Configuration

Use the **PCH-IO Configuration** menu (**BIOS Menu 23**) to configure the PCH-IO chipset.

```

Aptio Setup Utility - Copyright (C) 2016 American Megatrends, Inc.
Chipset
Auto Power Button Status [Disable (ATX)]
Restore AC Power Loss    [Last State]
-----
> PCI Express Configuration
> HD Audio Configuration
Power Saving Function(ERP) [Disabled]
USB Power SW1             [+5V DUAL]
USB Power SW2            [+5V DUAL]
-----
<->: Select Screen
↑ ↓: Select Item
EnterSelect
+ - Change Opt.
F1  General Help
F2  Previous Values
F3  Optimized Defaults
F4  Save & Exit
ESC Exit

Version 2.17.1255. Copyright (C) 2016 American Megatrends, Inc.
  
```

BIOS Menu 23: PCH-IO Configuration

KINO-AQ170 Industrial Motherboard

→ Restore AC Power Loss [Last State]

Use the **Restore AC Power** BIOS option to specify what state the system returns to if there is a sudden loss of power to the system.

- **Power Off** The system remains turned off
- **Power On** The system turns on
- **Last State** **DEFAULT** The system returns to its previous state. If it was on, it turns itself on. If it was off, it remains off.

→ Power Saving Function(ERP) [Disabled]

Use the **Power Saving Function(ERP)** BIOS option to enable or disable the power saving function.

- **Disabled** **DEFAULT** Power saving function is disabled.
- **Enabled** Power saving function is enabled. It will reduce power consumption when the system is off.

→ USB Power SW1 [+5V DUAL]

Use the **USB Power SW1** BIOS option to configure the USB power source for the corresponding USB connectors (**Table 5-1**).

- **+5V DUAL** **DEFAULT** Sets the USB power source to +5V dual
- **+5V** Sets the USB power source to +5V

→ USB Power SW2 [+5V DUAL]

Use the **USB Power SW2** BIOS option to configure the USB power source for the corresponding USB connectors (**Table 5-1**).

- **+5V DUAL** **DEFAULT** Sets the USB power source to +5V dual
- **+5V** Sets the USB power source to +5V

BIOS Options	Configured USB Ports
USB Power SW1	K/M_USB1 (external USB 2.0 ports) LAN1_USB1 (external USB 3.2 Gen 1 ports) LAN2_USB2 (external USB 3.2 Gen 1 ports)
USB Power SW2	USB1 (internal USB 2.0 ports) USB2 (internal USB 2.0 ports)

Table 5-1: BIOS Options and Configured USB Ports

5.4.2.1 PCI Express Configuration

Use the **PCI Express Configuration** submenu (**BIOS Menu 24**) to configure the PCI Express slots.

```

Aptio Setup Utility - Copyright (C) 2016 American Megatrends, Inc.
Chipset
PCI Express Configuration
> MPCIE1 Slot
M_PCIE_1 Slot Settings.
-----
<->: Select Screen
↑ ↓: Select Item
EnterSelect
+ - Change Opt.
F1 General Help
F2 Previous Values
F3 Optimized Defaults
F4 Save & Exit
ESC Exit

Version 2.17.1255. Copyright (C) 2016 American Megatrends, Inc.

```

BIOS Menu 24: PCI Express Configuration

The **MPCIE1 Slot** submenu contains the following options:

→ PCIe Speed [Auto]

Use the **PCIe Speed** option to configure the PCIe interface speed.

- Auto **DEFAULT**

KINO-AQ170 Industrial Motherboard

- Gen 1
- Gen 2
- Gen 3

→ Detect Non-Compliance Device [Disabled]

Use the **Detect Non-Compliance Device** option to enable or disable detecting if a non-compliance PCI Express device is connected to the PCI Express slot.

- **Disabled** **DEFAULT** Disables to detect if a non-compliance PCI Express device is connected to the PCI Express slot.
- **Enabled** Enables to detect if a non-compliance PCI Express device is connected to the PCI Express slot.

5.4.2.2 HD Audio Configuration

Use the **HD Audio Configuration** submenu (**BIOS Menu 25**) to configure the High Definition Audio codec.

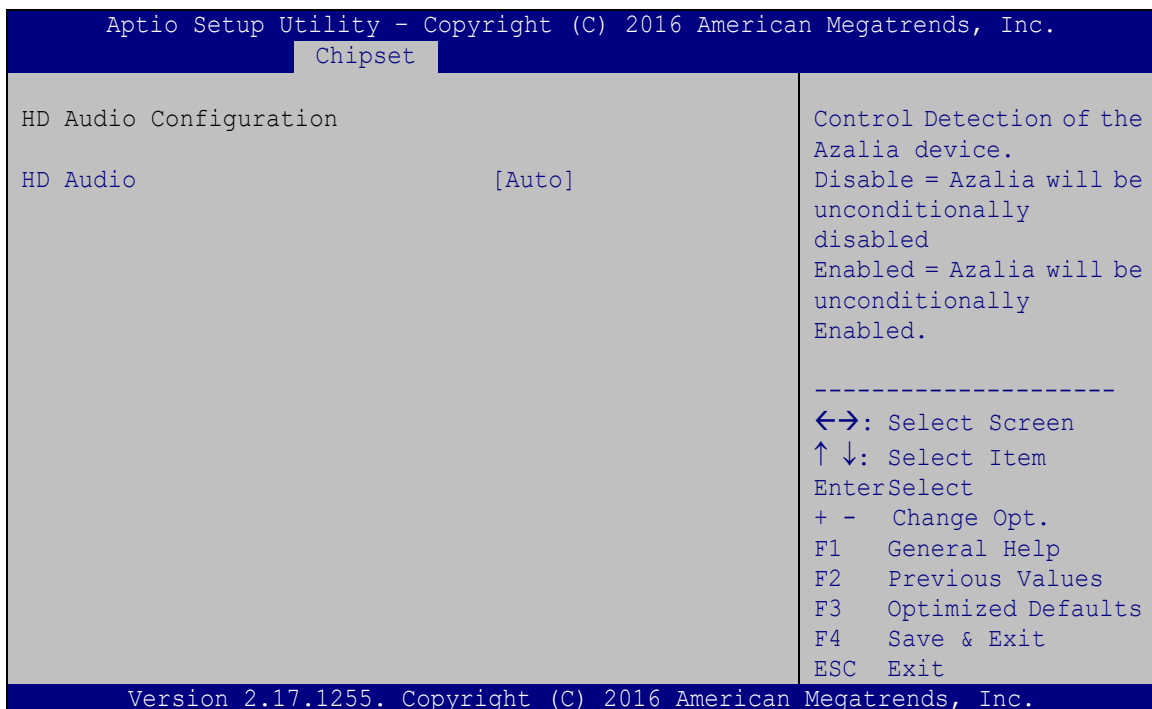

BIOS Menu 25: HD Audio Configuration

→ HD Audio [Auto]

Use the **HD Audio** BIOS option to enable or disable the High Definition Audio controller.

- **Disabled** The High Definition Audio controller is disabled.
- **Enabled** The High Definition Audio controller is enabled.
- **Auto** **DEFAULT** The onboard High Definition Audio controller automatically detected and enabled.

5.5 Security

Use the **Security** menu (**BIOS Menu 26**) to set system and user passwords.

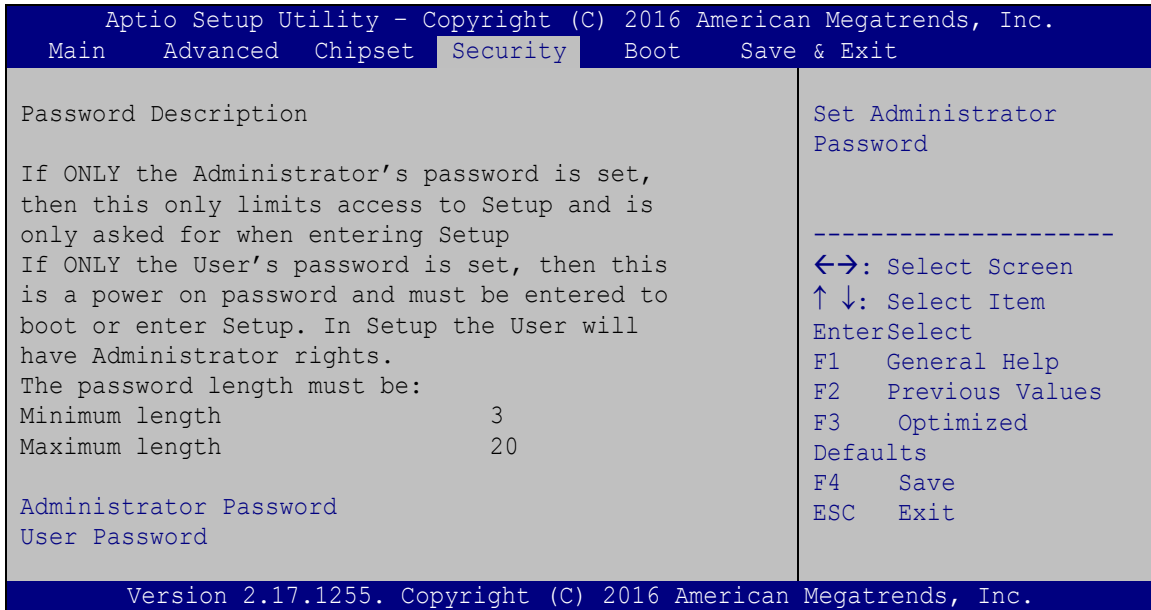

BIOS Menu 26: Security

→ Administrator Password

Use the **Administrator Password** to set or change a administrator password.

→ User Password

Use the **User Password** to set or change a user password.

KINO-AQ170 Industrial Motherboard

5.6 Boot

Use the **Boot** menu (**BIOS Menu 27**) to configure system boot options.

```

Aptio Setup Utility - Copyright (C) 2016 American Megatrends, Inc.
Main   Advanced  Chipset  Security  Boot   Save & Exit
-----
Boot Configuration
Bootup NumLock State      [On]
Quiet Boot                 [Enabled]
Launch PXE OpROM          [Disabled]
Option ROM Messages       [Force BIOS]
UEFI Boot                 [Disabled]

Driver Option Priorities
Boot Option Priorities

Select the keyboard
NumLock state

-----
←→: Select Screen
↑↓: Select Item
EnterSelect
F1  General Help
F2  Previous Values
F3  Optimized Defaults
F4  Save
ESC Exit

Version 2.17.1255. Copyright (C) 2016 American Megatrends, Inc.
  
```

BIOS Menu 27: Boot

→ Bootup NumLock State [On]

Use the **Bootup NumLock State** BIOS option to specify if the number lock setting must be modified during boot up.

→ **On** **DEFAULT** Allows the Number Lock on the keyboard to be enabled automatically when the computer system boots up. This allows the immediate use of the 10-key numeric keypad located on the right side of the keyboard. To confirm this, the Number Lock LED light on the keyboard is lit.

→ **Off** Does not enable the keyboard Number Lock automatically. To use the 10-keys on the keyboard, press the Number Lock key located on the upper left-hand corner of the 10-key pad. The Number Lock LED on the keyboard lights up when the Number Lock is engaged.

→ Quiet Boot [Enabled]

Use the **Quiet Boot** BIOS option to select the screen display when the system boots.

- **Disabled** Normal POST messages displayed
- **Enabled** **DEFAULT** OEM Logo displayed instead of POST messages

→ Launch PXE OpROM [Disabled]

Use the **Launch PXE OpROM** option to enable or disable boot option for legacy network devices.

- **Disabled** **DEFAULT** Ignore all PXE Option ROMs
- **Enabled** Load PXE Option ROMs.

→ Option ROM Messages [Force BIOS]

Use the **Option ROM Messages** option to set the Option ROM display mode.

- **Force BIOS** **DEFAULT** Sets display mode to force BIOS.
- **Keep Current** Sets display mode to current.

→ UEFI Boot [Disabled]

Use the **UEFI Boot** option to enable or disable to boot from the UEFI devices.

- **Enabled** Boot from UEFI devices is enabled.
- **Disabled** **DEFAULT** Boot from UEFI devices is disabled.

→ Boot Option Priority

Use the **Boot Option Priority** function to set the system boot sequence from the available devices. The drive sequence also depends on the boot sequence in the individual device section.

KINO-AQ170 Industrial Motherboard

5.7 Save & Exit

Use the **Save & Exit** menu (**BIOS Menu 28**) to load default BIOS values, optimal failsafe values and to save configuration changes.

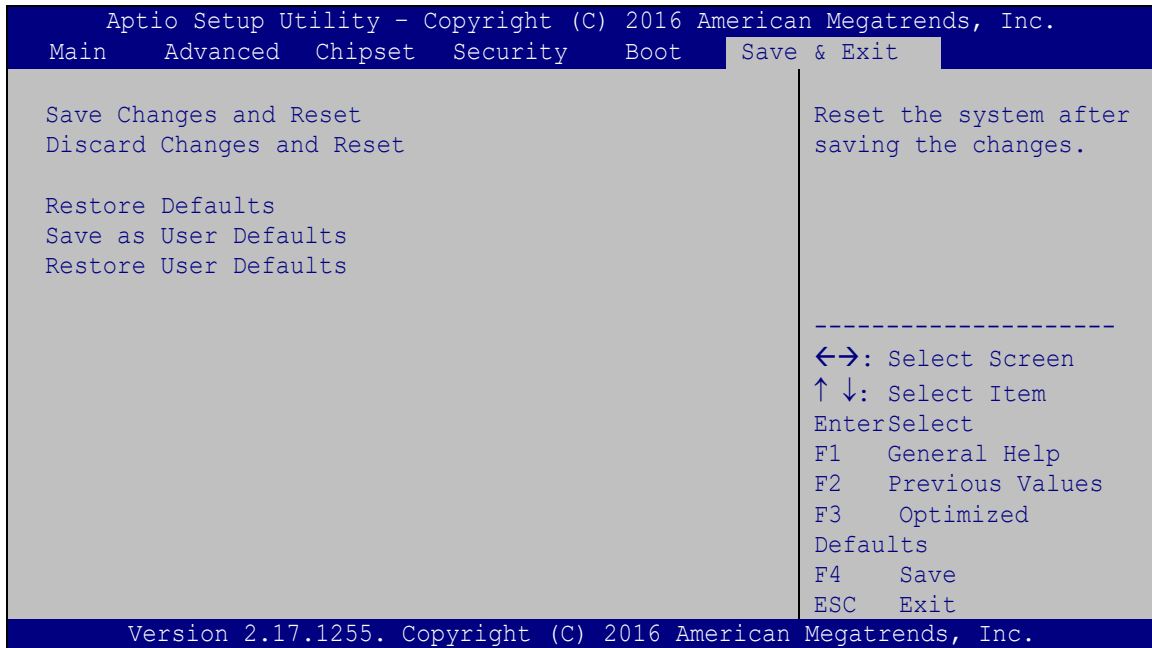

BIOS Menu 28: Exit

→ Save Changes and Reset

Use the **Save Changes and Reset** option to save the changes made to the BIOS options and to exit the BIOS configuration setup program.

→ Discard Changes and Reset

Use the **Discard Changes and Reset** option to exit the system without saving the changes made to the BIOS configuration setup program.

→ Restore Defaults

Use the **Restore Defaults** option to load the optimal default values for each of the parameters on the Setup menus. **F3 key can be used for this operation.**

→ **Save as User Defaults**

Use the **Save as User Defaults** option to save the changes done so far as user defaults.

→ **Restore User Defaults**

Use the **Restore User Defaults** option to restore the user defaults to all the setup options.

Chapter

6

Software Drivers

6.1 Available Drivers

All the drivers for the KINO-AQ170 are available on IEI Resource Download Center (<https://download.ieiworld.com>). Type KINO-AQ170 and press Enter to find all the relevant software, utilities, and documentation.

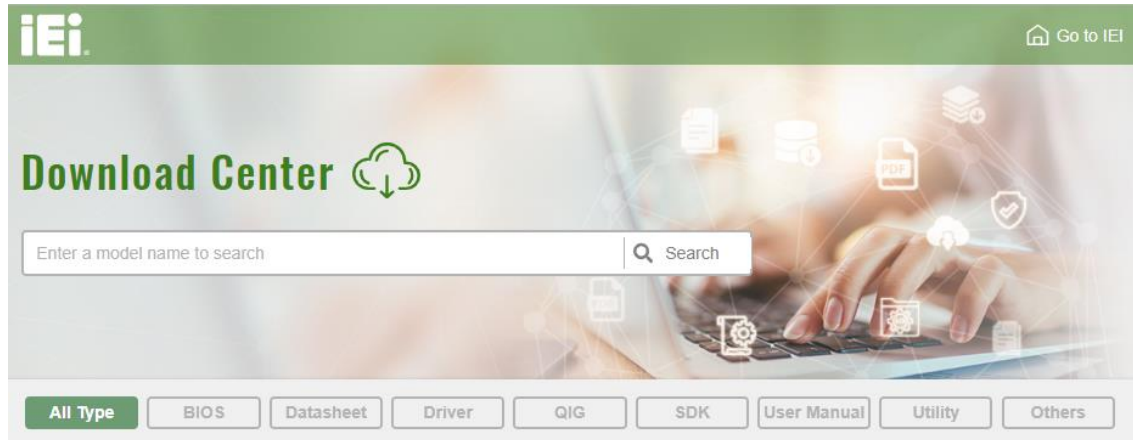
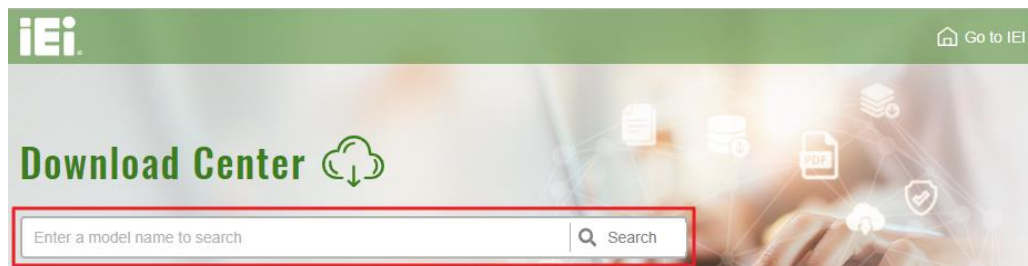

Figure 6-1: IEI Resource Download Center

6.2 Driver Download

To download drivers from IEI Resource Download Center, follow the steps below.

Step 1: Go to <https://download.ieiworld.com>. Type KINO-AQ170 and press Enter.



Step 2: All product-related software, utilities, and documentation will be listed. You can choose **Driver** to filter the result.

KINO-AQ170 Industrial Motherboard

[All Type](#)
[BIOS](#)
[Datasheet](#)
[Driver](#)
[QIG](#)
[SDK](#)
[User Manual](#)
[Utility](#)
[Others](#)

Keyword: "KINO-AQ170", Searching Result : 13 Records.

KINO-AQ170 [Product Info](#)

[Embedded Computer](#) > [Single Board Computer](#) > [Industrial Motherboard](#)

Mini-ITX SBC supports LGA 1151 Intel® Core™ i7/i5/i3, Pentium® or Celeron® CPU with Intel® Q170

Driver

File Name	Published	Version	File Checksum
7B000-001167-RS_V1.8.iso (1.13 GB)	2017/10/16	1.80	114B70CE3AE5F6E58D3E61586F2D255A

Step 3: Click the driver file name on the page and you will be prompted with the following window. You can download the entire ISO file (❶), or double click an individual item to find its driver file and click the file name to download (❷).

7B000-001167-RS_V1.8.iso

❶ [Click here to download entire ISO file, \(1.13 GB\)](#)

* Download individual file *

- Docs
 - 1.Chipset
 - ❷ WIN10&8.1&7.zip (2.68 MB)
 - 2.VGA
 - 3.LAN
 - 3.LAN(IMB-H110)
 - 4.Audio
 - 5.USB3.0
 - 6.KMDF
 - 7.ME
 - 8.RST
 - 9.Serial IO
 - A.Manual



NOTE:

To install software from the downloaded ISO image file in Windows 8, 8.1 or 10, double-click the ISO file to mount it as a virtual drive to view its content. On Windows 7 system, an additional tool (such as Virtual CD-ROM Control Panel from Microsoft) is needed to mount the file.

Appendix

A

Regulatory Compliance

KINO-AQ170 Industrial Motherboard

DECLARATION OF CONFORMITY



This equipment has been tested and found to comply with specifications for CE marking. If the user modifies and/or installs other devices in the equipment, the CE conformity declaration may no longer apply.

FCC WARNING



This equipment complies with Part 15 of the FCC Rules. Operation is subject to the following two conditions:

- This device may not cause harmful interference, and
- This device must accept any interference received, including interference that may cause undesired operation.

This equipment has been tested and found to comply with the limits for a Class A digital device, pursuant to part 15 of the FCC Rules. These limits are designed to provide reasonable protection against harmful interference when the equipment is operated in a commercial environment. This equipment generates, uses, and can radiate radio frequency energy and, if not installed and used in accordance with the instruction manual, may cause harmful interference to radio communications. Operation of this equipment in a residential area is likely to cause harmful interference in which case the user will be required to correct the interference at his own expense.

Appendix

B

Product Disposal

KINO-AQ170 Industrial Motherboard



CAUTION:

Risk of explosion if battery is replaced by an incorrect type. Only certified engineers should replace the on-board battery.

Dispose of used batteries according to instructions and local regulations.

- Outside the European Union – If you wish to dispose of used electrical and electronic products outside the European Union, please contact your local authority so as to comply with the correct disposal method.
- Within the European Union – The device that produces less waste and is easier to recycle is classified as electronic device in terms of the European Directive 2012/19/EU (WEEE), and must not be disposed of as domestic garbage.

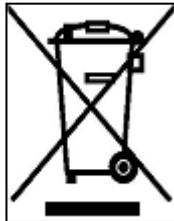

EU-wide legislation, as implemented in each Member State, requires that waste electrical and electronic products carrying the mark (left) must be disposed of separately from normal household waste. This includes monitors and electrical accessories, such as signal cables or power cords. When you need to dispose of your device, please follow the guidance of your local authority, or ask the shop where you purchased the product. The mark on electrical and electronic products only applies to the current European Union Member States.

Please follow the national guidelines for electrical and electronic product disposal.

Appendix

C

BIOS Menu Options

KINO-AQ170 Industrial Motherboard

ACPI Sleep State [S3 (Suspend to RAM)].....	85
Intel AMT [Enabled]	86
Un-configure ME [Disabled].....	86
Case Open Beep [Disabled].....	87
Serial Port [Enabled].....	88
Change Settings [Auto]	88
Serial Port [Enabled].....	89
Change Settings [Auto]	89
Serial Port [Enabled].....	90
Change Settings [Auto]	90
Serial Port [Enabled].....	91
Change Settings [Auto]	91
Serial Port [Enabled].....	92
Change Settings [Auto]	92
Transfer Mode [RS232].....	93
Serial Port [Enabled].....	93
Change Settings [Auto]	93
Transfer Mode [RS232].....	94
PC Health Status	95
CPU_FAN1 Smart Fan Control [Auto Mode]	96
SYS_FAN1 Smart Fan Control [Auto Mode].....	97
Auto mode fan start temperature [50].....	97
Auto mode fan off temperature [40].....	98
Auto mode fan start PWM [30].....	98
Auto mode fan slope PWM [1]	98
Wake system with Fixed Time [Disabled].....	99
Console Redirection [Disabled].....	101
Legacy Serial Redirection Port [COM1].....	101
Terminal Type [ANSI].....	102
Bits per second [115200].....	103
Data Bits [8]	103
Parity [None].....	103
Stop Bits [1].....	104
Active Processor Cores [All]	105

Intel® Virtualization Technology [Disabled]	105
Intel® SpeedStep™ [Enabled]	105
CPU C State [Disabled].....	105
Intel TXT(LT) Support [Disabled].....	106
STAT Controller(s) [Enabled].....	106
SATA Mode Selection [AHCI].....	107
Hot Plug [Disabled]	107
USB Devices	109
Legacy USB Support [Enabled].....	109
Auto Recovery Function [Disabled].....	110
VT-d [Disabled].....	112
Primary Display [Auto]	112
Internal Graphics [Enabled].....	113
DVMT Pre-Allocated [256M]	113
DVMT Total Gfx Mem [MAX].....	113
Primary IGFX Boot Display [VBIOS Default]	114
Enable Root Port [Enabled]	114
Max Link Speed [Auto]	115
Detect Non-Compliance Device [Disabled]	115
Restore AC Power Loss [Last State]	117
Power Saving Function(ERP) [Disabled].....	117
USB Power SW1 [+5V DUAL].....	117
USB Power SW2 [+5V DUAL].....	117
PCIe Speed [Auto].....	118
Detect Non-Compliance Device [Disabled]	119
HD Audio [Auto].....	120
Administrator Password	120
User Password	120
Bootup NumLock State [On].....	121
Quiet Boot [Enabled]	122
Launch PXE OpROM [Disabled].....	122
Option ROM Messages [Force BIOS].....	122
UEFI Boot [Disabled]	122
Boot Option Priority.....	122
Save Changes and Reset	123

KINO-AQ170 Industrial Motherboard

Discard Changes and Reset	123
Restore Defaults	123
Save as User Defaults	124
Restore User Defaults	124

Appendix

D

Digital I/O Interface

KINO-AQ170 Industrial Motherboard

D.1 Introduction

The DIO connector on the KINO-AQ170 is interfaced to GPIO ports on the Super I/O chipset. The DIO has both 8-bit digital inputs and 8-bit digital outputs. The digital inputs and digital outputs are generally control signals that control the on/off circuit of external devices or TTL devices. Data can be read or written to the selected address to enable the DIO functions.



NOTE:

For further information, please refer to the datasheet for the Super I/O chipset.

The BIOS interrupt call **INT 15H** controls the digital I/O.

INT 15H:

AH – 6FH	
<u>Sub-function:</u>	
AL – 8	:Set the digital port as INPUT
AL	:Digital I/O input value

D.2 Assembly Language Sample 1

```

MOV    AX, 6F08H    ;setting the digital port as input
INT    15H          ;
    
```

AL low byte = value

AH – 6FH	
<u>Sub-function:</u>	
AL – 9	:Set the digital port as OUTPUT
BL	:Digital I/O input value

D.3 Assembly Language Sample 2

```

MOV    AX, 6F09H    ;setting the digital port as output
MOV    BL, 09H      ;digital value is 09H
INT    15H          ;
    
```

Digital Output is 1001b

Appendix

E

Watchdog Timer



NOTE:

The following discussion applies to DOS. Contact IEI support or visit the IEI website for drivers for other operating systems.

The Watchdog Timer is a hardware-based timer that attempts to restart the system when it stops working. The system may stop working because of external EMI or software bugs. The Watchdog Timer ensures that standalone systems like ATMs will automatically attempt to restart in the case of system problems.

A BIOS function call (INT 15H) is used to control the Watchdog Timer.

INT 15H:

AH – 6FH Sub-function:	
AL – 2:	Sets the Watchdog Timer's period.
BL:	Time-out value (Its unit-second is dependent on the item "Watchdog Timer unit select" in CMOS setup).

Table E-1: AH-6FH Sub-function

Call sub-function 2 to set the time-out period of Watchdog Timer first. If the time-out value is not zero, the Watchdog Timer starts counting down. When the timer value reaches zero, the system resets. To ensure that this reset condition does not occur, calling sub-function 2 must periodically refresh the Watchdog Timer. However, the watchdog timer is disabled if the time-out value is set to zero.

A tolerance of at least 10% must be maintained to avoid unknown routines within the operating system (DOS), such as disk I/O that can be very time-consuming.

KINO-AQ170 Industrial Motherboard

**NOTE:**

The Watchdog Timer is activated through software. The software application that activates the Watchdog Timer must also deactivate it when closed. If the Watchdog Timer is not deactivated, the system will automatically restart after the Timer has finished its countdown.

EXAMPLE PROGRAM:

; INITIAL TIMER PERIOD COUNTER

;

W_LOOP:

;

```

MOV      AX, 6F02H      ;setting the time-out value
MOV      BL, 30         ;time-out value is 48 seconds
INT      15H

```

;

; ADD THE APPLICATION PROGRAM HERE

;

```

CMP      EXIT_AP, 1     ;is the application over?
JNE      W_LOOP        ;No, restart the application

```

```

MOV      AX, 6F02H      ;disable Watchdog Timer
MOV      BL, 0          ;
INT      15H

```

;

; EXIT ;

Appendix

F

Error Beep Code

KINO-AQ170 Industrial Motherboard

F.1 PEI Beep Codes

Number of Beeps	Description
1	Memory not Installed
1	Memory was installed twice (InstallPeiMemory routine in PEI Core called twice)
2	Recovery started
3	DXEIPL was not found
3	DXE Core Firmware Volume was not found
4	Recovery failed
4	S3 Resume failed
7	Reset PPI is not available

F.2 DXE Beep Codes

Number of Beeps	Description
1	Invalid password
4	Some of the Architectural Protocols are not available
5	No Console Output Devices are found
5	No Console Input Devices are found
6	Flash update is failed
7	Reset protocol is not available
8	Platform PCI resource requirements cannot be met

**NOTE:**

If you have any question, please contact IEI for further assistance.

Appendix

G

Hazardous Materials Disclosure

KINO-AQ170 Industrial Motherboard

G.1 RoHS II Directive (2015/863/EU)

The details provided in this appendix are to ensure that the product is compliant with the RoHS II Directive (2015/863/EU). The table below acknowledges the presences of small quantities of certain substances in the product, and is applicable to RoHS II Directive (2015/863/EU).

Please refer to the following table.

Part Name	Toxic or Hazardous Substances and Elements									
	Lead (Pb)	Mercury (Hg)	Cadmium (Cd)	Hexavalent Chromium (CR(VI))	Polybrominated Biphenyls (PBB)	Polybrominated Diphenyl Ethers (PBDE)	Bis(2-ethylhexyl) phthalate (DEHP)	Butyl benzyl phthalate (BBP)	Dibutyl phthalate (DBP)	Diisobutyl phthalate (DIBP)
Housing	O	O	O	O	O	O	O	O	O	O
Display	O	O	O	O	O	O	O	O	O	O
Printed Circuit Board	O	O	O	O	O	O	O	O	O	O
Metal Fasteners	O	O	O	O	O	O	O	O	O	O
Cable Assembly	O	O	O	O	O	O	O	O	O	O
Fan Assembly	O	O	O	O	O	O	O	O	O	O
Power Supply Assemblies	O	O	O	O	O	O	O	O	O	O
Battery	O	O	O	O	O	O	O	O	O	O

O: This toxic or hazardous substance is contained in all of the homogeneous materials for the part is below the limit requirement in Directive (EU) 2015/863.

X: This toxic or hazardous substance is contained in at least one of the homogeneous materials for this part is above the limit requirement in Directive (EU) 2015/863.

G.2 China RoHS

此附件旨在确保本产品符合中国 RoHS 标准。以下表格标示此产品中某有毒物质的含量符合中国 RoHS 标准规定的限量要求。

本产品上会附有“环境友好使用期限”的标签，此期限是估算这些物质“不会有泄漏或突变”的年限。本产品可能包含有较短的环境友好使用期限的可替换元件，像是电池或灯管，这些元件将会单独标示出来。

部件名称	有毒有害物质或元素					
	铅 (Pb)	汞 (Hg)	镉 (Cd)	六价铬 (CR(VI))	多溴联苯 (PBB)	多溴二苯醚 (PBDE)
壳体	○	○	○	○	○	○
显示	○	○	○	○	○	○
印刷电路板	○	○	○	○	○	○
金属螺帽	○	○	○	○	○	○
电缆组装	○	○	○	○	○	○
风扇组装	○	○	○	○	○	○
电力供应组装	○	○	○	○	○	○
电池	○	○	○	○	○	○
<p>○: 表示该有毒有害物质在该部件所有物质材料中的含量均在 SJ/T11364-2014 與 GB/T26572-2011 标准规定的限量要求以下。</p> <p>X: 表示该有毒有害物质至少在该部件的某一均质材料中的含量超出 SJ/T11364-2014 與 GB/T26572-2011 标准规定的限量要求。</p>						