

Board Layout and Jumper Settings

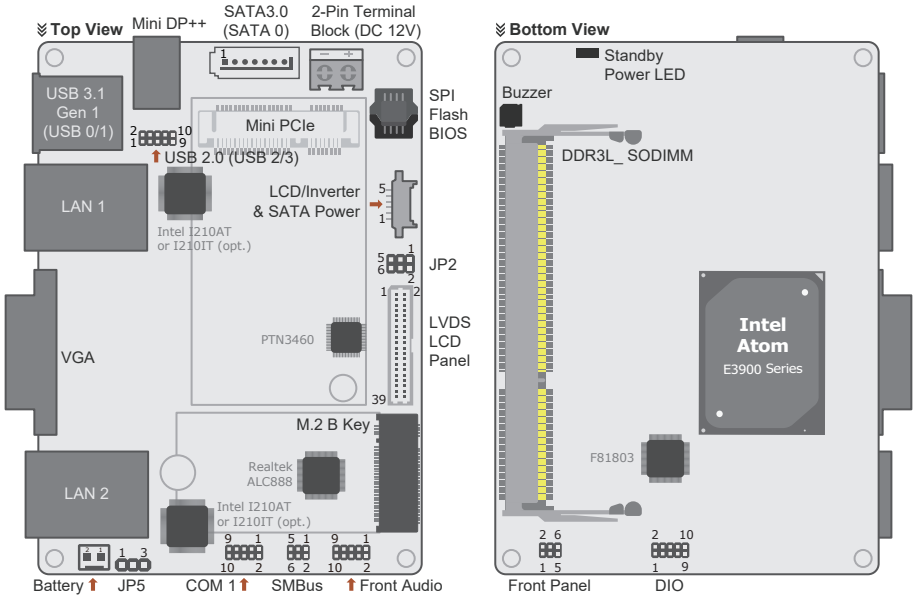

LVDS Panel Power Select JP2

+5V	1-3 On
+3.3V (default)	3-5 On

Power-on Select JP2

Power On via Power Button	2-4 On
Power On via AC Power	4-6 On

M.2 Signal Select JP5

SATA (default)	1-2 On
PCIe	2-3 On

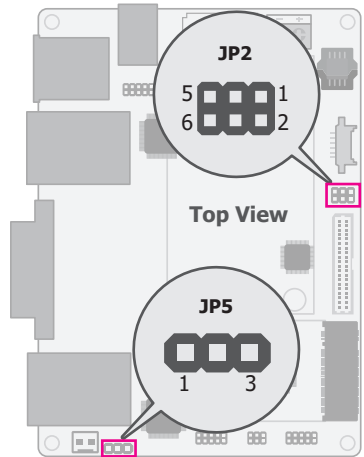

Pin Assignment

USB 2.0 Headers (USB 2/3)

Pin	Assignment	Pin	Assignment
1	VCC	2	VCC
3	Data0-	4	Data1-
5	Data0+	6	Data1+
7	GND	8	GND
9	---	10	N.C.

COM Port (COM 1)

Pin	RS232	RS422	RS485
1	DCD-	TX-	DATA-
2	RD	TX+	DATA+
3	TD	RX+	NC
4	DTR-	RX-	NC
5	GND	GND	GND
6	DSR-	NC	NC
7	RTS-	NC	NC
8	CTS-	NC	NC
9	RI-	NC	NC
10	GND	GND	NC

Front Audio

Pin	Assignment	Pin	Assignment
1	Mic-L	2	GND
3	Mic-R	4	N.C.
5	Line-R	6	Mic-JD
7	GND	8	---
9	Line-L	10	Line-JD

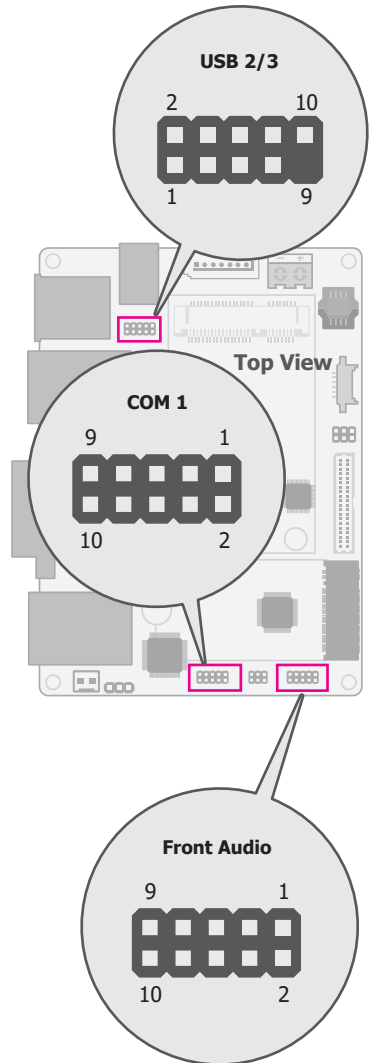

LVDS LCD Panel Connector

Pin	Assignment	Pin	Assignment
1	GND	2	GND
3	LVDS_Out3+	4	LVDS_Out7+
5	LVDS_Out3-	6	LVDS_Out7-
7	GND	8	GND
9	LVDS_Out2+	10	LVDS_Out6+
11	LVDS_Out2-	12	LVDS_Out6-
13	GND	14	GND
15	LVDS_Out1+	16	LVDS_Out5+
17	LVDS_Out1-	18	LVDS_Out5-
19	GND	20	GND
21	LVDS_Out0+	22	LVDS_Out4+
23	LVDS_Out0-	24	LVDS_Out4-
25	GND	26	GND
27	LVDS_CLK1+	28	LVDS_CLK2+
29	LVDS_CLK1-	30	LVDS_CLK2-
31	GND	32	GND
33	DDC_CLK	34	N.C.
35	DDC_DATA	36	+3.3V
37	Panel Power	38	Panel Power
39	Panel Power	40	Panel Power

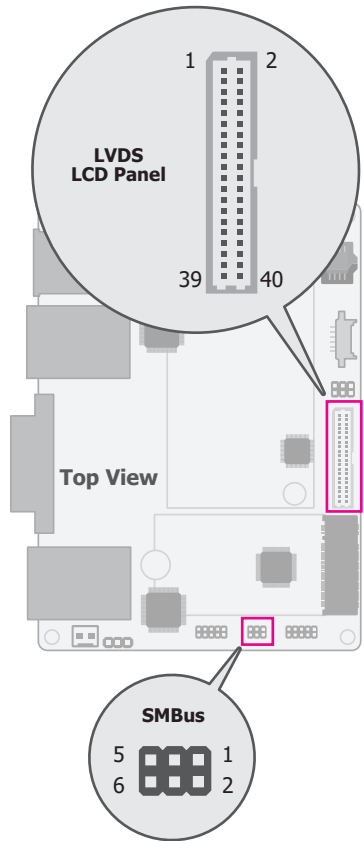

SMBus

Pin	Assignment	Pin	Assignment
1	3V3SB	2	GND
3	SMB_CLK	4	SMB_DATA
5	SMB_ALERT	6	GND

Digital I/O (DIO)

Pin	Assignment	Pin	Assignment
1	DIO07	2	DIO06
3	DIO05	4	DIO04
5	DIO03	6	DIO02
7	DIO01	8	DIO00
9	5V	10	GND

Front Panel

Pin	Assignment	Pin	Assignment		
HDD-LED	6	HDD LED	PWR-BTN	1	Power Button
	3	GND		3	GND
RESET	3	GND	PWR-LED	2	LED Power
	5	Reset Signal		4	LED Signal

LCD/Inverter & SATA Power Connector

Pin	Assignment	Pin	Assignment
1	+12V	4	Dimming Control
2	GND	5	+5V
3	Backlight On/Off		

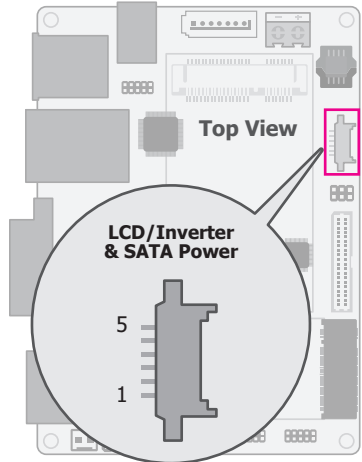
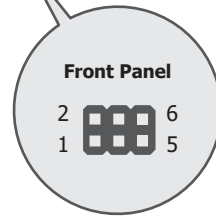
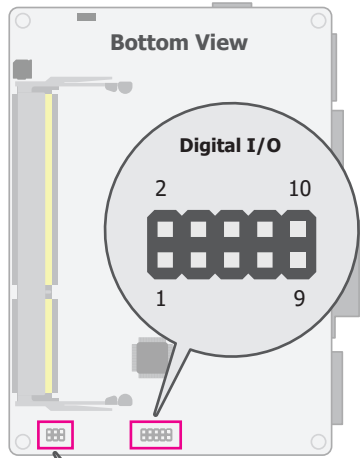

DFI reserves the right to change the specifications at any time prior to the product's release. This QR may be based on editions that do not resemble your actual products. For more documentation and drivers, please visit the download page at go.dfi.com/AL051, or via the QR code to the right.

