

**MODEL:
PM-BT**

**PC/104-Plus SBC with Intel® Celeron®/Atom™
On-board SoC, DDR3L, VGA, LVDS, GbE, USB 2.0,
SATA 3Gb/s, RS-232/422/485, 5 V DC Input and RoHS**

User Manual

Rev. 1.00 – May 31, 2018



Revision

Date	Version	Changes
May 31, 2018	1.00	Initial release

Copyright

COPYRIGHT NOTICE

The information in this document is subject to change without prior notice in order to improve reliability, design and function and does not represent a commitment on the part of the manufacturer.

In no event will the manufacturer be liable for direct, indirect, special, incidental, or consequential damages arising out of the use or inability to use the product or documentation, even if advised of the possibility of such damages.

This document contains proprietary information protected by copyright. All rights are reserved. No part of this manual may be reproduced by any mechanical, electronic, or other means in any form without prior written permission of the manufacturer.

TRADEMARKS

All registered trademarks and product names mentioned herein are used for identification purposes only and may be trademarks and/or registered trademarks of their respective owners.

Manual Conventions



WARNING

Warnings appear where overlooked details may cause damage to the equipment or result in personal injury. Warnings should be taken seriously.



CAUTION

Cautionary messages should be heeded to help reduce the chance of losing data or damaging the product.



NOTE

These messages inform the reader of essential but non-critical information. These messages should be read carefully as any directions or instructions contained therein can help avoid making mistakes.

Table of Contents

1 INTRODUCTION.....	1
1.1 INTRODUCTION.....	2
1.2 MODEL VARIATIONS	2
1.3 FEATURES.....	3
1.4 CONNECTORS	4
1.5 DIMENSIONS.....	5
1.6 DATA FLOW	6
1.7 TECHNICAL SPECIFICATIONS	7
2 PACKING LIST.....	10
2.1 ANTI-STATIC PRECAUTIONS	11
2.2 UNPACKING PRECAUTIONS.....	11
2.3 PACKING LIST.....	12
2.4 OPTIONAL ITEMS	13
3 CONNECTORS	14
3.1 PERIPHERAL INTERFACE CONNECTORS.....	15
3.1.1 <i>PM-BT Layout</i>	15
3.1.1 <i>Peripheral Interface Connectors</i>	16
3.2 INTERNAL PERIPHERAL CONNECTORS	17
3.2.1 <i>Battery Connector</i>	17
3.2.1 <i>Buzzer Connector</i>	18
3.2.2 <i>DDR3L SO-DIMM Socket</i>	19
3.2.3 <i>Digital I/O Connector</i>	20
3.2.4 <i>Front Panel Connector</i>	21
3.2.1 <i>LAN Connector</i>	22
3.2.1 <i>LVDS LCD Connector</i>	23
3.2.2 <i>LVDS Backlight Inverter Connector</i>	24
3.2.1 <i>PC/104-Plus Connector, ISA</i>	25
3.2.1 <i>PC/104-Plus Connector, PCI</i>	26

3.2.1 PC/104-Plus Power Connector.....	28
3.2.2 PCIe Mini Slot.....	29
3.2.1 Power Input Connector.....	31
3.2.2 RS-232/422/485 Serial Port Connectors	32
3.2.3 SATA 3Gb/s Drive Connector	34
3.2.1 SATA Power Connector.....	35
3.2.2 SPI Flash Connector.....	36
3.2.3 USB 2.0 Connectors.....	37
3.2.1 VGA Connector.....	38
4 INSTALLATION	39
4.1 ANTI-STATIC PRECAUTIONS	40
4.2 INSTALLATION CONSIDERATIONS.....	40
4.3 SO-DIMM INSTALLATION	42
4.4 FULL-SIZE PCIe MINI CARD INSTALLATION	43
4.5 SYSTEM CONFIGURATION.....	44
4.5.1 AT/ATX Power Mode Setting	44
4.5.1 LVDS Panel Resolution Select Switch	45
4.5.1 LVDS Voltage Selection	46
4.5.2 PCI Voltage Setup	47
4.6 AVAILABLE DRIVERS	48
4.6.1 Driver Download	48
4.7 OS INSTALLATION	50
5 BIOS	51
5.1 INTRODUCTION.....	52
5.1.1 Starting Setup.....	52
5.1.2 Using Setup	52
5.1.3 Getting Help.....	53
5.1.4 Unable to Reboot after Configuration Changes	53
5.1.5 BIOS Menu Bar.....	53
5.2 MAIN.....	54
5.3 ADVANCED.....	55
5.3.1 Trusted Computing	56
5.3.2 ACPI Settings.....	57

PM-BT SBC

5.3.3 F81866 Super IO Configuration	58
5.3.3.1 Serial Port n Configuration	58
5.3.4 F81866 H/W Monitor.....	61
5.3.5 RTC Wake Settings.....	62
5.3.6 Serial Port Console Redirection	63
5.3.7 iEi Feature	66
5.3.8 CPU Configuration	67
5.3.9 IDE Configuration.....	68
5.3.10 USB Configuration.....	69
5.4 CHIPSET	70
5.4.1 North Bridge	71
5.4.1.1 Intel IGD Configuration.....	72
5.4.2 South Bridge.....	74
5.4.2.1 PCI Express Configuration	75
5.5 SECURITY.....	76
5.6 BOOT.....	77
5.7 SAVE & EXIT	79
A REGULATORY COMPLIANCE	81
B PRODUCT DISPOSAL	83
C BIOS OPTIONS	85
D DIGITAL I/O INTERFACE.....	88
D.1 INTRODUCTION.....	89
D.2 ASSEMBLY LANGUAGE SAMPLE 1.....	90
D.3 ASSEMBLY LANGUAGE SAMPLE 2.....	90
E WATCHDOG TIMER.....	91
F HAZARDOUS MATERIALS DISCLOSURE.....	94

List of Figures

Figure 1-1: PM-BT	2
Figure 1-2: Connectors	4
Figure 1-3: PM-BT Dimensions (mm).....	5
Figure 1-4: Data Flow Diagram.....	6
Figure 3-1: Peripheral Interface Connectors (Front Side)	15
Figure 3-2: Peripheral Interface Connectors (Solder Side).....	15
Figure 3-3: Battery Connector Location.....	18
Figure 3-4: Buzzer Connector Location	19
Figure 3-5: DDR3L SO-DIMM Socket Locations	19
Figure 3-6: Digital I/O Connector Location	20
Figure 3-7: Front Panel Connector Location	21
Figure 3-8: LAN Connector Location.....	22
Figure 3-9: LAN Cable	22
Figure 3-10: LVDS Connector Location.....	23
Figure 3-11: Backlight Inverter Connector Location.....	24
Figure 3-12: PC/104 Slot Location	25
Figure 3-13: PCI-104 Connector Location	27
Figure 3-14: PC/104-Plus Power Connector Pinouts	28
Figure 3-15: PCIe Mini Slot Location	29
Figure 3-16: Power Connector Location	31
Figure 3-17: RS-232/422/485 Serial Port Connector Locations.....	32
Figure 3-18: SATA 3Gb/s Drive Connector Location	34
Figure 3-19: SATA Power Connector Location	35
Figure 3-20: SPI Flash Connector Location.....	36
Figure 3-21: USB 2.0 Connector Locations	37
Figure 3-22: VGA Connector Location	38
Figure 3-23: VGA Cable.....	38
Figure 4-1: SO-DIMM Installation	42
Figure 4-2: Removing the Retention Screw	43
Figure 4-3: Inserting the Full-size PCIe Mini Card into the Slot at an Angle	43

PM-BT SBC

Figure 4-4: Securing the Full-size PCIe Mini Card	44
Figure 4-5: AT/ATX Power Mode Switch Location	44
Figure 4-6: LVDS Panel Resolution Select Switch Location	45
Figure 4-7: LVDS Voltage Selection Jumper Locations	46
Figure 4-8: PCI Voltage Jumper Location	47
Figure 4-9: IEI Resource Download Center	48
Figure 4-10: BIOS Option-OS Selection	50

List of Tables

Table 1-1: Model Variations	2
Table 1-2: PM-BT Specifications	8
Table 2-1: Packing List.....	13
Table 2-2: Optional Items	13
Table 3-1: Peripheral Interface Connectors	16
Table 3-2: Battery Connector Pinouts	18
Table 3-3: Buzzer Connector Pinouts.....	19
Table 3-4: Digital I/O Connector Pinouts.....	20
Table 3-5: Front Panel Connector Pinouts.....	21
Table 3-6: LAN Connector Pinouts	22
Table 3-7: LVDS Connector Pinouts	23
Table 3-8: Backlight Inverter Connector Pinouts	24
Table 3-9: PC/104 Slot Connector Pinouts.....	26
Table 3-10: PCI-104 Connector Pinouts	28
Table 3-11: PC/104-Plus Power Connector Pinouts.....	29
Table 3-12: PCIe Mini Slot Pinouts.....	30
Table 3-13: Power Connector Pinouts.....	31
Table 3-14: RS-232 Serial Port Connector Pinouts	32
Table 3-15: DB-9 RS-232/422/485 Pinouts	33
Table 3-16: SATA 3Gb/s Drive Connector Pinouts.....	34
Table 3-17: SATA Power Connector Pinouts.....	35
Table 3-18: SPI Flash Connector Pinouts	36
Table 3-19: USB 2.0 Connector Pinouts.....	37
Table 3-20: VGA Connector Pinouts.....	38
Table 4-1: AT/ATX Power Mode Switch Settings.....	45
Table 4-2: LVDS Panel Resolution Selection.....	45
Table 4-3: LVDS Voltage Selection Jumper Settings.....	46
Table 4-4: PCI Voltage Jumper Settings.....	47
Table 5-1: BIOS Navigation Keys	53

BIOS Menus

BIOS Menu 1: Main	54
BIOS Menu 2: Advanced	55
BIOS Menu 3: Trusted Computing	56
BIOS Menu 4: ACPI Configuration	57
BIOS Menu 5: F81866 Super IO Configuration	58
BIOS Menu 6: Serial Port n Configuration Menu	58
BIOS Menu 7: F81866 H/W Monitor	61
BIOS Menu 8: RTC Wake Settings	62
BIOS Menu 9: Serial Port Console Redirection	63
BIOS Menu 10: iEi Feature	66
BIOS Menu 11: CPU Configuration	67
BIOS Menu 12: IDE Configuration	68
BIOS Menu 13: USB Configuration	69
BIOS Menu 14: Chipset	71
BIOS Menu 15: North Bridge	71
BIOS Menu 16: Intel IGD Configuration	72
BIOS Menu 17: South Bridge	74
BIOS Menu 18: PCI Express Configuration	75
BIOS Menu 19: Security	76
BIOS Menu 20: Boot	77
BIOS Menu 21: Save & Exit	79

Chapter

1

Introduction

1.1 Introduction



Figure 1-1: PM-BT

The PC/104-Plus form factor PM-BT is a highly integrated embedded computer specifically optimized for multi-media applications requiring minimum installation space. The PM-BT is particularly suitable for low power and fan-less applications. The PM-BT supports a full range of functions for an industrial computer in a space-saving 96 mm x 90 mm profile. The PM-BT is equipped with an on-board low-power consumption and high performance 22nm Intel® Celeron® or Atom™ processor. It also supports a single 204-pin 1333/1066 MHz DDR3L SO-DIMM (up to 8 GB).

1.2 Model Variations

The model variations for the PM-BT series are listed in **Table 1-1**.

Model	On-board SoC	Operating Temp.
PM-BT-J19001	Intel® Celeron® processor J1900 (2 GHz, quad-core, 2 MB cache, TDP=10 W)	-20°C ~ 60°C
PM-BT-N28071	Intel® Celeron® processor N2807 (1.58 GHz, dual-core, 2 MB cache, TDP=4.5 W)	-20°C ~ 60°C
PM-BT-E38451W2*	Intel® Atom™ processor E3845 (1.91 GHz, quad-core, 2 MB cache, TDP=10 W)	-40°C ~ 85°C
PM-BT-E38251W2*	Intel® Atom™ processor E3825 (1.33 GHz, dual-core, 1 MB cache, TDP=6 W)	-40°C ~ 85°C
*Production by order, MOQ 100 pcs/lot		

Table 1-1: Model Variations

PM-BT SBC

1.3 Features

Some of the PM-BT motherboard features are listed below:

- PC/104-Plus (ISA and PCI signal) function support
- 5V DC input solution
- On-board 22nm Intel® Atom™ or Celeron® processor
- One 204-pin 1333/1066 MHz single-channel DDR3L SDRAM SO-DIMM slot supports up to 8 GB of memory (for J1900, E3845 and E3825 SKUs)
or
One 204-pin 1333/1066 MHz single-channel DDR3L SDRAM SO-DIMM slot supports up to 4 GB of memory (for N2807 SKU)
- VGA and LVDS interfaces for dual independent display
- One GbE connector
- One SATA 3Gb/s connector with 5 V SATA power connector
- One full-size PCIe Mini card expansion slot
- Three USB 2.0 ports
- Two RS-232/422/485 serial ports
- On-board SSD (optional)
- RoHS compliant

1.4 Connectors

The connectors on the PM-BT are shown in the figure below.

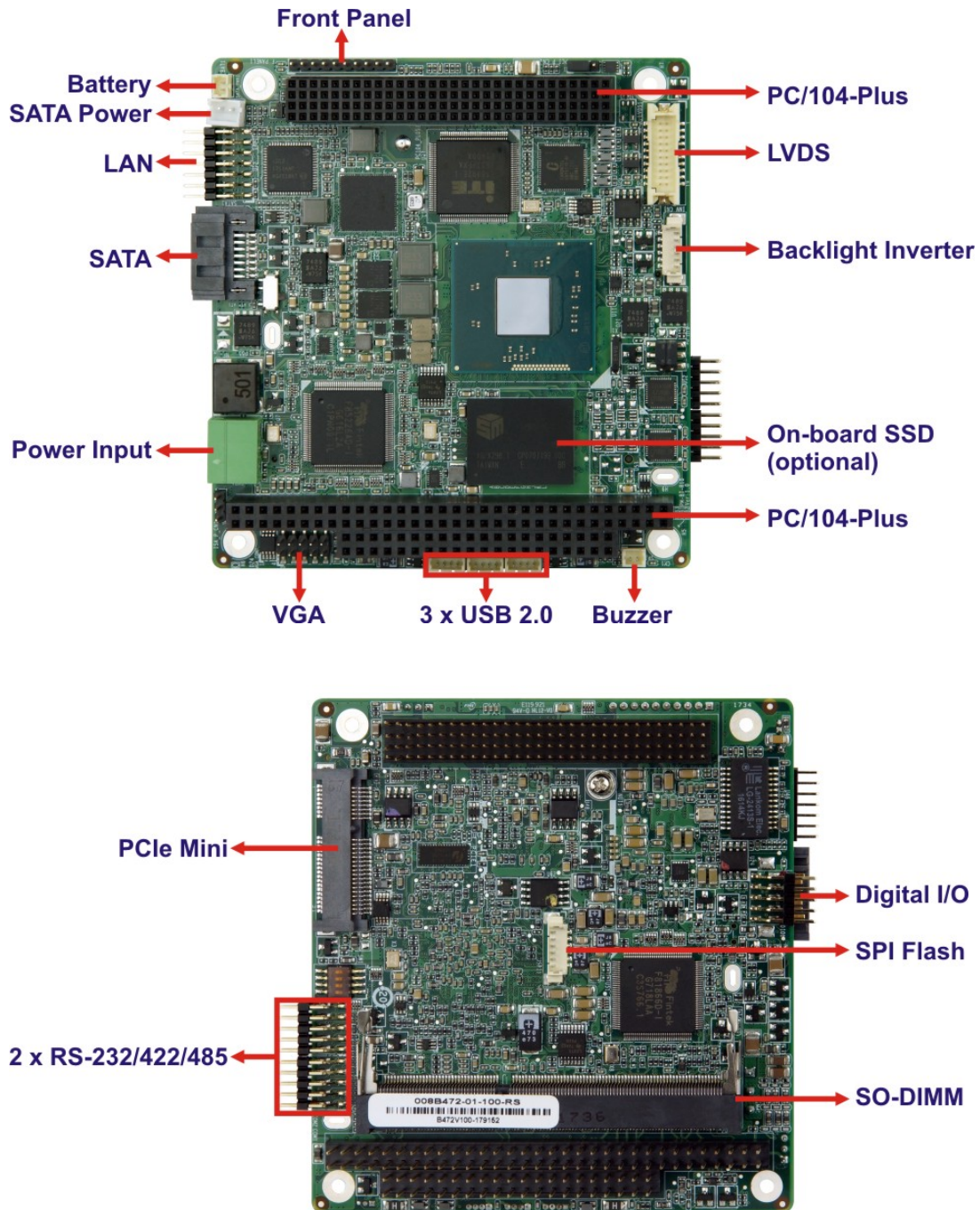

Figure 1-2: Connectors

PM-BT SBC

1.5 Dimensions

The main dimensions of the PM-BT are shown in the diagram below.

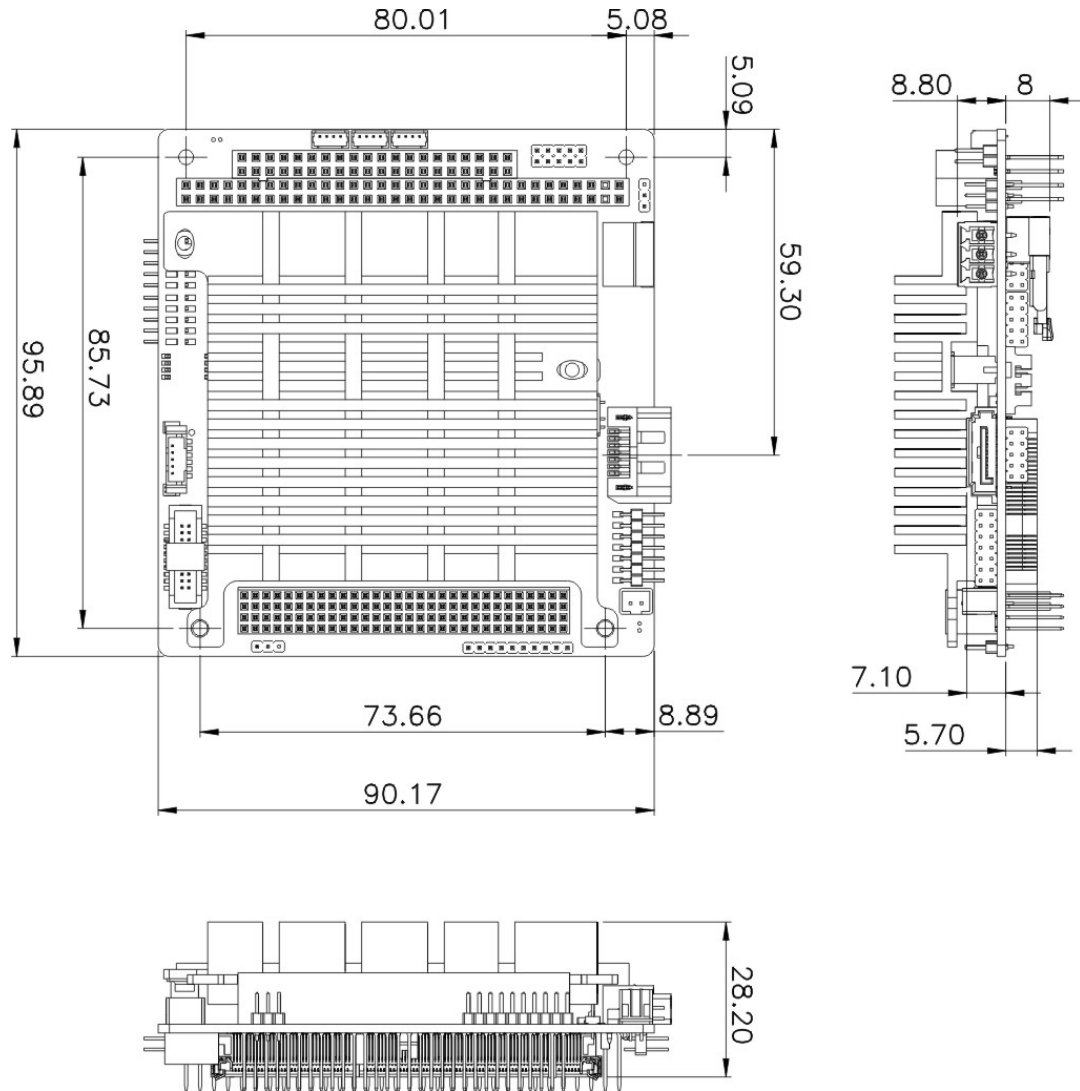

Figure 1-3: PM-BT Dimensions (mm)

1.6 Data Flow

Figure 1-4 shows the data flow between the system chipset, the CPU and other components installed on the motherboard.

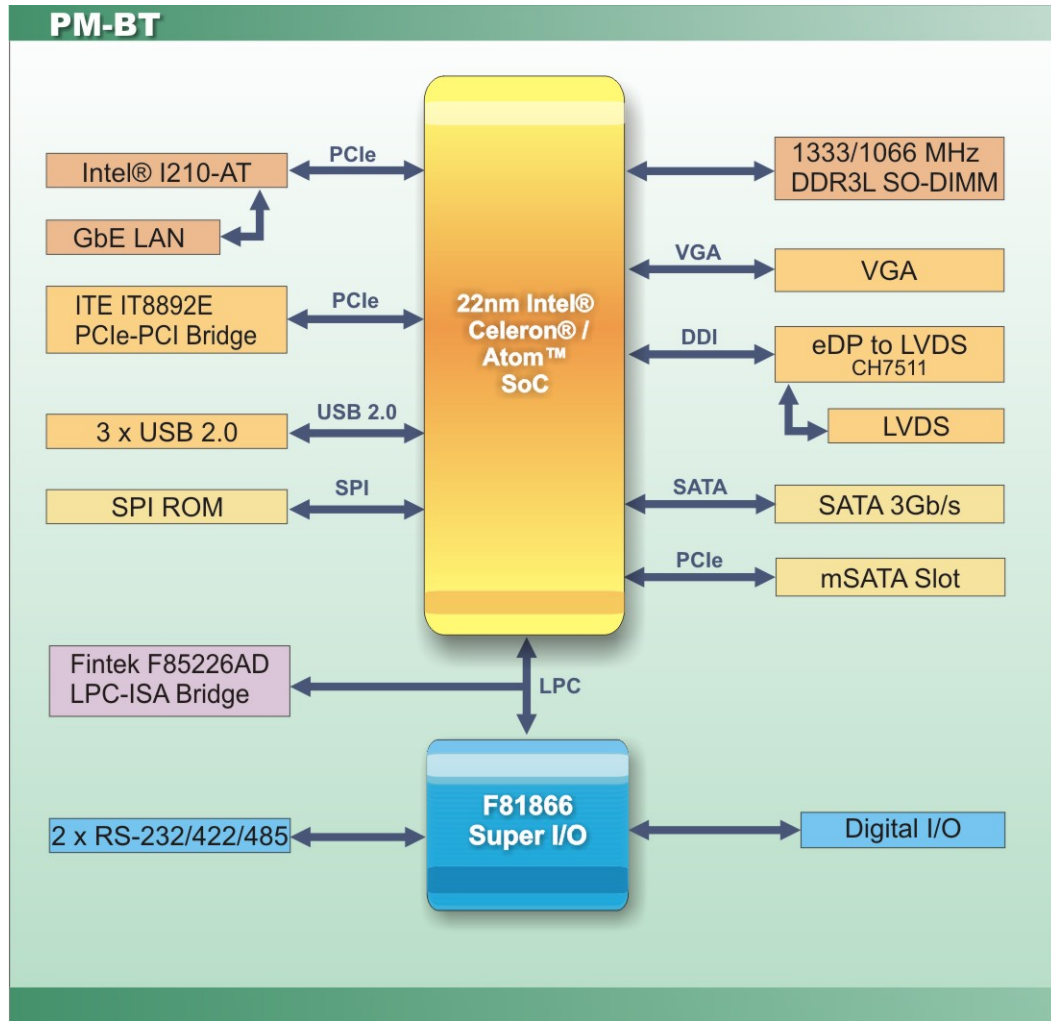

Figure 1-4: Data Flow Diagram

PM-BT SBC

1.7 Technical Specifications

The PM-BT technical specifications are listed below.

Specification/Model	PM-BT
Form Factor	PC/104-Plus
SoC	<ul style="list-style-type: none"> ▪ Standard <ul style="list-style-type: none"> ○ Intel® Celeron® processor J1900 (2 GHz, quad-core, 2 MB cache, TDP=10 W) ○ Intel® Celeron® processor N2807 (1.58 GHz, dual-core, 2 MB cache, TDP=4.5 W) ▪ By request (MOQ 100) <ul style="list-style-type: none"> ○ Intel® Atom™ processor E3845 (1.91 GHz, quad-core, 2 MB cache, TDP=10 W) ○ Intel® Atom™ processor E3825 (1.33 GHz, dual-core, 1 MB cache, TDP=6 W)
Memory	<p>For J1900, E3845 and E3825 SKUs: One 204-pin 1333/1066 MHz single-channel DDR3L SDRAM SO-DIMM slot supports up to 8 GB of memory</p> <p>For N2807 SKU: One 204-pin 1333/1066 MHz single-channel DDR3L SDRAM SO-DIMM slot supports up to 4 GB of memory</p>
Graphics Engine	Intel® HD Graphics Gen7 with 4 execution units, supporting DirectX 11.1, OpenCL 1.2 and OpenGL 4.2
Display Output	<p>Supports dual independent display</p> <p>One VGA (up to 2560x1600@60Hz)</p> <p>One 18-bit/24-bit single-channel LVDS</p>
Ethernet Controllers	Intel® I210 PCIe controller
BIOS	UEFI BIOS
Super I/O Controller	Fintek F81866
Watchdog Timer	Software programmable supports 1~255 sec. system reset

Expansions	<p>One full-size PCIe Mini card slot (supports mSATA)</p> <p>One PC/104-Plus (ISA + PCI)</p> <p>* The ISA function is limited. Please refer to page 8 for details.</p>
Storage	On-board SSD (optional)
I/O Interface Connectors	
Digital I/O	8-bit digital I/O
Ethernet	One GbE port
Front Panel	One 10-pin header (power LED, HDD LED, power button and reset button)
Serial ATA	One SATA 3Gb/s connector with 5 V SATA power connector
Serial Ports	Two RS-232/422/485 via internal 10-pin headers
USB 2.0	Three USB 2.0 ports via internal pin headers
Environmental and Power Specifications	
Power Supply	<p>5 V DC input</p> <p>12 V for fan, LVDS and PC/104-Plus</p> <p>3 V / 5 V jumper for add-in modules</p> <p>Support AT/ATX mode</p> <p>ErP/EuP Compliant</p>
Power Consumption	5 V @ 1.70 A (2 GHz Intel® Celeron® processor J1900 with one 8 GB 1333 MHz DDR3L memory)
Operating Temperature	<p>-20°C ~ 60°C (for J1900/N2807 SKUs)</p> <p>-40°C ~ 85°C (for E38xx SKUs)</p>
Storage Temperature	-40°C ~ 85°C
Operating Humidity	5% ~ 95% (non-condensing)
Safety	CE, FCC
Physical Specifications	
Dimensions	96 mm x 90 mm
Weight (GW/NW)	500 g / 120 g

Table 1-2: PM-BT Specifications

**NOTE:****ISA Limitation of PM-BT**

Due to the limitation of Intel® Bay Trail processors, the PM-BT does not support the following features:

- Bus Master Cycles
 - DMA
 - LPC Memory Mapped Transactions
 - IRQ0, IRQ1, IRQ2, IRQ8, IRQ9, IRQ13, IRQ14
 - ISA Enable (IE) Bit
 - PnP
-

Chapter

2

Packing List

PM-BT SBC

2.1 Anti-static Precautions



WARNING!

Static electricity can destroy certain electronics. Make sure to follow the ESD precautions to prevent damage to the product, and injury to the user.

Make sure to adhere to the following guidelines:

- **Wear an anti-static wristband:** Wearing an anti-static wristband can prevent electrostatic discharge.
- **Self-grounding:** Touch a grounded conductor every few minutes to discharge any excess static buildup.
- **Use an anti-static pad:** When configuring any circuit board, place it on an anti-static mat.
- **Only handle the edges of the PCB:** Don't touch the surface of the motherboard. Hold the motherboard by the edges when handling.

2.2 Unpacking Precautions

When the PM-BT is unpacked, please do the following:

- Follow the anti-static guidelines above.
- Make sure the packing box is facing upwards when opening.
- Make sure all the packing list items are present.







2.3 Packing List



NOTE:

If any of the components listed in the checklist below are missing, do not proceed with the installation. Contact the IEI reseller or vendor the PM-BT was purchased from or contact an IEI sales representative directly by sending an email to sales@ieiworld.com.

The PM-BT is shipped with the following components:

Quantity	Item and Part Number	Image
1	PM-BT single board computer	
1	SATA and power cable	
1	Power cable	
1	COM port cable	
1	LAN cable	
1	Single-port USB cable	

PM-BT SBC



Quantity	Item and Part Number	Image
1	VGA cable	
1	Quick installation guide	

Table 2-1: Packing List

2.4 Optional Items

The following are optional components which may be separately purchased:



Item and Part Number	Image
PC/104-Plus press-fit socket, 120-pin, p=2.0mm (P/N: 33403-000015-RS)	
PC/104-Plus press-fit socket, 64+40-pin, p=2.54mm (P/N: 33403-000016-RS)	

Table 2-2: Optional Items

Chapter

3

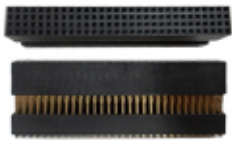
Connectors

PM-BT SBC

3.1 Peripheral Interface Connectors

This chapter details all the peripheral interface connectors.

3.1.1 PM-BT Layout

The figure below shows all the peripheral interface connectors.

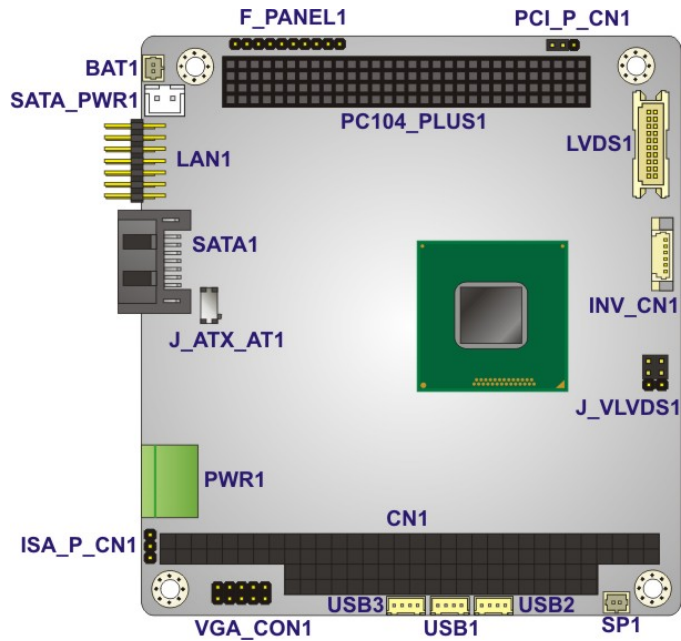

Figure 3-1: Peripheral Interface Connectors (Front Side)

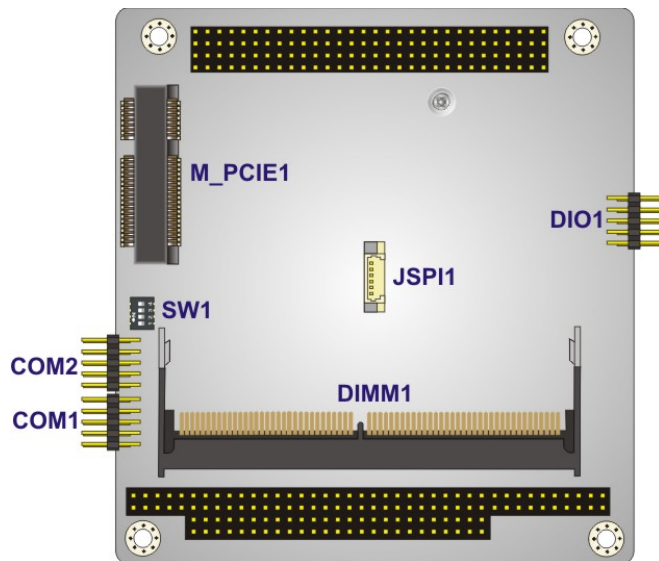

Figure 3-2: Peripheral Interface Connectors (Solder Side)

3.1.1 Peripheral Interface Connectors

The table below lists all the connectors on the board.

Connector	Type	Label
Battery connector	2-pin wafer	BAT1
Buzzer connector	2-pin wafer	SP1
DDR3L SO-DIMM socket	204-pin DDR3L SO-DIMM socket	DIMM1
Digital I/O connector	10-pin header	DIO1
Front panel connector	10-pin header	F_PANEL1
LAN connector	14-pin header	LAN1
LVDS connector	20-pin crimp	LVDS1
LVDS backlight inverter connector	6-pin wafer	INV_CN1
PC/104-Plus connector, ISA	PC/104	CN1
PC/104-Plus connector, PCI	PCI-104	PC104_PLUS1
PC/104-Plus power connector	3-pin header	ISA_P_CN1
PCIe Mini slot	PCIe Mini slot	M_PCIE1
Power input connector	3-pin terminal block	PWR1
RS-232/422/485 serial ports	10-pin header	COM1, COM2
SATA 3Gb/s drive connector	7-pin SATA connector	SATA1
SATA power connector	2-pin wafer	SATA_PWR1
SPI flash connector	6-pin wafer	JSPI1
USB 2.0 connectors	4-pin wafer	USB1, USB2, USB3
VGA connector	10-pin header	VGA_CON1

Table 3-1: Peripheral Interface Connectors

PM-BT SBC

3.2 Internal Peripheral Connectors

The section describes all of the connectors on the PM-BT.

3.2.1 Battery Connector



CAUTION:

Risk of explosion if battery is replaced by an incorrect type. Only certified engineers should replace the on-board battery.

Dispose of used batteries according to instructions and local regulations.



NOTE:

It is recommended to attach the RTC battery onto the system chassis in which the PM-BT is installed.

CN Label:	BAT1
CN Type:	2-pin wafer, p=1.25 mm
CN Location:	See Figure 3-3
CN Pinouts:	See Table 3-2

A system battery is placed in the battery holder. The battery provides power to the system clock to retain the time when power is turned off.

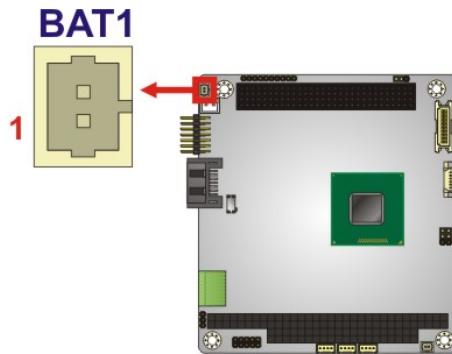

Figure 3-3: Battery Connector Location

Pin	Description
1	Battery+
2	Ground

Table 3-2: Battery Connector Pinouts

3.2.1 Buzzer Connector



NOTE:

If you cannot find a good place to put a buzzer on the PM-BT, it is recommended to attach the buzzer onto the system chassis in which the PM-BT is installed.

- CN Label:** SP1
- CN Type:** 2-pin wafer, p=1.25 mm
- CN Location:** See **Figure 3-4**
- CN Pinouts:** See **Table 3-3**

The buzzer connector is connected to a buzzer.

PM-BT SBC

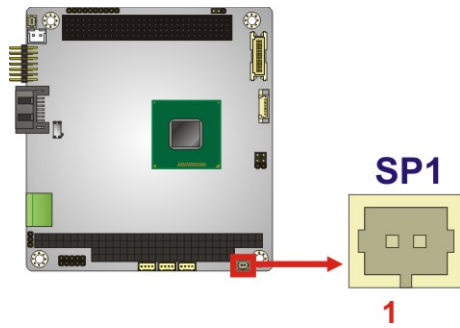

Figure 3-4: Buzzer Connector Location

Pin	Description
1	BU_PWR
2	PC_BEEP

Table 3-3: Buzzer Connector Pinouts

3.2.2 DDR3L SO-DIMM Socket

- CN Label:** DIMM1
- CN Type:** 204-pin DDR3L SO-DIMM socket
- CN Location:** See Figure 3-5

The SO-DIMM slots are for installing the DDR3L SO-DIMMs.

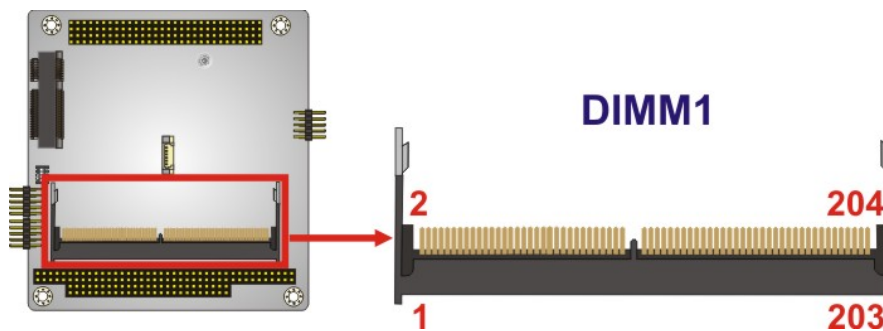

Figure 3-5: DDR3L SO-DIMM Socket Locations

3.2.3 Digital I/O Connector

- CN Label:** DIO1
- CN Type:** 10-pin header, p=2.00 mm
- CN Location:** See **Figure 3-6**
- CN Pinouts:** See **Table 3-4**

The digital I/O connector provides programmable input and output for external devices.

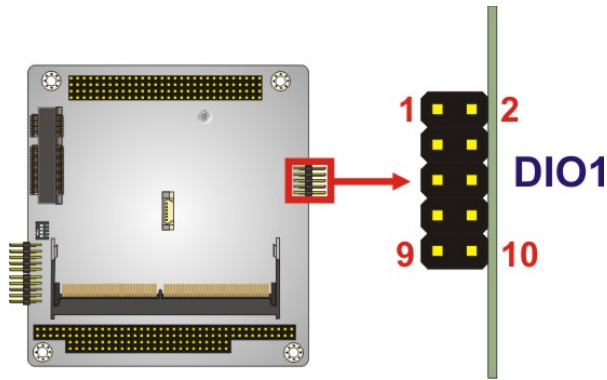

Figure 3-6: Digital I/O Connector Location

Pin	Description	Pin	Description
1	GND	2	VCC5V
3	Output 3	4	Output 2
5	Output 1	6	Output 0
7	Input 3	8	Input 2
9	Input 1	10	Input 0

Table 3-4: Digital I/O Connector Pinouts

PM-BT SBC

3.2.4 Front Panel Connector

- CN Label:** F_PANEL1
- CN Type:** 10-pin header, p=2.00 mm
- CN Location:** See **Figure 3-7**
- CN Pinouts:** See **Table 3-5**

The front panel connector connects to the indicator LEDs and buttons on the computer's front panel.

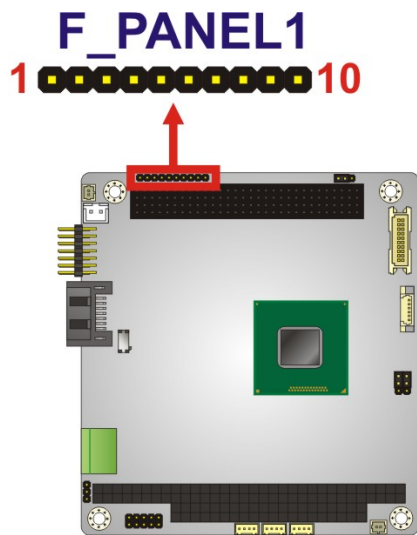

Figure 3-7: Front Panel Connector Location

Function	Pin	Description	Function	Pin	Description
	1	VCC	HDD LED	6	HDD_LED-
	2	GND	Power Button	7	PWR_BTN+
Power LED	3	PWR_LED+		8	PWR_BTN-
	4	PWR_LED-	Reset	9	RESET+
HDD LED	5	HDD_LED+		10	RESET-

Table 3-5: Front Panel Connector Pinouts

3.2.1 LAN Connector

- CN Label:** LAN1
- CN Type:** 14-pin header, p=2.00 mm
- CN Location:** See **Figure 3-8**
- CN Pinouts:** See **Table 3-6**

Use the LAN cable to connect to the LAN1 connector to provide gigabit LAN connection.

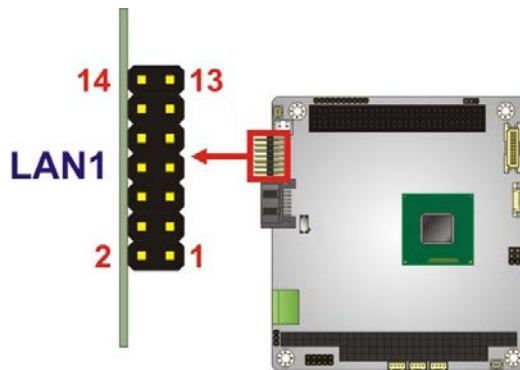

Figure 3-8: LAN Connector Location

Pin	Description	Pin	Description
1	MDX0+	2	MDX0-
3	MDX1+	4	MDX1-
5	MDX2+	6	MDX2-
7	MDX3+	8	MDX3-
9	GND	10	GND
11	LINKLED+	12	LINKLED-
13	SPEEDLED	14	SPEEDLED2

Table 3-6: LAN Connector Pinouts

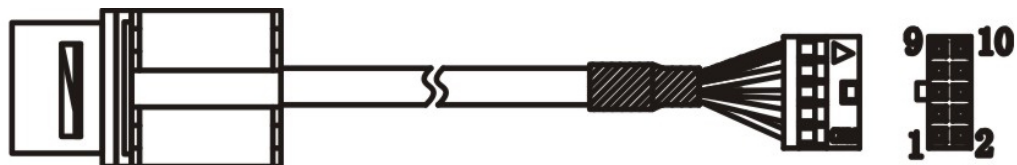

Figure 3-9: LAN Cable

PM-BT SBC

3.2.1 LVDS LCD Connector

- CN Label:** LVDS1
- CN Type:** 20-pin crimp, p=1.25 mm
- CN Location:** See **Figure 3-10**
- CN Pinouts:** See **Table 3-7**

The LVDS connector is for an LCD panel connected to the board.

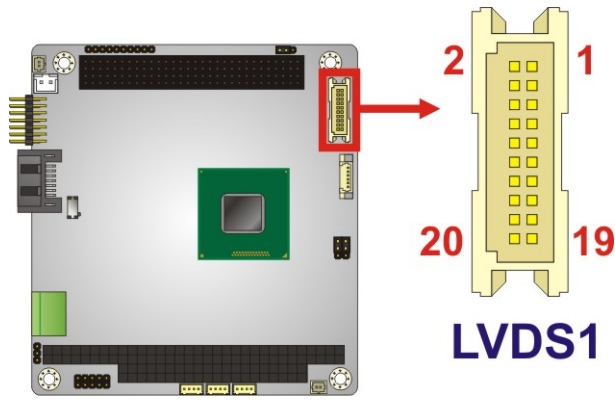

Figure 3-10: LVDS Connector Location

Pin	Description	Pin	Description
1	GND	2	GND
3	LVDSA_DATA1-	4	LVDSA_DATA0-
5	LVDSA_DATA1+	6	LVDSA_DATA0+
7	GND	8	GND
9	LVDSA_CLK-	10	LVDSA_DATA2-
11	LVDSA_CLK+	12	LVDSA_DATA2+
13	GND	14	GND
15	LVDSA_DATA3-	16	N/C
17	LVDSA_DATA3+	18	+VCC_LCD
19	GND	20	+VCC_LCD

Table 3-7: LVDS Connector Pinouts

3.2.2 LVDS Backlight Inverter Connector

- CN Label:** INV_CN1
- CN Type:** 6-pin wafer, p=2.00 mm
- CN Location:** See **Figure 3-11**
- CN Pinouts:** See **Table 3-8**

The backlight inverter connector provides power to an LCD panel.

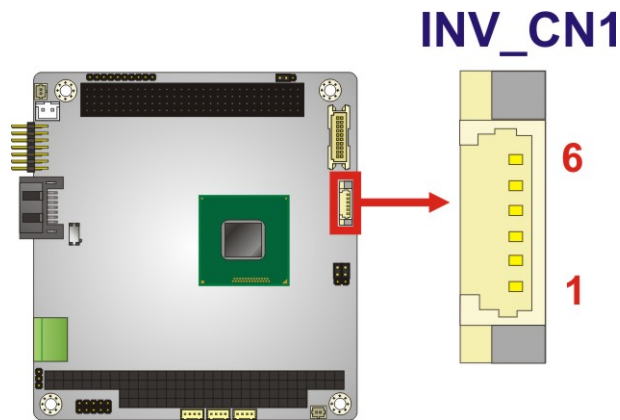

Figure 3-11: Backlight Inverter Connector Location

Pin	Description
1	+12 V
2	+12 V
3	BACKLIGHT ENABLE
4	BRIGHTNESS
5	GND
6	GND

Table 3-8: Backlight Inverter Connector Pinouts

PM-BT SBC

3.2.1 PC/104-Plus Connector, ISA

- CN Label:** CN1
- CN Type:** PC/104 Connector
- CN Location:** See **Figure 3-12**
- CN Pinouts:** See **Table 3-9**

This PC/104-Plus connector supports ISA bus.

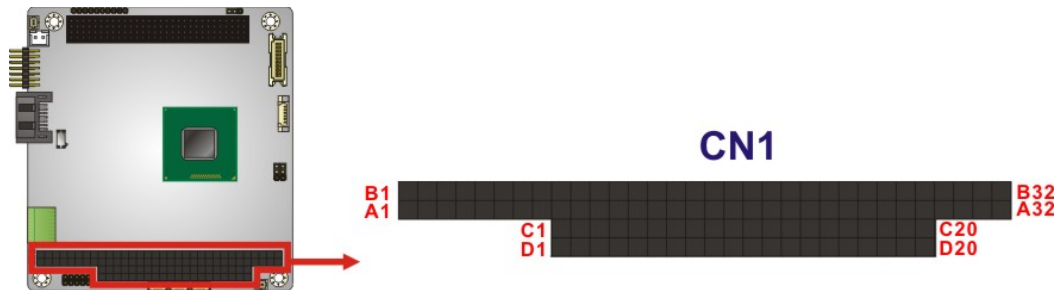

Figure 3-12: PC/104 Slot Location

Pin	Row A	Row B	Row C	Row D
1	IOCHK-	GROUND	GROUND	GROUND
2	SD7	RSTDRV	SBHE-	MEMCS16-
3	SD6	+5 V	LA23	IOCS16-
4	SD5	IRQ9	LA22	IRQ10
5	SD4	-5 V	LA21	IRQ11
6	SD3	DREQ2	LA20	IRQ12
7	SD2	-12 V	LA19	IRQ15
8	SD1	NOWS-	LA18	IRQ14
9	SD0	+12 V	LA17	DACK0-
10	IOCHRDY	GROUND	MEMR-	DRQ0
11	AEN	SMEMW-	MEMW-	DACK5-
12	SA19	SMEMR-	SD8	DRRQ5
13	SA18	IOW-	SD9	DACK6-
14	SA17	IOR-	SD10	DRQ6
15	SA16	DACK3-	SD11	DACK7-

Pin	Row A	Row B	Row C	Row D
16	SA15	DRQ3	SD12	DRQ7
17	SA14	DACK1-	SD13	+5 V
18	SA13	DRQ1	SD14	MASTER-
19	SA12	REFRESH-	SD15	GROUND
20	SA11	SYCLK	NC	GROUND
21	SA10	IRQ7		
22	SA9	IRQ6		
23	SA8	IRQ5		
24	SA7	IRQ4		
25	SA6	IRQ3		
26	SA5	DACK2-		
27	SA4	TC		
28	SA3	BALE		
29	SA2	+5 V		
30	SA1	ISA_OSC		
31	SA0	GROUND		
32	GROUND	GROUND		

Table 3-9: PC/104 Slot Connector Pinouts

3.2.1 PC/104-Plus Connector, PCI

- CN Label:** PC104_PLUS1
- CN Type:** PCI-104 connector
- CN Location:** See **Figure 3-13**
- CN Pinouts:** See **Table 3-10**

This PC/104-Plus connector supports PCI bus, and provides either 3.3V or 5V signaling level (configured by jumper, see **Section 4.5.2**).

PM-BT SBC

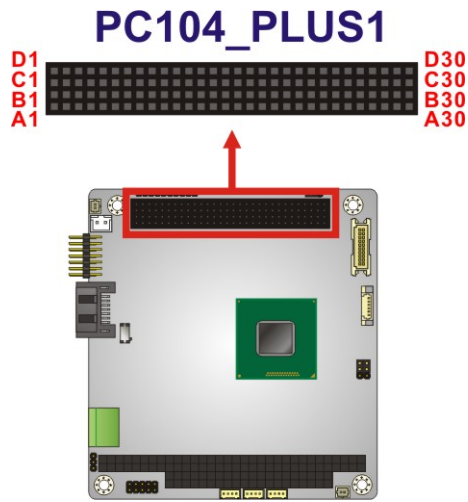

Figure 3-13: PCI-104 Connector Location

Pin	Row A	Row B	Row C	Row D
1	GND	SERI0Q_PCI	+5 V	AD00
2	+PIO_VCC	AD02	AD01	+5 V
3	AD05	GND	AD04	AD03
4	C/BE0	AD07	GND	AD06
5	GND	AD09	AD08	GND
6	AD11	+PIO_VCC	AD10	GND
7	AD14	AD13	GND	AD12
8	+3.3 V	C/BE1	AD15	+3.3 V
9	-SERR	GND	SB0	PAR
10	GND	-PERR	+3.3 V	SDONE
11	-STOP	+3.3 V	-LOCK	GND
12	+3.3 V	-TRDY	GND	-DEVSEL
13	-FRAME	GND	-IRDY	+3.3 V
14	GND	AD16	+3.3 V	C/BE2
15	AD18	+3.3 V	AD17	GND
16	AD21	AD20	GND	AD19
17	+3.3 V	AD23	AD22	+3.3 V
18	IDSEL0	GND	IDSEL1	IDSEL2
19	AD24	C/BE3	+PIO_VCC	IDSEL3

Pin	Row A	Row B	Row C	Row D
20	GND	AD26	AD25	GND
21	AD29	+5 V	AD28	AD27
22	+5 V	AD30	GND	AD31
23	REQ0	GND	REQ1	+PIO_VCC
24	GND	REQ2	+5 V	GNT0
25	GNT1	+PIO_VCC	GNT2	GND
26	+5 V	CLK0	GND	CLK1
27	CLK2	+5 V	CLK3	GND
28	GND	-PIRQD	+5 V	RST-
29	+12 V	-PIRQA	-PIRQB	-PIRQC
30	-12 V	PREQ-3	PGNT-3	GND

Table 3-10: PCI-104 Connector Pinouts

3.2.1 PC/104-Plus Power Connector

- CN Label:** PC104_PWR1
- CN Type:** 3-pin wafer (1x3)
- CN Location:** See **Figure 3-14**
- CN Pinouts:** See **Table 3-11**

The PC/104-Plus power connector provides extra power to PC/104 modules.

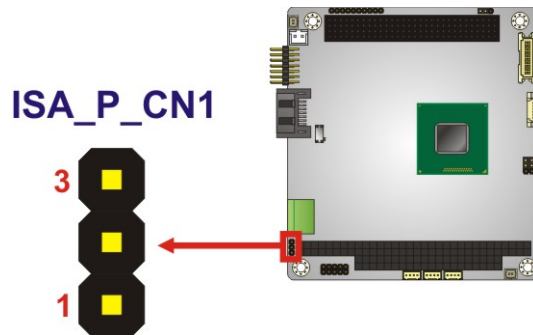

Figure 3-14: PC/104-Plus Power Connector Pinouts

PM-BT SBC

Pin	Description
1	-12 V
2	GND
3	-5 V

Table 3-11: PC/104-Plus Power Connector Pinouts

3.2.2 PCIe Mini Slot

- CN Label:** M_PCIE1
- CN Type:** Full-size PCIe Mini slot
- CN Location:** See **Figure 3-15**
- CN Pinouts:** See **Table 3-12**

The PCIe Mini slot supporting PCIe and USB signals is for installing a full-size mSATA module.

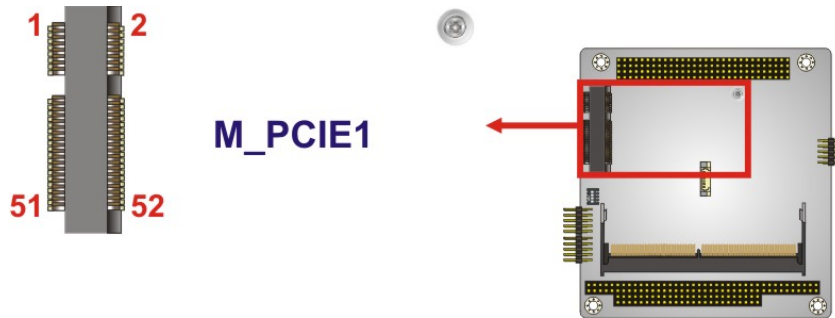

Figure 3-15: PCIe Mini Slot Location

Pin	Description	Pin	Description
1	PCIE_WAKE#	2	VCC3
3	N/C	4	GND
5	N/C	6	1.5V
7	N/C	8	N/C
9	GND	10	N/C
11	PCIE_CLK-	12	N/C
13	PCIE_CLK+	14	N/C
15	GND	16	N/C

Pin	Description	Pin	Description
17	N/C	18	GND
19	N/C	20	N/C
21	GND	22	PCIRST#
23	PCIE_RXN	24	VCC3
25	PCIE_RXP	26	GND
27	GND	28	1.5V
29	GND	30	SMBCLK
31	PCIE_TXN	32	SMBDATA
33	PCIE_TXP	34	GND
35	GND	36	USB D-
37	GND	38	USB D+
39	VCC3	40	GND
41	VCC3	42	N/C
43	N/C	44	N/C
45	N/C	46	N/C
47	N/C	48	1.5V
49	N/C	50	GND
51	mSATA_DET#	52	VCC3

Table 3-12: PCIe Mini Slot Pinouts

PM-BT SBC

3.2.1 Power Input Connector

- CN Label:** PWR1
- CN Type:** 3-pin terminal block connector
- CN Location:** See **Figure 3-16**
- CN Pinouts:** See **Table 3-13**

The PWR1 connector connects to the power source to provide main power to the system.

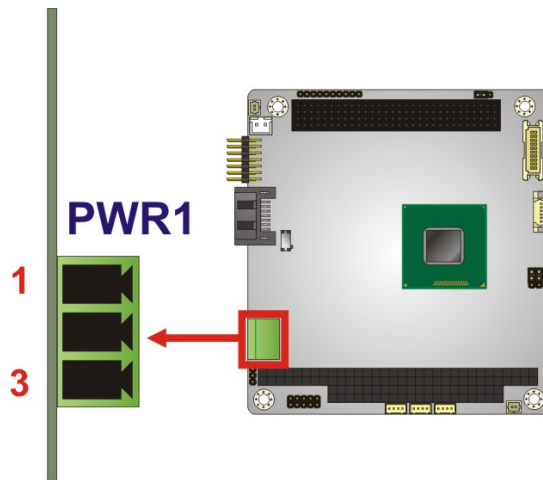

Figure 3-16: Power Connector Location

Pin	Description
1	+12 V
2	GND
3	+5 V

Table 3-13: Power Connector Pinouts

3.2.2 RS-232/422/485 Serial Port Connectors

- CN Label:** COM1, COM2
- CN Type:** 10-pin header, p=2.00 mm
- CN Location:** See **Figure 3-17**
- CN Pinouts:** See **Table 3-14**

Each of these connectors provides RS-232/422/485 connections.

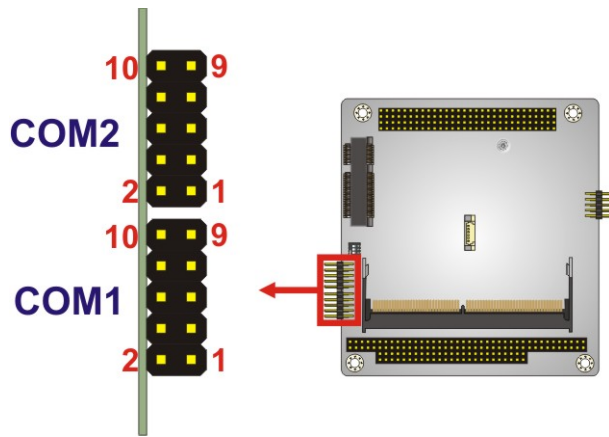

Figure 3-17: RS-232/422/485 Serial Port Connector Locations

Pin	Description	Pin	Description
1	DCD	2	DSR
3	RX	4	RTS
5	TX	6	CTS
7	DTR	8	RI
9	GND	10	GND

Table 3-14: RS-232 Serial Port Connector Pinouts

PM-BT SBC



NOTE:

The communication protocol of COM1 and COM2 serial ports is set through the BIOS menu in “Advanced → F81866 Super IO Configuration → Serial Port Configuration”. Use the **Transfer Mode** BIOS option to configure the correspondent serial ports (refer to **Sections 5.3.3.1.1** and **Section 5.3.3.1.2** for detailed information).

The DB-9 connector pinouts of the COM port cable are listed below.

RS-232 Pinouts	RS-422 Pinouts	RS-485 Pinouts

Table 3-15: DB-9 RS-232/422/485 Pinouts



Figure 3-18: COM Port Cable

3.2.3 SATA 3Gb/s Drive Connector

- CN Label:** SATA1
- CN Type:** 7-pin SATA drive connector
- CN Location:** See **Figure 3-18**
- CN Pinouts:** See **Table 3-16**

The SATA drive connector can be connected to SATA drives and supports up to 3Gb/s data transfer rate.

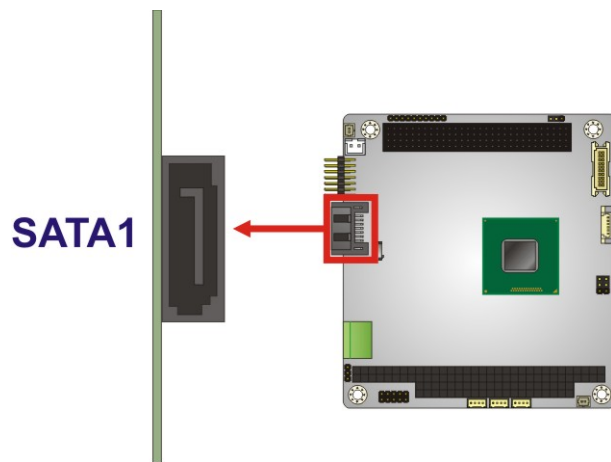

Figure 3-19: SATA 3Gb/s Drive Connector Location

Pin	Description	Pin	Description
1	GND	2	SATA_TXP
3	SATA_TXN	4	GND
5	SATA_RXN	6	SATA_RXP
7	GND		

Table 3-16: SATA 3Gb/s Drive Connector Pinouts

PM-BT SBC

3.2.1 SATA Power Connector

- CN Label:** SATA_PWR1
- CN Type:** 2-pin wafer, p=2.00 mm
- CN Location:** See **Figure 3-19**
- CN Pinouts:** See **Table 3-17**

Use the SATA Power Connector to connect to SATA device power connections.

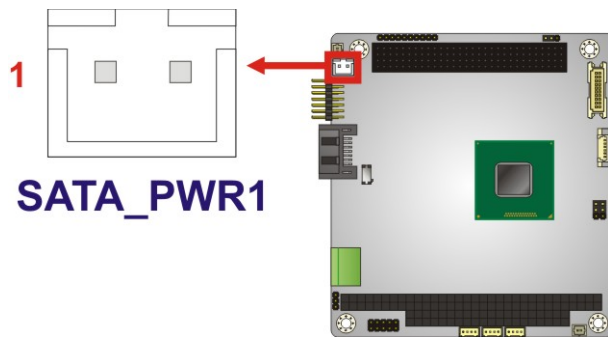

Figure 3-20: SATA Power Connector Location

Pin	Description
1	+5V
2	GND

Table 3-17: SATA Power Connector Pinouts

3.2.2 SPI Flash Connector

- CN Label:** JSPI1
- CN Type:** 6-pin wafer, p=1.25 mm
- CN Location:** See **Figure 3-20**
- CN Pinouts:** See **Table 3-18**

The SPI flash connector is used to flash the SPI ROM.

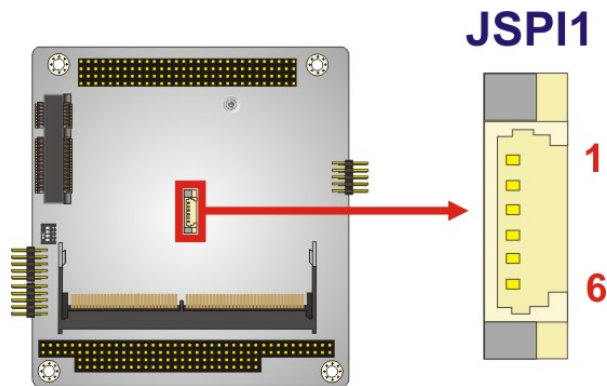

Figure 3-21: SPI Flash Connector Location

Pin	Description
1	+3.3V
2	SPI_CS
3	SPI_SO
4	SPI_CLK
5	SPI_SI
6	GND

Table 3-18: SPI Flash Connector Pinouts

PM-BT SBC

3.2.3 USB 2.0 Connectors

- CN Label:** USB1, USB2, USB3
- CN Type:** 4-pin wafer, p=1.25 mm
- CN Location:** See **Figure 3-21**
- CN Pinouts:** See **Table 3-19**

The USB 2.0 connectors connect to USB 2.0/1.1 devices.

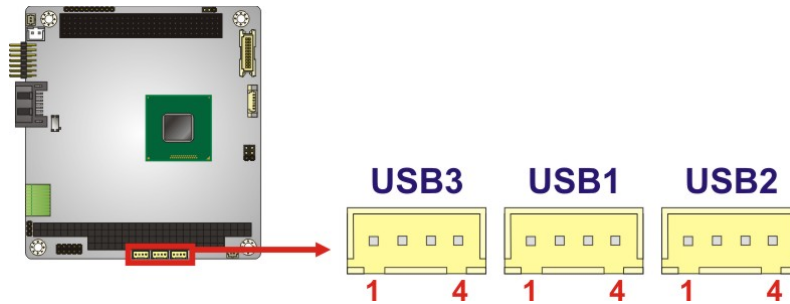

Figure 3-22: USB 2.0 Connector Locations

Pin	Description
1	VCC
3	DATA-
5	DATA+
7	GND

Table 3-19: USB 2.0 Connector Pinouts

3.2.1 VGA Connector

- CN Label:** VGA_CON1
- CN Type:** 10-pin header, p=2.00 mm
- CN Location:** See **Figure 3-22**
- CN Pinouts:** See **Table 3-20**

The VGA connector connects to a monitor through the VGA cable that came with the PM-BT.

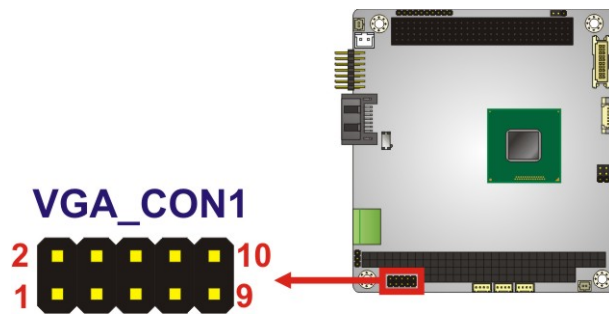

Figure 3-23: VGA Connector Location

Pin	Description	Pin	Description
1	RED	2	5 V_DDCDA
3	GREEN	4	5 V_DDCLK
5	BLUE	6	GND
7	5HSYNC	8	GND
9	5VSYNC	10	GND

Table 3-20: VGA Connector Pinouts

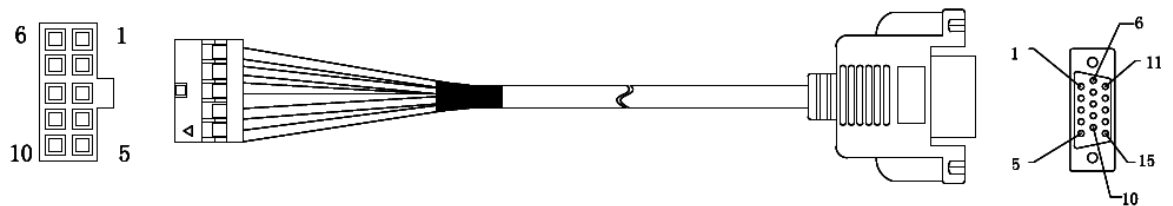

Figure 3-24: VGA Cable

Chapter

4

Installation

4.1 Anti-static Precautions



WARNING:

Failure to take ESD precautions during the installation of the PM-BT may result in permanent damage to the PM-BT and severe injury to the user.

Electrostatic discharge (ESD) can cause serious damage to electronic components, including the PM-BT. Dry climates are especially susceptible to ESD. It is therefore critical that whenever the PM-BT or any other electrical component is handled, the following anti-static precautions are strictly adhered to.

- **Wear an anti-static wristband:** - Wearing a simple anti-static wristband can help to prevent ESD from damaging the board.
- **Self-grounding:**- Before handling the board touch any grounded conducting material. During the time the board is handled, frequently touch any conducting materials that are connected to the ground.
- **Use an anti-static pad:** When configuring the PM-BT, place it on an anti-static pad. This reduces the possibility of ESD damaging the PM-BT.
- **Only handle the edges of the PCB:-:** When handling the PCB, hold the PCB by the edges.

4.2 Installation Considerations



NOTE:

The following installation notices and installation considerations should be read and understood before installation. All installation notices must be strictly adhered to. Failing to adhere to these precautions may lead to severe damage and injury to the person performing the installation.

PM-BT SBC



WARNING:

The installation instructions described in this manual should be carefully followed in order to prevent damage to the components and injury to the user.

Before and during the installation please **DO** the following:

- Read the user manual:
 - The user manual provides a complete description of the PM-BT installation instructions and configuration options.
- Wear an electrostatic discharge cuff (ESD):
 - Electronic components are easily damaged by ESD. Wearing an ESD cuff removes ESD from the body and helps prevent ESD damage.
- Place the PM-BT on an anti-static pad:
 - When installing or configuring the motherboard, place it on an anti-static pad. This helps to prevent potential ESD damage.
- Turn all power to the PM-BT off:
 - When working with the PM-BT, make sure that it is disconnected from all power supplies and that no electricity is being fed into the system.

Before and during the installation of the PM-BT, **DO NOT**:

- Remove any of the stickers on the PCB board. These stickers are required for warranty validation.
- Use the product before verifying all the cables and power connectors are properly connected.
- Allow screws to come in contact with the PCB circuit, connector pins, or its components.

4.3 SO-DIMM Installation

To install a SO-DIMM, please follow the steps below and refer to **Figure 4-1**.

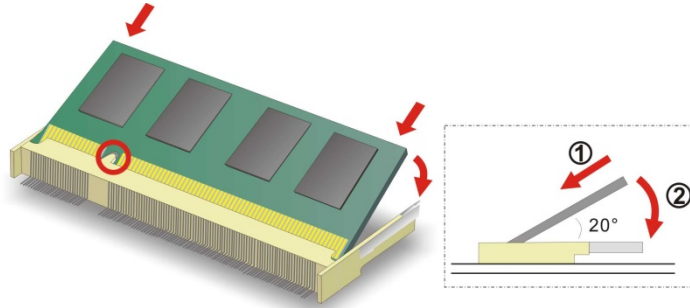

Figure 4-1: SO-DIMM Installation

- Step 1:** Locate the **SO-DIMM socket**. Place the board on an anti-static mat.
- Step 2:** Align the **SO-DIMM with the socket**. Align the notch on the memory with the notch on the memory socket.
- Step 3:** Insert the **SO-DIMM**. Push the memory in at a 20° angle. (See Figure 4-1)
- Step 4:** Seat the **SO-DIMM**. Gently push downwards and the arms clip into place. (See Figure 4-1)

4.4 Full-size PCIe Mini Card Installation

The PCIe Mini card slot allows installation of a full-size PCIe Mini card. To install a full-size PCIe Mini card, please follow the steps below.

Step 1: Locate the PCIe Mini card slot. See Chapter 3.

Step 2: Remove the retention screw. Remove the retention screw as shown in Figure 4-2.

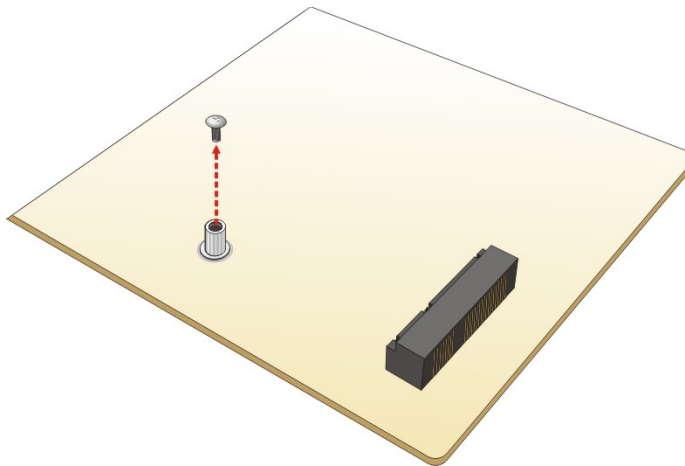

Figure 4-2: Removing the Retention Screw

Step 3: Insert into the socket at an angle. Line up the notch on the card with the notch on the slot. Slide the PCIe Mini card into the socket at an angle of about 20° (Figure 4-3).

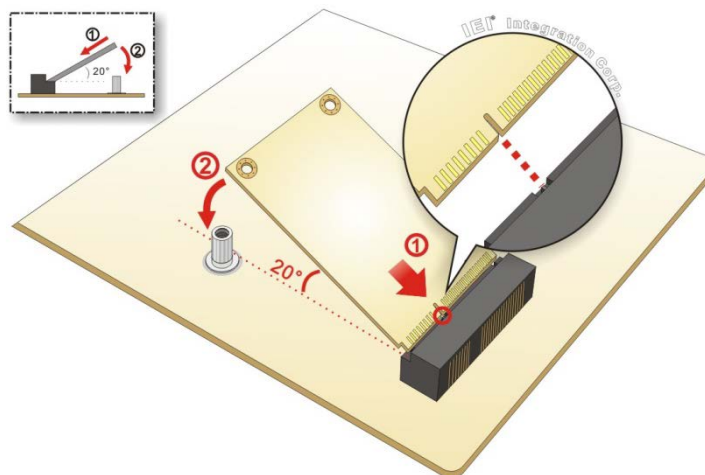

Figure 4-3: Inserting the Full-size PCIe Mini Card into the Slot at an Angle

Step 4: Secure the full-size PCIe Mini card. Secure the full-size PCIe Mini card with the retention screw previously removed (**Figure 4-4**).

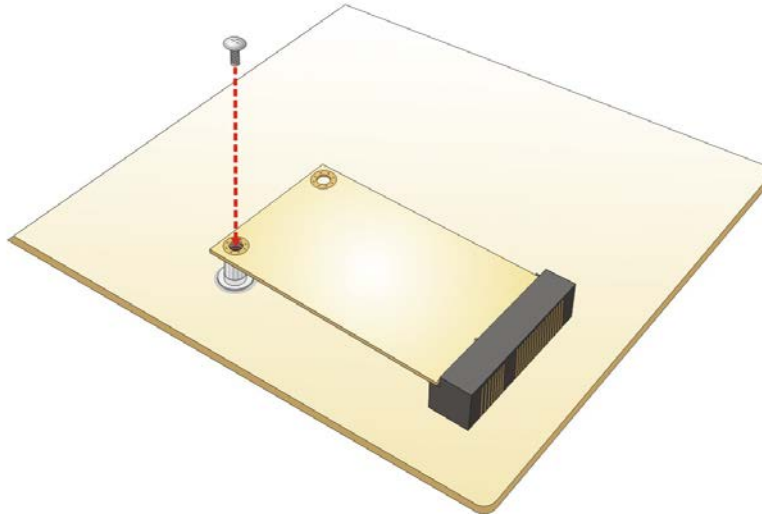

Figure 4-4: Securing the Full-size PCIe Mini Card

4.5 System Configuration

The system configuration should be performed before installation.

4.5.1 AT/ATX Power Mode Setting

The AT and ATX power mode selection is made through the AT/ATX power mode switch which is shown in **Figure 4-5**.

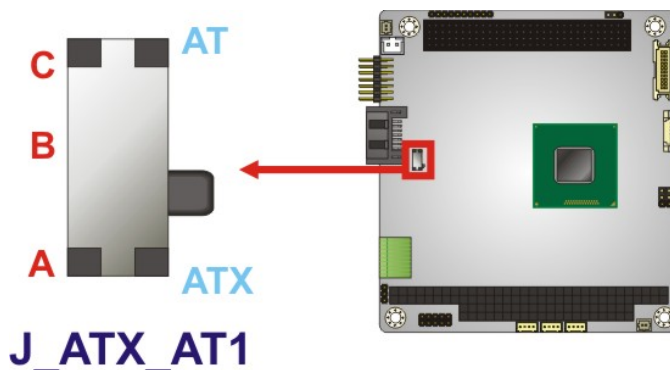

Figure 4-5: AT/ATX Power Mode Switch Location

PM-BT SBC

Setting	Description
Short A-B	ATX power mode (default)
Short B-C	AT power mode

Table 4-1: AT/ATX Power Mode Switch Settings

4.5.1 LVDS Panel Resolution Select Switch

- Jumper Label:** SW1
- Jumper Type:** DIP switch
- Jumper Settings:** See Table 4-2
- Jumper Location:** See Figure 4-6

Selects the resolution of the LCD panel connected to the LVDS connector.

* ON=0, OFF=1; Single=S

SW1 (4-3-2-1)	Description
0000	800x600 18-bit S (default)
0001	1024x768 18-bit S
0010	1024x768 24-bit S
0011	1280x768 18-bit S
0100	1280x800 18-bit S
0101	1280x960 18-bit S
0111	1366x768 18-bit S
1000	1366x768 24-bit S

Table 4-2: LVDS Panel Resolution Selection

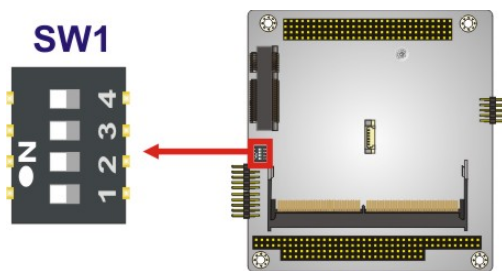

Figure 4-6: LVDS Panel Resolution Select Switch Location

4.5.1 LVDS Voltage Selection



WARNING:

Incorrect voltages can destroy the LCD panel. Make sure to select a voltage that matches the voltage required by the LCD panel.

- Jumper Label:** J_VLVDS1
- Jumper Type:** 6-pin header, p=2.00 mm
- Jumper Settings:** See Table 4-3
- Jumper Location:** See Figure 4-7

The LCD voltage selection jumper sets the voltage of the power supplied of the LCD panel.

Setting	Description
Short 1-3	Backlight Enable +3.3 V
Short 2-4	Set the voltage level of panel to +3.3 V
Short 3-5	Backlight Enable +5 V
Short 4-6	Set the voltage level of panel to +5 V

Table 4-3: LVDS Voltage Selection Jumper Settings

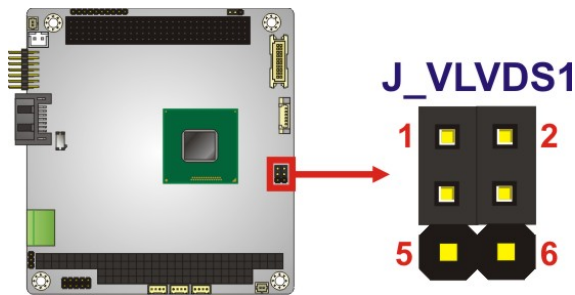

Figure 4-7: LVDS Voltage Selection Jumper Locations

PM-BT SBC

4.5.2 PCI Voltage Setup

- Jumper Label:** PCI_P_CN1
- Jumper Type:** 3-pin header, p=2.00 mm
- Jumper Settings:** See Table 4-4
- Jumper Location:** See Figure 4-8

This jumper selects the voltage supplied to the add-in module.

Setting	Description
Short 1-2	+5.0 V (Default)
Short 2-3	+3.3 V

Table 4-4: PCI Voltage Jumper Settings

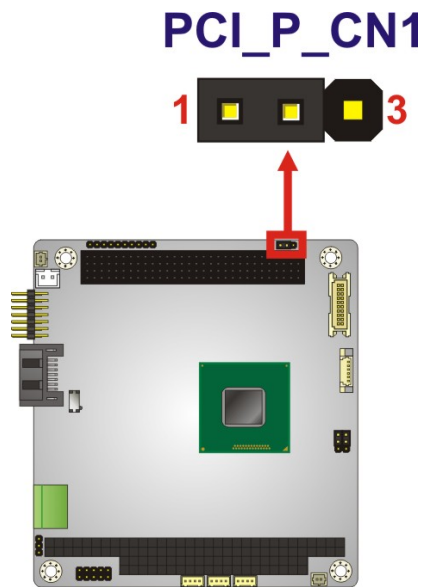

Figure 4-8: PCI Voltage Jumper Location

4.6 Available Drivers

All the drivers for the PM-BT are available on IEI Resource Download Center (<https://download.ieiworld.com>). Type PM-BT and press Enter to find all the relevant software, utilities, and documentation.

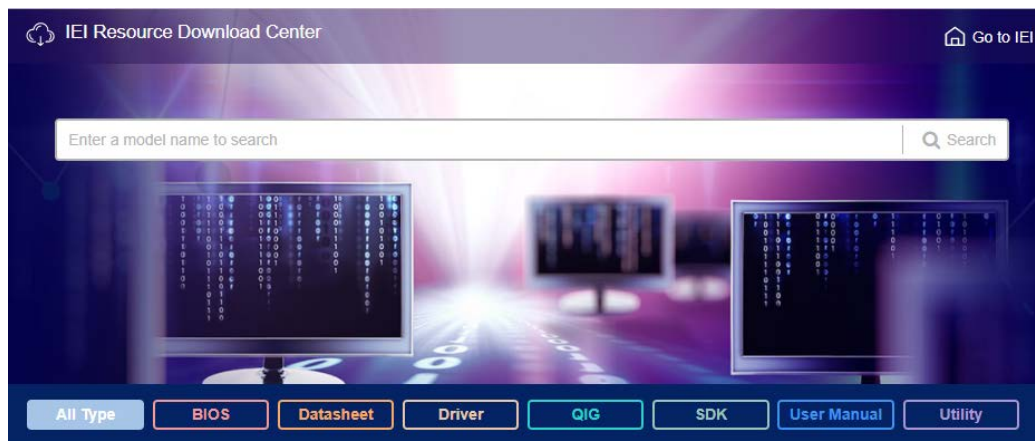
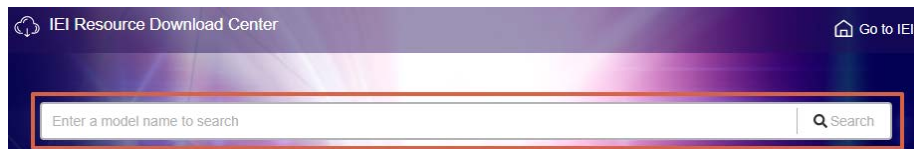

Figure 4-9: IEI Resource Download Center

4.6.1 Driver Download

To download drivers from IEI Resource Download Center, follow the steps below.

Step 1: Go to <https://download.ieiworld.com>. Type **PM-BT** and press Enter.



Step 2: All product-related software, utilities, and documentation will be listed. You can choose **Driver** to filter the result.

PM-BT SBC

Keyword: "WAFER-BW", Searching Result : 8 Records.

WAFER-BW Product Info

Embedded Computer > Single Board Computer > Embedded Board
3.5" SBC with Intel® 14nm Pentium®/Celeron® on-board SoC

Driver

File Name	Published	Version	File Checksum
7B000-001168-RS_V1.4.iso (2.99 GB)	2017/12/19	1.40	7FB3D8A55C9F2EB072E30AF64257FA51

Step 3: Click the driver file name on the page and you will be prompted with the following window. You can download the entire ISO file (❶), or click the small arrow to find an individual driver and click the file name to download (❷).

7B000-001168-RS_V1.4.iso

❶ [Click here to download entire ISO file. \(2.99 GB\)](#)

* Download individual file *

- Docs
 - 1.Chipset
 - 10.1.1.12.zip (2.7 MB)
 - 2.VGA
 - 3.Audio
 - 4.Lan
 - 5.USB 3.0
 - 6.Serial IO
 - 7.TXE
 - 8.Manual

❷



NOTE:

To install software from the downloaded ISO image file in Windows 8, 8.1 or 10, double-click the ISO file to mount it as a virtual drive to view its content. On Windows 7 system, an additional tool (such as Virtual CD-ROM Control Panel from Microsoft) is needed to mount the file.

4.7 OS Installation



WARNING:

Before installing the operating system, the user must enter the **Boot** BIOS menu first and choose which operating system will be installed. Otherwise, the OS installation may fail. Please refer to **Figure 4-10** and **Section 5.6**.

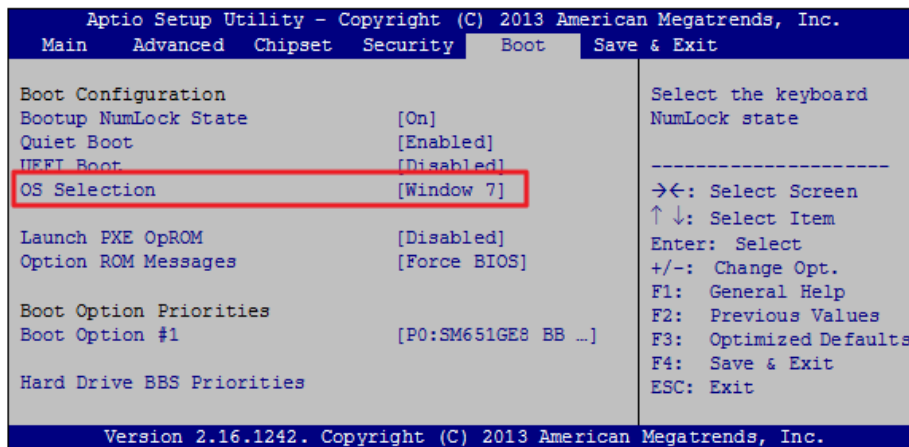

Figure 4-10: BIOS Option – OS Selection

Chapter

5

BIOS

5.1 Introduction

The BIOS is programmed onto the BIOS chip. The BIOS setup program allows changes to certain system settings. This chapter outlines the options that can be changed.



NOTE:

Some of the BIOS options may vary throughout the life cycle of the product and are subject to change without prior notice.

5.1.1 Starting Setup

The UEFI BIOS is activated when the computer is turned on. The setup program can be activated in one of two ways.

1. Press the **DEL** or **F2** key as soon as the system is turned on or
2. Press the **DEL** or **F2** key when the “**Press DEL or F2 to enter SETUP**” message appears on the screen.

If the message disappears before the **DEL** or **F2** key is pressed, restart the computer and try again.

5.1.2 Using Setup

Use the arrow keys to highlight items, press **ENTER** to select, use the PageUp and PageDown keys to change entries, press **F1** for help and press **ESC** to quit. Navigation keys are shown in the following table.

Key	Function
Up arrow	Move to previous item
Down arrow	Move to next item
Left arrow	Move to the item on the left hand side
Right arrow	Move to the item on the right hand side
+	Increase the numeric value or make changes
-	Decrease the numeric value or make changes

PM-BT SBC

Key	Function
Page Up	Move to the previous page
Page Dn	Move to the next page
Esc	Main Menu – Quit and not save changes into CMOS Status Page Setup Menu and Option Page Setup Menu -- Exit current page and return to Main Menu
F1	General help, only for Status Page Setup Menu and Option Page Setup Menu
F2	Load previous values
F3	Load optimized defaults
F4	Save changes and Exit BIOS

Table 5-1: BIOS Navigation Keys

5.1.3 Getting Help

When **F1** is pressed, a small help window describing the appropriate keys to use and the possible selections for the highlighted item appears. To exit the Help Window, press **Esc**.

5.1.4 Unable to Reboot after Configuration Changes

If the computer cannot boot after changes to the system configuration is made, CMOS defaults. Use the clear CMOS button described in **Chapter 4**.

5.1.5 BIOS Menu Bar

The **menu bar** on top of the BIOS screen has the following main items:

- Main – Changes the basic system configuration.
- Advanced – Changes the advanced system settings.
- Chipset – Changes the chipset settings.
- Security – Sets User and Supervisor Passwords.
- Boot – Changes the system boot configuration.
- Save & Exit – Selects exit options and loads default settings

The following sections completely describe the configuration options found in the menu items at the top of the BIOS screen and listed above.

5.2 Main

The **Main** BIOS menu (**BIOS Menu 1**) appears when the **BIOS Setup** program is entered.

The **Main** menu gives an overview of the basic system information.

```

Aptio Setup Utility - Copyright (C) 2013 American Megatrends, Inc.
Main  Advanced  Chipset  Security  Boot  Save & Exit

BIOS Information
BIOS Vendor                American Megatrends
Core Version                5.009
Compliance                 UEFI 2.3; PI 1.2
Project Version            B472AM10.ROM
Build Date and Time        04/30/2018 15:52:19

CPU Configuration
Microcode Patch            836
BayTrail SoC              C0 Stepping

Memory Information
Total Memory               4096 MB (LPDDR3)

TXE Information
Sec RC Version             00.05.00.00
TXE FW Version             01.00.02.1060

System Date                 [Fri 01/01/2010]
System Time                 [00:10:27]

Access Level                Administrator

Set the Date. Use Tab to
switch between Date
elements.

-----
-><: Select Screen
↑↓: Select Item
Enter: Select
+/-: Change Opt.
F1: General Help
F2: Previous Values
F3: Optimized Defaults
F4: Save & Exit
ESC: Exit

Version 2.16.1242. Copyright (C) 2013 American Megatrends, Inc.
    
```

BIOS Menu 1: Main

The **Main** menu has two user configurable fields:

➔ **System Date [xx/xx/xx]**

Use the **System Date** option to set the system date. Manually enter the day, month and year.

➔ **System Time [xx:xx:xx]**

Use the **System Time** option to set the system time. Manually enter the hours, minutes and seconds.

PM-BT SBC

5.3 Advanced

Use the **Advanced** menu (**BIOS Menu 2**) to configure the CPU and peripheral devices through the following sub-menus:



WARNING!

Setting the wrong values in the sections below may cause the system to malfunction. Make sure that the settings made are compatible with the hardware.

```

Aptio Setup Utility - Copyright (C) 2013 American Megatrends, Inc.
Main  Advanced  Chipset  Security  Boot  Save & Exit
-----
> Trusted Computing
> ACPI Settings
> F81866 Super IO Configuration
> iWDD H/M Monitor
> RTC Wake Settings
> Serial Port Console Redirection
> iEi Feature
> CPU Configuration
> IDE Configuration
> USB Configuration

System ACPI Parameters
-----
-><: Select Screen
↑↓: Select Item
Enter: Select
+/-: Change Opt.
F1: General Help
F2: Previous Values
F3: Optimized Defaults
F4: Save & Exit
ESC: Exit

Version 2.16.1242. Copyright (C) 2013 American Megatrends, Inc.
    
```

BIOS Menu 2: Advanced

5.3.1 Trusted Computing

Use the **Trusted Computing** menu (**BIOS Menu 3**) to configure settings related to the Trusted Computing Group (TCG) Trusted Platform Module (TPM).

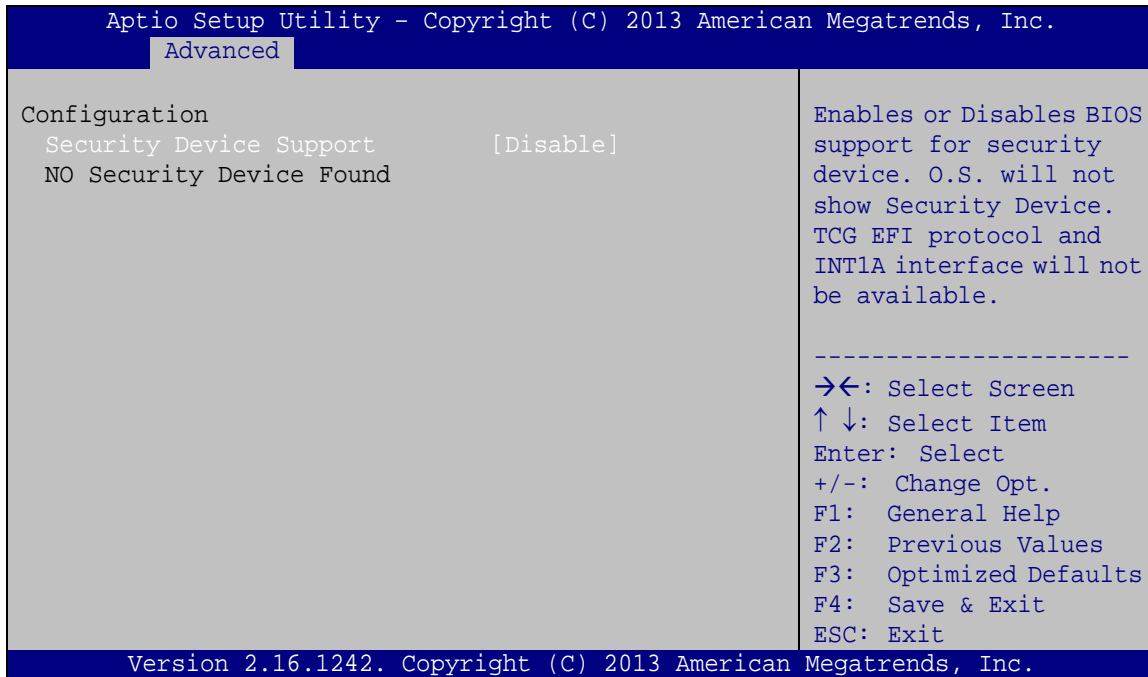

BIOS Menu 3: Trusted Computing

→ Security Device Support [Disable]

Use the **Security Device Support** option to configure support for the TPM.

- **Disable** DEFAULT TPM support is disabled.
- **Enable** TPM support is enabled.

PM-BT SBC

5.3.2 ACPI Settings

The **ACPI Settings** menu (**BIOS Menu 4**) configures the Advanced Configuration and Power Interface (ACPI) options.

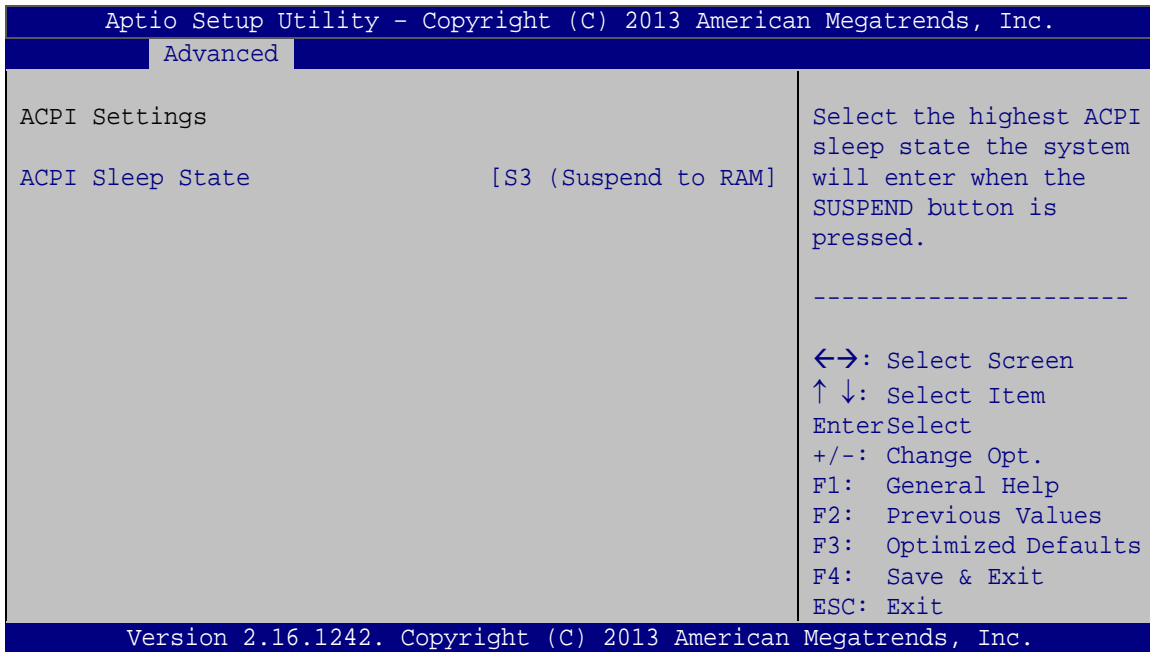

BIOS Menu 4: ACPI Configuration

→ ACPI Sleep State [S3 only (Suspend to RAM)]

The fields in **ACPI Sleep State** option cannot be changed.

- **S3 (Suspend to DEFAULT RAM)** The caches are flushed and the CPU is powered off. Power to the RAM is maintained. The computer returns slower to a working state, but more power is saved.

5.3.3 F81866 Super IO Configuration

Use the **F81866 Super IO Configuration** menu (**BIOS Menu 5**) to set or change the configurations for the serial ports and parallel port.

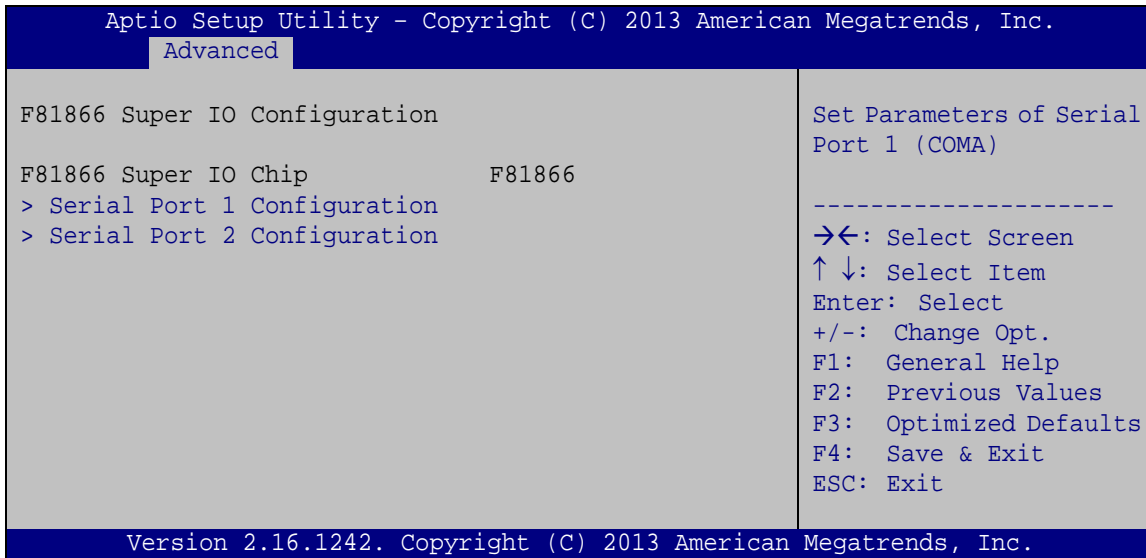

BIOS Menu 5: F81866 Super IO Configuration

5.3.3.1 Serial Port n Configuration

Use the **Serial Port n Configuration** menu (**BIOS Menu 6**) to configure the serial port n.

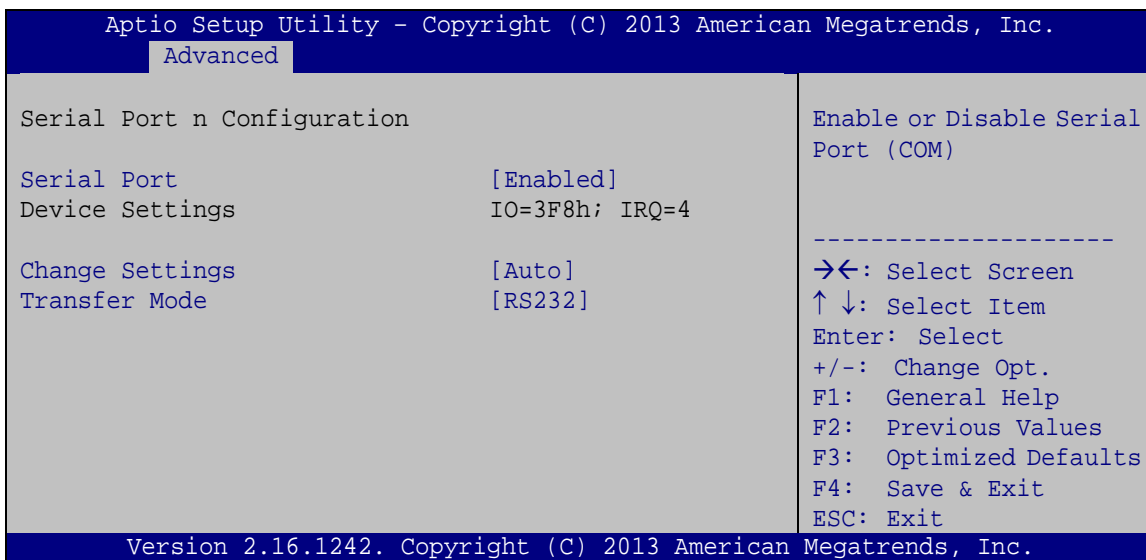

BIOS Menu 6: Serial Port n Configuration Menu

PM-BT SBC

5.3.3.1.1 Serial Port 1 Configuration

→ Serial Port [Enabled]

Use the **Serial Port** option to enable or disable the serial port.

- **Disabled** Disable the serial port
- **Enabled** **DEFAULT** Enable the serial port

→ Change Settings [Auto]

Use the **Change Settings** option to change the serial port IO port address and interrupt address.

- **Auto** **DEFAULT** The serial port IO port address and interrupt address are automatically detected.
- **IO=3F8h;**
IRQ=4 Serial Port I/O port address is 3F8h and the interrupt address is IRQ4
- **IO=3F8h;**
IRQ=3, 4 Serial Port I/O port address is 3F8h and the interrupt address is IRQ3, 4
- **IO=2F8h;**
IRQ=3, 4 Serial Port I/O port address is 2F8h and the interrupt address is IRQ3, 4
- **IO=3E8h;**
IRQ=3, 4 Serial Port I/O port address is 3E8h and the interrupt address is IRQ3, 4
- **IO=2E8h;**
IRQ=3, 4 Serial Port I/O port address is 2E8h and the interrupt address is IRQ3, 4

→ **Transfer Mode [RS232]**

Use the **Transfer Mode** option to select the Serial Port 1 signaling mode.

- **RS422** Serial Port 1 signaling mode is RS-422
- **RS232** **DEFAULT** Serial Port 1 signaling mode is RS-232
- **RS485** Serial Port 1 signaling mode is RS-485

5.3.3.1.2 Serial Port 2 Configuration

→ **Serial Port [Enabled]**

Use the **Serial Port** option to enable or disable the serial port.

- **Disabled** Disable the serial port
- **Enabled** **DEFAULT** Enable the serial port

→ **Change Settings [Auto]**

Use the **Change Settings** option to change the serial port IO port address and interrupt address.

- **Auto** **DEFAULT** The serial port IO port address and interrupt address are automatically detected.
- **IO=2F8h;
IRQ=3** Serial Port I/O port address is 2F8h and the interrupt address is IRQ3
- **IO=3F8h;
IRQ=3, 4** Serial Port I/O port address is 3F8h and the interrupt address is IRQ3, 4
- **IO=2F8h;
IRQ=3, 4** Serial Port I/O port address is 2F8h and the interrupt address is IRQ3, 4
- **IO=3E8h;
IRQ=3, 4** Serial Port I/O port address is 3E8h and the interrupt address is IRQ3, 4
- **IO=2E8h;
IRQ=3, 4** Serial Port I/O port address is 2E8h and the interrupt address is IRQ3, 4

PM-BT SBC

→ Transfer Mode [RS232]

Use the **Transfer Mode** option to select the Serial Port 2 signaling mode.

- **RS422** Serial Port 2 signaling mode is RS-422
- **RS232** **DEFAULT** Serial Port 2 signaling mode is RS-232
- **RS485** Serial Port 2 signaling mode is RS-485

5.3.4 F81866 H/W Monitor

The **F81866 H/W Monitor** menu (**BIOS Menu 7**) displays operating temperature, fan speeds and system voltages..

```

Aptio Setup Utility - Copyright (C) 2013 American Megatrends, Inc.
-----
Advanced
-----
PC Health Status

CPU temperature           : +46°C
System temperature       : +46°C
CPU_CORE                  : +0.744 V
+5V                       : +4.750 V
+12V                     : N/A
DDR                       : +1.355 V
+5VSB                    : +4.704 V
+3.3V                    : +3.296 V
+3.3VSB                  : +3.296 V

-----
→←: Select Screen
↑↓: Select Item
Enter: Select
+/-: Change Opt.
F1: General Help
F2: Previous Values
F3: Optimized Defaults
F4: Save & Exit
ESC: Exit
-----
Version 2.16.1242. Copyright (C) 2013 American Megatrends, Inc.
    
```

BIOS Menu 7: F81866 H/W Monitor

→ PC Health Status

The following system parameters and values are shown. The system parameters that are monitored are:

- System Temperatures:
 - CPU Temperature
 - System Temperature
- Voltages:

- CPU_CORE
- +5V
- +12V
- DDR
- +5VSB
- +3.3V
- +3.3VSB

5.3.5 RTC Wake Settings

The **RTC Wake Settings** menu (**BIOS Menu 8**) configures RTC wake event.

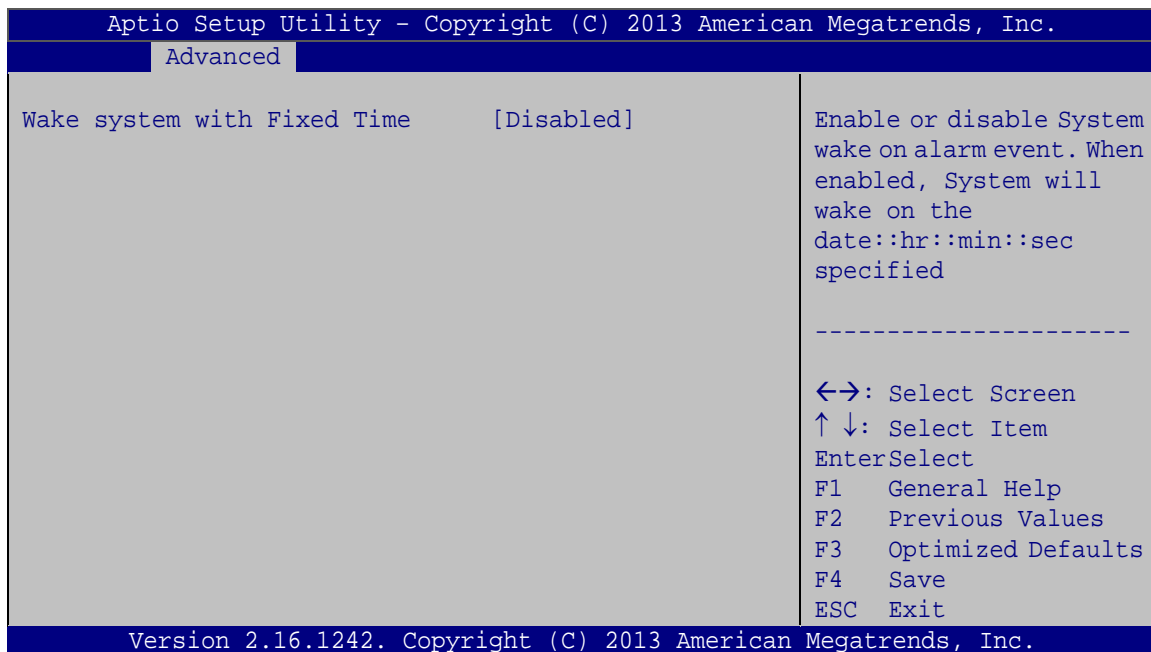

BIOS Menu 8: RTC Wake Settings

→ Wake system with Fixed Time [Disabled]

Use the **Wake system with Fixed Time** option to enable or disable the system wake on alarm event.

- **Disabled** **DEFAULT** The real time clock (RTC) cannot generate a wake event
- **Enabled** If selected, the **Wake up every day** option appears

PM-BT SBC

allowing you to enable to disable the system to wake every day at the specified time. Besides, the following options appear with values that can be selected:

Wake up date

Wake up hour

Wake up minute

Wake up second

After setting the alarm, the computer turns itself on from a suspend state when the alarm goes off.

5.3.6 Serial Port Console Redirection

The **Serial Port Console Redirection** menu (**BIOS Menu 9**) allows the console redirection options to be configured. Console redirection allows users to maintain a system remotely by re-directing keyboard input and text output through the serial port.

```

Aptio Setup Utility - Copyright (C) 2013 American Megatrends, Inc.
  Advanced
COM1
  Console Redirection          [Disabled]
> Console Redirection Settings
                                Console Redirection
                                Enable or Disable
                                -----
                                →←: Select Screen
                                ↑ ↓: Select Item
                                Enter: Select
                                +/-: Change Opt.
                                F1: General Help
                                F2: Previous Values
                                F3: Optimized Defaults
                                F4: Save & Exit
                                ESC: Exit
COM2
  Console Redirection          [Disabled]
> Console Redirection Settings
Version 2.16.1242. Copyright (C) 2013 American Megatrends, Inc.

```

BIOS Menu 9: Serial Port Console Redirection

→ Console Redirection [Disabled]

Use **Console Redirection** option to enable or disable the console redirection function.

- Disabled** **DEFAULT** Disabled the console redirection function
- Enabled** Enabled the console redirection function

The following options are available in the **Console Redirection Settings** submenu when the **Console Redirection** option is enabled.

→ Terminal Type [ANSI]

Use the **Terminal Type** option to specify the remote terminal type.

- VT100** The target terminal type is VT100
- VT100+** The target terminal type is VT100+
- VT-UTF8** The target terminal type is VT-UTF8
- ANSI** **DEFAULT** The target terminal type is ANSI

→ Bits per second [115200]

Use the **Bits per second** option to specify the serial port transmission speed. The speed must match the other side. Long or noisy lines may require lower speeds.

- 9600** Sets the serial port transmission speed at 9600.
- 19200** Sets the serial port transmission speed at 19200.
- 38400** Sets the serial port transmission speed at 38400.
- 57600** Sets the serial port transmission speed at 57600.
- 115200** **DEFAULT** Sets the serial port transmission speed at 115200.

→ Data Bits [8]

Use the **Data Bits** option to specify the number of data bits.

- 7** Sets the data bits at 7.
- 8** **DEFAULT** Sets the data bits at 8.

PM-BT SBC

→ Parity [None]

Use the **Parity** option to specify the parity bit that can be sent with the data bits for detecting the transmission errors.

- | | | | |
|---|--------------|----------------|---|
| → | None | DEFAULT | No parity bit is sent with the data bits. |
| → | Even | | The parity bit is 0 if the number of ones in the data bits is even. |
| → | Odd | | The parity bit is 0 if the number of ones in the data bits is odd. |
| → | Mark | | The parity bit is always 1. This option does not provide error detection. |
| → | Space | | The parity bit is always 0. This option does not provide error detection. |

→ Stop Bits [1]

Use the **Stop Bits** option to specify the number of stop bits used to indicate the end of a serial data packet. Communication with slow devices may require more than 1 stop bit.

- | | | | |
|---|----------|----------------|------------------------------------|
| → | 1 | DEFAULT | Sets the number of stop bits at 1. |
| → | 2 | | Sets the number of stop bits at 2. |

5.3.7 iEi Feature

Use the **iEi Feature** menu (**BIOS Menu 10**) to configure One Key Recovery function.

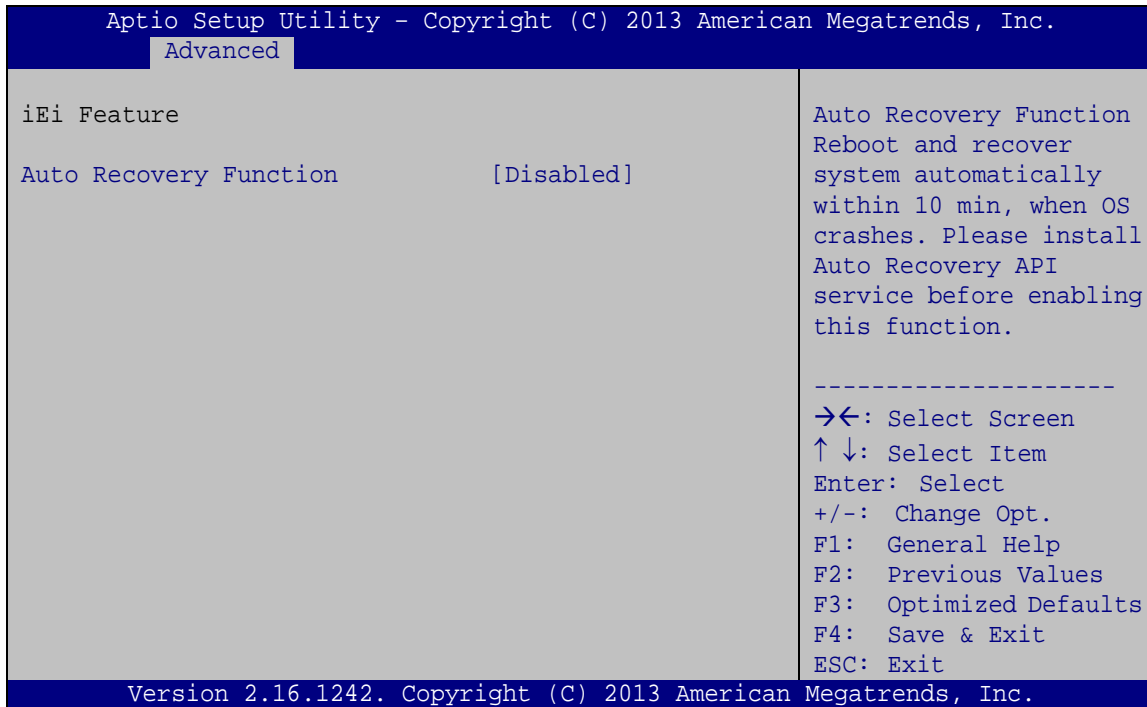

BIOS Menu 10: iEi Feature

→ Auto Recovery Function [Disabled]

Use the **Auto Recovery Function** BIOS option to enable or disable the auto recovery function of the IEI One Key Recovery.

- **Disabled** **DEFAULT** Auto recovery function disabled
- **Enabled** Auto recovery function enabled

PM-BT SBC

5.3.8 CPU Configuration

Use the **CPU Configuration** menu (**BIOS Menu 11**) to view detailed CPU specifications or enable the Intel Virtualization Technology.

```

Aptio Setup Utility - Copyright (C) 2013 American Megatrends, Inc.
  Advanced
CPU Information
Intel(R) Celeron(R) CPU N2807 @ 1.58GHz
CPU Signature           30678
Microcode Patch        836
Max CPU Speed          1580 MHz
Min CPU Speed          500 MHz
Processor Cores        2
Intel HT Technology     Not Supported
Intel VT-x Technology   Supported

L1 Data Cache          24 kB x 2
L1 Code Cache          32 kB x 2
L2 Cache               1024 kB x 1
L3 Cache               Not Present
64-bit                 Supported

Intel Virtualization Technology [Disabled]
EIST                   [Enabled]
CPU C state Report     [Disabled]

When enabled, a VMM can utilize the additional hardware capabilities provided by Vanderpool Technology.

-----
-><: Select Screen
↑ ↓: Select Item
Enter: Select
+/-: Change Opt.
F1: General Help
F2: Previous Values
F3: Optimized Defaults
F4: Save & Exit
ESC: Exit

Version 2.16.1242. Copyright (C) 2013 American Megatrends, Inc.
  
```

BIOS Menu 11: CPU Configuration

→ Intel Virtualization Technology [Disabled]

Use the **Intel Virtualization Technology** option to enable or disable virtualization on the system. When combined with third party software, Intel® Virtualization technology allows several OSs to run on the same system at the same time.

- **Disabled** **DEFAULT** Disables Intel Virtualization Technology.
- **Enabled** Enables Intel Virtualization Technology.

➔ **EIST [Enabled]**

Use the **EIST** option to enable or disable the Enhanced Intel® SpeedStep Technology (EIST).

- ➔ **Disabled** Disables Enhanced Intel® SpeedStep Technology
- ➔ **Enabled** **DEFAULT** Enables Enhanced Intel® SpeedStep Technology

➔ **CPU C State Report [Disabled]**

Use the **CPU C State Report** option to enable or disable CPU power management which allows CPU to go to C states when it is not 100% utilized.

- ➔ **Disabled** **DEFAULT** Disables CPU power management
- ➔ **Enabled** Enables CPU power management

5.3.9 IDE Configuration

Use the **IDE Configuration** menu (**BIOS Menu 12**) to change and/or set the configuration of the SATA devices installed in the system.

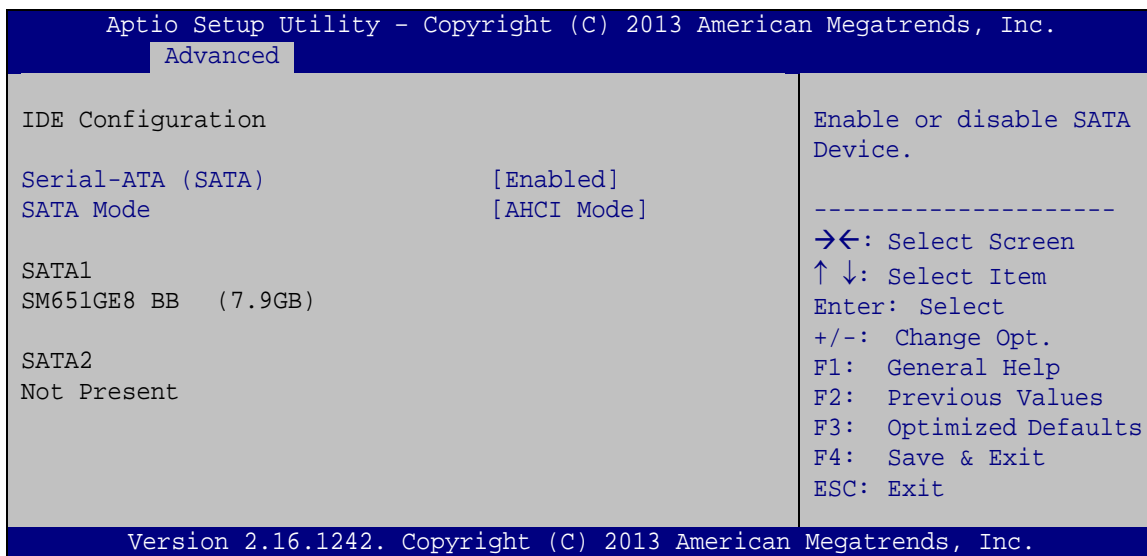

BIOS Menu 12: IDE Configuration

PM-BT SBC

→ Serial-ATA (SATA) [Enabled]

Use the **Serial-ATA (SATA)** option to configure the SATA controller.

- **Enabled** **DEFAULT** Enables the on-board SATA controller.
- **Disabled** Disables the on-board SATA controller.

→ SATA Mode [AHCI Mode]

Use the **SATA Mode** option to configure SATA devices as normal IDE devices.

- **IDE Mode** Configures SATA devices as normal IDE device.
- **AHCI Mode** **DEFAULT** Configures SATA devices as AHCI device.

5.3.10 USB Configuration

Use the **USB Configuration** menu (**BIOS Menu 13**) to read USB configuration information and configure the USB settings.

```

Aptio Setup Utility - Copyright (C) 2013 American Megatrends, Inc.
  Advanced
-----
USB Configuration                               Enables Legacy USB
                                                support. AUTO option
USB Devices:                                     disables legacy support
  1 Keyboard, 1 Hub                             if no USB devices are
                                                connected. DISABLE
Legacy USB Support                               option will keep USB
                                                devices available only
                                                for EFI applications.
                                                -----
                                                →←: Select Screen
                                                ↑ ↓: Select Item
                                                Enter: Select
                                                +/-: Change Opt.
                                                F1: General Help
                                                F2: Previous Values
                                                F3: Optimized Defaults
                                                F4: Save & Exit
                                                ESC: Exit
-----
Version 2.16.1242. Copyright (C) 2013 American Megatrends, Inc.

```

BIOS Menu 13: USB Configuration

→ **USB Devices**

The **USB Devices** field lists the USB devices that are enabled on the system

→ **Legacy USB Support [Enabled]**

Use the **Legacy USB Support** BIOS option to enable USB mouse and USB keyboard support. Normally if this option is not enabled, any attached USB mouse or USB keyboard does not become available until a USB compatible operating system is fully booted with all USB drivers loaded. When this option is enabled, any attached USB mouse or USB keyboard can control the system even when there is no USB driver loaded onto the system.

- | | | |
|-------------------|----------------|---|
| → Enabled | DEFAULT | Legacy USB support enabled |
| → Disabled | | Legacy USB support disabled |
| → Auto | | Legacy USB support disabled if no USB devices are connected |

5.4 Chipset

Use the **Chipset** menu (**BIOS Menu 14**) to access the North Bridge and South Bridge configuration menus.



WARNING!

Setting the wrong values for the Chipset BIOS selections in the Chipset BIOS menu may cause the system to malfunction.

PM-BT SBC

```

Aptio Setup Utility - Copyright (C) 2013 American Megatrends, Inc.
Main   Advanced  Chipset   Security  Boot   Save & Exit

> North Bridge
> South Bridge

North Bridge Parameters

-----
-><: Select Screen
↑ ↓: Select Item
Enter: Select
+/-: Change Opt.
F1: General Help
F2: Previous Values
F3: Optimized Defaults
F4: Save & Exit
ESC: Exit

Version 2.16.1242. Copyright (C) 2013 American Megatrends, Inc.

```

BIOS Menu 14: Chipset

5.4.1 North Bridge

Use the **North Bridge** menu (**BIOS Menu 15**) to configure the north bridge parameters.

```

Aptio Setup Utility - Copyright (C) 2013 American Megatrends, Inc.
Chipset

> Intel IGD Configuration

Memory Information

Total Memory          4096 MB (LPDDR3)
DIMM1                 4096 MB (LPDDR3)

Configure Intel IGD
Settings.

-----
-><: Select Screen
↑ ↓: Select Item
Enter: Select
+/-: Change Opt.
F1: General Help
F2: Previous Values
F3: Optimized Defaults
F4: Save & Exit
ESC: Exit

Version 2.16.1242. Copyright (C) 2013 American Megatrends, Inc.

```

BIOS Menu 15: North Bridge

PM-BT SBC

- **256M** **DEFAULT** 256 MB of memory used by internal graphics device
- **512M** 512 MB of memory used by internal graphics device

→ **DVMT Total Gfx Mem [Max]**

Use the **DVMT Total Gfx Mem** option to specify the maximum amount of memory that can be allocated as graphics memory. Configuration options are listed below.

- 128MB
- 256MB
- Max **DEFAULT**

→ **Primary IGFX Boot Display [VBIOS Default]**

Use the **Primary IGFX Boot Display** option to select the display device used by the system when it boots. Configuration options are listed below.

- VBIOS Default **DEFAULT**
- CRT
- LVDS

5.4.2 South Bridge

Use the **South Bridge** menu (**BIOS Menu 17**) to configure the south bridge parameters.

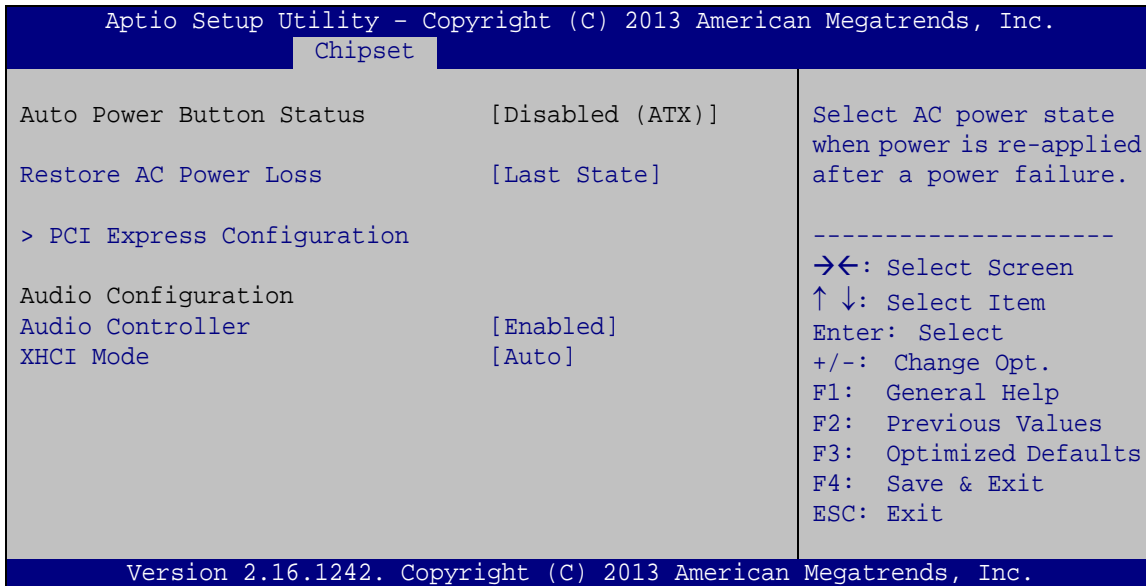

BIOS Menu 17: South Bridge

→ Restore on AC Power Loss [Last State]

Use the **Restore on AC Power Loss** BIOS option to specify what state the system returns to if there is a sudden loss of power to the system.

- **Power Off** The system remains turned off
- **Power On** The system turns on
- **Last State DEFAULT** The system returns to its previous state. If it was on, it turns itself on. If it was off, it remains off.

→ Audio Controller [Enabled]

Use the **Audio Controller** BIOS option to enable or disable the High Definition Audio controller.

- **Disabled** The High Definition Audio controller is disabled.
- **Enabled DEFAULT** The High Definition Audio controller is enabled.

PM-BT SBC

→ XHCI Mode [Auto]

Use the **XHCI Mode** BIOS option to configure the USB xHCI (USB 3.0) controller.

- **Enabled** Enable the xHCI controller.
- **Disabled** Disable the xHCI controller.
- **Auto** **DEFAULT** Allow the use of USB 3.0 devices prior to OS boot. USB 3.0 ports function as USB 3.0 ports even during a reboot.

5.4.2.1 PCI Express Configuration

Use the **PCI Express Configuration** submenu (**BIOS Menu 18**) to configure the PCIe Mini slot.

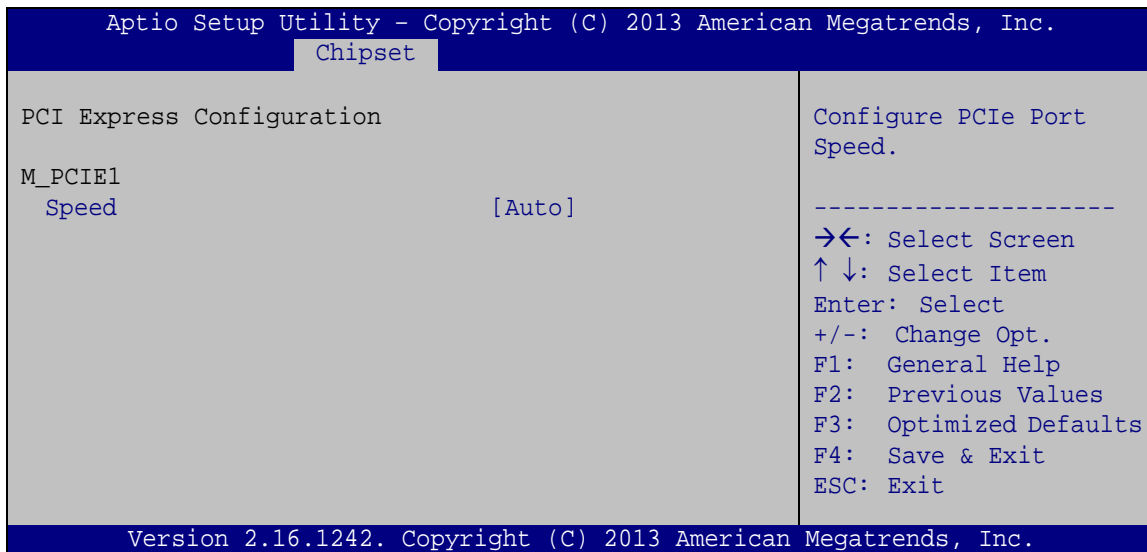

BIOS Menu 18: PCI Express Configuration

➔ **Speed [Auto]**

Use the **Speed** option to configure the speed of PCIe Mini slot.

- Auto **DEFAULT**
- Gen 2
- Gen 1

5.5 Security

Use the **Security** menu (**BIOS Menu 19**) to set system and user passwords.

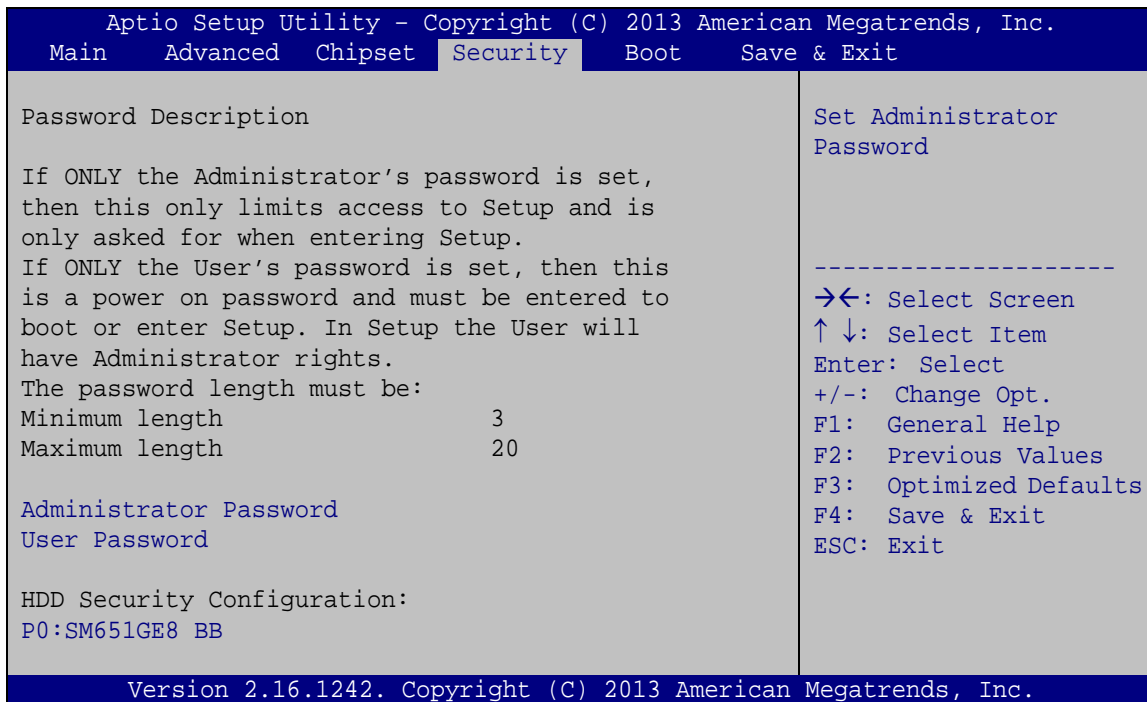

BIOS Menu 19: Security

➔ **Administrator Password**

Use the **Administrator Password** to set or change a administrator password.

➔ **User Password**

Use the **User Password** to set or change a user password.

PM-BT SBC

5.6 Boot

Use the **Boot** menu (**BIOS Menu 20**) to configure system boot options.

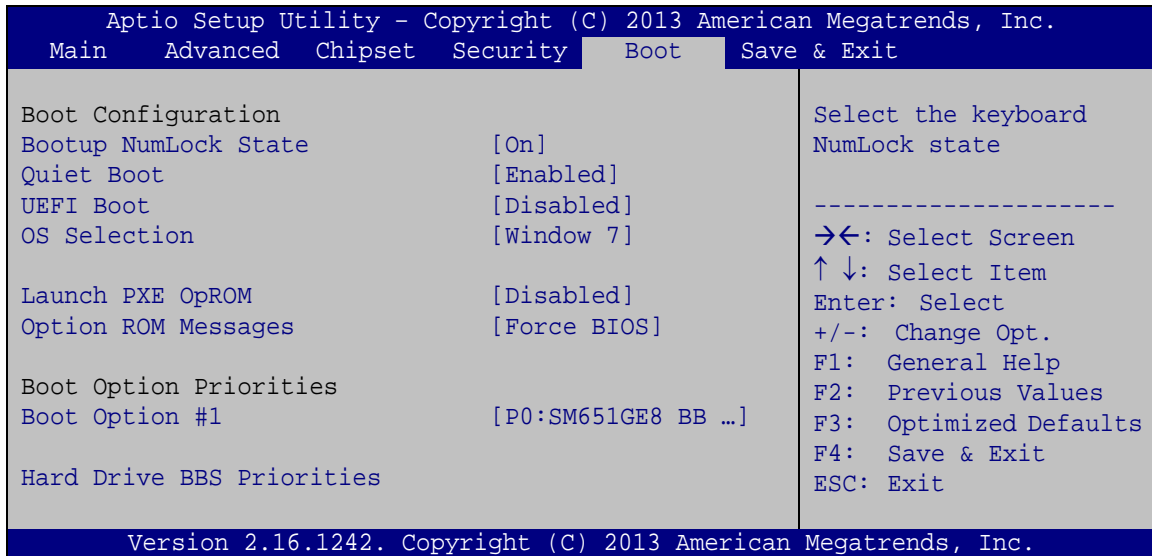

BIOS Menu 20: Boot

→ Bootup NumLock State [On]

Use the **Bootup NumLock State** BIOS option to specify if the number lock setting must be modified during boot up.

→ **On** **DEFAULT** Allows the Number Lock on the keyboard to be enabled automatically when the computer system boots up. This allows the immediate use of the 10-key numeric keypad located on the right side of the keyboard. To confirm this, the Number Lock LED light on the keyboard is lit.

→ **Off** Does not enable the keyboard Number Lock automatically. To use the 10-keys on the keyboard, press the Number Lock key located on the upper left-hand corner of the 10-key pad. The Number Lock LED on the keyboard lights up when the Number Lock is engaged.

→ Quiet Boot [Enabled]

Use the **Quiet Boot** BIOS option to select the screen display when the system boots.

- **Disabled** Normal POST messages displayed
- **Enabled** **DEFAULT** OEM Logo displayed instead of POST messages

→ UEFI Boot [Disabled]

Use the **UEFI Boot** option to enable or disable to boot from the UEFI devices.

- **Enabled** Boot from UEFI devices is enabled.
- **Disabled** **DEFAULT** Boot from UEFI devices is disabled.

→ OS Selection [Windows 7]

Use the **OS Selection** BIOS option to select an operating system (OS) before installing OS.

- **Windows 8.x** The system will be installed with Windows 8.x operating system.
- **Android** The system will be installed with Android operating system.
- **Windows 7** **DEFAULT** The system will be installed with Windows 7 operating system.

**WARNING:**

Before installing the operating system, the user must enter the **Boot** BIOS menu and choose which operating system will be installed. Otherwise, the OS installation may fail.

PM-BT SBC

→ Launch PXE OpROM [Disabled]

Use the **Launch PXE OpROM** option to enable or disable boot option for legacy network devices.

- **Disabled** **DEFAULT** Ignore all PXE Option ROMs
- **Enabled** Load PXE Option ROMs.

→ Option ROM Messages [Force BIOS]

Use the **Option ROM Messages** option to set the Option ROM display mode.

- **Force BIOS** **DEFAULT** Sets display mode to force BIOS.
- **Keep Current** Sets display mode to current.

5.7 Save & Exit

Use the **Safe & Exit** menu (**BIOS Menu 21**) to load default BIOS values, optimal failsafe values and to save configuration changes.

```

Aptio Setup Utility - Copyright (C) 2013 American Megatrends, Inc.
Main   Advanced  Chipset  Security  Boot   Save & Exit
-----
Save Changes and Reset
Discard Changes and Reset

Restore Defaults
Save as User Defaults
Restore User Defaults

Exit the system after
saving the changes.

-----
→←: Select Screen
↑↓: Select Item
Enter: Select
+/-: Change Opt.
F1: General Help
F2: Previous Values
F3: Optimized Defaults
F4: Save & Exit
ESC: Exit

Version 2.16.1242. Copyright (C) 2013 American Megatrends, Inc.
    
```

BIOS Menu 21: Save & Exit

→ **Save Changes and Reset**

Use the **Save Changes and Reset** option to save the changes made to the BIOS options and reset the system.

→ **Discard Changes and Reset**

Use the **Discard Changes and Reset** option to exit the system without saving the changes made to the BIOS configuration setup program.

→ **Restore Defaults**

Use the **Restore Defaults** option to load the optimal default values for each of the parameters on the Setup menus. **F3 key can be used for this operation.**

→ **Save as User Defaults**

Use the **Save as User Defaults** option to save the changes done so far as user defaults.

→ **Restore User Defaults**

Use the **Restore User Defaults** option to restore the user defaults to all the setup options.

Appendix

A

Regulatory Compliance

DECLARATION OF CONFORMITY

This equipment has been tested and found to comply with specifications for CE marking. If the user modifies and/or installs other devices in the equipment, the CE conformity declaration may no longer apply.

FCC WARNING

This equipment complies with Part 15 of the FCC Rules. Operation is subject to the following two conditions:

- This device may not cause harmful interference, and
- This device must accept any interference received, including interference that may cause undesired operation.

This equipment has been tested and found to comply with the limits for a Class A digital device, pursuant to part 15 of the FCC Rules. These limits are designed to provide reasonable protection against harmful interference when the equipment is operated in a commercial environment. This equipment generates, uses, and can radiate radio frequency energy and, if not installed and used in accordance with the instruction manual, may cause harmful interference to radio communications. Operation of this equipment in a residential area is likely to cause harmful interference in which case the user will be required to correct the interference at his own expense.

Appendix

B

Product Disposal

**CAUTION:**

Risk of explosion if battery is replaced by an incorrect type. Only certified engineers should replace the on-board battery.

Dispose of used batteries according to instructions and local regulations.

- Outside the European Union–If you wish to dispose of used electrical and electronic products outside the European Union, please contact your local authority so as to comply with the correct disposal method.
- Within the European Union–The device that produces less waste and is easier to recycle is classified as electronic device in terms of the European Directive 2012/19/EU (WEEE), and must not be disposed of as domestic garbage.

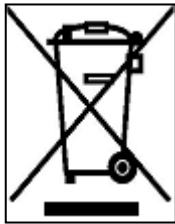

EU-wide legislation, as implemented in each Member State, requires that waste electrical and electronic products carrying the mark (left) must be disposed of separately from normal household waste. This includes monitors and electrical accessories, such as signal cables or power cords. When you need to dispose of your device, please follow the guidance of your local authority, or ask the shop where you purchased the product. The mark on electrical and electronic products only applies to the current European Union Member States.

Please follow the national guidelines for electrical and electronic product disposal.

Appendix

C

BIOS Options

Below is a list of BIOS configuration options in the BIOS chapter.

<input type="checkbox"/>	System Date [xx/xx/xx]	54
<input type="checkbox"/>	System Time [xx:xx:xx]	54
<input type="checkbox"/>	Security Device Support [Disable]	56
<input type="checkbox"/>	ACPI Sleep State [S3 only (Suspend to RAM)]	57
<input type="checkbox"/>	Serial Port [Enabled]	59
<input type="checkbox"/>	Change Settings [Auto]	59
<input type="checkbox"/>	Transfer Mode [RS232]	60
<input type="checkbox"/>	Serial Port [Enabled]	60
<input type="checkbox"/>	Change Settings [Auto]	60
<input type="checkbox"/>	Transfer Mode [RS232]	61
<input type="checkbox"/>	PC Health Status	61
<input type="checkbox"/>	Wake system with Fixed Time [Disabled]	62
<input type="checkbox"/>	Console Redirection [Disabled]	64
<input type="checkbox"/>	Terminal Type [ANSI]	64
<input type="checkbox"/>	Bits per second [115200]	64
<input type="checkbox"/>	Data Bits [8]	64
<input type="checkbox"/>	Parity [None]	65
<input type="checkbox"/>	Stop Bits [1]	65
<input type="checkbox"/>	Auto Recovery Function [Disabled]	66
<input type="checkbox"/>	Intel Virtualization Technology [Disabled]	67
<input type="checkbox"/>	EIST [Enabled]	68
<input type="checkbox"/>	CPU C State Report [Disabled]	68
<input type="checkbox"/>	Serial-ATA (SATA) [Enabled]	69
<input type="checkbox"/>	SATA Mode [AHCI Mode]	69
<input type="checkbox"/>	USB Devices	70
<input type="checkbox"/>	Legacy USB Support [Enabled]	70
<input type="checkbox"/>	Primary Display [Auto]	72
<input type="checkbox"/>	DVMT Pre-Allocated [256M]	72
<input type="checkbox"/>	DVMT Total Gfx Mem [Max]	73
<input type="checkbox"/>	Primary IGFX Boot Display [VBIOS Default]	73
<input type="checkbox"/>	Restore on AC Power Loss [Last State]	74
<input type="checkbox"/>	Audio Controller [Enabled]	74
<input type="checkbox"/>	XHCI Mode [Auto]	75

PM-BT SBC

<input type="checkbox"/> Speed [Auto].....	76
<input type="checkbox"/> Administrator Password	76
<input type="checkbox"/> User Password	76
<input type="checkbox"/> Bootup NumLock State [On].....	77
<input type="checkbox"/> Quiet Boot [Enabled]	78
<input type="checkbox"/> UEFI Boot [Disabled]	78
<input type="checkbox"/> OS Selection [Windows 7].....	78
<input type="checkbox"/> Launch PXE OpROM [Disabled]	79
<input type="checkbox"/> Option ROM Messages [Force BIOS].....	79
<input type="checkbox"/> Save Changes and Reset	80
<input type="checkbox"/> Discard Changes and Reset	80
<input type="checkbox"/> Restore Defaults	80
<input type="checkbox"/> Save as User Defaults	80
<input type="checkbox"/> Restore User Defaults	80

Appendix

D

Digital I/O Interface

PM-BT SBC

D.1 Introduction

The DIO connector on the PM-BT is interfaced to GPIO ports on the Super I/O chipset. The DIO has both 4-bit digital inputs and 4-bit digital outputs. The digital inputs and digital outputs are generally control signals that control the on/off circuit of external devices or TTL devices. Data can be read or written to the selected address to enable the DIO functions.



NOTE:

For further information, please refer to the datasheet for the Super I/O chipset.

The BIOS interrupt call **INT 15H** controls the digital I/O.

INT 15H:

AH – 6FH	
<u>Sub-function:</u>	
AL – 8	: Set the digital port as INPUT
AL	: Digital I/O input value

D.2 Assembly Language Sample 1

```
MOV     AX, 6F08H      ;setting the digital port as input
INT     15H           ;
```

AL low byte = value

AH – 6FH
<u>Sub-function:</u>
AL – 9 : Set the digital port as OUTPUT
BL : Digital I/O input value

D.3 Assembly Language Sample 2

```
MOV     AX, 6F09H      ;setting the digital port as output
MOV     BL, 09H        ;digital value is 09H
INT     15H           ;
```

Digital Output is 1001b

Appendix

E

Watchdog Timer

**NOTE:**

The following discussion applies to DOS environment. Contact IEI support or visit the IEI website for specific drivers for other operating systems.

The Watchdog Timer is provided to ensure that standalone systems can always recover from catastrophic conditions that cause the CPU to crash. This condition may have occurred by external EMIs or a software bug. When the CPU stops working correctly, Watchdog Timer either performs a hardware reset (cold boot) or a Non-Maskable Interrupt (NMI) to bring the system back to a known state.

A BIOS function call (INT 15H) is used to control the Watchdog Timer.

INT 15H:

AH – 6FH Sub-function:	
AL – 2:	Sets the Watchdog Timer's period.
BL:	Time-out value (Its unit-second is dependent on the item "Watchdog Timer unit select" in CMOS setup).

Table E-1: AH-6FH Sub-function

Call sub-function 2 to set the time-out period of Watchdog Timer first. If the time-out value is not zero, the Watchdog Timer starts counting down. When the timer value reaches zero, the system resets. To ensure that this reset condition does not occur, calling sub-function 2 must periodically refresh the Watchdog Timer. However, the watchdog timer is disabled if the time-out value is set to zero.

A tolerance of at least 10% must be maintained to avoid unknown routines within the operating system (DOS), such as disk I/O that can be very time-consuming.

PM-BT SBC

**NOTE:**

When exiting a program it is necessary to disable the Watchdog Timer, otherwise the system resets.

EXAMPLE PROGRAM:

; INITIAL TIMER PERIOD COUNTER

;

W_LOOP:

;

```

MOV      AX, 6F02H      ;setting the time-out value
MOV      BL, 30         ;time-out value is 48 seconds
INT      15H

```

;

; ADD THE APPLICATION PROGRAM HERE

;

```

CMP      EXIT_AP, 1     ;is the application over?
JNE      W_LOOP        ;No, restart the application

```

```

MOV      AX, 6F02H      ;disable Watchdog Timer
MOV      BL, 0          ;
INT      15H

```

;

; EXIT ;

Appendix

F

Hazardous Materials Disclosure

PM-BT SBC

The details provided in this appendix are to ensure that the product is compliant with the Peoples Republic of China (China) RoHS standards. The table below acknowledges the presences of small quantities of certain materials in the product, and is applicable to China RoHS only.

A label will be placed on each product to indicate the estimated “Environmentally Friendly Use Period” (EFUP). This is an estimate of the number of years that these substances would “not leak out or undergo abrupt change.” This product may contain replaceable sub-assemblies/components which have a shorter EFUP such as batteries and lamps. These components will be separately marked.

Please refer to below table.

Part Name	Toxic or Hazardous Substances and Elements					
	Lead (Pb)	Mercury (Hg)	Cadmium (Cd)	Hexavalent Chromium (CR(VI))	Polybrominated Biphenyls (PBB)	Polybrominated Diphenyl Ethers (PBDE)
Housing	O	O	O	O	O	O
Display	O	O	O	O	O	O
Printed Circuit Board	O	O	O	O	O	O
Metal Fasteners	O	O	O	O	O	O
Cable Assembly	O	O	O	O	O	O
Fan Assembly	O	O	O	O	O	O
Power Supply Assemblies	O	O	O	O	O	O
Battery	O	O	O	O	O	O

O: This toxic or hazardous substance is contained in all of the homogeneous materials for the part is below the limit requirement in SJ/T11363-2006 (now replaced by GB/T 26572-2011).

X: This toxic or hazardous substance is contained in at least one of the homogeneous materials for this part is above the limit requirement in SJ/T11363-2006 (now replaced by GB/T 26572-2011).

此附件旨在确保本产品符合中国 RoHS 标准。以下表格标示此产品中某有毒物质的含量符合中国 RoHS 标准规定的限量要求。

本产品上会附有“环境友好使用期限”的标签，此期限是估算这些物质“不会有泄漏或突变”的年限。本产品可能包含有较短的环境友好使用期限的可替换元件，像是电池或灯管，这些元件将会单独标示出来。

部件名称	有毒有害物质或元素					
	铅 (Pb)	汞 (Hg)	镉 (Cd)	六价铬 (CR(VI))	多溴联苯 (PBB)	多溴二苯 醚 (PBDE)
壳体	○	○	○	○	○	○
显示	○	○	○	○	○	○
印刷电路板	○	○	○	○	○	○
金属螺帽	○	○	○	○	○	○
电缆组装	○	○	○	○	○	○
风扇组装	○	○	○	○	○	○
电力供应组装	○	○	○	○	○	○
电池	○	○	○	○	○	○

○: 表示该有毒有害物质在该部件所有物质材料中的含量均在 SJ/T 11363-2006 (现由 GB/T 26572-2011 取代) 标准规定的限量要求以下。

X: 表示该有毒有害物质至少在该部件的某一均质材料中的含量超出 SJ/T 11363-2006 (现由 GB/T 26572-2011 取代) 标准规定的限量要求。