



**MODEL:  
HYPER-BW**

**PICO-ITX SBC supports Intel® 14nm Pentium®/Celeron®/Atom® on-board SoC, dual Mini HDMI, M.2 2242, GbE, USB 3.0, SATA 6Gb/s, COM, Audio and RoHS**

# User Manual

# Revision

---

Date	Version	Changes
28 January, 2019	1.05	Updated Figure 3-3: AT/ATX Mode Select Switch Location
20 November, 2018	1.04	Updated Section 3.3.3: Power Connector
2 March, 2018	1.03	Updated Section 1.2: Model Variations Updated Section 2.4: Optional Items Added Section 4.6: Power Cable Connection
13 December, 2017	1.02	Updated Section 1.5: Dimensions
6 July, 2017	1.01	Updated Section 1.2: Model Variations Updated Section 1.7: Technical Specifications
27 June, 2016	1.00	Initial release

# Copyright

---

## **COPYRIGHT NOTICE**

The information in this document is subject to change without prior notice in order to improve reliability, design and function and does not represent a commitment on the part of the manufacturer.

In no event will the manufacturer be liable for direct, indirect, special, incidental, or consequential damages arising out of the use or inability to use the product or documentation, even if advised of the possibility of such damages.

This document contains proprietary information protected by copyright. All rights are reserved. No part of this manual may be reproduced by any mechanical, electronic, or other means in any form without prior written permission of the manufacturer.

## **TRADEMARKS**

All registered trademarks and product names mentioned herein are used for identification purposes only and may be trademarks and/or registered trademarks of their respective owners.

# Manual Conventions

---



## **WARNING**

Warnings appear where overlooked details may cause damage to the equipment or result in personal injury. Warnings should be taken seriously.



## **CAUTION**

Cautionary messages should be heeded to help reduce the chance of losing data or damaging the product.



## **NOTE**

These messages inform the reader of essential but non-critical information. These messages should be read carefully as any directions or instructions contained therein can help avoid making mistakes.



## **HOT SURFACE**

This symbol indicates a hot surface that should not be touched without taking care.

# Table of Contents

<b>1 INTRODUCTION</b> .....	<b>1</b>
1.1 INTRODUCTION .....	2
1.2 MODEL VARIATIONS.....	2
1.3 FEATURES .....	3
1.4 CONNECTORS.....	4
1.5 DIMENSIONS.....	6
1.6 DATA FLOW.....	8
1.7 TECHNICAL SPECIFICATIONS.....	9
<b>2 UNPACKING</b> .....	<b>11</b>
2.1 ANTI-STATIC PRECAUTIONS .....	12
2.2 UNPACKING PRECAUTIONS .....	12
2.3 PACKING LIST.....	13
2.4 OPTIONAL ITEMS.....	14
<b>3 CONNECTORS</b> .....	<b>15</b>
3.1 PERIPHERAL INTERFACE CONNECTORS.....	16
3.1.1 HYPER-BW Layout.....	16
3.1.2 Peripheral Interface Connectors .....	17
3.1.3 External Interface Panel Connectors.....	18
3.2 INTERNAL PERIPHERAL CONNECTORS.....	18
3.2.1 AT/ATX Mode Select Switch.....	18
3.2.2 Audio Connector .....	19
3.2.3 Battery Connector.....	20
3.2.4 BIOS FW Connector .....	21
3.2.5 Buzzer Connector.....	21
3.2.6 Clear CMOS Button.....	22
3.2.7 CPU Fan Connector .....	23
3.2.8 DDR3L SO-DIMM Slot.....	24
3.2.9 Debug Connector.....	24
3.2.10 EC FW Connector.....	25

3.2.11 Front Panel Connector.....	26
3.2.12 LAN LED Connector.....	27
3.2.13 M.2 2242 (B key) Slot.....	28
3.2.14 RS-232 Serial Port Connector .....	28
3.2.15 SATA 6Gb/s Drive Connector .....	29
3.2.16 SATA Power Connector.....	30
3.2.17 SMBus Connector .....	31
3.2.18 USB Connector .....	31
3.3 EXTERNAL PERIPHERAL INTERFACE CONNECTOR PANEL .....	32
3.3.1 HDMI Connectors.....	33
3.3.2 LAN Connector .....	34
3.3.3 Power Connector .....	34
3.3.4 USB Connectors.....	35
<b>4 INSTALLATION.....</b>	<b>36</b>
4.1 ANTI-STATIC PRECAUTIONS.....	37
4.2 INSTALLATION CONSIDERATIONS .....	37
4.3 SO-DIMM INSTALLATION.....	39
4.4 M.2 MODULE INSTALLATION.....	40
4.5 INTERNAL PERIPHERAL DEVICE CONNECTIONS.....	41
4.5.1 SATA Drive Connection .....	41
4.5.2 Single RS-232 Cable .....	42
4.6 POWER CABLES CONNECTION.....	43
4.7 HEAT SINK ENCLOSURE .....	44
4.8 SOFTWARE INSTALLATION.....	45
4.8.1 Available Drivers .....	45
4.8.2 Driver Download .....	45
<b>5 BIOS .....</b>	<b>47</b>
5.1 INTRODUCTION .....	48
5.1.1 Starting Setup.....	48
5.1.2 Using Setup .....	48
5.1.3 Getting Help.....	49
5.1.4 Unable to Reboot after Configuration Changes .....	49
5.1.5 BIOS Menu Bar.....	49

## HYPER-BW

5.2 MAIN .....	50
5.3 ADVANCED .....	51
5.3.1 ACPI Settings .....	52
5.3.2 IT8528 Super IO Configuration .....	53
5.3.2.1 Serial Port 1 Configuration .....	53
5.3.3 iWDD H/W Monitor .....	55
5.3.3.1 Smart Fan Mode Configuration .....	56
5.3.4 RTC Wake Settings .....	59
5.3.5 Serial Port Console Redirection .....	60
5.3.5.1 Console Redirection Settings .....	61
5.3.6 iEi Feature .....	63
5.3.7 CPU Configuration .....	64
5.3.8 SATA Configuration .....	65
5.3.9 USB Configuration .....	66
5.4 CHIPSET .....	67
5.4.1 North Bridge Configuration .....	68
5.4.1.1 Intel IGD Configuration .....	68
5.4.2 Southbridge Configuration .....	71
5.4.2.1 PCI Express Configuration .....	72
5.4.2.2 M.2 Socket PCIEx1 .....	73
5.5 SECURITY .....	74
5.6 BOOT .....	75
5.7 EXIT .....	77
<b>A REGULATORY COMPLIANCE .....</b>	<b>79</b>
<b>B PRODUCT DISPOSAL .....</b>	<b>81</b>
<b>C BIOS OPTIONS .....</b>	<b>83</b>
<b>D TERMINOLOGY .....</b>	<b>86</b>
<b>E WATCHDOG TIMER .....</b>	<b>90</b>
<b>F HAZARDOUS MATERIALS DISCLOSURE .....</b>	<b>93</b>

# List of Figures

Figure 1-1: HYPER-BW.....	2
Figure 1-2: Connectors (Front Side).....	4
Figure 1-3: Connectors (Solder Side).....	5
Figure 1-4: Dimensions (mm).....	7
Figure 1-5: Data Flow Diagram.....	8
Figure 3-1: Connector and Jumper Locations (Front).....	16
Figure 3-2: Connector and Jumper Locations (Rear).....	16
Figure 3-3: AT/ATX Mode Select Switch Location .....	19
Figure 3-4: Audio Connector Location .....	19
Figure 3-5: Battery Connector Location.....	20
Figure 3-6: BIOS FW Connector Location.....	21
Figure 3-7: Buzzer Connector Location .....	22
Figure 3-8: Clear CMOS Button Location.....	23
Figure 3-9: CPU Fan Connector Location .....	23
Figure 3-10: DDR3L SO-DIMM Slot Location .....	24
Figure 3-11: Debug Port Connector Location.....	25
Figure 3-12: EC FW Connector Location .....	26
Figure 3-13: Front Panel Connector Location .....	26
Figure 3-14: LAN LED Connector Locations .....	27
Figure 3-15: M.2 2242 (B key) Slot Location .....	28
Figure 3-16: RS-232 Serial Port Connector Location.....	29
Figure 3-17: SATA 6Gb/s Drive Connector Location .....	30
Figure 3-18: SATA Power Connector Location .....	30
Figure 3-19: SMBus Connector Location .....	31
Figure 3-20: USB Connector Location.....	32
Figure 3-21: External Peripheral Interface Connector .....	33
Figure 3-22: HDMI Connector .....	33
Figure 3-23: LAN Connector .....	34
Figure 3-24: Power Connector .....	35
Figure 4-1: SO-DIMM Installation .....	39
Figure 4-2: Inserting the M.2 Module into the Slot at an Angle .....	40



## **HYPER-BW**

<b>Figure 4-3: Securing the M.2 Module.....</b>	<b>40</b>
<b>Figure 4-4: SATA Drive Cable Connection.....</b>	<b>41</b>
<b>Figure 4-5: Single RS-232 Cable Installation .....</b>	<b>42</b>
<b>Figure 4-4: Power Cables Connection.....</b>	<b>43</b>
<b>Figure 4-6: Heat Sink Retention Screws .....</b>	<b>44</b>
<b>Figure 4-8: IEI Resource Download Center.....</b>	<b>45</b>

# List of Tables

---

Table 1-1: HYPER-BW Model Variations .....	2
Table 1-2: Technical Specifications.....	10
Table 3-1: Peripheral Interface Connectors .....	17
Table 3-2: Rear Panel Connectors .....	18
Table 3-3: AT/ATX Mode Select Switch Settings.....	18
Table 3-4: Audio Connector Pinouts .....	20
Table 3-5: Battery Connector Pinouts .....	20
Table 3-6: BIOS FW Connector Pinouts .....	21
Table 3-7: Buzzer Connector Pinouts.....	22
Table 3-8: Clear CMOS Button Settings .....	22
Table 3-9: CPU Fan Connector Pinouts.....	23
Table 3-10: Debug Port Connector Pinouts .....	25
Table 3-11: EC FW Connector Pinouts.....	26
Table 3-12: Front Panel Connector Pinouts.....	27
Table 3-13: LAN LED Connector Pinouts .....	27
Table 3-14: RS-232 Serial Port Connector Pinouts .....	29
Table 3-15: SATA Power Connector Pinouts.....	30
Table 3-16: SMBus Connector Pinouts .....	31
Table 3-17: USB Connector Pinouts .....	32
Table 3-18: HDMI Connector Pinouts .....	33
Table 3-19: LAN Pinouts .....	34
Table 3-20: Connector LEDs.....	34
Table 3-21: Power Connector Pinouts.....	35
Table 3-22: USB 2.0 & USB 3.0 Port Pinouts .....	35
Table 5-1: BIOS Navigation Keys .....	49

# BIOS Menus

---

BIOS Menu 1: Main .....	50
BIOS Menu 2: Advanced .....	51
BIOS Menu 3: ACPI Configuration .....	52
BIOS Menu 4: Super IO Configuration.....	53
BIOS Menu 5: Serial Port 1 Configuration Menu .....	53
BIOS Menu 6: Hardware Monitor.....	55
BIOS Menu 7: Smart Fan Mode Configuration .....	56
BIOS Menu 8: RTC Wake Settings .....	59
BIOS Menu 9: Serial Port Console Redirection .....	60
BIOS Menu 10: Console Redirection Settings.....	61
BIOS Menu 11: IEI Feature .....	63
BIOS Menu 12: CPU Configuration .....	64
BIOS Menu 13: IDE Configuration .....	65
BIOS Menu 14: USB Configuration .....	66
BIOS Menu 15: Chipset .....	67
BIOS Menu 16: Northbridge Chipset Configuration.....	68
BIOS Menu 17: Integrated Graphics .....	69
BIOS Menu 18: Southbridge Chipset Configuration .....	71
BIOS Menu 19: PCI Express Configuration .....	72
BIOS Menu 20: PCI Express Configuration .....	73
BIOS Menu 21: Security .....	74
BIOS Menu 22: Boot .....	75
BIOS Menu 23:Exit.....	77

**Chapter**

**1**

# **Introduction**

---

## 1.1 Introduction



**Figure 1-1: HYPER-BW**

The HYPER-BW is a PICO-ITX motherboard. It accepts an Intel® Pentium®/Celeron®/Atom® on-board SoC and supports one 204-pin 1333/1600 MHz single-channel DDR3L SDRAM unbuffered SO-DIMM module up to 8 GB.

The HYPER-BW includes two mini HDMI ports. Expansion and I/O include one USB 2.0 connector and one USB 3.0 connector on the rear panel, two USB 2.0 connectors by pin header and one SATA 6Gb/s connector. Serial device connectivity is provided by one internal RS-232 connector. One RJ-45 Ethernet connector provides the system with smooth connections to an external LAN.

## 1.2 Model Variations

The model variations of the HYPER-BW Series are listed below.

Model No.	SoC
HYPER-BW-N4	Intel® Pentium® 14nm quad-core N3710 up to 2.56GHz (6W)
HYPER-BW-N3	Intel® Celeron® 14nm quad-core N3160 up to 2.24GHz (6W)
HYPER-BW-N2	Intel® Celeron® 14nm dual-core N3060 up to 2.48GHz (6W)
HYPER-BW-N1	Intel® Celeron® 14nm dual-core N3010 up to 2.24GHz (4W)
HYPER-BW-E8-ECO	Intel® Atom® 14nm quad-core x5-E8000 up to 2.00GHz (5W)
HYPER-BW-E8	Intel® Atom® 14nm quad-core x5-E8000 up to 2.00GHz (5W)

**Table 1-1: HYPER-BW Model Variations**

## HYPER-BW

### 1.3 Features

Some of the HYPER-BW motherboard features are listed below:

- Pico-ITX SBC supports Intel® 14nm Pentium®/Celeron®/Atom® on-board SoC
- IEI jumper-less function
- Dual independent display support
- 1333/1600 MHz 1.35V DDR3L SDRAM up to 8 GB supported
- COM, USB 3.0, SATA 6Gb/s and Audio support
- 1 x M.2 2242 B key slot for expansion possibility
- IEI One Key Recovery solution allows you to create rapid OS backup and recovery

## 1.4 Connectors

The connectors on the HYPER-BW are shown in the figure below.

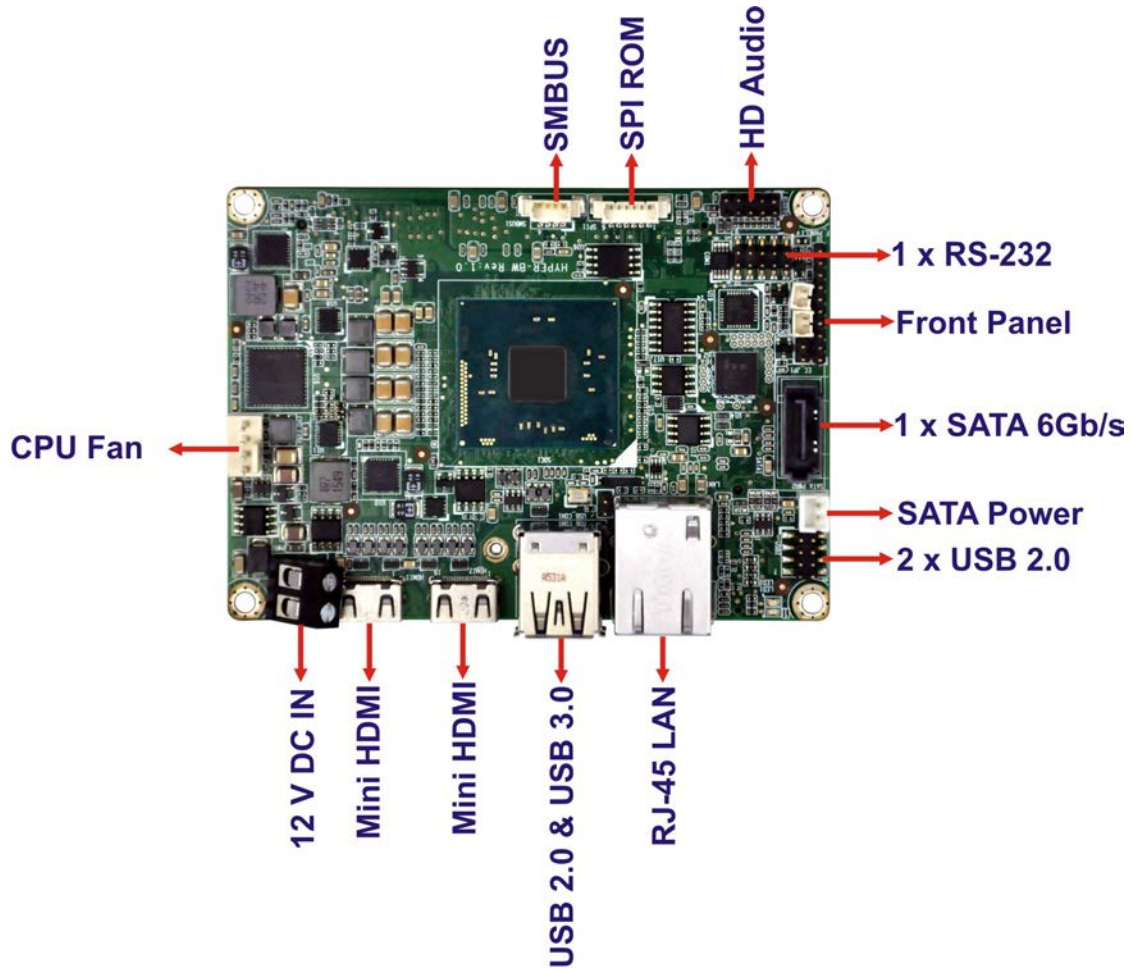

Figure 1-2: Connectors (Front Side)

HYPER-BW

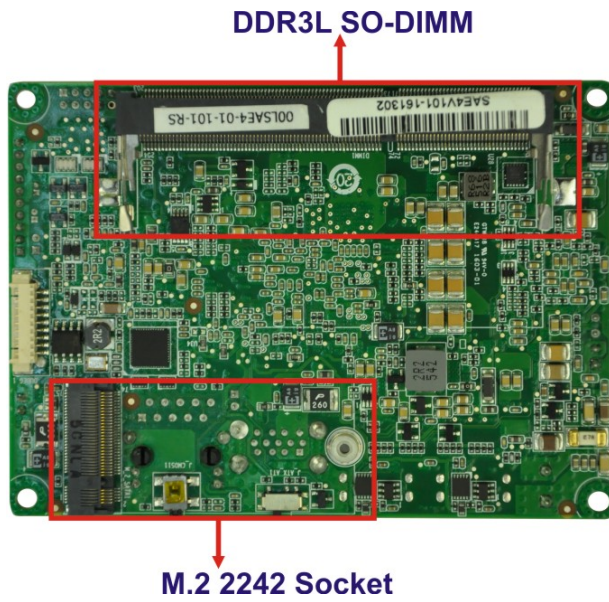
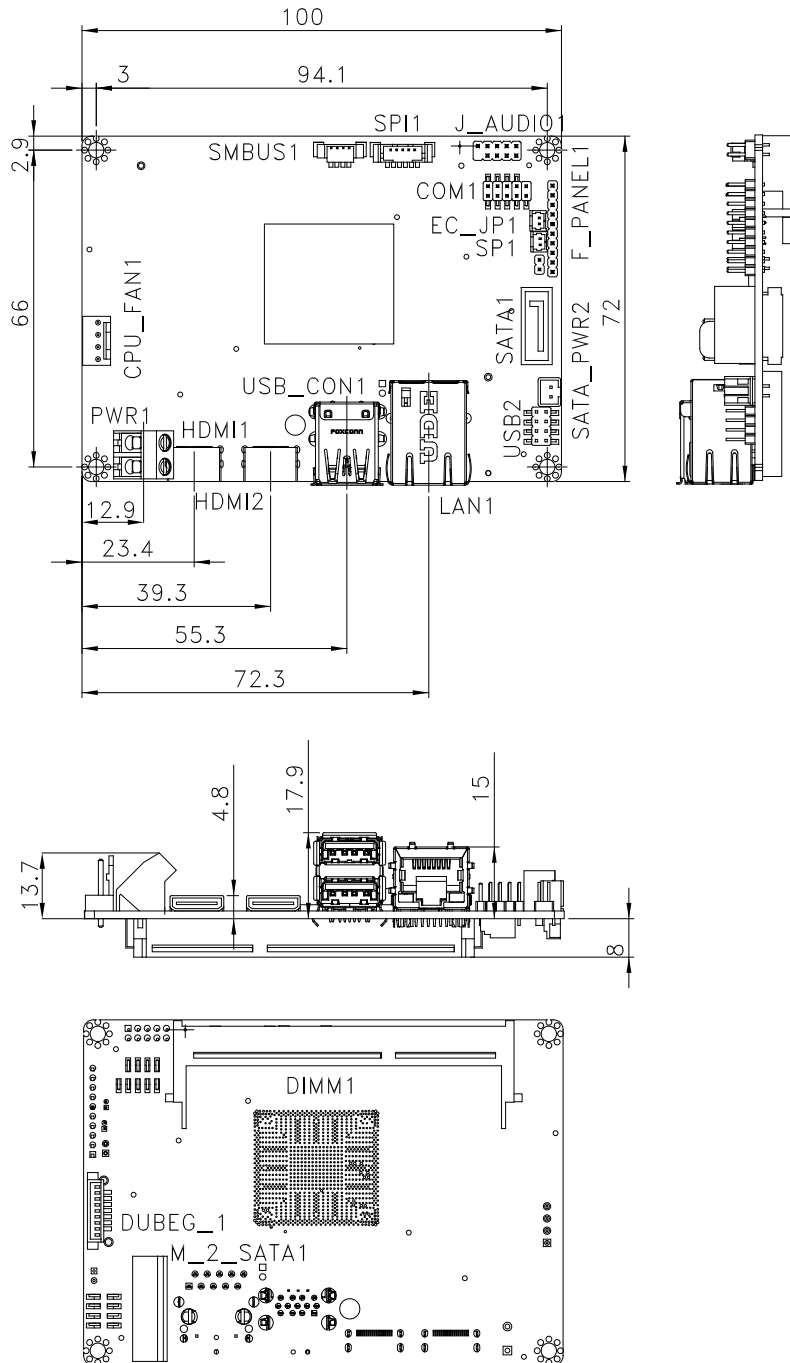

Figure 1-3: Connectors (Solder Side)



## 1.5 Dimensions

The dimensions of the board are listed below:



HYPER-BW

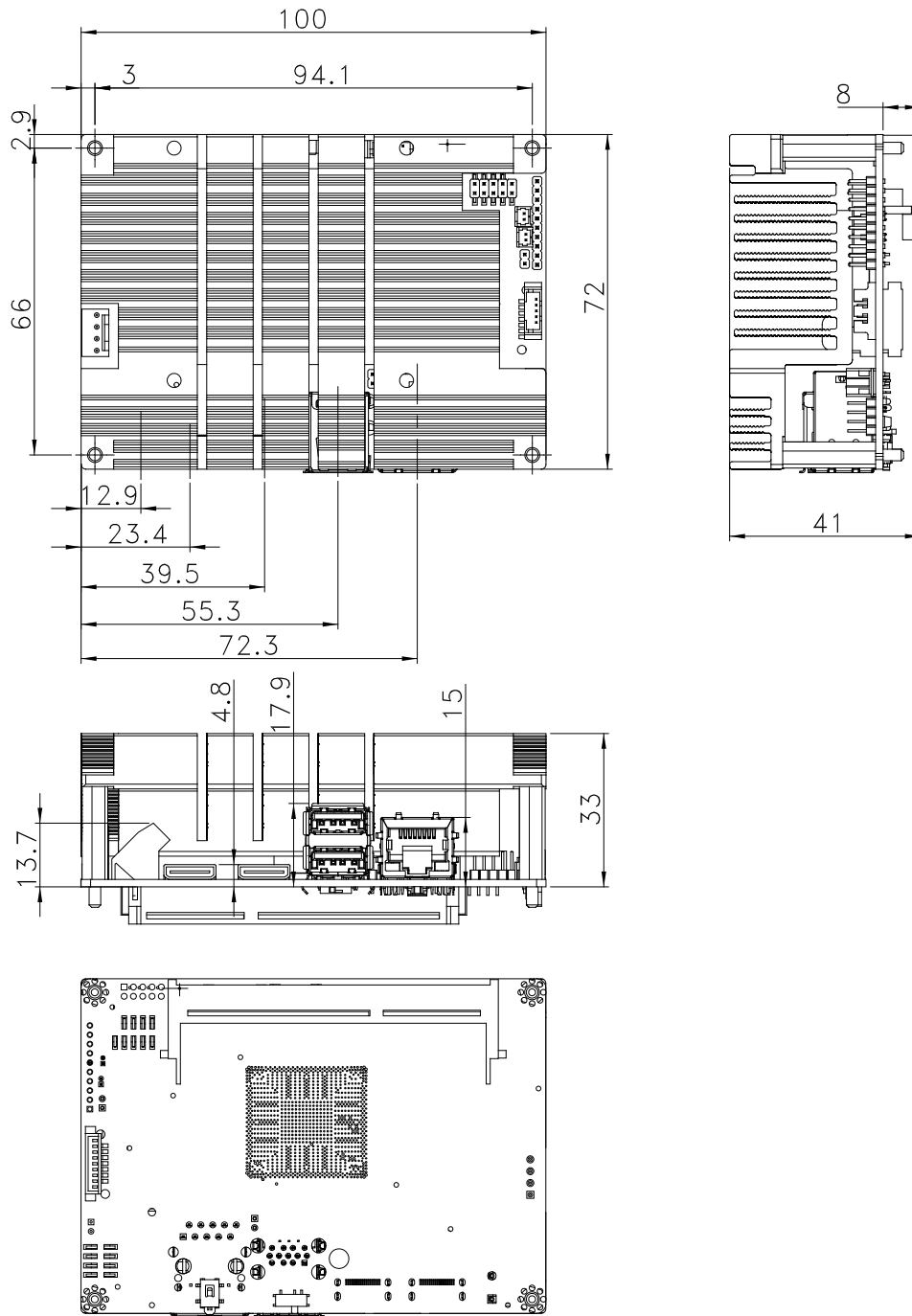

Figure 1-4: Dimensions (mm)

## 1.6 Data Flow

Figure 1-5 shows the data flow between the system chipset, the CPU and other components installed on the motherboard.

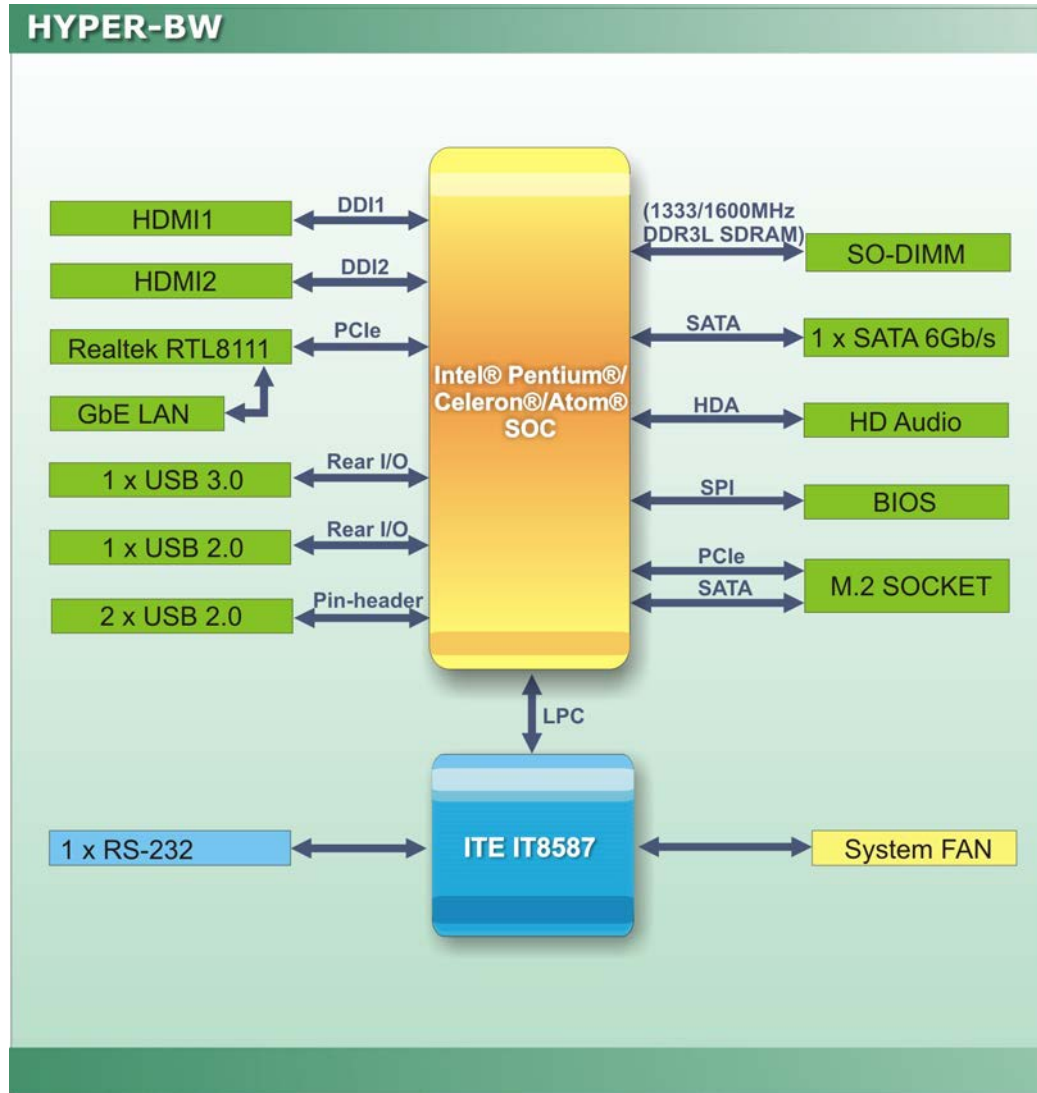

Figure 1-5: Data Flow Diagram

## HYPER-BW

### 1.7 Technical Specifications

HYPER-BW technical specifications are listed below.

Specification	HYPER-BW
<b>SoC</b>	<p>Intel® Pentium® N3710 on-board SoC (up to 2.56GHz, quad-core, 2MB cache, TDP=6W)</p> <p>Intel® Celeron® N3160 on-board SoC (up to 2.24GHz, quad-core, 2MB cache, TDP=6W)</p> <p>Intel® Celeron® N3060 on-board SoC (up to 2.48GHz, dual-core, 2MB cache, TDP=6W)</p> <p>Intel® Celeron® N3010 on-board SoC (up to 2.24GHz, dual-core, 2MB cache, TDP=4W)</p> <p>Intel® Atom® x5-E8000 on-board SoC (up to 2.00GHz, quad-core, 2MB cache, TDP=5W)</p>
<b>BIOS</b>	AMI UEFI BIOS
<b>Memory</b>	One 204-pin 1333/1600 MHz single-channel DDR3L SDRAM unbuffered SO-DIMM slot support up to 8 GB
<b>Graphics</b>	Intel® HD Graphics Gen 8 Engine with 16 low-power execution units, supporting DX11.1, OpenGL 4.2 and OpenCL1.2
<b>Display Output</b>	<p>Dual independent display</p> <p>2 x Mini HDMI (up to 3840x2160@30Hz)</p>
<b>Ethernet</b>	LAN1: Realtek RTL8111 controller
<b>EC</b>	IT8587
<b>Watchdog Timer</b>	Software programmable support 1~255 sec. system reset
<b>I/O Interface</b>	
<b>Audio Connector</b>	1 x HD Audio by 10-pin (2x5) header
<b>Ethernet</b>	One RJ-45 port
<b>Serial Ports</b>	1 x RS-232 (by pin header)

Specification	HYPER-BW
<b>USB Ports</b>	1 x USB 3.0 (on rear I/O) 3 x USB 2.0 (1 on rear I/O, 2 by pin header)
<b>Front Panel</b>	1 x Front panel (1x10 pin, power LED, HDD LED, power button, reset button)
<b>LAN LED</b>	1 x 2-pin (1x2) header
<b>FAN</b>	1 x Smart fan connector (1x4 pin)
<b>Expansion</b>	1 x M.2 2242 slot (B key, SATA and PCIe signal)
<b>Storage</b>	
<b>Serial ATA</b>	1 x SATA 6G/s with 5V SATA power connector (No RAID) (SATA port0)
<b>Environmental and Power Specifications</b>	
<b>Power Supply</b>	12V DC input only 1 x Power terminal block (1x2 pin) Support AT/ATX mode
<b>Power Consumption</b>	12V@1.52A (Intel® Pentium® processor N3710 with 8 GB 1600 MHz DDR3L memory)
<b>Operating Temperature</b>	-20°C ~ 60°C
<b>Storage Temperature</b>	-30°C ~ 70°C
<b>Humidity</b>	5% ~ 95%, non-condensing
<b>Vibration</b>	3G
<b>Physical Specifications</b>	
<b>Dimensions</b>	100 mm x 72 mm
<b>Weight GW/NW</b>	600 g / 250 g

**Table 1-2: Technical Specifications**

Chapter

2

# Unpacking

---

## 2.1 Anti-static Precautions

---



### WARNING!

Static electricity can destroy certain electronics. Make sure to follow the ESD precautions to prevent damage to the product, and injury to the user.

---

Make sure to adhere to the following guidelines:

- **Wear an anti-static wristband:** Wearing an anti-static wristband can prevent electrostatic discharge.
- **Self-grounding:** Touch a grounded conductor every few minutes to discharge any excess static buildup.
- **Use an anti-static pad:** When configuring any circuit board, place it on an anti-static mat.
- **Only handle the edges of the PCB:** Don't touch the surface of the motherboard. Hold the motherboard by the edges when handling.

## 2.2 Unpacking Precautions

When the HYPER-BW is unpacked, please do the following:

- Follow the antistatic guidelines above.
- Make sure the packing box is facing upwards when opening.
- Make sure all the packing list items are present.

## HYPER-BW





### 2.3 Packing List



#### NOTE:

If any of the components listed in the checklist below are missing, do not proceed with the installation. Contact the IEI reseller or vendor the HYPER-BW was purchased from or contact an IEI sales representative directly by sending an email to [sales@iei.com.tw](mailto:sales@iei.com.tw).



The HYPER-BW is shipped with the following components:

Quantity	Item and Part Number	Image
1	1 x HYPER-BW single board computer with specific heat sink	
1	SATA with power cable kit (P/N: 32801-000201-300-RS)	
1	RS-232 cable (P/N: 32205-002700-200-RS)	
1	Quick Installation Guide	
<p><b>** HYPER-BW-E8-ECO-R10 is ECO packing which is not including SATA cable kit and COM port cable, also with one utility CD and One Key Recovery CD in a box.</b></p>		

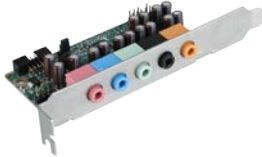

## 2.4 Optional Items

The following are optional components which may be separately purchased:

Item and Part Number	Image
Dual-port USB cable without bracket (P/N: 32000-070301-RS)	
Realtek ALC892 7.1 Channel HD Audio peripheral board (P/N: AC-KIT-892HD-R10)	
DC JACK 5.5*2.5+NUT to open end power cable,100MM (P/N: 32102-045100-100-RS)	
12V 36W AC/DC adapter (P/N: 63040-010036-111-RS)	

Chapter

3

# Connectors

---

### 3.1 Peripheral Interface Connectors

This chapter details all the jumpers and connectors.

#### 3.1.1 HYPER-BW Layout

The figures below show all the connectors and jumpers.

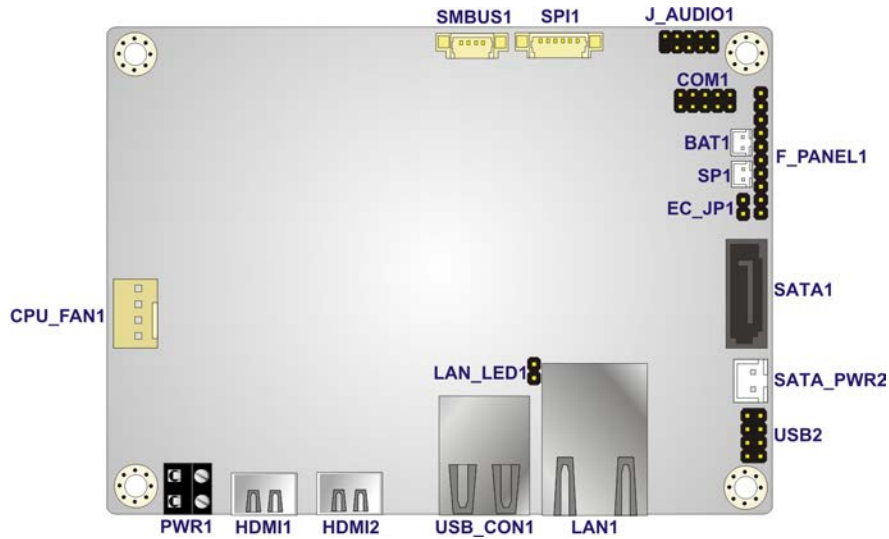

**Figure 3-1: Connector and Jumper Locations (Front)**

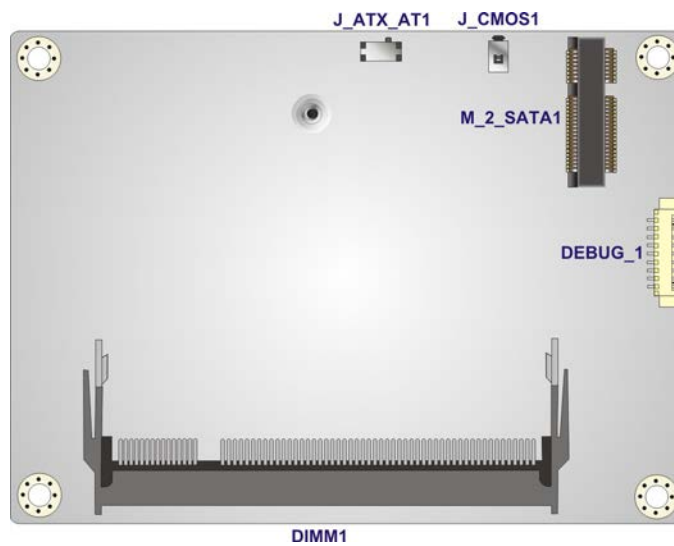

**Figure 3-2: Connector and Jumper Locations (Rear)**

## HYPER-BW

## 3.1.2 Peripheral Interface Connectors

The table below lists all the connectors on the board.

Connector	Type	Label
AT/ATX mode select switch	switch	J_ATX_AT1
Audio connector	10-pin header	J_AUDIO1
Battery connector	2-pin wafer	BAT1
BIOS FW connector	6-pin wafer	SPI1
Buzzer connector	2-pin wafer	SP1
Clear CMOS button	button	J_CMOS1
CPU fan connector	4-pin wafer	CPU_FAN1
DDR3L SO-DIMM slot	DDR3L SO-DIMM slot	DIMM1
Debug connector	9-pin wafer	DEBUG_1
EC FW connector	2-pin wafer	EC_JP1
Front panel connector	10-pin wafer	F_PANEL1
M.2 2242 (B key) socket	M.2 2242 (B key)	M_2_SATA1
RS-232 serial port connector	10-pin header	COM1
SATA 6Gb/s drive connector	7-pin SATA connector	SATA1
SATA power connector	2-pin wafer	SATA_PWR2
USB 2.0 connector	8-pin header	USB2

**Table 3-1: Peripheral Interface Connectors**

### 3.1.3 External Interface Panel Connectors

The table below lists the connectors on the external I/O panel.

Connector	Type	Label
HDMI Connectors	Mini HDMI Connector	HDMI1, HDMI2
LAN connector	RJ-45	LAN1
Power connector	2-pin connector	PWR1
USB connectors	USB 2.0 & USB 3.0	USB_CON1

**Table 3-2: Rear Panel Connectors**

## 3.2 Internal Peripheral Connectors

The section describes all of the connectors on the HYPER-BW.

### 3.2.1 AT/ATX Mode Select Switch

<b>CN Label:</b>	<b>J_ATX_AT1</b>
<b>CN Type:</b>	switch
<b>CN Location:</b>	See <b>Figure 3-3</b>
<b>CN Settings:</b>	See <b>Table 3-3</b>

The AT/ATX mode select switch specifies the systems power mode as AT or ATX. AT/ATX mode select switch settings are shown in **Table 3-3**.

Setting	Description
Short 1-2	ATX Mode (Default)
Short 2-3	AT Mode

**Table 3-3: AT/ATX Mode Select Switch Settings**

The location of the AT/ATX mode select switch is shown in **Figure 3-3** below.

HYPER-BW

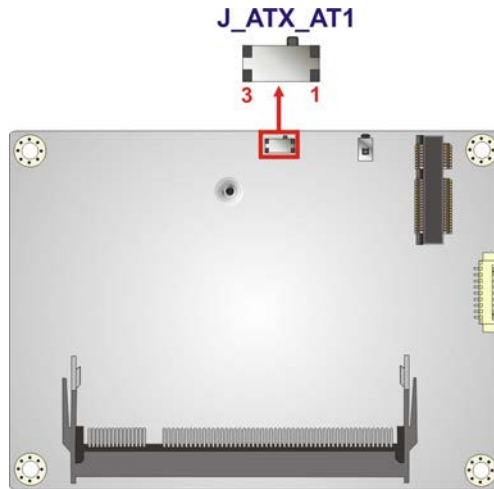

Figure 3-3: AT/ATX Mode Select Switch Location

3.2.2 Audio Connector

- CN Label:** J\_AUDIO1
- CN Type:** 10-pin header, p=2.00mm
- CN Location:** See Figure 3-4
- CN Pinouts:** See Table 3-4

This connector allows connection to an external audio kit.

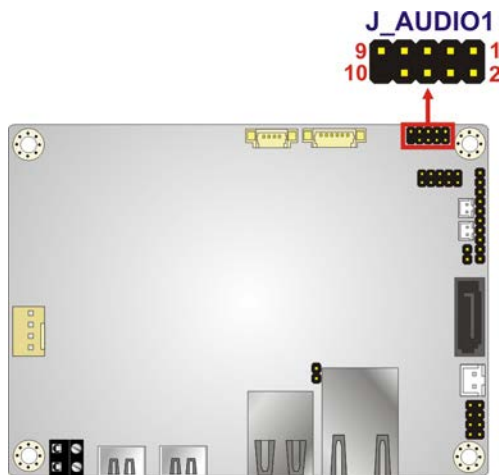

Figure 3-4: Audio Connector Location

Pin	Description	Pin	Description
1	HDA_SYNC	2	HDA_BCLK
3	HDA_SDO	4	HDA_SPKR
5	HDA_SDIO	6	HDA_RST#
7	+5V	8	AGND
9	+12V	10	AGND

**Table 3-4: Audio Connector Pinouts**

### 3.2.3 Battery Connector

- CN Label:**            **BAT1**
- CN Type:**            2-pin wafer, p=1.25mm
- CN Location:**        See **Figure 3-5**
- CN Pinouts:**         See **Table 3-5**

The battery connector is connected to the system battery. The battery provides power to the system clock to retain the time when power is turned off.

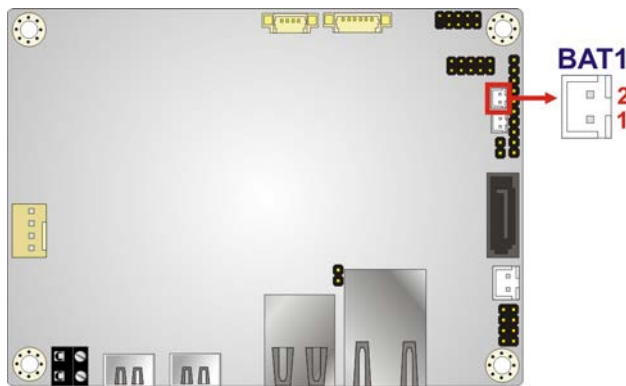

**Figure 3-5: Battery Connector Location**

Pin	Description	Pin	Description
1	VBATT	2	GND

**Table 3-5: Battery Connector Pinouts**

## HYPER-BW

### 3.2.4 BIOS FW Connector

- CN Label:** SPI1
- CN Type:** 6-pin wafer, p=1.25mm
- CN Location:** See **Figure 3-6**
- CN Pinouts:** See **Table 3-6**

The BIOS FW connector is used for programming the BIOS.

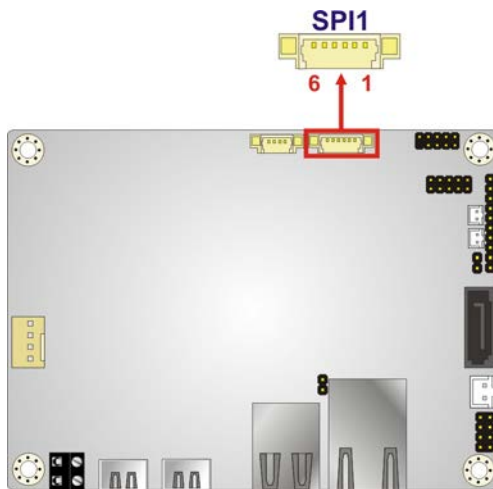

**Figure 3-6: BIOS FW Connector Location**

Pin	Description	Pin	Description
1	+SPI_VCC	2	SPI_CS0#_CN
3	SPI_SO0_CN	4	SPI_CLK0_CN
5	SPI_SI0_CN	6	GND

**Table 3-6: BIOS FW Connector Pinouts**

### 3.2.5 Buzzer Connector

- CN Label:** SP1
- CN Type:** 2-pin wafer, p=1.25mm
- CN Location:** See **Figure 3-7**
- CN Pinouts:** See **Table 3-7**



The buzzer connector is connected to the buzzer.

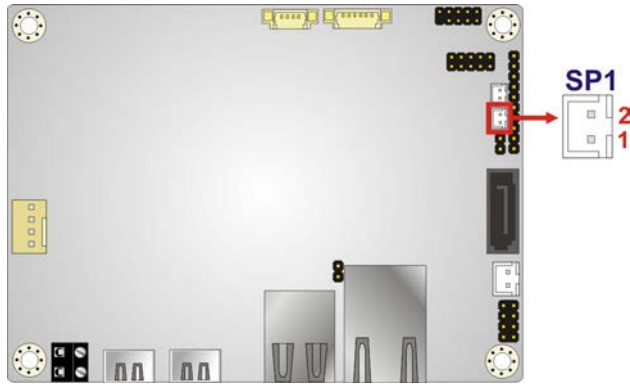

**Figure 3-7: Buzzer Connector Location**

Pin	Description	Pin	Description
1	5V	2	GND

**Table 3-7: Buzzer Connector Pinouts**

### 3.2.6 Clear CMOS Button

- CN Label:** J\_CMOS1
- CN Type:** button
- CN Location:** See **Figure 3-8**
- CN Settings:** See **Table 3-8**

If the HYPER-BW fails to boot due to improper BIOS settings, use the button to clear the CMOS data and reset the system BIOS information.

The clear CMOS button settings are shown in **Table 3-8**.

Setting	Description	
Open	Normal Operation	Default
Push	Clear CMOS Setup	

**Table 3-8: Clear CMOS Button Settings**

The location of the clear CMOS button is shown in **Figure 3-8**.

**HYPER-BW**

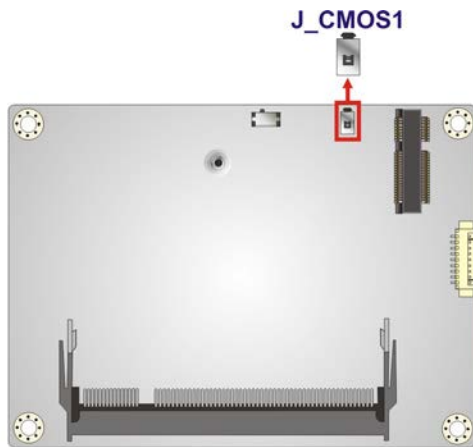
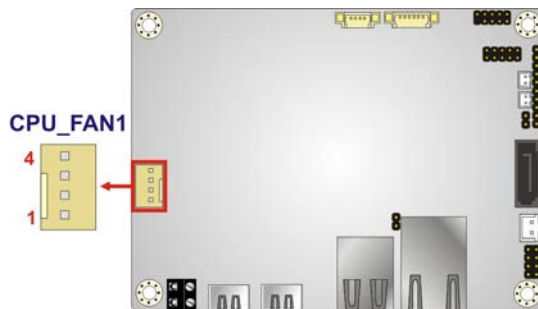

**Figure 3-8: Clear CMOS Button Location**

**3.2.7 CPU Fan Connector**

- CN Label:** CPU\_FAN1
- CN Type:** 4-pin wafer, p=2.54mm
- CN Location:** See **Figure 3-9**
- CN Pinouts:** See **Table 3-9**

The fan connector attaches to a cooling fan.



**Figure 3-9: CPU Fan Connector Location**

Pin	Description	Pin	Description
1	GND	2	+12V
3	FANIO1	4	FANOUT1

**Table 3-9: CPU Fan Connector Pinouts**

### 3.2.8 DDR3L SO-DIMM Slot

- CN Label:** DIMM1  
**CN Type:** DDR3L SO-DIMM slot  
**CN Location:** See **Figure 3-10**

The DDR3L SO-DIMM slot is for DDR3L SO-DIMM memory module.

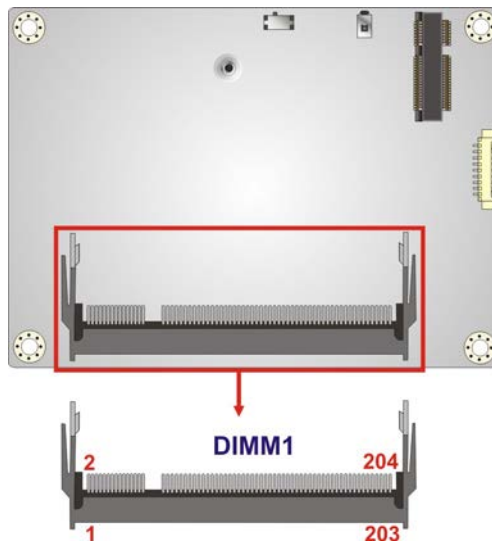

**Figure 3-10: DDR3L SO-DIMM Slot Location**

### 3.2.9 Debug Connector

- CN Label:** DEBUG\_1  
**CN Type:** 9-pin wafer, p=1.25mm  
**CN Location:** See **Figure 3-11**  
**CN Pinouts:** See **Table 3-10**

The debug connector is for system debug.

**HYPER-BW**

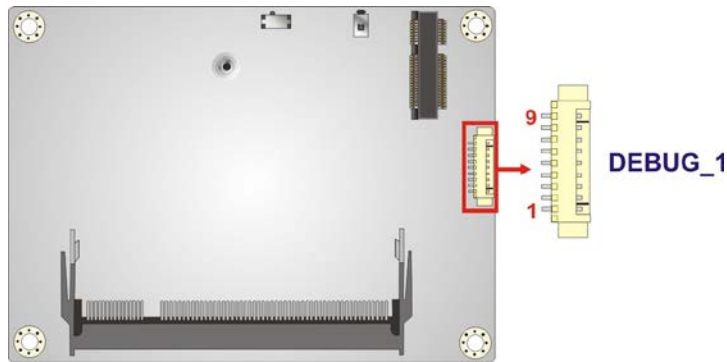

**Figure 3-11: Debug Port Connector Location**

PIN NO.	DESCRIPTION	PIN NO.	DESCRIPTION
1	BUF_PLT_RST#	2	TPM_CLK
3	GND	4	LPC_AD3
5	LPC_AD2	6	LPC_AD1
7	LPC_ADO	8	LPC_FRAME#
9	GND		

**Table 3-10: Debug Port Connector Pinouts**

**3.2.10 EC FW Connector**

- CN Label:** EC\_JP1
- CN Type:** 2-pin header, p=2.00mm
- CN Location:** See **Figure 3-12**
- CN Pinouts:** See **Table 3-11**

The EC FW connector is used for programming the EC.

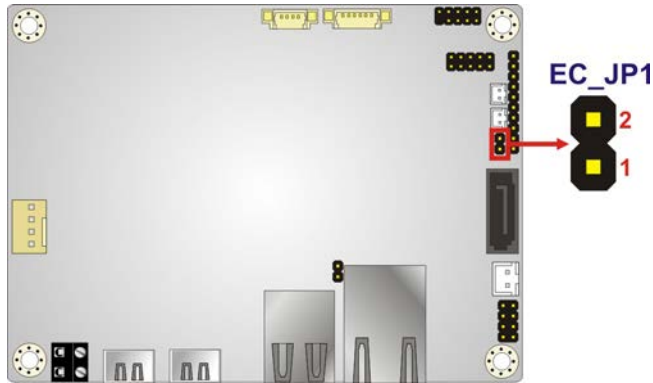

**Figure 3-12: EC FW Connector Location**

Pin	Description	Pin	Description
1	SMB_CLK_FW	2	SMB_DATA_FW

**Table 3-11: EC FW Connector Pinouts**

### 3.2.11 Front Panel Connector

- CN Label:** F\_PANEL1
- CN Type:** 10-pin wafer, p=2.00mm
- CN Location:** See Figure 3-13
- CN Pinouts:** See Table 3-12

The front panel connector connects to the indicator LEDs and buttons on the computer's front panel.

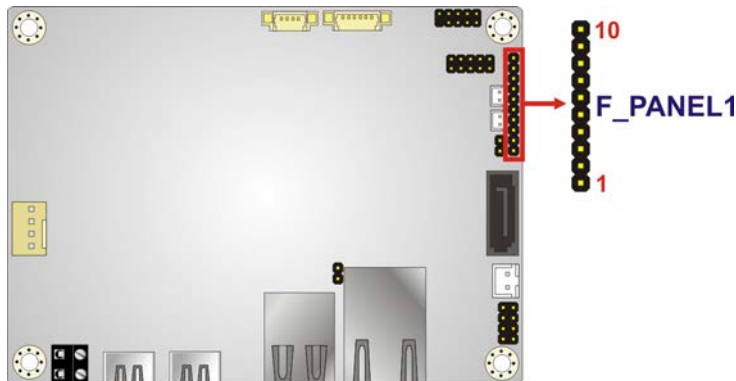

**Figure 3-13: Front Panel Connector Location**

**HYPER-BW**

Pin	Description	Pin	Description
1	NC	2	PWRBTN_SW
3	GND	4	HDDLED+
5	HDDLED-	6	PWRLED+
7	PWRLED+	8	GND
9	EXTRST-	10	GND

**Table 3-12: Front Panel Connector Pinouts**

**3.2.12 LAN LED Connector**

- CN Label:** LED\_LAN1
- CN Type:** 2-pin header, p=2 mm
- CN Location:** See **Figure 3-14**
- CN Pinouts:** See **Table 3-13**

The LAN LED connector is used to connect to the LAN LED indicators on the chassis to indicate users the link activities of the two LAN ports.

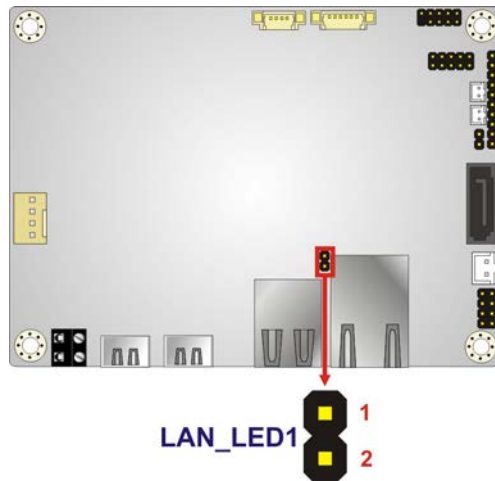

**Figure 3-14: LAN LED Connector Locations**

Pin	Description
1	+3.3VLAN
2	LAN1_LED_LINK#

**Table 3-13: LAN LED Connector Pinouts**

### 3.2.13 M.2 2242 (B key) Slot

<b>CN Label:</b>	<b>M_2_SATA1</b>
<b>CN Type:</b>	M.2 2242 (B key)
<b>CN Location:</b>	See <b>Figure 3-15</b>

The M.2 2242 (B key) slot is keyed in the B position and provides the mounting screw position for 2242-size M.2 module. The M.2 2242 (B key) slot supports the signals of SATA and PCIe.

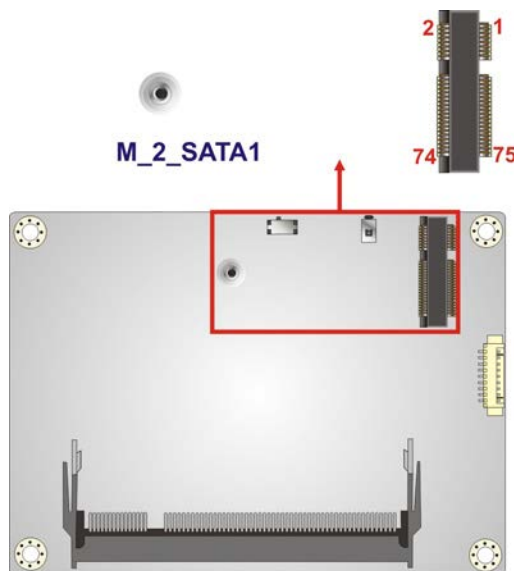

Figure 3-15: M.2 2242 (B key) Slot Location

### 3.2.14 RS-232 Serial Port Connector

<b>CN Label:</b>	<b>COM1</b>
<b>CN Type:</b>	10-pin header, p=2.00mm
<b>CN Location:</b>	See <b>Figure 3-16</b>
<b>CN Pinouts:</b>	See <b>Table 3-14</b>

The serial connector provides RS-232 connection.

**HYPER-BW**

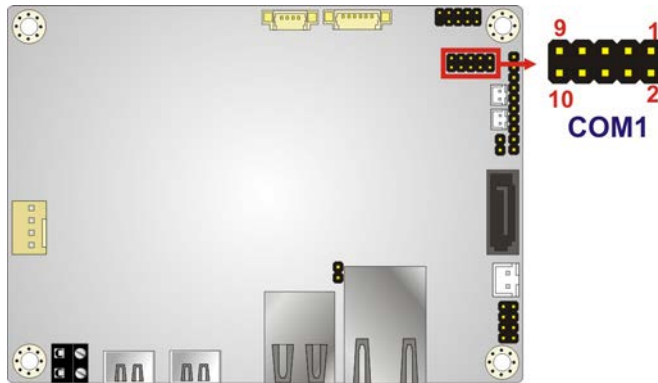

**Figure 3-16: RS-232 Serial Port Connector Location**

Pin	Description	Pin	Description
1	NDCD1	6	NDSR1
2	NRXD1	7	NRTS1
3	NTXD1	8	NCTS1
4	NDTR1	9	NR11
5	GND	10	GND

**Table 3-14: RS-232 Serial Port Connector Pinouts**

**3.2.15 SATA 6Gb/s Drive Connector**

- CN Label:** SATA1
- CN Type:** 7-pin SATA connector
- CN Location:** See **Figure 3-17**

The SATA 6Gb/s drive connector is connected to a SATA 6Gb/s drive. The SATA 3Gb/s drive transfers data at speeds as high as 6Gb/s.



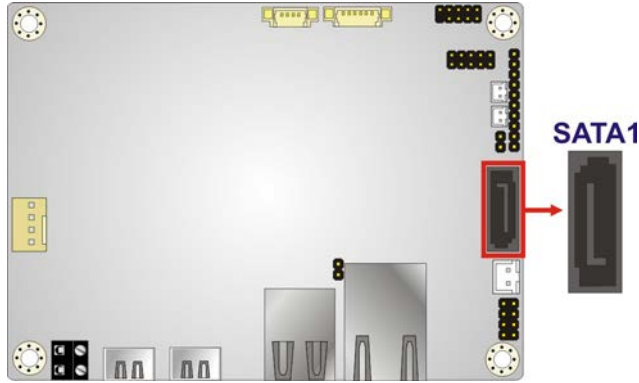
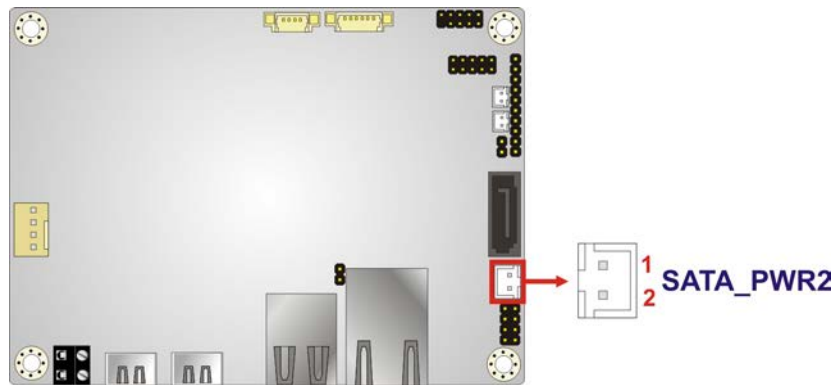

**Figure 3-17: SATA 6Gb/s Drive Connector Location**

**3.2.16 SATA Power Connector**

- CN Label:** SATA\_PWR2
- CN Type:** 2-pin wafer, p=2.00mm
- CN Location:** See **Figure 3-18**
- CN Pinouts:** See **Table 3-15**

The SATA power connector provides +5V power output to the SATA connector.



**Figure 3-18: SATA Power Connector Location**

Pin	Description
1	+5V
2	GND

**Table 3-15: SATA Power Connector Pinouts**

## HYPER-BW

### 3.2.17 SMBus Connector

- CN Label:** SMBUS1
- CN Type:** 4-pin wafer, p=1.25mm
- CN Location:** See **Figure 3-19**
- CN Pinouts:** See **Table 3-16**

The SMBus (System Management Bus) connector provides low-speed system management communications.

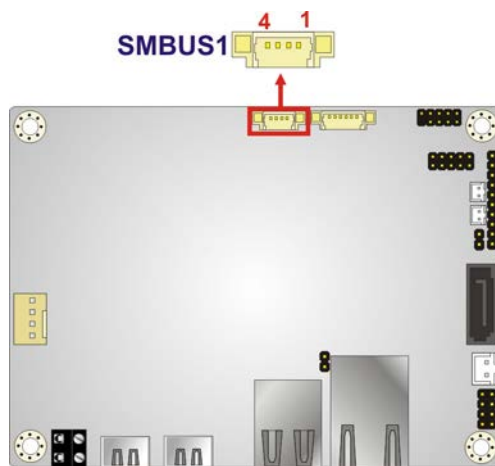

**Figure 3-19: SMBus Connector Location**

Pin	Description
1	GND
2	SMB_DATA
3	SMB_CLK
4	+V5S

**Table 3-16: SMBus Connector Pinouts**

### 3.2.18 USB Connector

- CN Label:** USB2
- CN Type:** 8-pin header, p=2.00mm
- CN Location:** See **Figure 3-20**

**CN Pinouts:** See **Table 3-17**

The USB connector provides two USB 2.0 ports by dual-port USB cable.

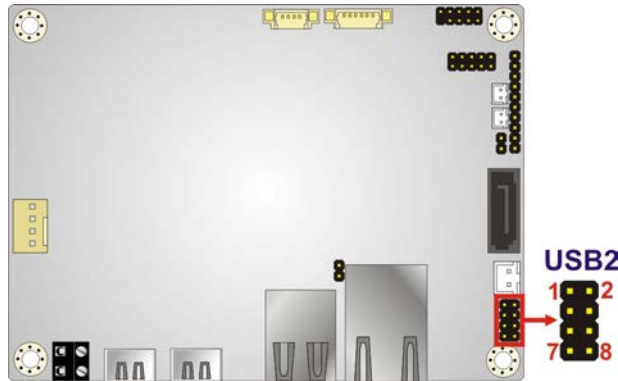

**Figure 3-20: USB Connector Location**

Pin	Description	Pin	Description
1	+5V	2	GND
3	USB20_C_N2	4	USB20_C_P3
5	USB20_C_P2	6	USB20_C_N3
7	GND	8	+5V

**Table 3-17: USB Connector Pinouts**

### 3.3 External Peripheral Interface Connector Panel

**Figure 3-21** shows the HYPER-BW external peripheral interface connector (EPIC) panel.

The EPIC panel consists of the following:

- 1 x LAN connector
- 1 x Power connector
- 1 x USB 2.0 & USB 3.0 connector
- 2x HDMI connectors

**HYPER-BW**

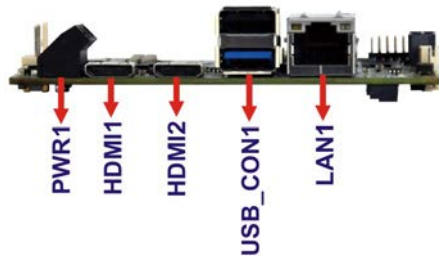

**Figure 3-21: External Peripheral Interface Connector**

**3.3.1 HDMI Connectors**

- CN Label:** HDMI1, HDMI2
- CN Type:** Micro HDMI connector
- CN Location:** See **Figure 3-21**
- CN Pinouts:** See **Table 3-18**

The HDMI connector connects to a display device with HDMI interface.

Pin	Description	Pin	Description
1	GND	2	HDMI_DATA2-1_L
3	HDMI_DATA2#-1_L	4	GND
5	HDMI_DATA1-1_L	6	HDMI_DATA1#-1_L
7	GND	8	HDMI_DATA0-1_L
9	HDMI_DATA0#-1_L	10	GND
11	HDMI_CLK-1_L	12	HDMI_CLK#-1_L
13	DDC/CEC GND	14	CEC
15	HDMI1_SCL	16	HDMI1_SDA
17	NC	18	HDMI1_PWR
19	HDMI1_HPD		

**Table 3-18: HDMI Connector Pinouts**

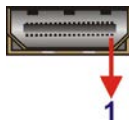
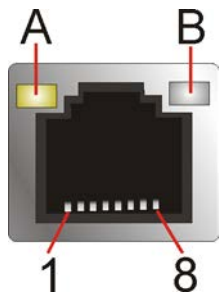

**Figure 3-22: HDMI Connector**

### 3.3.2 LAN Connector

- CN Label:** LAN1
- CN Type:** RJ-45
- CN Location:** See **Figure 3-21**
- CN Pinouts:** See **Figure 3-23** and **Table 3-19**

The LAN connector connects to a local network.



**Figure 3-23: LAN Connector**

Pin	Description	Pin	Description
1	MDIA3-	5	MDIA2+
2	MDIA3+	6	MDIA1+
3	MDIA1-	7	MDIA0-
4	MDIA2-	8	MDIA0+

**Table 3-19: LAN Pinouts**

LED	Description	LED	Description
A	on: linked blinking: data is being sent/received	B	off: 10 Mb/s green: 100 Mb/s orange: 1000 Mb/s

**Table 3-20: Connector LEDs**

### 3.3.3 Power Connector

- CN Label:** PWR1
- CN Type:** 2-pin connector
- CN Location:** See **Figure 3-21**

## HYPER-BW

**CN Pinouts:** See **Table 3-21**

The power connector supports 12V DC power input.

Pin	Description	Pin	Description
1	GND	2	+12 V

**Table 3-21: Power Connector Pinouts**



**Figure 3-24: Power Connector**

### 3.3.4 USB Connectors

**CN Label:** **USB\_CON1**

**CN Type:** USB 2.0 & USB 3.0 ports

**CN Location:** See **Figure 3-21**

**CN Pinouts:** See **Table 3-22**

The HYPER-BW has one external USB 2.0 port and one external USB 3.0 port. The USB connector can be connected to a USB device. The pinouts of USB 2.0 port & USB 3.0 connectors are shown below.

Pin	Description	Pin	Description
1	+5V	2	USB2P0_DM0_L
3	USB2P0_DP0_L	4	GND
5	USB3P0_RXDN0_C	6	USB3P0_RXDP0_C
7	GND	8	USB3P0_TXDN0_C
9	USB3P0_TXDP0_C	10	+5V
11	USB2P0_DM1_L	12	USB2P0_DP1_L
13	GND		

**Table 3-22: USB 2.0 & USB 3.0 Port Pinouts**

Chapter

**4**

# Installation

---

## HYPER-BW

### 4.1 Anti-static Precautions

---



#### WARNING:

Failure to take ESD precautions during the installation of the HYPER-BW may result in permanent damage to the HYPER-BW and severe injury to the user.

---

Electrostatic discharge (ESD) can cause serious damage to electronic components, including the HYPER-BW. Dry climates are especially susceptible to ESD. It is therefore critical that whenever the HYPER-BW or any other electrical component is handled, the following anti-static precautions are strictly adhered to.

- **Wear an anti-static wristband:** Wearing a simple anti-static wristband can help to prevent ESD from damaging the board.
- **Self-grounding:** Before handling the board, touch any grounded conducting material. During the time the board is handled, frequently touch any conducting materials that are connected to the ground.
- **Use an anti-static pad:** When configuring the HYPER-BW, place it on an anti-static pad. This reduces the possibility of ESD damaging the HYPER-BW.
- **Only handle the edges of the PCB:** When handling the PCB, hold the PCB by the edges.

### 4.2 Installation Considerations

---



#### NOTE:

The following installation notices and installation considerations should be read and understood before installation. All installation notices must be strictly adhered to. Failing to adhere to these precautions may lead to severe damage and injury to the person performing the installation.

---



**WARNING:**

The installation instructions described in this manual should be carefully followed in order to prevent damage to the HYPER-BW, HYPER-BW components and injury to the user.

Before and during the installation please **DO** the following:

- Read the user manual:
  - The user manual provides a complete description of the HYPER-BW installation instructions and configuration options.
- Wear an electrostatic discharge cuff (ESD):
  - Electronic components are easily damaged by ESD. Wearing an ESD cuff removes ESD from the body and helps prevent ESD damage.
- Place the HYPER-BW on an antistatic pad:
  - When installing or configuring the motherboard, place it on an antistatic pad. This helps to prevent potential ESD damage.
- Turn all power to the HYPER-BW off:
  - When working with the HYPER-BW, make sure that it is disconnected from all power supplies and that no electricity is being fed into the system.

Before and during the installation of the HYPER-BW **DO NOT:**

- Remove any of the stickers on the PCB board. These stickers are required for warranty validation.
- Use the product before verifying all the cables and power connectors are properly connected.
- Allow screws to come in contact with the PCB circuit, connector pins, or its components.

### 4.3 SO-DIMM Installation

**WARNING:**

Using incorrectly specified SO-DIMM may cause permanently damage the HYPER-BW. Please make sure the purchased SO-DIMM complies with the memory specifications of the HYPER-BW. SO-DIMM specifications compliant with the HYPER-BW are listed in the specification table of Chapter 1.

To install an SO-DIMM, please follow the steps below and refer to Figure 4-1.

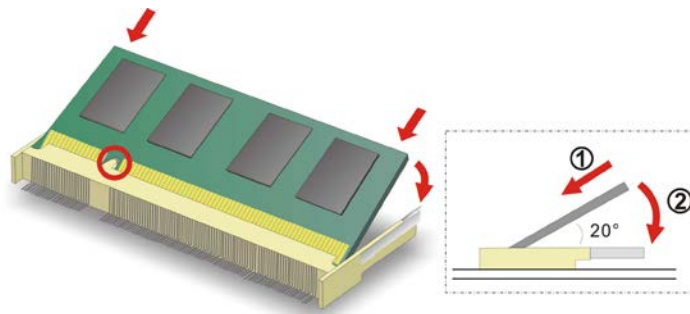

**Figure 4-1: SO-DIMM Installation**

- Step 1:** Locate the **SO-DIMM socket**. Place the board on an anti-static mat.
- Step 2:** Align the **SO-DIMM with the socket**. Align the notch on the memory with the notch on the memory socket.
- Step 3:** Insert the **SO-DIMM**. Push the memory in at a 20° angle (**Figure 4-1**).
- Step 4:** Seat the **SO-DIMM**. Gently push downwards and the arms clip into place (**Figure 4-1**).

## 4.4 M.2 Module Installation

To install an M.2 module, please follow the steps below.

- Step 1:** Locate the M.2 module slot. See **Chapter 3**.
- Step 2:** Line up the notch on the card with the notch on the slot. Slide the PCIe Mini card into the socket at an angle of about 20° (**Figure 4-2**).

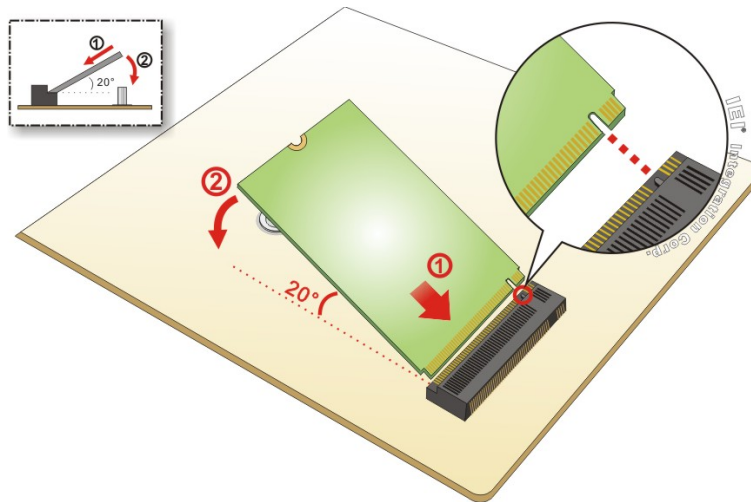

**Figure 4-2: Inserting the M.2 Module into the Slot at an Angle**

- Step 3:** Secure the M.2 module with the retention screw (**Figure 4-3**).

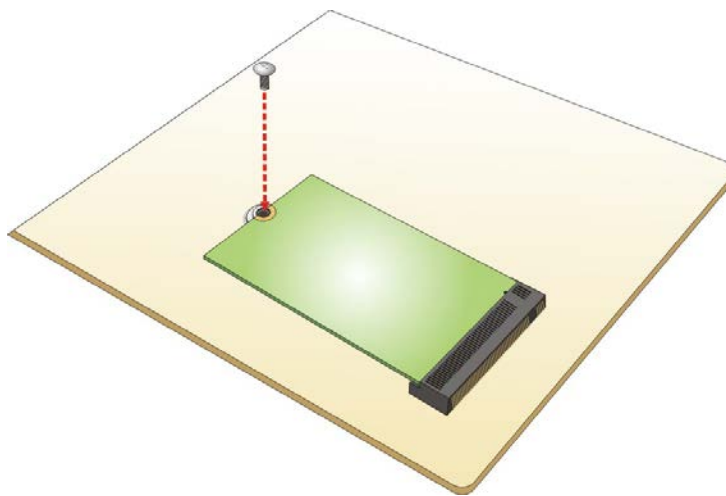

**Figure 4-3: Securing the M.2 Module**

## HYPER-BW

### 4.5 Internal Peripheral Device Connections

This section outlines the installation of peripheral devices to the on-board connectors

#### 4.5.1 SATA Drive Connection

The HYPER-BW is shipped with a SATA drive cable. To connect the SATA drive to the connector, please follow the steps below.

**Step 1:** Locate the SATA connector and the SATA power connector. The locations of the connectors are shown in Chapter 3.

**Step 2:** **Insert the cable connector.** Insert the cable connector into the on-board SATA drive connector and the SATA power connector. See **Figure 4-4**.

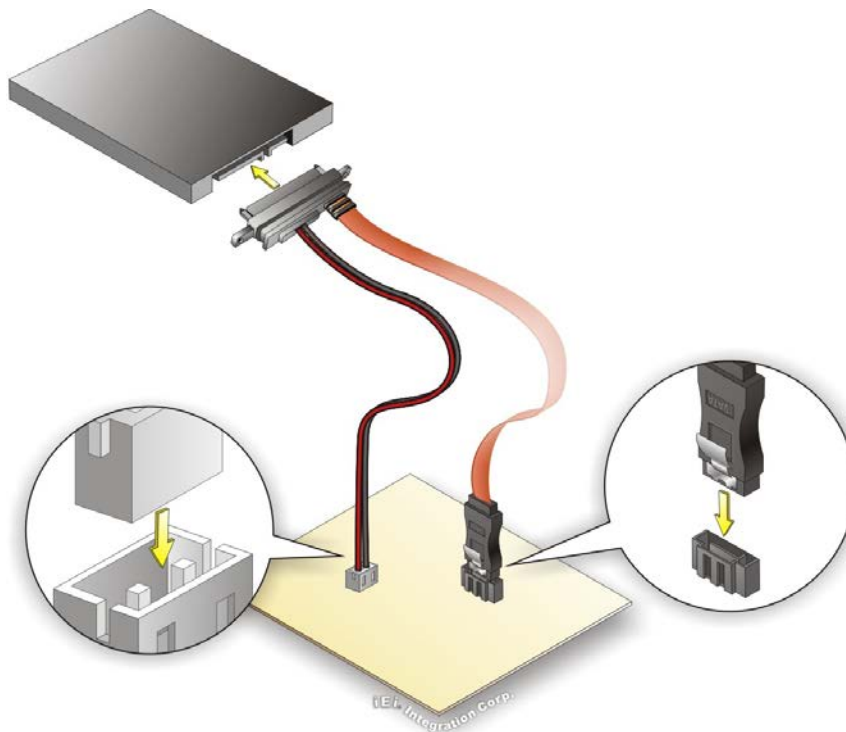

**Figure 4-4: SATA Drive Cable Connection**

**Step 3:** **Connect the cable to the SATA disk.** Connect the connector on the other end of the cable to the connector at the back of the SATA drive. See **Figure 4-4**.

**Step 4:** To remove the SATA cable from the SATA connector, press the clip on the connector at the end of the cable.

#### 4.5.2 Single RS-232 Cable

The single RS-232 cable consists of one serial port connector attached to a serial communications cable that is then attached to a D-sub 9 male connector. To install the single RS-232 cable, please follow the steps below.

**Step 1: Locate the connector.** The location of the RS-232 connector is shown in Chapter 3.

**Step 2: Insert the cable connector.** Insert the connector into the serial port box header. See Figure 4-5. A key on the front of the cable connectors ensures the connector can only be installed in one direction.

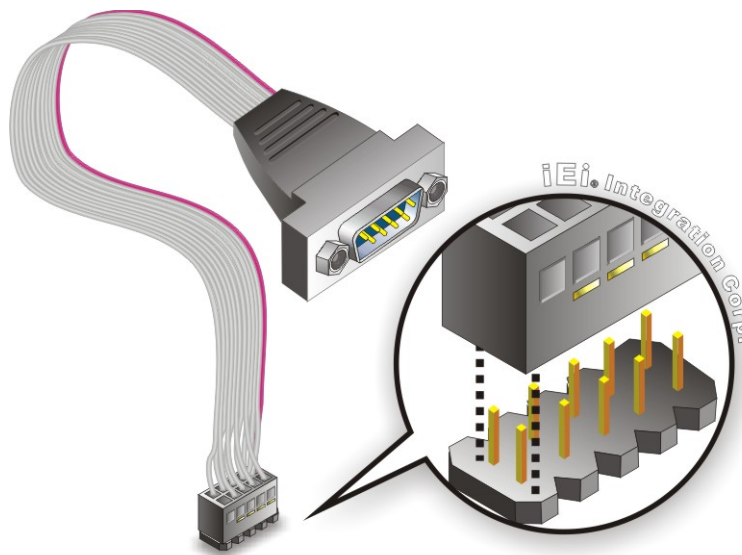

**Figure 4-5: Single RS-232 Cable Installation**

**Step 3: Secure the bracket.** The single RS-232 connector has two retention screws that must be secured to a chassis or bracket.

**Step 4: Connect the serial device.** Once the single RS-232 connector is connected to a chassis or bracket, a serial communications device can be connected to the system.

## HYPER-BW

## 4.6 Power Cables Connection

To connect the power cables to the connector, please follow the steps below.

**Step 1:** **Locate the connector.** The location of the power connector is shown in Chapter 3.

**Step 2:** **Insert the power cables.** Insert the power cables into the power connector. See Figure 4-4.

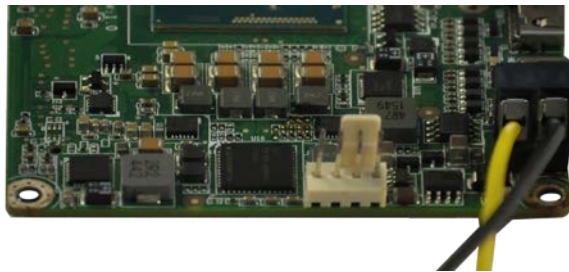

Figure 4-6: Power Cables Connection

**Step 3:** **Secure the power cables.** Secure the power cables by tightening the two retention screws on the power connector.

**NOTE:**

Please connect the power cables properly before installing the heat sink.

When installing the power cables, please avoid the power cables to drop out and touch the components on the motherboard.

When the power cables properly connected, then use the intermediate poles to install the heat sink.

---

## 4.7 Heat Sink Enclosure



**WARNING:**

Never run the HYPER-BW without the heat sink secured to the board. The heat sink ensures the system remains cool and does not need addition heat sinks to cool the system.

The HYPER-BW is shipped with a specific heat sink module and four retention screws, four hex head studs and four intermediate poles. To install the heat sink module, see **Figure 4-6** below.

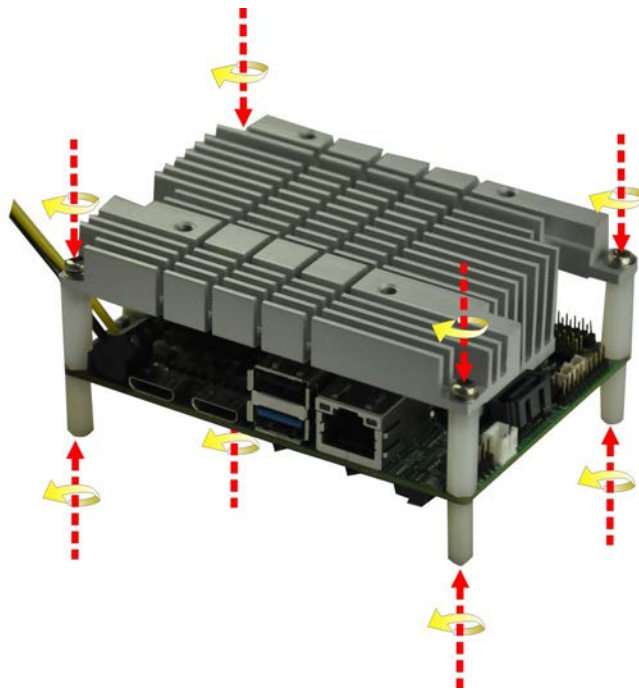

**Figure 4-7: Heat Sink Retention Screws**

## HYPER-BW

### 4.8 Software Installation

#### 4.8.1 Available Drivers

All the drivers for the HYPER-BW are available on IEI Resource Download Center (<https://download.ieiworld.com>). Type HYPER-BW and press Enter to find all the relevant software, utilities, and documentation.

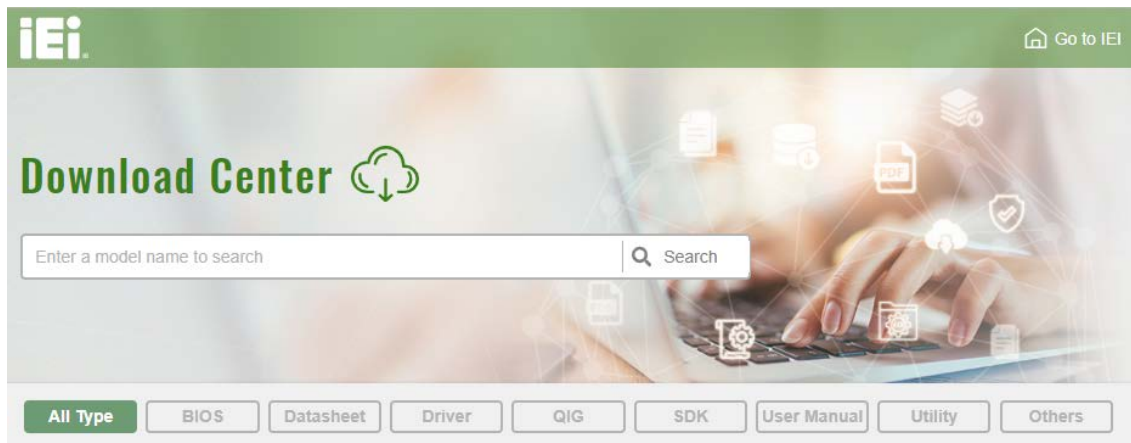
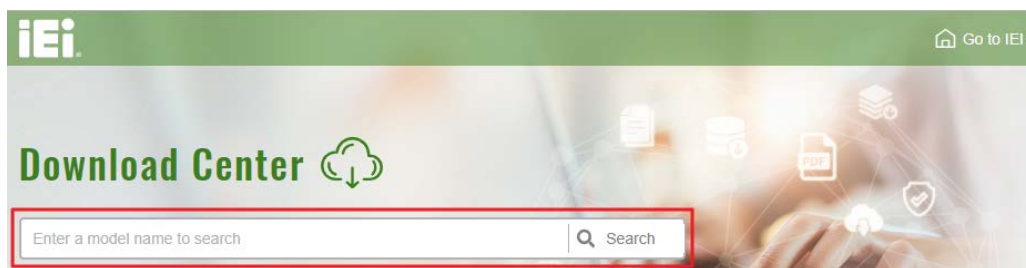

Figure 4-8: IEI Resource Download Center

#### 4.8.2 Driver Download

To download drivers from IEI Resource Download Center, follow the steps below.

**Step 1:** Go to <https://download.ieiworld.com>. Type HYPER-BW and press Enter.



**Step 2:** All product-related software, utilities, and documentation will be listed. You can choose **Driver** to filter the result.





All Type BIOS Datasheet **Driver** QIG SDK User Manual Utility Others

**WAFER-BT-i1** Product Info ▶

Embedded Computer ▶ Single Board Computer ▶ Embedded Board  
 3.5" SBC with Intel® 22nm Atom™/Celeron® on-board SoC

**Driver**

File Name	Published	Version	File Checksum
 <a href="#">7B000-001033-RS V2.3.iso (2.23 GB)</a> 	2017/10/03	2.30	3B2DB1F792779A93A8F50DDBC3943E30

**Step 3:** Click the driver file name on the page and you will be prompted with the following window. You can download the entire ISO file (❶), or click the small arrow to find an individual driver and click the file name to download (❷).

7B000-001168-RS\_V1.4.iso

❶ [Click here to download entire ISO file. \(2.99 GB\)](#)

\* Download individual file \*

❷ Docs

- 1.Chipset
- 10.1.1.12.zip (2.7 MB)
- 2.VGA
- 3.Audio
- 4.Lan
- 5.USB 3.0
- 6.Serial IO
- 7.TXE
- 8.Manual



**NOTE:**

To install software from the downloaded ISO image file in Windows 8, 8.1 or 10, double-click the ISO file to mount it as a virtual drive to view its content. On Windows 7 system, an additional tool (such as Virtual CD-ROM Control Panel from Microsoft) is needed to mount the file.

Chapter

5

# BIOS

---

## 5.1 Introduction

The BIOS is programmed onto the BIOS chip. The BIOS setup program allows changes to certain system settings. This chapter outlines the options that can be changed.



### NOTE:

Some of the BIOS options may vary throughout the life cycle of the product and are subject to change without prior notice.

---

### 5.1.1 Starting Setup

The UEFI BIOS is activated when the computer is turned on. The setup program can be activated in one of two ways.

1. Press the **DELETE** or **F2** key as soon as the system is turned on or
2. Press the **DELETE** or **F2** key when the “**Press Del to enter SETUP**” message appears on the screen.

If the message disappears before the **DELETE** or **F2** key is pressed, restart the computer and try again.

### 5.1.2 Using Setup

Use the arrow keys to highlight items, press **ENTER** to select, use the PageUp and PageDown keys to change entries, press **F1** for help and press **ESC** to quit. Navigation keys are shown in.

Key	Function
Up arrow	Move to previous item
Down arrow	Move to next item
Left arrow	Move to the item on the left hand side
Right arrow	Move to the item on the right hand side
+	Increase the numeric value or make changes

## HYPER-BW

Key	Function
-	Decrease the numeric value or make changes
F1 key	General help, only for Status Page Setup Menu and Option Page Setup Menu
F2 key	Load previous values.
F3 key	Load optimized defaults
F4 key	Save changes and Exit BIOS
Esc key	Main Menu – Quit and not save changes into CMOS Status Page Setup Menu and Option Page Setup Menu -- Exit current page and return to Main Menu

Table 5-1: BIOS Navigation Keys

### 5.1.3 Getting Help

When **F1** is pressed a small help window describing the appropriate keys to use and the possible selections for the highlighted item appears. To exit the Help Window press **Esc** or the **F1** key again.

### 5.1.4 Unable to Reboot after Configuration Changes

If the computer cannot boot after changes to the system configuration is made, CMOS defaults. Use the jumper described in Chapter 3.

### 5.1.5 BIOS Menu Bar

The **menu bar** on top of the BIOS screen has the following main items:

- Main – Changes the basic system configuration.
- Advanced – Changes the advanced system settings.
- Chipset – Changes the chipset settings.
- Boot – Changes the system boot configuration.
- Security – Sets User and Supervisor Passwords.
- Save & Exit – Selects exit options and loads default settings

The following sections completely describe the configuration options found in the menu items at the top of the BIOS screen and listed above.

## 5.2 Main

The **Main** BIOS menu (**BIOS Menu 1**) appears when the **BIOS Setup** program is entered. The **Main** menu gives an overview of the basic system information.

Aptio Setup Utility - Copyright (C) 2016 American Megatrends, Inc.		
Main	Advanced	Chipset Security Boot Save & Exit
BIOS Information		Set the Date. Use Tab to switch between Data elements.
BIOS Vendor	American Megatrends	
Core Version	5.11	
Compliancy	UEFI 2.4; PI 1.3	
Project Version	SAE4AR11.bin x64	
Build Date and Time	06/03/2016 15:01:53	
-----		
iWDD Vendor	iEi	
iWDD Version	SAE4ER11.bin	
Access Level	Administrator	
CPU Configuration		
Microcode Patch	408	
Memory Information		
Total Memory	2048 MB(LPDDR3)	
TXE Information		
Sec RC Version	00.05.00.00	
TXE FW Version	02.00.02.2092	
System Date	[Wed 06/22/2016]	
System Time	[08:51:27]	
Version 2.17.1249. Copyright (C) 2016 American Megatrends, Inc.		

### BIOS Menu 1: Main

The Main menu lists the following system details:

- BIOS Information
- iWDD Information
- CPU Configuration
- Memory Information
- TXE Information

## HYPER-BW

The System Overview field also has two user configurable fields:

→ **System Date [xx/xx/xx]**

Use the **System Date** option to set the system date. Manually enter the day, month and year.

→ **System Time [xx:xx:xx]**

Use the **System Time** option to set the system time. Manually enter the hours, minutes and seconds.

## 5.3 Advanced

Use the **Advanced** menu (**BIOS Menu 2**) to configure the CPU and peripheral devices through the following sub-menus:



### WARNING!

Setting the wrong values in the sections below may cause the system to malfunction. Make sure that the settings made are compatible with the hardware.

```

Aptio Setup Utility - Copyright (C) 2016 American Megatrends, Inc.
Main  Advanced  Chipset  Security  Boot  Save & Exit
-----
> ACPI Settings
> IT8528 Super IO Configuration
> iWDD H/W Monitor
> RTC Wake Settings
> Serial Port Console Redirection
> iEi Feature
> CPU Configuration
> SATA Configuration
> USB Configuration

System ACPI Parameters.
-----
<=>: Select Screen
↑ ↓: Select Item
Enter>Select
F1  General Help
F2  Previous Values
F3  Optimized Defaults
F4  Save
ESC Exit

Version 2.17.1249. Copyright (C) 2016 American Megatrends, Inc.
    
```

**BIOS Menu 2: Advanced**

### 5.3.1 ACPI Settings

The **ACPI Settings** menu (**BIOS Menu 3**) configures the Advanced Configuration and Power Interface (ACPI) options.

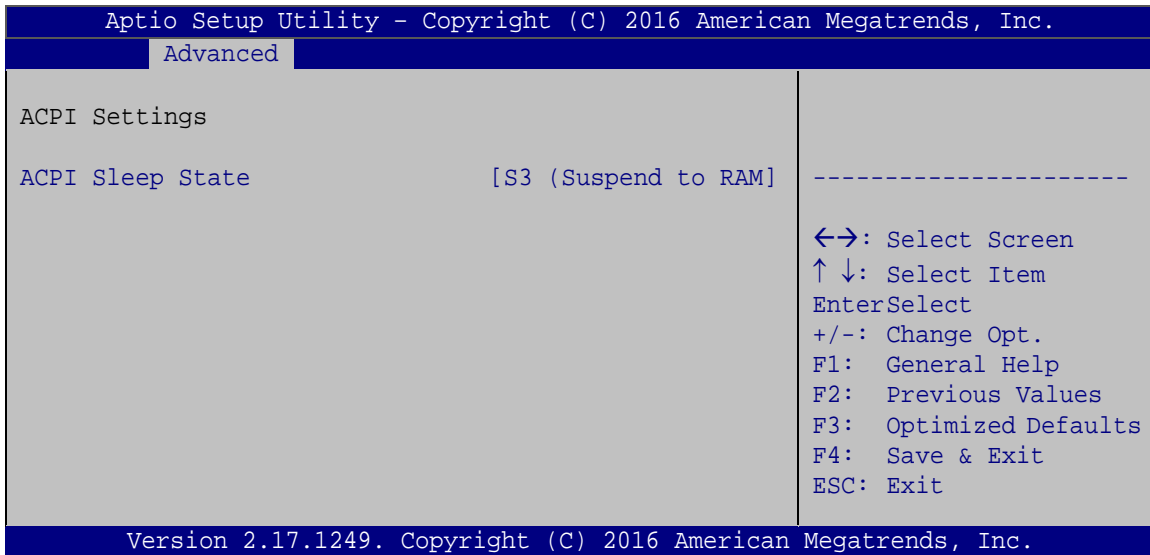

#### BIOS Menu 3: ACPI Configuration

##### → **ACPI Sleep State [S3 only (Suspend to RAM)]**

The fields in **ACPI Sleep State** option cannot be changed.

- **S3 (Suspend to DEFAULT RAM)** The caches are flushed and the CPU is powered off. Power to the RAM is maintained. The computer returns slower to a working state, but more power is saved.

## HYPER-BW

### 5.3.2 IT8528 Super IO Configuration

Use the **IT8528 Super IO Configuration** menu (**BIOS Menu 4**) to set or change the configurations for the serial ports.

```

Aptio Setup Utility - Copyright (C) 2016 American Megatrends, Inc.
  Advanced
IT8528 Super IO Configuration                               Set Parameters of Serial
                                                           Port 1 (COMA)
Super IO Chip                                             IT8528
> Serial Port 1 Configuration
                                                           -----
                                                           ←→: Select Screen
                                                           ↑ ↓: Select Item
                                                           EnterSelect
                                                           F1  General Help
                                                           F2  Previous Values
                                                           F3  Optimized
                                                           Defaults
                                                           F4  Save
                                                           ESC  Exit
Version 2.17.1249. Copyright (C) 2016 American Megatrends, Inc.
    
```

**BIOS Menu 4: Super IO Configuration**

#### 5.3.2.1 Serial Port 1 Configuration

Use the **Serial Port 1 Configuration** menu (**BIOS Menu 5**) to configure the serial port 1.

```

Aptio Setup Utility - Copyright (C) 2016 American Megatrends, Inc.
  Advanced
F81216 Serial Port 1 Configuration                       Enable or Disable Serial
                                                           Port (COM)
Serial Port                                             [Enabled]
Device Settings                                       IO=3F8h; IRQ=4
Change Settings                                       [Auto]
                                                           -----
                                                           ←→: Select Screen
                                                           ↑ ↓: Select Item
                                                           EnterSelect
                                                           F1  General Help
                                                           F2  Previous Values
                                                           F3  Optimized
                                                           Defaults
                                                           F4  Save
                                                           ESC  Exit
Version 2.17.1249. Copyright (C) 2016 American Megatrends, Inc.
    
```

**BIOS Menu 5: Serial Port 1 Configuration Menu**



➔ **Serial Port [Enabled]**

Use the **Serial Port** option to enable or disable the serial port.

- ➔ **Disabled**                      Disable the serial port
- ➔ **Enabled**      **DEFAULT**      Enable the serial port

➔ **Change Settings [Auto]**

Use the **Change Settings** option to change the serial port IO port address and interrupt address.

- ➔ **Auto**                      **DEFAULT**              The serial port IO port address and interrupt address are automatically detected.
- ➔ **IO=3F8h; IRQ=4**                      Serial Port I/O port address is 3F8h and the interrupt address is IRQ4
- ➔ **IO=3F8h; IRQ=3, 4,5,6,7,9,10,11,12**                      Serial Port I/O port address is 3F8h and the interrupt address is IRQ3,4,5,6,7,9,10,11,12
- ➔ **IO=2F8h; IRQ=3, 4,5,6,7,9,10,11,12**                      Serial Port I/O port address is 2F8h and the interrupt address is IRQ3,4,5,6,7,9,10,11,12
- ➔ **IO=3E8h; IRQ=3, 4,5,6,7,9,10,11,12**                      Serial Port I/O port address is 3E8h and the interrupt address is IRQ3,4,5,6,7,9,10,11,12
- ➔ **IO=2E8h; IRQ=3, 4,5,6,7,9,10,11,12**                      Serial Port I/O port address is 2E8h and the interrupt address is IRQ3,4,5,6,7,9,10,11,12

## HYPER-BW

### 5.3.3 iWDD H/W Monitor

The iWDD H/W Monitor menu (**BIOS Menu 6**) contains the fan configuration submenus and displays operating temperature, fan speeds and system voltages.

```

Aptio Setup Utility - Copyright (C) 2016 American Megatrends, Inc.
Advanced
PC Health Status
> Smart Fan Function
CPU temperature           :+37 C
Fan1 Speed                :N/A
Enable or Disable Smart Fan
-----
<->: Select Screen
↑ ↓: Select Item
EnterSelect
+ - Change Opt.
F1  General Help
F2  Previous Values
F3  Optimized Defaults
F4  Save & Exit
ESC Exit
Version 2.17.1249. Copyright (C) 2016 American Megatrends, Inc.
    
```

#### BIOS Menu 6: Hardware Monitor

##### → PC Health Status

The following system parameters and values are shown. The system parameters that are monitored are:

- System Temperatures:
  - CPU Temperature
- Fan Speed:
  - Fan1 Speed

### 5.3.3.1 Smart Fan Mode Configuration

Use the **Smart Fan Mode Configuration submenu (BIOS Menu 7)** to configure fan temperature and speed settings.

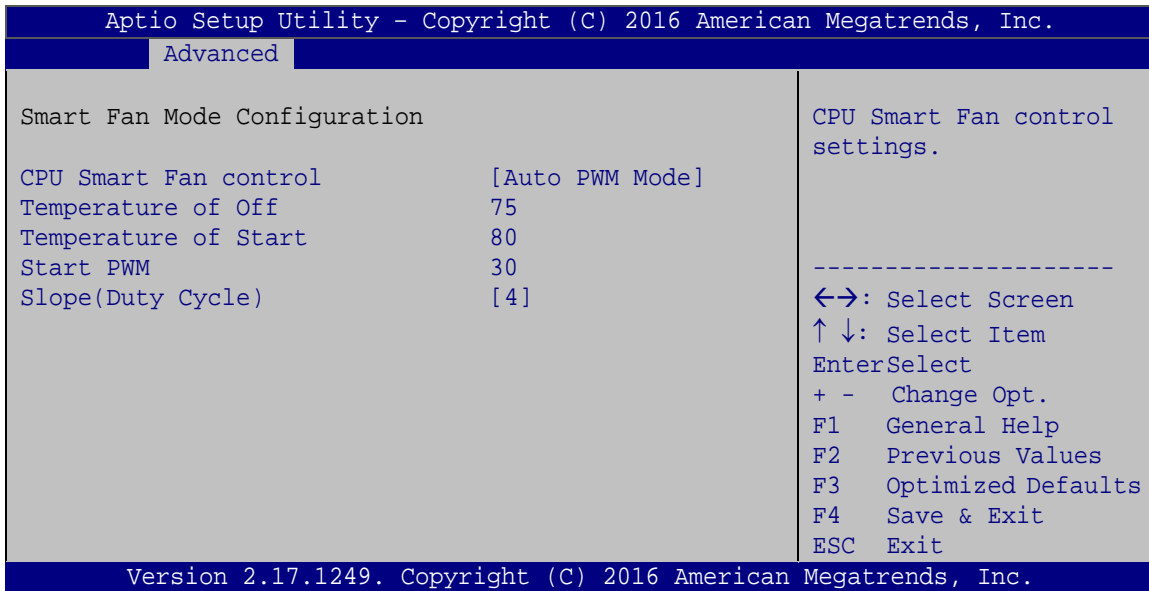

#### BIOS Menu 7: Smart Fan Mode Configuration

##### → CPU Smart Fan control [Auto PWM Mode]

Use the **CPU Smart Fan control** BIOS option to configure the CPU Smart Fan.

- **Full Mode** Fan is on all the time
- **Manual PWM Mode** The fan spins at the speed set in the manual PWM setting
- **Auto PWM Mode** **DEFAULT** The fan adjusts its speed using these settings:
  - Temperature of Off
  - Temperature of Start
  - Start PWM
  - Slope (Duty Cycle)

## HYPER-BW

### → Temperature of Off [75]

---



#### **WARNING:**

Setting this value too high may cause the fan to speed up only when the CPU is at a very high temperature and therefore cause the system to be damaged.

---

The **Temperature of Off** option can only be set if the **CPU Smart Fan control** option is set to **Auto Mode**. If the CPU temperature is lower than **Temperature of Off**, the fan speed change to be lowest. To set a value, select the **Temperature of Off** option and enter a decimal number between 0 and 127. The temperature range is specified below.

- Minimum Value: 0°C
- Maximum Value: 127°C

### → Temperature of Start [80]

---



#### **WARNING:**

Setting this value too high may cause the fan to rotate at full speed only when the CPU is at a very high temperature and therefore cause the system to be damaged.

---

The **Temperature of Start** option can only be set if the **CPU Smart Fan control** option is set to **Auto Mode**. If the CPU temperature is between **Temperature of Off** and **Temperature of Start**, the fan speed change to be **Start PWM**. To set a value, select the **Temperature of Start** option and enter a decimal number between 0 and 127. The temperature range is specified below.

- Minimum Value: 0°C
- Maximum Value: 127°C

**→ Start PWM [30]**

The **Start PWM** option can only be set if the **CPU Smart Fan control** option is set to **Auto Mode**. Use the **Start PWM** option to set the PWM start value. To set a value, select the **Start PWM** option and enter a decimal number between 0 and 100. The temperature range is specified below.

- Minimum Value: 0
- Maximum Value: 100

**→ Slope (Duty Cycle) [4]**

The **Slope (Duty Cycle)** option can only be set if the **CPU Smart Fan control** option is set to **Auto Mode**. Use the **Slope (Duty Cycle)** option to select the linear rate at which the PWM mode increases with respect to an increase in temperature. A list of available options is shown below:

- 0
- 1
- 2
- 4
- 8
- 16

## HYPER-BW

### 5.3.4 RTC Wake Settings

The **RTC Wake Settings** menu (**BIOS Menu 8**) configures RTC wake event.

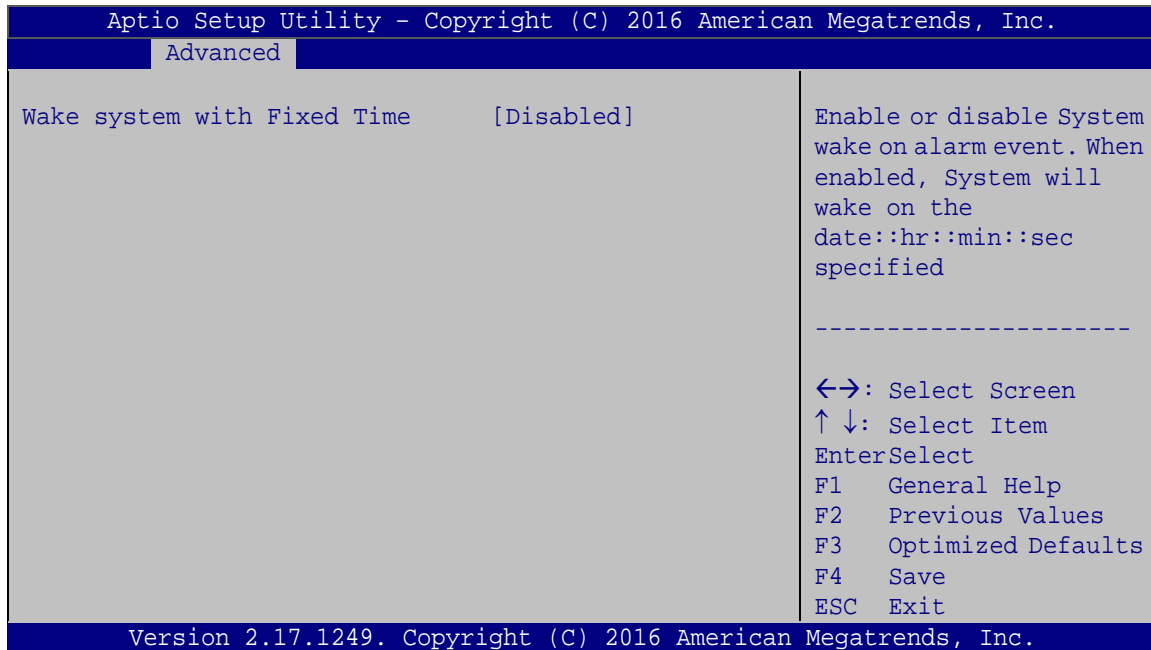

#### BIOS Menu 8: RTC Wake Settings

##### → Wake system with Fixed Time [Disabled]

Use the **Wake system with Fixed Time** option to enable or disable the system wake on alarm event.

- **Disabled**      **DEFAULT**      The real time clock (RTC) cannot generate a wake event
  
- **Enabled**      If selected, the **Wake up every day** option appears allowing you to enable to disable the system to wake every day at the specified time. Besides, the following options appear with values that can be selected:
  - Wake up date
  - Wake up hour
  - Wake up minute

Wake up second

After setting the alarm, the computer turns itself on from a suspend state when the alarm goes off.

### 5.3.5 Serial Port Console Redirection

The **Serial Port Console Redirection** menu (**BIOS Menu 9**) allows the console redirection options to be configured. Console redirection allows users to maintain a system remotely by re-directing keyboard input and text output through the serial port.

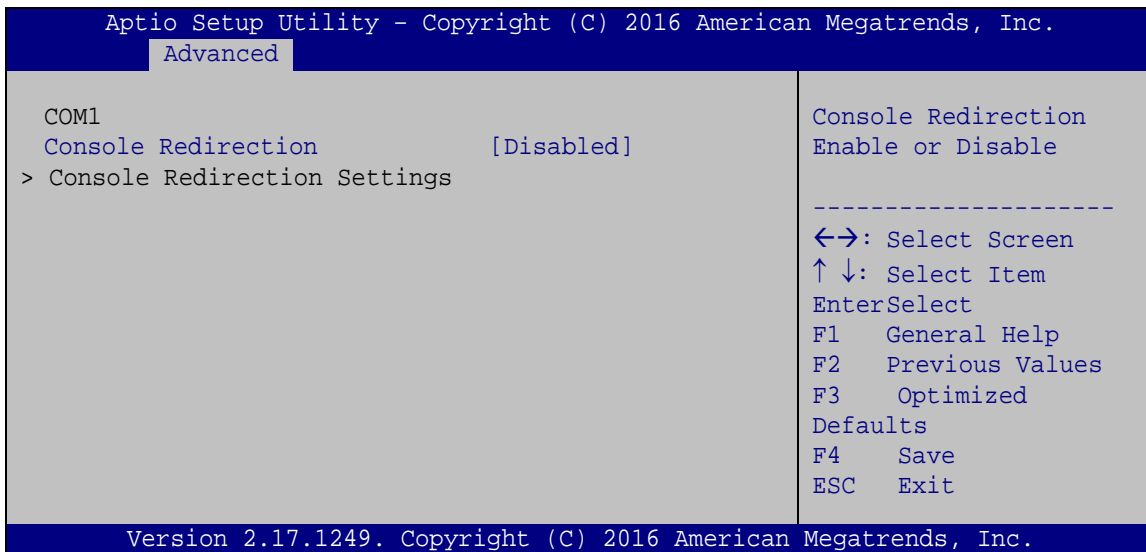

#### BIOS Menu 9: Serial Port Console Redirection

##### → Console Redirection [Disabled]

Use **Console Redirection** option to enable or disable the console redirection function.

- **Disabled**      **DEFAULT**      Disabled the console redirection function
- **Enabled**                      Enabled the console redirection function

## HYPER-BW

### 5.3.5.1 Console Redirection Settings

The **Console Redirection Settings** menu (**BIOS Menu 10**) allows the console redirection options to be configured. The option is active when Console Redirection option is enabled.

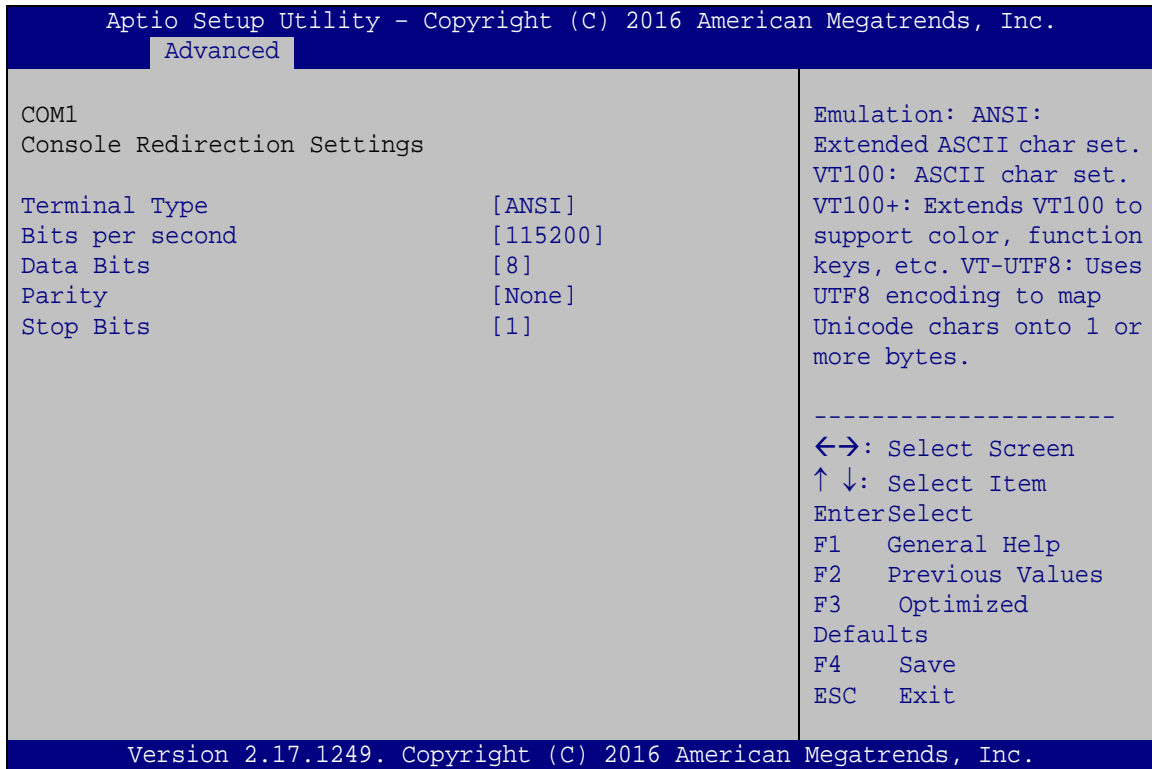

#### BIOS Menu 10: Console Redirection Settings

##### ➔ Terminal Type [ANSI]

Use the **Terminal Type** option to specify the remote terminal type.

- ➔ **VT100**                      The target terminal type is VT100
- ➔ **VT100+**                    The target terminal type is VT100+
- ➔ **VT-UTF8**                    The target terminal type is VT-UTF8
- ➔ **ANSI**                      **DEFAULT**      The target terminal type is ANSI



**→ Bits per second [115200]**

Use the **Bits per second** option to specify the serial port transmission speed. The speed must match the other side. Long or noisy lines may require lower speeds.

- |                 |                |  |
|-----------------|----------------|--|
| <b>→ 9600</b>   |                | Sets the serial port transmission speed at 9600.   |
| <b>→ 19200</b>  |                | Sets the serial port transmission speed at 19200.  |
| <b>→ 38400</b>  |                | Sets the serial port transmission speed at 38400.  |
| <b>→ 57600</b>  |                | Sets the serial port transmission speed at 57600.  |
| <b>→ 115200</b> | <b>DEFAULT</b> | Sets the serial port transmission speed at 115200. |

**→ Data Bits [8]**

Use the **Data Bits** option to specify the number of data bits.

- |            |                |                          |
|------------|----------------|--------------------------|
| <b>→ 7</b> |                | Sets the data bits at 7. |
| <b>→ 8</b> | <b>DEFAULT</b> | Sets the data bits at 8. |

**→ Parity [None]**

Use the **Parity** option to specify the parity bit that can be sent with the data bits for detecting the transmission errors.

- |                |                |   |
|----------------|----------------|---|
| <b>→ None</b>  | <b>DEFAULT</b> | No parity bit is sent with the data bits.                                 |
| <b>→ Even</b>  |                | The parity bit is 0 if the number of ones in the data bits is even.       |
| <b>→ Odd</b>   |                | The parity bit is 0 if the number of ones in the data bits is odd.        |
| <b>→ Mark</b>  |                | The parity bit is always 1. This option does not provide error detection. |
| <b>→ Space</b> |                | The parity bit is always 0. This option does not provide error detection. |

## HYPER-BW

### → Stop Bits [1]

Use the **Stop Bits** option to specify the number of stop bits used to indicate the end of a serial data packet. Communication with slow devices may require more than 1 stop bit.

- 1            **DEFAULT**      Sets the number of stop bits at 1.
- 2                              Sets the number of stop bits at 2.

### 5.3.6 iEi Feature

Use the **iEi Feature** menu (**BIOS Menu 11**) to configure One Key Recovery function.

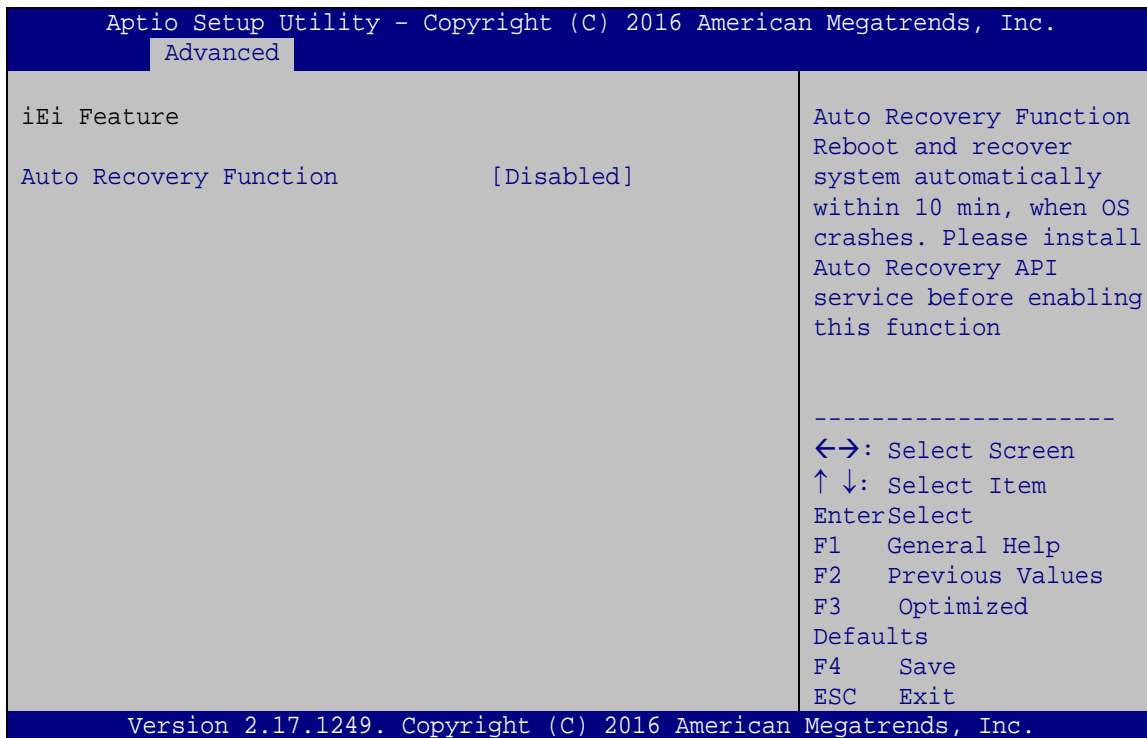

#### BIOS Menu 11: IEI Feature

### → Auto Recovery Function [Disabled]

Use the **Auto Recovery Function** BIOS option to enable or disable the auto recovery function of the IEI One Key Recovery.

- **Disabled**    **DEFAULT**      Auto recovery function disabled
- **Enabled**                      Auto recovery function enabled

### 5.3.7 CPU Configuration

Use the **CPU Configuration** menu (**BIOS Menu 5**) to view detailed CPU specifications and configure the CPU.

```

Apdio Setup Utility - Copyright (C) 2016 American Megatrends, Inc.
  Advanced
CPU Configuration
Intel(R) Pentium(R) CPU N3710 @ 1.60GHz
CPU Signature          406C4
Microcode Patch       408
Max CPU Speed         1600 MHz
Min CPU Speed         480 MHz
Processor Cores       4
Intel HT Technology   Not Supported
Intel VT-x Technology Supported

L1 Data Cache        24 KB x 2
L1 Code Cache        32 KB x 2
L2 Cache             1024 KB x 1
L3 Cache             Not Present
64-bit               Supported

Intel Virtualization Technology [Enabled]
EIST                  [Enabled]
CPU C state Report   [Disabled]

When enabled, a VMM can utilize the additional hardware capabilities provided by Vanderpool Technology.

-----
<->: Select Screen
↑ ↓: Select Item
Enter>Select
F1  General Help
F2  Previous Values
F3  Optimized
Defaults
F4  Save
ESC Exit

Version 2.17.1249. Copyright (C) 2016 American Megatrends, Inc.
  
```

#### BIOS Menu 12: CPU Configuration

##### ➔ Intel® Virtualization Technology [Disabled]

Use the **Intel® Virtualization Technology** option to enable or disable virtualization on the system. When combined with third party software, Intel Virtualization technology allows several OSs to run on the same system at the same time.

- ➔ **Disabled**      **DEFAULT**      Disables Intel Virtualization Technology.
- ➔ **Enabled**        Enables Intel Virtualization Technology.

##### ➔ EIST [Enabled]

Use the **EIST** option to enable or disable the Intel Speed Step Technology.

## HYPER-BW

- ➔ **Disabled**                      Disables the Intel Speed Step Technology.
- ➔ **Enabled**      **DEFAULT**      Enables the Intel Speed Step Technology.

### ➔ **CPU C state Report [Disabled]**

Use the **CPU C state Report** option to enable or disable CPU C state report to OS.

- ➔ **Disabled**                      Disables CPU C state report to OS.
- ➔ **Enabled**      **DEFAULT**      Enables CPU C state report to OS.

## 5.3.8 SATA Configuration

Use the **SATA Configuration** menu (**BIOS Menu 13**) to change and/or set the configuration of the SATA devices installed in the system.

```

Aptio Setup Utility - Copyright (C) 2016 American Megatrends, Inc.
  Advanced
-----
SATA Configuration                               Determines how SATA
SATA Mode Selection                               controller(s) operate.
[AHCI]
-----
SATA1
Not Present                                     ←→: Select Screen
Hot Plug                                       ↑ ↓: Select Item
M_2_SATA1                                     EnterSelect
Not Present                                     F1  General Help
Hot Plug                                       F2  Previous Values
[Disabled]                                     F3  Optimized
                                               Defaults
                                               F4  Save
                                               ESC Exit
Version 2.17.1249. Copyright (C) 2016 American Megatrends, Inc.

```

### **BIOS Menu 13: IDE Configuration**

#### ➔ **SATA Mode [ACHI Mode]**

Use the **SATA Mode** option to configure SATA devices as AHCI devices.

- ➔ **ACHI Mode**      **DEFAULT**      Configures SATA devices as AHCI device.

➔ **Hot Plug [Disabled]**

Use the **Hot Plug** option to enable or disable the hot plug function.

- ➔ **Disabled**      **DEFAULT**      Disables the hot plug function.
- ➔ **Enabled**                              Enables the hot plug function.

**5.3.9 USB Configuration**

Use the **USB Configuration** menu (**BIOS Menu 14**) to read USB configuration information and configure the USB settings.

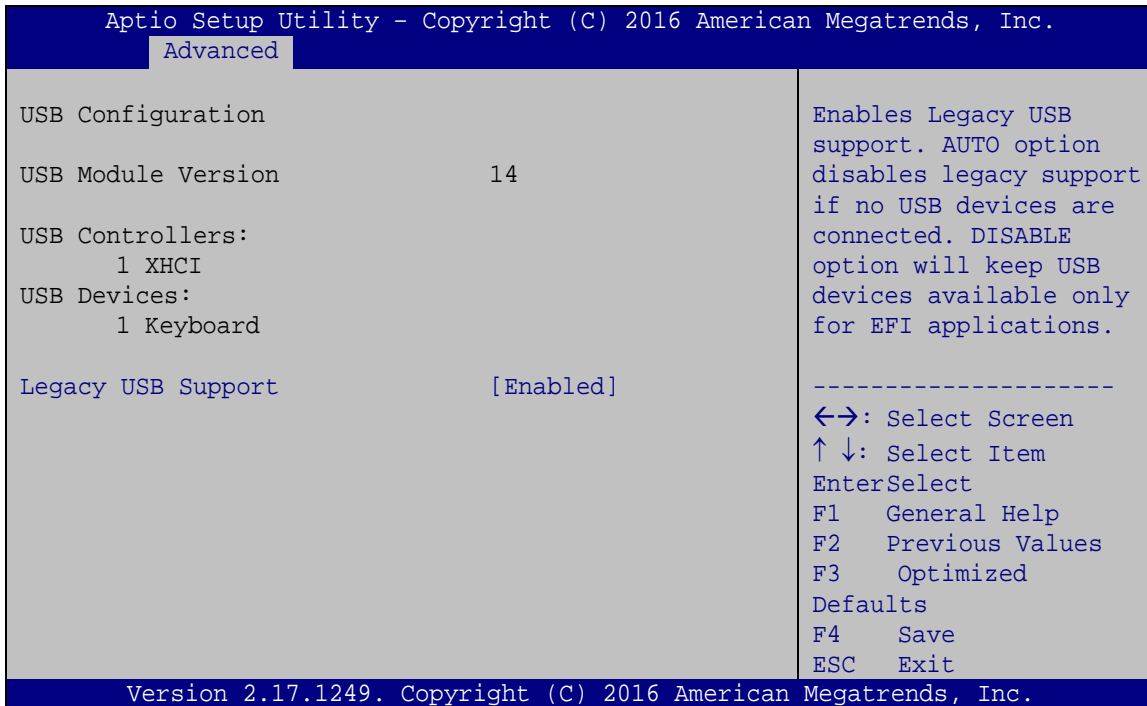

**BIOS Menu 14: USB Configuration**

➔ **USB Devices**

The **USB Devices Enabled** field lists the USB devices that are enabled on the system

➔ **Legacy USB Support [Enabled]**

Use the **Legacy USB Support** BIOS option to enable USB mouse and USB keyboard support. Normally if this option is not enabled, any attached USB mouse or USB keyboard

## HYPER-BW

does not become available until a USB compatible operating system is fully booted with all USB drivers loaded. When this option is enabled, any attached USB mouse or USB keyboard can control the system even when there is no USB driver loaded onto the system.

- ➔ **Enabled**      **DEFAULT**      Legacy USB support enabled
- ➔ **Disabled**                      Legacy USB support disabled
- ➔ **Auto**                              Legacy USB support disabled if no USB devices are connected

## 5.4 Chipset

Use the **Chipset** menu (**BIOS Menu 15**) to access the Northbridge and Southbridge configuration menus



### WARNING!

Setting the wrong values for the Chipset BIOS selections in the Chipset BIOS menu may cause the system to malfunction.

```

Aptio Setup Utility - Copyright (C) 2016 American Megatrends, Inc.
Main   Advanced  Chipset  Security  Boot   Save & Exit
-----
> North Bridge
> South Bridge

North Bridge Parameters
-----
<=>: Select Screen
↑↓: Select Item
Enter>Select
+/-: Change Opt.
F1   General Help
F2   Previous Values
F3   Optimized Defaults
F4   Save & Exit
ESC  Exit

Version 2.17.1249. Copyright (C) 2016 American Megatrends, Inc.
    
```

**BIOS Menu 15: Chipset**

## 5.4.1 North Bridge Configuration

Use the **North Bridge Configuration** menu (**BIOS Menu 16**) to configure the Intel IGD settings.

```

Aptio Setup Utility - Copyright (C) 2016 American Megatrends, Inc.
Chipset
> Intel IGD Configuration
Memory Information
Total Memory                2048 MB(LPDDR3)
DIMM1                       2048 MB(LPDDR3)
-----
<=>: Select Screen
↑ ↓: Select Item
EnterSelect
+/-: Change Opt.
F1:  General Help
F2:  Previous Values
F3:  Optimized Defaults
F4:  Save & Exit
ESC: Exit
Version 2.17.1249. Copyright (C) 2016 American Megatrends, Inc.

```

### BIOS Menu 16: Northbridge Chipset Configuration

#### → Memory Information

The **Memory Information** lists a brief summary of the on-board memory. The fields in **Memory Information** cannot be changed.

#### 5.4.1.1 Intel IGD Configuration

Use the **Intel IGD Configuration** menu (**BIOS Menu 17**) to configure the video device connected to the system.

## HYPER-BW

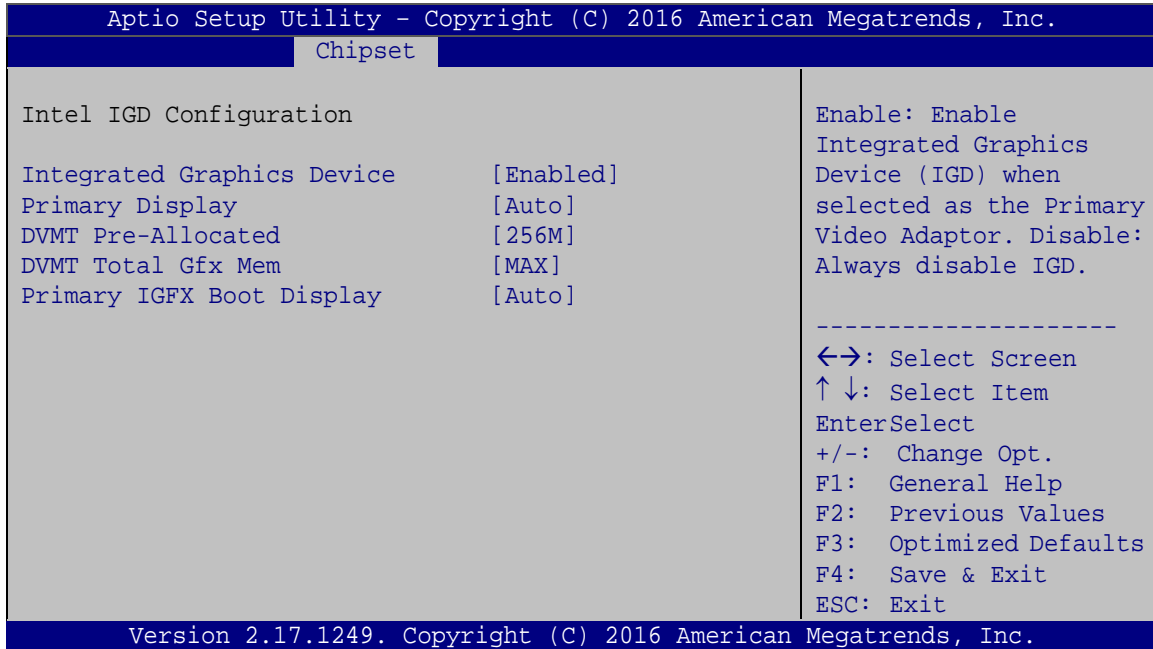

### BIOS Menu 17: Integrated Graphics

#### → Integrated Graphics Device [Enabled]

Use the **Integrated Graphics Device** option to enable or disable the Integrated Graphics Device (IGD) when selected as the Primary Video Adaptor.

- **Disabled** Disables the Integrated Graphics Device (IGD).
- **Enabled** **DEFAULT** Enables the Integrated Graphics Device (IGD).

#### → Primary Display [Auto]

Use the **Primary Display** option to select the primary graphics controller the system uses.

The following options are available:

- Auto **Default**
- IGD
- PCIe

#### → DVMT Pre-Allocated [256MB]

Use the **DVMT Pre-Allocated** option to set the amount of system memory allocated to the integrated graphics processor when the system boots. The system memory allocated can



then only be used as graphics memory, and is no longer available to applications or the operating system. Configuration options are listed below:

- 64M
- 128M
- 256M                   **Default**
- 512M

→ **DVMT Total Gfx Mem [MAX]**

Use the **DVMT Total Gfx Mem** option to select DVMT5.0 total graphic memory size used by the internal graphic device. The following options are available:

- 128M
- 256M
- MAX                   **Default**

→ **Primary IGFX Boot Display [Auto]**

Use the **Primary IGFX Boot Display** option to select the display device used by the system when it boots. For dual display support, select “VBIOS Deafult.” Configuration options are listed below.

- Auto                   **Default**
- HDMI1
- HDMII2

## HYPER-BW

### 5.4.2 Southbridge Configuration

Use the **Southbridge Configuration** menu (**BIOS Menu 18**) to configure the Southbridge chipset.

```

Aptio Setup Utility - Copyright (C) 2016 American Megatrends, Inc.
Chipset
> PCI Express Configuration
Auto Power Button Status      [Enabled(ATX)]
Restore AC Power Loss         [Last State]
Audio Configuration
Audio Controller              [Enabled]
Azalia HDMI Codec             [Enabled]
XHCI Mode                     [Enabled]
PCI Express Configuration settings.
-----
<=>: Select Screen
↑ ↓: Select Item
Enter>Select
+/-: Change Opt.
F1:  General Help
F2:  Previous Values
F3:  Optimized Defaults
F4:  Save & Exit
ESC: Exit
Version 2.17.1249. Copyright (C) 2016 American Megatrends, Inc.

```

#### BIOS Menu 18: Southbridge Chipset Configuration

##### → Restore on AC Power Loss [Last State]

Use the **Restore on AC Power Loss** BIOS option to specify what state the system returns to if there is a sudden loss of power to the system.

- **Power Off**                      The system remains turned off
- **Power On**                        The system turns on
- **Last State**    **DEFAULT**      The system returns to its previous state. If it was on, it turns itself on. If it was off, it remains off.

##### → Audio Controller [Enabled]

Use the **Audio Controller** option to enable or disable the High Definition Audio controller.

- **Disabled**                        The onboard High Definition Audio controller is disabled

➔ **Enabled**    **DEFAULT**    The onboard High Definition Audio controller is detected automatically and enabled

➔ **Azalia HDMI codec [Enabled]**

Use the **Azalia HDMI codec** option to enable or disable the HDMI codec for High Definition Audio.

➔ **Disabled**                      Disable HDMI codec for High Definition Audio

➔ **Enabled**    **DEFAULT**    Enable HDMI codec for High Definition Audio

➔ **XHCI Mode [Enabled]**

Use the **XHCI Mode** option to enable or disable the XHCI controller.

➔ **Disabled**            **DEFAULT**    Disable the XHCI controller.

➔ **Enabled**                      Enable the XHCI controller.

### 5.4.2.1 PCI Express Configuration

Use the **PCI Express Configuration** menu (**BIOS Menu 20**) to configure the M.2 2242 socket.

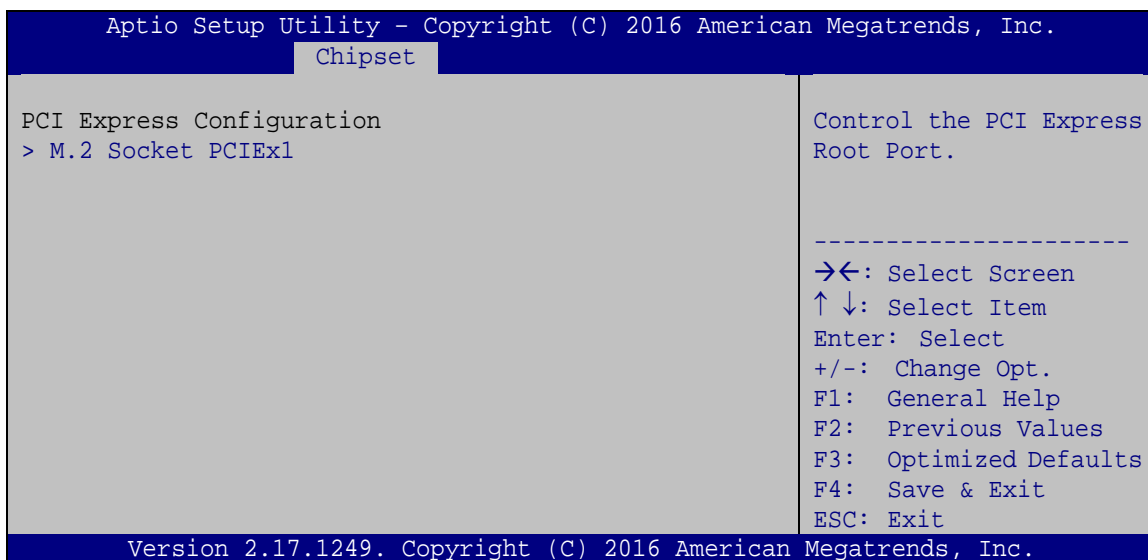

**BIOS Menu 19: PCI Express Configuration**

## HYPER-BW

### 5.4.2.2 M.2 Socket PCIex1

Use the **M.2 Socket PCIex1** menu (**BIOS Menu 20**) to select the support type of the PCIe Mini slot.

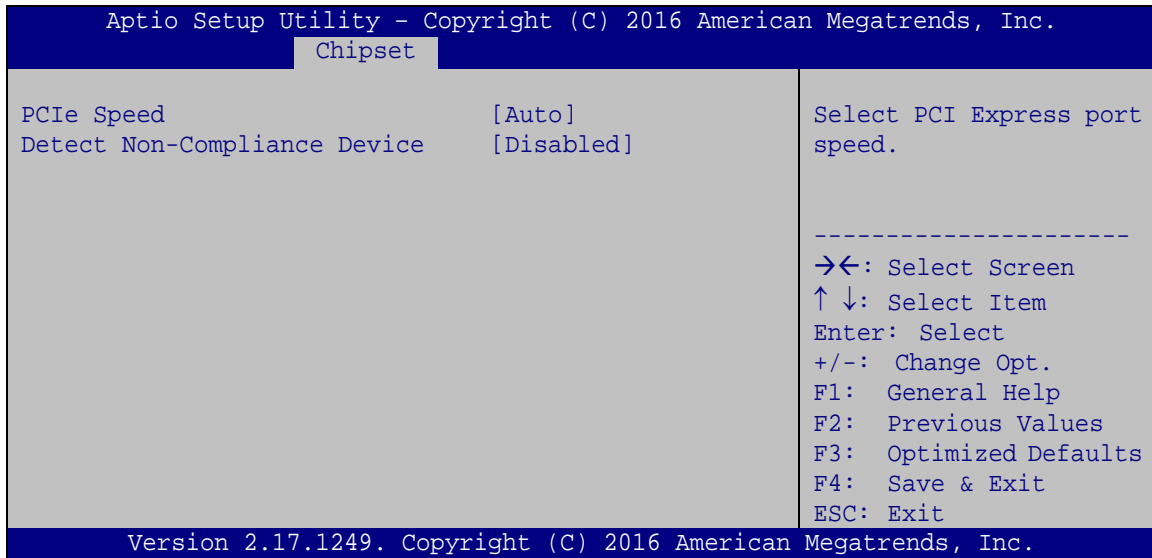

#### BIOS Menu 20: PCI Express Configuration

##### → PCIe Speed

Use PCIe Speed option to select the speed type of the PCIe Mini slot. The following options are available:

- Auto                      **Default**
- Gen2
- Gen1

##### → Detect Non-Compliance Device [Disabled]

Use the **Detect Non-Compliance Device** option to enable or disable the “detect no-compliance PCIe device” function.

- ➔ **Disabled**    **DEFAULT**    Detect no-compliance PCIe device function is disabled
- ➔ **Enabled**                      Detect no-compliance PCIe device function is enabled. If will take more time at POST if it is enabled.

## 5.5 Security

Use the **Security** menu (**BIOS Menu 21**) to set system and user passwords.

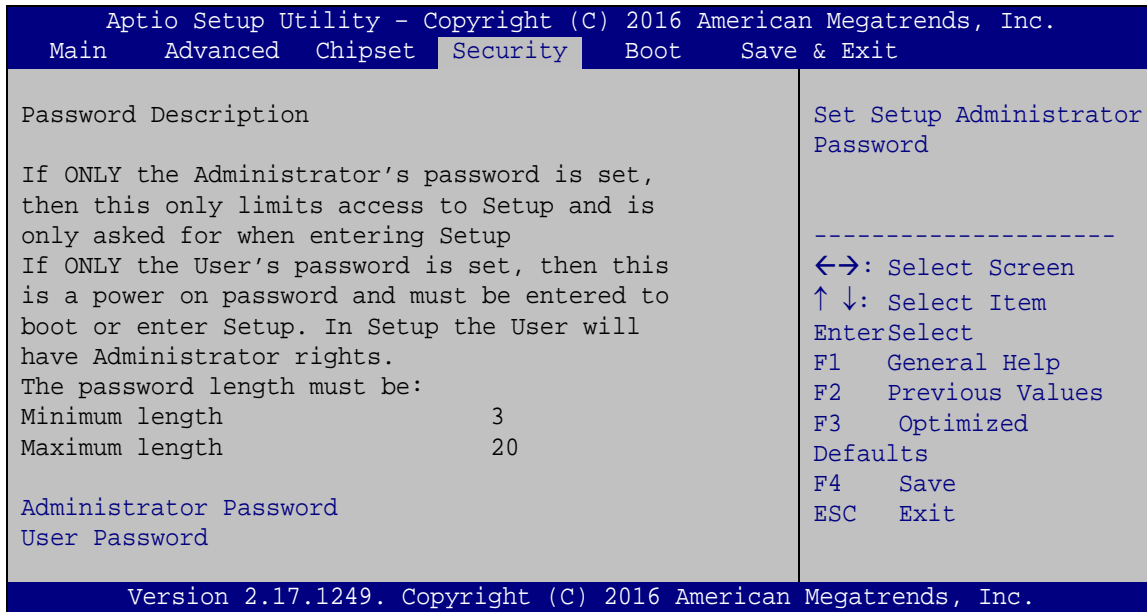

### BIOS Menu 21: Security

#### ➔ Administrator Password

Use the **Administrator Password** to set or change a administrator password.

#### ➔ User Password

Use the **User Password** to set or change a user password.

## HYPER-BW

### 5.6 Boot

Use the **Boot** menu (**BIOS Menu 18**) to configure system boot options.

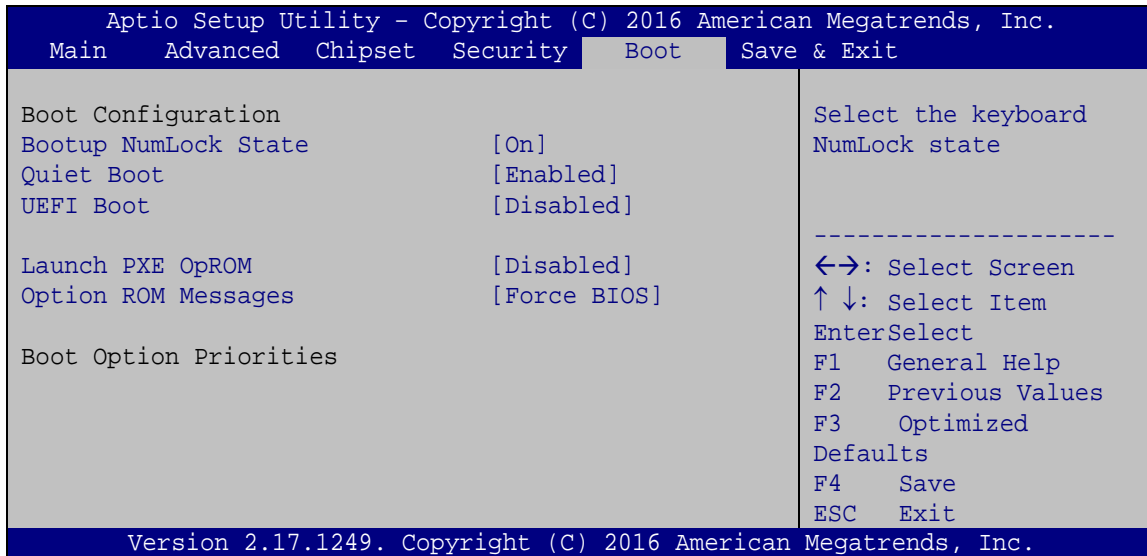

#### BIOS Menu 22: Boot

##### → Bootup NumLock State [On]

Use the **Bootup NumLock State** BIOS option to specify if the number lock setting must be modified during boot up.

- **On**      **DEFAULT**      Allows the Number Lock on the keyboard to be enabled automatically when the computer system boots up. This allows the immediate use of the 10-key numeric keypad located on the right side of the keyboard. To confirm this, the Number Lock LED light on the keyboard is lit.
  
- **Off**      Does not enable the keyboard Number Lock automatically. To use the 10-keys on the keyboard, press the Number Lock key located on the upper left-hand corner of the 10-key pad. The Number Lock LED on the keyboard lights up when the Number Lock is engaged.

**→ Quiet Boot [Enabled]**

Use the **Quiet Boot** BIOS option to select the screen display when the system boots.

- **Disabled** Normal POST messages displayed
- **Enabled** **DEFAULT** OEM Logo displayed instead of POST messages

**→ UEFI Boot [Disabled]**

Use the **UEFI Boot** option to enable or disable to boot from the UEFI devices.

- **Auto** If the first boot HDD is GPT then enable UEFI boot options, otherwise disable,
- **Enabled** Boot from UEFI devices is enabled.
- **Disabled** **DEFAULT** Boot from UEFI devices is disabled.

**→ Launch PXE OpROM [Disabled]**

Use the **Launch PXE OpROM** option to enable or disable boot option for legacy network devices.

- **Disabled** **DEFAULT** Ignore all PXE Option ROMs
- **Enabled** Load PXE Option ROMs.

**→ Option ROM Messages [Force BIOS]**

Use the **Option ROM Messages** option to set the Option ROM display mode.

- **Force BIOS** **DEFAULT** Sets display mode to force BIOS.
- **Keep Current** Sets display mode to current.

**→ Boot Option Priority**

Use the **Boot Option Priority** function to set the system boot sequence from the available devices. The drive sequence also depends on the boot sequence in the individual device section.

## HYPER-BW

## 5.7 Exit

Use the **Exit** menu (**BIOS Menu 23**) to load default BIOS values, optimal failsafe values and to save configuration changes.

```

Aptio Setup Utility - Copyright (C) 2016 American Megatrends, Inc.
Main  Advanced  Chipset  Security  Boot  Save & Exit
-----
Save Options
Save Changes and Reset
Discard Changes and Reset

Default Options
Restore Defaults
Save as User Defaults
Restore User Defaults

Reset the system after
saving the changes.

-----
<-->: Select Screen
↑ ↓: Select Item
Enter>Select
F1  General Help
F2  Previous Values
F3  Optimized
Defaults
F4  Save
ESC  Exit

Version 2.17.1249. Copyright (C) 2016 American Megatrends, Inc.

```

**BIOS Menu 23:Exit****→ Save Changes and Reset**

Use the **Save Changes and Reset** option to save the changes made to the BIOS options and to exit the BIOS configuration setup program.

**→ Discard Changes and Reset**

Use the **Discard Changes and Reset** option to exit the system without saving the changes made to the BIOS configuration setup program.

**→ Restore Defaults**

Use the **Restore Defaults** option to load the optimal default values for each of the parameters on the Setup menus. **F3 key can be used for this operation.**



→ **Save as User Defaults**

Use the **Save as User Defaults** option to save the changes done so far as user defaults.

→ **Restore User Defaults**

Use the **Restore User Defaults** option to restore the user defaults to all the setup options.

**Appendix**

**A**

# **Regulatory Compliance**

---

**DECLARATION OF CONFORMITY**

This equipment has been tested and found to comply with specifications for CE marking. If the user modifies and/or installs other devices in the equipment, the CE conformity declaration may no longer apply.

**FCC WARNING**

This equipment complies with Part 15 of the FCC Rules. Operation is subject to the following two conditions:

- This device may not cause harmful interference, and
- This device must accept any interference received, including interference that may cause undesired operation.

This equipment has been tested and found to comply with the limits for a Class A digital device, pursuant to part 15 of the FCC Rules. These limits are designed to provide reasonable protection against harmful interference when the equipment is operated in a commercial environment. This equipment generates, uses, and can radiate radio frequency energy and, if not installed and used in accordance with the instruction manual, may cause harmful interference to radio communications. Operation of this equipment in a residential area is likely to cause harmful interference in which case the user will be required to correct the interference at his own expense.

**Appendix**

**B**

# **Product Disposal**

---

**CAUTION:**

Risk of explosion if battery is replaced by an incorrect type. Only certified engineers should replace the on-board battery.

Dispose of used batteries according to instructions and local regulations.

---

- Outside the European Union – If you wish to dispose of used electrical and electronic products outside the European Union, please contact your local authority so as to comply with the correct disposal method.
- Within the European Union – The device that produces less waste and is easier to recycle is classified as electronic device in terms of the European Directive 2012/19/EU (WEEE), and must not be disposed of as domestic garbage.



EU-wide legislation, as implemented in each Member State, requires that waste electrical and electronic products carrying the mark (left) must be disposed of separately from normal household waste. This includes monitors and electrical accessories, such as signal cables or power cords. When you need to dispose of your device, please follow the guidance of your local authority, or ask the shop where you purchased the product. The mark on electrical and electronic products only applies to the current European Union Member States.

Please follow the national guidelines for electrical and electronic product disposal.

Appendix

C

# BIOS Options

---

Below is a list of BIOS configuration options in the BIOS chapter.

<input type="checkbox"/>	<b>System Date [xx/xx/xx]</b> .....	<b>51</b>
<input type="checkbox"/>	<b>System Time [xx:xx:xx]</b> .....	<b>51</b>
<input type="checkbox"/>	<b>ACPI Sleep State [S3 only (Suspend to RAM)]</b> .....	<b>52</b>
<input type="checkbox"/>	<b>Serial Port [Enabled]</b> .....	<b>54</b>
<input type="checkbox"/>	<b>Change Settings [Auto]</b> .....	<b>54</b>
<input type="checkbox"/>	<b>PC Health Status</b> .....	<b>55</b>
<input type="checkbox"/>	<b>CPU Smart Fan control [Auto PWM Mode]</b> .....	<b>56</b>
<input type="checkbox"/>	<b>Temperature of Off [75]</b> .....	<b>57</b>
<input type="checkbox"/>	<b>Temperature of Start [80]</b> .....	<b>57</b>
<input type="checkbox"/>	<b>Start PWM [30]</b> .....	<b>58</b>
<input type="checkbox"/>	<b>Slope (Duty Cycle) [4]</b> .....	<b>58</b>
<input type="checkbox"/>	<b>Wake system with Fixed Time [Disabled]</b> .....	<b>59</b>
<input type="checkbox"/>	<b>Console Redirection [Disabled]</b> .....	<b>60</b>
<input type="checkbox"/>	<b>Terminal Type [ANSI]</b> .....	<b>61</b>
<input type="checkbox"/>	<b>Bits per second [115200]</b> .....	<b>62</b>
<input type="checkbox"/>	<b>Data Bits [8]</b> .....	<b>62</b>
<input type="checkbox"/>	<b>Parity [None]</b> .....	<b>62</b>
<input type="checkbox"/>	<b>Stop Bits [1]</b> .....	<b>63</b>
<input type="checkbox"/>	<b>Auto Recovery Function [Disabled]</b> .....	<b>63</b>
<input type="checkbox"/>	<b>Intel® Virtualization Technology [Disabled]</b> .....	<b>64</b>
<input type="checkbox"/>	<b>EIST [Enabled]</b> .....	<b>64</b>
<input type="checkbox"/>	<b>CPU C state Report [Disabled]</b> .....	<b>65</b>
<input type="checkbox"/>	<b>SATA Mode [ACHI Mode]</b> .....	<b>65</b>
<input type="checkbox"/>	<b>Hot Plug [Disabled]</b> .....	<b>66</b>
<input type="checkbox"/>	<b>USB Devices</b> .....	<b>66</b>
<input type="checkbox"/>	<b>Legacy USB Support [Enabled]</b> .....	<b>66</b>
<input type="checkbox"/>	<b>Memory Information</b> .....	<b>68</b>
<input type="checkbox"/>	<b>Integrated Graphics Device [Enabled]</b> .....	<b>69</b>
<input type="checkbox"/>	<b>Primary Display [Auto]</b> .....	<b>69</b>
<input type="checkbox"/>	<b>DVMT Pre-Allocated [256MB]</b> .....	<b>69</b>
<input type="checkbox"/>	<b>DVMT Total Gfx Mem [MAX]</b> .....	<b>70</b>
<input type="checkbox"/>	<b>Primary IGFX Boot Display [Auto]</b> .....	<b>70</b>
<input type="checkbox"/>	<b>Audio Controller [Enabled]</b> .....	<b>71</b>

## HYPER-BW

<input type="checkbox"/>	Azalia HDMI codec [Enabled].....	72
<input type="checkbox"/>	XHCI Mode [Enabled].....	72
<input type="checkbox"/>	PCIe Speed .....	73
<input type="checkbox"/>	Detect Non-Compliance Device [Disabled] .....	73
<input type="checkbox"/>	Administrator Password .....	74
<input type="checkbox"/>	User Password .....	74
<input type="checkbox"/>	Bootup NumLock State [On].....	75
<input type="checkbox"/>	Quiet Boot [Enabled] .....	76
<input type="checkbox"/>	UEFI Boot [Disabled] .....	76
<input type="checkbox"/>	Launch PXE OpROM [Disabled] .....	76
<input type="checkbox"/>	Option ROM Messages [Force BIOS].....	76
<input type="checkbox"/>	Boot Option Priority.....	76
<input type="checkbox"/>	Save Changes and Reset .....	77
<input type="checkbox"/>	Discard Changes and Reset .....	77
<input type="checkbox"/>	Restore Defaults .....	77
<input type="checkbox"/>	Save as User Defaults .....	78
<input type="checkbox"/>	Restore User Defaults .....	78



Appendix

**D**

# Terminology

---

## HYPER-BW

<b>AC '97</b>	Audio Codec 97 (AC'97) refers to a codec standard developed by Intel® in 1997.
<b>ACPI</b>	Advanced Configuration and Power Interface (ACPI) is an OS-directed configuration, power management, and thermal management interface.
<b>AHCI</b>	Advanced Host Controller Interface (AHCI) is a SATA Host controller register-level interface.
<b>ATA</b>	The Advanced Technology Attachment (ATA) interface connects storage devices including hard disks and CD-ROM drives to a computer.
<b>ARMD</b>	An ATAPI Removable Media Device (ARMD) is any ATAPI device that supports removable media, besides CD and DVD drives.
<b>ASKIR</b>	Amplitude Shift Keyed Infrared (ASKIR) is a form of modulation that represents a digital signal by varying the amplitude (“volume”) of the signal. A low amplitude signal represents a binary 0, while a high amplitude signal represents a binary 1.
<b>BIOS</b>	The Basic Input/Output System (BIOS) is firmware that is first run when the computer is turned on and can be configured by the end user
<b>CODEC</b>	The Compressor-Decompressor (CODEC) encodes and decodes digital audio data on the system.
<b>CMOS</b>	Complimentary metal-oxide-conductor is an integrated circuit used in chips like static RAM and microprocessors.
<b>COM</b>	COM refers to serial ports. Serial ports offer serial communication to expansion devices. The serial port on a personal computer is usually a male DB-9 connector.
<b>DAC</b>	The Digital-to-Analog Converter (DAC) converts digital signals to analog signals.
<b>DDR</b>	Double Data Rate refers to a data bus transferring data on both the rising and falling edges of the clock signal.
<b>DMA</b>	Direct Memory Access (DMA) enables some peripheral devices to bypass the system processor and communicate directly with the system memory.

<b>DIMM</b>	Dual Inline Memory Modules are a type of RAM that offer a 64-bit data bus and have separate electrical contacts on each side of the module.
<b>DIO</b>	The digital inputs and digital outputs are general control signals that control the on/off circuit of external devices or TTL devices. Data can be read or written to the selected address to enable the DIO functions.
<b>EHCI</b>	The Enhanced Host Controller Interface (EHCI) specification is a register-level interface description for USB 2.0 Host Controllers.
<b>EIDE</b>	Enhanced IDE (EIDE) is a newer IDE interface standard that has data transfer rates between 4.0 MBps and 16.6 MBps.
<b>EIST</b>	Enhanced Intel® SpeedStep Technology (EIST) allows users to modify the power consumption levels and processor performance through application software. The application software changes the bus-to-core frequency ratio and the processor core voltage.
<b>FSB</b>	The Front Side Bus (FSB) is the bi-directional communication channel between the processor and the Northbridge chipset.
<b>GbE</b>	Gigabit Ethernet (GbE) is an Ethernet version that transfers data at 1.0 Gbps and complies with the IEEE 802.3-2005 standard.
<b>GPIO</b>	General purpose input
<b>HDD</b>	Hard disk drive (HDD) is a type of magnetic, non-volatile computer storage device that stores digitally encoded data.
<b>ICH</b>	The Input/Output Control Hub (ICH) is an Intel® Southbridge chipset.
<b>IrDA</b>	Infrared Data Association (IrDA) specify infrared data transmission protocols used to enable electronic devices to wirelessly communicate with each other.
<b>L1 Cache</b>	The Level 1 Cache (L1 Cache) is a small memory cache built into the system processor.
<b>L2 Cache</b>	The Level 2 Cache (L2 Cache) is an external processor memory cache.
<b>LCD</b>	Liquid crystal display (LCD) is a flat, low-power display device that consists of two polarizing plates with a liquid crystal panel in between.

## HYPER-BW

<b>LVDS</b>	Low-voltage differential signaling (LVDS) is a dual-wire, high-speed differential electrical signaling system commonly used to connect LCD displays to a computer.
<b>POST</b>	The Power-on Self Test (POST) is the pre-boot actions the system performs when the system is turned-on.
<b>RAM</b>	Random Access Memory (RAM) is volatile memory that loses data when power is lost. RAM has very fast data transfer rates compared to other storage like hard drives.
<b>SATA</b>	Serial ATA (SATA) is a serial communications bus designed for data transfers between storage devices and the computer chipsets. The SATA bus has transfer speeds up to 1.5 Gbps and the SATA II bus has data transfer speeds of up to 3.0 Gbps.
<b>S.M.A.R.T</b>	Self Monitoring Analysis and Reporting Technology (S.M.A.R.T) refers to automatic status checking technology implemented on hard disk drives.
<b>UART</b>	Universal Asynchronous Receiver-transmitter (UART) is responsible for asynchronous communications on the system and manages the system's serial communication (COM) ports.
<b>UHCI</b>	The Universal Host Controller Interface (UHCI) specification is a register-level interface description for USB 1.1 Host Controllers.
<b>USB</b>	The Universal Serial Bus (USB) is an external bus standard for interfacing devices. USB 1.1 supports 12Mbps data transfer rates and USB 2.0 supports 480Mbps data transfer rates.
<b>VGA</b>	The Video Graphics Array (VGA) is a graphics display system developed by IBM.

Appendix

**E**

# Watchdog Timer

---

## HYPER-BW

**NOTE:**

The following discussion applies to DOS environment. Contact IEI support or visit the IEI website for specific drivers for other operating systems.

The Watchdog Timer is provided to ensure that standalone systems can always recover from catastrophic conditions that cause the CPU to crash. This condition may have occurred by external EMIs or a software bug. When the CPU stops working correctly, Watchdog Timer either performs a hardware reset (cold boot) or a Non-Maskable Interrupt (NMI) to bring the system back to a known state.

A BIOS function call (INT 15H) is used to control the Watchdog Timer.

INT 15H:

<b>AH – 6FH Sub-function:</b>	
AL – 2:	Sets the Watchdog Timer's period.
BL:	Time-out value (Its unit-second is dependent on the item "Watchdog Timer unit select" in CMOS setup).

**Table E-1: AH-6FH Sub-function**

Call sub-function 2 to set the time-out period of Watchdog Timer first. If the time-out value is not zero, the Watchdog Timer starts counting down. When the timer value reaches zero, the system resets. To ensure that this reset condition does not occur, calling sub-function 2 must periodically refresh the Watchdog Timer. However, the watchdog timer is disabled if the time-out value is set to zero.

A tolerance of at least 10% must be maintained to avoid unknown routines within the operating system (DOS), such as disk I/O that can be very time-consuming.

**NOTE:**

When exiting a program it is necessary to disable the Watchdog Timer, otherwise the system resets.

**EXAMPLE PROGRAM:**

```
; INITIAL TIMER PERIOD COUNTER
```

```
;
```

```
W_LOOP:
```

```
;
```

```
    MOV     AX, 6F02H      ;setting the time-out value  
    MOV     BL, 30        ;time-out value is 48 seconds  
    INT     15H
```

```
;
```

```
; ADD THE APPLICATION PROGRAM HERE
```

```
;
```

```
    CMP     EXIT_AP, 1    ;is the application over?  
    JNE     W_LOOP       ;No, restart the application
```

```
    MOV     AX, 6F02H    ;disable Watchdog Timer  
    MOV     BL, 0       ;  
    INT     15H
```

```
;
```

```
; EXIT ;
```

Appendix

F

# Hazardous Materials Disclosure

---



The details provided in this appendix are to ensure that the product is compliant with the Peoples Republic of China (China) RoHS standards. The table below acknowledges the presences of small quantities of certain materials in the product, and is applicable to China RoHS only.

A label will be placed on each product to indicate the estimated “Environmentally Friendly Use Period” (EFUP). This is an estimate of the number of years that these substances would “not leak out or undergo abrupt change.” This product may contain replaceable sub-assemblies/components which have a shorter EFUP such as batteries and lamps. These components will be separately marked.

Please refer to the following table.

Part Name	Toxic or Hazardous Substances and Elements					
	Lead (Pb)	Mercury (Hg)	Cadmium (Cd)	Hexavalent Chromium (CR(VI))	Polybrominated Biphenyls (PBB)	Polybrominated Diphenyl Ethers (PBDE)
Housing	O	O	O	O	O	O
Display	O	O	O	O	O	O
Printed Circuit Board	O	O	O	O	O	O
Metal Fasteners	O	O	O	O	O	O
Cable Assembly	O	O	O	O	O	O
Fan Assembly	O	O	O	O	O	O
Power Supply Assemblies	O	O	O	O	O	O
Battery	O	O	O	O	O	O

O: This toxic or hazardous substance is contained in all of the homogeneous materials for the part is below the limit requirement in SJ/T11363-2006 (now replaced by GB/T 26572-2011).

X: This toxic or hazardous substance is contained in at least one of the homogeneous materials for this part is above the limit requirement in SJ/T11363-2006 (now replaced by GB/T 26572-2011).

## HYPER-BW

此附件旨在确保本产品符合中国 RoHS 标准。以下表格标示此产品中某有毒物质的含量符合中国 RoHS 标准规定的限量要求。

本产品上会附有“环境友好使用期限”的标签，此期限是估算这些物质“不会有泄漏或突变”的年限。本产品可能包含有较短的环境友好使用期限的可替换元件，像是电池或灯管，这些元件将会单独标示出来。

部件名称	有毒有害物质或元素					
	铅 (Pb)	汞 (Hg)	镉 (Cd)	六价铬 (CR(VI))	多溴联苯 (PBB)	多溴二苯 醚 (PBDE)
壳体	○	○	○	○	○	○
显示	○	○	○	○	○	○
印刷电路板	○	○	○	○	○	○
金属螺帽	○	○	○	○	○	○
电缆组装	○	○	○	○	○	○
风扇组装	○	○	○	○	○	○
电力供应组装	○	○	○	○	○	○
电池	○	○	○	○	○	○

○: 表示该有毒有害物质在该部件所有物质材料中的含量均在 SJ/T 11363-2006 (现由 GB/T 26572-2011 取代) 标准规定的限量要求以下。

X: 表示该有毒有害物质至少在该部件的某一均质材料中的含量超出 SJ/T 11363-2006 (现由 GB/T 26572-2011 取代) 标准规定的限量要求。