

# Avalue Intelligent Display & System

## HID-2340

23.8" Alder Lake Medical Panel PC

### User Manual

---

1<sup>st</sup> Ed- 15 September 2023

Copyright © 2023 Avalue Technology Inc., All Rights Reserved.

DMR No: T86027-00  
Rev: 1<sup>st</sup>

Part No: E2017H300A0R

## Instructions for the User

The document combines text and illustrations, providing a comprehensive overview of the system. The information is presented as a sequential steps of actions, allowing the user to learn directly how to use the device. The text provides explanations and instructs the user step-by-step in the practical use of the product, with short, clear instructions in an easy-to-follow sequence.

- Non-patient at least 18 years old with basic reading experience.
- Read and understand “westernized Arabic numbers” when written in Arial font
- Can distinguish human organs and understand hygiene.
- Understand languages as specified in the marketing plan (Ext: Chinese, English....).
- For general function operation and maintenance, no special experiences are required.
- Mechanical tool operation knowledge is needed when installing mounting.  
Please contact a service technician or your retailer.

## Purposes and Applications

HID-2340 is intended to be used in healthcare institutions for general purpose as an assisting device for data access – patient information, medical records, media services, and so on. The product is designed for general or special use in the hospital environment.

## Operating principle

A Medical Panel PC has four main components: the arithmetic logic unit (ALU), the control unit, the memory, and the input and output devices (collectively termed I/O). These parts are interconnected by buses, often made of groups of wires.

The control unit, ALU, and registers are collectively known as a central processing unit (CPU). Inside each of these parts are thousands to trillions of small electrical circuits which can be turned off or on by means of an electronic switch. Each circuit represents a bit (binary digit) of information so that when the circuit is on it represents a "1", and when off it represents a "0" (in positive logic representation). The circuits are arranged in logic gates so that one or more of the circuits may control the state of one or more of the other circuits.

## Definitions

**Warning!** A **WARNING** statement provides important information about a potentially hazardous situation which, if not avoided, could result in death or serious injury.



**Caution!** A **CAUTION** statement provides important information about a potentially hazardous situation which, if not avoided, may result in minor or moderate injury to the user or patient or in damage to the equipment or other property.



**Attention!** Un avertissement fournit des informations importantes sur une situation potentiellement dangereuse qui, si elle n'est pas évitée, peut entraîner la mort ou des blessures graves.



**Précaution!** Une mention **ATTENTION** fournit des informations importantes sur une situation potentiellement dangereuse qui, si elle n'est pas évitée, peut entraîner des blessures mineures ou modérées pour l'utilisateur ou le patient ou des dommages à l'équipement ou à d'autres biens.



**Note!** A **NOTE** provides additional information intended to avoid inconveniences during operation.



## Safety Instructions

1. Strictly follow these Instructions for Use, please read these safety instructions carefully.
2. Remind to keep this User's Manual for later reference, and any use of the product requires full understanding and strict observation of all portions of these instructions. Observe all **WARNINGS** and **CAUTIONS** as rendered throughout this manual and on labels on the equipment.
3. Repair of the device may also only be carried out by **MANUFACTURER**.

**Warning!** Because of the danger of electric shock, never remove the cover of a device while it is in operation or connected to a power outlet.



**Attention!** *En raison du risque de choc électrique, ne retirez jamais le couvercle d'un appareil lorsqu'il est en fonctionnement ou connecté à une prise de courant.*



4. If one of the following situations arises, please refer to the solutions:

Problem	Solution
The power cord or plug is damaged.	Contact manufacturer for further inspection.
Liquid has penetrated equipment.	Try to dry up excess liquid and contact manufacturer for further inspection.
The equipment does not power on.	<ol style="list-style-type: none"> <li>1. Check the adapter model to see if it is correct.</li> <li>2. Confirm whether power adapter and power cord is properly connected.</li> <li>3. If the problem still exists, contact manufacturer for further inspection.</li> </ol>
The equipment has been damaged.	<ol style="list-style-type: none"> <li>1. Power on the equipment to confirm whether the function is still normal.</li> <li>2. Contact manufacturer for repairment if needed.</li> </ol>

5. Disconnect this equipment from any AC outlet before cleaning. Use a damp cloth. Do not use liquid or spray detergents for cleaning and keep this equipment away from humidity.

**Caution!** *To avoid short-circuiting and otherwise damaging the device, do not allow fluids to come in contact with the device. If fluids are accidentally spilled on the equipment, remove the affected unit from service as soon as possible and contact the service personnel to verify that patient safety is not compromised.*



**Précaution!** *Pour éviter tout court-circuit et autrement endommager l'appareil, ne laissez pas de liquides entrer en contact avec l'appareil. Si du liquide est accidentellement renversé sur l'équipement, retirez l'unité affectée du service dès que possible et contactez le personnel d'entretien pour vérifier que la sécurité du patient n'est pas compromise.*



6. Put this equipment on a reliable surface during installation. Dropping it or letting it fall may cause damage. For plug-in equipment, the power outlet socket must be

located near the equipment and must be easily accessible.

**Caution!** *To prevent overheating, do not cover the openings and place the device in direct sunlight or near radiant heaters.*



**Précaution!** *Pour éviter la surchauffe, ne couvrez pas les ouvertures et placez l'appareil à la lumière directe du soleil ou à proximité de radiateurs rayonnants.*



7. Make sure the voltage of the power source is correct before connecting the equipment to the power outlet. Position the power cord so that people cannot step on it. Do not place anything over the power cord. If the equipment is not used for a long time, disconnect it from the power source to avoid damage by transient over voltage.

**Caution!** *Do not leave this equipment in an uncontrolled environment where the storage temperature is below -20° C (-4° F) or above 60° C (140° F). this may damage the equipment.*



**Précaution!** *Ne laissez pas cet équipement dans un environnement non contrôlé où la température de stockage est inférieure à -20 ° C (-4 ° F) ou supérieure à 60 ° C (140 ° F). cela pourrait endommager l'équipement.*



8. If your computer is losing dramatic time or the BIOS configuration reset to default, the battery has no power.

**Caution!** *Do not replace battery yourself. Please contact MANUFACTURER. The computer is provided with a battery-powered real-time clock circuit. There is a danger of explosion if battery is incorrectly replaced. Replace only with same or equivalent type recommended by the manufacture. Discard used batteries according to the manufacturer's instructions.*



**Précaution!** *Ne remplacez pas la batterie vous-même. Veuillez contacter le FABRICANT. L'ordinateur est équipé d'un circuit d'horloge en temps réel alimenté par batterie. Il existe un risque d'explosion si la batterie n'est pas remplacée correctement. Remplacez uniquement par un type identique*



*ou équivalent recommandé par le fabricant. Jeter les piles usagées conformément aux instructions du fabricant.*

9. Improper installation of VESA mounting can result in serious personal injury! VESA mount installation should be operated by professional technician, please contact the service technician or your retail if you need this service.

10. Environmental protection: follow national requirements to dispose of unit.

11. Maintenance: to properly maintain and clean the surfaces, use only the approved products or clean with a dry applicator.

12. Make sure the user not to contact SIP/SOPs and the patient at the same time.

13. When networking with electrical devices, the operator is responsible for ensuring that the resulting system meets the requirements set forth by the following standards:

– EN 60601-1 (IEC 60601-1)

Medical electrical equipment

Part 1: General requirements for safety

– EN 60601-1-1 (IEC 60601-1-1)

Medical electrical equipment

Part 1-1: General requirements for safety

Collateral standard: Safety requirements for Medical electrical systems

– EN 60601-1-2 (IEC 60601-1-2)

Medical electrical equipment

Part 1-2: General requirements for safety

Collateral standard: Electromagnetic compatibility; Requirements and tests



MEDICAL - GENERAL MEDICAL EQUIPMENT AS TO ELECTRICAL  
SHOCK, FIRE AND MECHANICAL HAZARDS ONLY IN ACCORDANCE  
ANSI/AAMI ES60601-1  
CAN/CSA-C22.2 No. 60601-1

14. Accessory equipment connected to the analog and digital interfaces must be in compliance with the respective nationally harmonized IEC standards (i.e. IEC 60950 for data processing equipment, IEC 60065 for video equipment, IEC 61010-1 for laboratory equipment, and IEC 60601-1 for medical equipment.) Furthermore, all configurations shall comply with the system standard IEC 60601-1-1. Everybody who connects additional equipment to the signal input part or signal output part configures a medical system, and is therefore, responsible that the system complies with the

requirements of the system standard IEC 60601-1-1. The unit is for exclusive interconnection with IEC 60601-1 certified equipment in the patient environment and IEC 60601-1 certified equipment outside of the patient environment. If in doubt, consult the technical services department or your local representative.

**Caution!** Use suitable mounting apparatus to avoid risk of injury.



**Précaution!** Utilisez un appareil de montage approprié pour éviter tout risque de blessure.



15. Use a power cord that matches the voltage of the power outlet, which has been approved and complies with the safety standard of your country.

**Note!** Environmental protection Follow national requirements to dispose of unit.



**Warning!** Do not modify this equipment without authorization of the manufacturer.



**Warning!** To avoid risk of electric shock, this equipment must only be connected to a supply main with protective earth.



**Caution!** This adapter EDAC EM11011M(18) is a forming part of the medical device.



**Attention!** Ne modifiez pas cet équipement sans l'autorisation du fabricant.



**Attention!** *Pour éviter tout risque de choc électrique, cet équipement ne doit être connecté qu'à une alimentation avec terre de protection.*



**Précaution!** *Cet adaptateur EDAC EM11011M(18) fait partie intégrante du dispositif médical.*



16. The design of Internal Smart battery is considered for backup purpose while system accidently loosing main power supply in any situation, it will supply max.6mins of the operating time to keep let user backup the data and shut down the system properly.

**Caution!** *Do not attempt to disassemble the battery pack. There is danger of excessive temperatures, fire or explosion if the battery is incorrectly replaced. Please contact with MANUFACTURER to replace battery packs.*

**Caution!** *Do not use the power adapter that isn't made for the equipment, supplying the equipment with inappropriate voltage may cause harm to the battery (if any) or even worse burn the equipment.*



**Précaution!** *Do not attempt to disassemble the battery pack. There is danger of excessive temperatures, fire or explosion if the battery is incorrectly replaced. Please contact with MANUFACTURER to replace battery packs.*

**Précaution!** *Do not use the power adapter that isn't made for the equipment, supplying the equipment with inappropriate voltage may cause harm to the battery (if any) or even worse burn the equipment.*





**Caution!** Risk of Explosion if Battery is replaced by an Incorrect Type. Dispose of Used Batteries According to the Instructions."

**Attention!** Risque d'explosion si la batterie est remplacée par un type incorrect. Jetez les piles usagées selon les instructions



## **WARNING**

### **RISK OF ELECTRIC SHOCK**



- TO REDUCE THE RISK OF ELECTRIC SHOCK, DO NOT REMOVE FRONT OR BACK COVER.
- READ THE MANUAL AND SAFETY PRECAUTIONS BEFORE PERFORMING INSTALLATION
- MAKE SURE THE POWER CORD IS PLUGGED INTO THE SYSTEM BEFORE CONNECTIONG THE POWER CORD TO AN AC POWER OUTLET
- DISCOUNT POWER FROM THE SYSTEM BY UNPLUGGING THE POWER CORD FROM AC OUTLET
- THE AC POWER OUTLET SHOULD BE COMPATIBLE WITH THE 3-PIN POWER CORD CONNECTOR

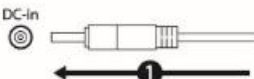

1. Plug the power cord into your system



2. Connect AC power cord to the power adapter

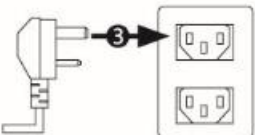

3. Plug the power cord into an easily accessible Ac power outlet



## **Attention!**

### **RISQUE DE CHOC ELECTRIQUE**



- POUR RÉDUIRE LE RISQUE DE CHOC ÉLECTRIQUE, N'ENLEVEZ PAS LE COUVERCLE AVANT OU ARRIÈRE
- LISEZ LE MANUEL ET LES PRÉCAUTIONS DE SÉCURITÉ AVANT DE RÉALISER L'INSTALLATION
- ASSUREZ-VOUS QUE LE CORDON D'ALIMENTATION EST BRANCHÉ DANS LE SYSTÈME AVANT DE CONNECTER LE CORDON D'ALIMENTATION À UNE PRISE DE COURANT CA
- RÉDUISSEZ L'ÉNERGIE DU SYSTÈME EN DÉBRANCHANT LE CORDON D'ALIMENTATION DE LA PRISE DE COURANT
- LA PRISE DE COURANT CA DOIT ÊTRE COMPATIBLE AVEC LE CONNECTEUR DE CORDON D'ALIMENTATION À 3 BROCHES

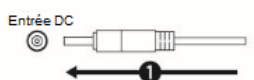

1. Branchez le cordon d'alimentation sur votre système





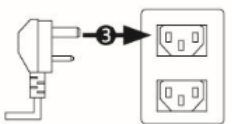







2. Connectez le cordon d'alimentation CA à l'adaptateur secteur









3. Branchez le cordon d'alimentation sur une prise de courant alternatif facilement accessible

17. The product is not used in Category AP or Category APG in an anesthetic gas environment.

## Explanation of Graphical Symbols

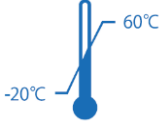
	<p>Warning: dangerous voltage</p>
	<p>Caution</p>
	<p>Note</p>
	<p>ISO 7000-1641: Follow operating instructions or Consult instructions for use.</p>
	<p>Direct current.</p>
	<p>Equipotential</p>
	<p>Stand-by</p>
	<p>US Conformance</p>
	<p>Follow the national requirements for disposal of equipment.</p>
	<p>Stacking layer limit</p>
	<p>This side up</p>

	Fragile Packaging
	Beware of water damage, moisture-proof
	Carton recyclable
	Handle with care
	Storage &Transportation Temperature: -20°C ~ 60°C
	Storage &Transportation Humidity: 10% ~ 95%

## Disposing of your old product

### Within the European Union

EU-wide legislation, as implemented in each Member State, requires that waste electrical and electronic products carrying the mark (left) must be disposed of



separately from normal household waste. This includes monitors and electrical accessories, such as signal cables or power cords. When you need to dispose of your display products, please follow the guidance of your local authority, or ask the shop where you purchased the product, or if applicable, follow any agreements made

between yourself. The mark on electrical and electronic products only applies to the current European Union Member States.



### Federal Communication Commission Interference Statement

**THIS DEVICE COMPLIES WITH PART 15 OF THE FCC RULES. OPERATION IS SUBJECT TO THE FOLLOWING TWO CONDITIONS: (1) THIS DEVICE MAY NOT CAUSE HARMFUL INTERFERENCE AND (2) THIS DEVICE MUST ACCEPT ANY INTERFERENCE RECEIVED, INCLUDING INTERFERENCE THAT MAY CAUSE UNDESIRE OPERATION.**

**Note:** This equipment has been tested and found to comply with the limits for a Class B digital device, pursuant to Part 15 of FCC Rules. These limits are designed to provide reasonable protection against harmful interference in a residential installation. This equipment generates, uses and can radiate radio frequency energy and, if not installed and used in accordance with the instruction, may cause harmful interference to radio communications. However, there is no guarantee that interference will not occur in a particular installation. If this equipment does cause harmful interference to radio or television reception, which can be determined by turning the equipment off and on, the user is encouraged to try to correct the interference by one or more of the following measures:

- Reorient or relocate the receiving antenna.
- Increase the separation between the equipment and receiver.

- **Connect the equipment into an outlet on a circuit different from the one the receiver is connected to.**
- **Consult the dealer or an experienced radio/TV technician for help.**

**Notice:**

- (1) **A Unshielded-type power cord is required in order to meet FCC emission limits and also to prevent interference to the nearby radio and television reception. It is essential that only the supplied power cord be used.**
- (2) **Use only shielded cables to connect I/O devices to this equipment.**
- (3) **Changes or modifications not expressly approved by the party responsible for compliance could void the user's authority to operate the equipment.**

### **FCC RF Radiation Exposure Statement**

**This equipment complies with FCC radiation exposure limits set forth for an uncontrolled environment. This equipment should be installed and operated with minimum distance 20cm between the radiator & your body. For product available in the USA/Canada market, only channel 1~11 can be operated. Selection of other channels is not possible. The antenna(s) used for this transmitter must not be co-located or operating in conjunction with any other antenna or transmitter. Shielded interface cables must be used in order to comply with emission limits.**

## Additional Information and Assistance

Contact your distributor, sales representative for technical support if you need additional assistance. Please have the following information ready before you call:

- Product name and serial number
- Description of your peripheral attachments
- Description of your software (operating system, version, application software, etc.)
- A complete description of the problem
- The exact wording of any error messages
- This equipment is a source of electromagnetic waves. Before use please, make sure that there are not EMI sensitive devices in its surrounding which may malfunction therefore.

### Environmental protection

- Follow national requirements to dispose of unit.

### Manufacturer

Avalue Technology Inc.

7F, No.79, Lide St., Zhonghe District, New Taipei City, 235, Taiwan

TEL: +886-2-8226-2345

FAX: +886-2-8226-2777

Web: [www.avalu.com](http://www.avalu.com)

Information: [sales@avalu.com.tw](mailto:sales@avalu.com.tw)

# CONTENT

<b>1. HID-2340 Multi Touch Medical Panel PC Features .....</b>	<b>17</b>
1.1 Packing List .....	17
1.2 Specifications.....	18
1.3 Front view .....	21
1.4 Rear & Bottom view .....	22
1.6 System Dimensions .....	23
<b>2. Setting Up HID-2340 Multi Touch Panel PCs .....</b>	<b>24</b>
2.1 VESA Mounting .....	25
2.2 Cabling.....	27
2.3 Cleaning and Disinfecting .....	29
<b>3. Using HID-2340 Multi Touch Panel PCs .....</b>	<b>31</b>
3.1. Turn ON/OFF the System .....	32
3.1.1 Turn ON the System .....	32
3.1.2 Turn OFF the System .....	32
3.2 Using LCD Display and Touch Screen .....	33
3.2.1 Adjust System Volume .....	33
3.2.2 Adjust LCD Display Brightness .....	34
3.2.3 LED reading light & Touch function .....	34
<b>4. HID-2340 Installation Figure.....</b>	<b>35</b>
4.1 Desktop Stand installation .....	36
4.2 Barcode Scanner Kit Installation.....	37
4.3 Storage installation .....	38
<b>5. Hardware Configuration .....</b>	<b>39</b>
5.1 HID-2340 Overviews.....	39
5.2 HID-2340 DB-A Overviews .....	40
5.3 HID-2340 DB-B Overviews .....	40
5.4 HID-2340 Jumper and Connector list.....	41
5.5 HID-2340 MB Jumpers & Connectors settings .....	43
5.5.1 Clear CMOS (JRTC1).....	43
5.5.2 LCD backlight brightness adjustment (JSBKL1) .....	43
5.5.3 AT/ATX auto power on select (JAT1) .....	44
5.5.4 M.2 KEY power select (JP1).....	44
5.5.5 Serial port 1/2 pin9 signal select (JRI1/2) .....	45
5.5.6 Serial port 1 – RS232/422/485 mode select (JCOM_SEL1) ...	45
5.5.7 Front Audio connector (JFAUD1) .....	46
5.5.8 On-board header for USB2.0 (JUSB1) .....	46

5.5.9 On-board header for USB2.0 (JUSB2) .....	47
5.5.10 On-board header for USB2.0 (JUSB3) .....	47
5.5.11 Speaker_R (JSPKR1) .....	48
5.5.12 Speaker_L (JSPKL1) .....	48
5.5.13 Power connector (PWR1) .....	49
5.5.14 Battery connector (BT1).....	49
5.5.15 SPI connector (JSPI1) .....	50
5.5.16 EC Debug connector (JEC1) .....	50
5.5.17 LCD Inverter connector (JBKL1).....	51
5.5.18 Reading Light connector (JLED_LIGHT) .....	51
5.5.19 SATA Power connector (SATAPW1) .....	52
5.5.20 Front Panel connector (JFPT1) .....	52
5.5.21 Serial port 1 connector (JCOM1) .....	53
5.5.22 Touch connector (JTP1).....	53
5.5.23 Battery mode connector (JBAT_AUX1) .....	54
5.5.24 Power Button connector (PWR_BTN1).....	54
5.5.25 LVDS/eDP connector (LVDS1) .....	55
5.5.26 B2B connector (JB2B1) .....	56
5.5.27 PC connector (JPC1).....	57
5.6 HID-2340 DB-A Connector list.....	58
5.7 HID-2340 DB-A Connectors settings .....	58
5.7.1 USB connector 1/2 (JUSB1/2) .....	58
5.7.2 COM1 in RS-232/422/485 mode (JCOM1_SEL1) .....	59
5.7.3 Serial port 1 connector (JCOM1) .....	59
5.7.4 B2B connector (B2B1).....	60
5.8 HID-2340 DB-B Connector list.....	61
5.9 HID-2340 DB-B Jumpers & Connectors settings .....	62
5.9.1 Serial port 1 in RS-232/422/485 mode (JCOMSEL1) .....	62
5.9.2 Audio connector (JMIC1) .....	62
5.9.2.1 Signal Description – Audio connector (JMIC1) .....	62
5.9.3 Serial port 1 connector (JCOM1) .....	63
5.9.4 RS-422/RS-485 Termination Resistance connector (JCOMS1)	
.....	63
5.9.5 USB connector 2 (JUSB2).....	64
<b>6. General Safety Guide.....</b>	<b>65</b>



# 1. HID-2340 Multi Touch Medical Panel PC

## Features

---

In this chapter, you will get to know all features of our HID-2340 Multi Touch Medical Panel PC.

### 1.1 Packing List

- 1 x HID-2340 Medical Panel PC
- 1 x Medical power adapter

#### **Power cords:**

- Utilize a UL-listed detachable power cord, 3-wire, type SJ or equivalent, 18 AWG min., rated 250 Vmin., provided with a hospital-grade type plug 5-15P configuration for 120V application, or 6-15P for 240V application.
- Do not overload wall outlets and extension cords as this may result in fire or electric shock.
- Mains lead protection (U.S.: Power cord): Power cords should be routed so that they are not likely to be walked upon or pinched by items placed upon or against them, paying particular attention to cords at plugs and receptacles.
- The power supply cord should be replaced by the designated operator only at all time.
- Use a power cord that matches the voltage of the power outlet, which has been approved and complies with the safety standard of your particular country.

## 1.2 Specifications

<b>Component</b>	
<b>Mother Board</b>	HID-2340 customized MB
<b>CPU</b>	LGA1700 Socket Alder Lake-PS Intel® Core™ i7/i5/i3 Processor (TDP: 15W) I3-1215UL I5-1235UL I7-1265UL
<b>CPU Cooler (Type)</b>	Passive
<b>Memory</b>	One 262-pin DDR5 4800MHz SO-DIMM socket, supports up to 32GB Max (Min 8GB)
<b>Adapter</b>	24V/5A120W Screw Type Medical Adapter
<b>System Fan</b>	Fanless
<b>Speaker</b>	2W x 2
<b>Camera</b>	5.0M Auto Focus CMOS,USB2.0, no mic
<b>Wireless LAN</b>	Optional Wi-Fi + Bluetooth 5.0 USB Module (Intel Wi-Fi 6E AX210)
<b>Expansion Card</b>	1 x M.2 Key B 3042/3052 for 4G/5G 1 x M.2 Key E 2230 support WiFi module 802.11abgn+acR2+axR2 Wi-Fi 6E BT5.2
<b>Storage</b>	
<b>Solid State Drive</b>	1 x 2.5" SSD
<b>Other Storage Device</b>	1 x M.2 Key M 2280 (PCI-e x4) slot for storage
<b>Panel</b>	
<b>LCD Panel</b>	AUO M238HVN01.0
<b>LCD Control Board</b>	Yes
<b>Touch Screen</b>	23.8" P-Cap
<b>Touch Controller</b>	EETI EXC84H5680
<b>External I/O</b>	
<b>Serial Port</b>	1 x COM (RS-232/422/485, selectable by BIOS & JUPMER)
<b>USB Port</b>	3 x USB Gen2X1 1 x USB 2.0 1 x USB Type C (Output for USB 3.1 & Display, 5V/3A 15W, No power receiving function)

<b>Audio Port</b>	Combo Jack
<b>LAN Port</b>	2 x LAN (1 x Intel® I225LM, 1 x I226LM 2.5 Gigabit Ethernet)
<b>Wireless LAN</b>	Intel Wi-Fi 6E AX210
<b>Wireless LAN Antenna</b>	2 x PCB Antenna
<b>Indicator Light</b>	HDD LED, Power LED (Green for Power, Yellow for HDD)
<b>Expansion Slots</b>	IET expansion
<b>Mechanical</b>	
<b>Power Type</b>	ATX (Default)
<b>Power Connector Type</b>	Lockable DC Jack (w/o battery: DC in 24V)
<b>Dimension</b>	592 x 382 x 49.5mm
<b>Weight</b>	6 kg
<b>Color</b>	White Plastic
<b>Fanless</b>	Yes
<b>OS Support</b>	Win10 64bit, Linux
<b>Reliability</b>	
<b>Dust and Rain Test</b>	Front IP65, Back IP54
<b>Vibration Test</b>	<p>Random Vibration Operation Reference IEC60068-2-64 Testing procedures Test Fh : Vibration broadband random Test 1 Test PSD : 0.00454G<sup>2</sup>/Hz , 1.5 Grms 2 Test frequency : 5~500 Hz 3 Test axis : X,Y and Z axis 4 Test time : 30 minutes each axis 5 System condition : operation mode 6 Test curve</p> <p>Sine Vibration Test Reference IEC60068-2-6 Testing procedures Test Fc : Vibration sinusoidal 1 Test Acceleration : 2G 2 Test frequency : 5~500 Hz 3 Sweep : 1 Oct/ per one minute. (logarithmic) 4 Test axis : X,Y and Z axis 5 Test time :30 min. each axis 6 System condition : Non-Operating mode 7 Test curve</p> <p>Package Vibration Test: Reference IEC60068-2-64 Testing procedures</p>

	<p>Test Fh : Vibration boardband random Test</p> <p>1 Test PSD : 0.026G<sup>2</sup>/Hz , 2.16 Grms</p> <p>2 Test frequency : 5~500 Hz</p> <p>3 Test axis : X,Y and Z axis</p> <p>4 Test time : 30 minutes each axis</p> <p>5 Test curve</p>
<b>Mechanical Shock Test</b>	With CF/SSD: 10Grms, IEC 60068-2-27, Half Sine, 11ms
<b>Operating Temperature</b>	0°C ~ 40°C (32°F ~ 104°F)
<b>Operating Humidity</b>	40°C @ 95% Relative Humidity, Non-condensing
<b>Storage Temperature</b>	-10°C ~ 60°C (14°F ~ 140°F)



**Note:** Specifications are subject to change without notice.

### 1.3 Front view

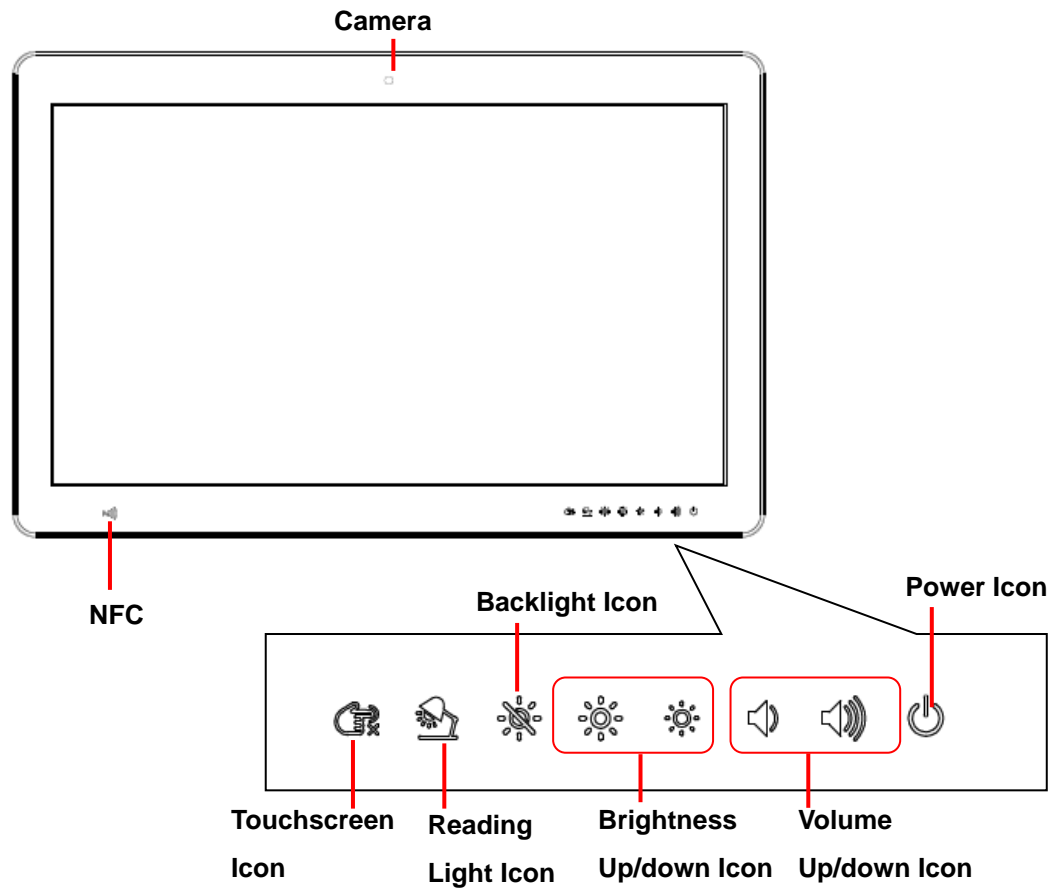

## 1.4 Rear & Bottom view

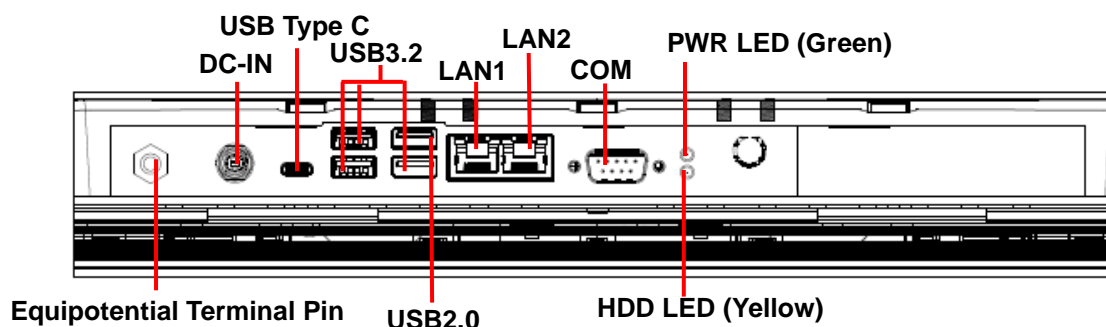

I/O port functions description:

Equipotential Terminal Pin: for connect hospital ground/earth

DC-IN: for Power adapter DC jack

USB Type C: USB Type C connector (Output for USB 3.1 & Display)

USB: 3 x USB3.2 Gen2, 1 x USB 2.0

LAN1/2: for internet connection (Using a shielded LAN cable is advised for compliance with the EN55032 and IEC61000-4-6 standards.)

COM: for Mouse/Ethernet..etc serial port device

HDD LED: indicate HDD activities status

PWR LED: indicate power status

**Note!** Equipotential terminal needs to be linked to the hospital ground/earth system before booting the system to protect both operator and system.



## 1.6 System Dimensions

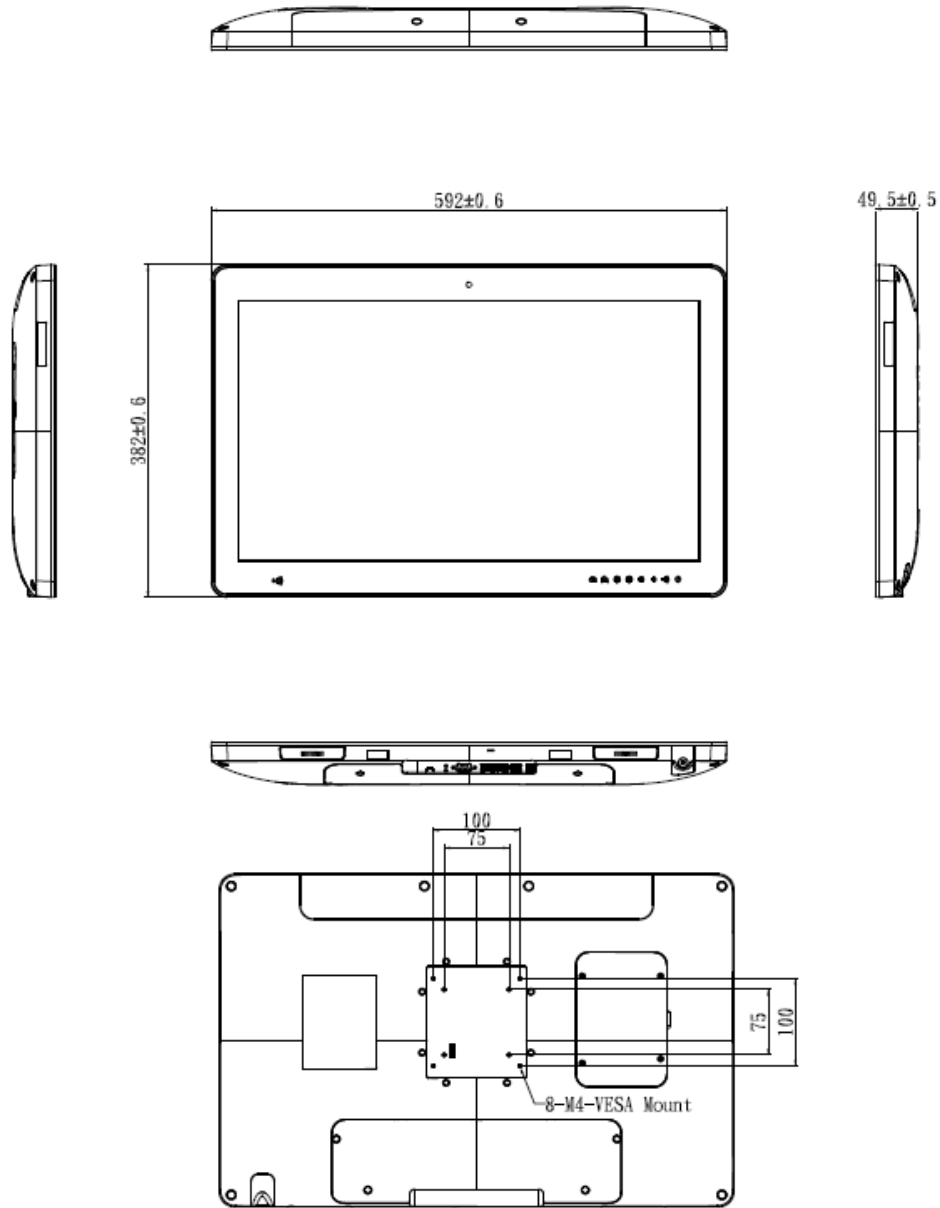

(Unit: mm)

## **2. Setting Up HID-2340 Multi Touch Panel PCs**

---

This chapter gives instructions on how to set up HID-2340 Multi Touch Panel PC and how to connect different cables.

2.1 VESA Mounting

2.2 Cleaning and Disinfecting



## 2.1 VESA Mounting

The HID-2340 also provides standard VESA mounting to help system integrators

conveniently integrate the panel PC into their system.

Never use mounting brackets except as provided by Avalue to prevent unreliable mounting of the HID-2340. VESA mount installation should be carried out by a professional technician; please contact a service technician or your retailer if you need this service.

Installation instructions follow:

1. First attach the wall-mounting to the heat-sink of the HID-2340, securing it in place with four of the M4 x 6mm screws provided.
2. Mount the on the wall, stand or other flat surface.

**Warning!** *Be sure to secure the screws of the mounting bracket tightly. A loose joint between the HID-2340 and mounting bracket may create danger of injury.*



**Attention!** *Assurez-vous de bien serrer les vis du support de montage. Un joint lâche entre le HID-2340 et le support de montage peut créer un risque de blessure.*

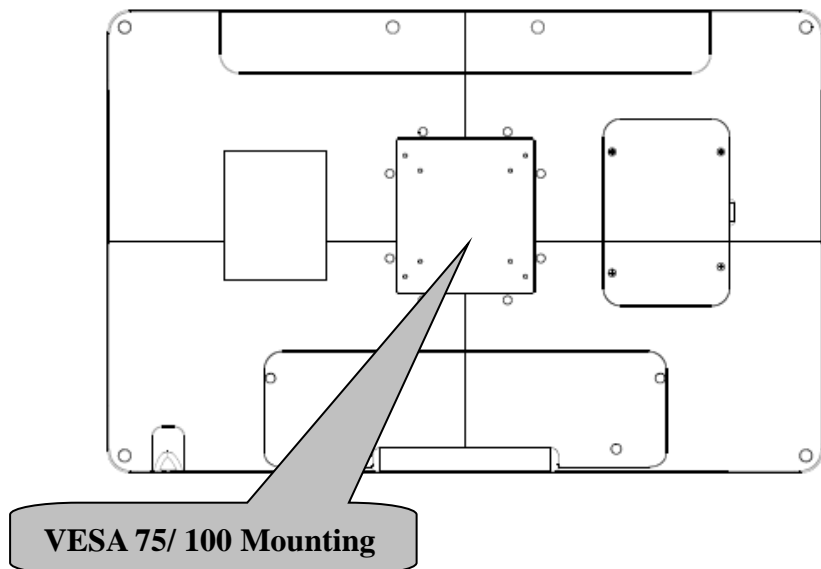

Suggested Screw type for mounting

**Note:** 4 pieces of M4 x 8mm~10mm screws

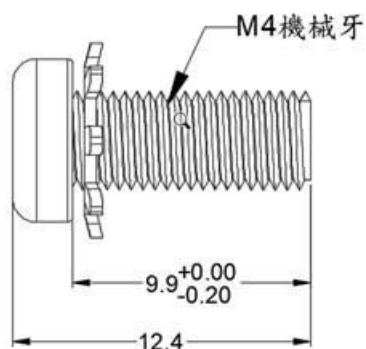
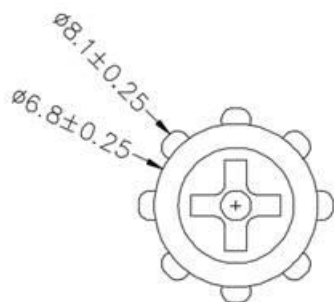
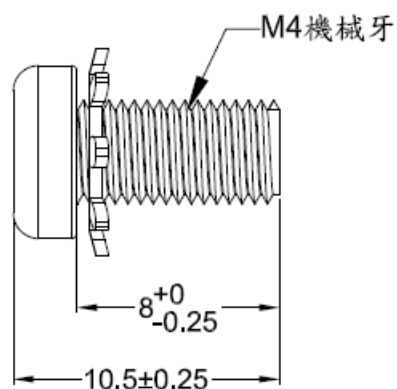
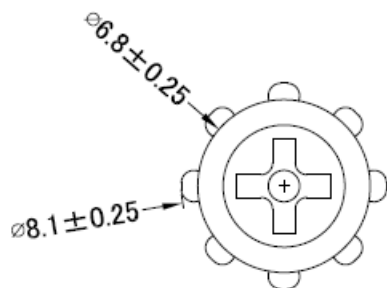

**Warning!** Use suitable mounting apparatus to avoid risk of injury.



**Attention!** Utilisez un appareil de montage approprié pour éviter tout risque de blessure.



## 2.2 Cabling

1. Power Cable
2. Equipotential Terminal Pin

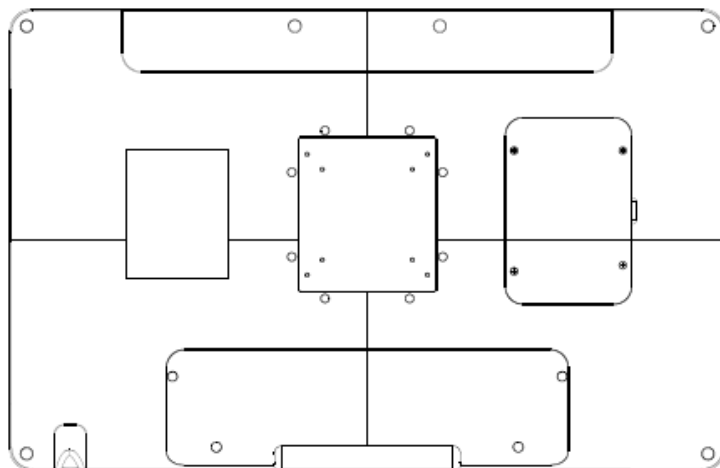

**Equipotential  
Terminal Pin**

**Power Jack**

**LAN**

Follow below step Connecting the Ground pin

1. With system ready, find the equipotential terminal on the rear side of the HID-2340. An equipotential terminal is provided to optionally connect to a hospital ground/earth system.
2. Prepare grounding cable and the other terminal links to the hospital ground/earth system.
3. Grounding cable plug with Equipotential Terminal

Please use shielded LAN cables for compliance with the EN55032 and IEC61000-4-6 standards.

Please follow below steps to connect power cable to system.

The HID-2340 could only be powered by a DC power adapter (EDAC Model no. EM11011M(18)). Be sure to always handle the power cords by holding the plug ends only.

Follow these procedures in order:

1. Connect the female end of the power adapter to the DC jack of the panel PC.
2. Connect the female end of the power cord to the DC power adapter.
3. Connect the 3-pin male plug of the power cord to an electrical outlet.

External equipment intended for connection to signal input/output or other connectors, shall comply with relevant UL standards (e.g. UL 60950-1 for IT equipment and ANSI/AAMI ES60601-1/ IEC 60601-1 series for medical electrical equipment)



## WARNING



RISK OF ELECTRIC SHOCK

- TO REDUCE THE RISK OF ELECTRIC SHOCK, DO NOT REMOVE FRONT OR BACK COVER.
- READ THE MANUAL AND SAFETY PRECAUTIONS BEFORE PERFORMING INSTALLATION.
- MAKE SURE THE POWER CORD IS PLUGGED INTO THE SYSTEM BEFORE CONNECTING THE POWER CORD TO AN AC POWER OUTLET.
- DISCOUNT POWER FROM THE SYSTEM BY UNPLUGGING THE POWER CORD FROM AC OUTLET.
- THE AC POWER OUTLET SHOULD BE COMPATIBLE WITH THE 3-PIN POWER CORD CONNECTOR.



1. Plug the power cord into your system



2. Connect AC power cord to the power adapter.

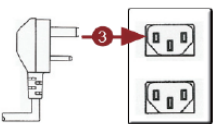

3. Plug the power cord into an easily accessible AC power outlet.



## Attention!



RISQUE DE CHOC ELECTRIQUE

- POUR RÉDUIRE LE RISQUE DE CHOC ÉLECTRIQUE, N'ENLEVEZ PAS LE COUVERCLE AVANT OU ARRIÈRE
- LISEZ LE MANUEL ET LES PRÉCAUTIONS DE SÉCURITÉ AVANT DE RÉALISER L'INSTALLATION
- ASSUREZ-VOUS QUE LE CORDON D'ALIMENTATION EST BRANCHÉ DANS LE SYSTÈME AVANT DE CONNECTER LE CORDON D'ALIMENTATION À UNE PRISE DE COURANT CA
- RÉDUISEZ L'ÉNERGIE DU SYSTÈME EN DÉBRANCHANT LE CORDON D'ALIMENTATION DE LA PRISE DE COURANT
- LA PRISE DE COURANT CA DOIT ÊTRE COMPATIBLE AVEC LE CONNECTEUR DE CORDON D'ALIMENTATION À 3 BROCHES



1. Branchez le cordon d'alimentation sur votre système



2. Connectez le cordon d'alimentation CA à l'adaptateur secteur

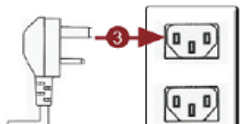

3. Branchez le cordon d'alimentation sur une prise de courant alternatif facilement accessible

## 2.3 Cleaning and Disinfecting

During normal use of HID-2340, the device may become dirty and should be regularly cleaned.

### Cleaning Instructions

1. Turn off the computer before starting clean up. This way, you can see any dirt on the screen; the brightness of the monitor may make you miss some areas.
2. Wet a soft, lint-free or microfiber cloth with cleaning agent per manufacturer's instructions or hospital protocol. Wipe the medical PC in a gentle motion to remove dust, oil, or fingerprint smudges.
3. Wipe any moisture excess with a dry lint-free cloth to finish cleaning before turning the computer back on.

### Cleaning Tools

Below is a list of some items that may be needed or used when cleaning the medical PC or medical PC peripherals.

Please keep in mind that some components in medical PC components may only be cleaned using a product designed for cleaning that component.

Cleaning agent list: chemical disinfectants which have been tested on the medical PC

No.	Cleaning agent
1	Acetic Acid
2	Acetone
3	Alcohol
4	Alcohol 70%
5	Ammonia
6	Artificial Perspiration (JIS K6772)
7	Boil Water
8	Caustic Soda
9	Cidex
10	Cold Cream Applied
11	Detergent (Kao Mypet) Applied
12	Ethanol

13	Gasoline
14	Glycerine
15	Green tinctured soap
16	Hydrochloric Acid
17	Incidin liquid
18	Incidin plus
19	Isopropyl alcohol
20	Kerosene
21	Lanoline Applied
22	Methanol
23	Mikrozyd liquid
24	Nitric Acid
25	Paraffin Oil
26	Propanol
27	Solution of salt
28	Sulfuric Acid
29	Toluene
30	Vaseline Applied
31	Virkon and water (1:100)
32	Windex

---

**Caution!**



- *Do not immerse or rinse the HID-2340 or its peripherals. If you accidentally spill liquid on the device, disconnect the unit from the power source. Contact your Biomed Department regarding the continued safety of the unit before placing it back in operation.*
- *Do not spray cleaning agent on the chassis.*
- *Do not use disinfectants that contain phenol. Do not autoclave or clean the HID-2340 or its peripherals with strong aromatic, chlorinated, ketone, ether, or Esther solvents, sharp tools or abrasives. Never immerse electrical connectors in water or other liquids.*

## 3. Using HID-2340 Multi Touch Panel PCs

---

This chapter describes in detail all features of HID-2340 Multi Touch Panel PC.

3.1 Turn ON/OFF the System

3.2 Using LCD Display and Touch Screen

### 3.1. Turn ON/OFF the System

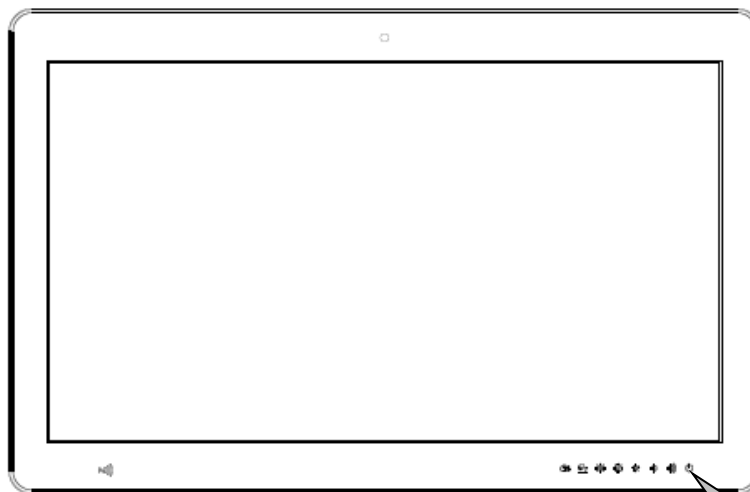

**ON/OFF Touch Button**

#### 3.1.1 Turn ON the System

1. Check if the Power ON/OFF LED light is Orange.
2. Press the Power ON/OFF icon firmly to turn power ON/OFF
3. The Power ON/OFF LED will turn green to indicate power is on.

#### 3.1.2 Turn OFF the System

1. Press on the Power ON/OFF icon firmly for 4 seconds.
2. The Power ON/OFF LED will turns orange to indicate power is off.
3. Your system is turned OFF.

**Note:** We recommend using operating system shut down procedure to turn the system OFF.



### 3.2 Using LCD Display and Touch Screen

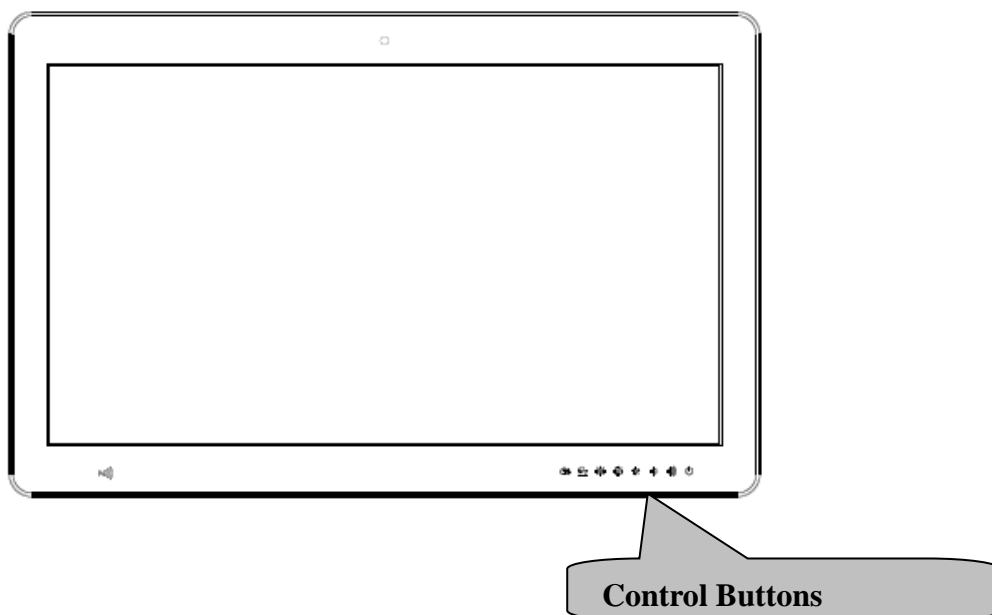

#### 3.2.1 Power On / Off



User Behavior	Power Icon Status
Connect the adapter to the terminal with power cord plugged into a power outlet	Power icon shows solid orange
Short press power icon to turn on the terminal	Power icon shows solid blue
Long press power icon for 4 seconds while system is operating	Terminal is forced shutdown Power icon shows solid orange

#### 3.2.2 Volume Control



User Behavior	Volume Status
Short press volume up icon	Volume level being turned up
Short press volume down icon	Volume level being turned down

### 3.2.3 Brightness Control



User Behavior	Brightness Status
Short press brightness up icon	Brightness level being turned up
Short press brightness down icon	Brightness level being turned down

### 3.2.4 Backlight On / Backlight Off



User Behavior	Backlight & Touchscreen Status
Long press backlight icon for 3 seconds when backlight is on	Backlight is turned off. Touchscreen is locked simultaneously. Touchscreen icon shows solid blue light.
Long press backlight icon for 3 seconds when backlight is off	Backlight is turned on. Brightness level automatically return to the value before backlight was off. Touchscreen remains locked.
Long press touchscreen icon 3 seconds when backlight is off	Touchscreen is unlocked. Backlight is turned on simultaneously. Brightness level automatically return to the value before backlight was off.

### 3.2.5 LED reading light & Touch function



User Behavior	Reading Lights Status
Short press reading light icon	Reading lights are on at the bottom of the terminal
Short pressed reading light icon again	Reading lights are off at the bottom of the terminal

## 4. HID-2340 Installation Figure

---

In this chapter, you will learn how to install storage into HID-2340. Please perform these steps with care.

▲ **WARNING:** Turn OFF the system and disconnect the power cable before performing the following tasks.

▲ **CAUTION:** Only a certified service technician is authorized to remove the cover and access system components.

## 4.1 Desktop Stand installation

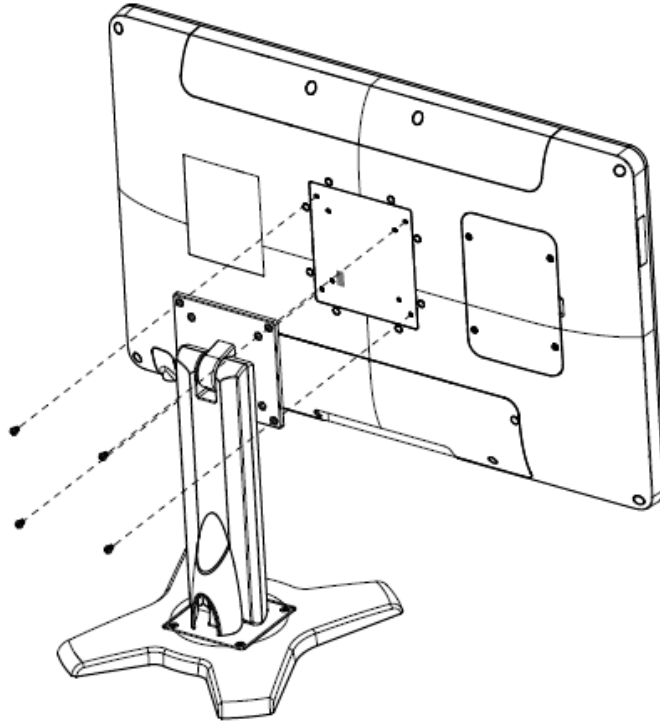

**Step1.** Position VESA Mount on both sides, matching the holes on the system.

**Step2.** Insert and fasten 4 screws on each side of the monitor to secure Mounting brackets.

## 4.2 Barcode Scanner Kit Installation

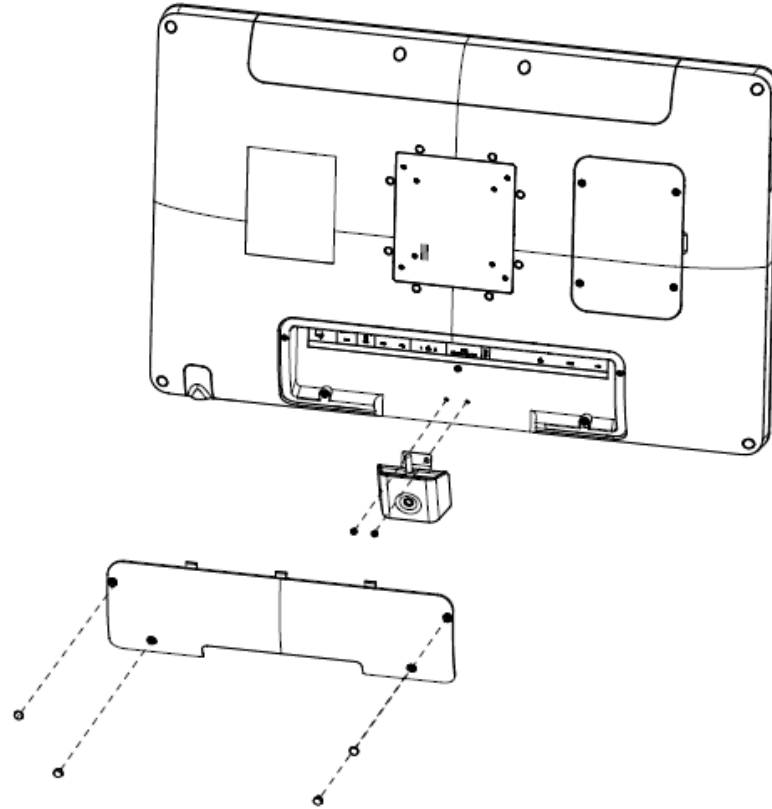

**Step1.** Remove the I/O cover.

**Step2.** Install the barcode scanner kit bracket with two screws as indicated.

**Step3.** Re-install the I/O cover.

### 4.3 Storage installation

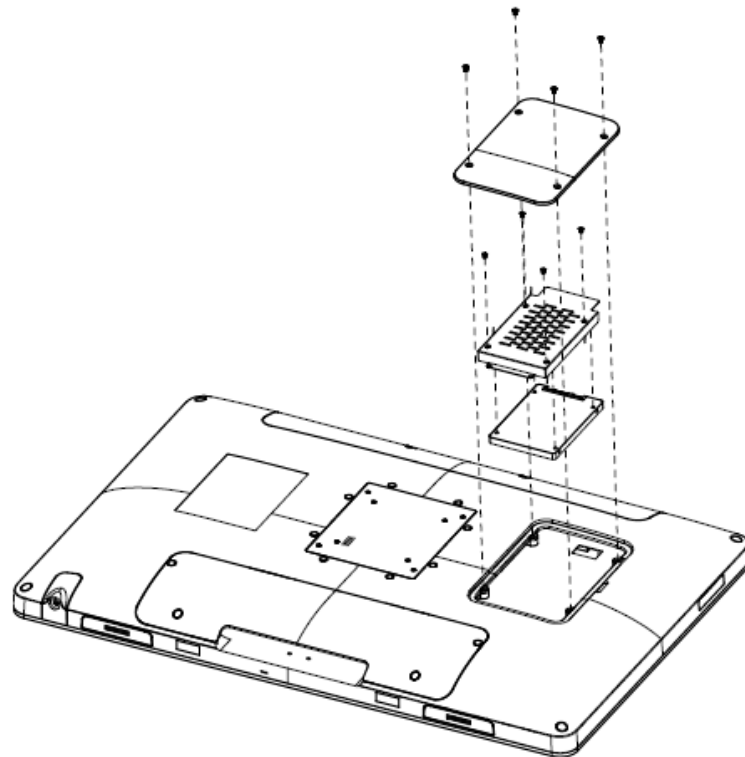

**Step1.** Remove 4 screws to release the chassis cover and remove it.

**Step2.** Insert the HDD back and fasten 4 screws.

## 5. Hardware Configuration

### 5.1 HID-2340 Overviews

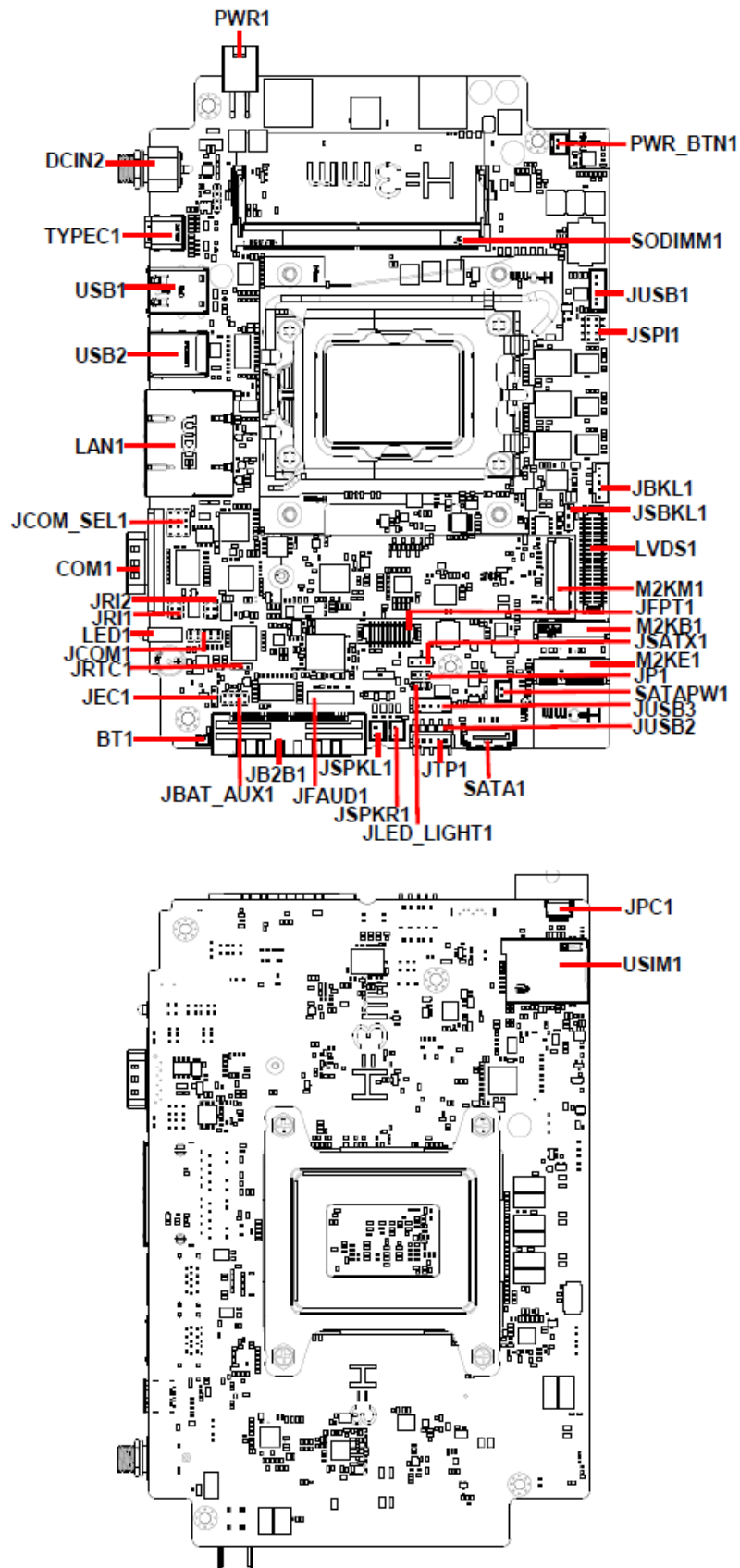

## 5.2 HID-2340 DB-A Overviews

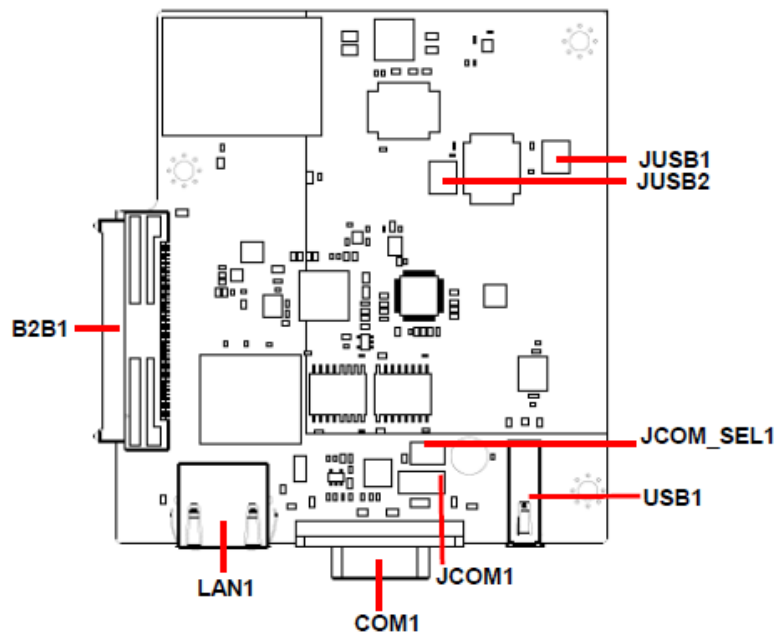

## 5.3 HID-2340 DB-B Overviews

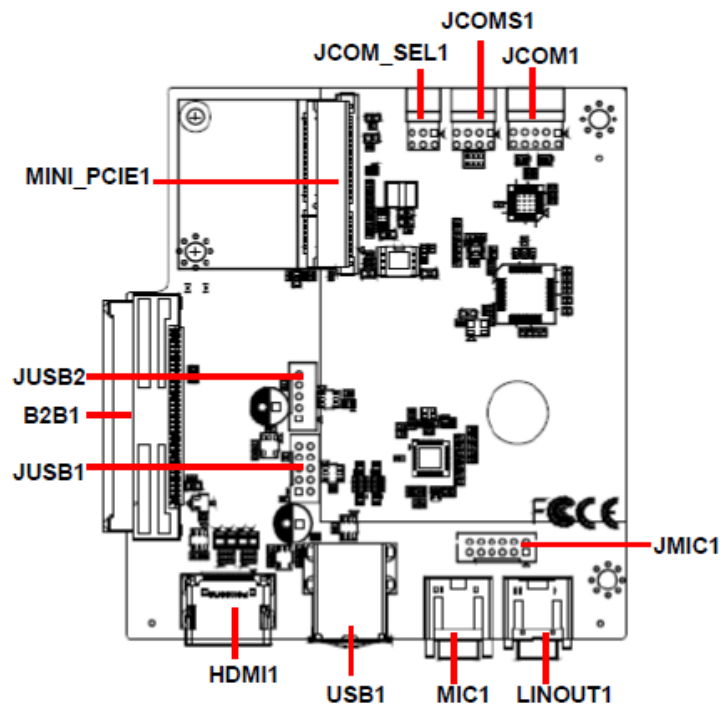



## 5.4 HID-2340 Jumper and Connector list

<b>Jumpers</b>		
<b>Label</b>	<b>Function</b>	<b>Note</b>
<b>JRTC1</b>	Clear CMOS	3 x 1 header, pitch 2.00 mm
<b>JSBKL1</b>	LCD backlight brightness adjustment	3 x 1 header, pitch 2.54 mm
<b>JSATX1</b>	AT/ATX auto power on select	3 x 1 header, pitch 2.54 mm
<b>JRI1/2</b>	Serial port 1/2 pin9 signal select	3 x 2 header, pitch 2.00 mm
<b>JCOM_SEL1</b>	Serial port 1 – RS232/422/485 mode select	4 x 3 header, pitch 2.00 mm
<b>JP1</b>	M.2 KEY power select	3 x 1 header, pitch 2.00 mm
<b>Connectors</b>		
<b>Label</b>	<b>Function</b>	<b>Note</b>
<b>SODIMM1</b>	262-Pin DDR5 4800MHz SO-DIMM	
<b>COM1</b>	Serial port 1 connector	
<b>JCOM1</b>	Serial port 1 connector	5 x 2 header, pitch 2.00 mm
<b>JSPKR1</b>	Speaker_R	2 x 1 wafer, pitch 2.00 mm
<b>JSPKL1</b>	Speaker_L	2 x 1 wafer, pitch 2.00 mm
<b>JTP1</b>	Touch connector	5 x 1 header, pitch 2.54 mm
<b>JBKL1</b>	LCD inverter connector	5 x 1 wafer, pitch 2.00 mm Matching Connector: JST PHR-5
<b>JB2B1</b>	B2B connector	40 x 2 wafer, pitch 0.80mm
<b>LVDS1</b>	LVDS/eDP connector	20 x 2 wafer, pitch 1.25 mm Matching Connector: Hirose DF13-40DS-1.25C
<b>JFPT1</b>	Front Panel connector	10 x 2 wafer, pitch 1.25 mm
<b>PWR_BTN1</b>	Power Button connector	2 x 1 wafer, pitch 2.00 mm
<b>USB1/2</b>	3 x USB3.2 Gen2 connector 1 x USB2.0 connector	
<b>JUSB1</b>	On-board header for USB2.0	5 x 1 wafer, pitch 2.00 mm
<b>JUSB2</b>	On-board header for USB2.0	5 x 1 wafer, pitch 2.00 mm
<b>JUSB3</b>	On-board header for USB2.0	5 x 1 wafer, pitch 2.00 mm

<b>TYPEC1</b>	USB Type C connector	
<b>LED1</b>	HDD/Power LED indicator	
<b>LAN1</b>	2 x RJ-45 Ethernet	
<b>BT1</b>	Battery connector	2 x 1 wafer, pitch 1.25 mm
<b>M2KM1</b>	M.2 Key M slot	
<b>M2KB1</b>	M.2 Key B slot	
<b>M2KE1</b>	M.2 Key E slot	
<b>PWR1</b>	Power connector	2 x 2 wafer, pitch 4.20 mm
<b>DCIN2</b>	DC power-in connector	
<b>JSPI1</b>	SPI connector	4 x 2 header, pitch 2.00 mm
<b>JEC1</b>	EC Debug connector	3 x 1 header, pitch 2.00 mm
<b>SATA1</b>	Serial ATA connector	
<b>SATAPW1</b>	SATA Power connector	2 x 1 wafer, pitch 2.00 mm
<b>JLED_LIGHT1</b>	Reading Light connector	3 x 1 header, pitch 2.00 mm
<b>JBAT_AUX1</b>	Battery mode connector	4 x 2 header, pitch 2.00 mm
<b>JFAUD1</b>	Front Audio connector	6 x 2 header, pitch 2.00 mm
<b>USIM1</b>	SIM card slot	
<b>JPC1</b>	PC connector	6 x 1 wafer, pitch 1.00 mm

## 5.5 HID-2340 MB Jumpers & Connectors settings

### 5.5.1 Clear CMOS (JRTC1)

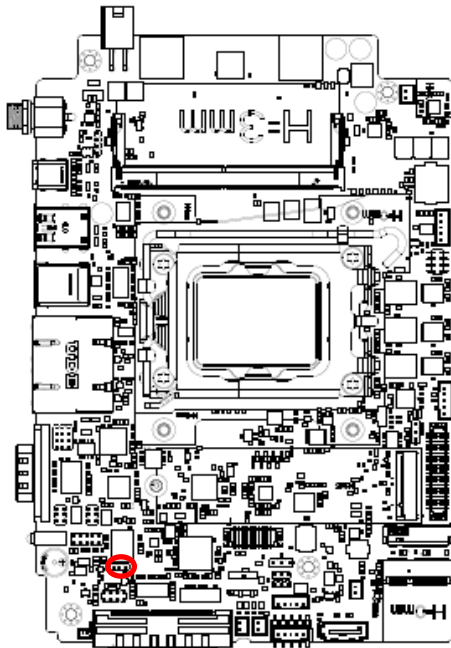

Protect\*

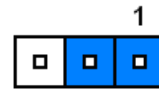

Clear CMOS

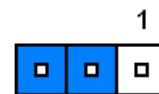

\*Default

### 5.5.2 LCD backlight brightness adjustment (JSBKL1)

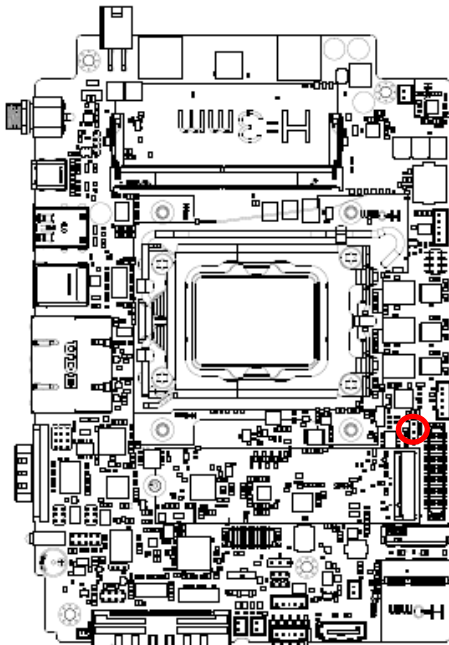

PWM Mode\*

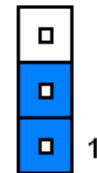

DC Mode

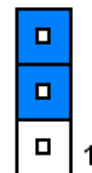

\* Default

### 5.5.3 AT/ATX auto power on select (JAT1)

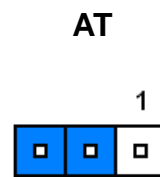
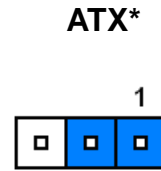
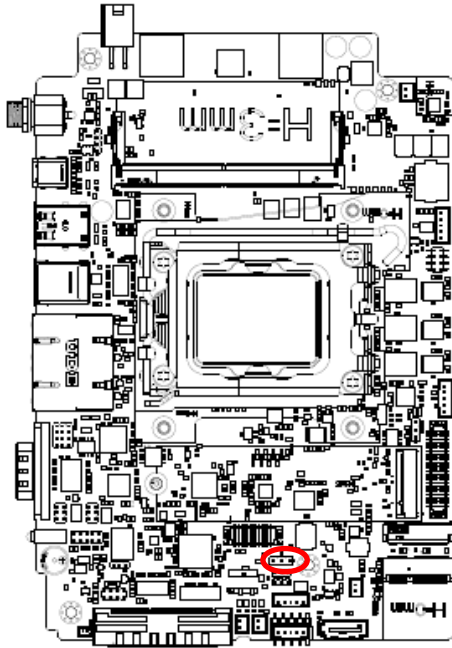

\* Default

### 5.5.4 M.2 KEY power select (JP1)

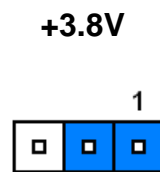
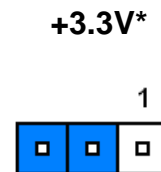
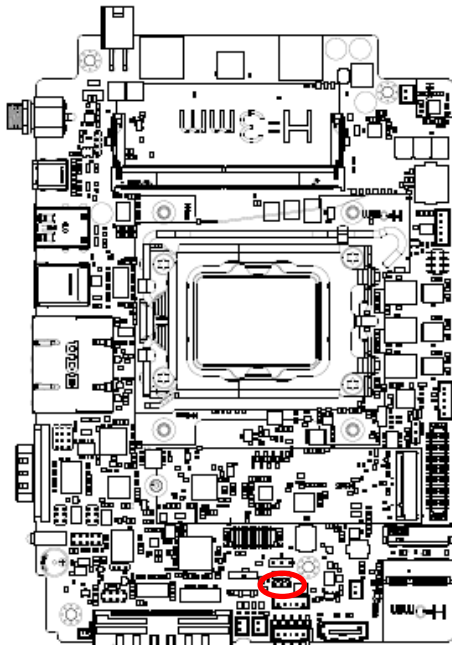

\* Default

### 5.5.5 Serial port 1/2 pin9 signal select (JRI1/2)

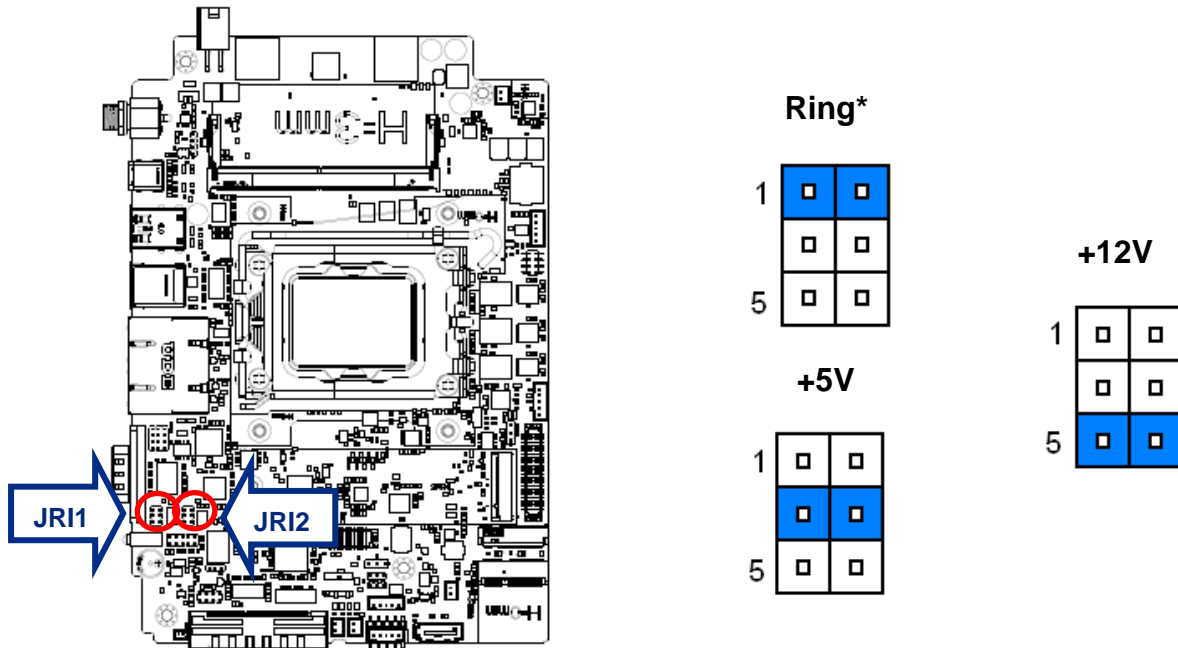

\* Default

### 5.5.6 Serial port 1 – RS232/422/485 mode select (JCOM\_SEL1)

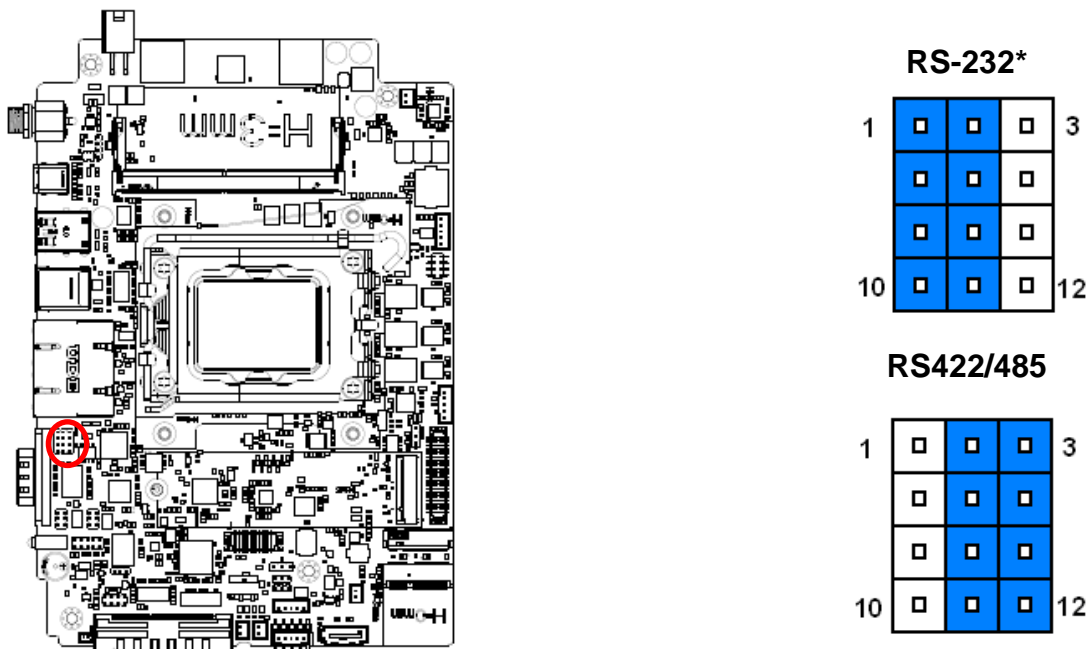

\* Default

### 5.5.7 Front Audio connector (JFAUD1)

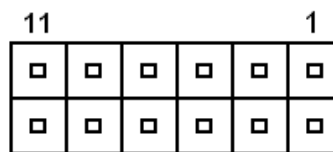
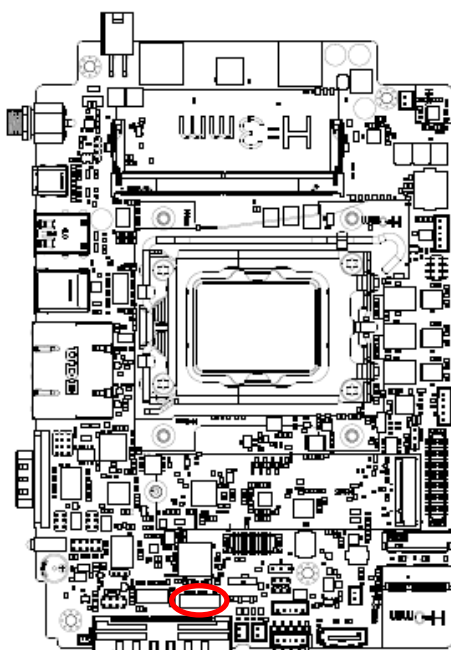

Signal	PIN	PIN	Signal
LINEOUT_R	1	2	LINEOUT_L
GND	3	4	GND
LINEIN_R	5	6	LINEIN_L
MICIN_R	7	8	MICIN_L
LINEOUT1_JD	9	10	LINE1-JD
MIC1_JD	11	12	GND

#### 5.5.7.1 Signal Description –Front Audio connector (JFAUD1)

Signal	Signal Description
LINE1-JD	AUDIO IN (LINE_RIN/LIN) sense pin
MIC1-JD	MIC IN (MIC_RIN/LIN) sense pin

### 5.5.8 On-board header for USB2.0 (JUSB1)

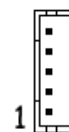
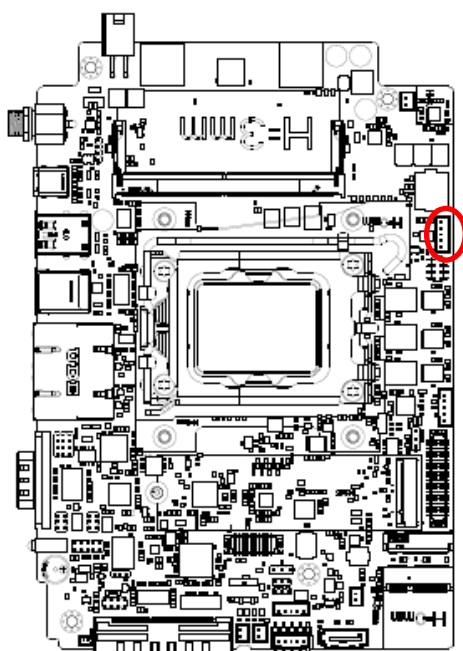

Signal	PIN
GND	5
GND	4
USB2_R_DP5	3
USB2_R_DN5	2
+5VSB	1

### 5.5.9 On-board header for USB2.0 (JUSB2)

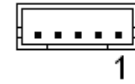
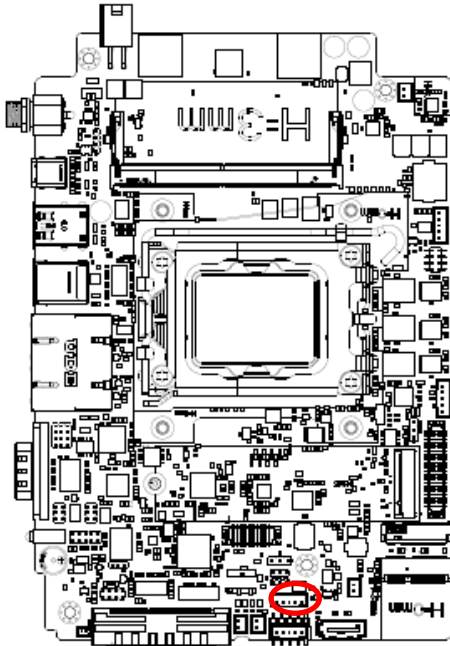

Signal	PIN
+5VSB	1
HUB1_USB1_R_N	2
HUB1_USB1_R_P	3
GND	4
GND	5

### 5.5.10 On-board header for USB2.0 (JUSB3)

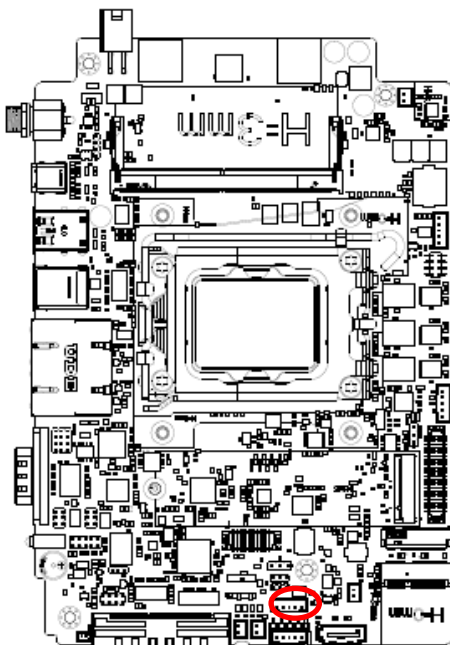

Signal	PIN
+5VSB	1
HUB1_USB3_R_N	2
HUB1_USB3_R_P	3
GND	4
GND	5

### 5.5.11 Speaker\_R (JSPKR1)

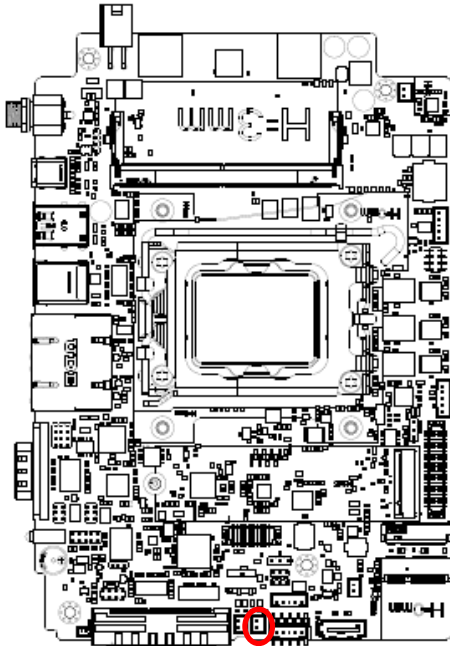

Signal	PIN
SPK_R-	2
SPK_R+	1

### 5.5.12 Speaker\_L (JSPKL1)

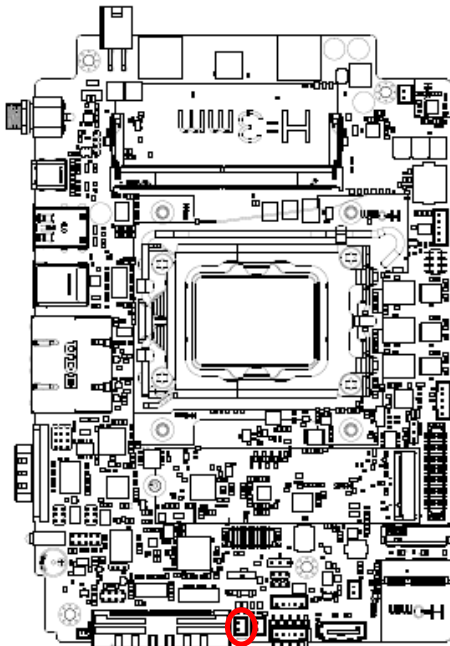

Signal	PIN
SPK_L-	2
SPK_L+	1



### 5.5.13 Power connector (PWR1)

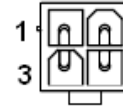
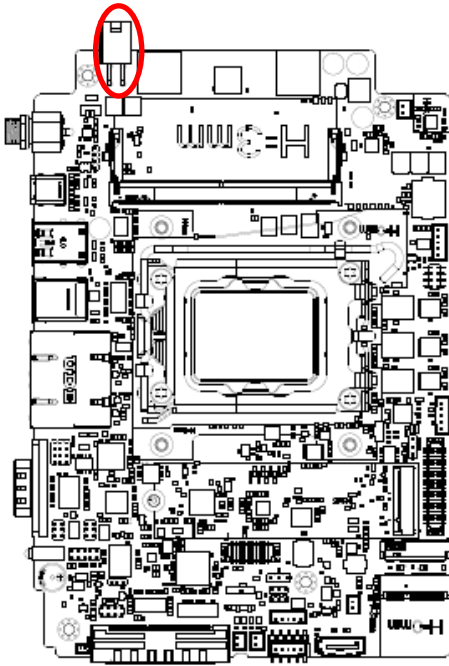

Signal	PIN	PIN	Signal
GND	1	2	GND
+VIN_12-24V	3	4	+VIN_12-24V

### 5.5.14 Battery connector (BT1)

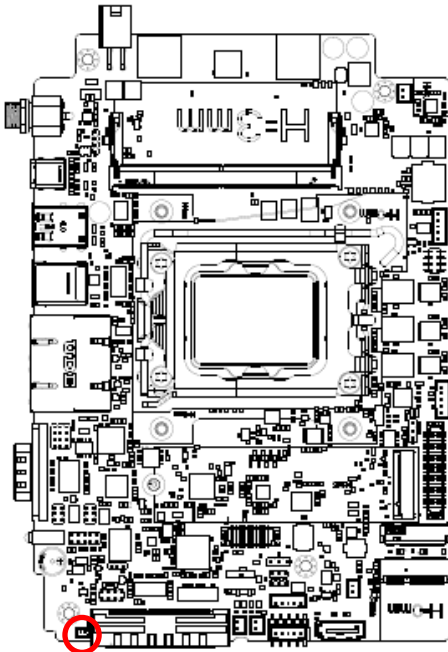

Signal	PIN
+RTCBATT	1
GND	2

### 5.5.15 SPI connector (JSPI1)

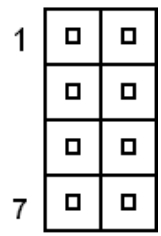
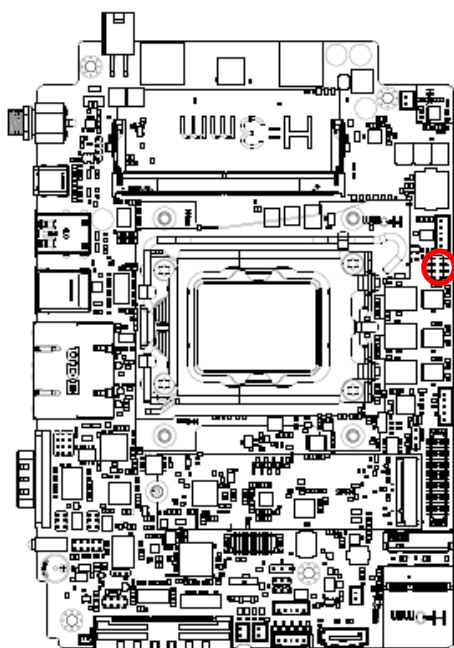

Signal	PIN	PIN	Signal
+3.3VSB	1	2	+3.3VSB
SPI0_CS0#	3	4	SPI0_BIOS_CLK
SPI0_BIOS_MISO	5	6	SPI0_BIOS_MOSI
SPI0_HOLD#	7	8	BIOS_WP#

### 5.5.16 EC Debug connector (JEC1)

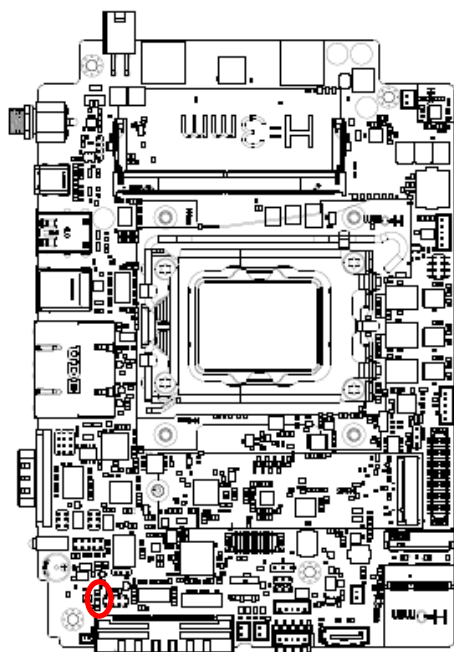

Signal	PIN
GND	3
EC_SMCLK_DEBUG	2
EC_SMDAT_DEBUG	1

### 5.5.17 LCD Inverter connector (JBKL1)

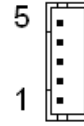
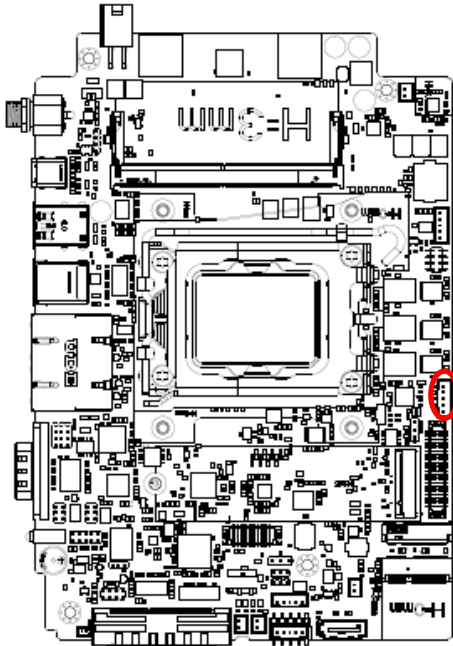

Signal	PIN
+5V	5
LVDS_BKLADJ	4
LVDS_BKLT_EN	3
GND	2
+12V	1

### 5.5.18 Reading Light connector (JLED\_LIGHT)

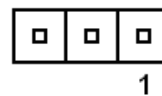
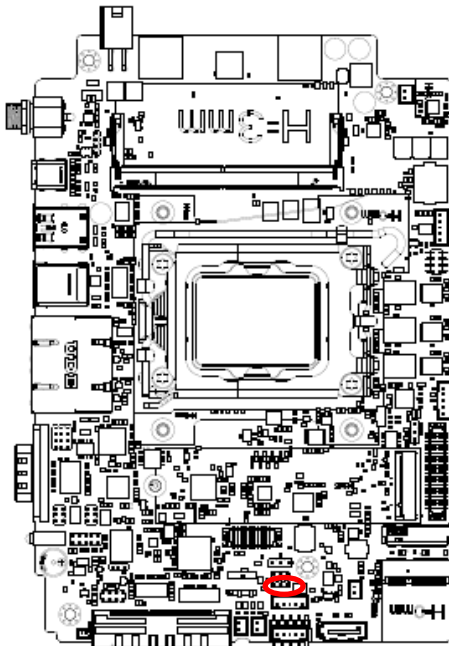

Signal	PIN
+5VSB	1
READ_LIGHT_EN	2
GND	3

### 5.5.19 SATA Power connector (SATAPW1)

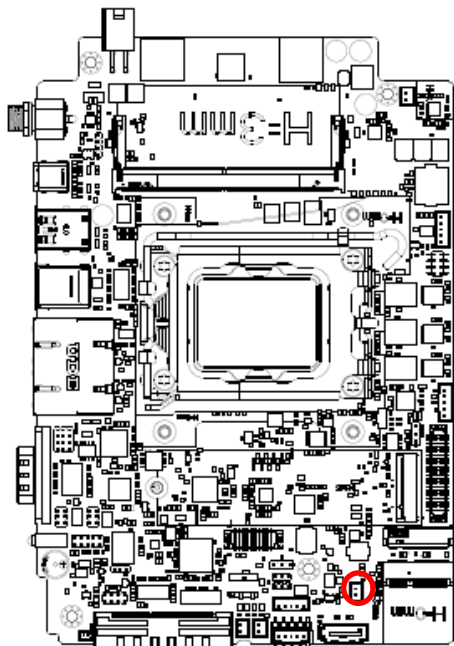

Signal	PIN
+5V	2
GND	1

### 5.5.20 Front Panel connector (JFPT1)

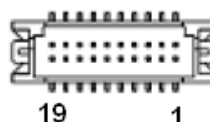
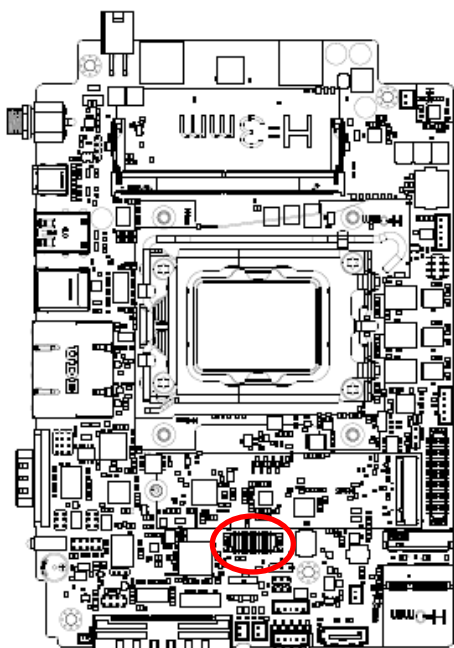

Signal	PIN	PIN	Signal
+3.3V	1	2	GND
BKL_ON_OFF	3	4	BLK_BRI_UP#
READ_LIGHT	5	6	BLK_BRI_DN#
BATTERY_1_O#	7	8	VOLUME_UP
BATTERY_1_B#	9	10	VOLUME_DN
BATTERY_2_O#	11	12	TOUCH_ON_OFF
BATTERY_2_B#	13	14	EXT_PWRBTN#
TOUCH_OFF_LED#	15	16	PWR_LED-
PCH_I2C4_SCL/EC_SMCLK1	17	18	PS_ON#
PCH_I2C4_SDA/EC_SMDAT1	19	20	+5VSB

### 5.5.21 Serial port 1 connector (JCOM1)

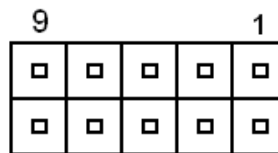
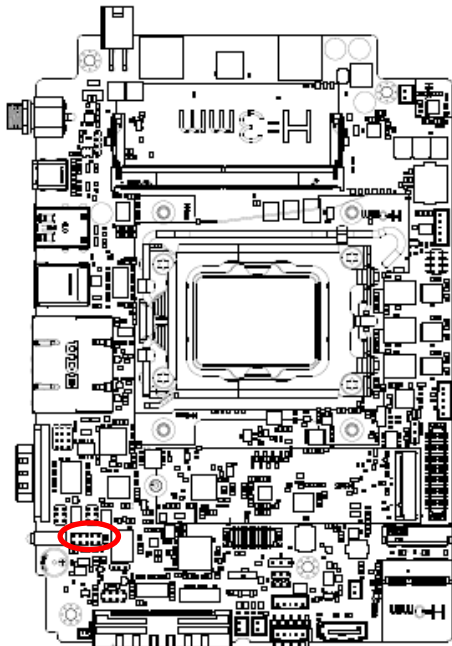

Signal	PIN	PIN	Signal
COM_DCD#_2	1	2	COM_RXD_2
COM_TXD_2	3	4	COM_DTR#_2
GND	5	6	COM_DSR#_2
COM_RTS#_2	7	8	COM_CTS#_2
COM_RI#_2	9	10	NC

### 5.5.22 Touch connector (JTP1)

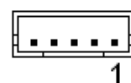
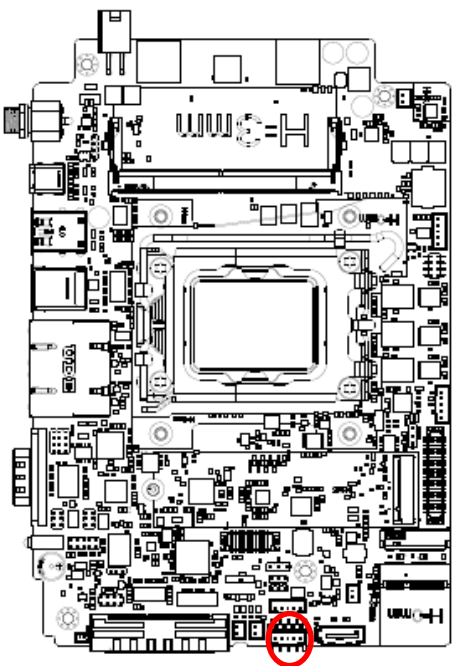

Signal	PIN
X+	1
X-	2
SENSE	3
Y+	4
Y-	5

### 5.5.23 Battery mode connector (JBAT\_AUX1)

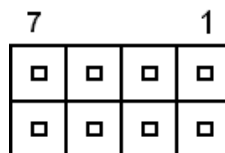
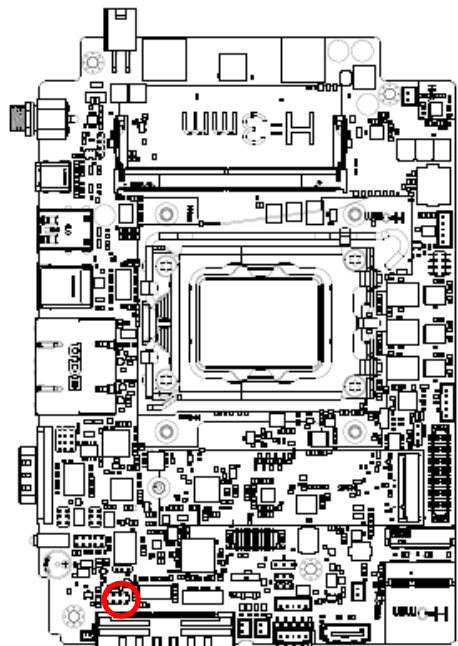

Signal	PIN	PIN	Signal
EC_SMCLK5	1	2	DB_AC_SENCE
EC_SMDAT5	3	4	BAT1_PRSNNT
+3.3VSB	5	6	BAT2_PRSNNT
GND	7	8	CHARGER_DISABLE

### 5.5.24 Power Button connector (PWR\_BTN1)

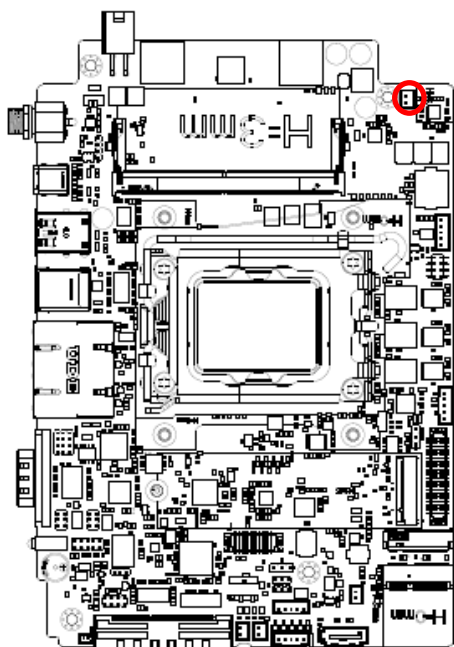

Signal	PIN
GND	2
EXT_PWRBTN#	1

### 5.5.25 LVDS/eDP connector (LVDS1)

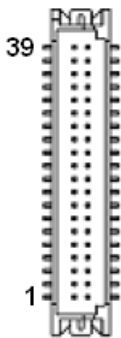
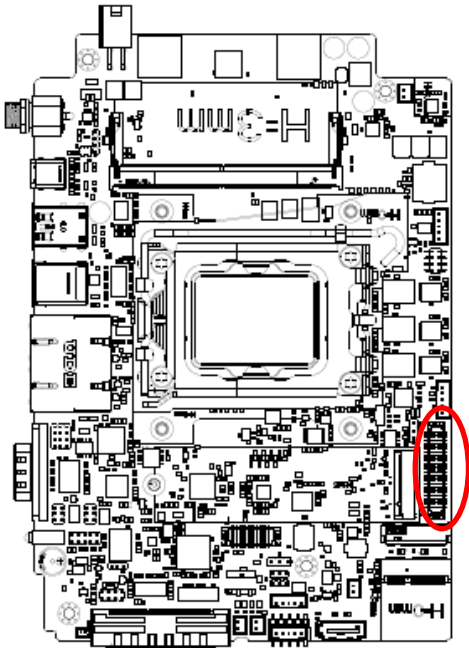

Signal	PIN	PIN	Signal
+12V	39	40	+12V
GND	37	38	GND
LVDS_CLK2N	35	36	LVDS_CLK1N/EPAUXN
LVDS_CLK2P	33	34	LVDS_CLK1P/EPAUXP
GND	31	32	GND
LVDS_DATAN7	29	30	LVDS_DATAN6
LVDS_DATAP7	27	28	LVDS_DATAP6
GND	25	26	GND
LVDS_DATAN5	23	24	LVDS_DATAN4
LVDS_DATAP5	21	22	LVDS_DATAP4
GND	19	20	GND
LVDS_DATAN3	17	18	LVDS_DATAN2/eDPN1
LVDS_DATAP3	15	16	LVDS_DATAP2/eDPP0
GND	13	14	GND
LVDS_DATAN1/eDPN1	11	12	LVDS_DATAN0
LVDS_DATAP1/eDPP1	9	10	LVDS_DATAP0/eDP_HPD
GND	7	8	GND
NC	5	6	NC
+3.3V	3	4	+5V
+3.3V	1	2	+5V

### 5.5.26 B2B connector (JB2B1)

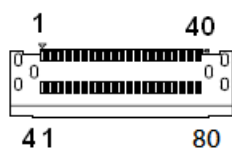
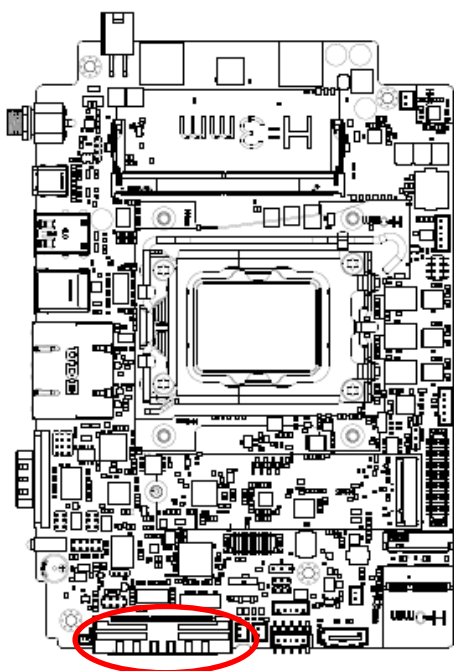

Signal	PIN	PIN	Signal
GND	1	41	GND
GND	2	42	GND
+12V	3	43	GND
+12V	4	44	GND
GND	5	45	GND
LPC_SERIRQ	6	46	+5VSB
LPC_LFRAME#	7	47	+5VSB
CLK3_LPC_B2B	8	48	+5VSB
LPC_AD0	9	49	+5VSB
LPC_AD1	10	50	+5VSB

Signal	PIN	PIN	Signal
LPC_AD2	11	51	GND
LPC_AD3	12	52	USB_PP8
PS_ON_B2B	13	53	USB_PN8
PLT_RST#	14	54	GND
PCH_SLP_S3#	15	55	SMBCLK
HDMI_HPD	16	56	SMBDATA
GND	17	57	GND
HDMI1_CTRL_CLK	18	58	BOARD_ID
HDMI1_CTRL_DAT	19	59	PCIEUSB3_PONRSTB
GND	20	60	PCIEUSB3_SMIB_INT#
HDMI1_TXN_2	21	61	B2BPCIE_WAKE#
HDMI1_TXP_2	22	62	RST_B2BPCIE#
GND	23	63	B2BPCIE_CLK_REQ#
HDMI1_TXN_1	24	64	GND
HDMI1_TXP_1	25	65	PCIE_TXN8
GND	26	66	PCIE_TXP8
HDMI1_TXN_0	27	67	GND
HDMI1_TXP_0	28	68	PCIE_RXN8
GND	29	69	PCIE_RXP8
HDMI1_CLKN	30	70	GND
HDMI1_CLKP	31	71	CLK_B2BPCIE_N2
GND	32	72	CLK_B2BPCIE_P2
GND	33	73	GND
MIC_RIN	34	74	GND
MIC_LIN	35	75	MIC1_JD
GND	36	76	GND
LINEOUT1_JD	37	77	LINE1_JD
LINEOUT_R	38	78	LINE1_RIN
LINEOUT_L	39	79	LNE1_LIN
GND	40	80	GND



### 5.5.27 PC connector (JPC1)

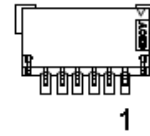
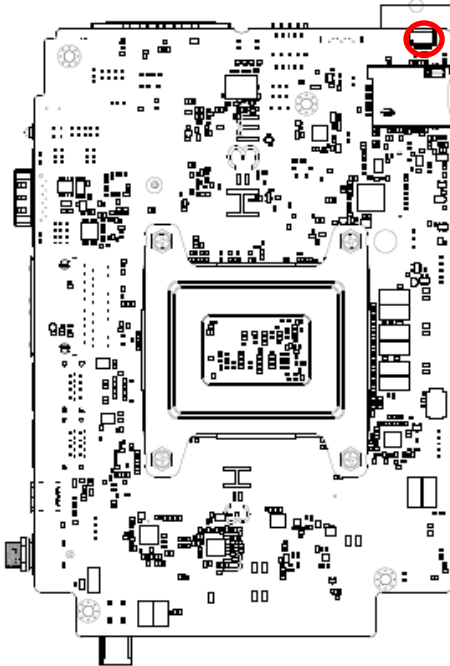

Signal	PIN
VCCCORE_nPMALERT	1
VCCCORE_PMSDA	2
GND	3
VCCCORE_PMSCL	4
+3.3VSB	5
NC	6

## 5.6 HID-2340 DB-A Connector list

### Jumper

Label	Function	Note
JUSB1	USB connector 1	3 x 1 header, pitch 2.00mm
JUSB2	USB connector 2	3 x 1 header, pitch 2.00mm
JCOMSEL1	COM1 in RS-232/422/485 mode	3 x 2 header, pitch 2.00mm

### Connectors

Label	Function	Note
COM1	Serial port 1 connector	D-sub 9 pin, male
JCOM1	Serial port 1 connector	4 x 2 header, pitch 2.00mm
B2B1	B2B connector	40 x 2 wafer, pitch 0.80mm
USB1	USB connector	
LAN1	RJ-45 Ethernet	

## 5.7 HID-2340 DB-A Connectors settings

### 5.7.1 USB connector 1/2 (JUSB1/2)

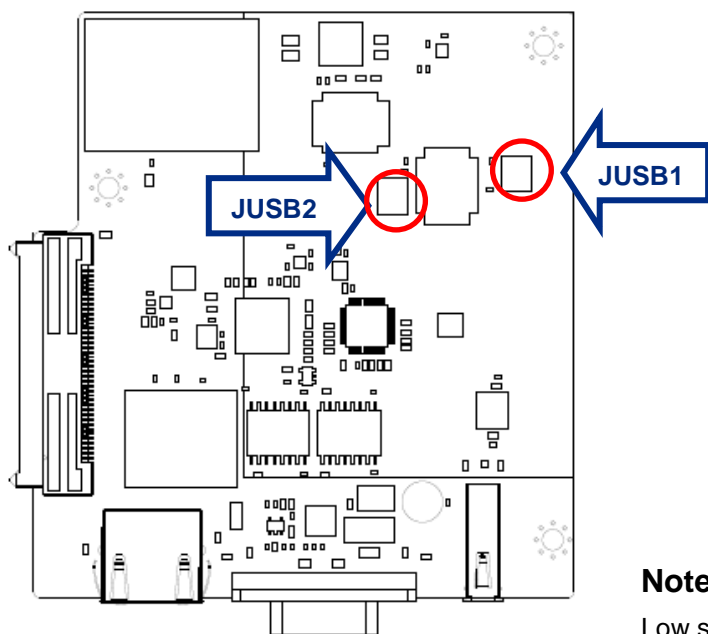

#### USB Full Speed\*



#### USB Low Speed



**Note:**

Low speed: compatible with Keyboard/ mouse.  
 Full speed: compatible with USB drive, Keyboard/ Mouse receiver.

\*Default

### 5.7.2 COM1 in RS-232/422/485 mode (JCOM1\_SEL1)

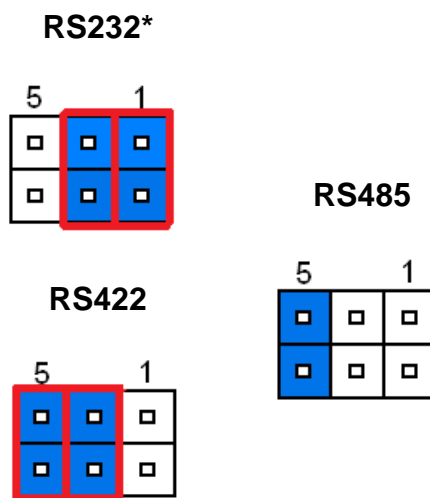
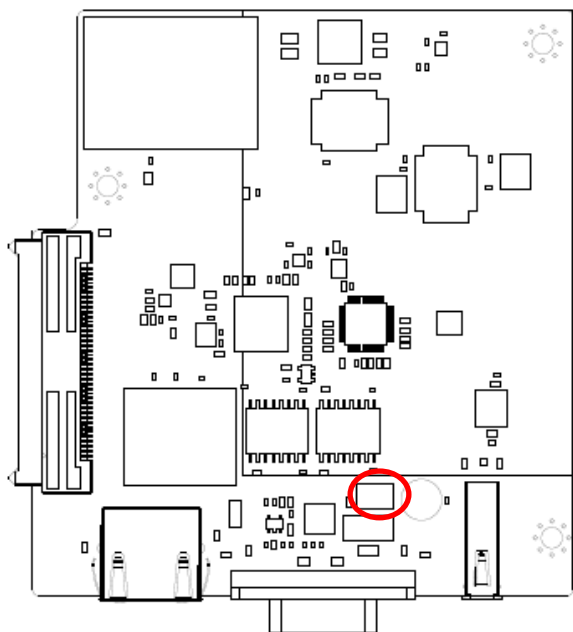

\*Default

### 5.7.3 Serial port 1 connector (JCOM1)

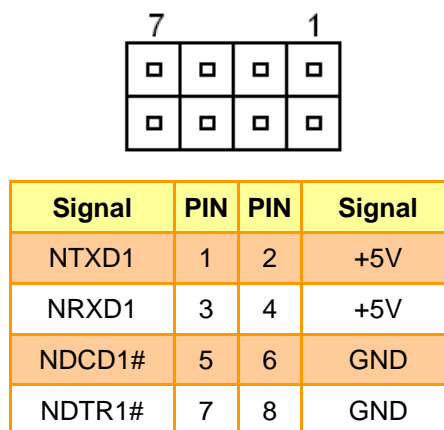
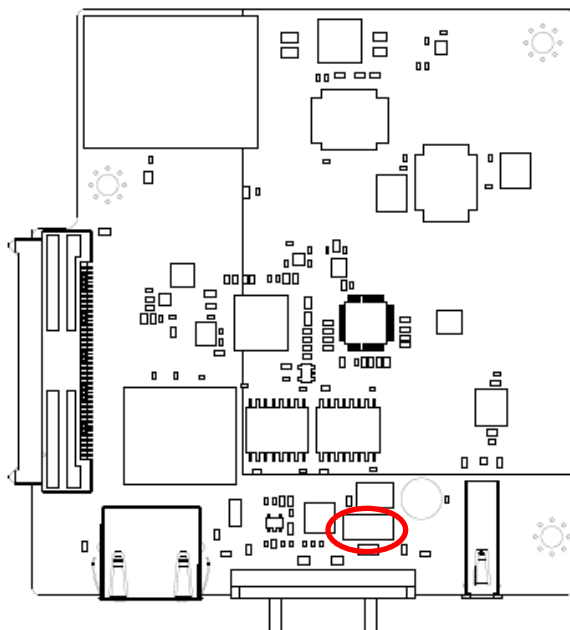

### 5.7.4 B2B connector (B2B1)

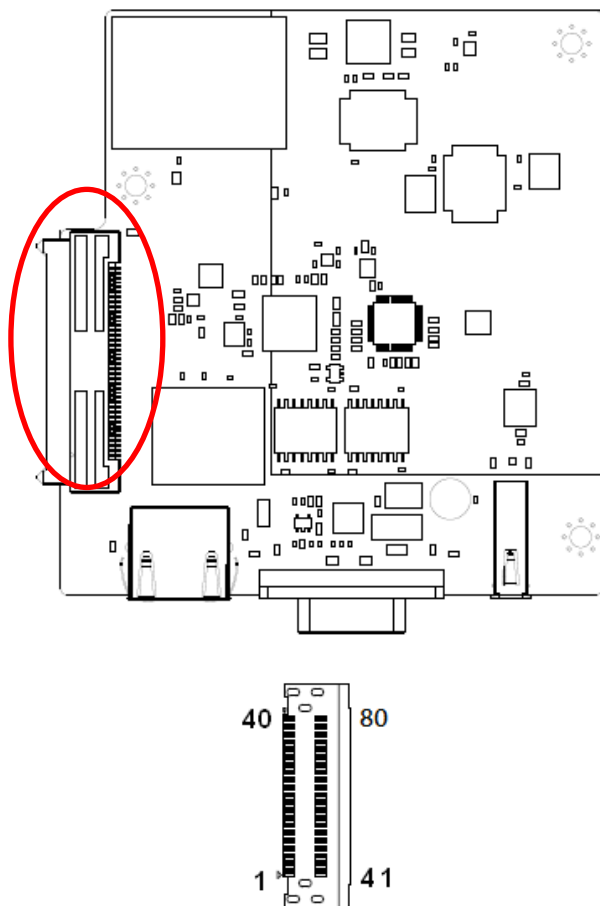

Signal	PIN	PIN	Signal
GND	40	80	GND
NC	39	79	NC
NC	38	78	NC
NC	37	77	NC
GND	36	76	GND
NC	35	75	NC
NC	34	74	GND
GND	33	73	GND
GND	32	72	PCIE_CLKP_A
NC	31	71	PCIE_CLKN_A

Signal	PIN	PIN	Signal
NC	30	70	GND
GND	29	69	PCIE_RXP_A
NC	28	68	PCIE_RXN_A
NC	27	67	GND
GND	26	66	PCIE_TXP_A
NC	25	65	PCIE_TXN_A
NC	24	64	GND
GND	23	63	GND
NC	22	62	LAN_RESET#_A
NC	21	61	LAN_WAKE#_A
GND	20	60	NC
NC	19	59	NC
NC	18	58	GND
GND	17	57	GND
NC	16	56	NC
NC	15	55	NC
PLT_RST#_A	14	54	GND
PS_ON_A	13	53	USB_DN_A
LPC_AD3_A	12	52	USB_DP_A
LPC_AD2_A	11	51	GND
LPC_AD1_A	10	50	+5VSB
LPC_AD0_A	9	49	+5VSB
LPC_CLK_A	8	48	+5VSB
LPC_FRAME#_A	7	47	+5VSB
LPC_SERIRQ_A	6	46	+5VSB
GND	5	45	GND
NC	4	44	GND
NC	3	43	GND
GND	2	42	GND
GND	1	41	GND

## 5.8 HID-2340 DB-B Connector list

### Jumper

Label	Function	Note
JCOMSEL1	Serial port 1 in RS-232/422/485 mode	3 x 2 header, pitch 2.00mm

### Connectors

Label	Function	Note
JCOM1	Serial port 1 connector	5 x 2 header, pitch 2.00mm
JCOMS1	RS-422/RS-485 Termination Resistance connector	4 x 2 header, pitch 2.00mm
B2B1	B2B connector	40 x 2 wafer, pitch 0.80mm
HDMI1	HDMI connector	
MIC1	Mic-in audio jack	
JMIC1	Audio connector (Reserved)	6 x 2 wafer, pitch 2.00mm
LINOUT1	Line-out audio jack	
MINI_PCIE1	Mini-PCIe connector	
USB1	USB connector x 2	
JUSB1	USB connector 1 (Reserved)	5 x 2 wafer, pitch 2.00mm
JUSB2	USB connector 2	5 x 1 wafer, pitch 2.00mm

## 5.9 HID-2340 DB-B Jumpers & Connectors settings

### 5.9.1 Serial port 1 in RS-232/422/485 mode (JCOMSEL1)

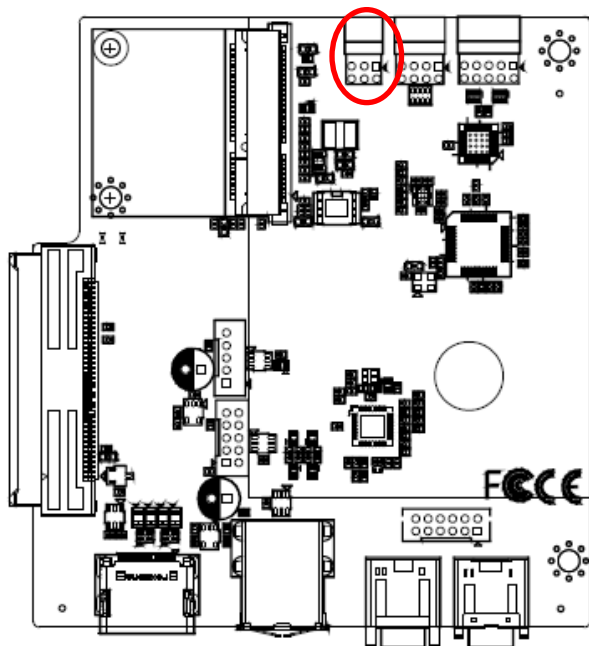

RS232\*

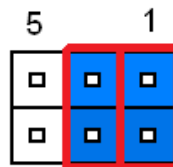

RS485

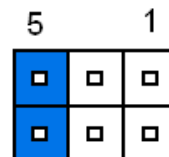

RS422

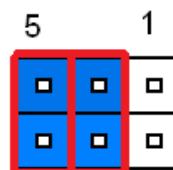

\*Default

### 5.9.2 Audio connector (JM1C1)

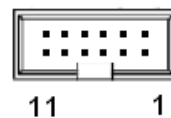
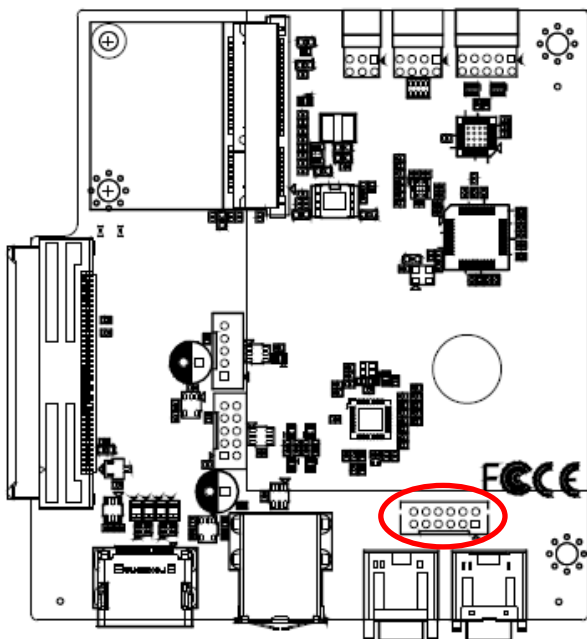

Signal	PIN	PIN	Signal
LINE_L_OUT	1	2	LINE_R_OUT
GND	3	4	GND
LINE_L_IN	5	6	LINE_R_IN
MIC_L	7	8	MIC_R
LINEIN_JD	9	10	LINEOUT_JD
GND	11	12	MIC_JD

#### 5.9.2.1 Signal Description – Audio connector (JM1C1)

Signal	Signal Description
LINEOUT_JD	AUDIO Out(ROUT/LOUT) sense pin
MIC_JD	MIC IN (MIC_RIN/LIN) sense pin

**Note:**

Line in function unavailable.

### 5.9.3 Serial port 1 connector (JCOM1)

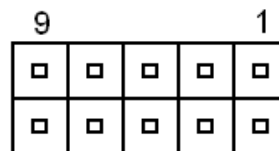
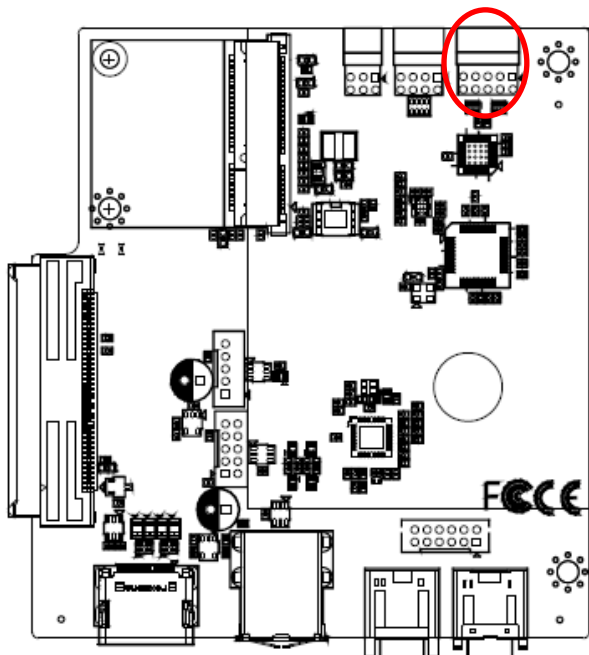

Signal	PIN	PIN	Signal
NDCD1#	1	2	NRXD1
NTXD1	3	4	NDTR1#
GND	5	6	NDSR1#
NRTS1#	7	8	NCTS1#
NRI1#	9	10	NC

### 5.9.4 RS-422/RS-485 Termination Resistance connector (JCOMS1)

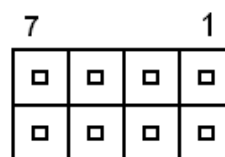
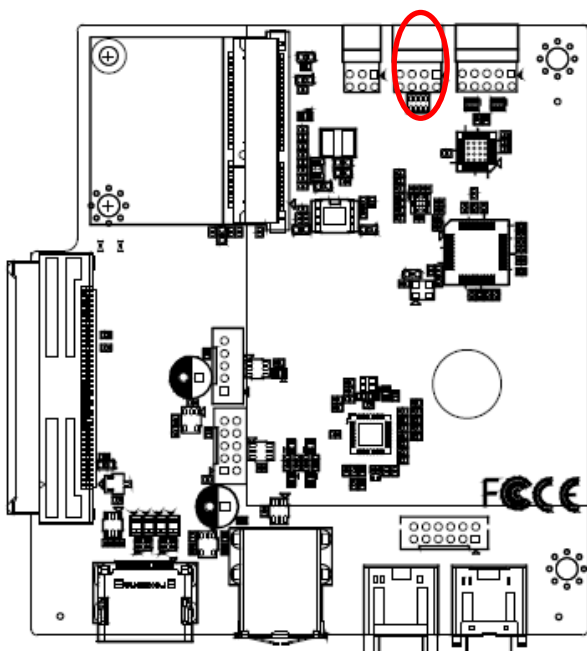

Signal	PIN	PIN	Signal
NTXD1	1	2	+5V
NRXD1	3	4	+5V
NDCD1	5	6	GND
NDTR1#	7	8	GND

### 5.9.5 USB connector 2 (JUSB2)

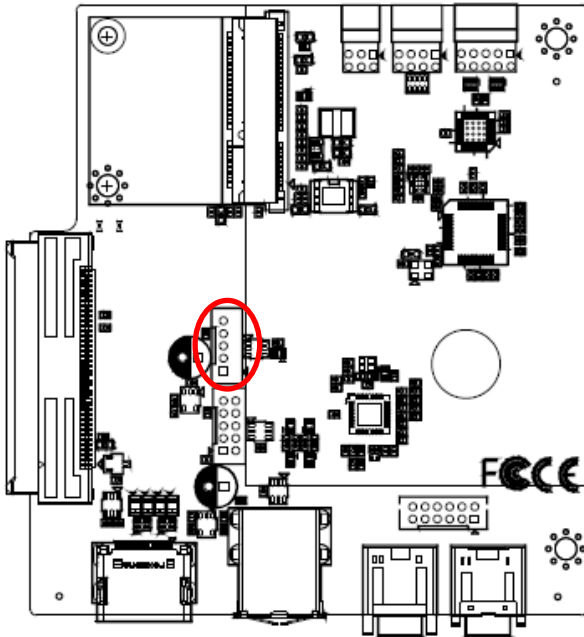

Signal	PIN
GND	5
GND	4
USB_DP_R_3	3
USB_DN_R_3	2
USBVCC2	1



## 6. General Safety Guide

For your own safety and that of your equipment, always take the following precautions.

Disconnect the power plug (by pulling the plug, not the cord), from your computer if any of the following conditions exists:

The power cord or plug becomes frayed or otherwise damaged

You spill something into the case

Your computer has been dropped or the case has been otherwise damaged

You suspect that your computer needs service or repair

You want to clean the computer or screen

You want to remove/install any parts

### Thermal

The HID-2340 is a fanless design system, heat is dispatch through rear metal heatsink which is located at VESA mount area.. When using your HID-2340 systems, it is normal for the metal heatsink to get warm. The rear metal heatsink of the HID-2340 functions as a cooling surface that transfers heat from inside the computer to the cooler air outside. Do not block this heatsink by any soft material.

### Disconnect the power

The only way to disconnect power completely is to unplug the adapter power cord. Make sure at least one end of the power cord is within easy reach so that you can unplug the computer when you need to.

**Warning!** *Your AC cord came equipped with a three-wire grounding plug (a plug that has a third grounding pin). This plug will fit only a grounded AC outlet. If you are unable to insert the plug into an outlet because the outlet is not grounded, contact a licensed electrician to replace the outlet with a properly grounded outlet. Do not defeat the purpose of the grounding plug.*



**Warning!** *Never push objects of any kind into this product through the openings in the case. Doing so may be dangerous and result in fire or a dangerous electric shock.*



**Attention!** *Votre cordon secteur est équipé d'une fiche de mise à la terre à trois fils (une fiche dotée d'une troisième broche de mise à la terre). Cette fiche ne s'adaptera qu'à une prise secteur mise à la terre. Si vous ne parvenez pas à insérer la fiche dans une prise car la prise n'est pas mise à la terre, contactez un électricien agréé pour remplacer la prise par une prise correctement mise à la terre. N'annulez pas l'objectif de la fiche de mise à la terre.*



**Attention!** *N'introduisez jamais d'objets d'aucune sorte dans ce produit par les ouvertures du boîtier. Cela pourrait être dangereux et provoquer un incendie ou un choc électrique dangereux.*



*Never place anything on system case before turn off computer.*

*Never turn on your computer unless all of its internal and external parts are in place.*

*Operating the computer when it is open or missing parts can be dangerous and can damage your computer.*

## Proper Handling

Handle your HID-2340 with care. It is made of metal, glass, and plastic and has sensitive electronic components inside.

Don't use a damaged HID-2340, such as one with a cracked screen, as it may cause injury.

Setup HID-2340 on a stable work surface.

Do not push objects into the ventilation openings.

To lift or move your system, hold its sides.

When you move your system, do not hit the surface of the glass.