

MS-9A76

Industrial Data Machine



Copyright and Trademarks Notice

Copyright © Micro-Star Int'l Co., Ltd. All rights reserved. The MSI logo used is a registered trademark of Micro-Star Int'l Co., Ltd. All other marks and names mentioned may be trademarks of their respective owners. No warranty as to accuracy or completeness is expressed or implied. MSI reserves the right to make changes to this document without prior notice.

Revision History

Revision	Date
V1.1	2021/01

Technical Support

If a problem arises with your product and no solution can be obtained from the user's manual, please contact your place of purchase or local distributor. Alternatively, please visit <https://www.msi.com/support/> for further guidance.

Safety Instructions

- Always read the safety instructions carefully.
- Keep this User's Manual for future reference.
- Keep this equipment away from humidity.
- Lay this equipment on a reliable flat surface before setting it up.
- The openings on the enclosure are for air convection hence protects the equipment from overheating. **DO NOT COVER THE OPENINGS.**
- Make sure the voltage of the power source and adjust properly 110/220V before connecting the equipment to the power inlet.
- Place the power cord such a way that people can not step on it. Do not place anything over the power cord.
- Always Unplug the Power Cord before inserting any add-on card or module.
- All cautions and warnings on the equipment should be noted.
- Never pour any liquid into the opening that could damage or cause electrical shock.
- If any of the following situations arises, get the equipment checked by service personnel:
 - The power cord or plug is damaged.
 - Liquid has penetrated into the equipment.
 - The equipment has been exposed to moisture.
 - The equipment does not work well or you can not get it work according to User's Manual.
 - The equipment has dropped and damaged.
 - The equipment has obvious sign of breakage.
- **DO NOT LEAVE THIS EQUIPMENT IN AN ENVIRONMENT UNCONDITIONED, STORAGE TEMPERATURE ABOVE 60°C (140°F), IT MAY DAMAGE THE EQUIPMENT.**
- When re-plug the DC-in cable, the interval time should be longer than 5 seconds.

警告使用者:

此為甲類資訊技術設備，於居住環境中使用時，可能會造成射頻擾動，在此種情況下，使用者會被要求採取某些適當的對策。

Chemical Substances Information

In compliance with chemical substances regulations, such as the EU REACH Regulation (Regulation EC No. 1907/2006 of the European Parliament and the Council), MSI provides the information of chemical substances in products at:

https://www.msi.com/html/popup/csr/evmtrprt_pcm.html

Battery Information



European Union:

Batteries, battery packs, and accumulators should not be disposed of as unsorted household waste. Please use the public collection system to return, recycle, or treat them in compliance with the local regulations.



廢電池請回收

Taiwan:

For better environmental protection, waste batteries should be collected separately for recycling or special disposal.



California, USA:

The button cell battery may contain perchlorate material and requires special handling when recycled or disposed of in California.

For further information please visit:

<https://www.dtsc.ca.gov/hazardouswaste/perchlorate/>

Danger of explosion if battery is incorrectly replaced. Replace only with the same or equivalent type recommended by the manufacturer.

CE Conformity

Hereby, Micro-Star International CO., LTD declares that this device is in compliance with the essential safety requirements and other relevant provisions set out in the European Directive.



FCC-A Radio Frequency Interference Statement



This equipment has been tested and found to comply with the limits for a Class A digital device, pursuant to Part 15 of the FCC Rules. These limits are designed to provide reasonable protection against harmful interference when the equipment is operated in a commercial environment. This equipment generates, uses and can radiate radio frequency energy and, if not installed and used in accordance with the instruction manual, may cause harmful interference to radio communications. Operation of this equipment in a residential area is likely to cause harmful interference, in which case the user will be required to correct the interference at his own expense.

Notice 1

The changes or modifications not expressly approved by the party responsible for compliance could void the user's authority to operate the equipment.

Notice 2

Shielded interface cables and AC power cord, if any, must be used in order to comply with the emission limits.

This device complies with Part 15 of the FCC Rules. Operation is subject to the following two conditions:

- 1) this device may not cause harmful interference, and
- 2) this device must accept any interference received, including interference that may cause undesired operation.

WEEE Statement

Under the European Union ("EU") Directive on Waste Electrical and Electronic Equipment, Directive 2002/96/EC, which takes effect on August 13, 2005, products of "electrical and electronic equipment" cannot be discarded as municipal waste anymore and manufacturers of covered electronic equipment will be obligated to take back such products at the end of their useful life.



CONTENTS

Copyright and Trademarks Notice.....	ii
Revision History	ii
Technical Support.....	ii
Safety Instructions.....	iii
Chemical Substances Information	iv
Battery Information	iv
CE Conformity.....	v
FCC-A Radio Frequency Interference Statement	v
WEEE Statement	v
1 Overview.....	1-1
System Overview	1-2
System Specifications	1-9
Block Diagram.....	1-12
Motherboard Jumpers.....	1-13
Mechanical Overview (4-Slot SKU).....	1-15
Mechanical Overview (2-Slot SKU).....	1-21
2 Getting Started.....	2-1
Top Cover.....	2-2
CPU.....	2-4
Memory	2-8
Hard Disk Drive	2-10
CFast Card.....	2-14
PCIe Expansion Card.....	2-15
Mini PCIe Card (Optional for 2-Slot SKU).....	2-17
Fan Module (Optional for 4-Slot SKU)	2-18
Fan Module (Optional for 2-Slot SKU)	2-20
Mounting Brackets (Optional).....	2-23
Power (Optional)	2-24
DIO (Optional).....	2-25

3 BIOS Setup	3-1
Entering Setup	3-2
The Menu Bar	3-4
Main	3-5
Advanced	3-6
Boot.....	3-12
Security	3-13
Chipset	3-20
Power	3-21
Save & Exit.....	3-23
Appendix WDT, GPIO, DIO	A-1
Abstract.....	A-2
WDT Sample Code	A-3
Digital I/O Connector.....	A-5



1 Overview

Thank you for choosing the MS-9A76, a high-performance automation computer from MSI.

A highly integrated, rugged system that features versatile I/O capability and PCIe expansion slots, the MS-9A76 is perfect for a wide variety of industrial applications, including machine automation, video surveillance, facility environment monitoring, intelligent transportation, etc.

System Overview



4-Slot SKU



2-Slot SKU

► System I/O & Controls



► Internal View



1

System Power Button

Press the system power button to turn the system on or off.

2

Digital I/O Connector

This Digital I/O connector can be used in various industrial applications like programmable logic devices and embedded, custom applications that make heavy use of GPIO for reading from various environmental sensors (IR, video, temperature, 3-axis orientation, and acceleration), and for writing output to DC motors (via PWM), audio, LCD displays, or LEDs for status. Its isolated Digital I/O pins provide electrical protection to the system, preventing high current devices and high voltages from damaging the system.

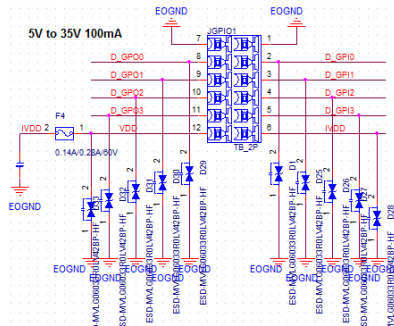

3

9~36V DC Power Jack

Power supplied through this jack supplies power to the system.

4

9~36V Phoenix DC Power Connector

The system is designed with a Phoenix connector that carries wide-range DC input and features reverse wiring protection.

5

Mouse/Keyboard Port

The standard PS/2 mouse/keyboard DIN connector is for a PS/2 mouse/keyboard.

6

USB 2.0 Port

The USB (Universal Serial Bus) port is for attaching USB devices such as keyboard, mouse, or other USB-compatible devices. It supports up to 480Mbit/s (Hi-Speed) data transfer rate.

7

USB 3.0 Port

The USB 3.0 port is backward-compatible with USB 2.0 devices. It supports up to 5Gbit/s (SuperSpeed) data transfer rate.

8**RS-232/422/485 Serial Port: COM1 (0V/5V/12V)**

The serial port is a 16550A high speed communications port that sends/receives 16 bytes FIFOs. It supports barcode scanners, barcode printers, bill printers, credit card machine, etc.

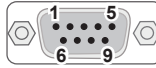
**RS-232**

PIN	SIGNAL	DESCRIPTION
1	NDCD	Data Carrier Detect
2	NSIN	Signal In
3	NSOUT	Signal Out
4	NDTR	Data Terminal Ready
5	GND	Signal Ground
6	NDSR	Data Set Ready
7	NRTS	Request To Send
8	NCTS	Clear To Send
9	VCC	5V or 12V selected by jumper

RS-422

PIN	SIGNAL	DESCRIPTION
1	422 TXD-	Transmit Data, Negative
2	422 RXD+	Receive Data, Positive
3	422 TXD+	Transmit Data, Positive
4	422 RXD-	Receive Data, Negative
5	GND	Signal Ground
6	NC	No Connection
7	NC	No Connection
8	NC	No Connection
9	NC	No Connection

RS-485

PIN	SIGNAL	DESCRIPTION
1	485 TXD-	Transmit Data, Negative
2	NC	No Connection
3	485 TXD+	Transmit Data, Positive
4	NC	No Connection
5	GND	Signal Ground
6	NC	No Connection
7	NC	No Connection
8	NC	No Connection
9	NC	No Connection

9

RS-232/422/485 Serial Port: COM2 (0V/5V/12V)

The serial port is a 16550A high speed communications port that sends/receives 16 bytes FIFOs. It supports barcode scanners, barcode printers, bill printers, credit card machine, etc.

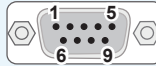

RS-232

PIN	SIGNAL	DESCRIPTION
1	NDCD	Data Carrier Detect
2	NSIN	Signal In
3	NSOUT	Signal Out
4	NDTR	Data Terminal Ready
5	GND	Signal Ground
6	NDSR	Data Set Ready
7	NRTS	Request To Send
8	NCTS	Clear To Send
9	RI	Ring Indicator

RS-422

PIN	SIGNAL	DESCRIPTION
1	422 TXD-	Transmit Data, Negative
2	422 RXD+	Receive Data, Positive
3	422 TXD+	Transmit Data, Positive
4	422 RXD-	Receive Data, Negative
5	GND	Signal Ground
6	NC	No Connection
7	NC	No Connection
8	NC	No Connection
9	NC	No Connection

RS-485

PIN	SIGNAL	DESCRIPTION
1	485 TXD-	Transmit Data, Negative
2	NC	No Connection
3	485 TXD+	Transmit Data, Positive
4	NC	No Connection
5	GND	Signal Ground
6	NC	No Connection
7	NC	No Connection
8	NC	No Connection
9	NC	No Connection

10

RS-232 Serial Port: COM3, COM4, COM5 (0V)

The serial port is a 16550A high speed communications port that sends/receives 16 bytes FIFOs. It supports barcode scanners, barcode printers, bill printers, credit card machine, etc.

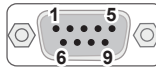
**RS-232**

PIN	SIGNAL	DESCRIPTION
1	NDCD	Data Carrier Detect
2	NSIN	Signal In
3	NSOUT	Signal Out
4	NDTR	Data Terminal Ready
5	GND	Signal Ground
6	NDSR	Data Set Ready
7	NRTS	Request To Send
8	NCTS	Clear To Send
9	RI	Ring Indicator

11

DVI-I Port

The DVI-I (Digital Visual Interface-Integrated) connector allows you to connect an LCD monitor. It provides a high-speed digital interconnection between the computer and its display device. To connect an LCD monitor, simply plug your monitor cable into the DVI connector, and make sure that the other end of the cable is properly connected to your monitor (refer to your monitor manual for more information.)

12

DisplayPort

DisplayPort is a digital display interface standard. This connector is used to connect a monitor with DisplayPort inputs.

13

RJ45 LAN Jack

The standard RJ-45 LAN jack is provided for connection to the Local Area Network (LAN). You can connect a network cable to it.



LED	Color	LED State	Condition
Left	Yellow	Off	LAN link is not established.
		On (steady state)	LAN link is established.
		On (blinking)	The computer is communicating with another computer on the LAN.
Right	Green	Off	10 Mbit/sec data rate is selected.
	Orange	On	100 Mbit/sec data rate is selected.
		On	1000 Mbit/sec data rate is selected.

14

Audio Jack

- Line-In (Blue) - for external CD player or other audio devices
- Line-Out (Green) - for speakers or headphones
- Mic-In (Pink) - for microphones

15

HDD Bracket

This bracket is provided for hard disk drives.

16

Memory Slot

These slots are intended for memory modules.

17

CFast 2.0 Socket

This socket is provided for CFast cards.

18

PCI/PCIe Expansion Slot

These slots are provided for PCI/PCIe expansion cards.

To enable multi-screen output from integrated graphics and external graphics card, please set BIOS items as following.

1. Set CSM to Disable
2. Set Chipset/Primary Display to IGFX

19

4-Pin Power Connector

Please kindly note the power spec (Input Voltage) of extension card must be the same with DC-in adaptor which supply to MS-9A76 system.

System Specifications

Processor

- Intel 6/7th generation Core i7/ i5/ i3/ Celeron/ Pentium processor (LGA1151)

Chipset

- Intel Q170/C236 chipset

Memory

- 2 * Non-ECC or ECC, unbuffered DDR4 2133/2400 MHz SO-DIMM slots
- ECC support only PCH C236
- Support Dual-Channel mode
- Up to 32 GB

LAN

- Intel I219 Gigabit Fast Ethernet controller with iAMT 11.8 support (LAN1)
- Intel I210-AT Gigabit Fast Ethernet controller (LAN2)

Storage

- Onboard SATA III for 2 * 2.5" HDD/SSD installation
 - Support AHCI and RAID 0, 1
- 1 * CFast 2.0 socket

Audio

- Realtek ALC887-VD2-CG co-lay ALC888S High Definition Audio codec
- 3 * audio jacks (Line-In, Line-Out, Mic-In)

Graphics

- 1 * DVI-I port
- 2 * DisplayPorts
 - To enable multi-screen output from integrated graphics and external graphics card, please set BIOS items as following.
 1. Set CSM to Disable
 2. Set Chipset/Primary Display to IGFX

Security

- 1 * internal USB 2.0 port for Security Key

System I/O & Controls

- 1 * System Power Button
- 1 * Digital I/O Connector
- 1 * 9~36V DC Power Jack
- 1 * 9~36V Phoenix DC Power Connector
- 1 * Mouse/Keyboard Port
- 2 * USB 2.0 Ports
- 6 * USB 3.0 Ports
- 1 * RS-232/422/485 Serial Port (COM1: 0V/5V/12V)
- 1 * RS-232/422/485 Serial Port (COM2: 0V/5V/12V)
- 3 * RS-232 Serial Ports (COM3, COM4, COM5: 0V)
- 1 * DVI-I Port
- 2 * DisplayPorts
- 2 * RJ45 LAN Jacks
- 3 * Audio Jacks

Expansion Slot

Dimensions \ SKUs	4-Slot SKU		2-Slot SKU
	9989 Riser Board (1*PCIe x16, 3*PCI)	99B9 Riser Board (2*PCIe x8, 2*PCI)	99C6 (1*PCIe x16, 1*PCI, 1*mSATA)
PCI Express Card	<ul style="list-style-type: none"> ■ Maximum card length: 210mm ■ Maximum card height (with optional bracket): 118mm ■ Minimum card height (with optional bracket): 65mm 		
PCI Card	<ul style="list-style-type: none"> ■ Maximum card length: 210mm ■ Maximum card height (with optional bracket): 112mm ■ Minimum card height (with optional bracket): 65mm 		

Power Supply

- Input: 9-36Vdc, 20-5A
- GPIO Port: 5-35Vdc, 100mA

Power Consumption

CPU 65W (kabylake DT)	Power off (deep S5) (*3)	System Idle mode (*1)	System Full Load (*2)	Recommended Power Supply
Integrated Embedded Computer				
Core-i7(7700)	0.12992W	13.571W	87.27W	180W

*1-Screen saver disable

*2-BurnIn test v8.1: CPU, Memory, HDD, 2D, 3D, Video, Network Loading 100%

*3-Meet Eu ErP

Environmental

- Operation Temperature:
 - » -10 ~ 50°C w/ industrial DC power Up to 35W CPU
 - » -10 ~ 40°C w/ Fan module Up to 65W CPU
- Storage Temperature: -20 ~ 80°C
- Relative Humidity: 0 ~ 90%, non-condensing

Dimension

- 4-Slot SKU: 176 (W) x 226 (D) x 217 (H) mm
- 2-Slot SKU: 143 (W) x 226 (D) x 217 (H) mm

Weight

- 4-Slot SKU: 4.8Kg
- 2-Slot SKU: 4.4Kg

Regulatory Compliance

- CE, FCC Class A, VCCI, RCM, BSMI, RoHS, UL

OS Support

- Windows 7 32/64 Bit for Skylake CPU
- Windows 8.1 32/ 64 Bit for Skylake CPU
- Windows 10 64 Bit

Hardware Options

- Optional fan module covers available to enhance heat dissipation from installed PCI/PCIe cards

SKU Comparison

SKUs	4-Slot SKU		2-Slot SKU
Features	9A76 (Q170 or C236)		
Motherboard	98J2 (Q170 or C236)		
Riser Board	9989 (1*PCIe x16, 3*PCI)	99B9 (2*PCIe x8, 2*PCI)	99C6 (1*PCIe x16, 1*PCI, 1*mSATA)

Block Diagram

MS-9A76 (Q170/C236)

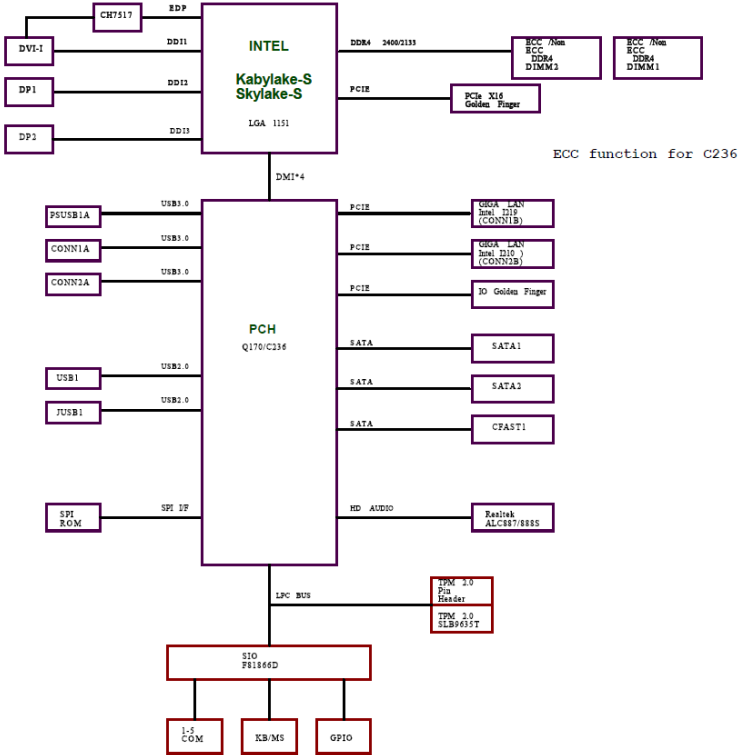

Motherboard Jumpers

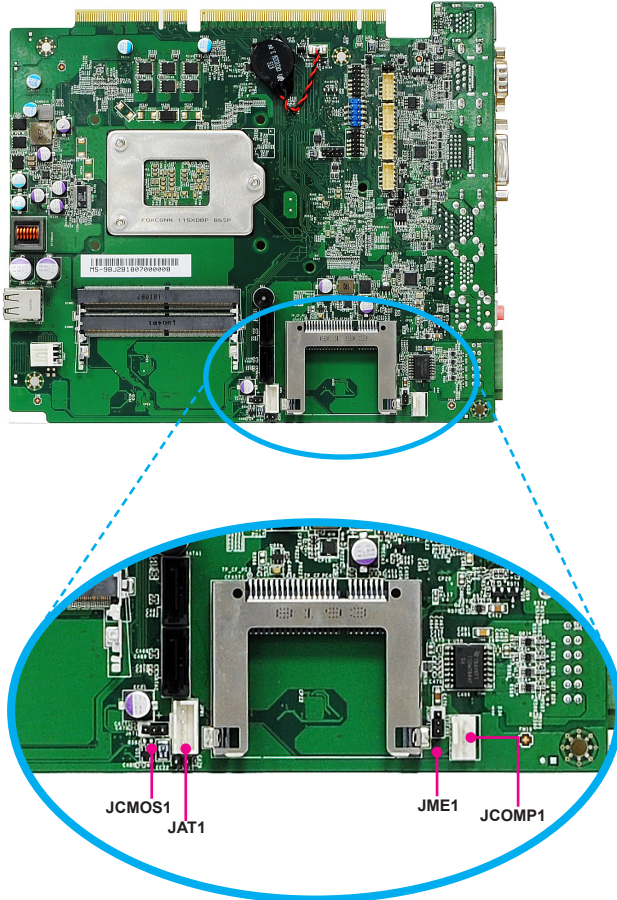

Clear CMOS Jumper: JCMOS1



Normal
(Default)



Clear CMOS

AT/ATX Select Jumper: JAT1



ATX (Default)



AT

ME Jumper: JME1



Normal
(Default)



ME disable

Serial Port Power Jumper: JCOMP1



+5V (Default)



+12V

Mechanical Overview (4-Slot SKU)

► System Dimensions

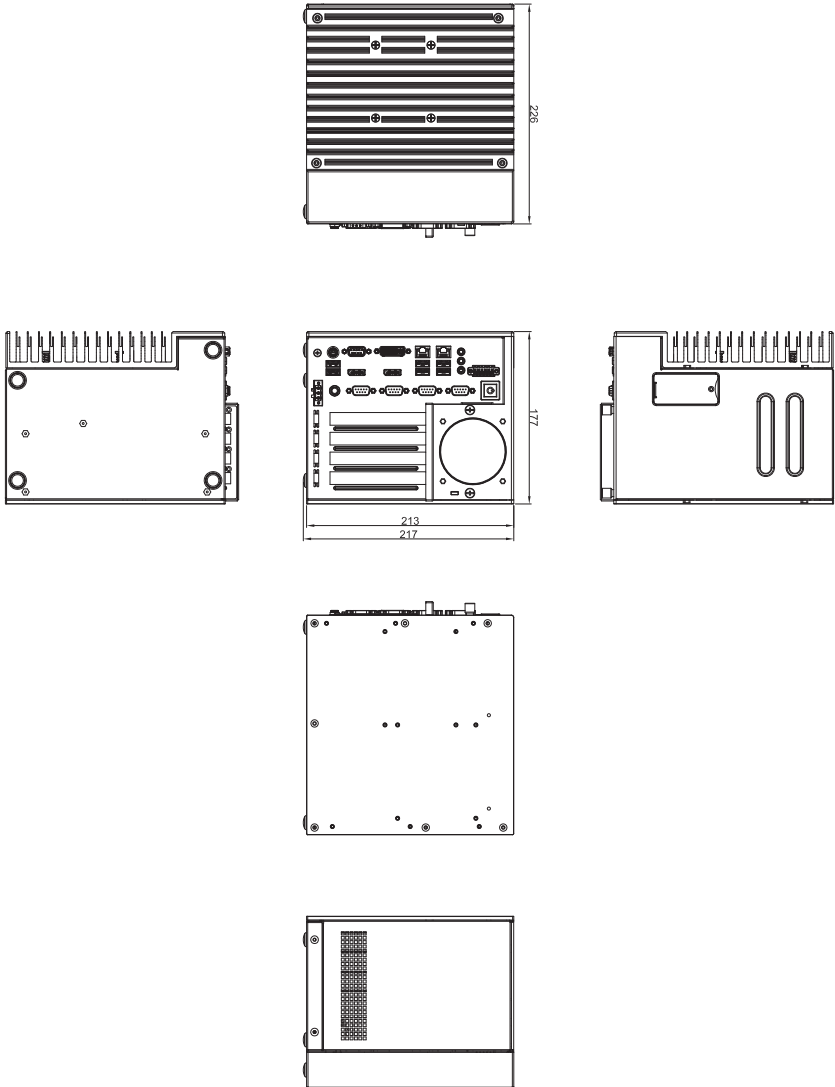

► System Dimensions with Wall Mount

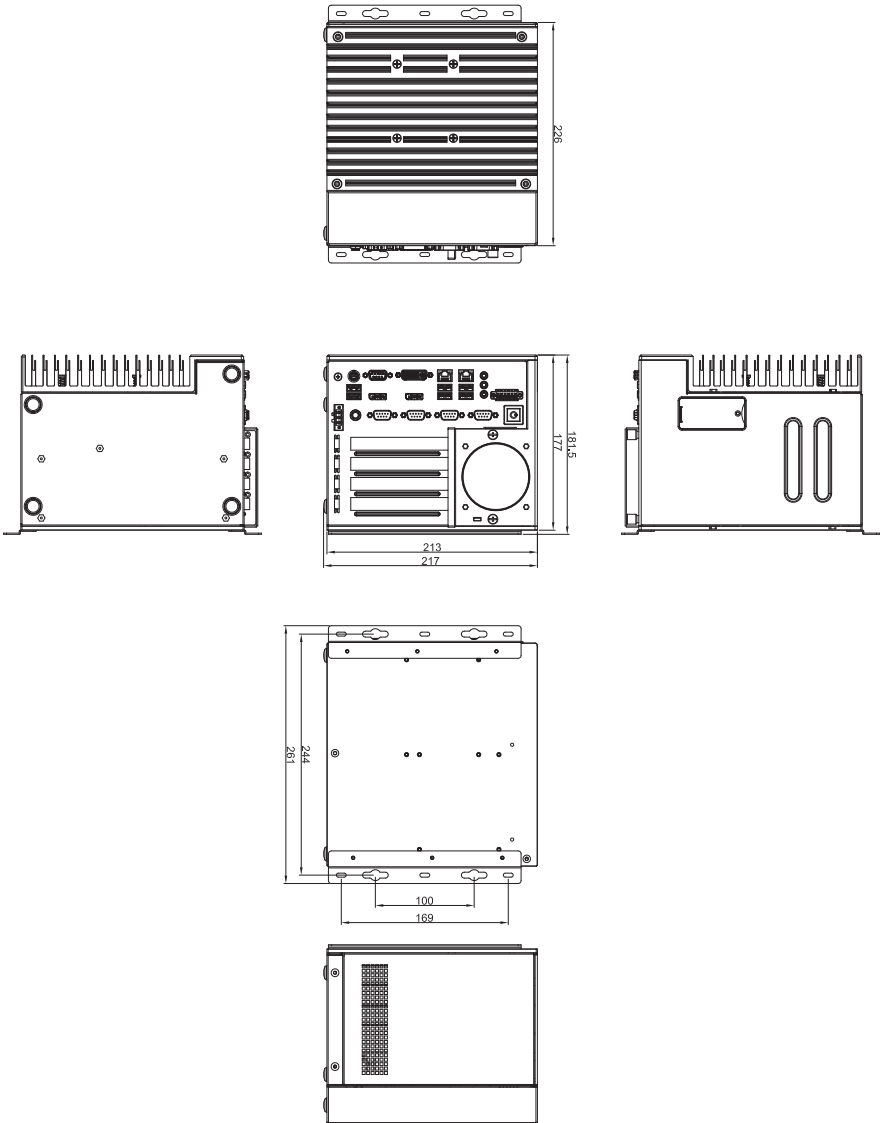

► PCI Express Card Dimensions

PCI Express Card Dimensions

PCIe Card	Dimension	Remarks
Minimum X	155mm	(fixed by optional bracket)
Maximum X	210mm	
Minimum Y	65mm	(w/ optional bracket)
Maximum Y	118mm	(w/ optional bracket)

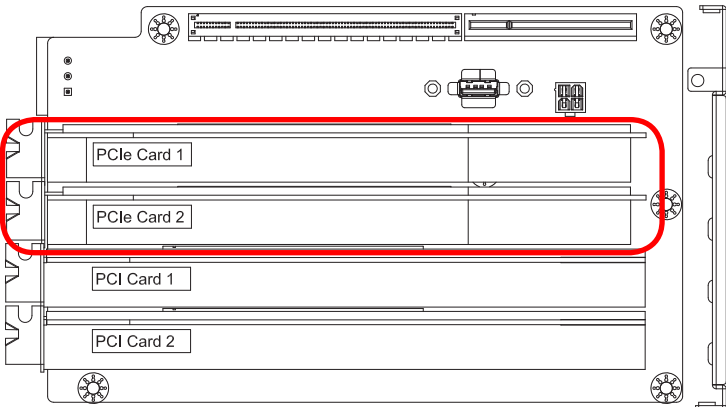
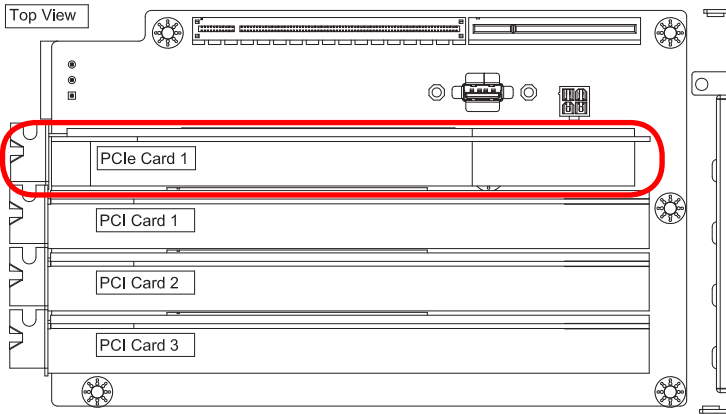

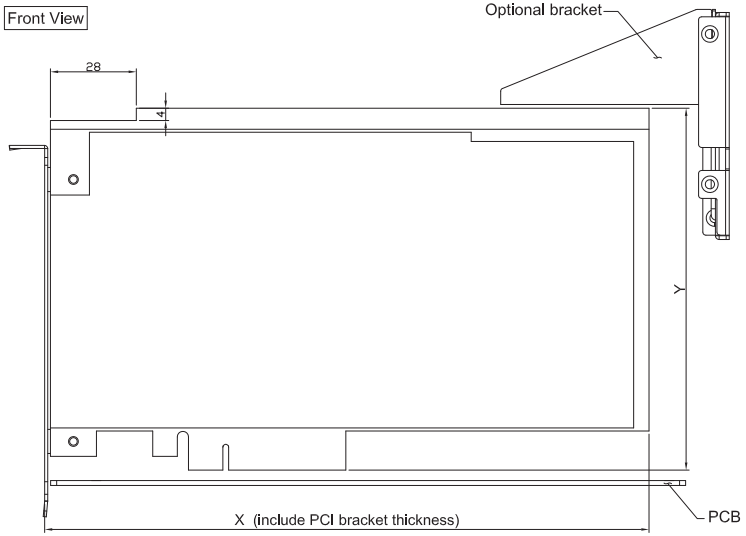

► PCI Card Dimensions

PCI Card Dimensions

PCI Card	Dimension	Remarks
Minimum X	155mm	(fixed by optional bracket)
Maximum X	210mm	
Minimum Y	65mm	(w/ optional bracket)
Maximum Y	112mm	(w/ optional bracket)

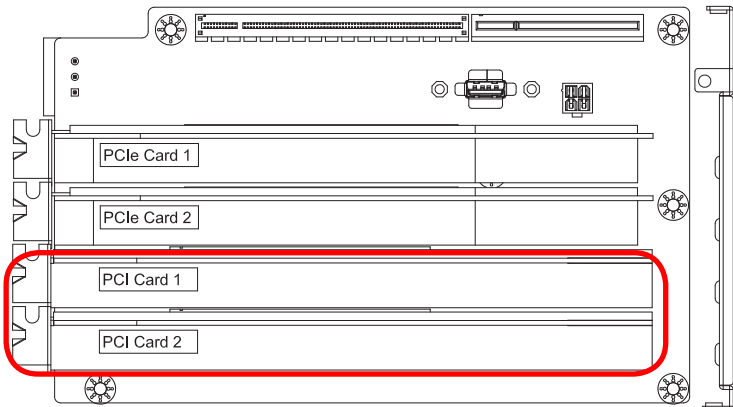
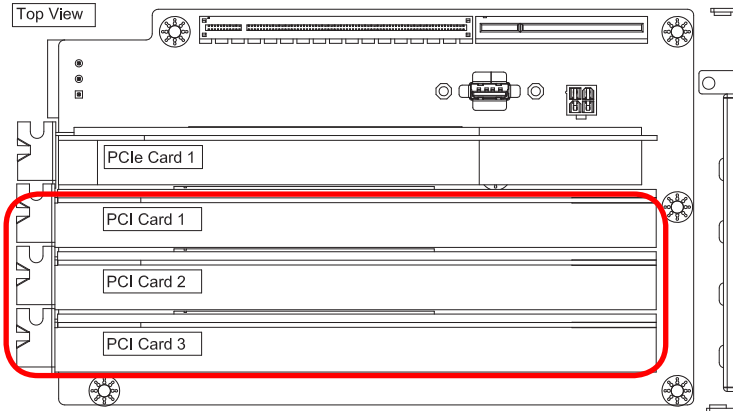

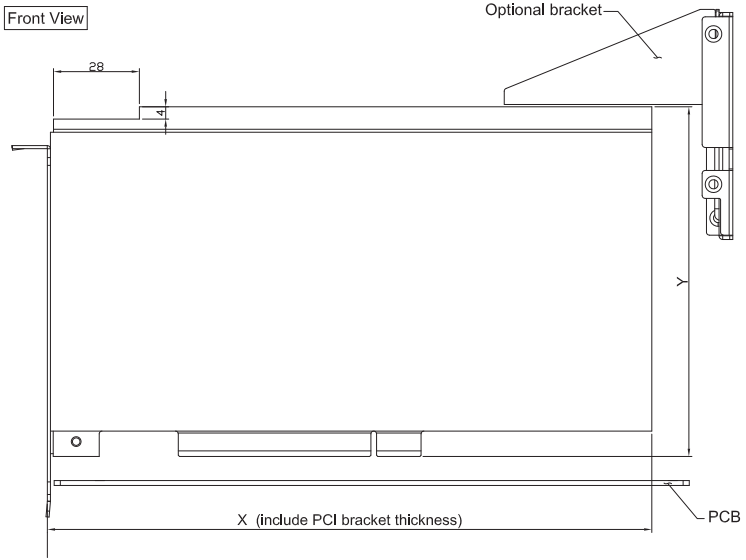

Mechanical Overview (2-Slot SKU)

► System Dimensions

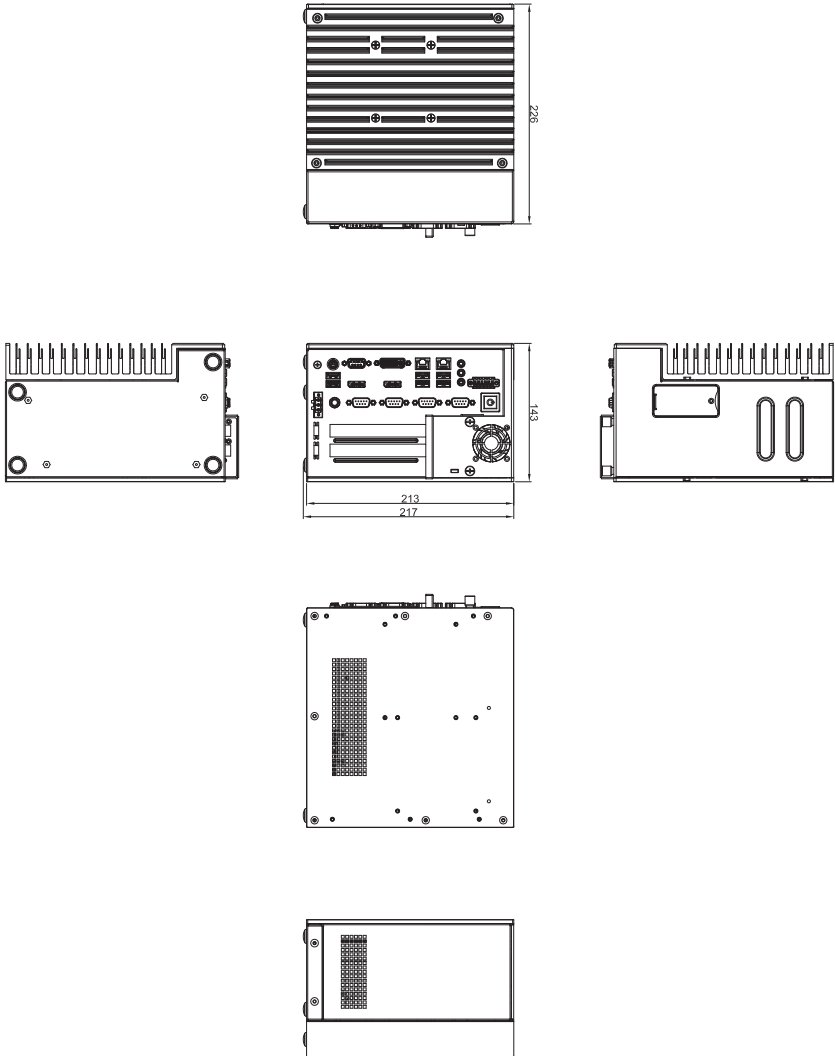

► System Dimensions with Wall Mount

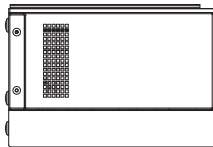
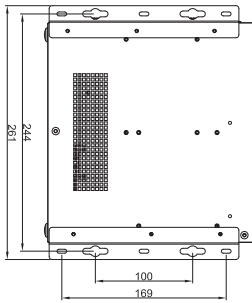
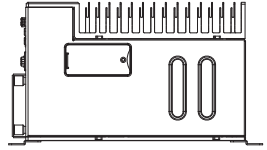
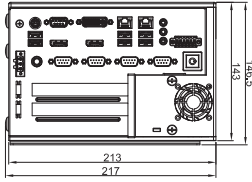
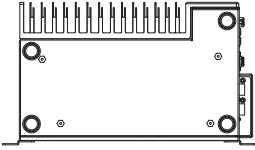
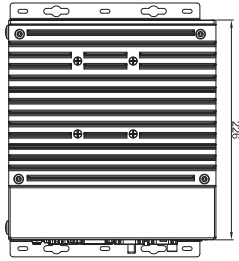

► PCI Express Card Dimensions

PCI Express Card Dimensions

PCIe Card	Dimension	Remarks
Minimum X	155mm	(fixed by optional bracket)
Maximum X	210mm	
Minimum Y	65mm	(w/ optional bracket)
Maximum Y	118mm	(w/ optional bracket)

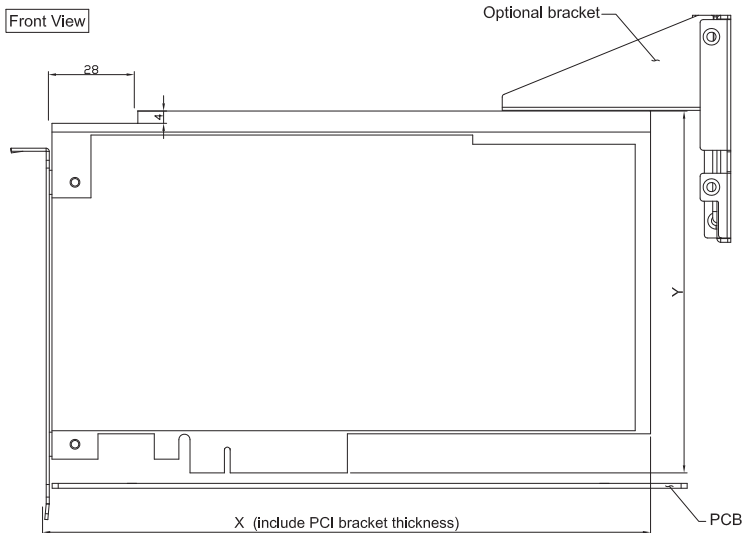
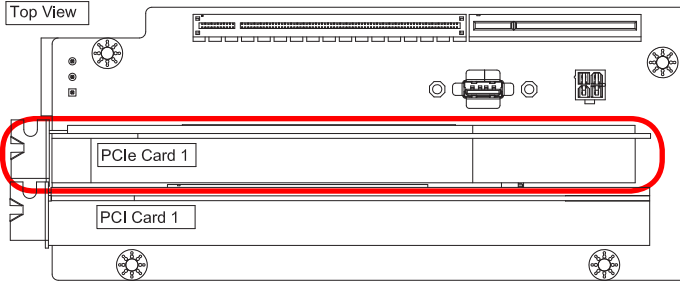

► PCI Card Dimensions

PCI Card Dimensions

PCI Card	Dimension	Remarks
Minimum X	155mm	(fixed by optional bracket)
Maximum X	210mm	
Minimum Y	65mm	(w/ optional bracket)
Maximum Y	112mm	(w/ optional bracket)

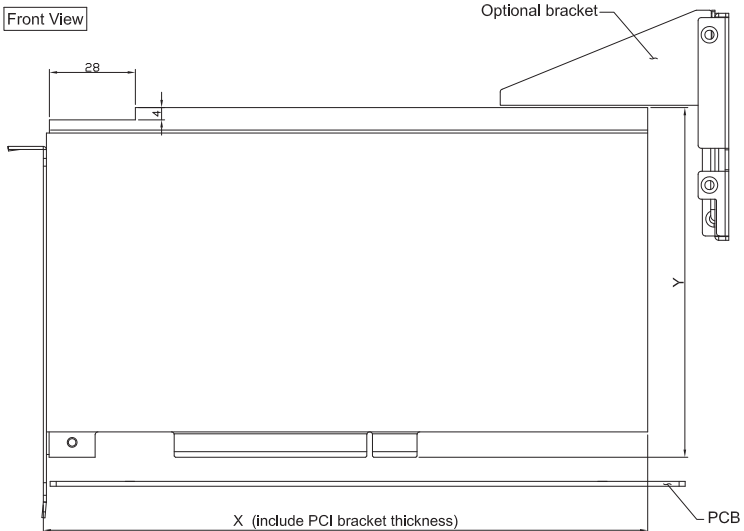
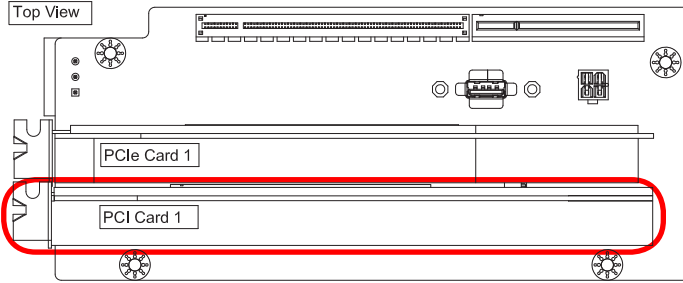

2 Getting Started



This chapter provides you with the information on hardware setup procedures. While connecting peripheral devices, be careful in holding the devices and use a grounded wrist strap to avoid static electricity.

Top Cover

Important

Turn off the system and unplug the power cord before installing or replacing system components.

1. Locate the thumbscrews on the front panel of the system.



2. Loosen the thumbscrews to release the top cover.



3. Push the top cover gently forward.



4. Remove the top cover from the system.



CPU

1. Locate and loosen the heatsink screws.



2. Remove the heatsink.



3. Find the CPU socket.

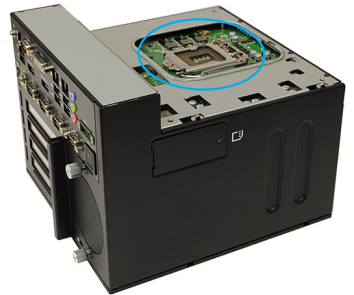

4. Push the load lever down to unclip it and lift to the fully open position.
5. The load plate will automatically lift up as the load lever is pushed to the fully open position.

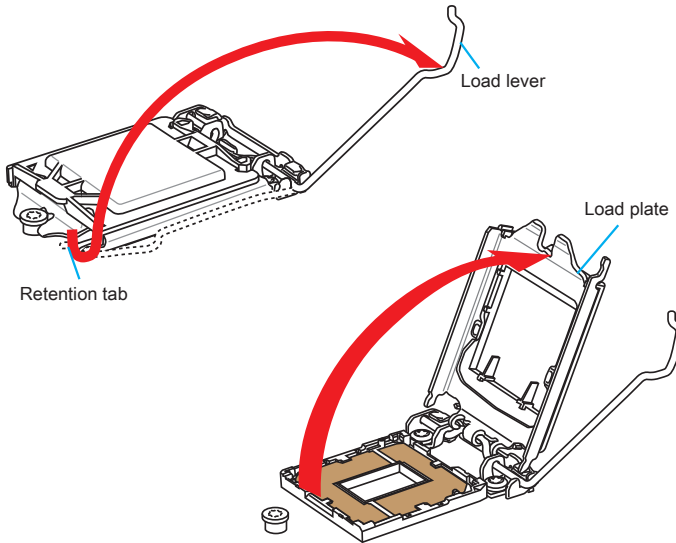

! Important

Do not touch the socket contacts or the bottom of the CPU.

6. Align the notches with the socket alignment keys. Lower the CPU straight down, without tilting or sliding the CPU in the socket. Inspect the CPU to check if it is properly seated in the socket.
7. Close and slide the load plate under the retention knob. Close and engage the load lever.

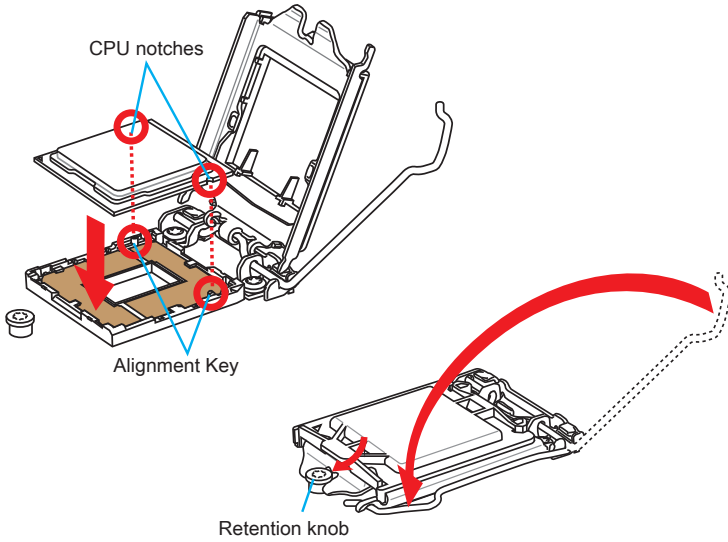

8. When you press down the load lever the PnP cap will automatically pop up from the CPU socket. Do not discard the PnP cap. Always replace the PnP cap if the CPU is removed from the socket.
9. Put the PSX CPU Thermal PAD atop the CPU. This will improve heat dissipation and prevent CPU overheating.

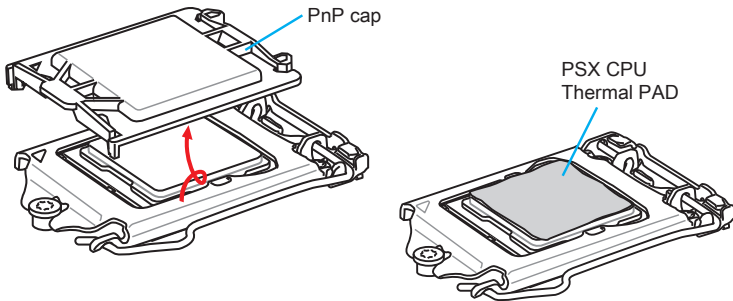

Important

- Confirm that the CPU heatsink has formed a tight seal with the CPU before booting your system.
- Whenever the CPU is not installed, always protect the CPU socket pins by covering the socket with the plastic cap.

10. Place the heatsink and lock the screws in the assigned diagonal sequences.



Memory

1. For convenient installation, please remove the SATA cable first and reconnect it after memory installation.

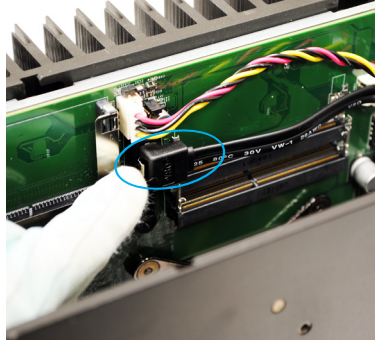

2. Locate the memory slot.



3. Align the notch on the memory with the key on the slot and insert the memory into the slot at a 45-degree angle.



4. Push the memory gently downwards until the slot clips click and lock the memory in place.



5. Install the second memory if necessary.

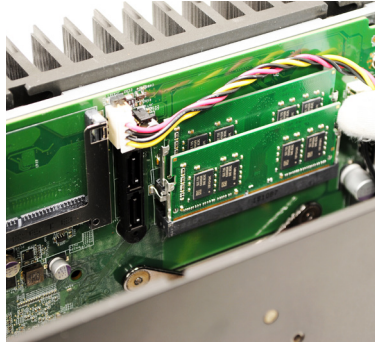

Hard Disk Drive

1. Identify the components necessary for HDD installation.

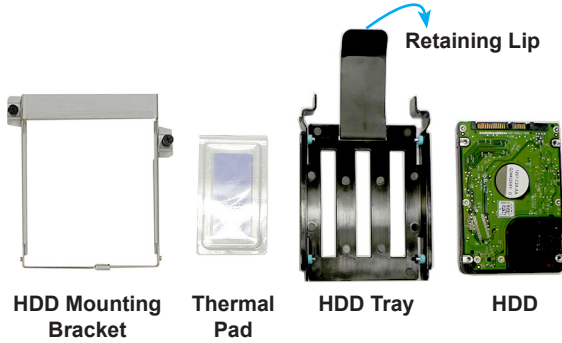

2. Fit the HDD into the tray. Be sure to put the HDD in the correct orientation.

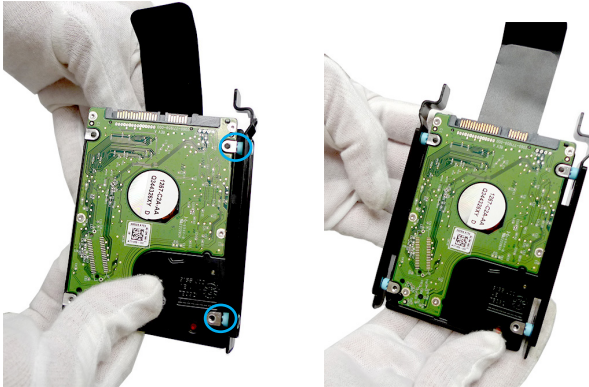

3. Peel off the transparent protective film of the thermal pad.

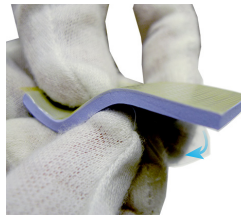

4. Place the thermal pad onto the HDD. Check the following picture for the exact location of the thermal pad. Once the thermal pad is secured, peel off the yellow protective film.

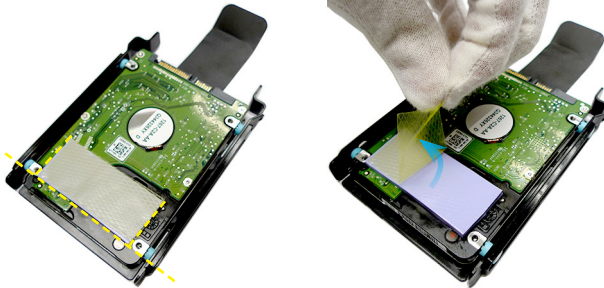

5. Fit the HDD into the mounting bracket.



6. Once the HDD has been securely installed, place the HDD set back to the system. Make sure the HDD set is correctly oriented. Fasten the HDD set to the system with screws.

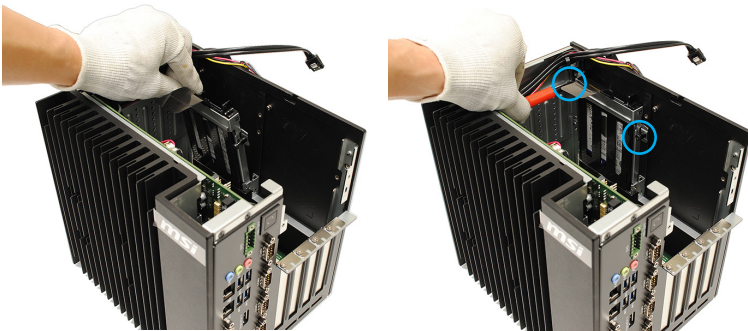

-
7. To avoid clutter, tidy up the retaining lip behind the HDD.



-
8. Connect the SATA data cable to the HDD.



-
9. Connect the SATA power cable to the HDD.



10. Route the cables through the cable routing clip.

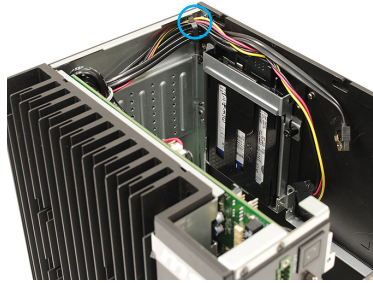

CFAST Card

1. Locate and loosen the CFAST card door on the top panel of the system.



2. Remove the CFAST card door.

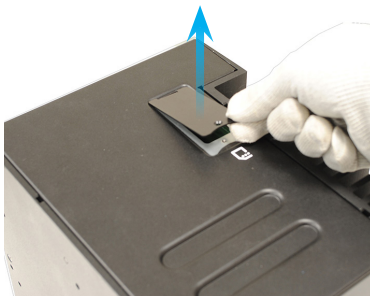

3. Insert the CFAST card into the socket. Push the card gently downwards to secure it in place.



PCIe Expansion Card

1. Locate the PCIe slot and remove the card bracket from the chassis.



2. Check the card's keyed components for correct alignment with the slot and lower the card into the slot. Push the card gently downwards to secure it in place.



3. Screw the card to the chassis to fix it in place.



4. (Optional) A protective bracket is provided to cut down on system vibrations that may damage the card.



5. Then place the bracket above the card and screw it to the HDD set as indicated by the picture.

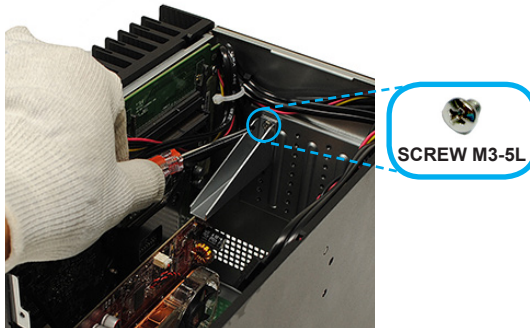

Mini PCIe Card (Optional for 2-Slot SKU)

1. Locate the Mini PCIe slot on the motherboard.

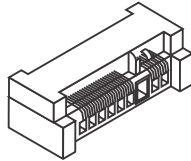

2. Remove the card screw.

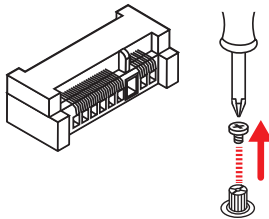

3. Insert the card into the slot at a 45-degree angle.

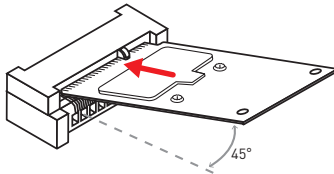

4. Push the card gently downwards and fasten it with the screw.

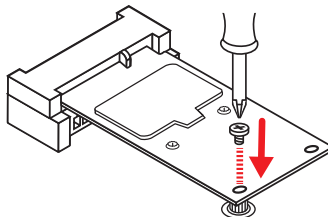

Fan Module (Optional for 4-Slot SKU)

1. Identify the components necessary for fan module installation.



2. Mount the fan module over the air ventilation holes on the system top cover.



3. Put the fan bracket atop the fan and screw it to the fan in diagonal sequence.



4. Connect the fan power connector to the motherboard.

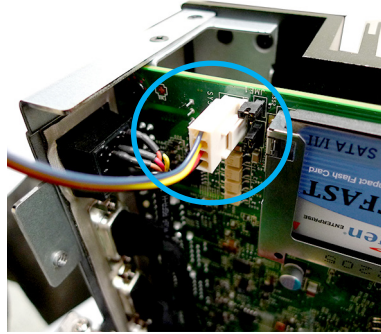

Fan Module (Optional for 2-Slot SKU)

1. Identify the components necessary for fan module installation.

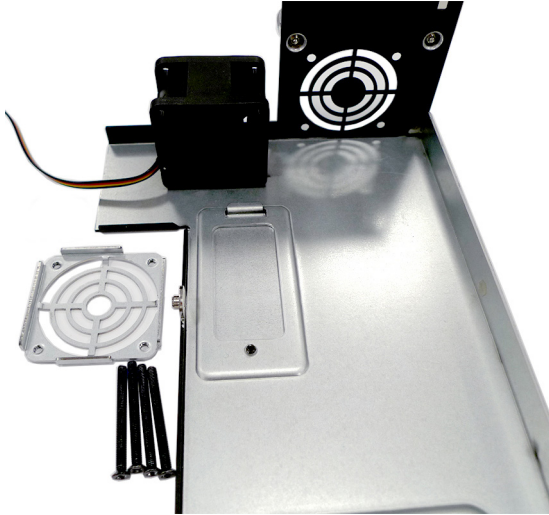

2. Put the fan bracket atop the fan. Mind the orientation of the bracket to ensure a smooth pathway for the fan cable.

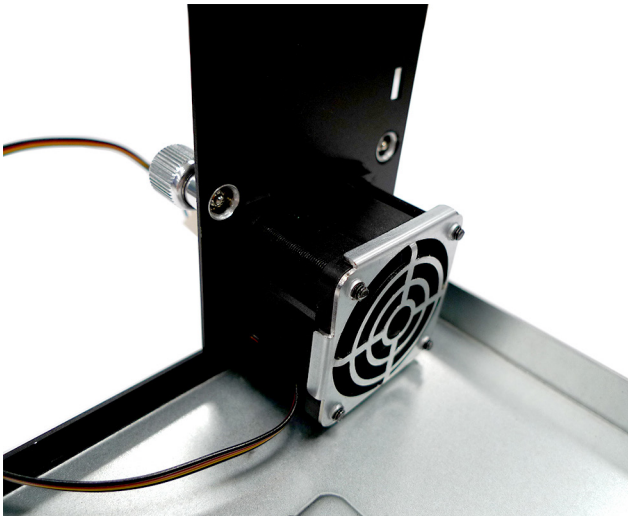

3. Mount the fan module over the air ventilation holes on the system top cover. Screw the fan module to the top cover in diagonal sequence.

External View**Internal View**

4. Connect the fan power connector to the motherboard.

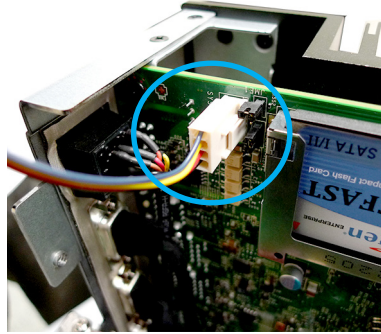

Mounting Brackets (Optional)

1. Identify the components necessary for mounting bracket installation.



2. Screw the brackets to the system.



Power (Optional)

With a redundant power supply solution, users may feed the power through the DC power jack and/or through the 9V~36V Phoenix DC connector.

1. Locate the DC power connector on the system panel.



2. Connect a DC receptacle connector to it.



DIO (Optional)

1. Locate the DIO connector on the system panel.



2. Insert the DIO switch connector at a 45-degree angle.



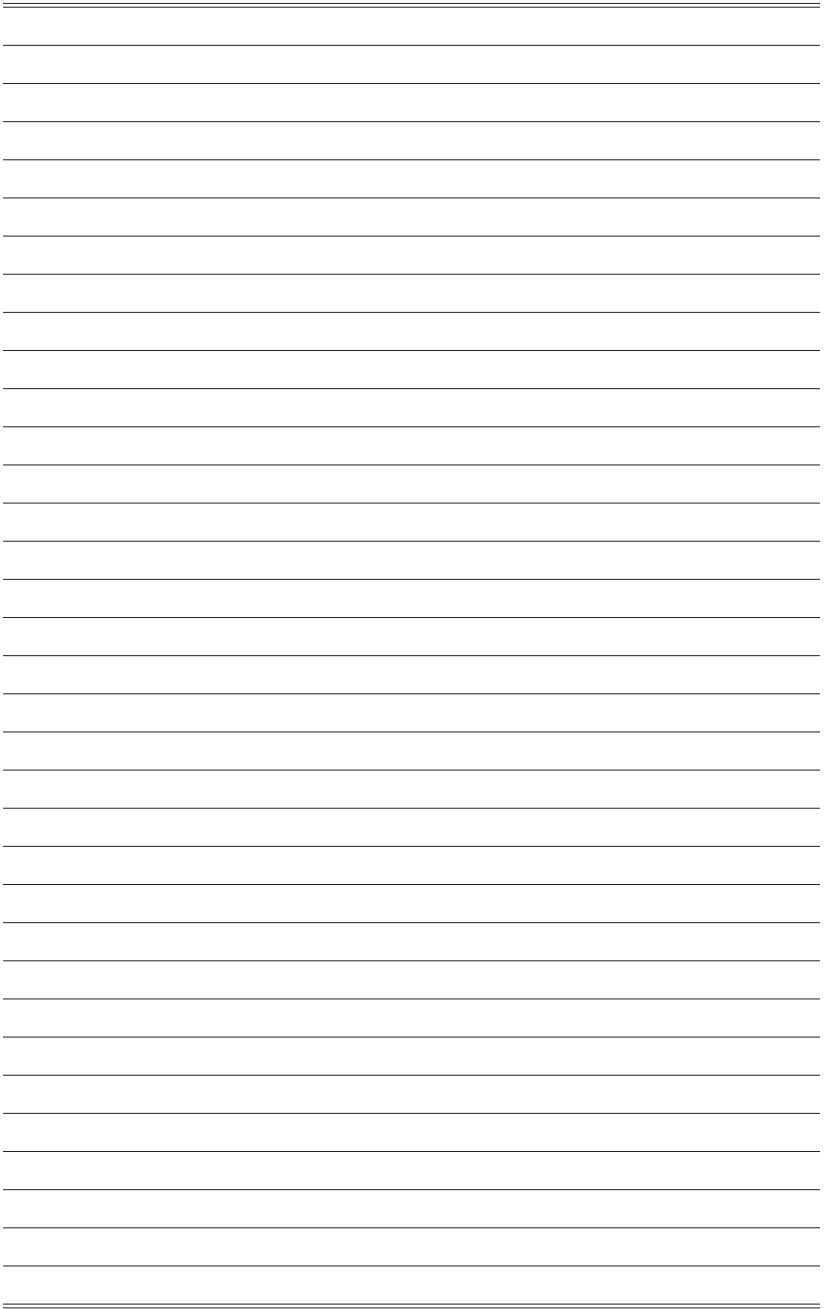

3 BIOS Setup

This chapter provides information on the BIOS Setup program and allows users to configure the system for optimal use.

Users may need to run the Setup program when:

- An error message appears on the screen at system startup and requests users to run SETUP.
- Users want to change the default settings for customized features.

Important

- *Please note that BIOS update assumes technician-level experience.*
- *As the system BIOS is under continuous update for better system performance, the illustrations in this chapter should be held for reference only.*

Entering Setup

Power on the computer and the system will start POST (Power On Self Test) process. When the message below appears on the screen, press or <F2> key to enter Setup.

Press or <F2> to enter SETUP

If the message disappears before you respond and you still wish to enter Setup, restart the system by turning it OFF and On or pressing the RESET button. You may also restart the system by simultaneously pressing <Ctrl>, <Alt>, and <Delete> keys.

Important

The items under each BIOS category described in this chapter are under continuous update for better system performance. Therefore, the description may be slightly different from the latest BIOS and should be held for reference only.

Control Keys

← →	Select Screen
↑ ↓	Select Item
Enter	Select
+ -	Change Option
F1	General Help
F7	Previous Values
F9	Optimized Defaults
F10	Save & Reset
Esc	Exit

Getting Help

After entering the Setup menu, the first menu you will see is the Main Menu.

Main Menu

The main menu lists the setup functions you can make changes to. You can use the arrow keys (↑ ↓) to select the item. The on-line description of the highlighted setup function is displayed at the bottom of the screen.

Sub-Menu

If you find a right pointer symbol appears to the left of certain fields that means a sub-menu can be launched from this field. A sub-menu contains additional options for a field parameter. You can use arrow keys (↑ ↓) to highlight the field and press <Enter> to call up the sub-menu. Then you can use the control keys to enter values and move from field to field within a sub-menu. If you want to return to the main menu, just press the <Esc >.

General Help <F1>

The BIOS setup program provides a General Help screen. You can call up this screen from any menu by simply pressing <F1>. The Help screen lists the appropriate keys to use and the possible selections for the highlighted item. Press <Esc> to exit the Help screen.

The Menu Bar

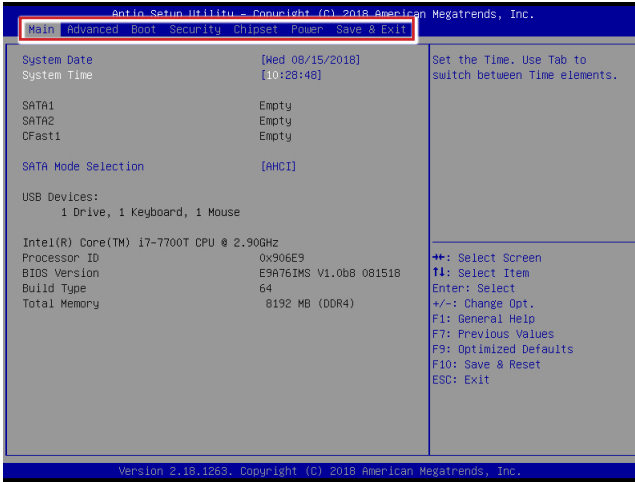

► Main

Use this menu for basic system configurations, such as time, date, etc.

► Advanced

Use this menu to set up the items of special enhanced features.

► Boot

Use this menu to specify the priority of boot devices.

► Security

Use this menu to set supervisor and user passwords.

► Chipset

This menu controls the advanced features of the onboard chipsets.

► Power

Use this menu to specify your settings for power management.

► Save & Exit

This menu allows you to load the BIOS default values or factory default settings into the BIOS and exit the BIOS setup utility with or without changes.

Main

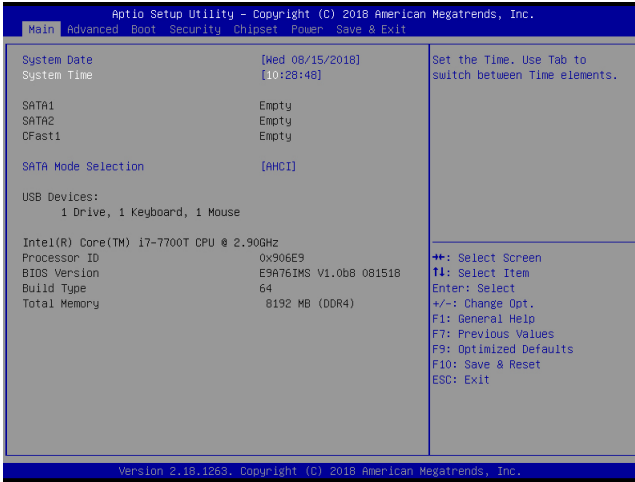

► System Date

This setting allows you to set the system date. The date format is <Day>, <Month> <Date> <Year>.

► System Time

This setting allows you to set the system time. The time format is <Hour> <Minute> <Second>.

► SATA Mode Selection

This setting specifies the SATA controller mode.

Advanced

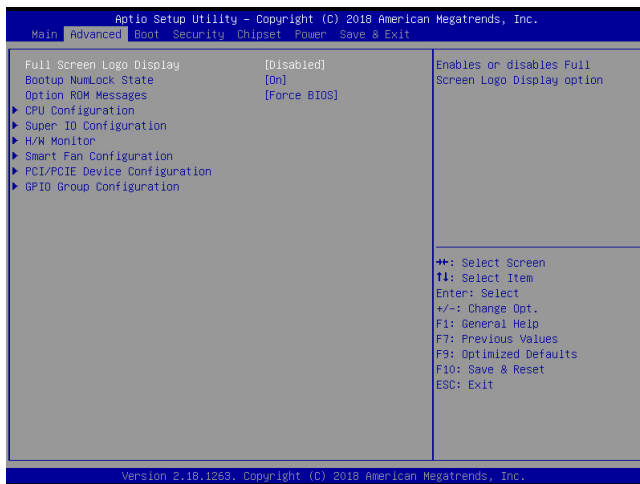

► Full Screen Logo Display

This BIOS feature determines if the BIOS should hide the normal POST messages with the motherboard or system manufacturer's full-screen logo.

When it is enabled, the BIOS will display the full-screen logo during the boot-up sequence, hiding normal POST messages.

When it is disabled, the BIOS will display the normal POST messages, instead of the full-screen logo.

Please note that enabling this BIOS feature often adds 2-3 seconds of delay to the booting sequence. This delay ensures that the logo is displayed for a sufficient amount of time. Therefore, it is recommended that you disable this BIOS feature for a faster boot-up time.

► Bootup NumLock State

This setting is to set the Num Lock status when the system is powered on. Setting to [On] will turn on the Num Lock key when the system is powered on. Setting to [Off] will allow users to use the arrow keys on the numeric keypad.

► Option ROM Messages

This item is used to determine the display mode when an optional ROM is initialized during POST. When set to [Force BIOS], the display mode used by AMI BIOS is used. Select [Keep Current] if you want to use the display mode of optional ROM.

► CPU Configuration

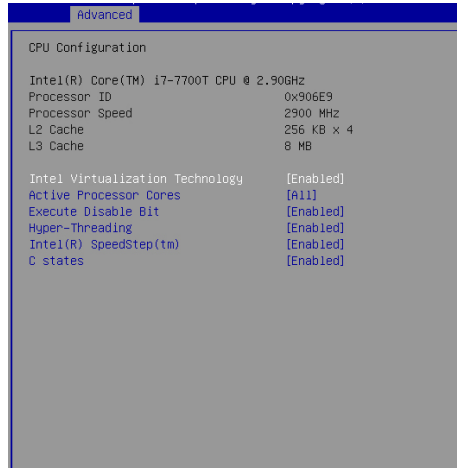

► Intel Virtualization Technology

Virtualization enhanced by Intel Virtualization Technology will allow a platform to run multiple operating systems and applications in independent partitions. With virtualization, one computer system can function as multiple “Virtual” systems.

► Active Processor Cores

This setting specifies the number of active processor cores.

► Execute Disable Bit

Intel’s Execute Disable Bit functionality can prevent certain classes of malicious “buffer overflow” attacks when combined with a supporting operating system. This functionality allows the processor to classify areas in memory by where application code can execute and where it cannot. When a malicious worm attempts to insert code in the buffer, the processor disables code execution, preventing damage or worm propagation.

► Hyper-Threading

The processor uses Hyper-Threading technology to increase transaction rates and reduces end-user response times. The technology treats the two cores inside the processor as two logical processors that can execute instructions simultaneously. In this way, the system performance is highly improved. If you disable the function, the processor will use only one core to execute the instructions. Please disable this item if your operating system doesn’t support HT Function, or unreliability and instability may occur.

► C-States

C-state performance indicates the ability to run the processor in lower power states when the PC is idle. This setting enables/disables the C-State Configuration for power saving purposes.

► Intel(R) SpeedStep(tm)

EIST (Enhanced Intel SpeedStep Technology) allows the system to dynamically adjust processor voltage and core frequency, which can result in decreased average power consumption and decreased average heat production. When disabled, the processor will return the actual maximum CPUID input value of the processor when queried.

► Super IO Configuration



► Serial Port 1/ 2/ 3/ 4/ 5

This setting enables/disables the specified serial port.

► Change Settings

This setting is used to change the address & IRQ settings of the specified serial port.

► Mode Select

Select an operation mode for the specified serial port.

► Watch Dog Timer

You can enable the system watch-dog timer, a hardware timer that generates a reset when the software that it monitors does not respond as expected each time the watch dog polls it.

► FIFO Mode

This setting controls the FIFO data transfer mode.

► Shared IRQ Mode

This setting provides the system with the ability to share interrupts among its serial ports.

► H/W Monitor

These items display the current status of all monitored hardware devices/ components such as voltages, temperatures and all fans' speeds.

Advanced	
PC Health Status	
Thermal Shutdown	[Disabled]
CPU temperature	: +55 C
System temperature	: +40 C
SYSFAN1	: N/A
VCC_CORE	: +0.912 V
VCC3	: +3.279 V
VCC5	: +4.961 V
+12V	: +12.056 V
VCC3V	: +3.296 V
VSB3V	: +3.296 V
VSB5V	: +4.872 V
VBAT	: +3.104 V

► Smart Fan Configuration

Advanced	
Configuration Smart FAN	
SYSFAN1	[Disabled]

► SYSFAN1

These settings enable/disable the Smart Fan function. Smart Fan is an excellent feature which will adjust the CPU/system fan speed automatically depending on the current CPU/system temperature, avoiding the overheating to damage your system.

► **PCI/PCIE Device Configuration**

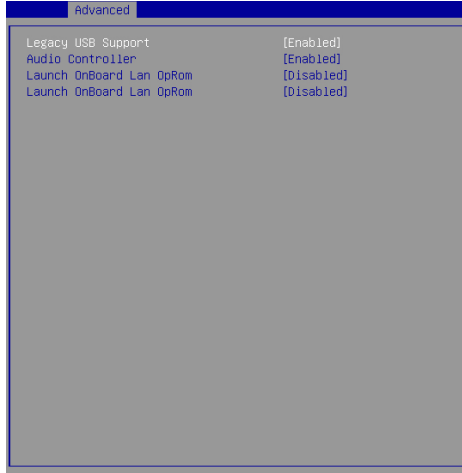

► **Legacy USB Support**

Set to [Enabled] if you need to use any USB 1.1/2.0 device in the operating system that does not support or have any USB 1.1/2.0 driver installed, such as DOS and SCO Unix.

► **Audio Controller**

This setting enables/disables the onboard audio controller.

► **Launch OnChip/OnBoard LAN OpROM**

These settings enable/disable the initialization of the onboard/onchip LAN Boot ROM during bootup. Selecting [Disabled] will speed up the boot process.

▶ GPIO Group Configuration

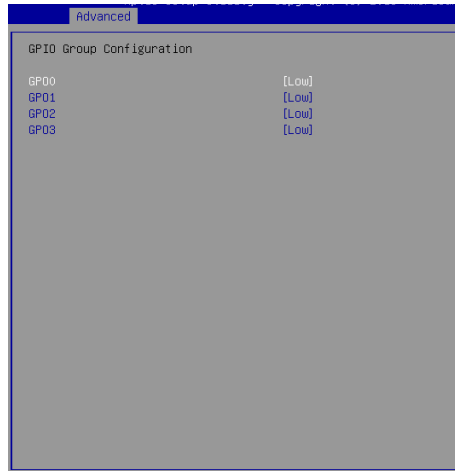

▶ GPIO0 ~ GPIO3 Data

These settings control the operation mode of the specified GPIO.

Boot

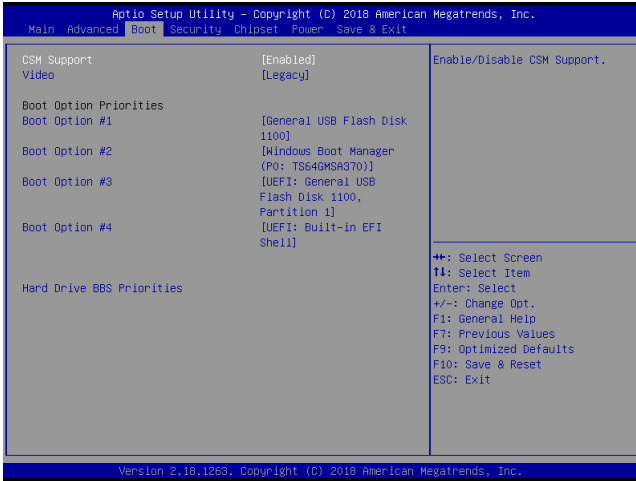

► CSM Support

This setting enables/disables the support for Compatibility Support Module, a part of the Intel Platform Innovation Framework for EFI providing the capability to support legacy BIOS interfaces.

Important

If the Operating System is going to boot in UEFI mode, disable CSM Support to speed up the boot process.

► Video

This setting controls the execution of UEFI and Legacy Video OpROM.

► Boot Option Priorities

This setting allows users to set the sequence of boot devices where BIOS attempts to load the disk operating system.

► Hard Drive BBS Priorities

This setting allows users to set the priority of the specified devices. First press <Enter> to enter the sub-menu. Then you may use the arrow keys (↑↓) to select the desired device, then press <+>, <-> or <PageUp>, <PageDown> key to move it up/down in the priority list.

Security

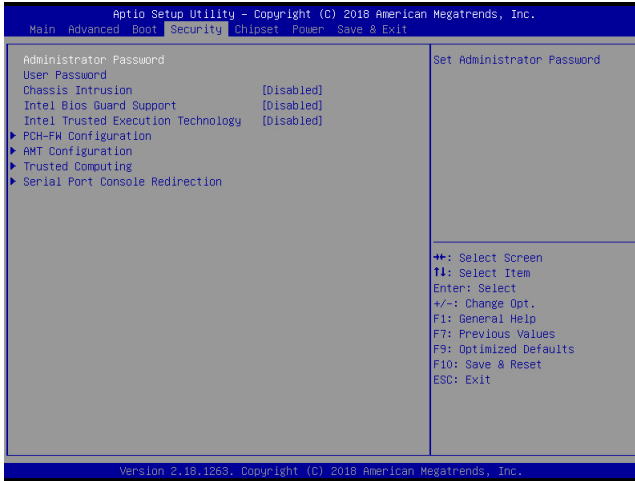

▶ Administrator Password

Administrator Password controls access to the BIOS Setup utility.

▶ User Password

User Password controls access to the system at boot and to the BIOS Setup utility.

▶ Chassis Intrusion

The field enables or disables the feature of recording the chassis intrusion status and issuing a warning message if the chassis is once opened.

▶ Intel BIOS Guard Support

Intel BIOS Guard Support ensures that updates to system BIOS flash are secure.

▶ Intel Trusted Execution Technology

Intel Trusted Execution Technology provides highly scalable platform security in physical and virtual infrastructures.

► PCH-FW Configuration

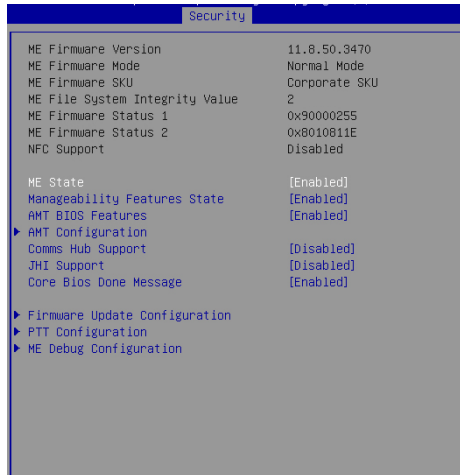

► **ME FW Version, ME Firmware Mode/ Type/ SKU**

These settings show the firmware information of the Intel ME (Management Engine).

► **ME State**

This setting enables/disables ME State.

► **Manageability Features State**

This setting enables/disables Manageability Features State.

► **AMT BIOS Features**

This setting enables/disables AMT BIOS Feature.

► **Comms Hub Support**

This setting enables/disables Communications Hub Support.

► **JHI Support**

This setting enables/disables support for Intel Dynamic Application Loader Host Interface (JHI).

► **Core BIOS Done Message**

This setting enables/disables Core BIOS Done Message sent to ME.

► Firmware Update Configuration



► ME FW Image Re-Flash

This setting enables/disables the ME FW image reflash.

► PTT Configuration

This menu offers Intel PTT (Platform Trust Technology) Configuration settings.

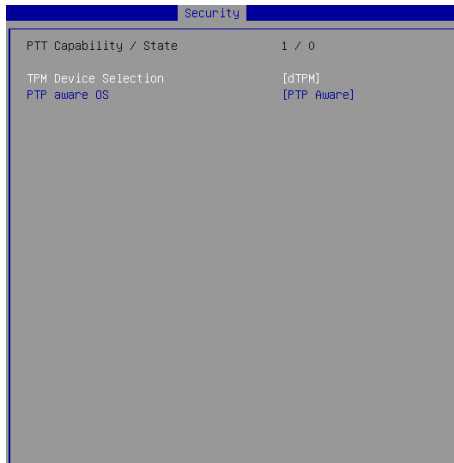

► **ME Debug Configuration**

This menu offers ME Debug settings for testing purposes.

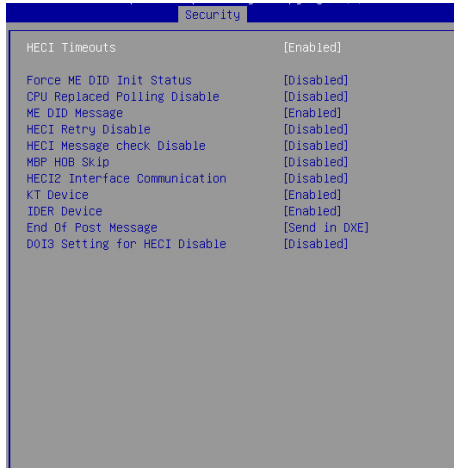

► **AMT Configuration**

Intel Active Management Technology (AMT) is hardware-based technology for remotely managing and securing PCs out-of-band.



► Trusted Computing

Security	
TPM2.0 Device Found	
Vendor: IFX	
Firmware Version: 5.62	
Security Device Support	[Enable]
Active PCR banks	SHA-1,SHA256
Available PCR banks	SHA-1,SHA256
SHA-1 PCR Bank	[Enabled]
SHA256 PCR Bank	[Enabled]
Pending operation	[None]
Platform Hierarchy	[Enabled]
Storage Hierarchy	[Enabled]
Endorsement Hierarchy	[Enabled]
TPM2.0 UEFI Spec Version	[TCG_2]
Physical Presence Spec Version	[1,3]
TPM 2.0 InterfaceType	[TIS]

► Security Device Support

This setting enables/disables BIOS support for security device. When set to [Disable], the OS will not show security device. TCG EFI protocol and INT1A interface will not be available.

► SHA-1 PCR Bank, SHA256 PCR Bank

These settings enable/disable the SHA-1 PCR Bank and SHA256 PCR Bank.

► Pending Operation

When **Security Device Support** is set to [Enable], **Pending Operation** will appear. Set this item to [TPM Clear] to clear all data secured by TPM or [None] to discard the selection. It is advised that users should routinely back up their TPM secured data.

► Platform Hierarchy, Storage Hierarchy, Endorsement Hierarchy

These settings enable/disable the Platform Hierarchy, Storage Hierarchy and Endorsement Hierarchy.

► TPM2.0 UEFI Spec Version, Physical Presence Spec Version

This settings show the TPM2.0 UEFI Spec Version and Physical Presence Spec Version.

► TPM2.0 Interface Type

This setting shows the TPM2.0 Interface Type.

► **Serial Port Console Redirection**

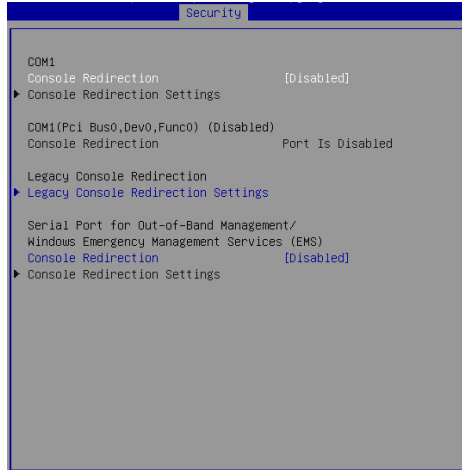

► **Console Redirection**

Console Redirection operates in host systems that do not have a monitor and keyboard attached. This setting enables/disables the operation of console redirection. When set to [Enabled], BIOS redirects and sends all contents that should be displayed on the screen to the serial COM port for display on the terminal screen. Besides, all data received from the serial port is interpreted as keystrokes from a local keyboard.

► **Legacy Console Redirection Settings**



► **Redirection COM Port**

This setting specifies the COM port for redirection.

► **Resolution**

This setting specifies the redirection resolution of legacy OS.

► **Redirect After POST**

This setting determines whether or not to keep terminals' console redirection running after the POST has booted.

► **Console Redirection Settings**

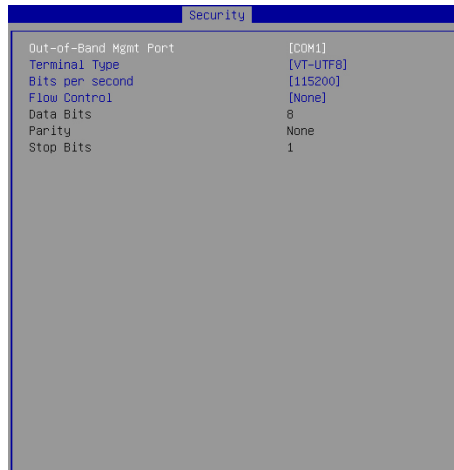

► **Out-of-Band Mgmt Port**

This setting specifies the Out-of-Band Management Port

► **Terminal Type**

To operate the system's console redirection, you need a terminal supporting ANSI terminal protocol and a RS-232 null modem cable connected between the host system and terminal(s). This setting specifies the type of terminal device for console redirection.

► **Bits per second, Data Bits, Parity, Stop Bits**

This setting specifies the transfer rate (bits per second, data bits, parity, stop bits) of Console Redirection.

► **Flow Control**

Flow control is the process of managing the rate of data transmission between two nodes. It's the process of adjusting the flow of data from one device to another to ensure that the receiving device can handle all of the incoming data. This is particularly important where the sending device is capable of sending data much faster than the receiving device can receive it.

Chipset

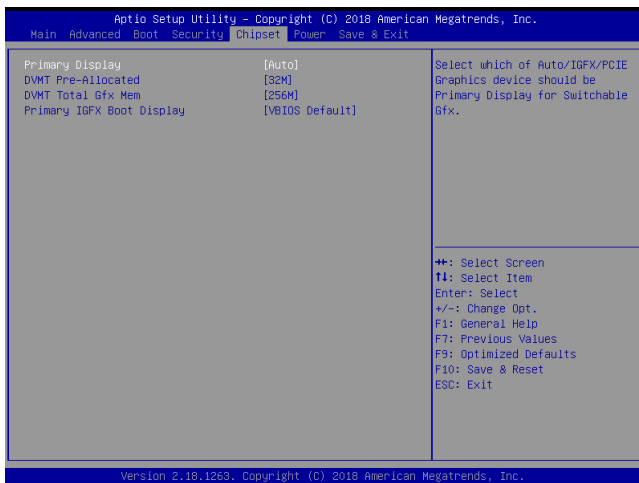

► Primary Display

This setting specifies which is your primary graphics adapter.

► DVMT Pre-Allocated

This setting defines the DVMT pre-allocated memory. Pre-allocated memory is the small amount of system memory made available at boot time by the system BIOS for video. Pre-allocated memory is also known as locked memory. This is because it is "locked" for video use only and as such, is invisible and unable to be used by the operating system.

► DVMT Total Gfx Mem

This setting specifies the memory size for DVMT.

► Primary IGFX Boot Display

Use the field to select the type of device you want to use as the display(s) of the system.

Power

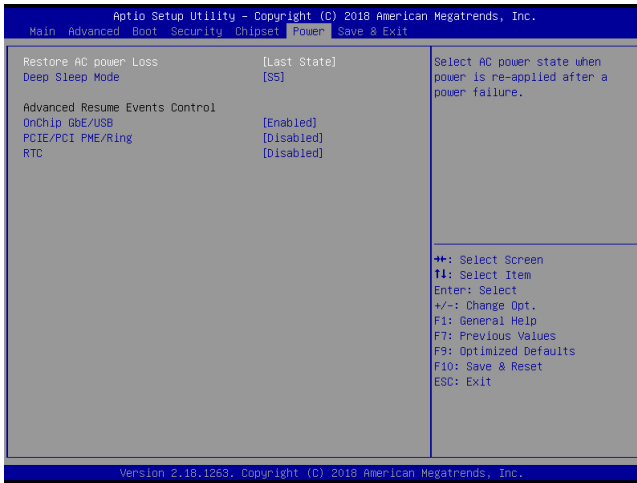

► Restore AC Power Loss

This setting specifies whether your system will reboot after a power failure or interrupt occurs. Available settings are:

[Power Off]	Leaves the computer in the power off state.
[Power On]	Leaves the computer in the power on state.
[Last State]	Restores the system to the previous status before power failure or interrupt occurred.

► Deep Sleep Mode

The setting specifies the Deep Sleep power saving mode. S5 is almost the same as G3 Mechanical Off, except that the PSU still supplies power, at a minimum, to the power button to allow return to S0. A full reboot is required. No previous content is retained. Other components may remain powered so the computer can “wake” on input from the keyboard, clock, modem, LAN, or USB device.

** Advanced Resume Events Control **

► USB from S3/S4

The item allows the activity of the USB device to wake up the system from S3/S4 sleep state.

► **OnChip GbE/USB**

This field specifies whether the system will be awakened from power saving modes when activity or input signal of onchip Gigabit Ethernet or USB is detected.

► **PCIE/PCI PME**

This field specifies whether the system will be awakened from power saving modes when activity or input signal of onboard PCIE/PCI PME is detected.

► **Ring**

An input signal on the serial Ring Indicator (RI) line (in other words, an incoming call on the modem) awakens the system from a soft off state.

► **RTC**

When [Enabled], you can set the date and time at which the RTC (real-time clock) alarm awakens the system from suspend mode.

Save & Exit

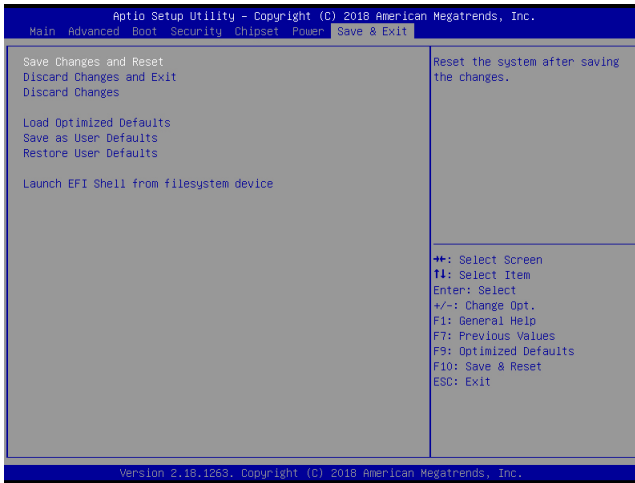

► Save Changes and Reset

Save changes to CMOS and reset the system.

► Discard Changes and Exit

Abandon all changes and exit the Setup Utility.

► Discard Changes

Abandon all changes.

► Load Optimized Defaults

Use this menu to load the default values set by the motherboard manufacturer specifically for optimal performance of the motherboard.

► Save as User Defaults

Save changes as the user's default profile.

► Restore User Defaults

Restore the user's default profile.

► Launch EFI Shell from filesystem device

This setting helps to launch the EFI Shell application from one of the available file system devices.

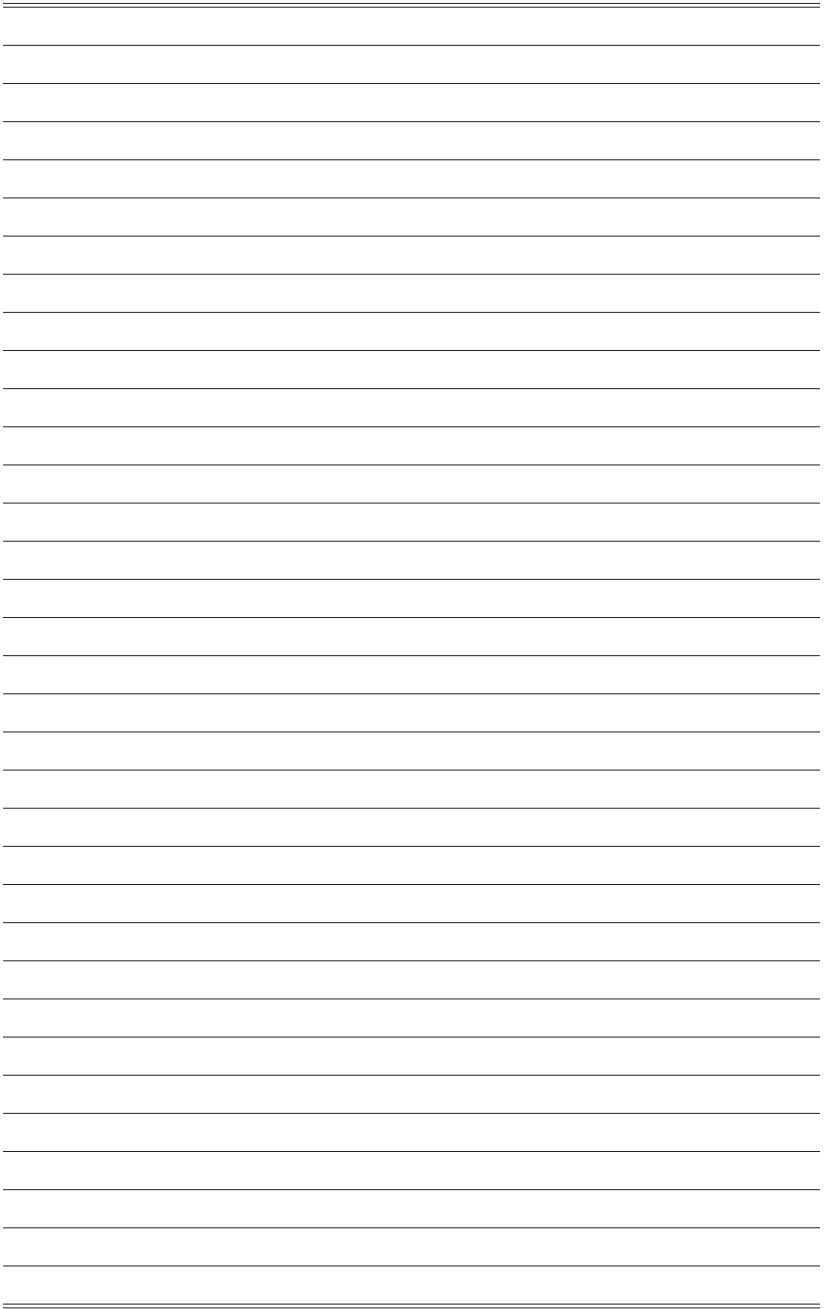

Appendix

WDT, GPIO, DIO



This appendix provides information on WDT (Watch Dog Timer), GPIO (General Purpose Input/Output) and DIO (Digital Input/Output).

Abstract

In this document, code examples based on C programming language are provided for customer interest. `Inportb`, `Outportb`, `Inportl` and `Outportl` are basic functions used for access IO ports and defined as following.

`Inportb`: Read a single 8-bit I/O port.

`Outportb`: Write a single byte to an 8-bit port.

`Inportl`: Reads a single 32-bit I/O port.

`Outportl`: Write a single long to a 32-bit port.

WDT Sample Code

1. Watchdog Timer – WDT

The base address (WDT_BASE) of WDT configuration registers is 0xA10.

1.1 Set WDT Time Unit

```
val = Inportb (WDT_BASE + 0x05); // Read current WDT setting
val = val | 0x08; // minute mode, val = val & 0xF7 if second
mode
Outportb (WDT_BASE + 0x05, val); // Write back WDT setting
```

1.2 Set WDT Time

```
Outportb (WDT_BASE + 0x06, Time); // Write WDT time, value 1 to 255.
```

1.3 Enable WDT

```
val = Inportb (WDT_BASE + 0x0A); // Read current WDT_PME setting
val = val | 0x01; // Enable WDT OUT: WDOUT_EN (bit 0) set
to 1.
Outportb (WDT_BASE + 0x0A, val); // Write back WDT setting.
val = Inportb (WDT_BASE + 0x05); // Read current WDT setting
val = val | 0x20; // Enable WDT by set WD_EN (bit 5) to 1.
Outportb (WDT_BASE + 0x05, val); // Write back WDT setting.
```

1.4 Disable WDT

```
val = Inportb (WDT_BASE + 0x05); // Read current WDT setting
val = val & 0xDF; // Disable WDT by set WD_EN (bit 5) to 0.
Outportb (WDT_BASE + 0x05, val); // Write back WDT setting.
```

1.5 Check WDT Reset Flag

If the system has been reset by WDT function, this flag will set to 1.

```
val = Inportb (WDT_BASE + 0x05); // Read current WDT setting.
val = val & 0x40; // Check WDTMOUT_STS (bit 6).
if (val) printf ("timeout event occurred");
else printf ("timeout event not occurred");
```

1.6 Clear WDT Reset Flag

```
val = Inportb (WDT_BASE + 0x05); // Read current WDT setting
val = val | 0x40; // Set 1 to WDTMOUT_STS (bit 6);
Outportb (WDT_BASE + 0x05, val); // Write back WDT setting
```

GPIO Sample Code

2. General Purposed IO – GPIO/DIO

The GPIO port configuration addresses are listed in the following table:

Name	IO Port	IO address	Name	IO Port	IO address
N_GPIO0	0xA05	Bit 7	N_GPO0	0xA05	Bit 3
N_GPIO1	0xA05	Bit 2	N_GPO1	0xA05	Bit 4
N_GPIO2	0xA05	Bit 1	N_GPO2	0xA05	Bit 5
N_GPIO3	0xA05	Bit 0	N_GPO3	0xA05	Bit 6

2.1 Set output value of GPO

1. Read the value from GPO port.
2. Set the value of GPO address.
3. Write the value back to GPO port.

Example: Set N_GPO0 output “high”

```
val = Inportb (0xA05);           // Read value from N_GPO0 port.
val = val | (1<<3);             // Set N_GPO0 address (bit 3) to 1 (output
                                // “high”).
Outportb (0xA05, val);         // Write back to N_GPO0 port.
```

Example: Set N_GPO1 output “low”

```
val = Inportb (0xA05);           // Read value from N_GPO1 port.
val = val & ~(1<<4);           // Set N_GPO1 address (bit 4) to 0 (output
                                // “low”).
Outportb (0xA05, val);         // Write back to N_GPO1 port.
```

2.2 Read input value from GPI

1. Read the value from GPI port.
2. Get the value of GPI address.

Example: Get N_GPI2 input value.

```
val = Inportb (0xA05);           // Read value from N_GPI2 port.
val = val & (1<<1);             // Read N_GPI2 address (bit 1).
if (val) printf (“Input of N_GPI2 is High”);
else     printf (“Input of N_GPI2 is Low”);
```

Digital I/O Connector

The MS-9A76 features an onboard isolated digital I/O circuit and supports the following features:

- 4-CH Isolated DI
 - Logic high: 5 to 35 V
 - Logic low: 0 to 1.5 V
 - Isolation type: Digital Isolator (ISOW7844)
 - Isolation voltage: 1500 V DC
- 4-CH Isolated DO
 - Output Type: MOSFET + BJT transistor
 - Sink current up to 100 mA (sustained loading) or 250 mA (peak loading) on each isolated output channel
 - Supply voltage: 5 to 35 V DC
 - Isolation type: Digital Isolator (ISO7740)
 - Isolation voltage: 1500 V DC
- Isolated 5V DC Power Source for DO
 - Supply voltage: 5 ± 0.5 V DC
 - Supply current: 180 mA (maximum)
 - Isolation type: DC-to-DC transformer
 - Isolation voltage: 1000 VRMS (channel to system)
 - Data transfer: programmed IO
 - Software Driver support for Windows 7 32/64 Bit, Windows 8.1 32/64 Bit, Windows 10 64 Bit



Digital I/O Pin Header

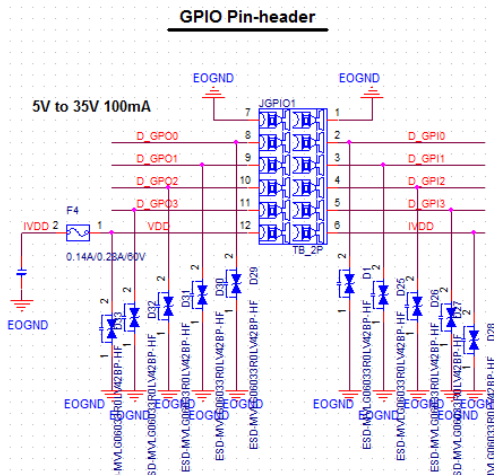

► Isolated Digital Input Circuits

Input accepts voltages up to 35V.

Applications

- Industrial Automation
- Motor Control
- Grid Infrastructure
- Medical Equipment
- Test and Measurement

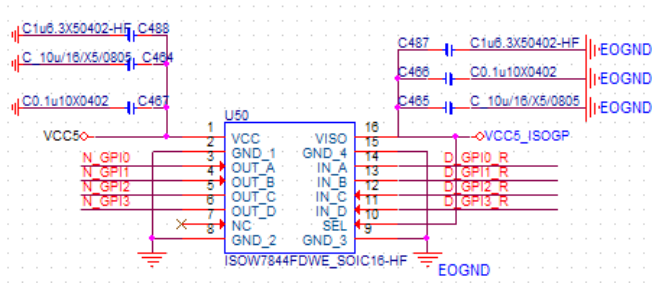

► Isolated Digital Output Circuits

Each isolation digital output channel adopts a MOSFET + BJT transistor, capable of driving peak current up to 250mA (sustained current up to 100 mA) with voltage ranges from 5V to 35V.

Applications

- Industrial Automation
- Motor Control
- Power Supplies
- Solar Inverters
- Medical Equipment

