

MS-98I8

(v1.x) Industrial Computer Board



Copyright Notice

The material in this document is the intellectual property of **MICRO-STAR INTERNATIONAL**. We take every care in the preparation of this document, but no guarantee is given as to the correctness of its contents. Our products are under continual improvement and we reserve the right to make changes without notice.

Trademarks

All trademarks are the properties of their respective owners.

Revision History

Revision	Date
V1.1	2016/12

Technical Support

If a problem arises with your system and no solution can be obtained from the user's manual, please contact your place of purchase or local distributor. Alternatively, please try the following help resources for further guidance.

Visit the MSI website for technical guide, BIOS updates, driver updates and other information, or contact our technical staff via <http://www.msi.com/support/>

Safety Instructions

- Always read the safety instructions carefully.
- Keep this User's Manual for future reference.
- Keep this equipment away from humidity.
- Lay this equipment on a reliable flat surface before setting it up.
- The openings on the enclosure are for air convection hence protects the equipment from overheating. **DO NOT COVER THE OPENINGS.**
- Make sure the voltage of the power source and adjust properly 110/220V before connecting the equipment to the power inlet.
- Place the power cord such a way that people can not step on it. Do not place anything over the power cord.
- Always Unplug the Power Cord before inserting any add-on card or module.
- All cautions and warnings on the equipment should be noted.
- Never pour any liquid into the opening that could damage or cause electrical shock.
- If any of the following situations arises, get the equipment checked by service personnel:
 - The power cord or plug is damaged.
 - Liquid has penetrated into the equipment.
 - The equipment has been exposed to moisture.
 - The equipment does not work well or you can not get it work according to User's Manual.
 - The equipment has dropped and damaged.
 - The equipment has obvious sign of breakage.
- **DO NOT LEAVE THIS EQUIPMENT IN AN ENVIRONMENT UNCONDITIONED, STORAGE TEMPERATURE ABOVE 60°C (140°F), IT MAY DAMAGE THE EQUIPMENT.**

警告使用者:

這是甲類資訊產品，在居住的環境中使用時，可能會造成無線電干擾，在這種情況下，使用者會被要求採取某些適當的對策。

Chemical Substances Information

In compliance with chemical substances regulations, such as the EU REACH Regulation (Regulation EC No. 1907/2006 of the European Parliament and the Council), MSI provides the information of chemical substances in products at:

http://www.msi.com/html/popup/csr/evmtrpt_pcm.html

Battery Information



European Union:

Batteries, battery packs, and accumulators should not be disposed of as unsorted household waste. Please use the public collection system to return, recycle, or treat them in compliance with the local regulations.



廢電池請回收

Taiwan:

For better environmental protection, waste batteries should be collected separately for recycling or special disposal.



California, USA:

The button cell battery may contain perchlorate material and requires special handling when recycled or disposed of in California.

For further information please visit:

<http://www.dtsc.ca.gov/hazardouswaste/perchlorate/>

Danger of explosion if battery is incorrectly replaced. Replace only with the same or equivalent type recommended by the manufacturer.

CE Conformity

Hereby, Micro-Star International CO., LTD declares that this device is in compliance with the essential safety requirements and other relevant provisions set out in the European Directive.



FCC-A Radio Frequency Interference Statement



This equipment has been tested and found to comply with the limits for a Class A digital device, pursuant to Part 15 of the FCC Rules. These limits are designed to provide reasonable protection against harmful interference when the equipment is operated in a commercial environment. This equipment generates, uses and can radiate radio frequency energy and, if not installed and used in accordance with the instruction manual, may cause harmful interference to radio communications. Operation of this equipment in a residential area is likely to cause harmful interference, in which case the user will be required to correct the interference at his own expense.

Notice 1

The changes or modifications not expressly approved by the party responsible for compliance could void the user's authority to operate the equipment.

Notice 2

Shielded interface cables and AC power cord, if any, must be used in order to comply with the emission limits.

VOIR LA NOTICE D'INSTALLATION AVANT DE RACCORDER AU RESEAU.

This device complies with Part 15 of the FCC Rules. Operation is subject to the following two conditions:

- 1) this device may not cause harmful interference, and
- 2) this device must accept any interference received, including interference that may cause undesired operation.

WEEE Statement

Under the European Union ("EU") Directive on Waste Electrical and Electronic Equipment, Directive 2002/96/EC, which takes effect on August 13, 2005, products of "electrical and electronic equipment" cannot be discarded as municipal waste anymore and manufacturers of covered electronic equipment will be obligated to take back such products at the end of their useful life. MSI will comply with the product take back requirements at the end of life of MSI-branded products that are sold into the EU. You can return these products to local collection points.



Japan JIS C 0950 Material Declaration

A Japanese regulatory requirement, defined by specification JIS C 0950, mandates that manufacturers provide material declarations for certain categories of electronic products offered for sale after July 1, 2006.

http://www.msi.com/html/popup/csr/cemm_jp.html

http://tw.msi.com/html/popup/csr_tw/cemm_jp.html

日本JIS C 0950材質宣言

日本工業規格JIS C 0950により、2006年7月1日以降に販売される特定分野の電気および電子機器について、製造者による含有物質の表示が義務付けられます。

http://www.msi.com/html/popup/csr/cemm_jp.html

http://tw.msi.com/html/popup/csr_tw/cemm_jp.html

India RoHS

This product complies with the "India E-waste (Management and Handling) Rule 2011" and prohibits use of lead, mercury, hexavalent chromium, polybrominated biphenyls or polybrominated diphenyl ethers in concentrations exceeding 0.1 weight % and 0.01 weight % for cadmium, except for the exemptions set in Schedule 2 of the Rule.

Turkey EEE Regulation

Conforms to the EEE Regulations of the Republic Of Turkey

Türkiye EEE yönetmeliği

Türkiye Cumhuriyeti: EEE Yönetmeliğine Uygundur

Ukraine Restriction of Hazardous Substances

The equipment complies with requirements of the Technical Regulation, approved by the Resolution of Cabinet of Ministry of Ukraine as of December 3, 2008 № 1057, in terms of restrictions for the use of certain dangerous substances in electrical and electronic equipment.

Україна обмеження на наявність небезпечних речовин

Обладнання відповідає вимогам Технічного регламенту щодо обмеження використання деяких небезпечних речовин в електричному та електронному обладнанні, затвердженого постановою Кабінету Міністрів України від 3 грудня 2008 № 1057.

Vietnam RoHS

As from December 1, 2012, all products manufactured by MSI comply with Circular 30/2011/TT-BCT temporarily regulating the permitted limits for a number of hazardous substances in electronic and electric products.

Việt Nam RoHS

Kể từ ngày 01/12/2012, tất cả các sản phẩm do công ty MSI sản xuất tuân thủ Thông tư số 30/2011/TT-BCT quy định tạm thời về giới hạn hàm lượng cho phép của một số hóa chất độc hại có trong các sản phẩm điện, điện tử"

CONTENTS

Copyright Notice.....	ii
Trademarks	ii
Revision History	ii
Technical Support.....	ii
Safety Instructions.....	iii
Chemical Substances Information	iv
Battery Information	iv
CE Conformity.....	v
FCC-A Radio Frequency Interference Statement	v
WEEE Statement	v
1. Overview.....	1-1
Motherboard Specifications.....	1-2
Motherboard Layout.....	1-4
2. Hardware Setup	2-1
Memory	2-3
Power Supply.....	2-4
Rear Panel I/O	2-5
Connector.....	2-6
Jumper	2-12
Slot.....	2-14
3. BIOS Setup.....	3-1
Entering Setup	3-2
The Menu Bar	3-4
Main	3-5
Advanced	3-6
Boot.....	3-12
Security	3-13
Chipset	3-17
Power.....	3-18
Save & Exit.....	3-20
Appendix WDT & GPIO	A-1
WDT Sample Code	A-2
GPIO Sample Code	A-3

1 Overview

Thank you for choosing the MS-9818, an excellent industrial computer board.

Based on the innovative Intel® Braswell N3160/N3010 SoC for optimal system efficiency, the MS-9818 supports up to 8GB of onboard DDR3L 1600MHz memory and allows connection to 3 or 2 independent displays with HDMI, DisplayPort and LVDS outputs.

The MS-9818 is durable under extreme environments and suitable to be applied in every industrial field, such as digital signage, kiosk, gaming, industrial control automation and POS.

Motherboard Specifications

Processor

- Intel® Celeron® N3160 Processor (QC/1.6 GHz/2.24 GHz for Burst/TDP-6W)
- Intel® Celeron® N3010 Processor (DC/1.04 GHz/2.24 GHz for Burst/TDP-4W)

Memory

- 1 SO-DIMM slot for single-channel DDR3L 1600MHz
- Up to 8GB

Networking

- LAN1: Realtek® RTL8111G GbE LAN
- LAN2: Realtek® RTL8111G GbE LAN

Storage

- 1 x SATA 6Gb/s port
- 1 x mSATA 6Gb/s slot (shared with MINI_PCIE1)

Audio

- Realtek® ALC887-VD2-CG HD Audio Codec
- 1 x Front audio connector
- 1 x Amplifier connector

Graphics

- HD Graphics integrated in Intel® processor
- LVDS up to 1920 x 1200 @ 60 Hz
- HDMI up to 2560 x 1600 @ 60 Hz, 3840 x 2160 @ 30 Hz
- DisplayPort up to 2560 x 1600 @ 60 Hz, 3840 x 2160 @ 30 Hz
- Supports three independent displays: LVDS + HDMI + DisplayPort

Rear Panel I/O

- 1 x HDMI port
- 1 x DisplayPort
- 2 x RJ45 GbE LAN ports
- 4 x USB 3.0 ports

Onboard Connectors

- 1 x 4-pin DC power connector
- 1 x 4-pin SATA power connector
- 1 x System FAN connector
- 1 x SATA 6Gb/s port
- 1 x USB 2.0 connector (2 ports)
- 1 x RS232/422/485 serial port connector
- 3 x RS232 serial port connectors
- 1 x Front panel connector
- 1 x Front audio connector
- 1 x Amplifier connector
- 1 x GPIO connector
- 1 x LVDS connector
- 1 x Inverter connector
- 1 x PS/2 keyboard/mouse connector
- 1 x LPC connector
- 1 x Clear CMOS jumper
- 1 x Inverter power jumper
- 1 x LVDS power jumper
- 1 x AT/ATX select jumper
- 1 x COM port power jumper

Expansion Slot

- 2 x Mini-PCIe slots (MINI_PCIE1 supports mSATA)

Form Factor

- 146 mm x 102 mm (3.5-inch size)

Environment

- Operating temperature: -10 ~ 60°C
- Storage temperature: -20 ~ 80°C
- Humidity: 10 ~ 90% RH, non-condensing

Motherboard Layout

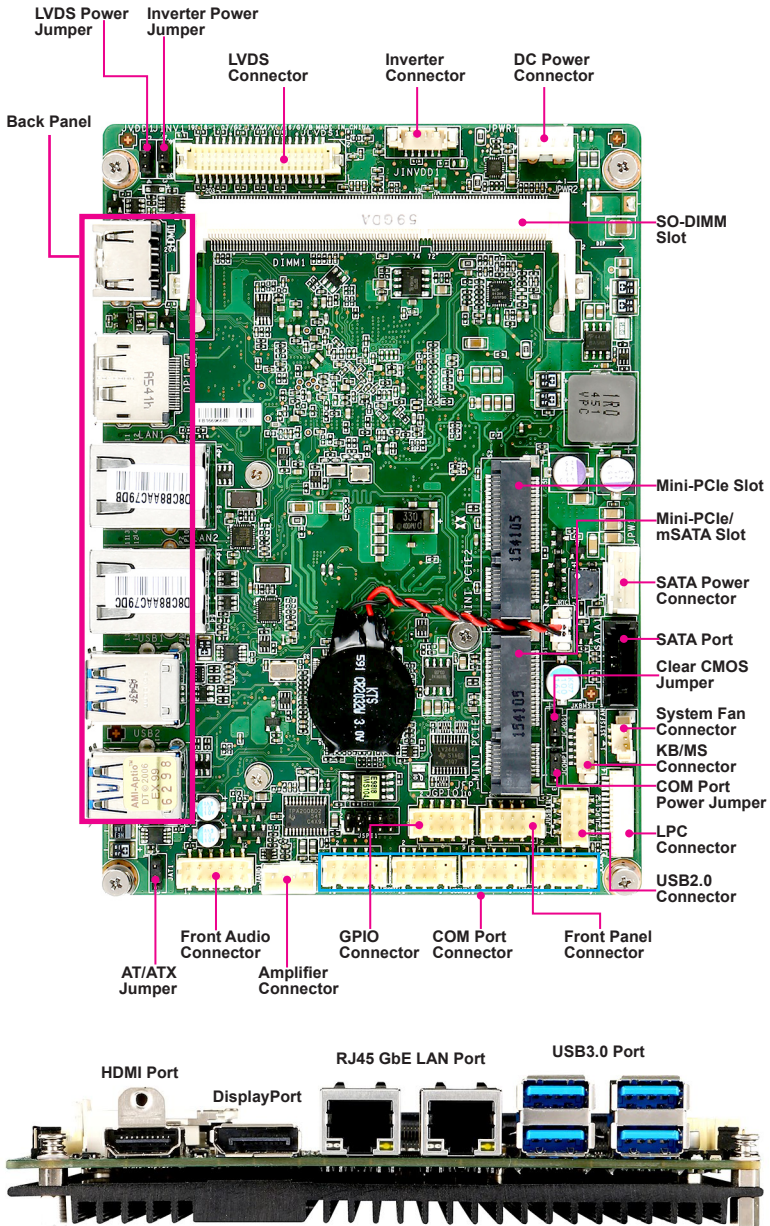

2 Hardware Setup

This chapter provides you with the information about hardware setup procedures. While doing the installation, be careful in holding the components and follow the installation procedures. For some components, if you install in the wrong orientation, the components will not work properly.

Use a grounded wrist strap before handling computer components. Static electricity may damage the components.

Components Reference Guide

Memory	2-3
Power Supply	2-4
DC-In Power Connector: JPWR1.....	2-4
SATA Power Connector: JPW1.....	2-4
Rear Panel I/O	2-5
Connector	2-6
Fan Power Connector: SYSFAN1.....	2-6
Serial ATA Connector: SATA1.....	2-6
Front Panel Connector: JFP1.....	2-7
Front Audio Connector: JAUD1.....	2-7
Audio Amplifier Connector: JAMP1.....	2-7
GPIO Connector: JGPIO1.....	2-8
RS232 Serial Port Connector: JCOM2, JCOM3, JCOM4.....	2-8
RS232/422/485 Serial Port Connector: JCOM1.....	2-9
LVDS Inverter Connector: JINVDD1.....	2-10
LVDS Connector: JLVDS1.....	2-10
Keyboard/Mouse Connector: JKBMS1.....	2-11
USB 2.0 Header: JUSB1.....	2-11
LPC Debug Port Connector: JLPC1 (With TPM Support).....	2-11
Jumper	2-12
Clear CMOS Jumper: JCMOS1.....	2-12
AT/ATX Select Jumper: JAT1.....	2-12
Serial Port Power Jumper: JCOMP1.....	2-13
LVDS Power Jumper: JVDD1.....	2-13
LVDS Inverter Power Jumper: JINV1.....	2-13
Slot	2-14
Mini-PCIe (Peripheral Component Interconnect Express) Slot.....	2-14

Memory

The SO-DIMM slot is intended for memory modules.

1. Locate the SO-DIMM slot. Align the notch on the DIMM with the key on the slot and insert the DIMM into the slot.

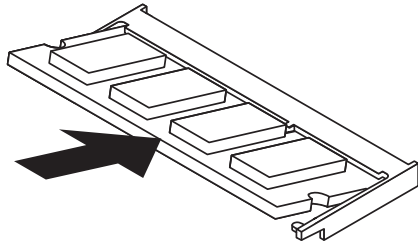

2. Push the DIMM gently downwards until the slot levers click and lock the DIMM in place.

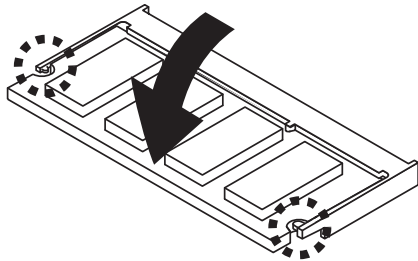

3. To uninstall the DIMM, flip the slot levers outwards and the DIMM will be released instantly.

Important

You can barely see the golden finger if the DIMM is properly inserted in the DIMM slot.

Power Supply

DC-In Power Connector: JPWR1

This connector is used to provide power to the motherboard.

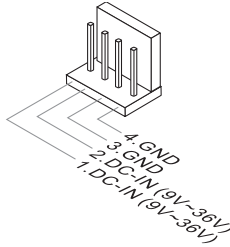

SATA Power Connector: JPW1

This connector is used to provide power to SATA devices.

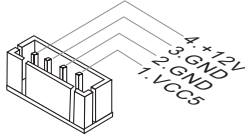

Important

Make sure that all power connectors are connected to the power supply to ensure stable operation of the motherboard.

Rear Panel I/O

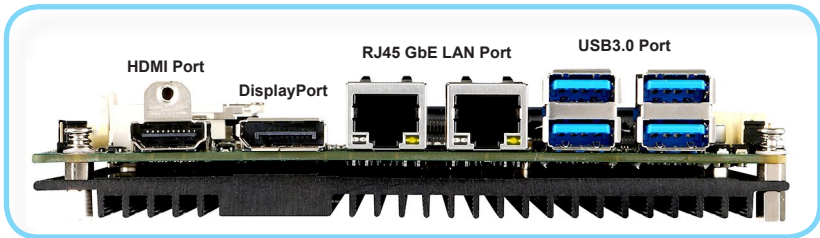

➤ HDMI Port **HDMI™** HIGH-DEFINITION MULTIMEDIA INTERFACE

The High-Definition Multimedia Interface (HDMI) is an all-digital audio/video interface capable of transmitting uncompressed streams. HDMI supports all TV format, including standard, enhanced, or high-definition video, plus multi-channel digital audio on a single cable.

➤ DisplayPort

DisplayPort is a digital display interface standard. This connector is used to connect a monitor with DisplayPort inputs.

➤ RJ45 GbE LAN Port

The standard single RJ45 LAN jack is provided for connection to the Local Area Network (LAN). You can connect a network cable to it.

<p>Speed LED</p> <p>Active LED</p>	LED	LED Status	Description
	Active LED	Off	No link
		Yellow	Linked
		Blinking	Data activity
	Speed LED	Off	10 Mbps connection
		Green	100 Mbps connection
Orange		1 Gbps connection	

➤ USB 3.0 Port

The USB 3.0 port is backward-compatible with USB 2.0 devices and supports data transfer rate up to 5 Gbit/s (SuperSpeed).

Connector

Fan Power Connector: SYSFAN1

The fan power connector supports system cooling fan with +12V. When connecting the wire to the connectors, always note that the red wire is the positive and should be connected to the +12V; the black wire is Ground and should be connected to GND. If the motherboard has a System Hardware Monitor chipset onboard, you must use a specially designed fan with speed sensor to take advantage of the CPU fan control.



Serial ATA Connector: SATA1

This connector is a high-speed Serial ATA interface port. Each connector can connect to one Serial ATA device.

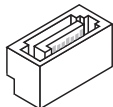

Important

Please do not fold the SATA cable into a 90-degree angle. Otherwise, data loss may occur during transmission.

Front Panel Connector: JFP1

This front panel connector is provided for electrical connection to the front panel switches & LEDs and is compliant with Intel Front Panel I/O Connectivity Design Guide.

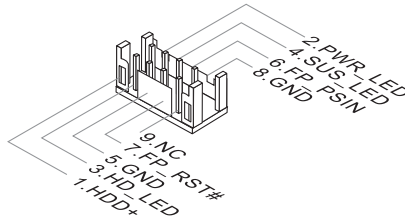

Front Audio Connector: JAUD1

This connector allows you to connect the front panel audio and is compliant with Intel Front Panel I/O Connectivity Design Guide.

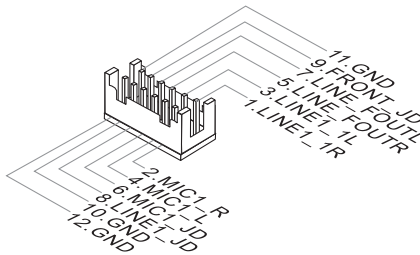

Audio Amplifier Connector: JAMP1

The connector is used to connect audio amplifiers to enhance audio performance.

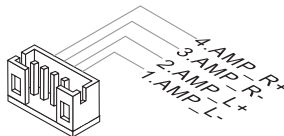

GPIO Connector: JGPIO1

This connector is provided for the General-Purpose Input/Output (GPIO) peripheral module.

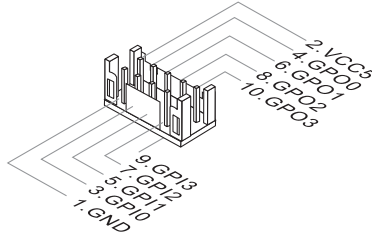

RS232 Serial Port Connector: JCOM2, JCOM3, JCOM4

This connector is a 16550A high speed communications port that sends/receives 16 bytes FIFOs. You can attach serial devices to it through the optional serial port bracket.

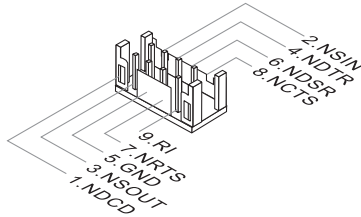

PIN	SIGNAL	DESCRIPTION
1	NDCD	Data Carrier Detect
2	NSIN	Signal In
3	NSOUT	Signal Out
4	NDTR	Data Terminal Ready
5	GND	Signal Ground
6	NDSR	Data Set Ready
7	NRTS	Request To Send
8	NCTS	Clear To Send
9	RI	Ring Indicator

RS232/422/485 Serial Port Connector: JCOM1

This connector is a 16550A high speed communications port that sends/receives 16 bytes FIFOs. You can attach a serial device to it through an optional serial port bracket.

RS232

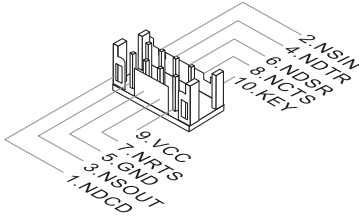

PIN	SIGNAL	DESCRIPTION
1	NDCD	Data Carrier Detect
2	NSIN	Signal In
3	NSOUT	Signal Out
4	NDTR	Data Terminal Ready
5	GND	Signal Ground
6	NDSR	Data Set Ready
7	NRTS	Request To Send
8	NCTS	Clear To Send
9	VCC	5V or 12V selected by jumper

RS422

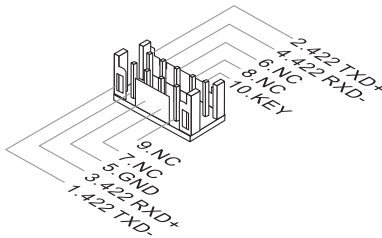

PIN	SIGNAL	DESCRIPTION
1	422 TXD-	Transmit Data, Negative
2	422 TXD+	Transmit Data, Positive
3	422 RXD+	Receive Data, Positive
4	422 RXD-	Receive Data, Negative
5	GND	Signal Ground
6	NC	No Connection
7	NC	No Connection
8	NC	No Connection
9	NC	No Connection

RS485

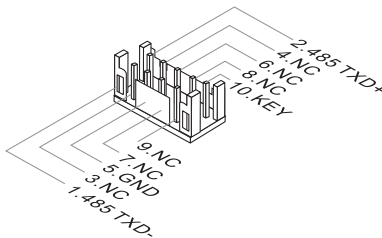

PIN	SIGNAL	DESCRIPTION
1	485 TXD-	Transmit Data, Negative
2	485 TXD+	Transmit Data, Positive
3	NC	No Connection
4	NC	No Connection
5	GND	Signal Ground
6	NC	No Connection
7	NC	No Connection
8	NC	No Connection
9	NC	No Connection

LVDS Inverter Connector: JINVDD1

The connector is provided for LCD backlight options.

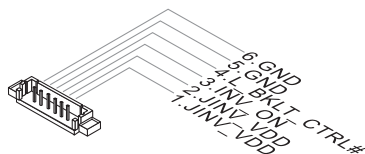

LVDS Connector: JLVDS1

The LVDS (Low Voltage Differential Signal) connector provides a digital interface typically used with flat panels. After connecting an LVDS interface flat panel to the JLVDS1, be sure to check the panel datasheet and set the LVDS jumper to proper power voltage.

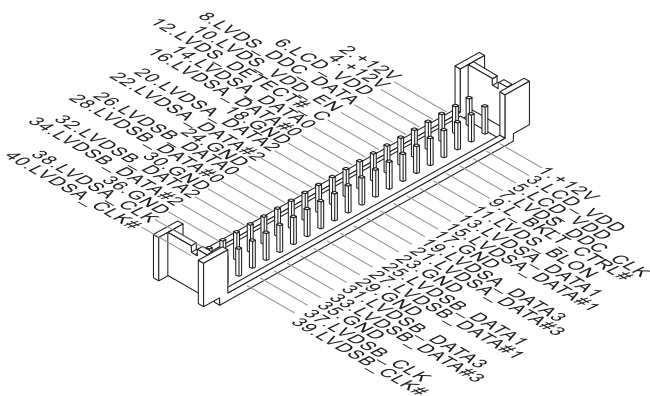

Important

Pin 12 is a detect pin. When using a customized LVDS cable, pin 12 should be a signal ground with a low impedance. Otherwise, LVDS will not function.

Keyboard/Mouse Connector: JKBMS1

This connector is provided to connect a keyboard and a mouse.

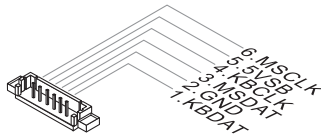

USB 2.0 Header: JUSB1

This connector, compliant with Intel I/O Connectivity Design Guide, is ideal for connecting high-speed USB interface peripherals such as USB HDD, digital cameras, MP3 players, printers, modems and the like.

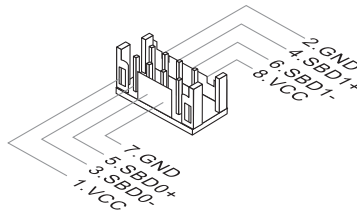

Important

Note that the pins of VCC and GND must be connected correctly to avoid possible damage.

LPC Debug Port Connector: JLPC1 (With TPM Support)

This connector works as LPC debug port and supports TPM modules through an adapter.

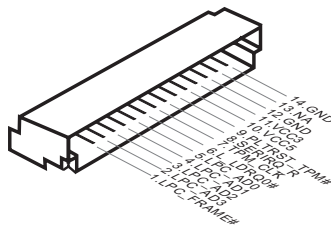

Jumper

Important

Avoid adjusting jumpers when the system is on; it will damage the motherboard.

Clear CMOS Jumper: JCMOS1

There is a CMOS RAM onboard that has a power supply from an external battery to keep the data of system configuration. With the CMOS RAM, the system can automatically boot OS every time it is turned on. If you want to clear the system configuration, set the jumper to clear data.



Normal



Clear CMOS

Important

You can clear CMOS by shorting 2-3 pin while the system is off. Then return to 1-2 pin position. Avoid clearing the CMOS while the system is on; it will damage the motherboard.

AT/ATX Select Jumper: JAT1

This jumper allows users to select between AT and ATX power.



ATX



AT

Serial Port Power Jumper: JCOMP1

The jumper specifies the operation voltage of the specified serial port.



LVDS Power Jumper: JVDD1

Use this jumper to specify the operation voltage of the LVDS display.



LVDS Inverter Power Jumper: JINV1

Use this jumper to specify the operation voltage of the LVDS inverter.

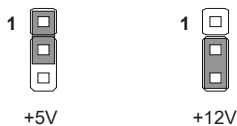

Slot

Mini-PCle (Peripheral Component Interconnect Express) Slot

The Mini-PCle slot is provided for WiFi modules, Bluetooth modules, TV tuner cards and other Mini-PCle cards.

- **MINI_PCIE1** supports **Mini-PCle** and **mSATA** cards.
- **MINI_PCIE2** only supports **Mini-PCle** cards.

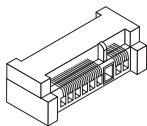

Important

When adding or removing expansion cards, make sure that you unplug the power supply first. Meanwhile, read the documentation for the expansion card to configure any necessary hardware or software settings for the expansion card, such as jumpers, switches or BIOS configuration.

3 BIOS Setup

This chapter provides information on the BIOS Setup program and allows users to configure the system for optimal use.

Users may need to run the Setup program when:

- An error message appears on the screen at system startup and requests users to run SETUP.
- Users want to change the default settings for customized features.

Important

- *Please note that BIOS update assumes technician-level experience.*
- *As the system BIOS is under continuous update for better system performance, the illustrations in this chapter should be held for reference only.*

Entering Setup

Power on the computer and the system will start POST (Power On Self Test) process. When the message below appears on the screen, press or <F2> key to enter Setup.

Press or <F2> to enter SETUP

If the message disappears before you respond and you still wish to enter Setup, restart the system by turning it OFF and On or pressing the RESET button. You may also restart the system by simultaneously pressing <Ctrl>, <Alt>, and <Delete> keys.

Important

The items under each BIOS category described in this chapter are under continuous update for better system performance. Therefore, the description may be slightly different from the latest BIOS and should be held for reference only.

Control Keys

← →	Select Screen
↑ ↓	Select Item
Enter	Select
+ -	Change Option
F1	General Help
F7	Previous Values
F9	Optimized Defaults
F10	Save & Exit
Esc	Exit

Getting Help

After entering the Setup menu, the first menu you will see is the Main Menu.

Main Menu

The main menu lists the setup functions you can make changes to. You can use the arrow keys (↑ ↓) to select the item. The on-line description of the highlighted setup function is displayed at the bottom of the screen.

Sub-Menu

If you find a right pointer symbol appears to the left of certain fields that means a sub-menu can be launched from this field. A sub-menu contains additional options for a field parameter. You can use arrow keys (↑ ↓) to highlight the field and press <Enter> to call up the sub-menu. Then you can use the control keys to enter values and move from field to field within a sub-menu. If you want to return to the main menu, just press the <Esc >.

General Help <F1>

The BIOS setup program provides a General Help screen. You can call up this screen from any menu by simply pressing <F1>. The Help screen lists the appropriate keys to use and the possible selections for the highlighted item. Press <Esc> to exit the Help screen.

The Menu Bar

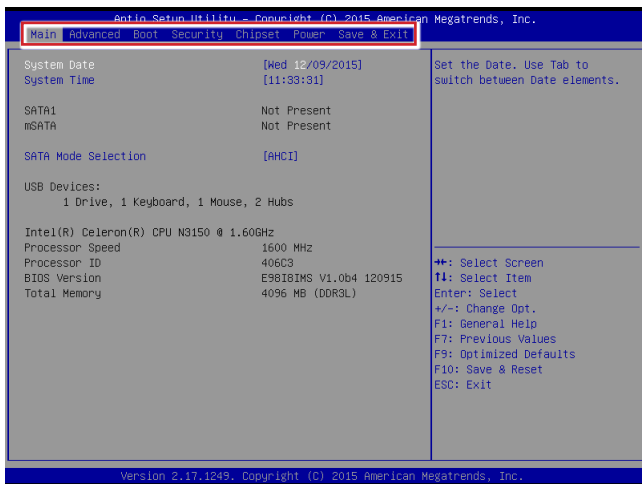

► Main

Use this menu for basic system configurations, such as time, date, etc.

► Advanced

Use this menu to set up the items of special enhanced features.

► Boot

Use this menu to specify the priority of boot devices.

► Security

Use this menu to set supervisor and user passwords.

► Chipset

This menu controls the advanced features of the onboard chipsets.

► Power

Use this menu to specify your settings for power management.

► Save & Exit

This menu allows you to load the BIOS default values or factory default settings into the BIOS and exit the BIOS setup utility with or without changes.

Main

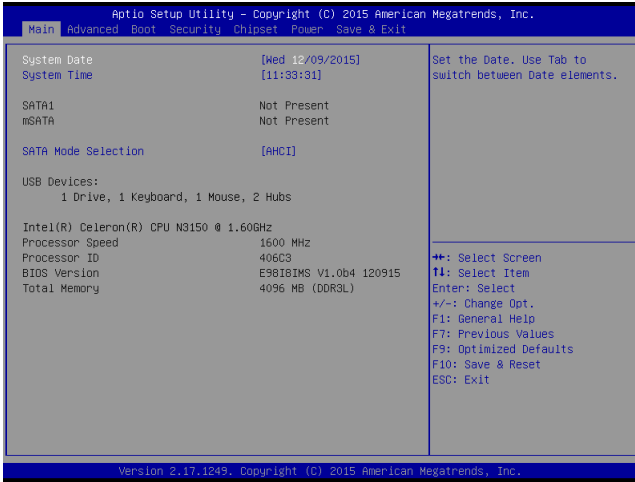

► System Date

This setting allows you to set the system date. The date format is <Day>, <Month> <Date> <Year>.

► System Time

This setting allows you to set the system time. The time format is <Hour> <Minute> <Second>.

► SATA Mode Selection

This setting specifies the SATA controller mode.

Advanced

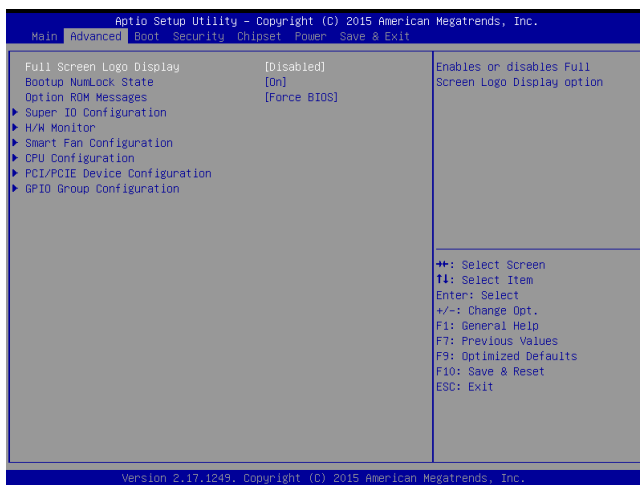

► Full Screen Logo Display

This BIOS feature determines if the BIOS should hide the normal POST messages with the motherboard or system manufacturer's full-screen logo.

When it is enabled, the BIOS will display the full-screen logo during the boot-up sequence, hiding normal POST messages.

When it is disabled, the BIOS will display the normal POST messages, instead of the full-screen logo.

Please note that enabling this BIOS feature often adds 2-3 seconds of delay to the booting sequence. This delay ensures that the logo is displayed for a sufficient amount of time. Therefore, it is recommended that you disable this BIOS feature for a faster boot-up time.

► Bootup NumLock State

This setting is to set the Num Lock status when the system is powered on. Setting to [On] will turn on the Num Lock key when the system is powered on. Setting to [Off] will allow users to use the arrow keys on the numeric keypad.

► Option ROM Messages

This item is used to determine the display mode when an optional ROM is initialized during POST. When set to [Force BIOS], the display mode used by AMI BIOS is used. Select [Keep Current] if you want to use the display mode of optional ROM.

► Super IO Configuration



► Serial Port 1/ 2/ 3/ 4

This setting enables/disables the specified serial port.

► Change Settings

This setting is used to change the address & IRQ settings of the specified serial port.

► Mode Select

Select an operation mode for the specified serial port.

► FIFO Mode

This setting controls the FIFO data transfer mode.

► Shared IRQ Mode

This setting provides the system with the ability to share interrupts among its serial ports.

► Watch Dog Timer

You can enable the system watch-dog timer, a hardware timer that generates a reset when the software that it monitors does not respond as expected each time the watch dog polls it.

► **H/W Monitor**

These items display the current status of all monitored hardware devices/ components such as voltages, temperatures and all fans' speeds.

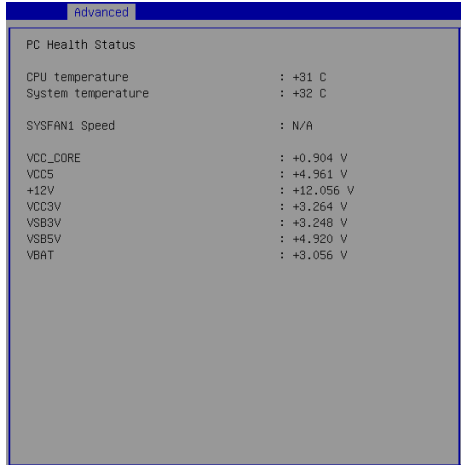

► **Smart Fan Configuration**



► **Smart SYSFAN Target**

This setting enables/disables the Smart Fan function. Smart Fan is an excellent feature which will adjust the CPU/system fan speed automatically depending on the current CPU/system temperature, avoiding the overheating to damage your system.

► CPU Configuration

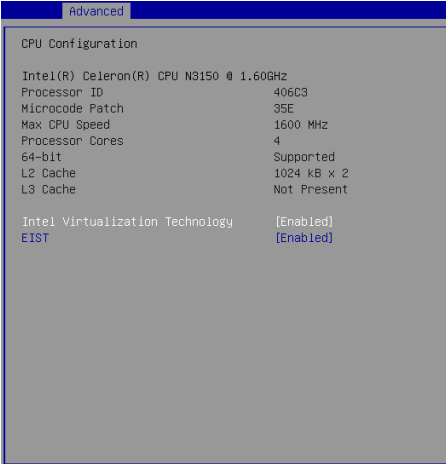

The screenshot shows a BIOS configuration window titled "Advanced" with a sub-section "CPU Configuration". The window displays the following information:

CPU Configuration	
Intel(R) Celeron(R) CPU N3150 @ 1.60GHz	
Processor ID	406C3
Microcode Patch	35E
Max CPU Speed	1600 MHz
Processor Cores	4
64-bit	Supported
L2 Cache	1024 KB x 2
L3 Cache	Not Present
Intel Virtualization Technology	[Enabled]
EIST	[Enabled]

► Intel Virtualization Technology

Virtualization enhanced by Intel Virtualization Technology will allow a platform to run multiple operating systems and applications in independent partitions. With virtualization, one computer system can function as multiple "Virtual" systems.

► EIST

EIST (Enhanced Intel SpeedStep Technology) allows the system to dynamically adjust processor voltage and core frequency, which can result in decreased average power consumption and decreased average heat production. When disabled, the processor will return the actual maximum CPUID input value of the processor when queried.

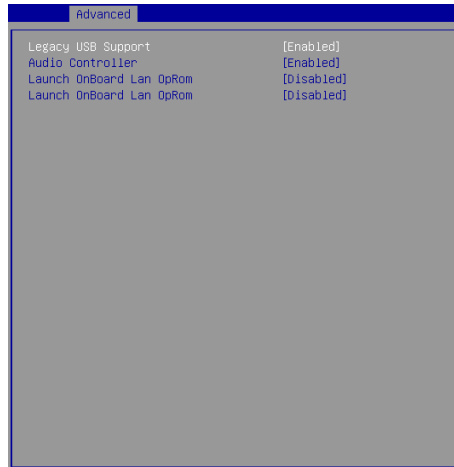
► PCI/PCIE Device Configuration**► Legacy USB Support**

Set to [Enabled] if you need to use any USB 1.1/2.0 device in the operating system that does not support or have any USB 1.1/2.0 driver installed, such as DOS and SCO Unix.

► Audio Controller

This setting enables/disables the onboard audio controller.

► Launch OnBoard LAN OpROM

These settings enable/disable the initialization of the onboard/onchip LAN Boot ROM during bootup. Selecting [Disabled] will speed up the boot process.

▶ GPIO Group Configuration

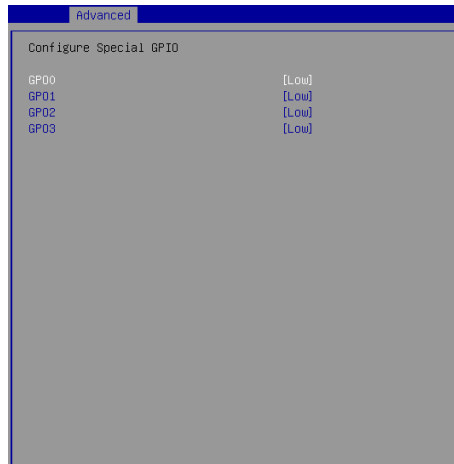

▶ GP00 ~ GP03

These settings control the operation mode of the specified GPIO.

Boot

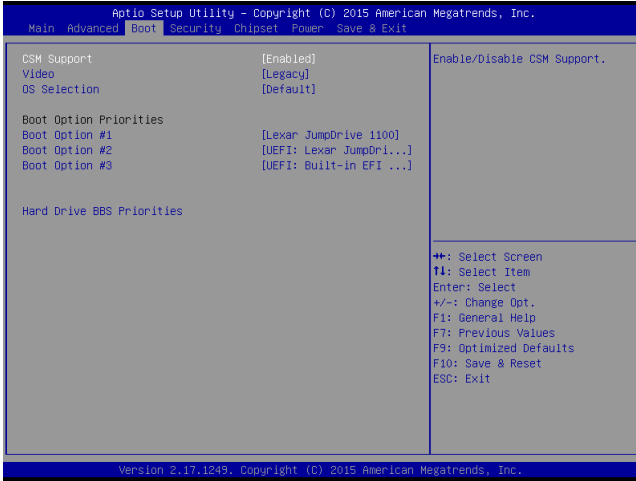

► CSM Support

This setting enables/disables the support for Compatibility Support Module, a part of the Intel Platform Innovation Framework for EFI providing the capability to support legacy BIOS interfaces.

► Video

This setting selects the video mode.

► OS Selection

This setting allows users to select the Operating System.

► Boot Option Priorities

This setting allows users to set the sequence of boot devices where BIOS attempts to load the disk operating system.

► Hard Drive BBS Priorities

This setting allows users to set the priority of the specified devices. First press <Enter> to enter the sub-menu. Then you may use the arrow keys (↑↓) to select the desired device, then press <+>, <-> or <PageUp>, <PageDown> key to move it up/down in the priority list.

Security

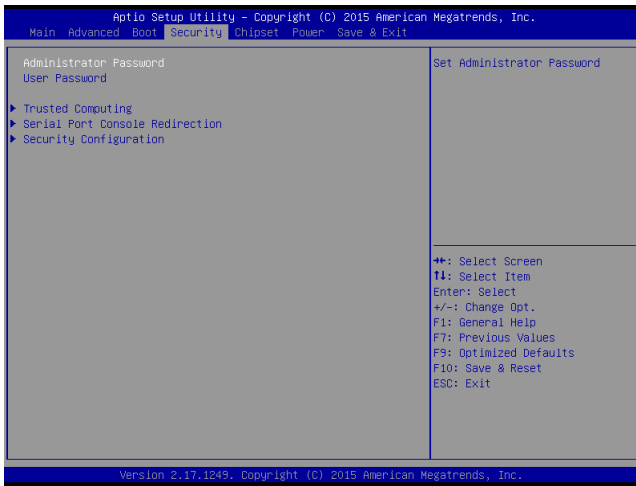

► Administrator Password

Administrator Password controls access to the BIOS Setup utility.

► User Password

User Password controls access to the system at boot and to the BIOS Setup utility.

► **Trusted Computing**



► **Security Device Support**

This setting enables/disables BIOS support for security device. When set to [Disable], the OS will not show security device. TCG EFI protocol and INT1A interface will not be available.

► **Serial Port Console Redirection**



► **Console Redirection**

Console Redirection operates in host systems that do not have a monitor and keyboard attached. This setting enables/disables the operation of console

redirection. When set to [Enabled], BIOS redirects and sends all contents that should be displayed on the screen to the serial COM port for display on the terminal screen. Besides, all data received from the serial port is interpreted as keystrokes from a local keyboard.

► Console Redirection Settings

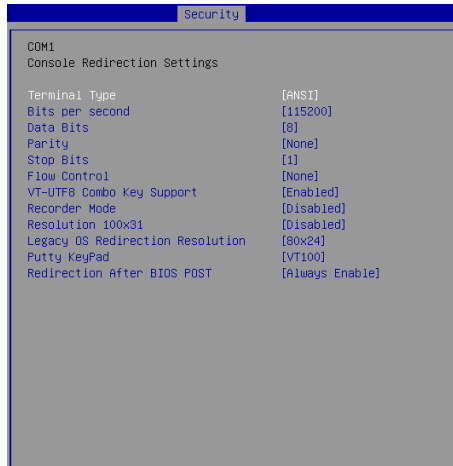

► Terminal Type

To operate the system's console redirection, you need a terminal supporting ANSI terminal protocol and a RS-232 null modem cable connected between the host system and terminal(s). This setting specifies the type of terminal device for console redirection.

► Bits per second, Data Bits, Parity, Stop Bits

This setting specifies the transfer rate (bits per second, data bits, parity, stop bits) of Console Redirection.

► Flow Control

Flow control is the process of managing the rate of data transmission between two nodes. It's the process of adjusting the flow of data from one device to another to ensure that the receiving device can handle all of the incoming data. This is particularly important where the sending device is capable of sending data much faster than the receiving device can receive it.

► VT-UTF8 Combo Key Support

This setting enables/disables the VT-UTF8 combination key support for ANSI/VT100 terminals.

► Recorder Mode, Resolution 100x31

These settings enable/disable the recorder mode and the resolution 100x31.

► **Legacy OS Redirection Resolution**

This setting specifies the redirection resolution of legacy OS.

► **Putty Keypad**

PuTTY is a terminal emulator for Windows. This setting controls the numeric keypad for use in PuTTY.

► **Redirection After BIOS POST**

This setting determines whether or not to keep terminals' console redirection running after the BIOS POST has booted.

► **Security Configuration**



► **TXE FW Version**

The setting shows the firmware information of the Intel Trusted Execution Engine (TXE).

► **TXE HMRFPO**

The setting enables/disables TXE HMRFPO (Host ME Region Flash Protection Override).

► **TXE Firmware Update**

This setting enables/disables TXE FW update.

► **TXE EOP Message**

This setting determines whether or not to send EOP (Exchange Online Protection) message before entering OS.

Chipset

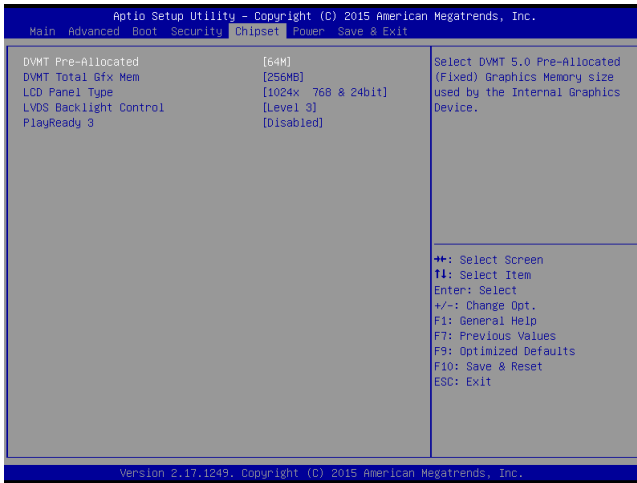

► DVMT Pre-Allocated

This setting defines the DVMT pre-allocated memory. Pre-allocated memory is the small amount of system memory made available at boot time by the system BIOS for video. Pre-allocated memory is also known as locked memory. This is because it is "locked" for video use only and as such, is invisible and unable to be used by the operating system.

► DVMT Total Gfx Mem

This setting specifies the memory size for DVMT.

► LCD Panel Type

This setting specifies the LCD panel type.

► LVDS Backlight Control

This setting controls the intensity of the LVDS backlight.

► PlayReady 3 (for Windows 10 only)

This setting enables/disables Microsoft's PlayReady 3 technology. PlayReady is a content protection technology from Microsoft that includes encryption, output protection and Digital Rights Management (DRM). Window's PlayReady 3.0 DRM can support 4K content but use more restrictive digital rights management technology to curb illegitimate streams at the same time.

Power

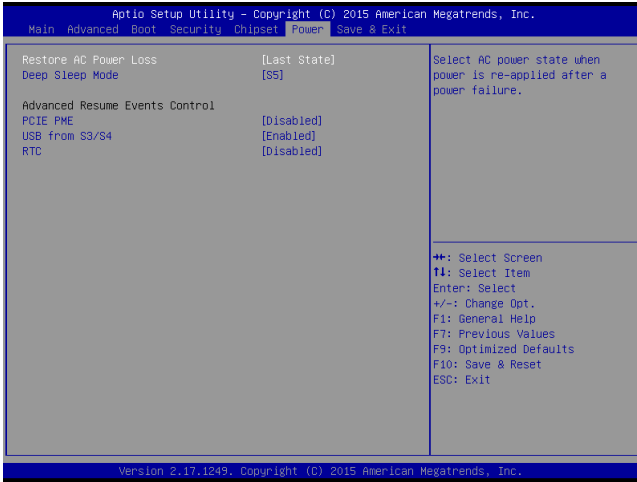

► **Restore AC Power Loss**

This setting specifies whether your system will reboot after a power failure or interrupt occurs. Available settings are:

[Power Off]	Leaves the computer in the power off state.
[Power On]	Leaves the computer in the power on state.
[Last State]	Restores the system to the previous status before power failure or interrupt occurred.

► **Deep Sleep Mode**

The setting enables/disables the Deep S5 power saving mode. S5 is almost the same as G3 Mechanical Off, except that the PSU still supplies power, at a minimum, to the power button to allow return to S0. A full reboot is required. No previous content is retained. Other components may remain powered so the computer can “wake” on input from the keyboard, clock, modem, LAN, or USB device.

**** Advanced Resume Events Control ****

► **PCIE PME**

This field specifies whether the system will be awakened from power saving modes when activity or input signal of onboard PCIE PME is detected.

► **USB from S3/S4**

The item allows the activity of the USB device to wake up the system from S3/S4 sleep state.

► **RTC**

When [Enabled], you can set the date and time at which the RTC (real-time clock) alarm awakens the system from suspend mode.

Save & Exit

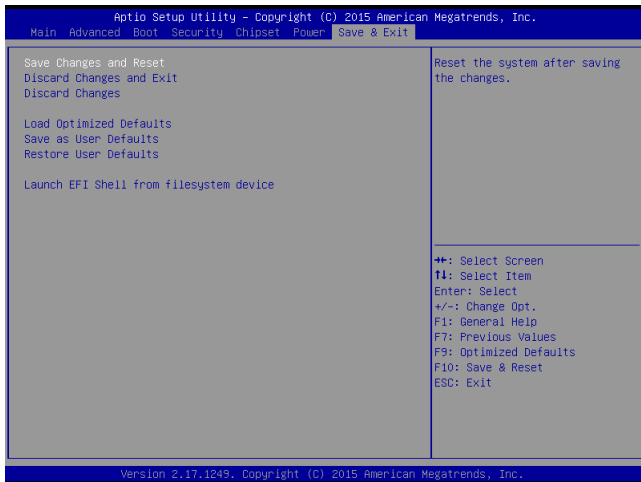

► Save Changes and Reset

Save changes to CMOS and reset the system.

► Discard Changes and Exit

Abandon all changes and exit the Setup Utility.

► Discard Changes

Abandon all changes.

► Load Optimized Defaults

Use this menu to load the default values set by the motherboard manufacturer specifically for optimal performance of the motherboard.

► Save as User Defaults

Save changes as the user's default profile.

► Restore User Defaults

Restore the user's default profile.

► Launch EFI Shell from filesystem device

This setting helps to launch the EFI Shell application from one of the available file system devices.

Appendix

WDT & GPIO



This appendix provides the sample codes of WDT (Watch Dog Timer) and GPIO (General Purpose Input/ Output).

WDT Sample Code

```

SIO_INDEX_Port    equ 04Eh
SIO_DATA_Port    equ 04Fh
SIO_UnLock_Value equ 087h
SIO_Lock_Value   equ 0AAh
WatchDog_LDN     equ 007h
WDT_UNIT         equ 60h    ;60h=second, 68h=minute, 40h=Disabled watchdog timer
WDT_Timer        equ 30    ;ex. 30 seconds

```

Sample code:

```

;Enable config mode
mov dx, SIO_INDEX_Port
mov al, SIO_UnLock_Value
out dx, al
jmp short $+2          ;Io_delay
jmp short $+2          ;Io_delay
out dx, al
;Change to WDT
mov dx, SIO_INDEX_Port
mov al, 07h
out dx, al
mov dx, SIO_DATA_Port
mov al, WatchDog_LDN
out dx, al
;Active WDT
mov dx, SIO_INDEX_Port
mov al, 30h
out dx, al
mov dx, SIO_DATA_Port
in al, dx
or al, 01h
out dx, al
;set timer
mov dx, SIO_INDEX_Port
mov al, 0F6h
out dx, al
mov dx, SIO_DATA_Port
mov al, WDT_Timer
out dx, al
;set UINIT
mov dx, SIO_INDEX_Port
mov al, 0F5h
out dx, al
mov dx, SIO_DATA_Port
mov al, WDT_UNIT
out dx, al
;enable reset
mov dx, SIO_INDEX_Port
mov al, 0FAh
out dx, al
mov dx, SIO_DATA_Port
in al, dx
or al, 01h
out dx, al
;close config mode
mov dx, SIO_INDEX_Port
mov al, SIO_Lock_Value
out dx, al

```

GPIO Sample Code

- GPI 0 ~ GPI 3

	GPI 0	GPI 1	GPI 2	GPI 3				
IO Address								
SIO GPIO Register	8Ah	8Ah	8Ah	8Ah				
Bit	0	1	2	3				
Sample code	#1							

- GPO 0 ~ GPO 3

	GPO 0	GPO 1	GPO 2	GPO 3				
IO Address								
SIO GPIO Register	89h	89h	89h	89h				
Bit	4	5	6	7				
Sample code	#2							

```

SIO_INDEX_Port      equ    04Eh
SIO_DATA_Port       equ    04Fh
SIO_UnLock_Value    equ    087h
SIO_Lock_Value      equ    0AAh
SIO_LDN_GPIO        equ    06h
SIO_GPIO_Data       equ    089h
SIO_GPIO_Status     equ    08Ah
GPI_0               equ    00000001b
GPO_0               equ    00010000b

```

Sample Code:

#1 : Get GPI 0 status

; Enable config mode

```

mov  dx, SIO_INDEX_Port
mov  al, SIO_UnLock_Value
out  dx, al
jmp  short $+2          ;Io_delay
jmp  short $+2          ;Io_delay
out  dx, al

```

; Switch GPIO Configuration for SIO LDN 0x06

```

mov  dx, SIO_INDEX_Port
mov  al, 07h
out  dx, al
mov  dx, SIO_DATA_Port
mov  al, SIO_LDN_GPIO
out  dx, al

```

; Get GPI 0 Pin Status Register

```

mov    dx, SIO_INDEX_Port
mov    al, SIO_GPIO_Status
out    dx, al
mov    dx, SIO_DATA_Port
in     al, dx                ;al bit0 = GPI 0 status

```

; Exit SIO

```

mov    dx, SIO_INDEX_Port
mov    al, SIO_Lock_Value
out    dx, al

```

#2 : Set GPO 0 to high

; Enable config mode

```

mov    dx, SIO_INDEX_Port
mov    al, SIO_UnLock_Value
out    dx, al
jmp    short $+2            ;Io_delay
jmp    short $+2            ;Io_delay
out    dx, al

```

; Switch GPIO Configuration for SIO LDN 0x06

```

mov    dx, SIO_INDEX_Port
mov    al, 07h
out    dx, al
mov    dx, SIO_DATA_Port
mov    al, SIO_LDN_GPIO
out    dx, al

```

; Set GPO 0 Register

```

mov    dx, SIO_INDEX_Port
mov    al, SIO_GPIO_Data
out    dx, al
mov    dx, SIO_DATA_Port
in     al, dx
and    al, not GPO_0
or     al, GPO_0
out    dx, al

```

; Exit SIO

```

mov    dx, SIO_INDEX_Port
mov    al, SIO_Lock_Value
out    dx, al

```