

ES220F-CS

C246
Q370
H310



8th/9th Gen Intel® Core™
Compact Fanless Embedded System



KEY FEATURES



Two HDMI 2.0

2 x HDMI 2.0 Supports 4K@60Hz resolution

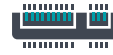

Triple Storage

1 x M.2 SSD + 2 x 2.5" SSD (option)



DDR4

2 x DDR4 SODIMM up to 64GB



RAID Support

RAID support NAS/Server application



Rich I/O

2 x Intel GbE, 4 x USB 3.1, 2 x USB 2.0, 2 x COM



PANEL

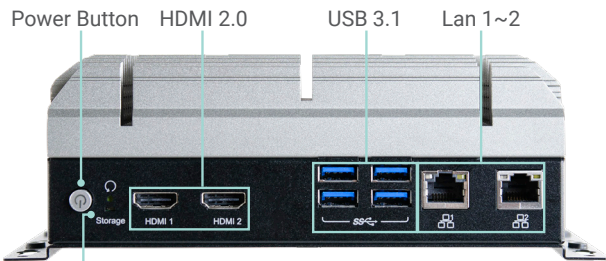

Front View
ES220F-CS (1 Storage)

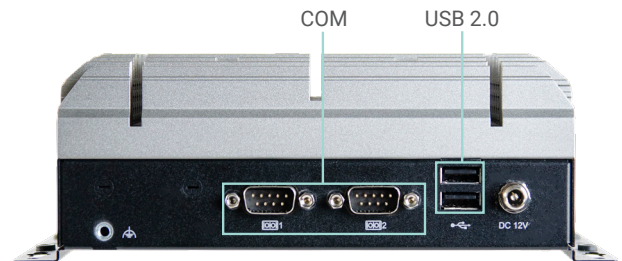

Rear View
ES220F-CS (1 Storage)

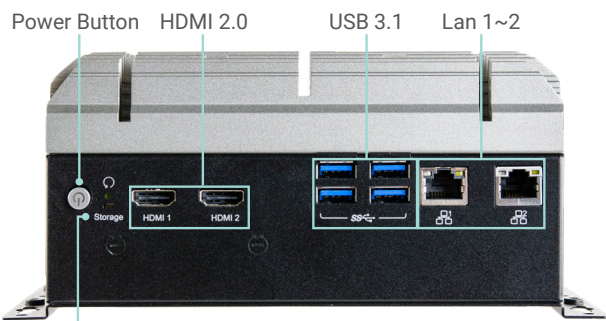

Front View
ES220F-CS (3 Storage)

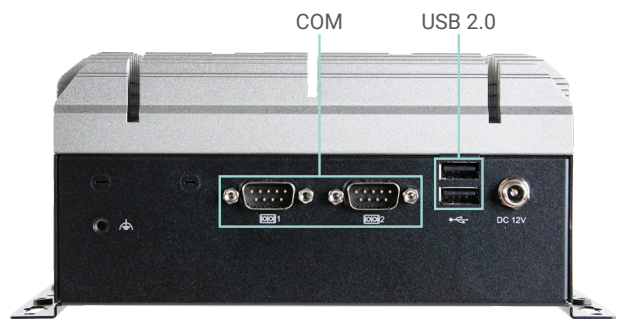

Rear View
ES220F-CS (3 Storage)

DIMENSIONS

1 Storage (1x m.2 SSD)

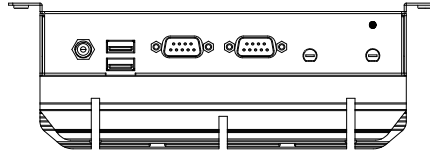

Rear View

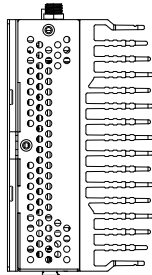

Left View

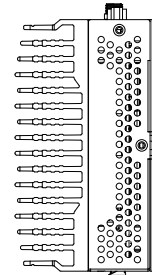
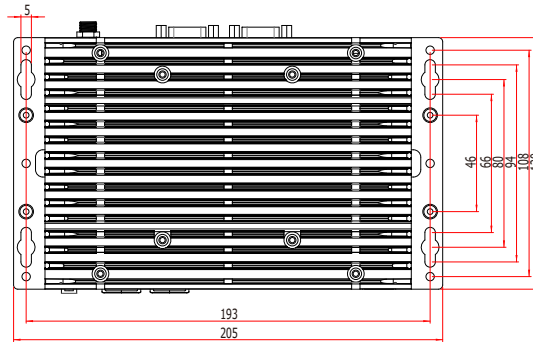

Right View

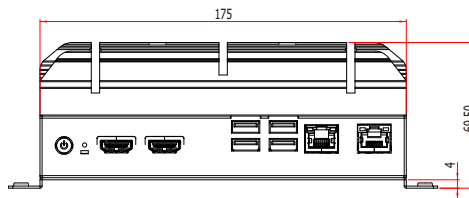

Front View

3 Storage (1x m.2 SSD + 2x 2.5" SSD)

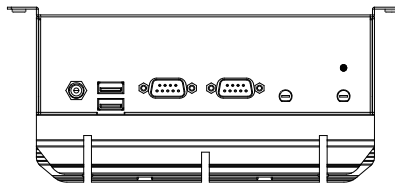

Rear View

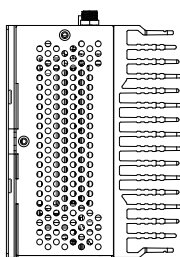

Left View

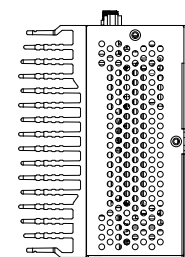
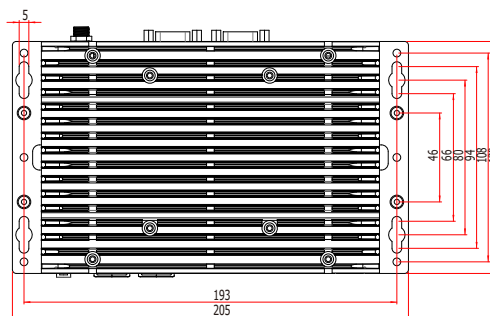

Right View

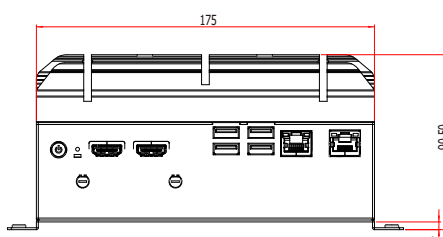

Front View

WALL MOUNTING

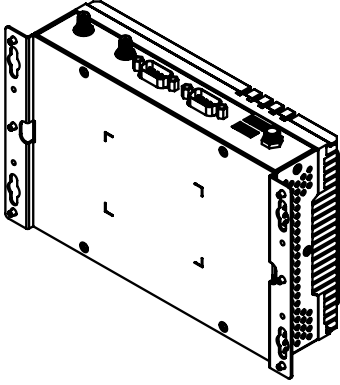

WALL MOUNT

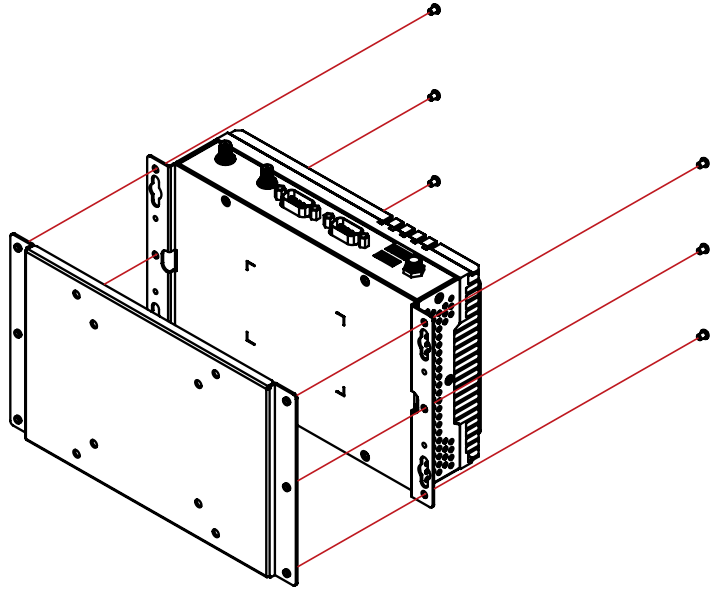

VESA MOUNT

SPECIFICATION

SYSTEM	Processor	9th Gen Intel® Core™ Processors, LGA 1151 Socket Intel® Core™ i7-9700TE Processor (8C/8T, 12M Cache, 3.6GHz, TDP 35W) Intel® Core™ i5-9500TE Processor (6C/6T, 9M Cache, 3.6GHz, TDP 35W) Intel® Core™ i3-9100TE Processor (4C/4T, 6M Cache, 3.2GHz, TDP 35W) 8th Gen Intel® Core™ Processors, LGA 1151 Socket Intel® Core™ i7-8700T Processor (6C/12T, 12M Cache, 4.0GHz; TDP 35W) Intel® Core™ i5-8500T Processor (6C/6T, 9M Cache, 3.5GHz; TDP 35W) Intel® Core™ i3-8100T Processor (4C/4T, 6M Cache, 3.1GHz; TDP 35W) Intel® Pentium® G5400T Processor (2C/4T, 4M Cache, 3.1GHz; TDP 35W) Intel® Celeron® G4900T Processor (2C/2T, 2M Cache, 2.9GHz; TDP 35W)
	Chipset	Intel® C246/Q370/H310 Chipset
	Memory	2 x 260-pin SODIMM up to 64GB Dual Channel DDR4 2666MHz (ECC : C246 only)
	BIOS	AMI SPI 128Mbit
GRAPHICS	Controller	Intel® HD Graphics
	Feature	OpenGL 4.5, DirectX 12, OpenCL 2.1 HW Decode: AVC/H.264, MPEG2, VC1/WMV9, JPEG/MJPEG, HEVC/H265, VP8, VP9 HW Encode: AVC/H.264, MPEG2, JPEG, HEVC/H265, VP8, VP9
	Display	2 x HDMI 2.0 HDMI: resolution up to 4096x2160@60Hz
	Dual Displays	2 x HDMI 2.0
STORAGE	Internal	2 x 2.5" SATA bay (optional) support RAID 0/1
EXPANSION	Interface	1 x M.2 2280 M key (PCIe x4/SATA 3.0) 1 x M.2 2230 E key (PCIe x1/USB2.0), WiFi
ETHERNET	Interface	2 x GbE RJ-45
	Controller	2 x Intel® I219/I210IT (10/100/1000Mbps) (Support Intel® iAMT)
LED	Indicators	1 x Power LED 1 x HDD LED
FRONT I/O	Ethernet	2 x GbE (RJ-45)
	USB	4 x USB 3.1 (type A)
	Buttons	1 x Power button 1 x Reset button
	Display	2 x HDMI 2.0
REAR I/O	Serial	2 x RS232/RS422/RS485 (DB9) or 1 x RS232/RS422/RS485 (DB9)(COM1) + 1 x 8bit DIO (DB9)
	USB	2 x USB 2.0 (type A)
	Antenna	2 x Opening Antenna Hole (WiFi)
WATCHDOG TIMER	Output & Interval	System Reset, Programmable via Software from 1 to 255 Seconds
SECURITY	TPM	TPM2.0 (option)
POWER	Type	12V DC-in jack lockable External power brick
	RTC Battery	CR2032 Coin Cell
	Supply	AC Power 100-250V, 50/60Hz
OS SUPPORT	Microsoft	Windows 10 IoT Enterprise 2019 LTSC + RS5 Windows 10 Professional
ENVIRONMENT	Operating Temperature	CPU power output config. via BIOS: TDP 35W : -5° C or 45° C cTPU 15W -20° to 60° C
	Storage Temperature	-20° to 60° C
	Relative Humidity	5 to 90% RH
MECHANICAL	Construction	Metal + Aluminum
	Mounting	Wall mount VESA mount 75x75/10x10cm (optional)
	Dimensions(W x H x D)	175 x 69.4 x 120mm (1 Storage: 1 x M.2 SSD) 175 x 90.4 x 120mm (3 Storage: 1 x M.2 SSD + 2 x 2.5" bay)
	Weight	3.5kg (1 Storage: 1 x M.2 SSD) 3.8kg (3 Storage: 1 x M.2 SSD + 2 x 2.5" bay)
	Color	Black
STANDARDS AND CERTIFICATIONS	Certification	FCC, CE Class B, RoHS, WEEE, UKCA