



# APLEX



## AEx-2411

Stainless steel BOX PC for Hazardous Locations  
ATEX/IECEX/CID2/CIID2/CIII/UKCA Certified BOX PC

## User Manual

**Release Date**

**Revision**

Mar. 2022

V1.7

©2022 Aplex Technology, Inc.

All Rights Reserved.

Published in Taiwan

Aplex Technology, Inc.

15F-1, No.186, Jian Yi Road, Zhonghe District, New Taipei City 235, Taiwan

Tel: 886-2-82262881 Fax: 886-2-82262883 URL: <http://www.aplertec.com/zh/home.php>

# Revision History

Reversion	Date	Description
0.1	2017/11/24	For Preliminary Release
1.0	2018/01/02	Official version
1.1	2018/03/27	Modify power pin defined
1.2	2018/05/16	Modify power pin description
1.3	2018/06/22	Add Warning
1.4	2021/06/25	Add IECEX/ATEX Standards in P5
1.5	2021/12/07	Add Pin define information in 1.2 chart
1.6	2022/01/20	Modify ATEX Standards and Notice, Certification information
1.7	2022/03/11	Add UKCA LOGO and Standards

## Warning!

---

This equipment generates, uses and can radiate radio frequency energy and if not installed and used in accordance with the instructions manual, it may cause interference to radio communications. It has been tested and found to comply with the limits for a Class A computing device pursuant to FCC Rules, which are designed to provide reasonable protection against such interference when operated in a commercial environment. Operation of this equipment in a residential area is likely to cause interference in which case the user at his own expense will be required to take whatever measures may be required to correct the interference.

Electric Shock Hazard – Do not operate the machine with its back cover removed. There are dangerous high voltages inside.

If you need to connect or reconnect M12 cables, please make sure turning off the power before all the replacement procedures and must in normal environment, Recommend use ATEX certificated IO cables.

## Disclaimer

**This information in this document is subject to change without notice. In no event shall Apex Technology Inc. be liable for damages of any kind, whether incidental or consequential, arising from either the use or misuse of information in this document or in any related materials.**

# ATEX Instruction Guide

## SAFETY INSTRUCTIONS

Read these instructions carefully, and look at the equipment to become familiar with the device before trying to install, operate, or maintain it. The following special messages may appear throughout this documentation or on the equipment to warn of potential hazards or to call attention to information that clarifies or simplifies a procedure.



This is the safety alert symbol. It is used to alert you to potential personal injury hazards. Obey all safety messages that follow this symbol to avoid possible injury or death.

## PLEASE NOTE

Electrical equipment should be installed, operated, serviced, and maintained only by qualified personnel. No responsibility is assumed by Digital Electronics Corporation for any consequences arising out of the use of this material. A qualified person is one who has skills and knowledge related to the construction and operation of electrical equipment and its installation, and has received safety training to recognize and avoid the hazards involved.

## SCOPE

This present document applies when AEx-2411 bears  marking. They are supplied only with DC 9~36 V. This documentation has to be kept and always refer to those instructions for installation, operation, maintenance or evolution of your system.

## Permitted zones of application

Refer to the section titled "Markings" to get information about the permitted zones of protection and the types of protection.

- AEx-2411 is installed in zones 2 hazardous areas must be certified and bear the  **UK CA** marking.
- Ensure with the marking that the terminals are compatible with the conditions permitted for the hazardous area at the site where it is being used.

## Notice

- 1.** Under certain extreme circumstances, the label may generate an ignition-capable level of electrostatic charge. Therefore the equipment shall not be installed in a location where the external conditions are conducive to the build-up of electrostatic charge on the label. In addition, the label shall only be cleaned with a damp cloth.
- 2.** Warning – in locations where high external humidity and internal temperature variations (e.g. frequent on-off cycles) may cause condensation inside the equipment, the interior should be periodically inspected.
- 3.** When the device is mounted in a hazardous area, connection and disconnection of external connectors while live is only permitted if the potentially explosive atmosphere is shown to be absent.
- 4.** The “9-36” Vdc rated supply shall be protected such that transients are limited to a maximum of 119 V; no such protection is required for the signal lines.
- 5.** Equipotential bonding facilities on the outside of enclosure are assessed as providing effective connection of a conductor with a cross-sectional area of at least 4 mm<sup>2</sup>, 10AWG, 600V wire
- 6.** The equipment is suitable for use in class I, division 2, groups A, B, C, D, Class II, Division 2, Group F,G, T135°C, Class III OR non-hazardous locations only.
- 7.** Warning- Do not use USB while the circuit is live unless the area is known to be non-hazardous.
- 8.** Electrostatic charging hazard - Clean only with a damp cloth.

## Markings

Markings applied to the AEx-2411 Graphic Operator Interface, are as follows:

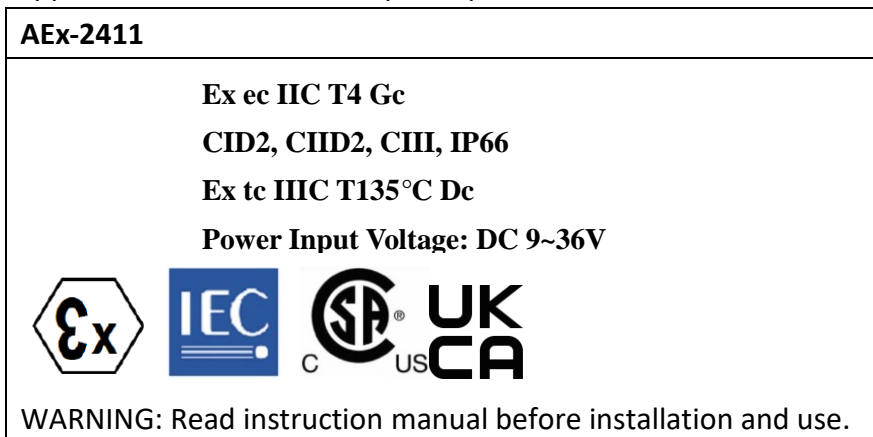

Below designated standards were certified with conform the relevant regulations:

New standards		
 II 3GD      Ex ec ic IIC T4 Gc Ex tc IIIC T135°C Dc		
IECEX	ATEX	UKCA
IEC 60079-0:2017	EN 60079-0:2018	BS 60079-0:2018
IEC 60079-11:2011	EN 60079-11:2012	BS 60079-11:2012
IEC 60079-7:2015 +AMD1:2017	EN 60079-7:2015/A1:2018	BS 60079-7:2015/A1:2018
IEC 60079-31:2013	EN 60079-31:2014	BS 60079-31:2014

# Table of Contents

Revision History.....	1
Warning!/Caution.....	2
Packing List.....	3
Safety Precautions.....	4

## Chapter 1 Getting Started

1.1 Features.....	8
1.2 Specifications.....	8
1.3 Dimensions.....	11
1.4 Brief Description of AEx-2411.....	12
1.5 VESA mounting and Wall mounting.....	13

## Chapter 2 Hardware

2.1 Motherboard Introduction.....	14
2.2 Specifications.....	14
2.3 Jumpers and Connectors Location.....	17
2.4 Jumpers Setting and Connectors.....	18

## Chapter 3 BIOS Setup

3.1 Operations after POST Screen.....	35
3.2 BIOS Setup Utility.....	35
3.3 Main Settings.....	36
3.4 Advanced Settings.....	37
3.5 Chipset Settings.....	46
3.6 Security Settings.....	69
3.7 Boot Settings.....	71
3.8 Save & Exit Settings.....	72

## Chapter 4 Installation of Drivers

4.1 Intel H170 Chipset.....	75
4.2 Intel® HD Graphics 530 Chipset.....	78
4.3 Realtek ALC662 HD Audio Driver Installation.....	82
4.4 Intel® Management Engine Interface.....	84
4.5 DPTF Driver.....	87

## Figures

---

Figure 1.1: Dimensions of AEx-2411.....	11
Figure 1.2: Overview of AEx-2411.....	12
Figure 1.3: VESA mount of AEx-2411.....	13
Figure 1.4: Wall mount of AEx-2411.....	13
Figure 2.1: Motherboard Dimensions.....	16
Figure 2.2: Jumpers and Connectors Location-Board Top.....	17
Figure 2.3: Jumpers and Connectors Location-Board Bottom.....	17



# Chapter 1

# Getting Started

## 1.1 Features

- Intel® 6th generation core i5/i3 Processors
- WLAN for Option
- Full IP66 grade with M12 waterproof connector
- Wide range DC 9~36V power input
- Support VESA and Wall mounting
- 316 Stainless steel design

## 1.2 Specifications

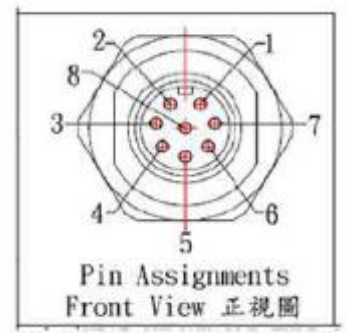
		AEx-2411																		
<b>System</b>																				
CPU	Onboard Intel® 6th generation core i5-6300U/i3-6100U																			
Chipset	SoC																			
Memory	1 x 260-pin SO-DIMM DDR4 2400MHz, up to 16GB																			
<b>IO Port</b>																				
USB	1 x M12 for 2 x USB2.0 with waterproof cover and chain <table border="1" style="margin-left: auto; margin-right: auto;"> <thead> <tr> <th>CN1</th> <th>Pin Define</th> </tr> </thead> <tbody> <tr> <td>1</td> <td>USB1 5V</td> </tr> <tr> <td>3</td> <td>D1-</td> </tr> <tr> <td>4</td> <td>D1+</td> </tr> <tr> <td>7</td> <td>GND</td> </tr> <tr> <td>2</td> <td>USB2 5V</td> </tr> <tr> <td>5</td> <td>D2-</td> </tr> <tr> <td>6</td> <td>D2+</td> </tr> <tr> <td>8</td> <td>GND</td> </tr> </tbody> </table>	CN1	Pin Define	1	USB1 5V	3	D1-	4	D1+	7	GND	2	USB2 5V	5	D2-	6	D2+	8	GND	 <p>Pin Assignments Front View 正視圖</p>
CN1	Pin Define																			
1	USB1 5V																			
3	D1-																			
4	D1+																			
7	GND																			
2	USB2 5V																			
5	D2-																			
6	D2+																			
8	GND																			
Serial/Parallel	1 x M12 for COM1— RS-232(RS-422/485 for option)																			

CN1	RS-232/422/485	CN2
1	DCD / 422R+	1
2	RXD / 422R-	2
3	TXD / 422T- / 485-	3
4	DTR / 422T+ / 485+	4
5	GND	5
6	DSR	6
7	RTS	7
8	CTS	8



LAN

2 x M12 for LAN with waterproof cover and chain

	Pin Define
1	LAN1_0+
2	LAN1_0-
3	LAN1_1+
4	LAN1_1-
5	LAN1_2+
6	LAN1_2-
7	LAN1_3+
8	LAN1_3-



VGA

1 x M12 for VGA with Metal Waterproof CAP

Power

1 x M12 for DC power input with waterproof cover and chain

	Pin Define
1	VCC
2	GND
3	FG

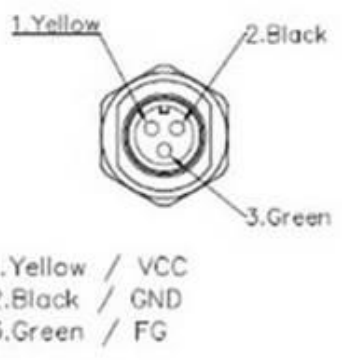

**Optional IO Port (Must be replacement for standard I/O)**

USB

1 x M12 for 2 x USB2.0 with metal waterproof CAP  
1 x M12 for 1 x USB3.0 with metal waterproof CAP

Serial/Parallel

1 x M12 for 1x RS-232 with metal waterproof CAP

**Storage Space**

Storage

1 x 2.5" SATA HDD or SSD space

**Expansion**

Expansion	1 x Mini PCIe full size slot (For option WLAN/BT module/mSATA SSD) 1 x VGA Transfer board
<b>Power</b>	
Power Input	DC 9~36V
Power Consumption	Max: 45.7W
<b>Mechanical</b>	
Construction	316 Stainless Steel Chassis
Mounting	VESA Mount 100 x100 (option) Wall Mount (default)
Dimension (mm)	334 x 195 x 38.5
Net Weight (Kg)	4
<b>Environmental</b>	
Operating temperature	-20~60°C
Storage temperature	-30~70°C
Storage humidity	10 to 90% @ 40°C, non- condensing
Storage temperature	Under 2000m
Altitude limit for application	CAT II
Overvoltage category	2
Certification	CE / FCC Class A ECEEx Certification: Ex ec ic IIC T4 Gc Ex tc IIIC T135°C Dc ATEX Certification:  II 3 GD Certification: Class I, Division2, Group A,B,C,D,T4 Class II, Division2, Group F,G, T135°C Class III ANSI/ISA 12.12.01-2013 CSA Std.C22.2 No213-1987 CSAE 22UKEX 1073X
<b>Operating System Support</b>	
OS Support	Windows 7 Embedded Standard Windows Embedded Standard 7 Windows Embedded 8.1 Pro Windows Embedded 8.1 Industry Pro

### 1.3 Dimensions

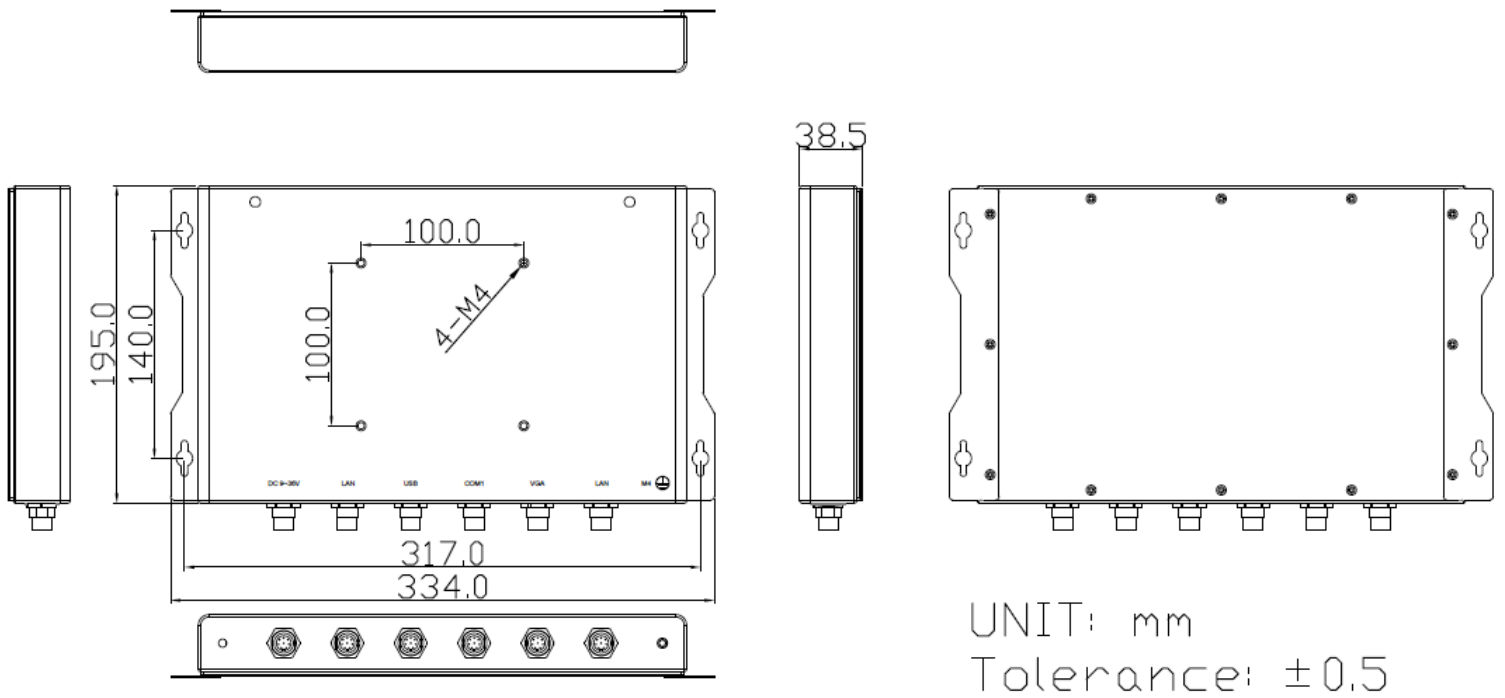

Figure 1.1: Dimensions of AEx-2411

## 1.4 Brief Description of AEx-2411

The AEx-2411 is a fanless design high-efficiency BOX PC for Hazardous Locations, powered by 6th generation Intel® core i3/i5 processor and supports 1 x so-dimm DDR4L 2400MHz up to 16G memory. It comes with 1x USB2.0 (support 2x USB2.0 function), 2x LAN, 1x COM and 1x VGA for standard I/O port, but also can be replaced by USB2.0/3.0 or RS-232; also designed by full IP66 waterproof connector. It supports 1 x 2.5" SATA2 HDD space and DC 9~36V wide-ranging power input. The model has 1 x Mini-PCIe full size slot for expansion. There are some specified limits for WIFI module such as the output power of transmitter which has to be less than 33dBm, and operating channel frequency band must be between 9KHZ to 60GHZ. The model is plating stainless steel chassis and full IP66 grade design. The AEx-2411 works very well along with any of our display series and it absolutely can provide an easy way to perform control and field maintenance.



**Figure 1.2: Overview of AEx-2411**

## 1.5 VESA mounting and Wall mounting

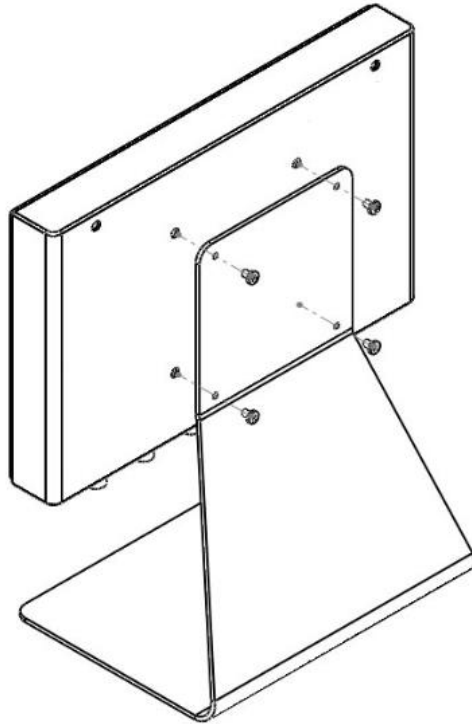

Figure 1.3: VESA mount of AEx-2411

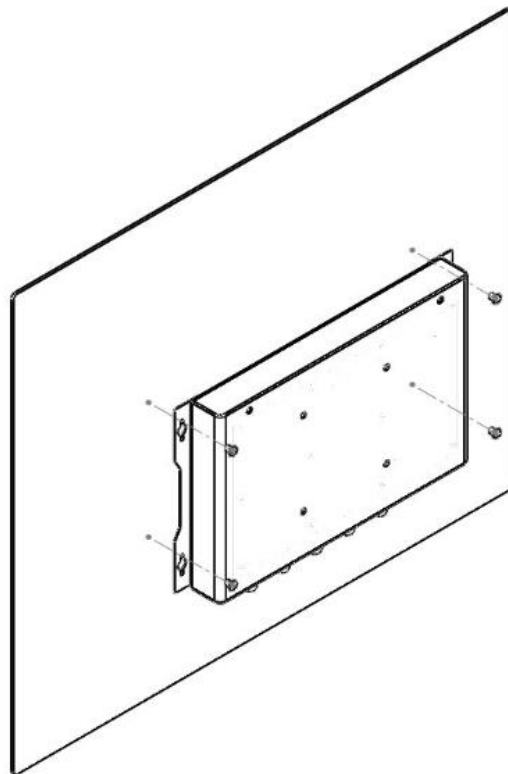

Figure 1.4: Wall mount of AEx-2411

## 2.1 Motherboard Introduction

SBC-7114 is a 4" industrial motherboard developed on the basis of Intel Skylake-U Processor, which provides abundant peripheral interfaces to meet the needs of different customers. Also, it features dual GbE ports, 6-COM ports and one mSATA configuration, one HDMI port, one LVDS interface. To satisfy the special needs of high-end customers, CN1 and CN2 and CN3 richer extension functions. The product is widely used in various sectors of industrial control.

## 2.2 Specifications

Specifications	
<b>Board Size</b>	170mm x 113mm
<b>CPU Support</b>	Intel® Core™ i3-6100U /2.30GHz (onboard) Intel® Core™ /i5-6300U /2.40 up to 3.00GHz (option ) Intel® Core™ /i7-6600U /2.60 up to 3.40GHz (option )
<b>Chipset</b>	SOC
<b>Memory Support</b>	1x SO-DIMM (260pins), up to 16GB DDR4 2133MHz FSB
<b>Graphics</b>	Intel® HD Graphics 520
<b>Display Mode</b>	1 x HDMI Port 1 x LVDS (18/24-bit dual LVDS) 1 x eDP Port (DF13-40P)
<b>Support Resolution</b>	Up to 4096 x 2304 for HDMI Up to 1920 x 1200 for LVDS (PS8625) Up to 4096 x 2304 for eDP1
<b>Dual Display</b>	HDMI + LVDS HDMI + eDP1 (option) LVDS + eDP1 (option) HDMI + LVDS + eDP1 (option)
<b>Super I/O</b>	Nuvoton NCT6106D
<b>BIOS</b>	AMI/UEFI
<b>Storage</b>	1 x SATAIII Connector (7P) 1 x SATAIII Connector (7P+15P)

	1 x MSATA Connector (option)
<b>Ethernet</b>	2 x PCIe Gbe LAN by <a href="#">Intel I211-AT</a>
<b>USB</b>	<p>2 x USB 3.0 (type A)stack ports (USB3) (USB3.0:USB3-1/USB3-2,USB2.0:USB1/USB2)</p> <p>2 x USB 2.0 Pin header for CN3 (USB3/USB4)</p> <p>2 x USB 3.0/USB2.0 Pin header for CN3 (PCIe 1x or USB3.0, option)</p> <p>1 x USB 2.0 Pin header for CN2 (USB5)</p> <p>1 x USB 2.0 Pin header for CN1 (USB7 or Touch, option)</p> <p>1 x USB 2.0 Pin header for EDP1 (USB7 or Touch, option)</p> <p>1 x USB 2.0 for MPCIE1 (USB6)</p>
<b>Serial</b>	<p>1 x RS232/RS422/RS485 port, DB9 connector for external (COM1) Pin 9 w/5V/12V/Ring select</p> <p>1 x RS232 port, DB9 connector for external (COM2) Pin 9 w/5V/12V/Ring select</p> <p>2 x UART for CN3 (COM3,COM4)</p> <p>1 x RS422/485 header for CN2 (NCT6106D /COM5)</p> <p>1 x RS422/485 header for CN2 (NCT6106D /COM6)</p>
<b>Digital I/O</b>	<p>8-bit digital I/O by Pin header (CN2) 4-bit digital Input 4-bit digital Output</p> <p>4-bit digital I/O by Pin header (CN3) 2-bit digital Input 2-bit digital Output</p>
<b>Battery</b>	Support CR2477 Li battery by 2-pin header (BAT3/CMOS)
<b>Smart battery</b>	<p>1 x Smart battery</p> <p>Support 3 Serial Li battery by 10-pin header (BAT2)</p>
<b>Audio</b>	<p>Support Audio via Realtek ALC269Q HD audio codec</p> <p>Support Line-out by JACK (LINE_OUT1)</p> <p>Support Line-in, Line-out, MIC by 2x6-pin header(AUDIO2)</p> <p>Support a stereo Class-D Speaker Amplifier with 2 watt per channel output power, by 1x4-pin header (SPK1)</p>
<b>Keyboard /Mouse</b>	1 x PS2 keyboard/mouse by box pin header (CN3)
<b>Expansion Bus</b>	<p>1 x mini-PCI-express slot (MPCIE or MSATA, <a href="#">Default: MPCIE</a>)</p> <p>1 x PCI-express for CN3</p> <p>2 x PCI-express for CN3 (PCIe 1x or USB3.0, <a href="#">Default: PCIe 1x</a>)</p>



<b>Touch Ctrl</b>	1 x Touch ctrl header for TCH1 ( USB10 )
<b>Power Management</b>	Wide Range DC9V~36V input 1 x 3-pin power input connector
<b>Switches and LED Indicators</b>	1 x Power on/off switch ( P_SW1/BT2/CN2/CN3 ) 1 x Reset ( CN2 ) 1 x HDD LED status ( CN2 ) 1 x Power LED status ( CN1 ) 1 x Buzzer
<b>External I/O port</b>	2 x COM Ports ( COM1/COM2 ) 2 x USB 3.0 Ports ( stack ) 2 x RJ45 GbE LAN Ports 1 x HDMI Port 1 x Audio Jack ( Line out )
<b>Temperature</b>	Operating: -20°C to 70°C Storage: -40°C to 85°C
<b>Humidity</b>	10% - 90%, non-condensing, operating
<b>Power Consumption</b>	12V/3A(Intel i3-6100U 2.30 GHz Processor with 16GB DDR4/HDD)
<b>EMI/EMS</b>	Meet CE/FCC class A

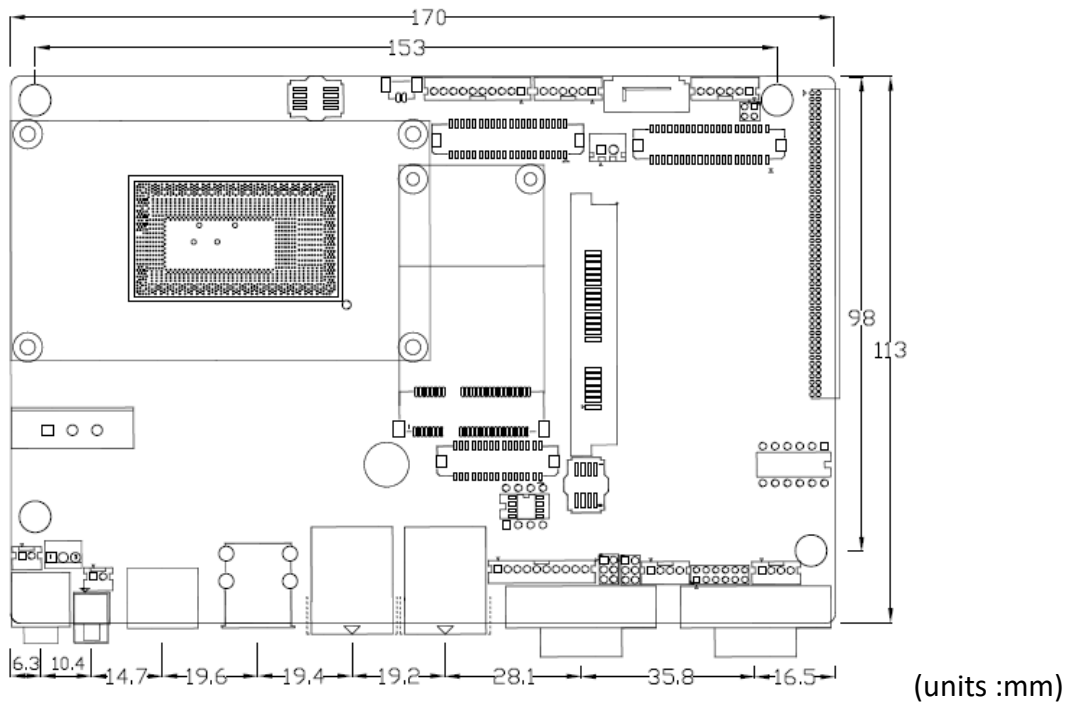

**Figure 2.1: Motherboard Dimensions**

## 2.3 Jumpers and Connectors Location

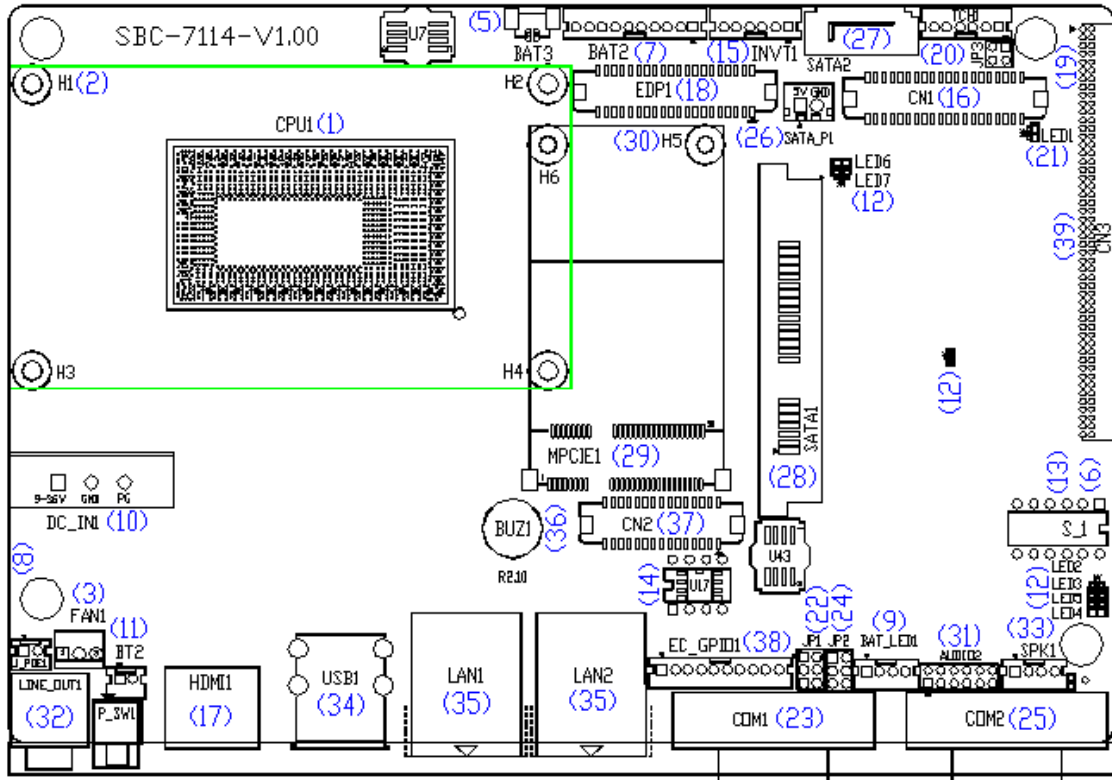

Figure 2.2: Jumpers and Connectors Location- Board Top

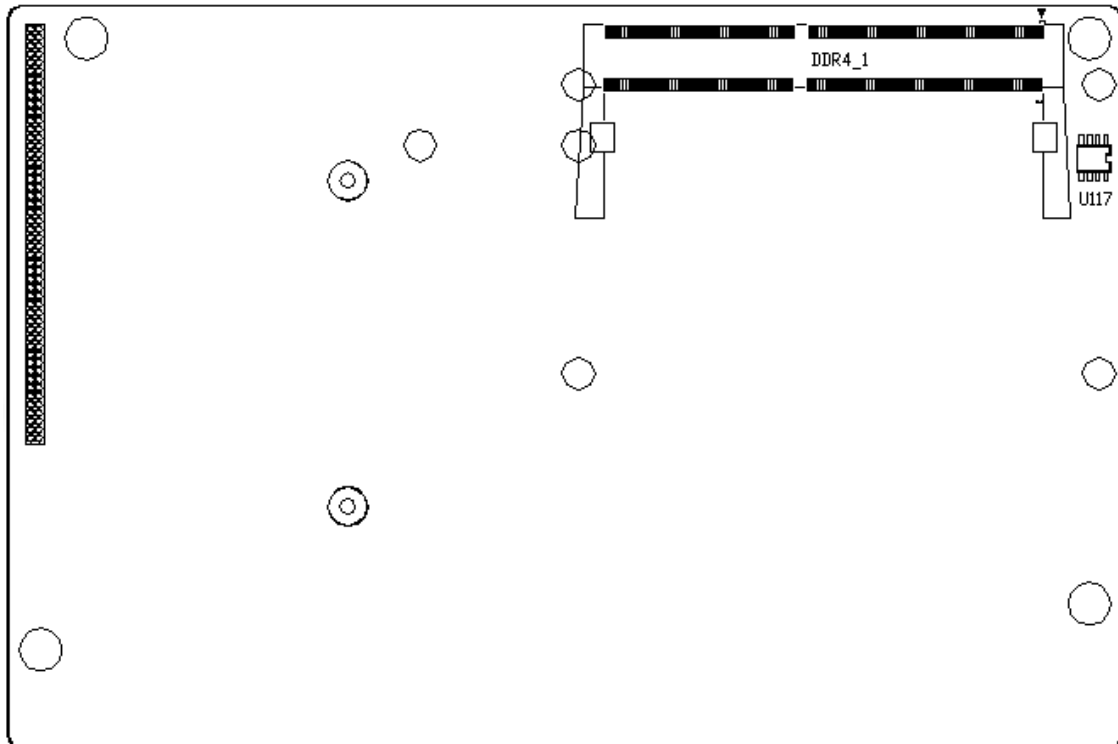

Figure 2.3: Jumpers and Connectors Location- Board Bottom

## 2.4 Jumpers Setting and Connectors

### 1. CPU1:

(FCBGA1356), onboard Intel Skylake-U processors.

Model	Processor					
	Number	PBF	Cores/ Threads	TDP	Embedded	Remarks
SBC-7114-I3-6100U	I3-6100U	2.30GHz	2 / 4	15W	●	
SBC-7114-I3-6100UP	I3-6100U	2.30GHz	2 / 4	15W	●	option
SBC-7114-I5-6300U	I5-6300U	2.4 up to 3.0GHz	2 / 4	15W 25W	●	option
SBC-7114-I5-6300UP	I5-6300U	2.4 up to 3.0GHz	2 / 4	15W 25W	●	option
SBC-7114-I7-6600U	I7-6600U	2.6 up to 3.4GHz	2 / 4	15W 25W	●	option
SBC-7114-I7-6600UP	I7-6600U	2.6 up to 3.4GHz	2 / 4	15W 25W	●	option
<i>SBC-7114-I5-6200U</i>	<i>I5-6200U</i>	<i>2.3 up to 2.8GHz</i>	<i>2 / 4</i>	<i>15W 25W</i>	○	<i>option</i>
<i>SBC-7114-I5-6200UP</i>	<i>I5-6200U</i>	<i>2.3 up to 2.8GHz</i>	<i>2 / 4</i>	<i>15W 25W</i>	○	<i>option</i>

### 2. H1/H2/H3/H4(option):

CPU1 Heat Sink Screw holes, four screw holes for intel skylake-U Processors.

Heat Sink assemblies.

### 3. FAN1:

(2.54mm Pitch 1x3 Pin Header), Fan connector, cooling fans can be connected directly for use. You may set the rotation condition of cooling fan in menu of BIOS CMOS Setup.

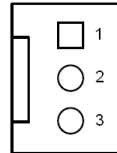

Pin#	Signal Name
1	Ground
2	VCC
3	Rotation detection



Note:

Output power of cooling fan must be limited under 5W.

#### 4. DDR4\_1:

(SO-DIMM 260Pin socket), DDR4 memory socket, the socket is located at the top of the board and supports 260Pin 1.2V DDR4 2133MHz FSB SO-DIMM memory module up to **16GB**.

#### 5. BAT3 :

(1.25mm Pitch 1x2 Wafer Pin Header, SMD) 3.0V Li battery is embedded to provide power for CMOS.

Pin#	Signal Name
Pin1	Ground
PIN2	VBAT

#### 6. S\_1 (PIN1 , PIN2 , PIN6):

(Switch), ATX Power and Auto Power on jumper setting.

S-1(Switch)	Mode
Pin1 ( Off )	ATX Power
Pin1 ( On )	<b>Auto Power on (Default)</b>

(Switch), CMOS clear switch, CMOS clear operation will permanently reset old BIOS settings to factory defaults.

S-1(Switch)	CMOS
Pin2 ( Off )	NORMAL (Default)
Pin2 ( On )	Clear CMOS



### Procedures of CMOS clear:

- a) Turn off the system and unplug the power cord from the power outlet.
- b) To clear the CMOS settings, pushing the S\_1 pin2 ON for about 3 seconds then pushing the S\_1 Pin2 OFF.
- c) Power on the system again.
- d) When entering the POST screen, press the <ESC> or <DEL> key to enter CMOS Setup Utility to load optimal defaults.
- e) After the above operations, save changes and exit BIOS Setup.

### 7. BAT2:

(2.0mm Pitch 1x10 Wafer Pin Header), smart battery Interface.

Pin#	Signal Name
Pin1	VCC_BAT1
Pin2	VCC_BAT1
Pin3	VCC_BAT1
Pin4	SMB_DAT_SW
Pin5	SMB_CLK_SW
Pin6	BAT1_TEMP
Pin7	Ground
Pin8	Ground
Pin9	Ground
Pin10	SET_BAT1_ON

Function	Specifications
Nominal voltage (3S1P)	11.1~12.6V
Charge voltage	12.6V
Charge current	0.5C

### 8. J\_POE1:

(2.0mm Pitch 1x2 Wafer Pin Header),POE or DCIN input setting.

J_POE1 (Jumper)	DC_IN1	BAT2
Pin1-Pin2(open, <b>Default</b> )	●	-

Pin1-Pin2 ( Close )	-	●
---------------------	---	---

### 9. BAT\_LED1:

(2.0mm Pitch 1x4 Wafer Pin Header),The Charge status indicator for BAT2.

Pin1-Pin3: Charge LED status.

Pin2-Pin3: Discharge LED status.

Pin4-Pin3: EC LED status.

Pin#	Signal Name
Pin1	BAT1_LED+
Pin2	BAT1_LED-
Pin3	Ground
Pin4	RST_EC

### 10. DC\_IN1:

(5.08mm Pitch 1x3 Pin Connector),DC 9V~36V System power input connector.

Pin#	PIN OUT		
CN. 1	Wire Color	Power Input	CN. 2
1	Yellow	DC+9V~36V	Tail peeling 60mm
2	Black	Ground	Tail peeling 60mm
3	Green	FG	Tail peeling 60mm

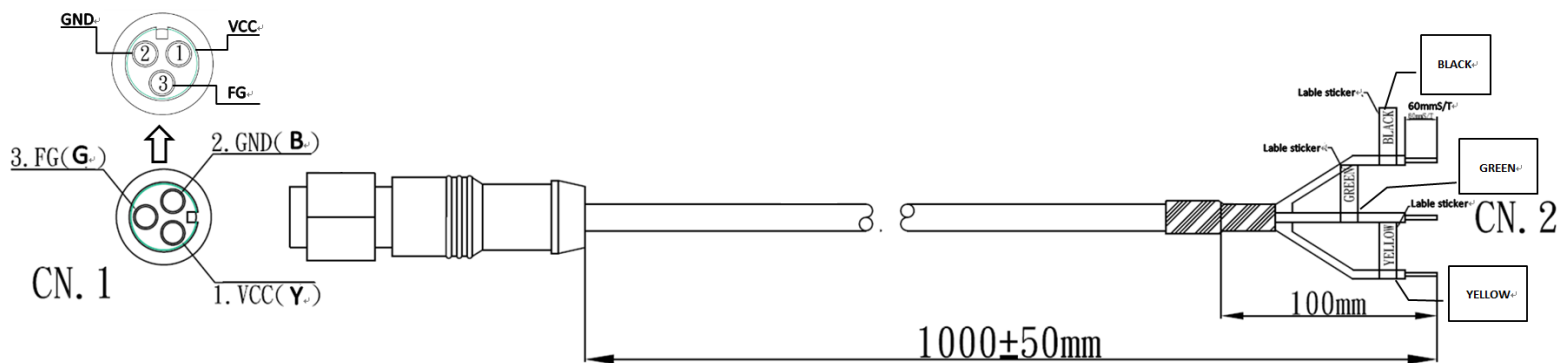

Model	DC_IN1
SBC-7114-I3-6100U	180°Connector
SBC-7114-I5-6300U	180°Connector
SBC-7114-I7-6600U	180°Connector
SBC-7114-I3-6100UP	45°Connector

SBC-7114-I5-6300UP	45°Connector
SBC-7114-I7-6600UP	45°Connector

Connector	Power input
DC_IN1 (Default)	DC_IN1
BAT2 (option)	BAT2
DC_IN1 + BAT2 (option)	DC_IN1

### 11. P\_SW1/BT2 :

**Power on/off button**, they are used to connect power switch button. The two pins are disconnected under normal condition. You may short them temporarily to realize system startup & shutdown or awaken the system from sleep state.

P_SW1	Function
1x2Pin connect	(Default)
Button	option

### 12. LED2/LED3/LED4/LED5/LED6/LED7/LED8:

LED2: LED STATUS. Green LED for 3P3V\_ALLS\_EC Power status.

LED3: LED STATUS. Green LED for 3P3V\_S5 Power status.

LED4: LED STATUS. Green LED for Motherboard Standby Power Good status.

LED5: LED STATUS. Reserve.

LED6: LED STATUS. Green LED for charge status.

LED7: LED STATUS. Green LED for charge Complete status.

LED8: LED STATUS. Green LED for charge Power Good status.

### 13. S\_1(PIN3/PIN4/PIN6):

(Switch), LVDS jumper setting.

S-1(Switch)	Function (CN1)
Pin3 (ON)	Single channel LVDS
<b>Pin3 (OFF)</b>	<b>Dual channel LVDS (Default)</b>
<b>Pin4 (ON)</b>	<b>8/24 bit (Default)</b>
Pin4 (OFF)	6/18 bit
SEL-LCD-EDID (U17 or OPC-547 U2/U3)	
Pin6 (ON)	Onboard EDID

Pin6 (OFF)	Panel EDID
------------	------------

**14. U17:**

AT24C02-DIP8,The EEPROM IC ( U17 ) is the set of LVDS resolution.  
If you need other resolution settings, please upgrade U17 data.

Model	LVDS resolution
SBC-7114-I3-6100U SBC-7114-I5-6300U SBC-7114-I7-6600U	1280*1024 (Default)
	800*480 ( option )
	800*600 ( option )
	1024*768 ( option )
	1920*1080 ( option )
	.....

**15. INVT1:**

(2.0mm Pitch 1x6 wafer Pin Header), Backlight control connector for LVDS.

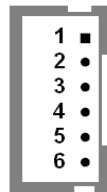

Pin#	Signal Name
1	+DC12V_S0
2	+DC12V_S0
3	Ground
4	Ground
5	BKLT_EN_OUT
6	BKLT_CTRL

**16. CN1:**

(1.25mm Pitch 2x20 Connector,DF13-40P),For 18/24-bit LVDS output connector, fully supported by parad PS8625(DP to LVDS), the interface features dual channel 24-bit output. Low Voltage Differential Signaling, A high speed, low power data transmission standard used for display connections to LCD panels.

Function	Signal Name	Pin#		Signal Name	Function
	12V_S0	2	1	12V_S0	



LVDS	BKLT_EN_OUT	4	3	BKLT_CTRL	LVDS
	Ground	6	5	Ground	
	LVDS_VDD5	8	7	LVDS_VDD5	
	LVDS_VDD3	10	9	LVDS_VDD3	
	Ground	12	11	Ground	
	LA_D0_P	14	13	LA_D0_N	
	LA_D1_P	16	15	LA_D1_N	
	LA_D2_P	18	17	LA_D2_N	
	LA_D3_P	20	19	LA_D3_N	
	LA_CLKP	22	21	LA_CLKN	
	LB_D0_P	24	23	LB_D0_N	
	LB_D1_P	26	25	LB_D1_N	
	LB_D2_P	28	27	LB_D2_N	
	LB_D3_P	30	29	LB_D3_N	
LB_CLKP	32	31	LB_CLKN		
USB7 (option)	Ground	34	33	LCD_EDID_SEN	
	USB7_P	36	35	USB7_N	
	5V_S5_USB	38	37	LVDS1_DDC_DATA	
Power LED	PWR_LED+	40	39	LVDS1_DDC_CLK	Power LED

### 17. HDMI1:

(HDMI 19P Connector), High Definition Multimedia Interface connector.

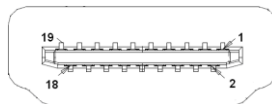

### 18. EDP1(option):

Function	Signal Name	Pin#		Signal Name	Function
	12V_S0_EDP	2	1	12V_S0_EDP	
	12V_S0_EDP	4	3	12V_S0_EDP	
	Ground	6	5	Ground	
	EDP_VDD5	8	7	EDP_VDD5	
	EDP_VDD3	10	9	EDP_VDD3	
	CPU_CFG4	12	11	Ground	
	EDP_BKLT_EN	14	13	EDP_TXN_1	

EDP	EDP_BKLT_CTL	16	15	EDP_TXP_1	EDP
	EDP_VDD_EN	18	17	Ground	
	EDP_TXN_2	20	19	EDP_TXN_0	
	EDP_TXP_2	22	21	EDP_TXP_0	
	Ground	24	23	Ground	
	EDP_TXN_3	26	25	EDP_AUX_N	
	EDP_TXP_3	28	27	EDP_AUX_P	
	EDP_DISP_UTI L	30	29	I2C1_SCL	I2C
	EDP_HP_CN	32	31	I2C1_SDA	
USB7 (option)	Ground	34	33	Ground	USB7 (option)
	USB7_P	36	35	USB7_N	
	5V_S5_USB	38	37	5V_S5_USB	
Power LED	PWR_LED+	40	39	Ground	Power LED

### 19. JP3:

(2.0mm Pitch 2x2 wafer Pin Header), touch jumper setting.

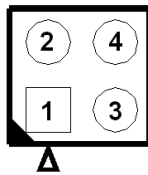

JP3	Touch(TCH1)
Open 3-4( <b>default</b> )	Enable
Close 3-4(option)	Disable
Open 1-2( <b>default</b> )	-

Priority Order :			
Touch Function	JP3(3-4)	S_1(Pin5)	EC_GPIO
TCH1(Enable)	Short	-	-
TCH1(Disable)	Open	ON	-
TCH1(Enable)	Open	OFF	1 ( Default )
TCH1(Disable)	Open	OFF	0

### 20. TCH1:

(2.0mm Pitch 1x6 wafer Pin Header), internal touch controller connector.

Pin#	Signal Name
1	SENSE
2	X+
3	X-
4	Y+
5	Y-
6	GND_EARCH

**21. LED1:**

LED1: LED STATUS. Green LED for touch power status.

**22. JP1:**

(2.0mm Pitch 2x3 Pin Header), COM1 jumper setting, pin 1~6 are used to select signal out of pin 9 of COM1 port.

JP1 Pin#	Function
<b>Close 1-2</b>	<b>COM1 RI (Ring Indicator) (default)</b>
Close 3-4	COM1 Pin9:DC+5V (option)
Close 5-6	COM1 Pin9:DC+12V (option)

**23. COM1:**

**(Type DB9M)**,Rear serial port, standard DB9 Male serial port is provided to make a direct connection to serial devices. COM1 port is controlled by pins No.1~6 of JP1,select output Signal RI or 5V or 12V, For details, please refer to description of JP1 and S\_232 and S\_422 setting.

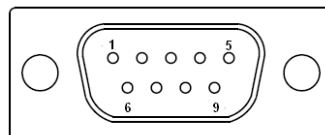

<b>RS232 (Default):</b>	
Pin#	Signal Name
1	DCD# (Data Carrier Detect)
2	RXD (Received Data)
3	TXD (Transmit Data)
4	DTR (Data Terminal Ready)

5	Ground
6	DSR (Data Set Ready)
7	RTS (Request To Send)
8	CTS (Clear To Send)
9	<b>JP1 select Setting (RI/5V/12V)</b>
BIOS Setup : Advanced/NCT6106D Super IO Configuration/F75111 COM1 Configuration <b>【RS-232】</b>	

RS422 (option):	
Pin#	Signal Name
1	422_TX-
2	422_TX+
3	422_RX+
4	422_RX-
5	Ground
6	NC
7	NC
8	NC
9	NC
BIOS Setup : Advanced/NCT6106D Super IO Configuration/F75111 COM1 Configuration <b>【RS-422】</b>	

RS485 (option):	
Pin#	Signal Name
1	485-
2	485+
3	NC
4	NC
5	Ground
6	NC
7	NC
8	NC
9	NC
BIOS Setup :	

**24. JP2:**

(2.0mm Pitch 2x3 Pin Header), COM2 jumper setting, pin 1~6 are used to select signal out of pin 9 of COM2 port.

JP2 Pin#	Function
<b>Close 1-2</b>	<b>COM2 RI (Ring Indicator) (default)</b>
Close 3-4	COM2 Pin9 : DC+5V (option)
Close 5-6	COM2 Pin9 : DC+12V (option)

**25. COM2:**

(Type DB9M), Rear serial port, standard DB9 Male serial port is provided to make a direct connection to serial devices.

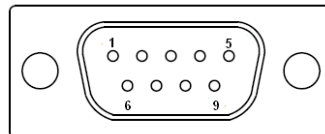

Pin#	Signal Name
1	DCD# (Data Carrier Detect)
2	RXD (Received Data)
3	TXD (Transmit Data)
4	DTR (Data Terminal Ready)
5	Ground
6	DSR (Data Set Ready)
7	RTS (Request To Send)
8	CTS (Clear To Send)
9	<b>JP2 select Setting (RI/5V/12V)</b>

**26. SATA\_P1:**

(2.5mm Pitch 1x2 box Pin Header), One onboard 5V output connector are reserved to provide power for SATA devices.

Pin#	Signal Name
------	-------------

1	+DC5V
2	Ground



**Note:**

**Output current of the connector must not be above 1A.**

**27. SATA2:**

(SATA 7Pin), SATA Connectors, one SATA connector are provided; with transfer speed up to 6.0Gb/s.

**28. SATA1:**

(SATA 7Pin+15Pin), SATA Connectors, one SATA connector are provided; with transfer speed up to 6.0Gb/s.

**29. MPCIE1:**

(50.95mmx30mm Socket 52Pin), mSATA socket, it is located at the top, it supports mini PCIe devices with LPCbus and SMBus and mSATA signal. **B2 mSATA bus** for flash disk signal.

Function	Support
Mini SATA	<a href="#">o(co-lay, Option,17/12/05)</a>
Mini PCIe	●
LPC bus	●
SMBus	●
USB2.0 ( USB6 )	●

**30. H5/H6:**

MPCIE1 SCREW HOLES, H5 and H6 for mini PCIE card (30mmx50.95mm) assemble.

**31. AUDIO2:**

(2.0mm Pitch 2X6 Pin Header), Front Audio, An onboard Realtek ALC269Q codec is used to provide high-quality audio I/O ports. Line Out can be connected to a headphone or amplifier. Line In is used for the connection of external audio source via a Line in cable. MIC is the port for microphone input audio.

Signal Name	Pin#	Pin#	Signal Name
+5V	1	2	GND_AUD
LINE-OUT-L	3	4	LINE-OUT-R

FRONT_JD	5	6	LINE1_JD
LINE-IN-L	7	8	LINE-IN-R
MIC-IN-L	9	10	MIC-IN-R
GND_AUD	11	12	MIC1_JD

### 32. LINE\_OUT:

(Diameter 3.5mm Jack), HD Audio port, An onboard Realtek ALC269-VB codec is used to provide high quality audio I/O ports. Line Out can be connected to a headphone or amplifier.



Line out

### 33. SPK1:

(2.0mm Pitch 1x4 Wafer Pin Header), support a stereo Class-D Speaker Amplifier with 2 watt per channel output power

Pin#	Signal Name
1	SPK_OUTL_P
2	SPK_OUTL_N
3	SPK_OUTR_N
4	SPK_OUTR_P

### 34. USB1:

**USB3-1/USB3-2** : (Double stack USB type A), Rear USB connector, it provides up to two USB3.0 ports, High-speed USB 2.0 allows data transfers up to 480 Mb/s, USB 3.0 allows data transfers up to 5.0Gb/s ,support USB full-speed and low-speed signaling.

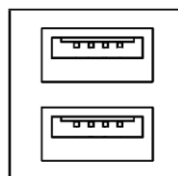

USB3-1/USB3.0

USB3-2/USB3.0

**Each USB Type A Receptacle (2 Ports) Current limited value is 2.0A.**

**If the external USB device current exceeds 1.5A, please separate connectors into different Receptacle.**

### 35. LAN1/LAN2:

**LAN1/LAN2:** (RJ45 Connector), Rear LAN port, Two standard 10/100/1000M RJ-45

Ethernet ports are provided. Used intel 82574L chipset, LINK LED (green) and ACTIVE LED (green) respectively located at the left-hand and right-hand side of the Ethernet port indicate the activity and transmission state of LAN.

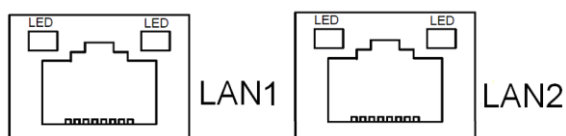

**36. BUZ1:**

Onboard buzzer.

**37. CN2:**

(DF13-30P Connector), For expand output connector, It provides eight GPIO, two RS422 or RS485, one USB2.0, one Power on/off, one Reset.

Function	Signal Name	Pin#	Pin#	Signal Name	Function
5V	5V_S5	2	1	5V_S5	5V
	<a href="#">6106_GPIO41</a>	4	3	GPIO_IN1	<a href="#">6106_GPIO40</a>
	<a href="#">6106_GPIO43</a>	6	5	GPIO_IN3	<a href="#">6106_GPIO42</a>
	<a href="#">6106_GPIO45</a>	8	7	GPIO_OUT1	<a href="#">6106_GPIO44</a>
	<a href="#">6106_GPIO47</a>	10	9	GPIO_OUT3	<a href="#">6106_GPIO46</a>
	Ground	12	11	Ground	
485 or 422 (COM5)	485+_422TX5 +	14	13	485-_422TX5 -	485 or 422 (COM5)
	422_RX5+	16	15	422_RX5-	
485 or 422 (COM6)	485+_422TX6 +	18	17	485-_422TX6 -	485 or 422 (COM6)
	422_RX6+	20	19	422_RX6-	
5V	5V_S0	22	21	HDD_LED+	HDD LED
USB2.0	5V_USB5	24	23	5V_USB5	USB2.0
	USB5_P	26	25	USB5_N	
	Ground	28	27	FP_RST-	RESET
Power auto on	PWRBTN_ON	30	29	Ground	
COM5 BIOS Setup : Advanced/NCT6106D Super IO Configuration/ COM5 Configuration <b>【RS-422】</b> Advanced/NCT6106D Super IO Configuration/ COM5 Configuration					



【RS-485】  
 COM6 BIOS Setup :  
 Advanced/NCT6106D Super IO Configuration/ COM5 Configuration  
 【RS-422】  
 Advanced/NCT6106D Super IO Configuration/ COM5 Configuration  
 【RS-485】

**38. EC\_GPIO1 :**

(2.0mm Pitch 1X10 Pin Header),For expand connector ,It provides eight GPIO.

Pin#	Signal Name	GPIO Name
1	Ground	Ground
2	GPA0_ONOFF	EC_GPA0
3	GPA1_SPK	EC_GPA1
4	GPE6_BKLT	EC_GPE6
5	GPE0_BKLT+	EC_GPE0
6	GPH3_SPK+	EC_GPH3
7	BKLT_CTRL_PWR	BKLT_CTRL_PWR
8	ADC6_BKLT_CTRL	EC_ADC6
9	ADC7_RSV	EC_ADC7
10	3.3V_ALLS_EC	3.3V_ALLS_EC

**39. CN3:**

(1.27mm Pitch 2X50 Female Header),For expand output connector,It provides four GPIO,two USB 2.0,one PS/2 mouse,one PS/2 keyboard, two uart,one PCIe1,one SMBus,two PCIe1 or USB3.0, two USB 2.0, connected to the TB-528 riser Card.

Function	Signal Name	Pin#		Signal Name	Function
	5V_S5_USB	1	2	5V_S5_USB	
	5V_S5_USB	3	4	5V_S5_USB	
	USB34_OC	5	6	PSON_ALL-	
USB4	USB4_N	7	8	USB4_P	USB4
USB3	USB3_N	9	10	USB3_P	USB3
	Ground	11	12	Ground	
PS/2 MS	PS2_MSCLK	13	14	PS2_MSDATA	PS/2 MS
PS/2 KB	PS2_KBCLK	15	16	PS2_KBDATA	PS/2 KB
	COM4_RI	17	18	COM4_DCD-	

COM4 (UART)	COM4_TXD	19	20	COM4_RXD	COM4 (UART)
	COM4_DTR	21	22	COM4_RTS-	
	COM4_DSR	23	24	COM4_CTS-	
	Ground	25	26	Ground	
COM3 (UART)	COM3_RI	27	28	COM3_DCD-	COM3 (UART)
	COM3_TXD	29	30	COM3_RXD	
	COM3_DTR	31	32	COM3_RTS-	
	COM3_DSR	33	34	COM3_CTS-	
GPPC20	PCH_GPPC20	35	36	PCH_GPPC22	GPPC22
GPPC21	PCH_GPPC21	37	38	PCH_GPPC23	GPPC23
	Ground	39	40	Ground	
PCIE1	PCIE1_TX_NO	41	42	PE1_TX_P0	PCIE1
	PCIE1_RX_NO	43	44	PE1_RX_P0	
	Ground	45	46	Ground	
	CLK_100M_PE1_N	47	48	CLK_100M_PE1_P	
	PCIE1_WAKE_N	49	50	PLT_RST_BUF2-	
SMBUS	SMB_CLK_S5	51	52	SMB_DATA_S5	SMBUS
PCIE	CLKREQ_PE1-	53	54	Ground	
	3P3V_S5	55	56	PWRBTN_ON-	Power Auto on
	3P3V_S5	57	58	3P3V_S5	
12V	12V_S0	59	60	12V_S0	12V
12V	12V_S0	61	62	12V_S0	12V
PCIE3	Ground	63	64	Ground	PCIE3
	PE3_TX_NO	65	66	PE3_TX_P0	
	PE3_RX_NO	67	68	PE3_RX_P0	
	Ground	69	70	Ground	
	CLK_100M_PEO_N	71	72	CLK_100M_PEO_P	
	CLKREQ_PEO-	73	74	CLKREQ_PE5-	
PCIE5 or USB3.0	Ground	75	76	Ground	PCIE5 or USB3.0
	CLK_100M_PE5_N	77	78	CLK_100M_PE5_P	
	USB5PE1_TX_N	79	80	USB5PE1_TX_P	
	USB5PE1_RX_N	81	82	USB5PE1_RX_P	
PCIE6 or USB3.0	Ground	83	84	Ground	PCIE6 or USB3.0
	USB6PE2_TX_N	85	86	USB6PE2_TX_P	
	USB6PE2_RX_N	87	88	USB6PE2_RX_P	

	CLK_100M_XDP_N	89	90	CLK_100M_XDP_P	
USB2.0	Ground	91	92	Ground	USB2.0
	USB8_N	93	94	USB8_P	
	USB9_N	95	96	USB9_P	
	5V_S5	97	98	5V_S5	
	3P3V_S5	99	100	3P3V_S5	



SBC-7114 can support TB-528 Series, if any requirement please contact with [CSE department](#).

## 3.1 Operations after POST Screen

After CMOS discharge or BIOS flashing operation, press [Delete] key to enter CMOS Setup.



After optimizing and exiting CMOS Setup

## 3.2 BIOS Setup Utility

Press [Delete] key to enter BIOS Setup utility during POST, and then a main menu containing system summary information will appear.

### 3.3 Main Settings

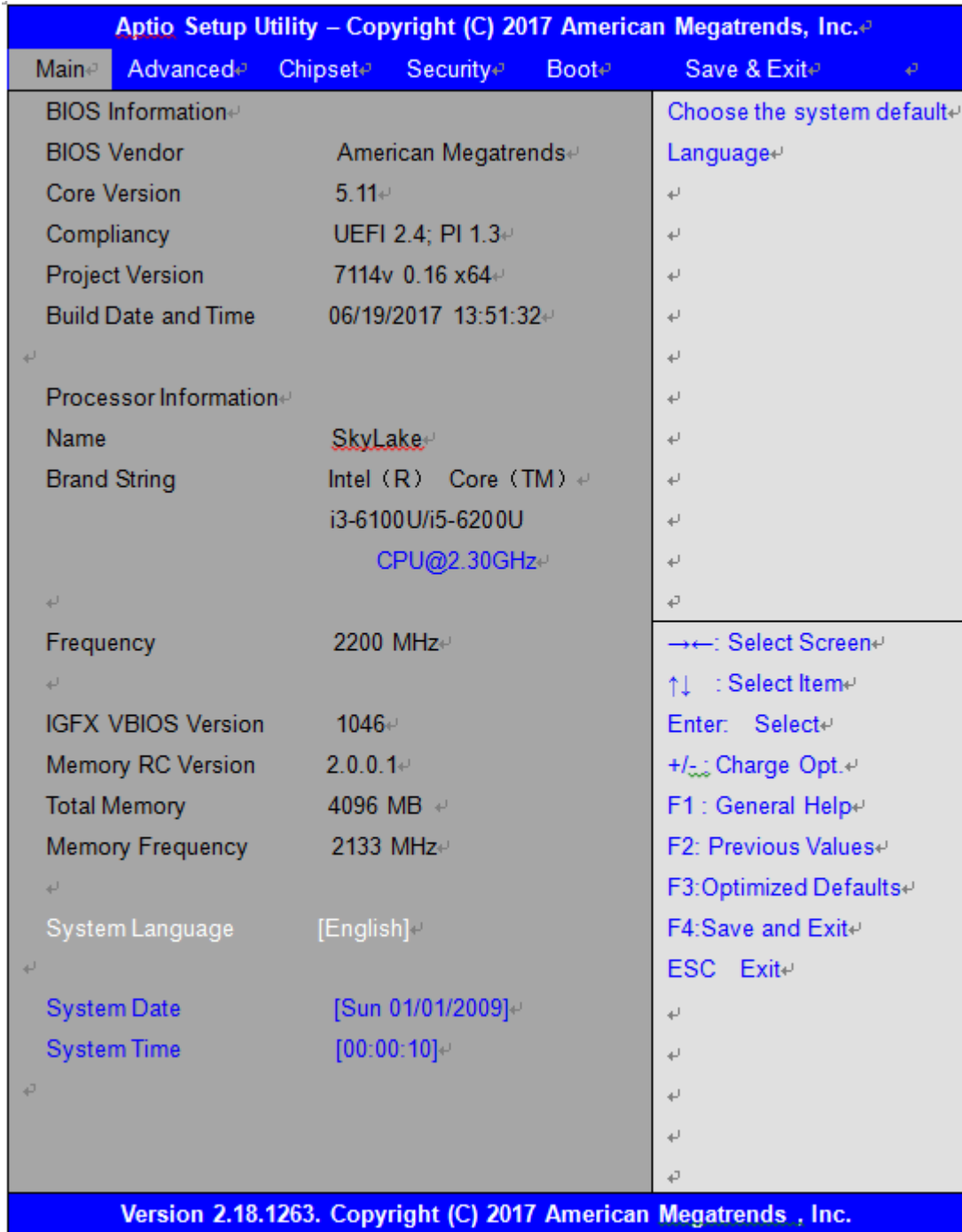

#### System Time:

Set the system time, the time format is:

Hour : 0 to 23

Minute : 0 to 59

Second : 0 to 59

### System Date:

Set the system date, the date format is:

**Day:** Note that the 'Day' automatically changes when you set the date.

**Month:** 01 to 12

**Date:** 01 to 31

**Year:** 1998 to 2099

## 3.4 Advanced Settings

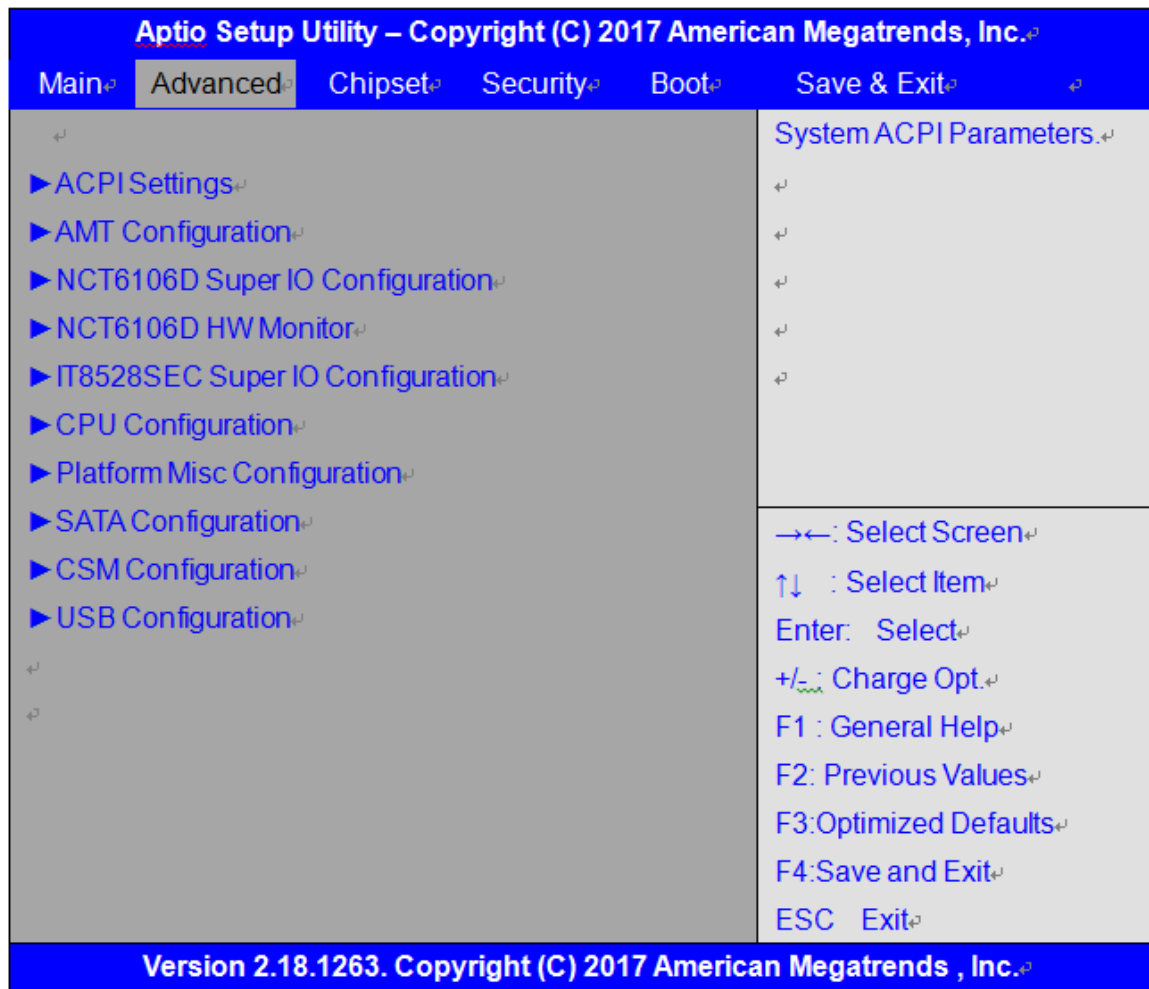

### 3.4.1 ACPI Settings

Enable ACPI Auto Configuration:

**[Disabled]**

[Enabled]

Enable Hibernation:

**[Enabled]**

[Disabled]

ACPI Sleep State:

**[S3 (Suspend to RAM) ]**  
[Suspend Disabled]

Lock Legacy Resources:

**[Disabled]**  
[Enabled]

S3 Video Repost:

**[Disabled]**  
[Enabled]

ACPI Low Power S0 Idle:

**[Disabled]**  
[Enabled]

### 3.4.2 AMT Configuration

Intel AMT	[Disabled]
BIOS Hotkey Pressed	[Disabled]
MEBx Selection Screen	[Disabled]
Hide Un-Configure ME Configuration Prompt	[Disabled]
MEBx Debug Message Output	[Disabled]
Un-Configure ME	[Disabled]
Amt Wait Timer	0
ASF	[Enabled]
Activate Remote Assistance Process	[Disabled]
USB Provisioning of AMT	[Enabled]
PET Progress	[Enabled]
AMT CIRA Timeout	0
WatchDog	[Disabled]
OS Timer	0
BIOS Timer	0

### 3.4.3 NCT6106D Super IO Configuration

Super IO Chip	NCT6106D
Serial Port 1 Configuration	
Serial port	<b>[Enabled]</b>
	[Disabled]
Device Settings	IO=3F8h; IRQ=4;

Change Settings	[Auto]
F75111 COM1 Config	
	[RS-232 Mode]
	[RS-485 Mode]
	[RS-422 Mode]
Serial Port 2 Configuration	
Serial port	[Enabled]
	[Disabled]
Device Settings	IO=2F8h; IRQ=3;
Change Settings	[Auto]
Serial Port 3 Configuration	
Serial port	[Enabled]
	[Disabled]
Device Settings	IO=3E8h; IRQ=7;
Change Settings	[Auto]
Serial Port 4 Configuration	
Serial port	[Enabled]
	[Disabled]
Device Settings	IO=2E8h; IRQ=7;
Change Settings	[Auto]
Serial Port 5 Configuration	
Serial port	[Enabled]
	[Disabled]
Device Settings	IO=2F0h; IRQ=7;
Change Settings	[Auto]
COM5 Config	[RS-485 Mode]
	[RS-422 Mode]
Serial Port 6 Configuration	
Serial port	[Enabled]
	[Disabled]
Device Settings	IO=2E0h; IRQ=7;



Change Settings	[Auto]
COM6 Config	[RS-485 Mode] [RS-422 Mode]
Power Failure	[Power OFF] [Power ON] [Last state]

### 3.4.4 NCT6106D HW Monitor

#### Pc Health Status

CPU Temperature	: 38
CPU Fan Speed	: N/A
VCORE	: +0.872V
12V	: +11.864V
5V	: +5.299V
VCC3V	: +3.472V

### 3.4.5 IT8528SEC Super IO Configuration

EC VERSION	7114E005
Super IO Chip	IT8528SEC

### 3.4.6 CPU Configuration

Intel(R) Core(TM) i5-6200U CPU @ 2.30GHz

CPU Signature	406E3
Microcode Patch	9E
Max CPU Speed	2300 MHz
Mix CPU Speed	400MHz
CPU Speed	2200 MHz
Processor Cores	2
Hyper Threading Technology	Supported
Intel VT-X Technology	Supported
Intel SMX Technology	Not Supported
64-bit	Supported
EIST Technology	Supported
CPU C3 state	Supported
CPU C6 state	Supported
CPU C7 state	Supported
CPU C8 state	Supported

CPU C9 state	Supported
CPU C10 state	Supported
L1 Date Cache	32KB x 2
L1 Code Cache	32KB x 2
L2 Cache	256 KB x 2
L3 Cache	3 MB
L4 Cache	Not Present

Hyper-threading	[Enabled]
Active Processor Cores	[All]
Overclocking lock	[Disabled]
Intel Virtualization Technology	[Enabled]
Hardware Prefetcher	[Enabled]
Adjacent Cache Line Prefetch	[Enabled]
CPU AES	[Enabled]
Boot performance mode	[Max Non-Turbo Performance]
Intel(R) Speed Shift Technology	[Enabled]
Intel(R) SpeedStep(tm)	[Enabled]
Turbo Mode	[Enabled]
Package Power Limit MSR Lock	[Disabled]
1-Core Ratio Limit Override	0
2-Core Ratio Limit Override	0
Configurable TDP Boot Mode	[Nominal]
Configurable TDP Lock	[Disabled]
CTDP BIOS control	[Disabled]
Platform PL1 Enable	[Disabled]
Platform PL2 Enable	[Disabled]
CPU C states	[Enabled]
Enhanced C-states	[Enabled]
C-State Auto Demotion	[C1 and C3]
C-State Un- Demotion	[C1 and C3]
Package C state demotion	[Enabled]
Package C state undemotion	[Enabled]
CState Pre-Wake	[Enabled]
Package C State limit	[AUTO]
CFG lock	[Enabled]

► **Power Limit 3 Settings**

Power Limit 3 Override	[Disabled]
------------------------	------------

► **Power Limit 4 Settings**  
 Power Limit 4 Override [Disabled]

► **CPU Thermal Configuration**  
 CPU DTS [Disabled]  
 TCC Activation Offset 0  
 ACPI 3.0 T-States [Disabled]  
  
 Debug Interface [Disabled]  
 Debug Interface Lock [Enabled]  
 SW Guard Extensions(SGX) [Software Controlled]  
 Select Owner EPOCH input type [No Change In Owner EPOCHS]  
  
 PRMRR Size [AUTO]

**3.4.7 Platform Misc Configuration**

Native PCIE Enable [Enabled]  
 Native ASPM [Auto]  
 BDAT ACPI Table Support [Disabled]  
  
 Intel Ready Mode Technology [Disabled]  
 ACPI Debug [Disabled]  
  
 PTID Support [Enabled]  
 PECI Access Method [Direct I/O]  
  
 Firmware Configuration [Test]  
 ZpODD Support [Disabled]  
  
 PCI Delay Optimization [Disabled]

► **DPTF Configuration**  
 DPTF [Enabled]

► **Platform Setting**  
 Pmic Vcc IO Level [Disabled]  
 Pmic Vddq Level [Disabled]

Power Sharing Manager	[Disabled]
Select Camera	[IVCAM]
Enable 3D Camera DFU device	[Disabled]
Wireless device	[Disabled]
WRDS Package	
WiFi SAR	[Disabled]
HID Event Filter Driver	[Disabled]
Enable Wireless Charge Support	[Disabled]
Enable FFU Support	[Disabled]

### 3.4.8 SATA Configuration

SATA Controller(S)	[Enabled]
SATA Mode	[AHCI]
SATA Test Mode	[Disabled]

#### ► Software Feature Mask SATA Controller

Aggressive LPM Support	[Enabled]
SATA Controller Speed	[Default]

Serial ATA Port 0	Empty
Software Preserve	Unknown
Port 0	[Enabled]
Hot Plug	[Disabled]
External SATA	[Disabled]
Spin Up Device	[Disabled]
SATA Device Type	[Hard Disk Drive]
Topology	[Unknown]
Device Sleep	[Disabled]
SATA DEVSLEP Idle Timeout Config	[Disabled]

Serial ATA Port 1	Empty
Software Preserve	Unknown
Port 1	[Enabled]
Hot Plug	[Disabled]
External SATA	[Disabled]
Spin Up Device	[Disabled]
SATA Device Type	[Hard Disk Drive]
Topology	[Unknown]

Device Sleep	[Disabled]
SATA DEVSLEP Idle Timeout Config	[Disabled]
Serial ATA Port 2	Empty
Software Preserve	Unknown
Port 2	[Enabled]
Hot Plug	[Disabled]
External SATA	[Disabled]
Spin Up Device	[Disabled]
SATA Device Type	[Hard Disk Drive]
Topology	[Unknown]
Device Sleep	[Disabled]
SATA DEVSLEP Idle Timeout Config	[Disabled]
Serial ATA Port 3	Empty
Software Preserve	Unknown
Port 3	[Enabled]
Hot Plug	[Disabled]
External SATA	[Disabled]
Spin Up Device	[Disabled]
SATA Device Type	[Hard Disk Drive]
Topology	[Unknown]
Device Sleep	[Disabled]
SATA DEVSLEP Idle Timeout Config	[Disabled]
Serial ATA Port 4	Empty
Software Preserve	Unknown
Port 4	[Enabled]
Hot Plug	[Disabled]
External SATA	[Disabled]
Spin Up Device	[Disabled]
SATA Device Type	[Hard Disk Drive]
Topology	[Unknown]
Device Sleep	[Disabled]
SATA DEVSLEP Idle Timeout Config	[Disabled]
Serial ATA Port 5	Empty
Software Preserve	Unknown

Port 5	[Enabled]
Hot Plug	[Disabled]
External SATA	[Disabled]
Spin Up Device	[Disabled]
SATA Device Type	[Hard Disk Drive]
Topology	[Unknown]
Device Sleep	[Disabled]
SATA DEVSLEP Idle Timeout Config	[Disabled]

### 3.4.9 CSM Configuration

#### Compatibility Support Module Configuration

CSM Support	[Enabled]
CSM16 Module Version	07.79
GateA20 Active	[Upon Request]
Option ROM Messages	[Force BIOS]
INT19 Trap Response	[Immediate]
Boot option filter	[UEFI and Legacy]
Option ROM execution	
Network	[Do not launch]
Storage	[UEFI]
Video	[Legacy]
Other PCI devices	[UEFI]

### 3.4.10 USB Configuration

USB Module Version	16
USB Controllers:	1XHCI
USB Devices:	1 Keyboard,1 Mouse
Legacy USB Support	[Enabled]

XHCI Hand-off	[Enabled]
USB Mass Storage Driver Support	[Enabled]
Port 60/64 Emulation	[Disabled]

USB Hardware delays and time-outs:

USB transfer time-out	[20 sec]
Device reset time-out	[20 sec]
Device power-up delay	[Auto]

### 3.5 Chipset Settings

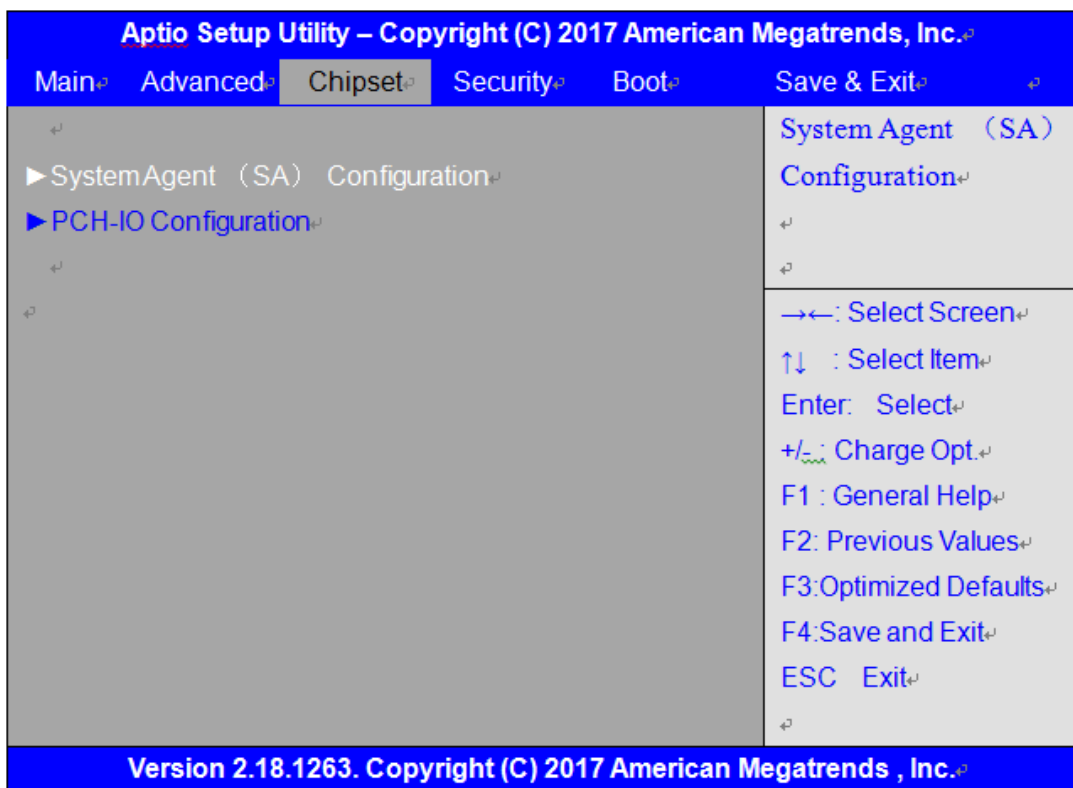

#### 3.5.1 System Agent (SA) Configuration

System Agent Bridge Name	Skylake
SA PCIe Code Version	2.0.0.0
VT-d	Supported
VT-d	[Enabled]
Primary IGFX Boot Display	[VBIOS Deafault]
Secondary IGFX Boot Display	[Disabled]
Active LFP	[eDP Port-A]
Panel Color Depth	[18 Bit]

LCD Backlight Control	[PWM Normal by BIOS]
BIOS Control Backlight Level	[Level7]
<b>► Graphics Configuration</b>	
IGFX VBIOS Version	1046
Graphics Turbo IMON Current	31
Skip Scanning of External Gfx Card	[Disabled]
Primary Display	[Auto]
Primary PEG	[Auto]
Primary PCIE	[Auto]
Internal Graphics	[Auto]
GTT Size	[8MB]
Aperture Size	[256MB]
DVMT Pre-Allocated	[32M]
DVMT Total Gfx Mem	[256M]
Gfx Low Power Mode	[Enabled]
VDD Enable	[Enabled]
PM Support	[Enabled]
PAVP Enable	[Enabled]
Cdynmax Clamping Enable	[Enabled]
Cd Clock Frequency	[675MHz]
<b>► Intel(R) Ultrabook Event Support</b>	
IUER Slate Enable	[Disabled]
IUER Dock Enable	[Disabled]
IUER Button Enable	[Disabled]
<b>► DMI/OPI Configuration</b>	
DMI Vc1 Control	[Disabled]
DMI Vcm Control	[Enabled]
<b>► Memory Configuration</b>	
Memory RC Version	2.0.0.1
Memory Frequency	2133MHz
Total Memory	4096MB
VDD	1200
DIMM#0	4096MB
DIMM#1	Not Present
DIMM#2	Not Present
DIMM#3	Not Present



Memory Timings(tCL-tRCD-tRP-tRAS)	15-36
MRC ULT Safe Conifg	[Disabled]
Maximum Memory Frequency	[Auto]
HOB Buffer Size	[Auto]
ECC Support	[Enabled]
Max TOLUD	[Dynamic]
LCD Backlight Mode	[PWM]
Backlight Control	[PWM Normal by BIOS]
BIOS Control Backlight Level	[Level 7]
SA GV	[Enabled]
SA GV Low Freq	[MRC default]
Energy Performance Gain	[Disabled]
EPG DIMM Idd3N	26
EPG DIMM Idd3P	11
Retrain on Fast fall	[Enabled]
Enable RH Prevention	[Enabled]
Row Hammer Solution	[Hardware RHP]
RH Activation Probability	[1/2^11]
Exit On Failure(MRC)	[Enabled]
MC Lock	[Enabled]
Probeless Trace	[Disabled]
Enable/Disable IED(Intel Enhanced Debug)	[Disabled]
Ch Hash Support	[Enabled]
Ch Hash Mask	12488
Ch Hash Interleaved Bit	[BIT8]
VC1 Read Metering	[Enabled]
VC1 RdMeter Time Window	800
VC1 RdMeter Threshold	280
Strong Weak Leaker	7
Memory Scrambler	[Enabled]
Channel A DIMM Control	[Enable both DIMMS]
Channel B DIMM Control	[Enable both DIMMS]
Force Single Rank	[Disabled]
Memory Remap	[Enabled]
Time Measure	[Disabled]
Lpddr Mem WL Set	[Set B]
EV Loader	[Disabled]

EV Loader Delay	[Enabled]
Fast Boot	[Enabled]
DLL Weak Lock Support	[Enabled]
<b>▶ Memory Thermal Configuration</b>	
<b>▶ Memory Power and Thermal Throttling</b>	
DDR PowerDown and idle counter	[BIOS]
For LPDDR Only:DDR PowerDown and idle counter	[BIOS]
REFRESH_2X_MODE	[Disabled]
LPDDR Thermal Sensor	[Enabled]
SelfRefresh Enable	[Enabled]
SelfRefresh IdleTimer	512
Throttler CKEMin Defeature	[Enabled]
Throttler CKEMin Timer	48
For LPDDR Only:Throttler CKEMin Defeature	Enabled]
For LPDDR Only:Throttler CKEMin Timer	64
Pwr Down Idle Timer	0
<b>▶ Dram Power Idle Timer</b>	
Use user provided power weights,scale factor,and channel power floor values	[Disabled]
Energy Scale factor	4
Idle Energy Ch0Dimm0	10
PowerDown Energy Ch0Dimm0	6
Activate Energy Ch0Dimm0	172
Read Energy Ch0Dimm0	212
Write Energy Ch0Dimm0	221
Idle Energy Ch0Dimm1	10
PowerDown Energy Ch0Dimm1	6
Activate Energy Ch0Dimm1	172
Read Energy Ch0Dimm1	212
Write Energy Ch0Dimm1	221
Idle Energy Ch1Dimm0	10
PowerDown Energy Ch1Dimm0	6

Activate Energy Ch1Dimm0	172
Read Energy Ch1Dimm0	212
Write Energy Ch1Dimm0	221
Idle Energy Ch1Dimm0	10
PowerDown Energy Ch1Dimm0	6
Activate Energy Ch1Dimm0	172
Read Energy Ch1Dimm0	212
Write Energy Ch1Dimm0	221
Idle Energy Ch1Dimm1	10
PowerDown Energy Ch1Dimm1	6
Activate Energy Ch1Dimm1	172
Read Energy Ch1Dimm1	212
Write Energy Ch1Dimm1	221

#### ► Memory Thermal Reporting

Lock Thermal:Management Registers [Enabled]

#### Memory Thermal Reporting

Extern Therm Status [Disabled]

Closed Loop Therm Manage [Disabled]

Open Loop Therm Manage [Disabled]

#### Thermal Threhold Settings

Warm Threshold Ch0 Dimm0 255

Warm Threshold Ch0 Dimm1 255

Hot Threshold Ch0 Dimm0 255

Hot Threshold Ch0 Dimm1 255

Warm Threshold Ch1 Dimm0 255

Warm Threshold Ch1 Dimm1 255

Hot Threshold Ch1 Dimm0 255

Hot Threshold Ch1 Dimm1 255

#### Thermal Throttle Budget Settings

Warm Budget Ch0 Dimm0 255

Warm Budget Ch0 Dimm1	255
Hot Budget Ch0 Dimm0	255
Hot Budget Ch0 Dimm1	255
Warm Budget Ch1 Dimm0	255
<b>Warm Budget Ch1 Dimm1</b>	255
Hot Budget Ch1 Dimm0	255
Hot Budget Ch1 Dimm1	255

► **Memory RAPL**

Rapl Power Floor Ch0	0
Rapl Power Floor Ch1	0

RAPL PL Lock	[Disabled]
RAPL PL 1 enable	[Disabled]
RAPL PL 1 Power	0
RAPL PL 1 WindowX	0
RAPL PL 1 WindowY	0

RAPL PL 1 enable	[Disabled]
RAPL PL 1 Power	0
RAPL PL 1 WindowX	0
RAPL PL 1 WindowY	0

Memory Thermal Management	[Disabled]
---------------------------	------------

► **Memory Training Algorithms**

Early Command Training	[Disabled]
SenseAmp Offset Training	[Enabled]
Early ReadMPR Timing Centering 2D	[Enabled]
Read MPR Training	[Enabled]
Receive Enable Training	[Enabled]
Jedec Write Leveling	[Enabled]
Early Write Time Centering 2D	[Enabled]
Early Read Time Centering 2D	[Enabled]
Write Timing Centering 1D	[Enabled]
Write Voltage Centering 1D	[Enabled]
Read Timing Centering 1D	[Enabled]
Dimm ODT Training*	[Enabled]
Max RTT_WR	[ODT Off]

DIMM RON Training*	[Enabled]
Write Drive Strength/Equalization 2D*	[Disabled]
Write Slew Rate Training*	[Enabled]
Read ODT Training*	[Enabled]
Read Equalization Training*	[Enabled]
Read Amplifier Training*	[Enabled]
Write Timing Centering 2D	[Enabled]
Read Timing Centering 2D	[Enabled]
Command Voltage Centering	[Enabled]
Write Voltage Centering	[Enabled]
Read Voltage Centering 2D	[Enabled]
Late Command Training	[Enabled]
Round Trip Latency	[Enabled]
Turn Around Timing Training	[Enabled]
Rank Margin Tool	[Disabled]
Memory Test	[Disabled]
DIMM SPD Alias Test	[Enabled]
Receive Enable Centering 1D	[Enabled]
Retrain Margin Check	[Enabled]
Command Power Training	[Disabled]

► **GT-Power Management Control**

GT Info	GT2
RC6(Render Standby)	<b>[Enabled]</b>

**3.5.2 PCH-IO Configuration**

Intel PCH RC Version	2.0.0.0
Intel PCH SKU Name	PCH-LP Mobile(U) Premium SKU
Intel PCH REV ID	21/C1

► **PCI Express Configuration**

PCI Express Clock Gating	[Enabled]
DMI Link ASPM Control	[Enabled]
Port8xh Decode	[Disabled]
Peer Memory Write Enable	[Disabled]

Compliance Test Mode	[Disabled]
PCIe-USB Glitch W/A	[Disabled]
PCIe function swap	[Enabled]
<b>► PCI Express Gen3 Eq Lanes</b>	
Override SW EQ Settings	[Disabled]
<b>► PCI Express Root Port 1</b>	
PCI Express Root Port 1	[Enabled]
Topology	[Unknown]
ASPM Support	[Auto]
L1 SubStates	[L1.1&L1.2]
Gen3 Eq Phase3 Method	[Software Search]
UPTP	5
DPTP	7
ACS	[Enabled]
URR	[Disabled]
FER	[Disabled]
NFER	[Disabled]
CER	[Disabled]
CTO	[Disabled]
SEFE	[Disabled]
SENF	[Disabled]
SECE	[Disabled]
PME SCI	[Enabled]
Hot Plug	[Disabled]
Advanced Error Reporting	[Enabled]
PCIe Speed	[Auto]
Transmitter Half Swing	[Disabled]
Detect Non-Compliance Device	[Disabled]
Extra Bus Reserved	0
Reserved Memory	10
Prefetchable Memory	10
Reserved I/O	4
PCIE Cp	2
PCIE Cm	6
PCIE LTR	[Enabled]
PCIE LTR Lock	[Disabled]
PCH PCIe CLKREQ# Configuration	

PCIE1 CLKREQ Mapping Override	[Default]
Snoop Latency Ocerride	[Auto]
Non Snoop Latency Ocerride	[Auto]

► **PCI Express Root Port 2**

PCI Express Root Port 2	[Enabled]
Topology	[Unknown]
ASPM Support	[Auto]
L1 SubStates	[L1.1&L1.2]
Gen3 Eq Phase3 Method	[Software Search]
UPTP	5
DPTP	7
ACS	[Enabled]
URR	[Disabled]
FER	[Disabled]
NFER	[Disabled]
CER	[Disabled]
CTO	[Disabled]
SEFE	[Disabled]
SENF	[Disabled]
SECE	[Disabled]
PME SCI	[Enabled]
Hot Plug	[Disabled]
Advanced Error Reporting	[Enabled]
PCIe Speed	[Auto]
Transmitter Half Swing	[Disabled]
Detect Non-Compliance Device	[Disabled]
Extra Bus Reserved	0
Reserved Memory	10
Prefetchable Memory	10
Reserved I/O	4
PCIE Cp	2
PCIE Cm	6
PCIE LTR	[Enabled]
PCIE LTR Lock	[Disabled]
PCH PCIe CLKREQ# Configuration	
PCIE2 CLKREQ Mapping Override	[Default]

Snoop Latency Ocerride	[Auto]
Non Snoop Latency Ocerride	[Auto]
<b>► PCI Express Root Port 3</b>	
PCI Express Root Port 3	[Enabled]
Topology	[Unknown]
ASPM Support	[Auto]
L1 SubStates	[L1.1&L1.2]
Gen3 Eq Phase3 Method	[Software Search]
UPTP	5
DPTP	7
ACS	[Enabled]
URR	[Disabled]
FER	[Disabled]
NFER	[Disabled]
CER	[Disabled]
CTO	[Disabled]
SEFE	[Disabled]
SENF	[Disabled]
SECE	[Disabled]
PME SCI	[Enabled]
Hot Plug	[Disabled]
Advanced Error Reporting	[Enabled]
PCIe Speed	[Auto]
Transmitter Half Swing	[Disabled]
Detect Non-Compliance Device	[Disabled]
Extra Bus Reserved	0
Reserved Memory	10
Prefetchable Memory	10
Reserved I/O	4
PCIE Cp	2
PCIE Cm	6
PCIE LTR	[Enabled]
PCIE LTR Lock	[Disabled]
PCH PCIe CLKREQ# Configuration	
PCIE3 CLKREQ Mapping Override	[Default]
Snoop Latency Ocerride	[Auto]
Non Snoop Latency Ocerride	[Auto]



#### ► PCI Express Root Port 4

PCI Express Root Port 4	[Enabled]
Topology	[Unknown]
ASPM Support	[Auto]
L1 SubStates	[L1.1&L1.2]
Gen3 Eq Phase3 Method	[Software Search]
UPTP	5
DPTP	7
ACS	[Enabled]
URR	[Disabled]
FER	[Disabled]
NFER	[Disabled]
CER	[Disabled]
CTO	[Disabled]
SEFE	[Disabled]
SENF	[Disabled]
SECE	[Disabled]
PME SCI	[Enabled]
Hot Plug	[Disabled]
Advanced Error Reporting	[Enabled]
PCIe Speed	[Auto]
Transmitter Half Swing	[Disabled]
Detect Non-Compliance Device	[Disabled]
Extra Bus Reserved	0
Reserved Memory	10
Prefetchable Memory	10
Reserved I/O	4
PCIE Cp	2
PCIE Cm	6
PCIE LTR	[Enabled]
PCIE LTR Lock	[Disabled]
PCH PCIe CLKREQ# Configuration	
PCIE4 CLKREQ Mapping Override	[Default]
Snoop Latency Ocerride	[Auto]
Non Snoop Latency Ocerride	[Auto]

#### ► PCI Express Root Port 5

PCI Express Root Port 5	[Enabled]
Topology	[Unknown]
ASPM Support	[Auto]
L1 SubStates	[L1.1&L1.2]
Gen3 Eq Phase3 Method	[Software Search]
UPTP	5
DPTP	7
ACS	[Enabled]
URR	[Disabled]
FER	[Disabled]
NFER	[Disabled]
CER	[Disabled]
CTO	[Disabled]
SEFE	[Disabled]
SENF	[Disabled]
SECE	[Disabled]
PME SCI	[Enabled]
Hot Plug	[Disabled]
Advanced Error Reporting	[Enabled]
PCIe Speed	[Auto]
Transmitter Half Swing	[Disabled]
Detect Non-Compliance Device	[Disabled]
Extra Bus Reserved	0
Reserved Memory	10
Prefetchable Memory	10
Reserved I/O	4
PCIE Cp	2
PCIE Cm	6
PCIE LTR	[Enabled]
PCIE LTR Lock	[Disabled]
PCH PCIe CLKREQ# Configuration	
PCIE5 CLKREQ Mapping Override	[Default]
Snoop Latency Ocerride	[Auto]
Non Snoop Latency Ocerride	[Auto]
► <b>PCI Express Root Port 6</b>	
PCI Express Root Port 6	[Enabled]
Topology	[Unknown]

ASPM Support	[Auto]
L1 SubStates	[L1.1&L1.2]
Gen3 Eq Phase3 Method	[Software Search]
UPTP	5
DPTP	7
ACS	[Enabled]
URR	[Disabled]
FER	[Disabled]
NFER	[Disabled]
CER	[Disabled]
CTO	[Disabled]
SEFE	[Disabled]
SENF	[Disabled]
SECE	[Disabled]
PME SCI	[Enabled]
Hot Plug	[Disabled]
Advanced Error Reporting	[Enabled]
PCIe Speed	[Auto]
Transmitter Half Swing	[Disabled]
Detect Non-Compliance Device	[Disabled]
Extra Bus Reserved	0
Reserved Memory	10
Prefetchable Memory	10
Reserved I/O	4
PCIE Cp	2
PCIE Cm	6
PCIE LTR	[Enabled]
PCIE LTR Lock	[Disabled]
PCH PCIe CLKREQ# Configuration	
PCIE6 CLKREQ Mapping Override	[Default]
Snoop Latency Ocerride	[Auto]
Non Snoop Latency Ocerride	[Auto]

► **PCI Express Root Port 7**

PCI Express Root Port 7	[Enabled]
Topology	[Unknown]
ASPM Support	[Auto]

L1 SubStates	[L1.1&L1.2]
Gen3 Eq Phase3 Method	[Software Search]
UPTP	5
DPTP	7
ACS	[Enabled]
URR	[Disabled]
FER	[Disabled]
NFER	[Disabled]
CER	[Disabled]
CTO	[Disabled]
SEFE	[Disabled]
SENF	[Disabled]
SECE	[Disabled]
PME SCI	[Enabled]
Hot Plug	[Disabled]
Advanced Error Reporting	[Enabled]
PCIe Speed	[Auto]
Transmitter Half Swing	[Disabled]
Detect Non-Compliance Device	[Disabled]
Extra Bus Reserved	0
Reserved Memory	10
Prefetchable Memory	10
Reserved I/O	4
PCIE Cp	2
PCIE Cm	6
PCIE LTR	[Enabled]
PCIE LTR Lock	[Disabled]
PCH PCIe CLKREQ# Configuration	
PCIE7 CLKREQ Mapping Override	[Default]
Snoop Latency Ocerride	[Auto]
Non Snoop Latency Ocerride	[Auto]

► **PCI Express Root Port 8**

PCI Express Root Port 8	[Enabled]
Topology	[Unknown]
ASPM Support	[Auto]
L1 SubStates	[L1.1&L1.2]

Gen3 Eq Phase3 Method	[Software Search]
UPTP	5
DPTP	7
ACS	[Enabled]
URR	[Disabled]
FER	[Disabled]
NFER	[Disabled]
CER	[Disabled]
CTO	[Disabled]
SEFE	[Disabled]
SENF	[Disabled]
SECE	[Disabled]
PME SCI	[Enabled]
Hot Plug	[Disabled]
Advanced Error Reporting	[Enabled]
PCIe Speed	[Auto]
Transmitter Half Swing	[Disabled]
Detect Non-Compliance Device	[Disabled]
Extra Bus Reserved	0
Reserved Memory	10
Prefetchable Memory	10
Reserved I/O	4
PCIE Cp	2
PCIE Cm	6
PCIE LTR	[Enabled]
PCIE LTR Lock	[Disabled]
PCH PCIe CLKREQ# Configuration	
PCIE8 CLKREQ Mapping Override	[Default]
Snoop Latency Ocerride	[Auto]
Non Snoop Latency Ocerride	[Auto]

► **PCI Express Root Port 9**

PCI Express Root Port 9	[Enabled]
Topology	[Unknown]
ASPM Support	[Auto]
L1 SubStates	[L1.1&L1.2]
Gen3 Eq Phase3 Method	[Software Search]

UPTP	5
DPTP	7
ACS	[Enabled]
URR	[Disabled]
FER	[Disabled]
NFER	[Disabled]
CER	[Disabled]
CTO	[Disabled]
SEFE	[Disabled]
SENF	[Disabled]
SECE	[Disabled]
PME SCI	[Enabled]
Hot Plug	[Disabled]
Advanced Error Reporting	[Enabled]
PCIe Speed	[Auto]
Transmitter Half Swing	[Disabled]
Detect Non-Compliance Device	[Disabled]
Extra Bus Reserved	0
Reserved Memory	10
Prefetchable Memory	10
Reserved I/O	4
PCIE Cp	2
PCIE Cm	6
PCIE LTR	[Enabled]
PCIE LTR Lock	[Disabled]
PCH PCIe CLKREQ# Configuration	
PCIE9 CLKREQ Mapping Override	[Default]
Snoop Latency Ocerride	[Auto]
Non Snoop Latency Ocerride	[Auto]
<b>► PCI Express Root Port 10</b>	
PCI Express Root Port 10	[Enabled]
Topology	[Unknown]
ASPM Support	[Auto]
L1 SubStates	[L1.1&L1.2]
Gen3 Eq Phase3 Method	[Software Search]
UPTP	5
DPTP	7

ACS	[Enabled]
URR	[Disabled]
FER	[Disabled]
NFER	[Disabled]
CER	[Disabled]
CTO	[Disabled]
SEFE	[Disabled]
SENF	[Disabled]
SECE	[Disabled]
PME SCI	[Enabled]
Hot Plug	[Disabled]
Advanced Error Reporting	[Enabled]
PCIe Speed	[Auto]
Transmitter Half Swing	[Disabled]
Detect Non-Compliance Device	[Disabled]
Extra Bus Reserved	0
Reserved Memory	10
Prefetchable Memory	10
Reserved I/O	4
PCIE Cp	2
PCIE Cm	6
PCIE LTR	[Enabled]
PCIE LTR Lock	[Disabled]
PCH PCIe CLKREQ# Configuration	
PCIE10 CLKREQ Mapping Override	[Default]
Snoop Latency Ocerride	[Auto]
Non Snoop Latency Ocerride	[Auto]

► **PCI Express Root Port 11**

PCI Express Root Port 11	[Enabled]
Topology	[Unknown]
ASPM Support	[Auto]
L1 SubStates	[L1.1&L1.2]
Gen3 Eq Phase3 Method	[Software Search]
UPTP	5
DPTP	7
ACS	[Enabled]

URR	[Disabled]
FER	[Disabled]
NFER	[Disabled]
CER	[Disabled]
CTO	[Disabled]
SEFE	[Disabled]
SENF	[Disabled]
SECE	[Disabled]
PME SCI	[Enabled]
Hot Plug	[Disabled]
Advanced Error Reporting	[Enabled]
PCIe Speed	[Auto]
Transmitter Half Swing	[Disabled]
Detect Non-Compliance Device	[Disabled]
Extra Bus Reserved	0
Reserved Memory	10
Prefetchable Memory	10
Reserved I/O	4
PCIE Cp	2
PCIE Cm	6
PCIE LTR	[Enabled]
PCIE LTR Lock	[Disabled]
PCH PCIe CLKREQ# Configuration	
PCIE11 CLKREQ Mapping Override	[Default]
Snoop Latency Ocerride	[Auto]
Non Snoop Latency Ocerride	[Auto]

► **PCI Express Root Port 12**

PCI Express Root Port 12	[Enabled]
Topology	[Unknown]
ASPM Support	[Auto]
L1 SubStates	[L1.1&L1.2]
Gen3 Eq Phase3 Method	[Software Search]
UPTP	5
DPTP	7
ACS	[Enabled]
URR	[Disabled]



FER	[Disabled]
NFER	[Disabled]
CER	[Disabled]
CTO	[Disabled]
SEFE	[Disabled]
SENF	[Disabled]
SECE	[Disabled]
PME SCI	[Enabled]
Hot Plug	[Disabled]
Advanced Error Reporting	[Enabled]
PCIe Speed	[Auto]
Transmitter Half Swing	[Disabled]
Detect Non-Compliance Device	[Disabled]
Extra Bus Reserved	0
Reserved Memory	10
Prefetchable Memory	10
Reserved I/O	4
PCIE Cp	2
PCIE Cm	6
PCIE LTR	[Enabled]
PCIE LTR Lock	[Disabled]
PCH PCIe CLKREQ# Configuration	
PCIE12 CLKREQ Mapping Override	[Default]
Snoop Latency Ocerride	[Auto]
Non Snoop Latency Ocerride	[Auto]
<b>► USB Configuration</b>	
USB Precondition	[Disabled]
XHCI Disable Compliance Mode	[FALSE]
xDCI Support	[Disabled]
USB Port Disable Override	[Disabled]
<b>► BIOS Security Configuration</b>	
RTC Lock	[Enabled]
BIOS Lock	[Disabled]
<b>► HD Audio Configuration</b>	
HD Audio	[Autio]
Audio DSP	[Disabled]

HDA-Link Codec Select	[Platform Onboard]
iDisplay Audio Disconnect	[Disabled]
PME Enable	[Disabled]

► **HD Audio Advanced Configuration**

HD Audio Subsystem Advanced Configuration Settings

I/O Buffer Control:

I/O Buffer Ownership [HD-Audio Link]

I/O Buffer Voltage Select [3.3V]

Statically Switchable BCLK Clock

Frequency Configuration:

HD Audio Link Frequency [24MHz]

iDisplay Link Frequency [96MHz]

► **HD Audio DSP Features Configuration**

HD Audio Subsystem Features Configuration(ACPI)

Audio DSP NHLT Endpoints:

Configuration:

DMIC [4 Mic Array]

Bluetooth [Disabled]

I2S [Disabled]

Audio DSP Feature Support:

WoV(Wake on Voice) [Disabled]

Bluetooth Sideband [Disabled]

BT Intel HFP [Disabled]

BT Intel A2DP [Disabled]

Codec based VAD [Disabled]

DSP based Speech.Pre-Processing Disabled [Disabled]

Voice Activity Detection [Intel Wake on Voice]

Audio DSP Pre/Post-Processing

Module Support:

Waves [Disabled]

DTS [Disabled]

IntelSst Speech [Disabled]

Dolby [Disabled]

ForteMedia SAMSoft	[Disabled]
Intel WoV	[Disabled]
Sound Research IP	[Disabled]
Conexant Pre-Process	[Disabled]
Conexant Smart Amp	[Disabled]
Custom Module 'Alpha'	[Disabled]
Custom Module 'Beta'	[Disabled]
Custom Module 'Gamma'	[Disabled]
<b>► Serial IO Configuration</b>	
Touch Panel	[SPI Touch]
BT/UART Mux Select	[UART Signal]
I2C0 Controller	[Disabled]
I2C1 Controller	[Disabled]
I2C2 Controller	[Disabled]
I2C3 Controller	[Disabled]
I2C4 Controller	[Disabled]
I2C5 Controller	[Disabled]
SPI0 Controller	[Disabled]
SPI1 Controller	[Disabled]
UART0 Controller	[Disabled]
UART1 Controller	[Disabled]
UART2 Controller	[Disabled]
GPIO Controller	[Enabled]
<b>► Serial IO GPIO Settings</b>	
GPIO IRQ Route	[IRQ14]
WITT/MITT Test Device	[Disabled]
UART Test Device	[Disabled]
Additional Serial IO devices	[Disabled]
<b>► SerialIO timing parameters</b>	
SerialIO timing parameters	[Disabled]
<b>► SkyCam Configuration</b>	
SkyCam CIO2 Device	[Disabled]
Control Logic 0	[Disabled]
Control Logic 1	[Disabled]

Control Logic 2	[Disabled]
Control Logic 3	[Disabled]
Link0	[Disabled]
Link1	[Disabled]
Link2	[Disabled]
Link3	[Disabled]
PORT-A HS-RXEN/TEM-EN Override	[Disabled]
PORT-B HS-RXEN/TEM-EN Override	[Disabled]
PORT-C HS-RXEN/TEM-EN Override	[Disabled]
PORT-D HS-RXEN/TEM-EN Override	[Disabled]
PORT-A CTLE	[Enabled]
PORT-B CTLE	[Enabled]
PORT-C/D CTLE	[Enabled]
PORT-A CTLE CAP Value	e
PORT-A CTLE RES Value	d
PORT-B CTLE CAP Value	e
PORT-B CTLE RES Value	d
PORT-C/D CTLE CAP Value	e
PORT-C/D CTLE RES Value	d
PORT-A TRIM	[Enabled]
PORT-B TRIM	[Enabled]
PORT-C TRIM	[Enabled]
PORT-D TRIM	[Enabled]
PORT-A Data Trim Value	bbbb
PORT-B Data Trim Value	bbbb
PORT-C/D Data Trim Value	cccc
PORT-A Clk Trim Value	a
PORT-B Clk Trim Value	a
PORT-C Clk Trim Value	9
PORT-D Clk Trim Value	a

► **SCS Configuration**

eMMC 5.0 Controller	[Enabled]
eMMC 5.0 HS400 Mode	[Enabled]
Driver Strength	[33 Ohm]
SDCard 3.0 Controller	[Disabled]

► **ISH Configuration**

ISH Controller	[Disabled]
PDT Unlock Message	[Disabled]

► **TraceHub Configuration Menu**

TraceHub Enabled Mode	[Disabled]
MemRegion 0 Buffer Size	[1MB]
MemRegion 1 Buffer Size	[1MB]

► **Pch Thermal Throttling Control**

Thermal Throttling Level	[Suggested Setting]
DMI Thermal Setting	[Suggested Setting]
SATA Thermal Setting	[Suggested Setting]

► **SB Porting Configuration**

SATA RAID ROM	[Legacy ROM]
DCI enable(HDCIEN)	[Disabled]
DCI Auto Detect Enabled	[Enabled]
Debug Port Selection	[Legacy UART]
GNSS	[Disabled]
PCH LAN Controller	[Enabled]
LAN PHY Drives LAN_WAKE#	[Disabled]
Sensor Hub Type	[None]
DeepSx Power Policies	[Disabled]
LAN Wake From DeepSx	[Enabled]
Wake on LAN	[Enabled]
SLP_LAN# Low on DC Power	[Enabled]
K1 off	[Enabled]
Wake on WLAN Enable	[Disabled]
Disable DSX ACPRESENT PullDown	[Disabled]
CLKRUN# Logic	[Enabled]
Serial IRQ Mode	[Continuous]
Port 61h Bit-4 Emulation	[Enabled]
High Precision Timer	[Enabled]
State After G3	[S5 State]
Port 80h Redirection	[LPC Bus]
Enhance Port 80h LPC Decoding	[Enabled]
Compatible Revision ID	[Disabled]

PCH Cross Throttling	[Enabled]
Disable Energy Reporting	[Disabled]
Capsule Reset Type	[Capsule S3 Resume]
Pcie Pll SSC	[Auto]
IOAPIC 24-119 Entries	[Enabled]
Unlock PCH P2SB	[Disabled]
PMC READ DISABLE	[Enabled]

### 3.6 Security Settings

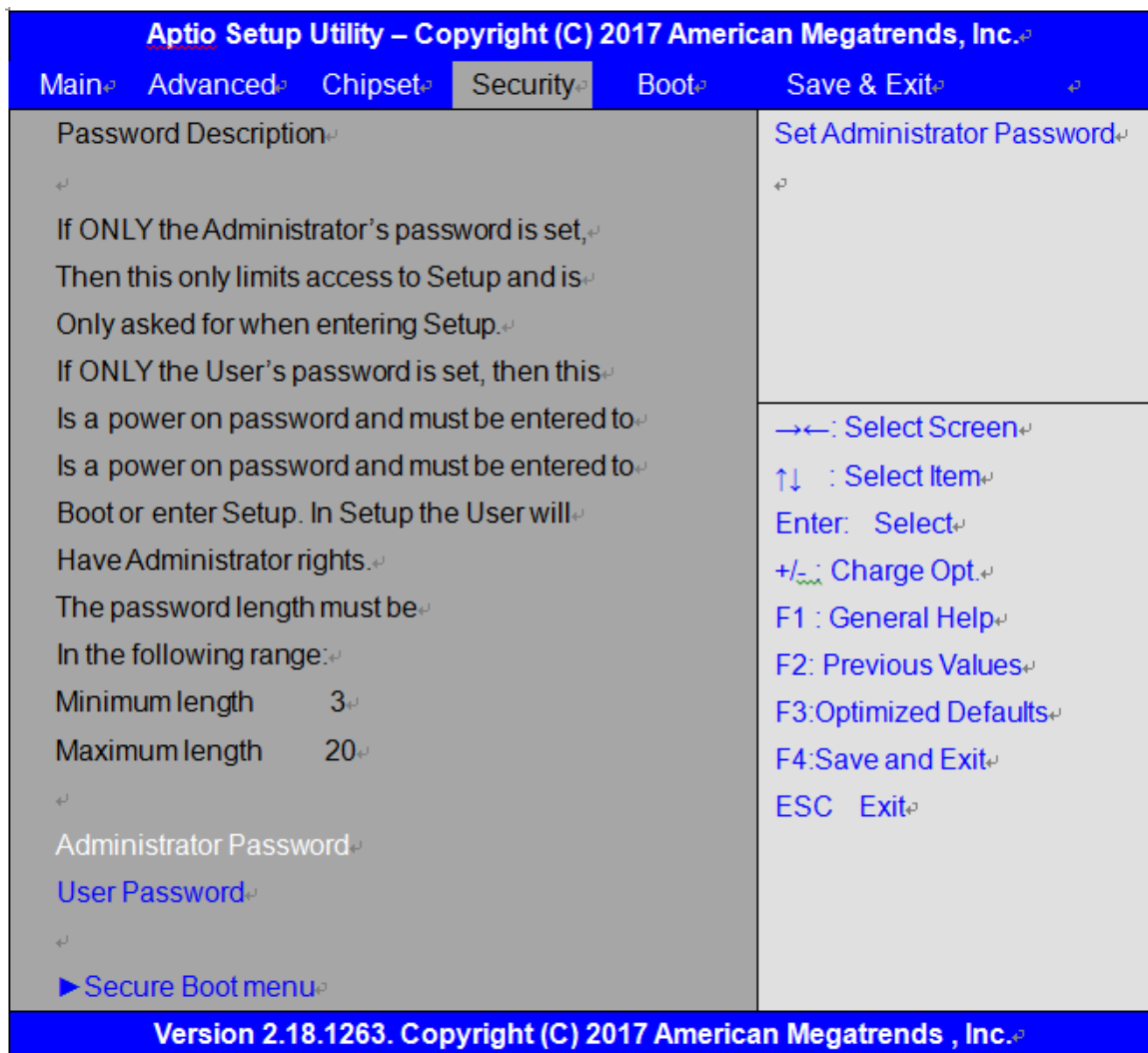

#### 3.6.1 Administrator Password



#### 3.6.2 User Password



Type the password with up to 20 characters and then press <Enter> key. This will clear all previously typed CMOS passwords. You will be requested to confirm the password. Type the password again and press <Enter> key. You may press <Esc> key to abandon password entry operation.

To clear the password, just press <Enter> key when password input window pops up. A confirmation message will be shown on the screen as to whether the password will be disabled. You will have direct access to BIOS setup without typing any password after system reboot once the password is disabled.

Once the password feature is used, you will be requested to type the password each time you enter BIOS setup. This will prevent unauthorized persons from changing your system configurations.

Also, the feature is capable of requesting users to enter the password prior to system boot to control unauthorized access to your computer. Users may enable the feature in Security Option of Advanced BIOS Features. If Security Option is set to System, you will be requested to enter the password before system boot and when entering BIOS setup; if Security Option is set to Setup, you will be requested for password for entering BIOS setup.

### 3.7 Boot Settings

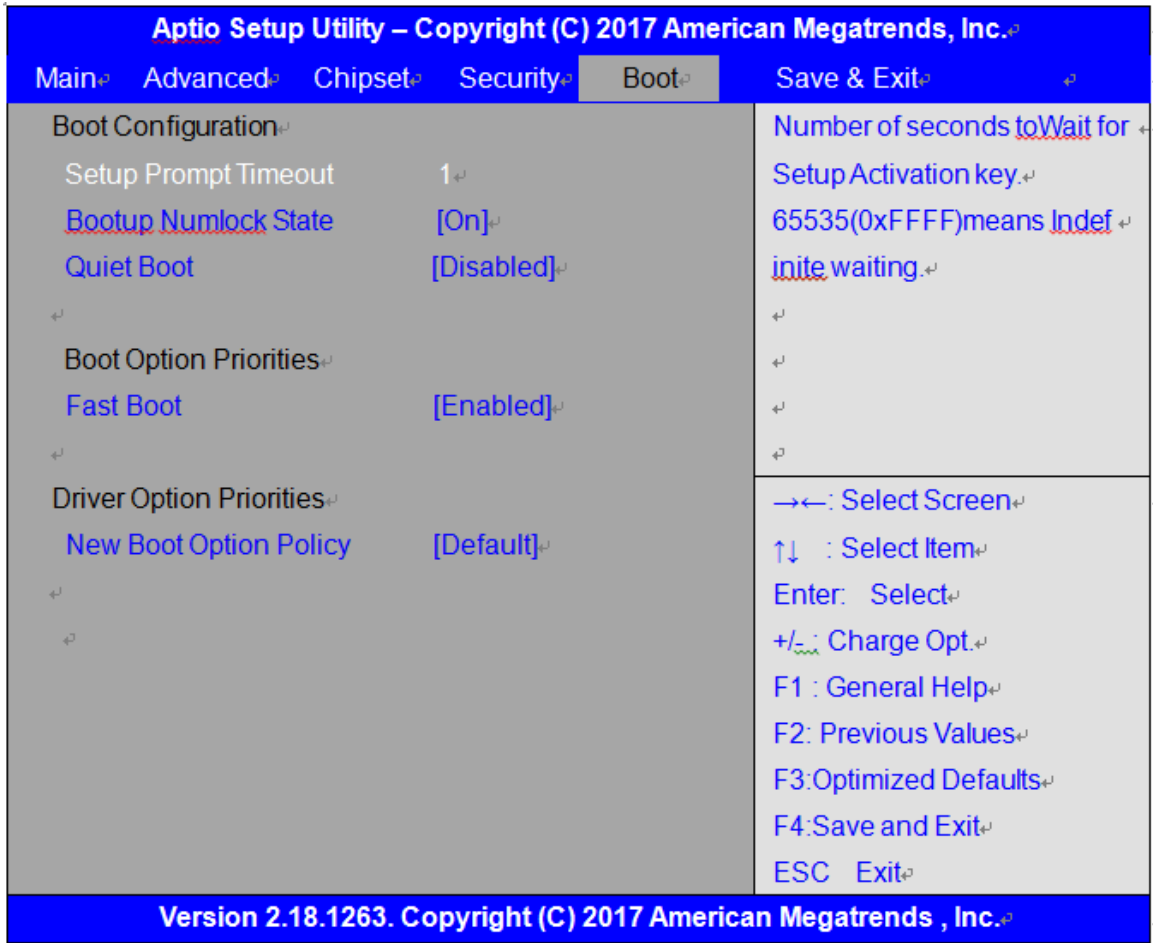

Setup Prompt Timeout	1
Bootup Numlock State	[On]
Quiet Boot	[Disabled]
Boot Option Priorities	
Fast Boot	[Disabled]
Driver Option Priorities	
New Boot Option Policy	[Default]



### 3.8 Save & Exit Settings

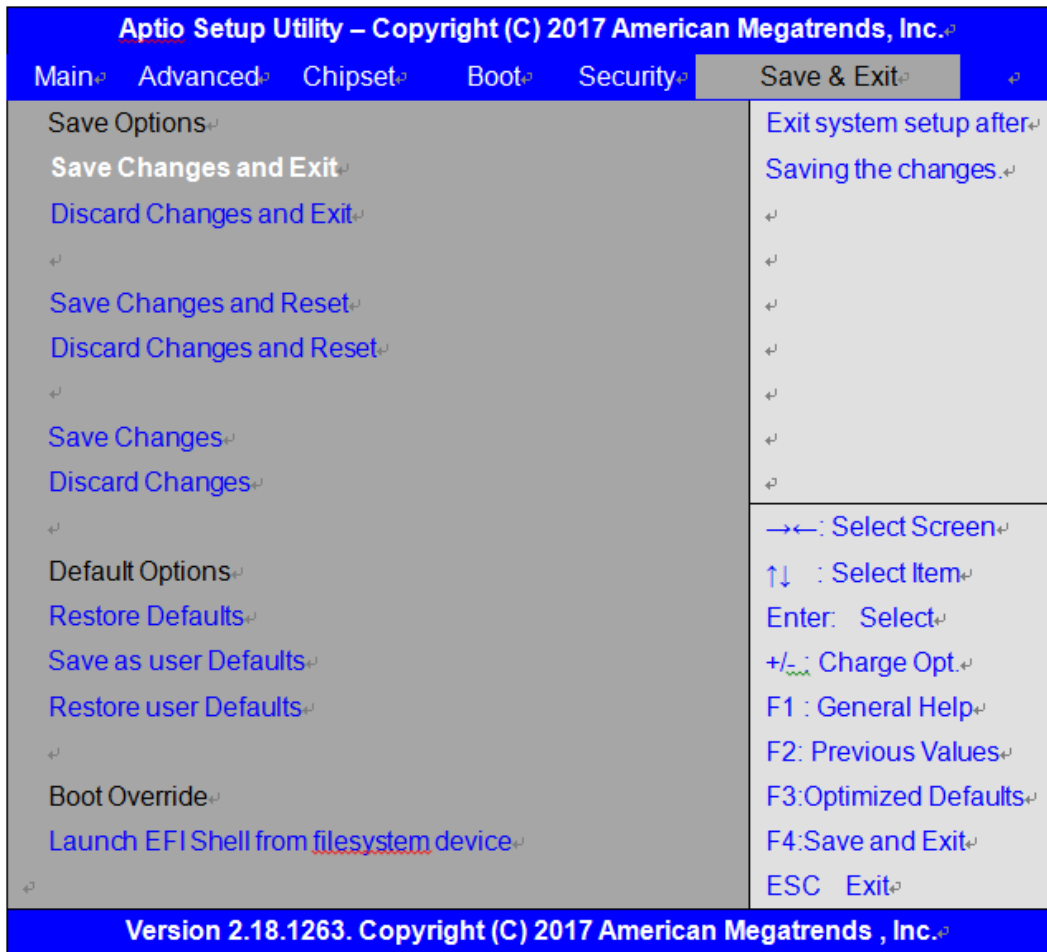

Save Changes and Exit

Save & Exit Setup save Configuration and exit ?

[Yes]

[No]

Discard Changes and Ext

Exit Without Saving Quit without saving?

[Yes]

[No]

Save Changes and Reset

Reset the system after Saving The changes?

[Yes]

[No]

Discard Changes and Reset

Reset system setup without Saving any changes?

[Yes]

[No]

Save Changes

Save Setup done so far to any of the setup options?

[Yes]

[No]

Discard Changes

Discard Changes done so far to any of the setup options?

[Yes]

[No]

Restore Defaults

Restore /Load Defaults values for all the setup options?

[Yes]

[No]

Save as user Defaults

Save the changes done so far as User Defaults?

[Yes]

[No]

Restore user Defaults

Restore the User Defaults to all the setup options?

[Yes]

[No]

Boot Override

Launch EFI Shell from filesystem device

WARNING Not Found

[ok]

# Chapter 4 Installation of Drivers

This chapter describes the installation procedures for software and drivers under the windows 8.1 & 10. The software and drivers are included with the motherboard. The contents include **Intel H170 , Graphics 530 chipset driver, Audio driver, IntelR management engine interface, and DPTF Driver** Installation instructions are given below.

**Important Note:**

After installing your Windows operating system, you must install first the Intel Chipset Software Installation Utility before proceeding with the installation of drivers.

**AEx Series**

**WIN8.1& WIN10 - DRIVER**

**DRIVERS**

- Intel H170 Chipset
- Intel(R) HD Graphics 530 Chipset
- Realtek ALC269 HD Audio Driver
- IntelR Management Engine Interface
- DPTF Driver
- Other Driver

**OTHERS**

- User Manual

View EXIT

## 4.1 Intel H170 Chipset

To install the Intel H170 chipset driver, please follow the steps below.

**Step 1.** Select **Intel H170 Chipset** from the list



**Step 2.** Here is welcome page. Please make sure you save and exit all programs before install. Click **Next**.

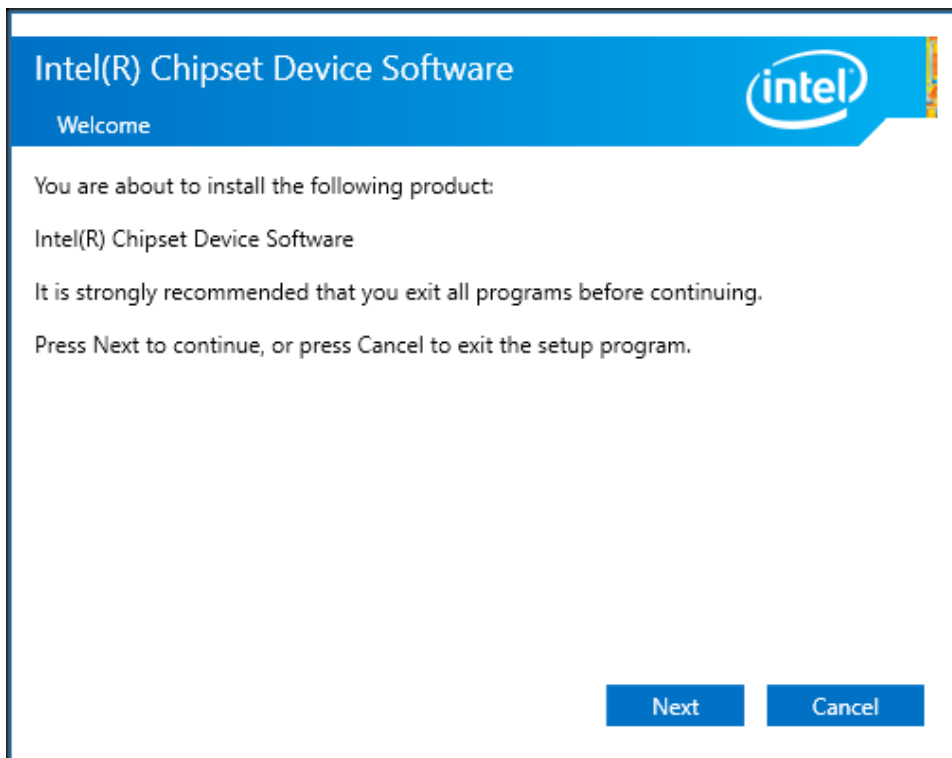

**Step 3.** Read the license agreement. Click **Accept** to accept all of the terms of the license agreement.

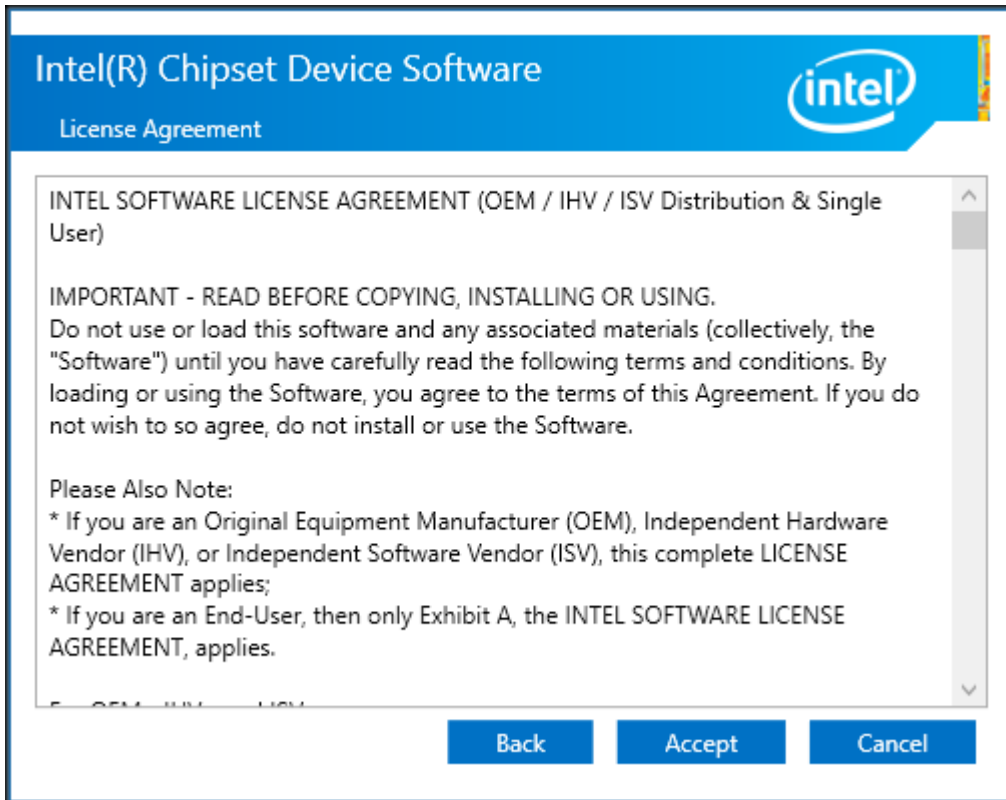

**Step 4.** Click **Install** to begin the installation.

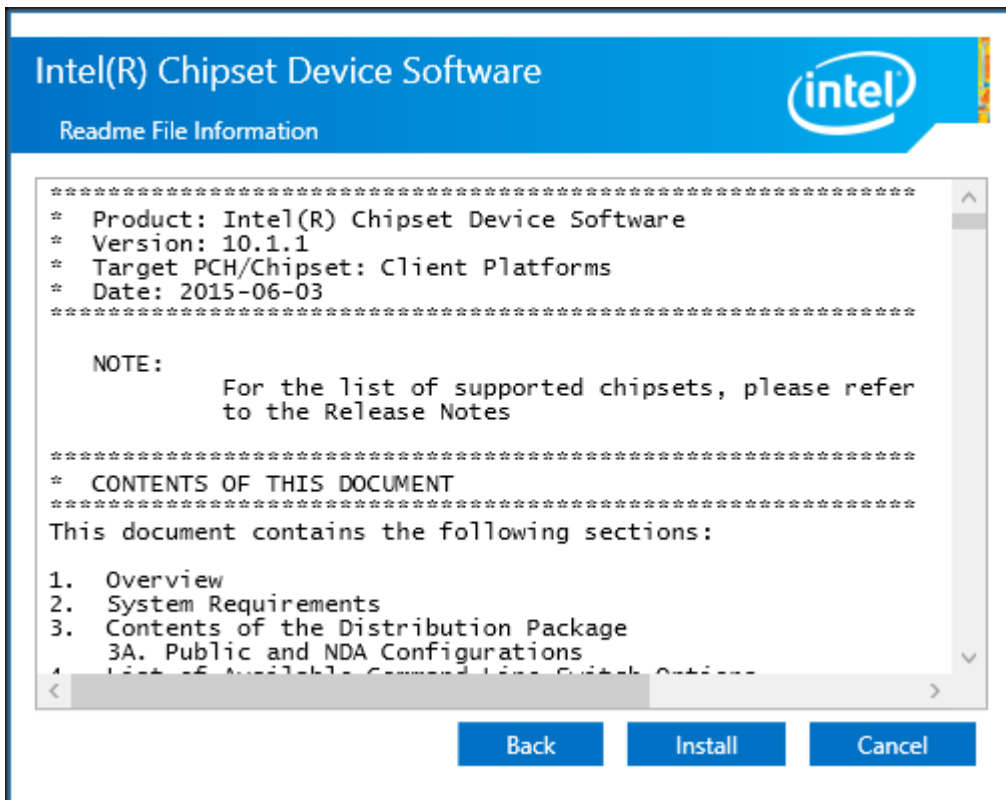

**Step 5.** Select **Restart Now** to reboot your computer for the changes to take effect.

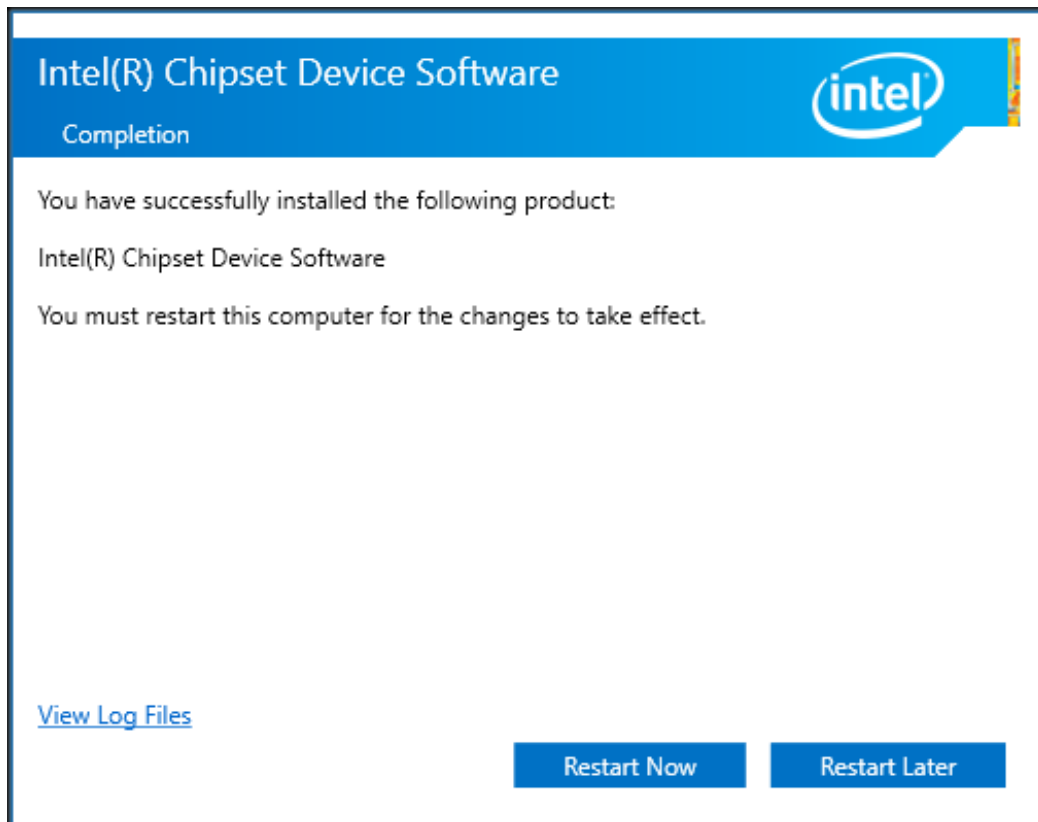

## 4.2 Intel® HD Graphics 530 Chipset

To install the Intel® HD Graphics 530 Chipset, please follow the steps below.

**Step 1.** Select Intel® HD Graphics 530 Chipset from the list.



**Step 2.** . Click Next.

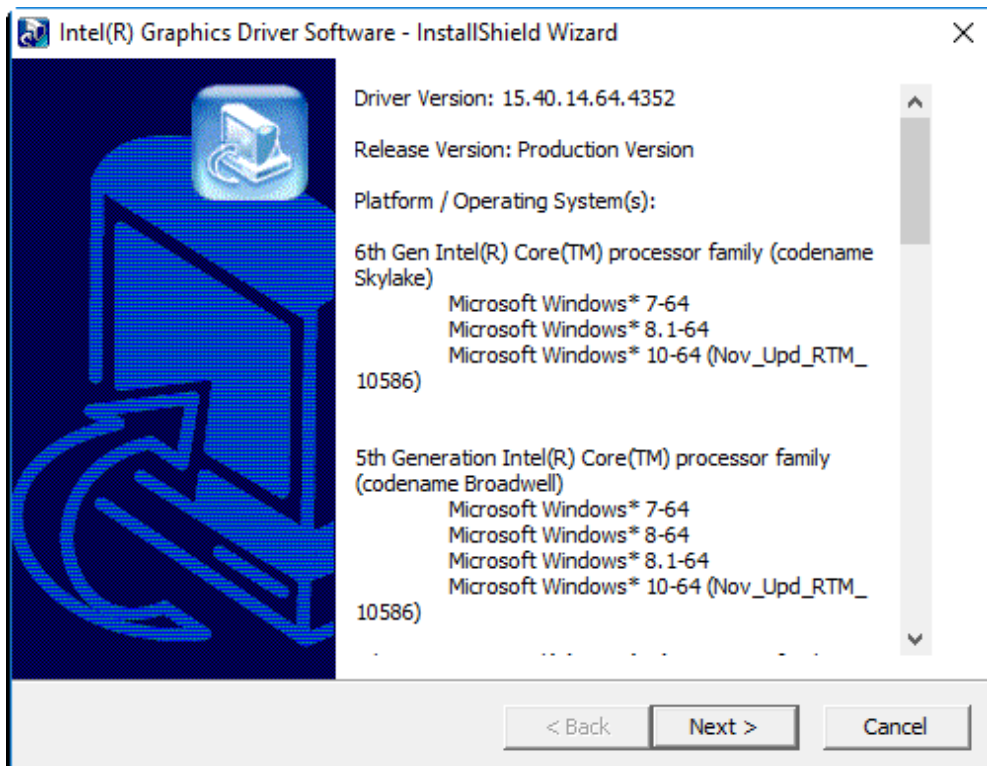

**Step 3.** Choose **automatically run** function and Click **Next** to setup program.

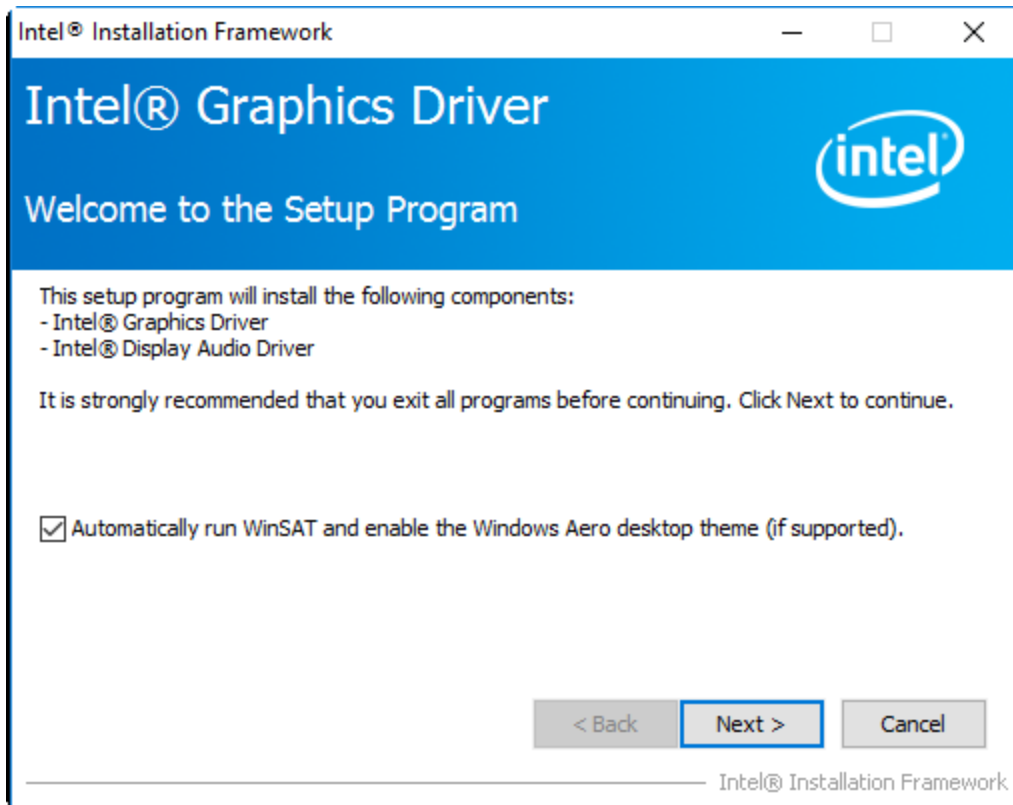

**Step 4.** Read the license agreement. Click **Yes** to accept all of the terms of the license agreement.

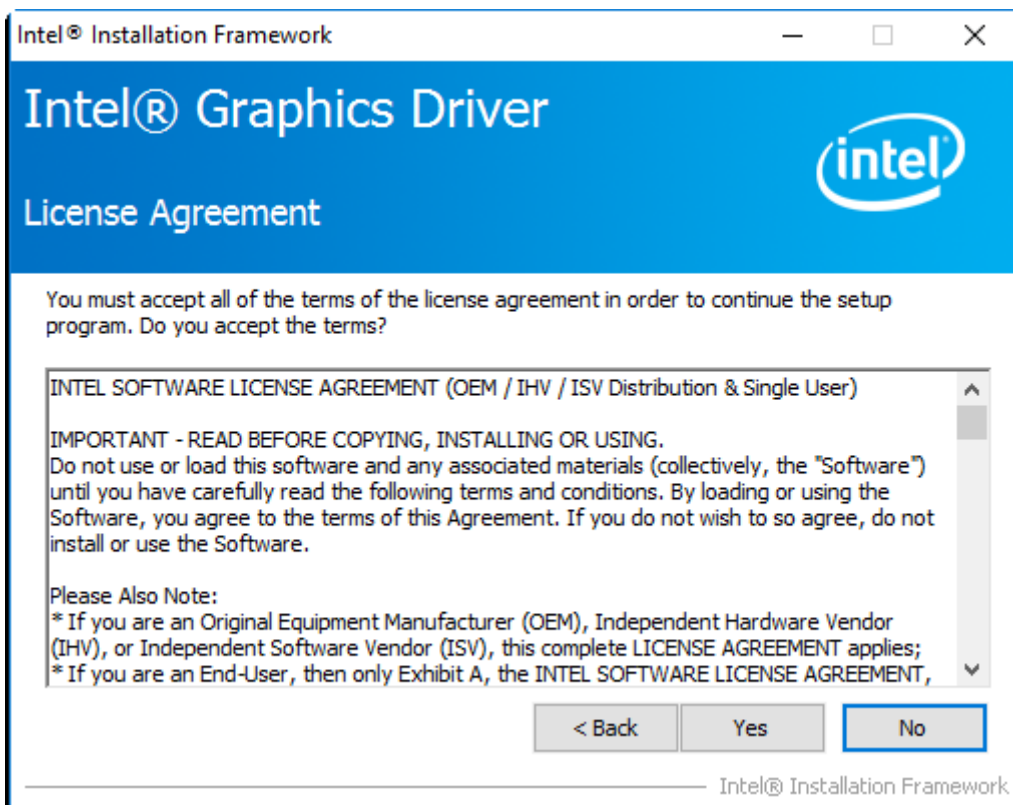



**Step 5.** Click **Next** to continue.

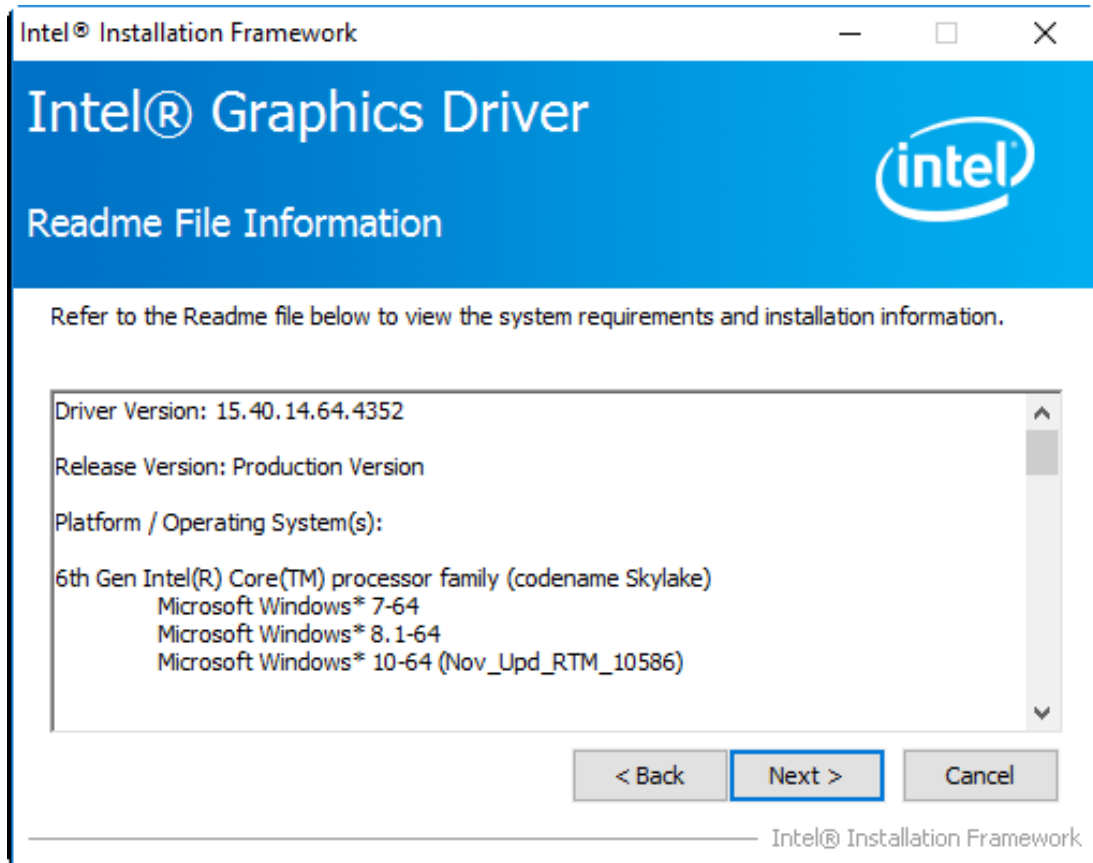

**Step 6.** Here is Intel product improvement program information, you can choose **Accept** or **Decline** by your option and installation will go to next step.

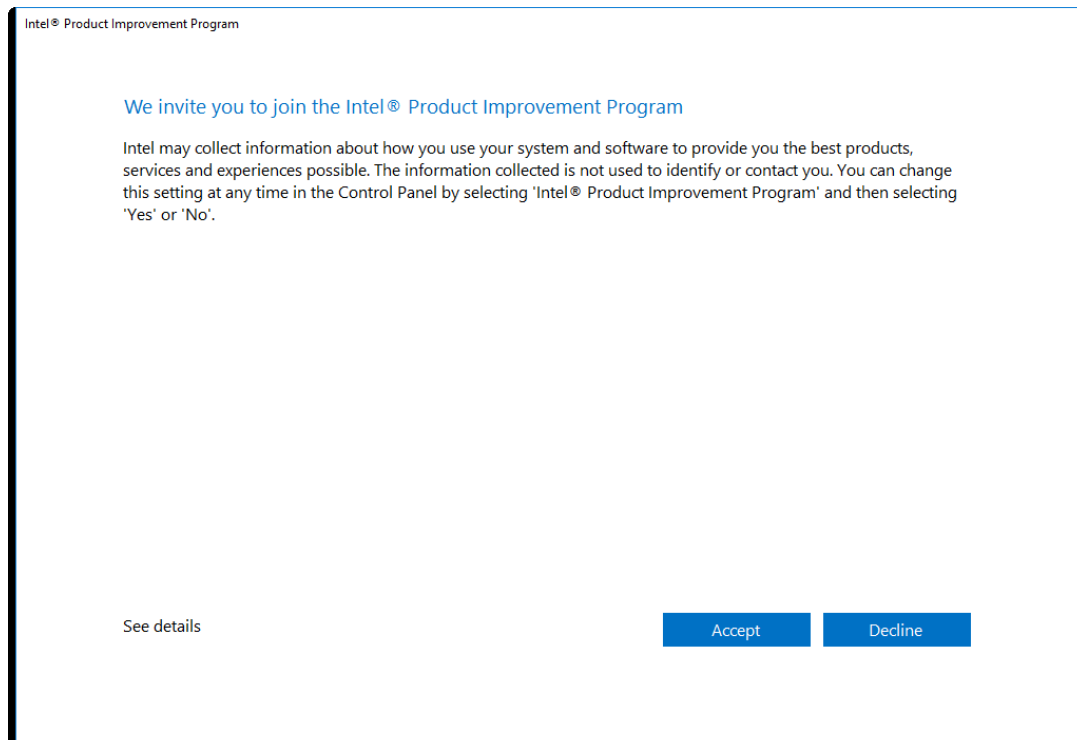

**Step 7.** Click **Next** to continue the program.

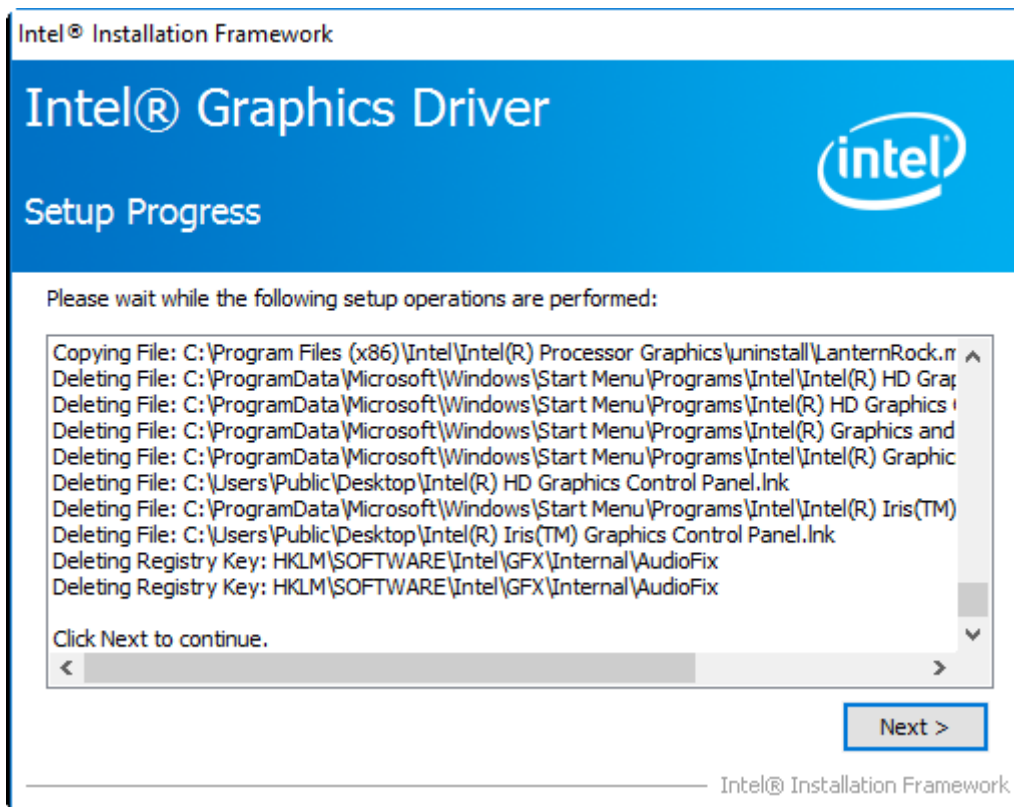

**Step 8.** Select **Yes, I want to restart this computer now**. Click **Finish** to complete installation.

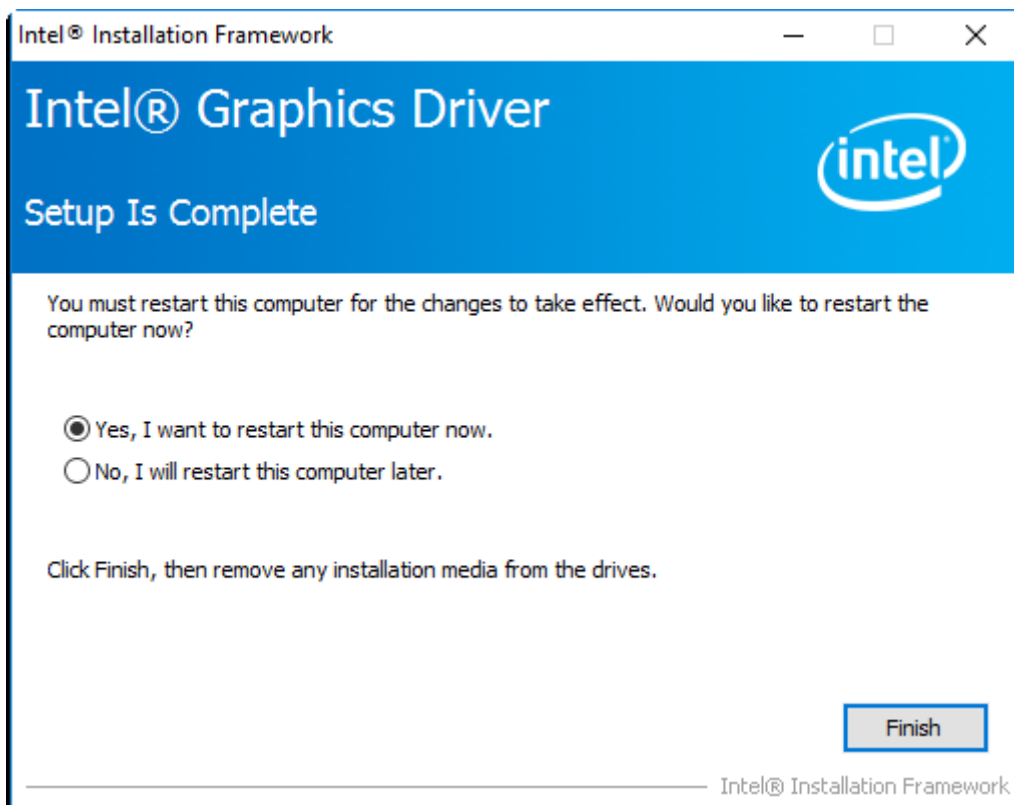

## 4.3 Realtek ALC662 HD Audio Driver Installation

To install the Realtek ALC662 HD Audio Driver, please follow the steps below.

**Step 1.** Select **Realtek AL662 HD Audio Driver** from the list



**Step 2.** Click **Next** to continue.

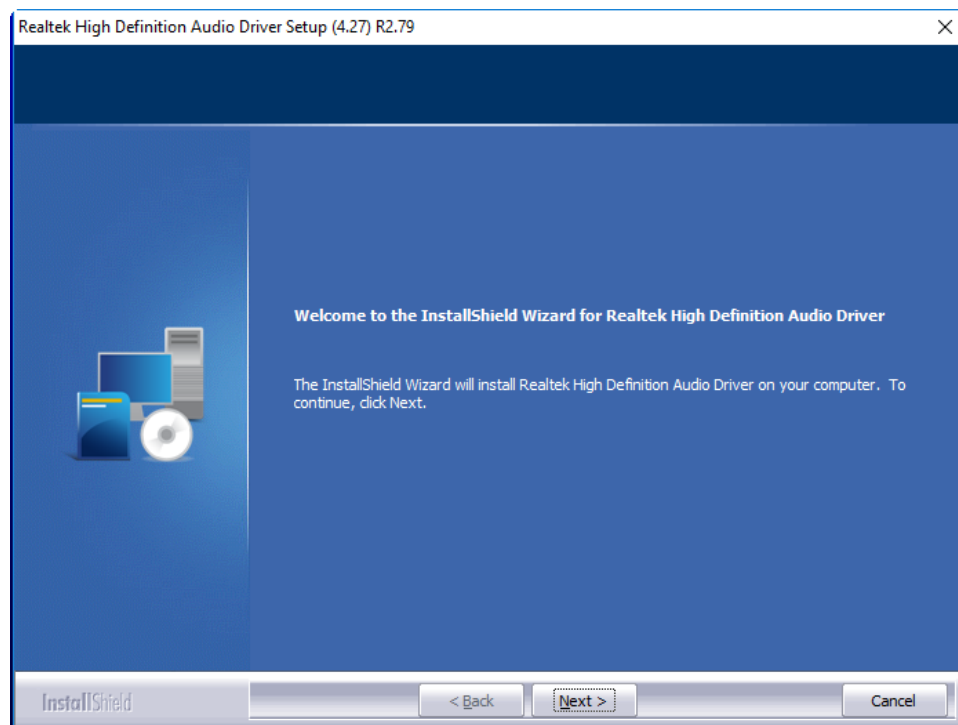

**Step 3.** Click **Yes, I want to restart my computer now.** Click **Finish** to complete the installation.

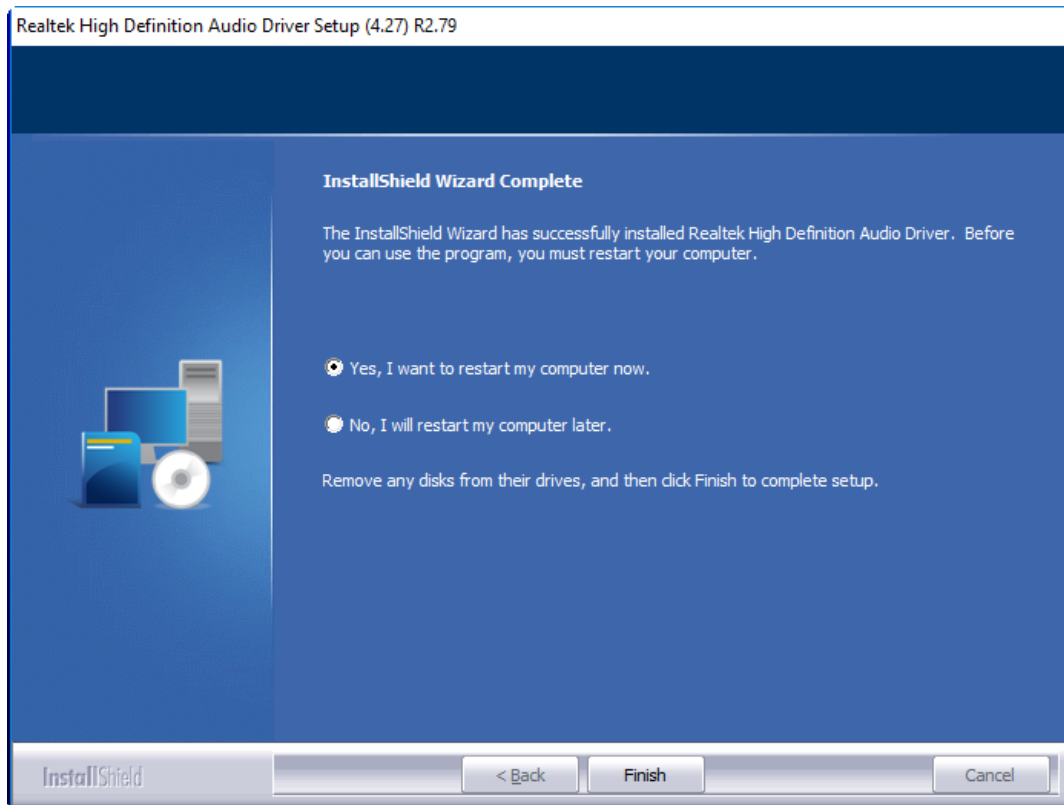

## 4.4 Intel® Management Engine Interface

To install the Intel® Management Engine Interface, please follow the steps below.

**Step 1.** Select **Intel® Management Engine Interface** from the list



**Step 2.** Select setup language you need. Click **Next** to continue.

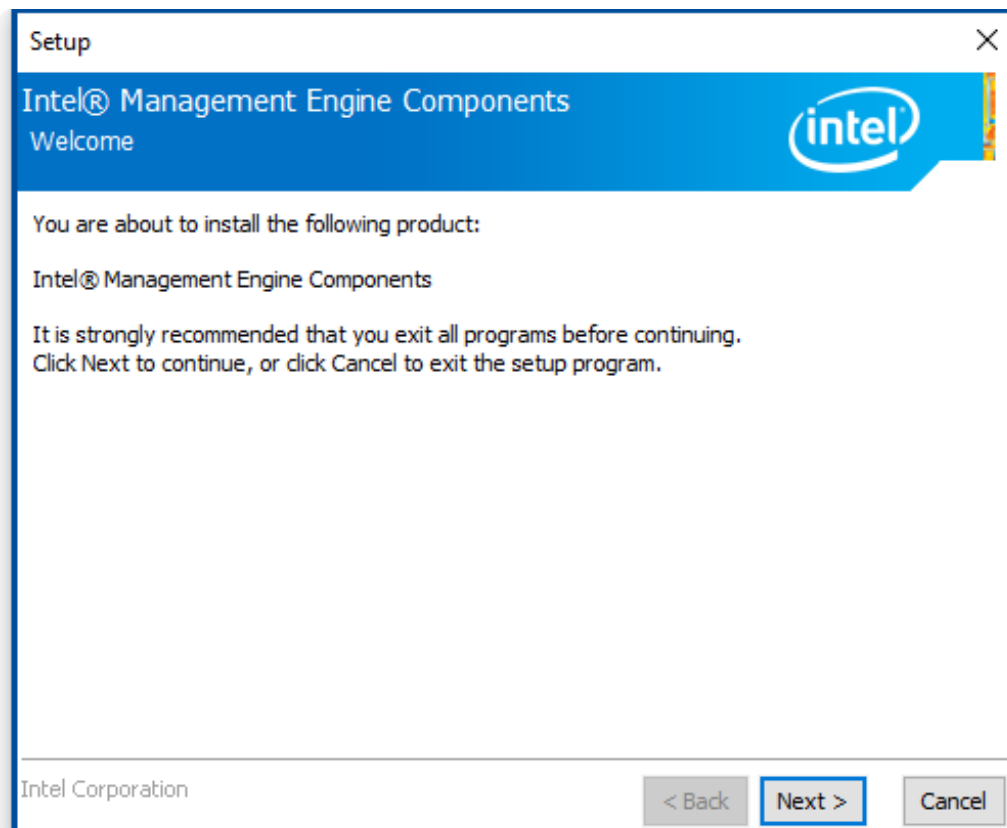

**Step 3.** Choose **I accept the terms in the License Agreement** and click **Next** to begin the installation.

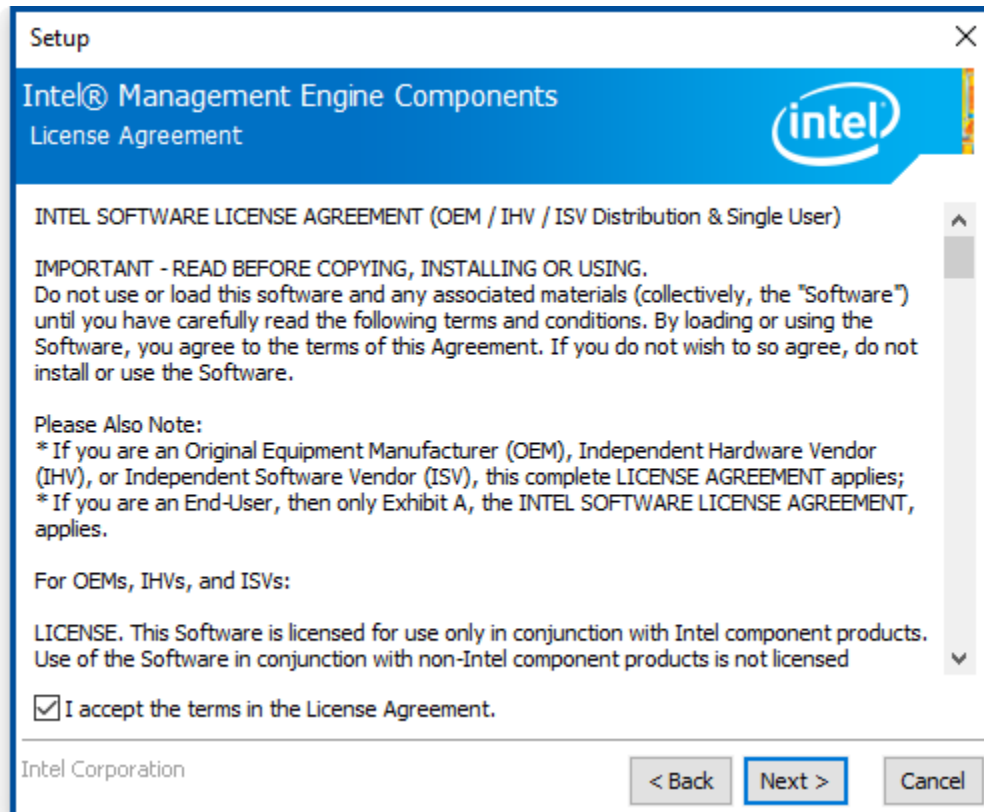

**Step 4.** Click **Next** to continue.

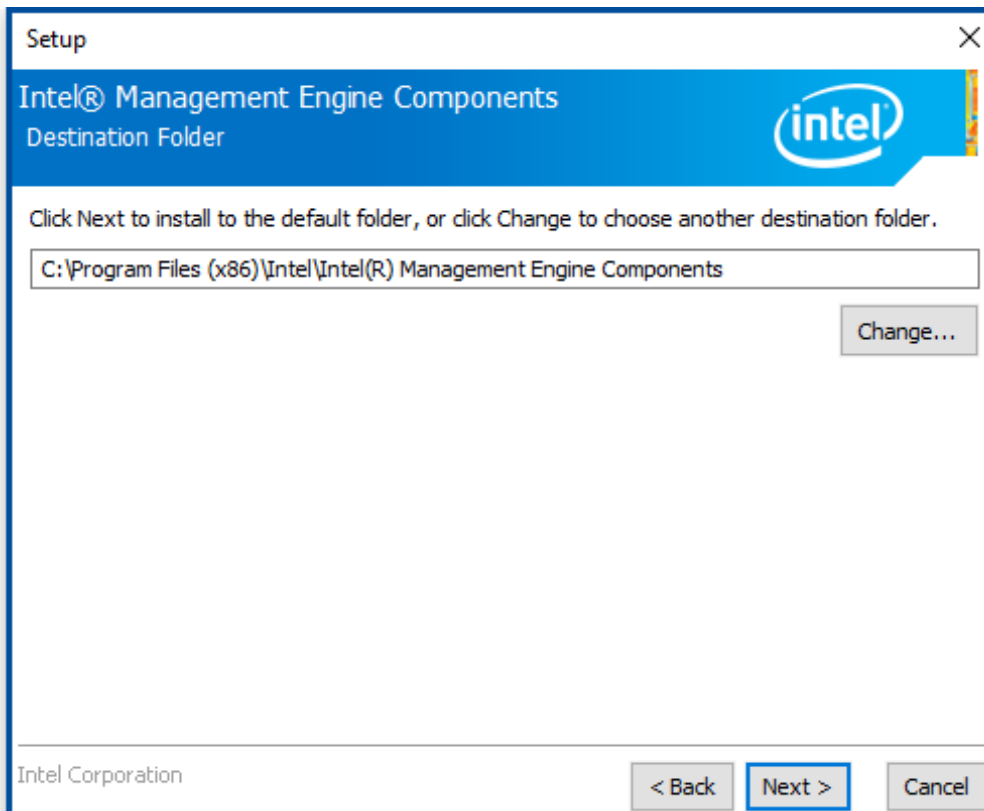

**Step 5.** Click **Finish** to complete the installation.

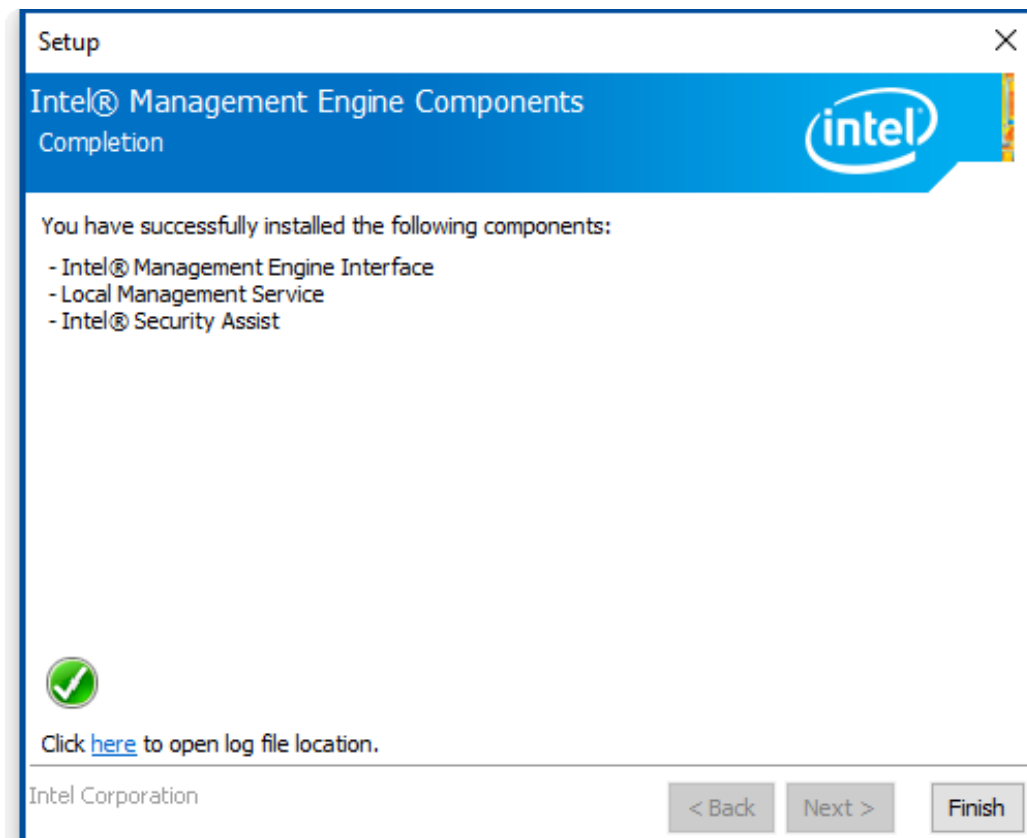

## 4.5 DPTF Driver

To install the DPTF Driver, please follow the steps below.

**Step 1.** Select **DPTF Driver** from the list



**Step 2.** Click **Next** to continue.

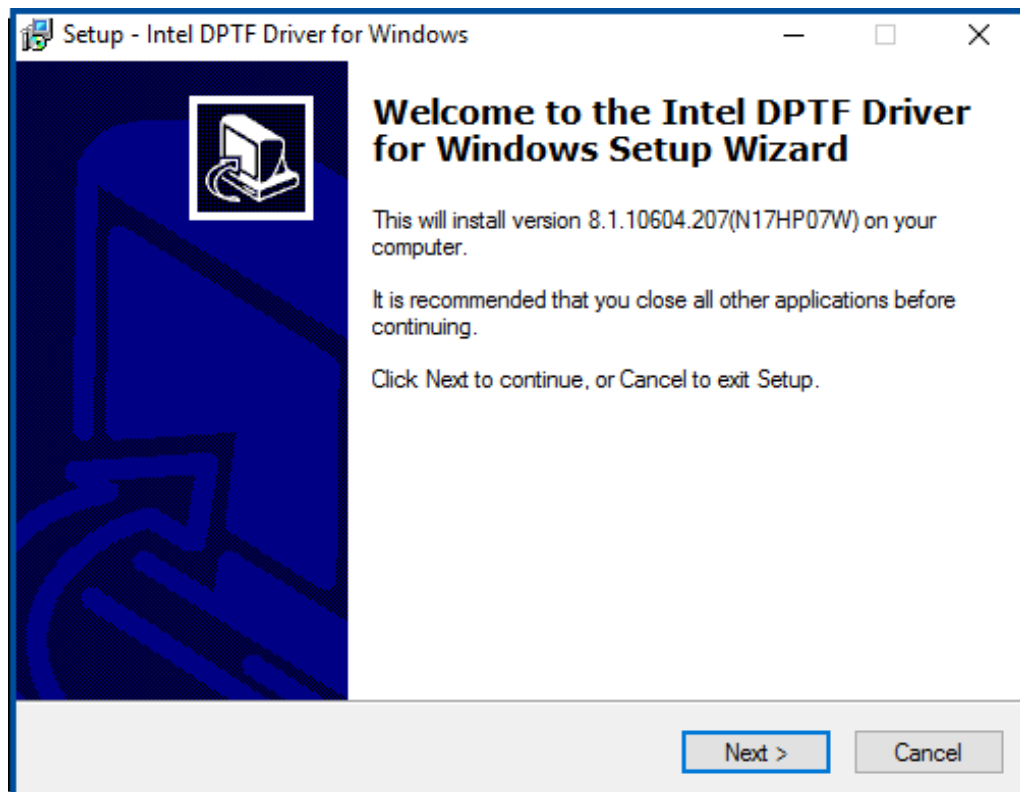



**Step 3.** Read the license agreement. Choose **Accept** and click **Next** to accept all of the terms of the license agreement.

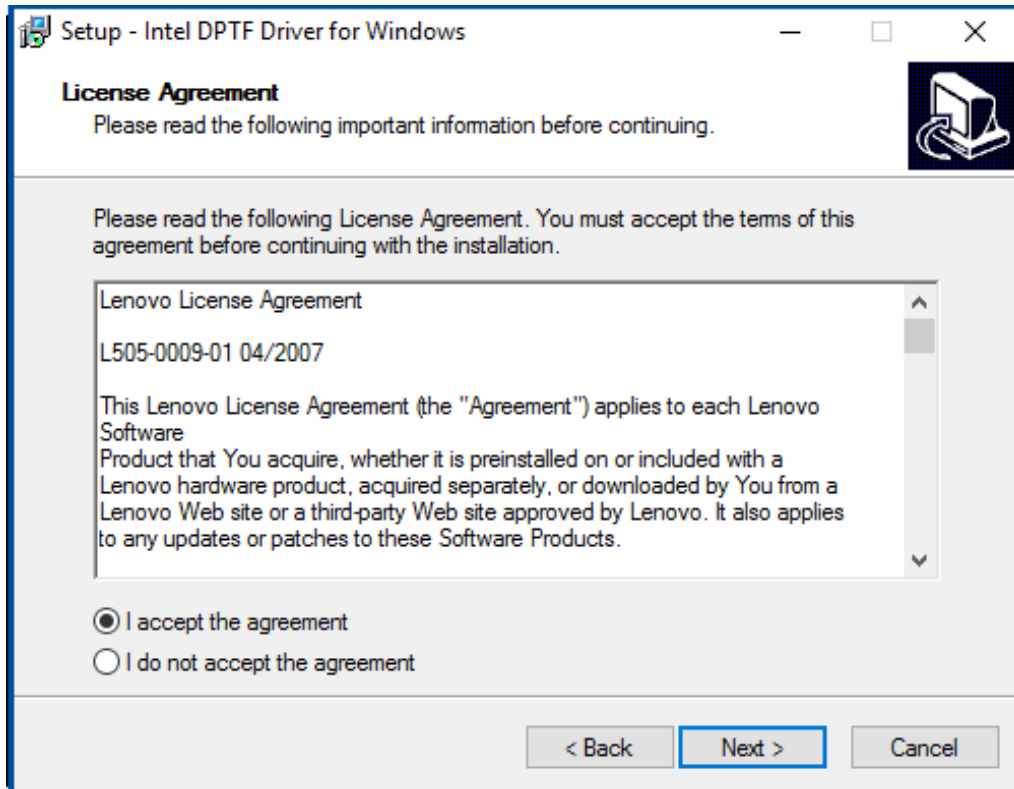

**Step 4.** Select destination location by your option and click **Next** to continue.

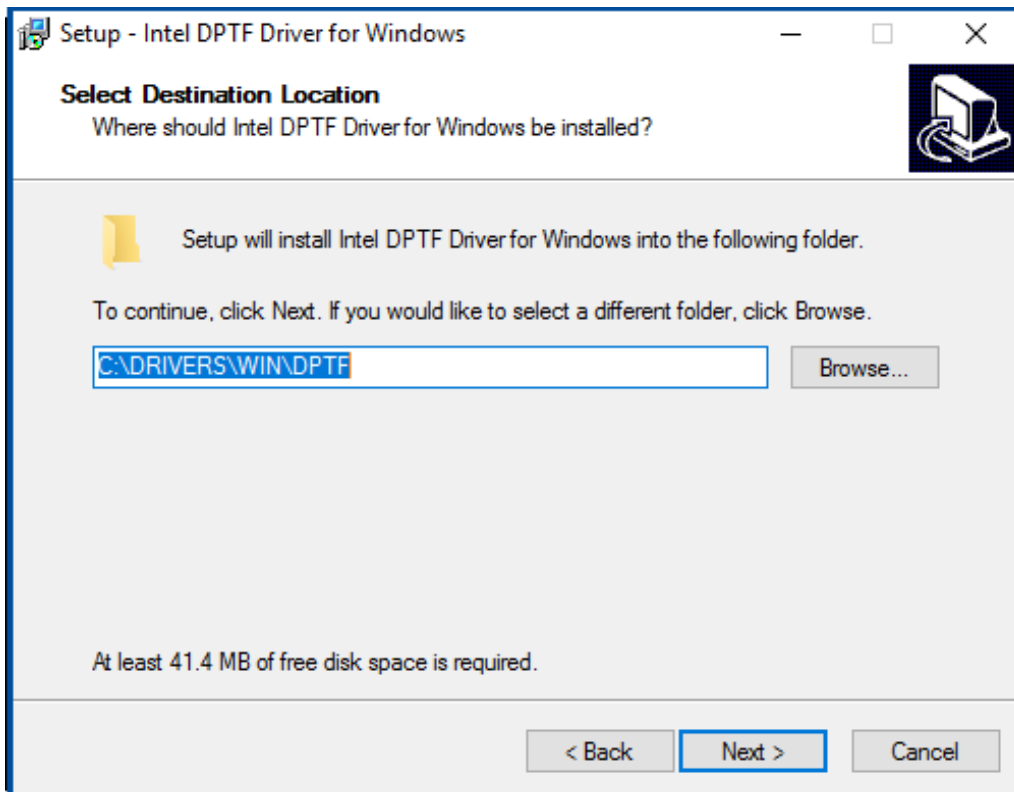

**Step 5.** Click **Install** to continue the installing.

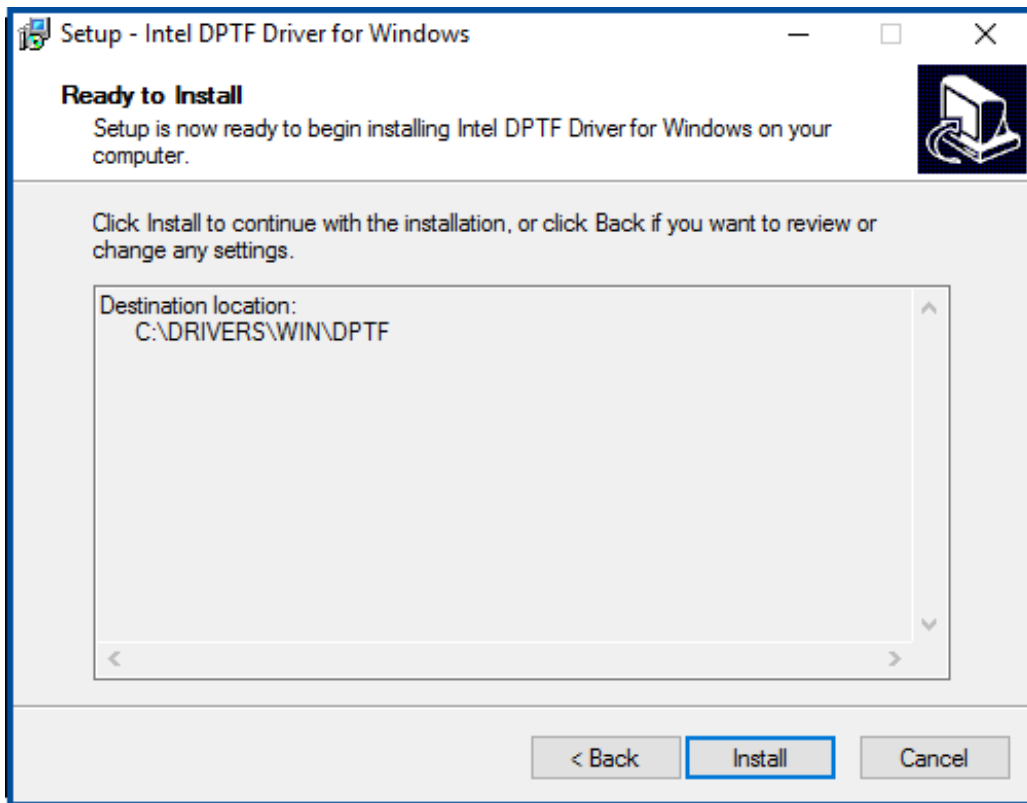

**Step 6.** Click **Finish** to complete the installation and start install Intel DPTF driver for Windows.

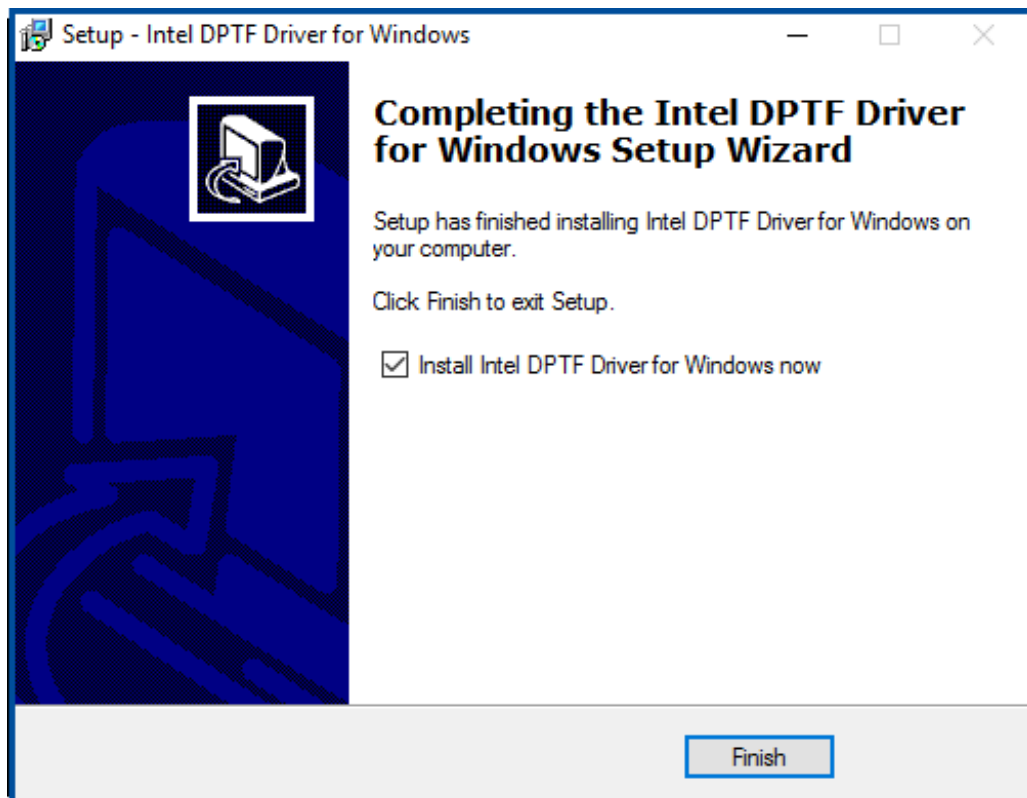

**Step 7.** Click **Next** to start the installation.

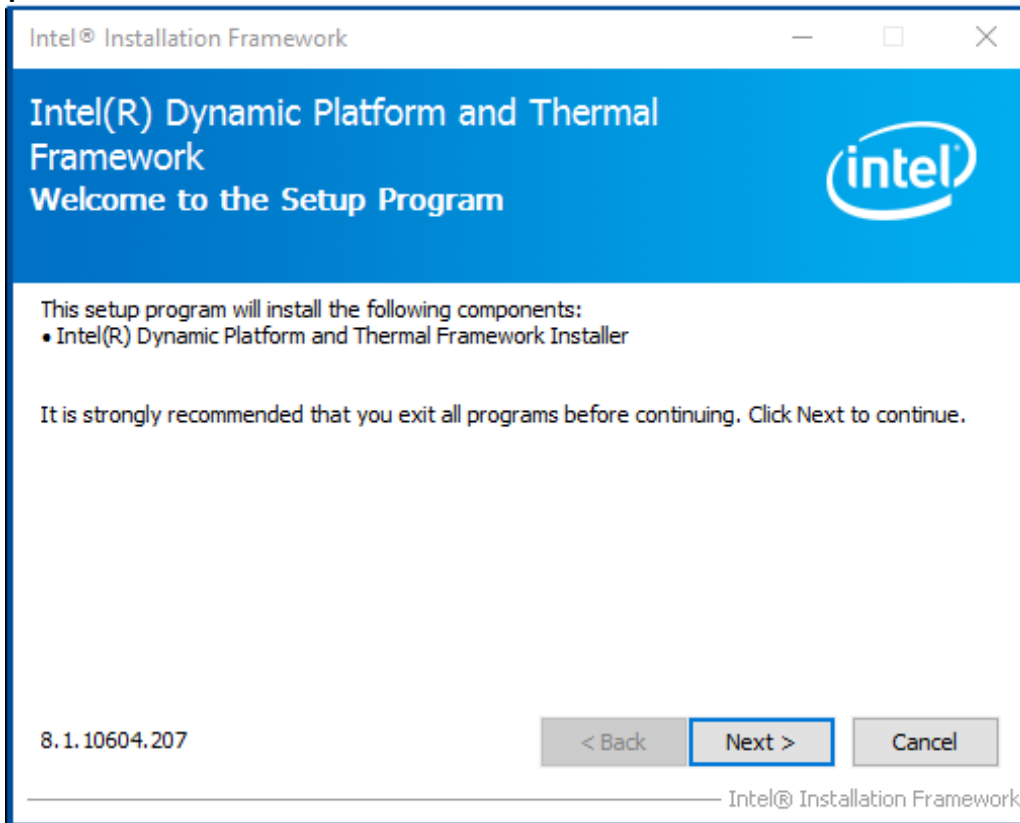

**Step 8.** Read the license agreement. Click **Yes** to accept all of the terms of the license agreement.

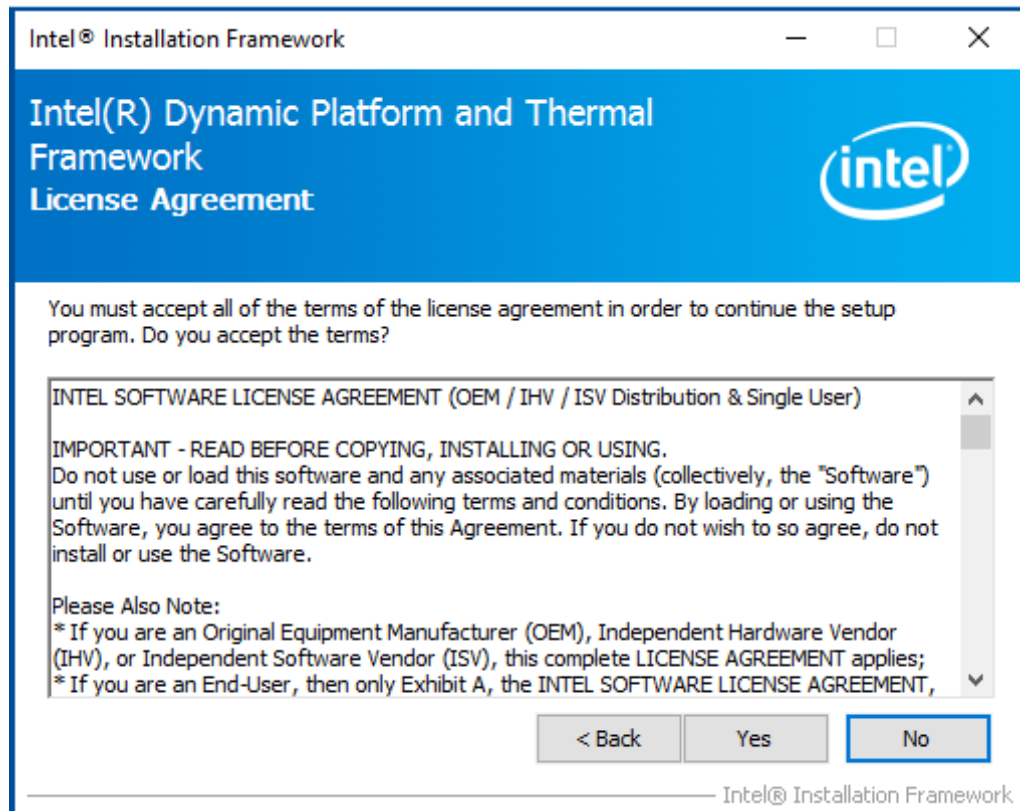

**Step 9.** Click **Next** to continues.

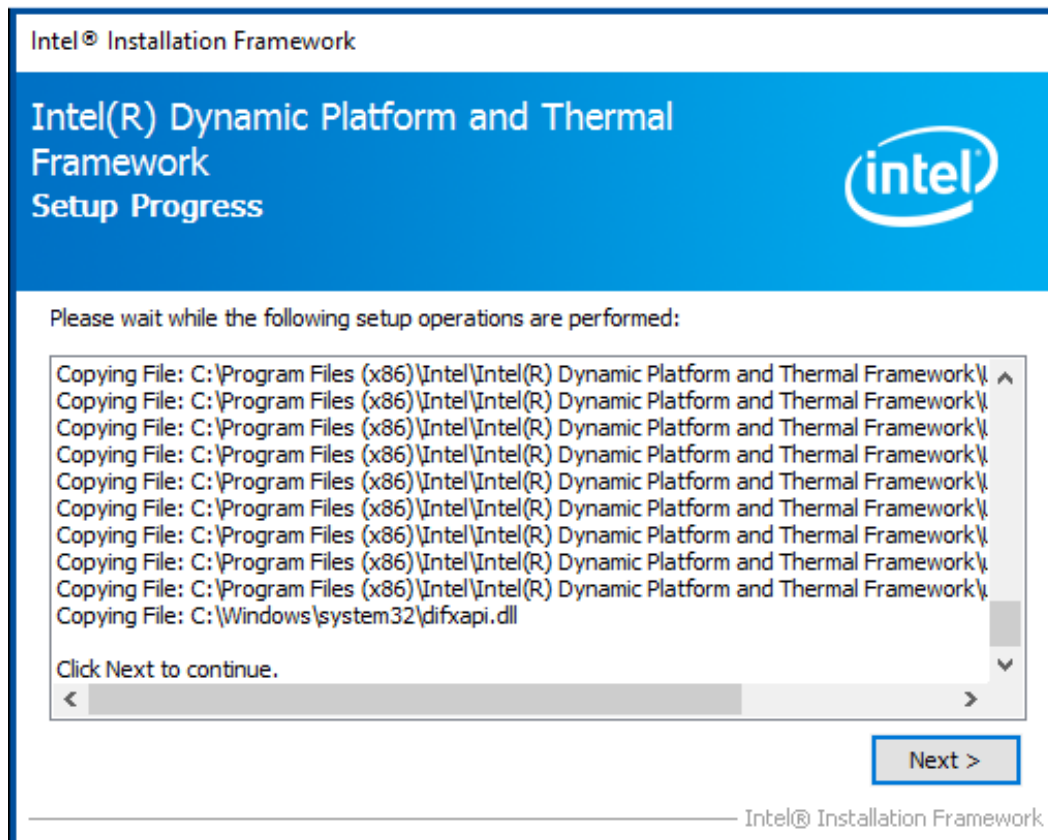

**Step 10.** Click **Finish** to complete the installation.

