

# MI808

Mini-ITX Motherboard

# USER'S MANUAL

Version 1.1

---

## **Acknowledgments**

AMI is a registered trademark of American Megatrends Inc.  
PS/2 is a trademark of International Business Machines Corporation.

Microsoft Windows is a registered trademark of Microsoft Corporation.

Winbond is a registered trademark of Winbond Electronics Corporation.

All other product names or trademarks are properties of their respective owners.

---

# Table of Contents

<b>Introduction</b> .....	<b>1</b>
Product Description.....	1
Checklist.....	2
MI808 Specifications .....	3
Board Dimensions .....	6
<b>Installations</b> .....	<b>7</b>
Installing the Memory.....	8
Setting the Jumpers.....	9
Connectors on MI808.....	16
<b>BIOS Setup</b> .....	<b>32</b>
<b>Drivers Installation</b> .....	<b>48</b>
Intel Chipset Software Installation Utility.....	49
VGA Drivers Installation.....	52
Realtek HD Audio Driver Installation .....	54
LAN Drivers Installation .....	55
TXE Drivers Installation.....	58
<b>Appendix</b> .....	<b>60</b>
A. I/O Port Address Map.....	60
B. Interrupt Request Lines (IRQ).....	61
C. Watchdog Timer Configuration .....	62

---

This page is intentionally left blank.

# Introduction

## Product Description

---

---

MI808 is a Mini ITX board (170mm x 170mm) that comes with the Intel Intel® Pentium® N3000 series processor. It has two DDR3L SO-DIMM sockets supporting up to 8GB of system memory.

It also features the Intel® Gen8-LP graphics engine with interface for CRT, DVI-D and 24-bit dual channel LVDS displays.

The platform provides four USB 3.0 connector at the board edge and USB 2.0 two ports with pin header. Two SATA III ports are included.

### MI808 FEATURES

- Mini ITX form factor, 170mm x 170mm
- Onboard Intel® Pentium® N3000 series
- Two DDR3L SO-DIMM sockets, DDR3L-1600, Max. 8GB
- Intel® Gen8-LP graphics for CRT, DVI-D interface
- 24-bit dual channel LVDS interface
- Dual Intel I211-AT PCIe Gigabit LAN
- 4x USB 3.0 on edge, 2xUSB 2.0 support
- Two SATA III, 4x COM ports
- Digital I/O 4-in / 4-out, PCIe (1x) slot, 2x Mini-PCIe
- Watchdog Timer, iSMART, RoHS compliance

## **Checklist**

---

---

Your MI808 package should include the items listed below.

- The MI808 Mini-ITX motherboard
- This User's Manual
- 1 CD containing chipset drivers and flash memory utility
- Serial ATA cable
- I/O shield

## MI808 Specifications

<b>Product Name</b>	MI808F-370 (N3700 onboard, DC-in 12V only) <b>MI808F-371 (N3710 onboard, DC-in 12V only)</b> MI808FW-370 (N3700 onboard DC-in 18V~24V, wider range) <b>MI808FW-371 (N3700 onboard DC-in 18V~24V, wider range)</b> MI808F-300(N3000 onboard DC-in 12V only) <b>MI808F-301(N3010 onboard DC-in 12V only)</b> MI808FW-300 (N3000 onboard DC-in 18V~24V, wider range) <b>MI808FW-301 (N3010 onboard DC-in 18V~24V, wider range)</b> MI808FW-370A (N3700 onboard DC-in 18V~24V, w/o TPM/CFast) <b>MI808FW-371A (N3710 onboard DC-in 18V~24V, w/o TPM/CFast)</b> [Default silk screen model # on PCB is MI808F]
<b>Form Factor</b>	Mini-ITX
<b>SoC Type/Speed</b>	14nm Lithography, FCBGA1170, Package= 25mm x 27mm - Pentium® N3700 QC, up to 2.4Ghz , TDP=6W - Pentium® N3710 QC, up to 2.56Ghz , TDP=6W - Celeron® N3000 DC, up to 2.08GHz, TDP=4W - Celeron® N3010 DC, up to 2.24GHz, TDP=4W
<b>BIOS</b>	AMI BIOS
<b>Memory</b>	2 xDDR3L SO-DIMM socket [Horizontal type] Maximum to DDR3L-1600@8GB (Non-ECC, Unbuffered, 1.35V)
<b>Display</b>	Intel® Pentium® SoC integrated Gen 8-LP graphics core Supports DX11.1 & OpenGL 4.2, 3 x independent displays - VGA x 1(Thru NXP PTN3392) **Supports up to1920x1200 @ 60Hz - LVDS: 24-bit dual channel via NXP PTN3460 thru eDP **Supports up to1920x1200 @ 60Hz** - DVI-D x1 **Supports up to 3840x2160 @ 60 Hz**
<b>LAN</b>	Intel I211-AT PCIe Gigabit LAN x 2
<b>USB</b>	Intel® Pentium® SoC built-in USB 3.0 host controller, supports 4 ports, Edge I/O x 4 Intel® Braswell SoC built-in USB 2.0 host controller with USB hub Renesas uPD720115K8-611-BAK-A(C013720115K861000P) For total 4 ports x USB 2.0 - 2 ports thru pin header - 2 ports thru Mini PCIe slot
<b>Serial ATA Ports</b>	Intel® Pentium® SoC built-in SATA III controller, supports 2 ports - 2 x SATAIII connector - MSATA (thru Mini PCIe) via switch - CFast (Optional) via switch
<b>Audio</b>	Realtek ALC269QHD-VC3 with class-D speaker amplifier (2W per channel) , Support 2-channel audio out + AMP
<b>LPC I/O</b>	Fintek F81846AD-I [128-pin LQFP, 14x14x1.4mm] COM #1 (RS232/422/485) supports ring-in with power @500mA (selectable for 5V or 12V) - [SP339EER1 232/422/485 transceiver x 1 for jumper-less] - COM #2 (RS232 only), support ring-in with power @500mA (selectable for 5V or 12V), with SP3243EBER - COM #3~COM #4 (RS232 only) with SP3243EBER [Hardware Monitor] 2 x Thermal inputs; 2 x Voltage monitoring 1 x 4-pin for CPU fan (PWM), 1 x 3-pin for SYS fan (DC mode)
<b>Digital IO</b>	4-in / 4-out (User configurable)
<b>Expansion Slots</b>	PCIe (1x) slot x 1 Full-sized Mini-PCIe x 2 [Mounting holes for full-sized (x2) + half-sized (x1)] Mini-PCIe #1 supports PCIe(1x) / USB signal Mini-PCIe #2 supports mSATA / USB signal

*INTRODUCTION*

	CFast x1 @ solder side [Except MI808FW-370A]
--	--



<b>Edge Connector</b>	PS/2 Keyboard + PS/2 mouse stack connector x 1 Dual DB9 Stack connector x1 for COM#1 / COM#2 VGA+ DVI-D stack connector x 1 for CRT + DVI-D RJ45+Dual USB 3.0 stack connector x 2 Audio 3-port connector x 1 (Line-out, Line-in, MIC)
<b>Onboard Header/Connector</b>	DF11-8 pin connector x 1 for USB (2.0) x 2 ports 2x6 pin header x 1 for front audio (2.54 pitch type) 2x13 pin box header x 1 for LPT DF11-10 pin box header x 4 for COM #3--# 6 DF20 socket connector x 2 for 24-bit dual channel LVDS 4 pins box header x1 for LCD backlight control SATA connector x 2 for SATA III device (Blue color) 4-pin power connector x 2 for SATA device 2x5 pin header x 1 for Digital I/O (2.54 pitch type) 4-pin header for speaker out (from ALC269 internal amplifier) 2x4 pin header x 1 for front I/O panel (2.54 pitch type) 2 x 2 pin connector x 1 for power-in SIM slot x 1 (Location under #1 MiniPCle)
<b>Watchdog Timer</b>	Yes (256 segments, 0, 1, 2...255 sec/min)
<b>Power Connector</b>	+12V only ( $\pm 5\%$ tolerance) or 18V~+24V
<b>Others</b>	<ol style="list-style-type: none"> <li>1. iSMART 3.2</li> <li>2. TPM 2.0 (Infineon SLB9665) [Except M1808FW-370A]</li> <li>3. Heatsink for fanless solution</li> </ol>
<b>OS supporting</b>	<ul style="list-style-type: none"> <li>- Windows 8.1 (64-bit)</li> <li>- Window Embedded 8</li> <li>- Windows 7 (64-bit)</li> <li>- Linux (Fedora, uBuntu)</li> </ul>
<b>RoHS</b>	Yes
<b>Certification</b>	CE /FCC/LVD
<b>Environment</b>	Operation Temperature: 0~60 degree C Storage Temperature: -40 ~ 80 degree C Relative humidity: 90%, non-condensing @ 60 degree C
<b>Board Size</b>	170mm x 170mm

# Board Dimensions

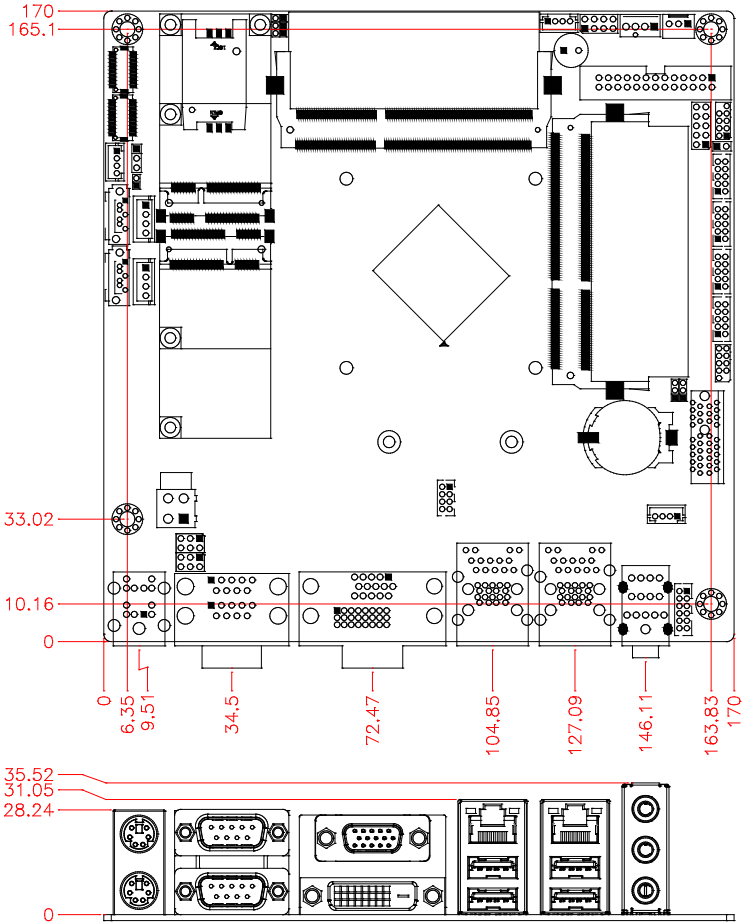

## Installations

This section provides information on how to use the jumpers and connectors on the MI808 in order to set up a workable system. The topics covered are:

Installing the Memory .....	8
Setting the Jumpers.....	9
Connectors on MI808 .....	16

## Installing the Memory

---

---

The MI808 board supports two DDR3L-1600 memory slots.

### Remarks:

MI808 supports two SO-DIMM (w/o ECC) modules. Total maximum memory supported is 8GB.

### Installing and Removing Memory Modules

To install the DDR3L modules, locate the memory slot on the board and perform the following steps:

1. Hold the DDR3L module so that the key of the DDR3L module aligned with that on the memory slot.
2. Gently push the DDR3L module in an upright position until the clips of the slot close to hold the DDR3L module in place when the DDR3L module touches the bottom of the slot.

To remove the DDR3L module, press the clips with both hands.

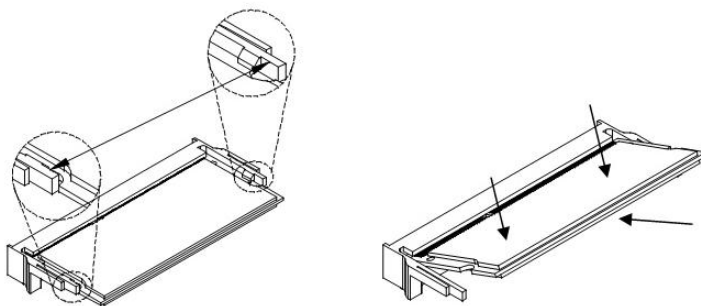

## Setting the Jumpers

---



---

Jumpers are used on MI808 to select various settings and features according to your needs and applications. Contact your supplier if you have doubts about the best configuration for your needs. The following lists the connectors on MI808 and their respective functions.

Jumper Locations on MI808 .....	10
JP1: LCD Backlight Connector .....	11
JP2: LVDS Panel Brightness Control Selection .....	11
JP3/JP4 COM1/COM2 RS232 RI/+5V/+12V Power Setting.....	12
JP8: Clear CMOS Contents.....	13
JP7: Clear ME Contents.....	14
JP9: For SPI Debug Tools .....	14
J22: ATX/AT Mode .....	15

Jumper Locations on MI808

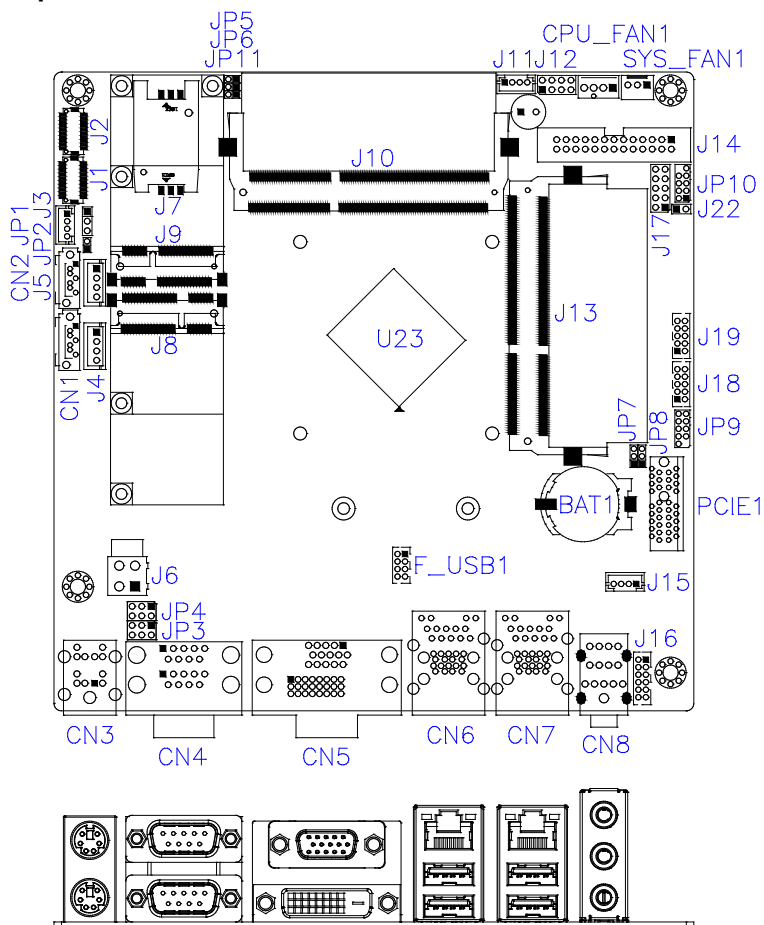

Jumpers on MI808.....	Page
JP1: LCD Backlight Connector.....	11
JP2: LVDS Panel Brightness Control Selection.....	11
JP3/JP4 COM1/COM2 RS232 RI/+5V/+12V Power Setting .....	12
JP8: Clear CMOS Contents .....	13
JP7: Clear ME Contents .....	14
JP9: For SPI Debug Tools .....	14
J22: ATX/AT Mode .....	15

**JP1: LCD Backlight Connector**

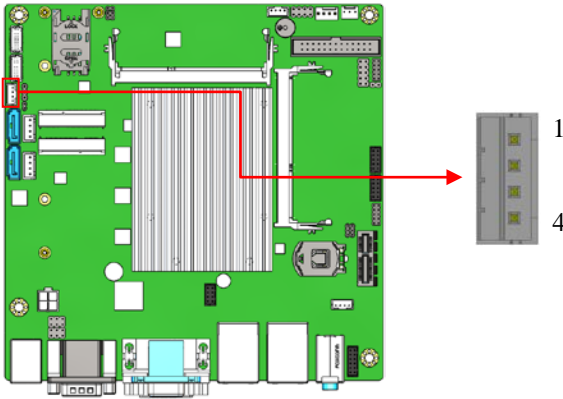

Pin #	Signal Name
1	+12V
2	Backlight Enable
3	Brightness Control
4	Ground

**JP2: LVDS Panel Brightness Control Selection**

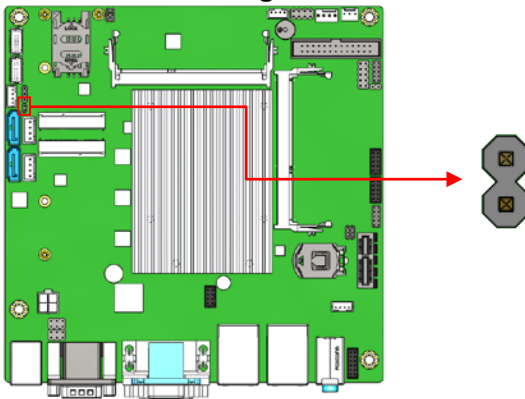

Setting	Brightness Control (PWM mode)
Open	3.3V
Close	5V(Default)

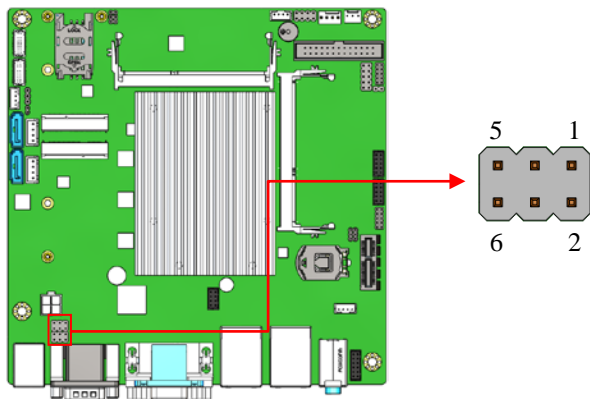

**JP3/JP4 COM1/COM2 RS232 RI/+5V/+12V Power Setting**



JP3/JP4	Setting	Function
	Pin 1-3 Short/Closed	+12V
	Pin 3-4 Short/Closed	RI
	Pin 3-5 Short/Closed	+5V

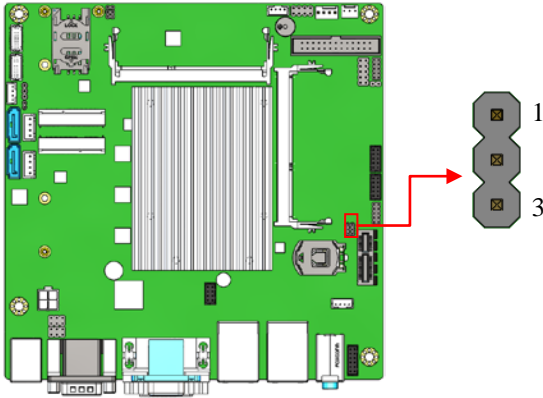

**JP8: Clear CMOS Contents**

JP8	Setting	Function
 1 2 3	Pin 1-2 Short/Closed	Normal
 1 2 3	Pin 2-3 Short/Closed	Clear CMOS

**JP7: Clear ME Contents**

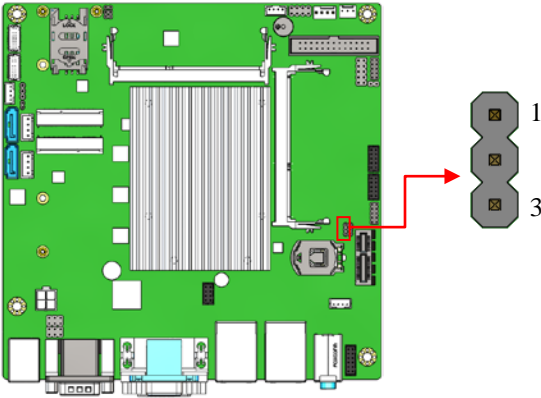

JP7	Setting	Function
	Pin 1-2 Short/Closed	Normal
	Pin 2-3 Short/Closed	Clear ME REGISTER

**JP9: For SPI Debug Tools**

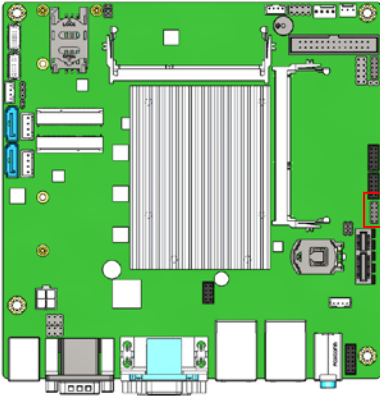

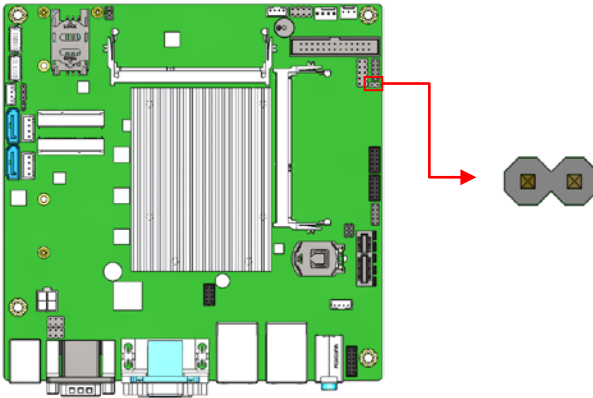
**J22: ATX/AT Mode**

Setting	Function
Open	ATX (Default)
Close	AT

## Connectors on MI808

---

Connector Locations on MI808 .....	17
CN1 / CN2: SATA3 Connectors.....	18
CN2 Share with CN9.....	18
CN3: PS2 Keyboard/Mouse.....	18
CN4: COM1 / COM2 .....	18
CN5: CRT+DVI Connector.....	19
CN6/CN7: Gigabit LAN / USB 3.0 Connector.....	19
CN8: Audio Connector.....	19
CN9: CFAST Connector .....	20
J1, J2: LVDS Connectors, Hirose DF20G-20DP-1V.....	20
J2: First Channel LVDS.....	21
J3: LVDS Panel Power Selection.....	21
J4 / J5: SATA HDD Power Connectors .....	22
J6: DC_IN Connector.....	22
J8 / J9: Mini PCIE Slot (SIM Card).....	23
J8 mSATA only (Share with CN1, W/O USB).....	23
F_USB1: USB 2.0.....	23
J10: DDR3L SO-DIMM (CH-A) Sockets.....	24
J13: DDR3L SO-DIMM (CH-B) Sockets.....	24
J11: MCU JTAG .....	25
J12: Front Panel.....	25
J15 Amplifier Connector.....	26
J16 Audio Connector (DF11-12DP-2DSA).....	27
J17: Digital I/O.....	28
J18, J19: COM3/COM4.....	29
CPU_FAN1: CPU Fan Power Connector.....	30
SYS_FAN1: System Fan1 Power Connector.....	30
J7: SIM Card Slot.....	31
JP5/JP6: Reserved .....	31
J14: LPT Port Connector.....	31

Connector Locations on MI808

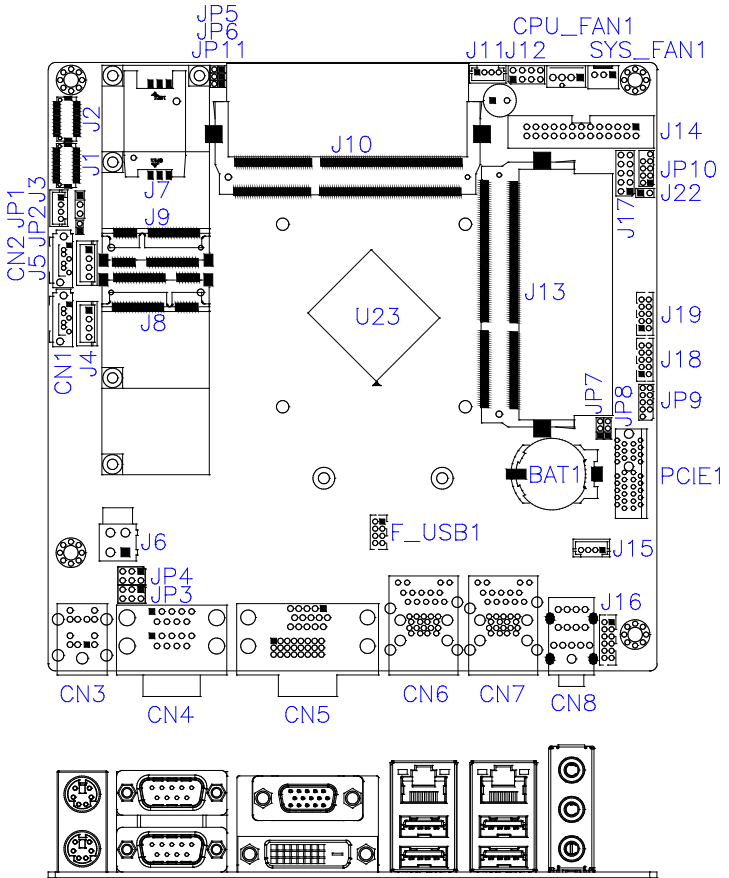

Connector Locations on MI808

**CN1 / CN2: SATA3 Connectors**

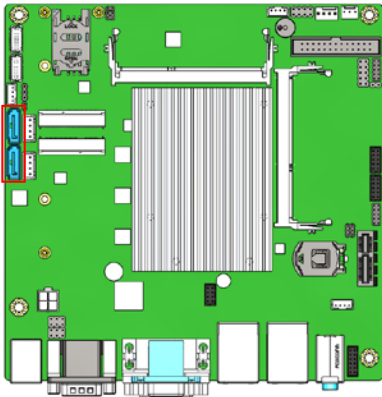

**CN2 Share with CN9 (CFAST)**

**CN3: PS2 Keyboard/Mouse**

**CN4: COM1 / COM2**

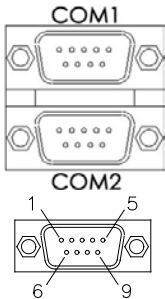

Pin #	Signal Name		
	RS-232	R2-422	RS-485
1	DCD	TX-	DATA-
2	RX	TX+	DATA+
3	TX	RX+	NC
4	DTR	RX-	NC
5	Ground	Ground	Ground
6	DSR	NC	NC
7	RTS	NC	NC
8	CTS	NC	NC
9	RI	NC	NC
10	NC	NC	NC

**CN5: CRT+DVI Connector**

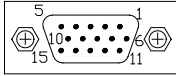

Signal Name	Pin #	Pin #	Signal Name
Red	1	2	Green
Blue	3	4	N.C.
GND	5	6	GND
GND	7	8	GND
VCC	9	10	GND
N.C.	11	12	DDCDATA
HSYNC	13	14	VSYNC
DDCCLK	15		

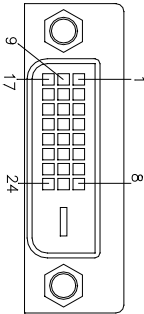

Signal Name	Pin #	Pin #	Signal Name
DATA2-	1	2	DATA2+
GND	3	4	N.C.
N.C.	5	6	DDCCLK
DDCDATA	7	8	N.C.
DATA1-	9	10	DATA1+
GND	11	12	N.C.
N.C.	13	14	VCC
GND	15	16	Hot Plug Detect
DATA0-	17	18	DATA0+
GND	19	20	N.C.
N.C.	21	22	GND
CLK+	23	24	CLK-

**CN6/CN7: Gigabit LAN / USB 3.0 Connector**

**CN8: Audio Connector**

### CN9: CFAST Connector

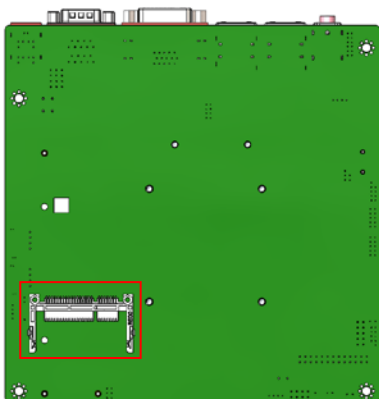

### J1, J2: LVDS Connectors, Hirose DF20G-20DP-1V

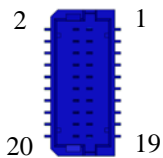
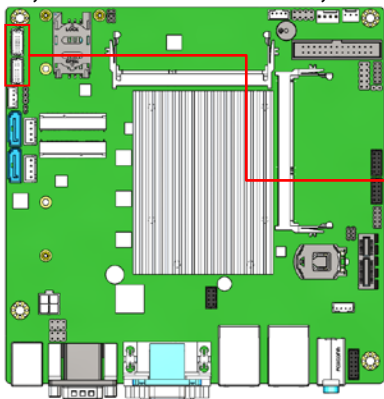



**J2: First Channel LVDS**

**J1: Second Channel LVDS**

Signal Name	Pin #	Pin #	Signal Name
TX0N	2	1	TX0P
Ground	4	3	Ground
TX1N	6	5	TX1P
Ground	8	7	Ground
TX2N	10	9	TX2P
Ground	12	11	Ground
CLKN	14	13	CLKP
Ground	16	15	Ground
TX3N	18	17	TX3P
Power	20	19	Power

**J3: LVDS Panel Power Selection**

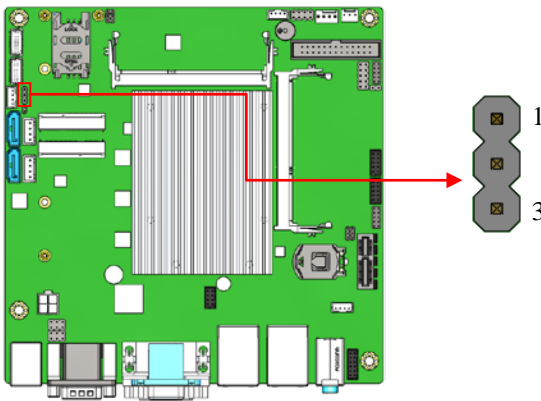

J3	Setting	Panel Voltage
<p>1 2 3</p>	Pin 1-2 Short/Closed	3.3V (default)
<p>1 2 3</p>	Pin 2-3 Short/Closed	5V

**J4 / J5: SATA HDD Power Connectors**

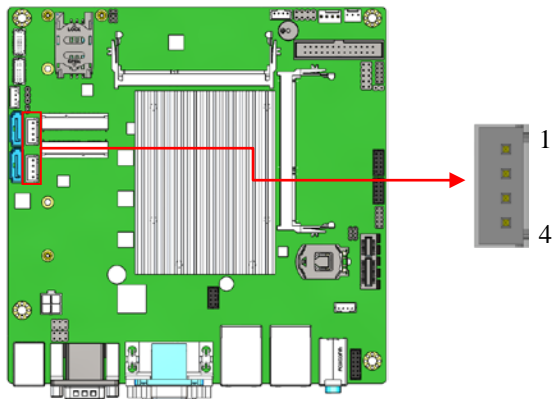

Pin #	Signal Name
1	+5V
2	Ground
3	Ground
4	+12V

**J6: DC\_IN Connector**

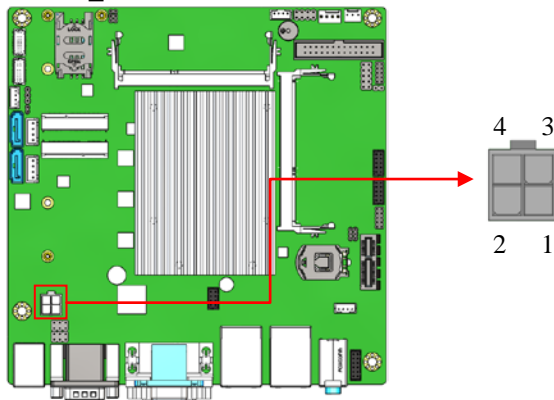

Pin #	Signal Name
1	Ground
2	Ground
3	+12V or +24V
4	+12V or +24V

**J8 / J9: Mini PCIE Slot (SIM Card J7)**

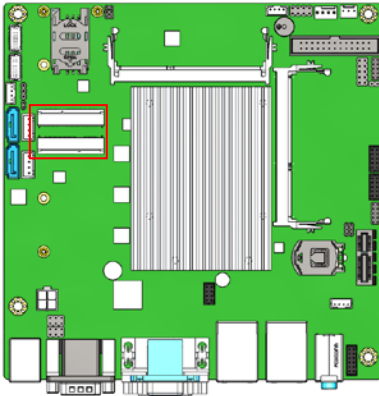

J8 mSATA only (Share with CN1, W/O USB)

**F\_USB1: USB 2.0**

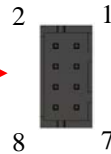
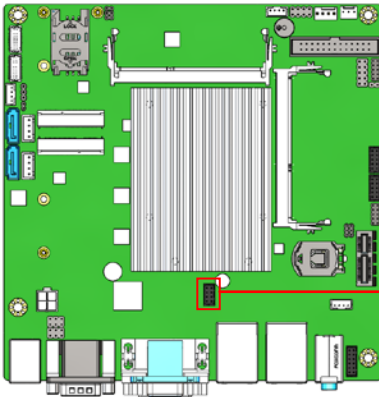

Signal Name	Pin #	Pin #	Signal Name
Vcc	1	2	Ground
D0-	3	4	D1+
D0+	5	6	D1-
Ground	7	8	Vcc

**J10: DDR3L SO-DIMM (CH-A) Sockets**

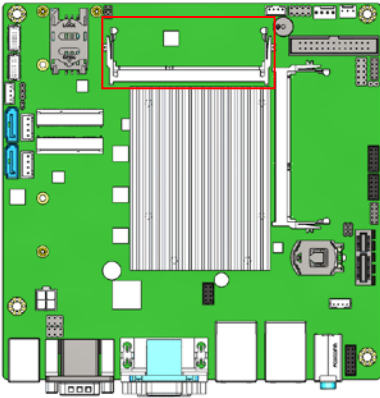

**J13: DDR3L SO-DIMM (CH-B) Sockets**

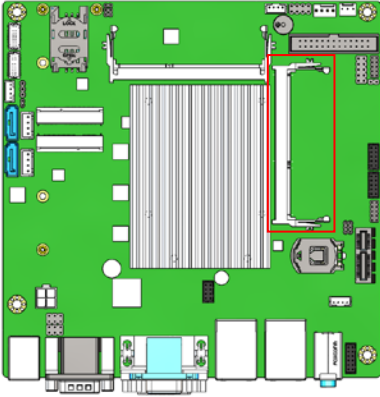

**J11: MCU JTAG**

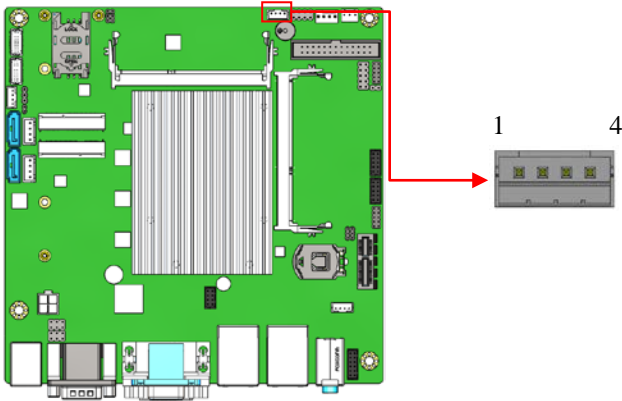

**J12: Front Panel**

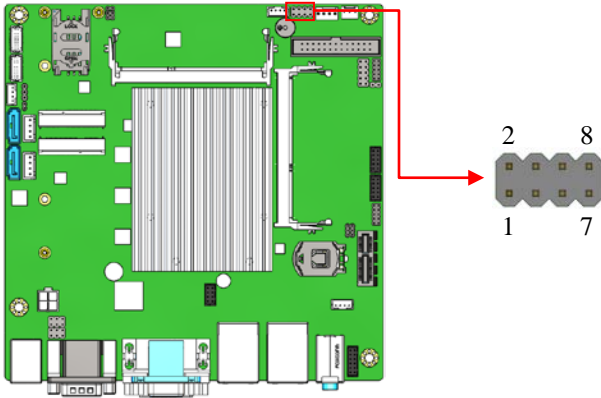

Signal Name	Pin #	Pin #	Signal Name
GND	1	2	PWR_BTN
3.3V	3	4	HDD Active
GND	5	6	Reset
+5V	7	8	GND

### J15 Amplifier Connector

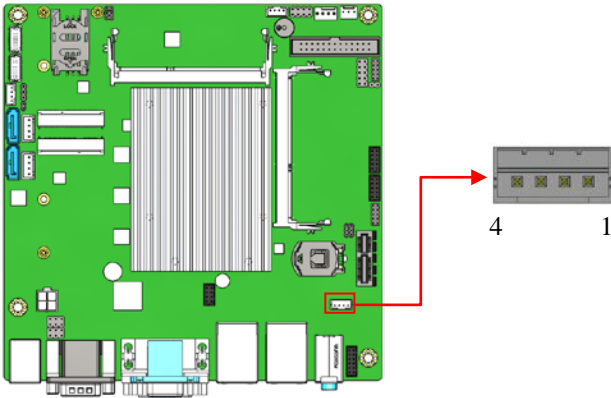

Pin #	Signal Name
1	OUTL+
2	OUTL-
3	OUTR-
4	OUTR+

### J16 Audio Connector (DF11-12DP-2DSA)

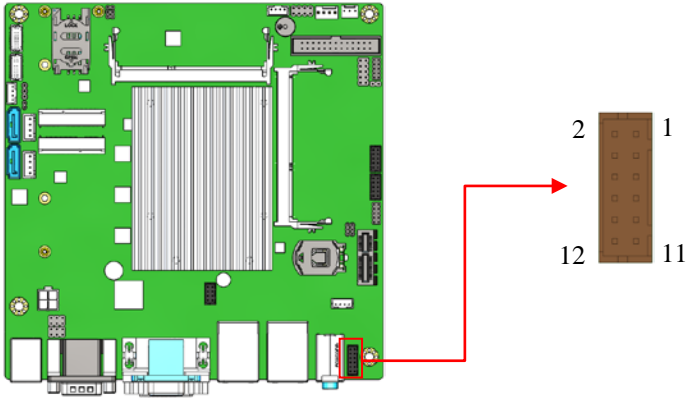

Signal Name	Pin #	Pin #	Signal Name
LINEOUT_R	2	1	LINEOUT_L
Ground	4	3	JD_FRONT
LINEIN_R	6	5	LINEIN_L
Ground	8	7	JD_LINEIN
MIC-R	10	9	MIC_L
Ground	12	11	JD_MIC1

**J17: Digital I/O**

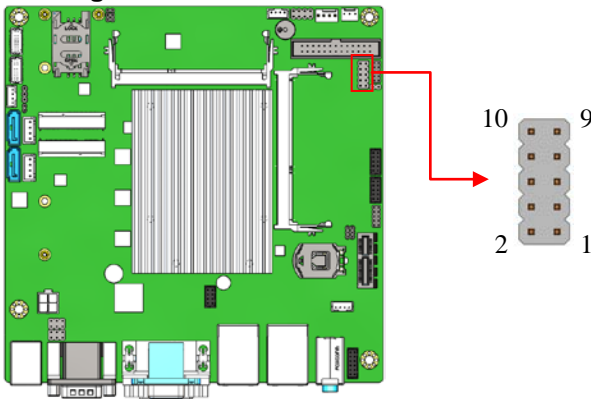

Signal Name	Pin #	Pin #	Signal Name
GND	1	2	VCC
OUT3	3	4	OUT1
OUT2	5	6	OUT0
IN3	7	8	IN1
IN2	9	10	IN0



**J18, J19: COM3/COM4**

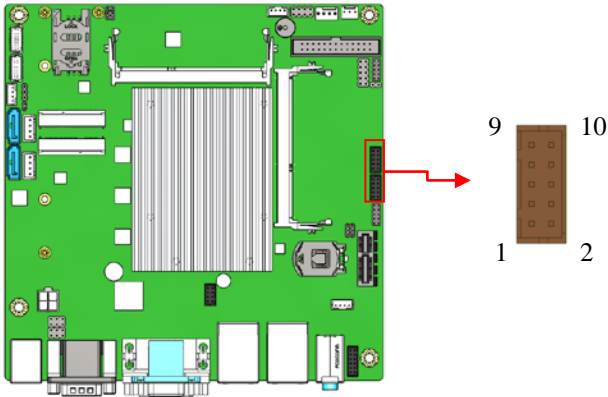

Signal Name	Pin #	Pin #	Signal Name
Data carrier detect	1	2	Receive data
Transmit data	3	4	Data terminal ready
Ground	5	6	Data set ready
Request to send	7	8	Clear to send
Ring indicator	9	10	Not Used

**CPU\_FAN1: CPU Fan Power Connector**

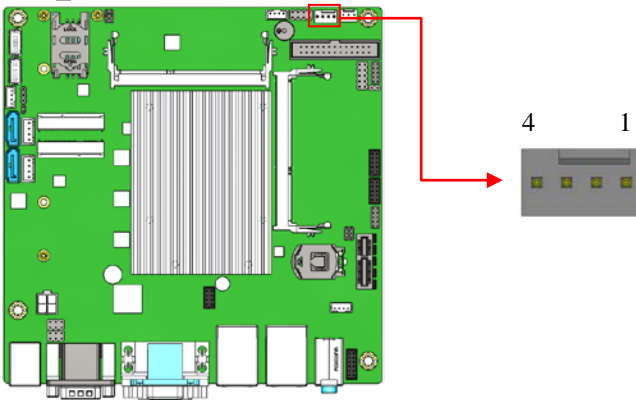

Pin #	Signal Name
1	Ground
2	+12V
3	Rotation detection
4	Control

**SYS\_FAN1: System Fan1 Power Connector**

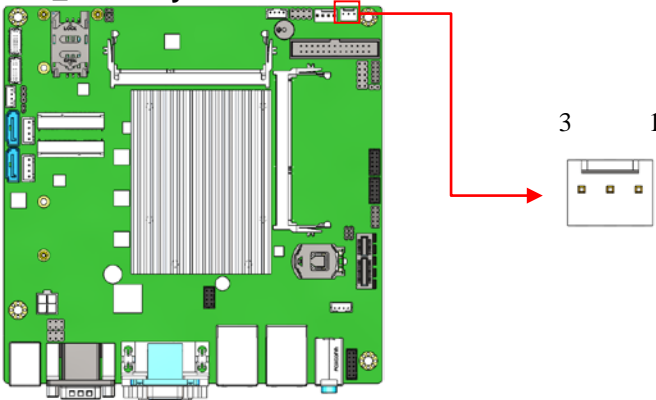

**J7: SIM Card Slot**

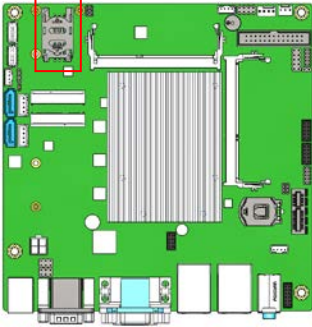

**JP5/JP6: Reserved**

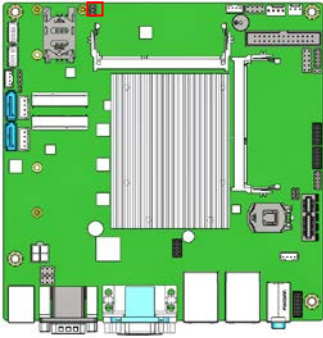

**J14: LPT Port Connector**

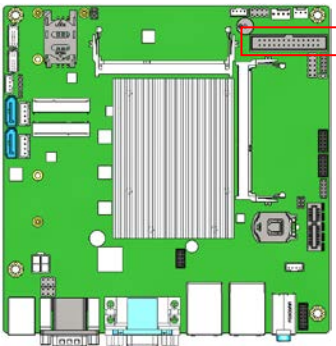

# BIOS Setup

This chapter describes the different settings available in the Award BIOS that comes with the board. The topics covered in this chapter are as follows:

BIOS Introduction.....	33
BIOS Setup .....	33
Advanced Settings .....	34
CSM Configuration .....	41
Chipset Settings.....	43
Security Settings.....	45
Boot Settings.....	46
Save & Exit Settings.....	47

## BIOS Introduction

The BIOS (Basic Input/Output System) installed in your computer system's ROM supports Intel processors. The BIOS provides critical low-level support for a standard device such as disk drives, serial ports and parallel ports. It also provides password protection as well as special support for detailed fine-tuning of the chipset controlling the entire system.

## BIOS Setup

The BIOS provides a Setup utility program for specifying the system configurations and settings. The BIOS ROM of the system stores the Setup utility. When you turn on the computer, the BIOS is immediately activated. Pressing the <Del> key immediately allows you to enter the Setup utility. If you are a little bit late pressing the <Del> key, POST (Power On Self Test) will continue with its test routines, thus preventing you from invoking the Setup. If you still wish to enter Setup, restart the system by pressing the "Reset" button or simultaneously pressing the <Ctrl>, <Alt> and <Delete> keys. You can also restart by turning the system Off and back On again. The following message will appear on the screen:

```
Press <DEL> to Enter Setup
```

In general, you press the arrow keys to highlight items, <Enter> to select, the <PgUp> and <PgDn> keys to change entries, <F1> for help and <Esc> to quit.

When you enter the Setup utility, the Main Menu screen will appear on the screen. The Main Menu allows you to select from various setup functions and exit choices.

**Warning:** *It is strongly recommended that you avoid making any changes to the chipset defaults. These defaults have been carefully chosen by both AMI and your system manufacturer to provide the absolute maximum performance and reliability. Changing the defaults could cause the system to become unstable and crash in some cases.*

## Main Settings

Aptio Setup Utility					
Main	Advanced	Chipset	Boot	Security	Save & Exit
Memory Information					
Total Memory			8192 MB (LPDDR3)		→ ← Select Screen ↑ ↓ Select Item Enter: Select +- Change Opt F1: General Help F2: Previous Values F3: Optimized Default F4: Save & EXIT ESC: Exit
Access Level			Administrator		
System Language			[English]		
System Date			[Mon 06/22/2015]		
System Time			[18:21:30]		

### System Date

Set the Date. Use Tab to switch between Data elements.

### System Time

Set the Time. Use Tab to switch between Data elements.

## Advanced Settings

Aptio Setup Utility					
Main	Advanced	Chipset	Boot	Security	Save & Exit
	<ul style="list-style-type: none"> <li>▶ Trusted Computing</li> <li>▶ ACPI Settings</li> <li>▶ LVDS1 (eDP/DP) Configuration</li> <li>▶ Shutdown Temperature Configuration</li> <li>▶ iSmart Controller</li> <li>▶ F81866/F81846 Super IO Configuration</li> <li>▶ F81866/F81846 H/W Monitor</li> <li>▶ CPU Configuration</li> <li>▶ SATA Configuration</li> <li>▶ Network Stack Configuration</li> <li>▶ CSM Configuration</li> <li>▶ USB Configuration</li> </ul>				→ ← Select Screen ↑ ↓ Select Item Enter: Select +- Change Opt F1: General Help F2: Previous Values F3: Optimized Default F4: Save & EXIT ESC: Exit

## Trusted Computing

Aptio Setup Utility

Main	Advanced	Chipset	Boot	Security	Save & Exit
TPM20 Device Found					→ ← Select Screen
Security Device Support			Enable		↑ ↓ Select Item
Pending operation			None		Enter: Select
Platform Hierarchy			Enabled		+ - Change Opt.
Storage Hierarchy			Enabled		F1: General Help
Endorsement Hierarchy			Enabled		F2: Previous Values
HashPolicy			Sha-1		F3: Optimized Defaults
TPM 20 InterfaceType			TIS		F4: Save & Exit
Device Select			Auto		ESC: Exit

### Security Device Support

Enables or Disables BIOS support for security device. O.S. will not show Security Device. TCG EFI protocol and INT1A interface will not be available.

### Pending operation

Schedule an Operation for the Security Device. NOTE: Your Computer will reboot during restart in order to change State of Security Device.

### Platform Hierarchy

Enable or Disable Platform Hierarchy

### Storage Hierarchy

Enable or Disable Storage Hierarchy

### Endorsement Hierarchy

Enable or Disable Endorsement Hierarchy

### HashPolicy

Select the Hash policy to use. SHA-2 is most secure but might not be supported by all Operating Systems

### TPM 20 InterfaceType

Select the Communication Interface to TPM 20 Device.

### Device Select

TPM 1.2 will restrict support to TPM 1.2 devices, TPM 2.0 will restrict support to TPM 2.0 devices, Auto will support both with the default set to TPM 2.0 devices if not found, TPM 1.2 devices will be enumerated.

## ACPI Settings

Aptio Setup Utility

Main	Advanced	Chipset	Boot	Security	Save & Exit
ACPI Settings					
Enable Hibernation		Enabled			
ACPI Sleep State		S3 (Suspend to R...)			
					→ ← Select Screen ↑ ↓ Select Item Enter: Select +- Change Field F1: General Help F2: Previous Values F3: Optimized Default F4: Save ESC: Exit

### Enable Hibernation

Enables or Disables System ability to Hibernate (OS/S4 Sleep State). This option may be not effective with some OS.

### ACPI Sleep State

Select the highest ACPI sleep state the system will enter when the SUSPEND button is pressed.

## LVDS (eDP/DP) Configuration

Aptio Setup Utility

Main	Advanced	Chipset	Boot	Security	Save & Exit
LVDS (eDP/DP) Configuration					
LVDS (eDP/DP) Support		Disabled			
					→ ← Select Screen ↑ ↓ Select Item Enter: Select +- Change Field F1: General Help F2: Previous Values F3: Optimized Default F4: Save ESC: Exit

### LVDS (eDP/DP) Support

LVDS (eDP/DP) ON/OFF



## Shutdown Temperature Configuration

Aptio Setup Utility					
Main	Advanced	Chipset	Boot	Security	Save & Exit
	ACPI Shutdown Temperature		Disabled		→ ← Select Screen ↑ ↓ Select Item Enter: Select +- Change Field F1: General Help F2: Previous Values F3: Optimized Default F4: Save ESC: Exit

## iSmart Controller

Aptio Setup Utility					
Main	Advanced	Chipset	Boot	Security	Save & Exit
	iSmart Controller				
	Power-On after Power failure		Disable		→ ← Select Screen
	Temperature Guardian		Enable		↑ ↓ Select Item
	Schedule Slot 1		None		Enter: Select
	Schedule Slot 2		None		+ - Change Opt.
	Brightness Control		Disable		F1: General Help
					F2: Previous Values
					F3: Optimized Defaults
					F4: Save & Exit
					ESC: Exit

### Power-On after Power failure

This field sets the system power status whether Disable or Enable when power returns to the system from a power failure situation.

### Temperature Guardian

Generate the reset signal when system hangs up on POST.

### Schedule Slot 1 / 2

Setup the hour/minute for system power on.

## F81866/F81846 Super IO Configuration

Aptio Setup Utility

Main	Advanced	Chipset	Boot	Security	Save & Exit
F81866/F81846 Super IO Configuration					
Super IO Chip			F81866/F81846		→ ← Select Screen
▶ Serial Port 1 Configuration					↑ ↓ Select Item
▶ Serial Port 2 Configuration					Enter: Select
▶ Serial Port 3 Configuration					+ - Change Field
▶ Serial Port 4 Configuration					F1: General Help
▶ Parallel Port Configuration					F2: Previous Values
					F3: Optimized Default
					F4: Save
					ESC: Exit

### Serial Port Configuration

Set Parameters of Serial Ports (COM)

### Parallel Port Configuration

Set Parameters of Parallel Port (LPT/LPTE)

## F81866/F81846 H/W Monitor

Aptio Setup Utility

Main	Advanced	Chipset	Boot	Security	Save & Exit
PC Health Status					
CPU Smart Fan Control			Disabled		
System FAN1 Smart Fan Control			Disabled		→ ← Select Screen
CPU Temperature			+32 C		↑ ↓ Select Item
System Temperature			+33 C		Enter: Select
CPU Fan Speed			6850 RPM		+ - Change Field
System FAN1 Fan Speed			4225 RPM		F1: General Help
Vcore			+0.880 V		F2: Previous Values
Vcc5			+5.045 V		F3: Optimized Default
Vcc12			+12.144 V		F4: Save
V1.35			+1.352 V		ESC: Exit

### Temperatures/Voltages

These fields are the parameters of the hardware monitoring function feature of the board. The values are read-only values as monitored by the system and show the PC health status.

## CPU Configuration

Aptio Setup Utility

Main	Advanced	Chipset	Boot	Security	Save & Exit
CPU Configuration					
▶ Socket 0 CPU Information					→ ← Select Screen
CPU Speed					↑ ↓ Select Item
64-bit					Enter: Select
1600 MHz					+ - Change Field
Supported					F1: General Help
Intel Virtualization Technology					F2: Previous Values
Enabled					F3: Optimized Default
Power Technology					F4: Save
Energy Efficient					ESC: Exit

### Socket 0 CPU Information

Socket specific CPU Information

### Intel Virtualization Technology

When enabled, a VMM can utilize the additional hardware capabilities provided by Vanderpool Technology.

### Power Technology

Enable the power management features.

### Socket 0 CPU Information

Aptio Setup Utility

Main	Advanced	Chipset	Boot	Security	Save & Exit
Socket 0 CPU Information					
Intel(R) Pentium(R) CPU N3700 @1.6GHz z					→ ← Select Screen
CPU Signature					↑ ↓ Select Item
406c3					Enter: Select
Microcode Patch					+ - Change Field
33c					F1: General Help
Max CPU Speed					F2: Previous Values
1600 MHz					F3: Optimized Default
Min CPU Speed					F4: Save
480 MHz					ESC: Exit
Processor Cores					
4					
Intel HT Technology					
Not Supported					
Intel VT-x Technology					
Supported					

## SATA Configuration

Aptio Setup Utility					
Main	Advanced	Chipset	Boot	Security	Save & Exit
SATA Controller		Enabled			
SATA Mode Selection		AHCI			
SATA Interface Speed		Gen3			
SATA Port 0				→ ← Select Screen	
Not Present				↑ ↓ Select Item	
Port 0		Enabled		Enter: Select	
Hot Plug		Disabled		+- Change Field	
SATA Port 1				F1: General Help	
Not Present				F2: Previous Values	
Port 1		Enabled		F3: Optimized Default	
Hot Plug		Disabled		F4: Save	
				ESC: Exit	

### SATA Controller

Enable / Disable SATA Device

### SATA Mode Selection

Determines how SATA controller operate.

### SATA Interface Speed

Select SATA Interface Speed CHV A1 always with Gen1 Speed.

### Port

Enable or Disable SATA Port

### Hot Plug

Designates this port as Hot Pluggable.

## Network Stack Configuration

Aptio Setup Utility

Main	Advanced	Chipset	Boot	Security	Save & Exit
Network Stack			Disabled		

### Network Stack

Enables/Disable UEFI Network Stack

## CSM Configuration

Aptio Setup Utility

Main	Advanced	Chipset	Boot	Security	Save & Exit
Compatibility Support Module Configuration					
CSM Support			Enabled		→ ← Select Screen ↑ ↓ Select Item Enter: Select +- Change Field F1: General Help F2: Previous Values F3: Optimized Default F4: Save ESC: Exit
CSM16 Module Version			07.76		
GateA20 Active			Upon Request		
Option ROM Messages			Force BIOS		
Boot option filter			UEFI and Legacy		
Option ROM execution					
Network			UEFI		
Storage			UEFI		
Video			Legacy		
Other PCI device			UEFI		

### CSM Support

Enable/Disable CSM Support.

### Boot option filter

This option controls Legacy/UEFI ROMs priority

### Network

Controls the execution of UEFI and Legacy PXE OpROM

### Storage

Controls the execution of UEFI and Legacy Storage OpROM

### Video

Controls the execution of UEFI and Legacy Video OpROM

### Other PCI device

Determines OpROM execution policy for devices other than Network, Storage, or Video.

## USB Configuration

Aptio Setup Utility

Main	Advanced	Chipset	Boot	Security	Save & Exit
USB Configuration					
USB Module Version			10		
USB Devices: 1 Drive, 1 Keyboard, 1 Hubs					
Legacy USB Support			Enabled	→ ← Select Screen	
XHCI Hand-off			Enabled	↑ ↓ Select Item	
EHCI Hand-off			Enabled	Enter: Select	
USB Mass Storage Driver Support			Enabled	+- Change Field	
USB hardware delays and time-outs:				F1: General Help	
USB Transfer time-out			20 sec	F2: Previous Values	
Device reset time-out			20 sec	F3: Optimized Default	
Device power-up delay			Auto	F4: Save	
				ESC: Exit	

### Legacy USB Support

Enables Legacy USB support.

AUTO option disables legacy support if no USB devices are connected.

DISABLE option keeps USB devices available only for EFI applications.

### XHCI Hand-off

This is a workaround for OSes without XHCI hand-off support. The XHCI ownership change should be claimed by XHCI driver.

### EHCI Hand-off

This is a workaround for OSes without EHCI hand-off support. The EHCI ownership change should be claimed by EHCI driver.

### USB Mass Storage Driver Support

Enable/Disable USB Mass Storage Driver Support.

### USB Transfer time-out

The time-out value for Control, Bulk, and Interrupt transfers.

### Device reset time-out

USB mass Storage device start Unit command time-out.

### Device power-up delay

Maximum time the device will take before it properly reports itself to the Host Controller. 'Auto' uses default value: for a Root port it is 100ms, for a Hub port the delay is taken from Hub descriptor.

## Chipset Settings

Aptio Setup Utility					
Main	Advanced	Chipset	Boot	Security	Save & Exit
<ul style="list-style-type: none"> <li>▶ North Bridge</li> <li>▶ South Bridge</li> </ul>					

## North Bridge

Aptio Setup Utility					
Main	Advanced	Chipset	Boot	Security	Save & Exit
<ul style="list-style-type: none"> <li>▶ Intel IGD Configuration</li> </ul>					
Memory Information					→ ← Select Screen
Total Memory		8192 MB(LPDDR3)			↑ ↓ Select Item
Memory Slot 0		4096 MB(LPDDR3)			Enter: Select
Memory Slot 1		4096 MB(LPDDR3)			+ - Change Field
					F1: General Help
					F2: Previous Values
					F3: Optimized Default
					F4: Save ESC: Exit

## South Bridge

Aptio Setup Utility					
Main	Advanced	Chipset	Boot	Security	Save & Exit
<ul style="list-style-type: none"> <li>▶ Azalia Configuration</li> <li>▶ USB Configuration</li> <li>▶ PCI Express Configuration</li> </ul>					

### Azalia Configuration

Azalia HD Audio Options

### USB Configuration

USB Configuration Settings

### PCI Express Configuration

PCI Express Configuration Settings

## Azalia Configuration

Main	Advanced	Chipset	Boot	Security	Save & Exit
Azalia Configuration					
Audio Controller			Enabled		
Azalia HDMI Codec			Enabled		
Azalia HDMI Codec Port B			Enabled		
Azalia HDMI Codec Port C			Enabled		
Azalia HDMI Codec Port D			Enabled		

### Azalia

Control Detection of the Azalia device.

Disabled = Azalia will be unconditionally be disabled.

Enabled = Azalia will be unconditionally be enabled.

Auto = Azalia will be enabled if present, disabled otherwise.

### Azalia HDMI Codec

Enable/Disable internal HDMI codec for Azalia

## USB Configuration

Main	Advanced	Chipset	Boot	Security	Save & Exit
USB Configuration					
xHCI Mode			Enabled		

### xHCI Mode

Mode of operation of xHCI controller.

## PCI Express Configuration

Main	Advanced	Chipset	Boot	Security	Save & Exit
PCI Express Configuration					
<ul style="list-style-type: none"> <li>▶ PCI Express Root Port 1</li> <li>▶ PCI Express Root Port 2</li> <li>▶ PCI Express Root Port 3</li> <li>▶ PCI Express Root Port 4</li> </ul>			→ ← Select Screen ↑ ↓ Select Item Enter: Select +- Change Field F1: General Help F2: Previous Values F3: Optimized Default F4: Save ESC: Exit		

### PCI Express Configuration

PCI Express Root Port Settings.



## Security Settings

This section allows you to configure and improve your system and allows you to set up some system features according to your preference.

Aptio Setup Utility					
Main	Advanced	Chipset	Boot	Security	Save & Exit
Password Description  If ONLY the Administrator's password is set, then this only limit access to Setup and is only asked for when entering Setup. If ONLY the User's password is set, then this is a power on password and must be entered to boot or enter Setup. In Setup the User will have Administrator rights The password length must be in the following range: Minimum length 3 Maximum length 20  Administrator Password User Password				→ ← Select Screen ↑ ↓ Select Item Enter: Select +- Change Field F1: General Help F2: Previous Values F3: Optimized Default F4: Save ESC: Exit	

### Administrator Password

Set Setup Administrator Password.

### User Password

Set User Password.

## Boot Settings

This section allows you to configure the boot settings.

Aptio Setup Utility					
Main	Advanced	Chipset	Boot	Security	Save & Exit
Boot Configuration					→ ← Select Screen
Setup Prompt Timeout		1			↑ ↓ Select Item
Bootup NumLock State		Off			Enter: Select
Fast Boot		Disabled			+ - Change Field
					F1: General Help
Quiet Boot		Disabled			F2: Previous Values
					F3: Optimized Default
Boot Option Priorities					F4: Save
New Boot Option Policy		Default			ESC: Exit

### Setup Prompt Timeout

Number of seconds to wait for setup activation key.

65535(0xFFFF) means indefinite waiting.

### Bootup NumLock State

Select the keyboard NumLock state.

### Quiet Boot

Enables/Disables Quiet Boot option.

### Fast Boot

Enables/Disables boot with initialization of a minimal set of devices required to launch active boot option. Has no effect for BBS boot options.

## Save & Exit Settings

Aptio Setup Utility

Main	Advanced	Chipset	Boot	Security	Save & Exit
Save Options					
Save Changes and Exit					
Discard Changes and Exit					
Save Changes and Reset					
Discard Changes and Reset					
Save Changes					
Discard Changes					
Defaults Options					
Restore Defaults					
Save as User Defaults					
Restore User Defaults					
Boot Override					
					→ ← Select Screen ↑ ↓ Select Item Enter: Select +- Change Field F1: General Help F2: Previous Values F3: Optimized Default F4: Save ESC: Exit

### Save Changes and Exit

Exit system setup after saving the changes.

### Discard Changes and Exit

Exit system setup without saving any changes.

### Save Changes and Reset

Reset the system after saving the changes.

### Discard Changes and Reset

Reset system setup without saving any changes.

### Save Changes

Save Changes done so far to any of the setup options.

### Discard Changes

Discard Changes done so far to any of the setup options.

### Restore Defaults

Restore/Load Defaults values for all the setup options.

### Save as User Defaults

Save the changes done so far as User Defaults.

### Restore User Defaults

Restore the User Defaults to all the setup options.

## Drivers Installation

This section describes the installation procedures for software and drivers. The software and drivers are included with the motherboard. If you find the items missing, please contact the vendor where you made the purchase. The contents of this section include the following:

Intel Chipset Software Installation Utility.....	49
VGA Drivers Installation .....	52
Realtek HD Audio Driver Installation .....	54
LAN Drivers Installation.....	55
TXE Drivers Installation.....	58

### **IMPORTANT NOTE:**

After installing your Windows operating system, you must install first the Intel Chipset Software Installation Utility before proceeding with the drivers installation.

## Intel Chipset Software Installation Utility

The Intel Chipset Drivers should be installed first before the software drivers to enable Plug & Play INF support for Intel chipset components. Follow the instructions below to complete the installation.

1. Insert the disc that comes with the board. Click **Intel** and then **Intel(R) Braswell Chipset Drivers**.



2. Click **Intel(R) Chipset Software Installation Utility**



3. When the Welcome screen to the Intel® Chipset Device Software appears, click *Next* to continue.



4. Click **Accept** to accept the software license agreement and proceed with the installation process.



5. On the Readme File Information screen, click **Install** to continue the installation.
6. The Setup process is now complete. Click **Finish** to restart the computer and for changes to take effect.

## VGA Drivers Installation

1. Click **Intel(R) Braswell Graphics Driver**



2. When the Welcome screen appears, click **Next** to continue.

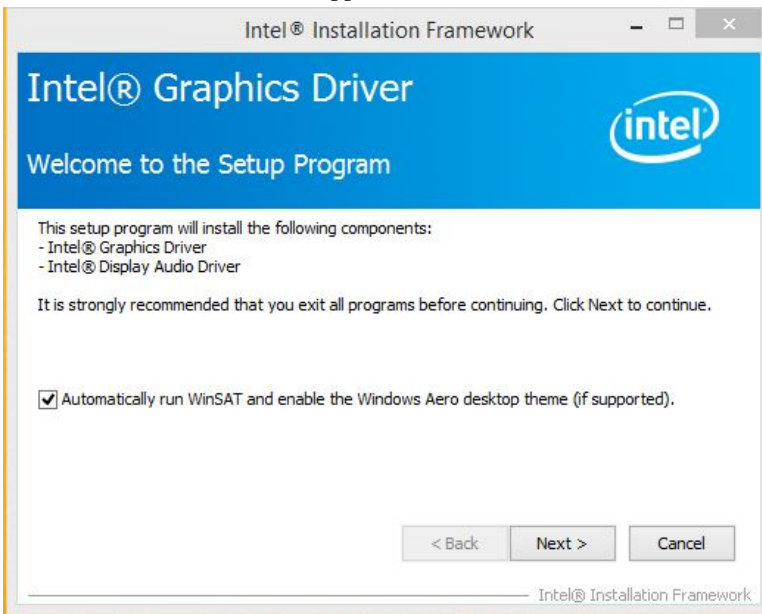

3. Click **Yes** to to agree with the license agreement and continue the installation.



4. On the Readme File Information screen, click *Next* to continue the installation of the Intel® Graphics Driver.

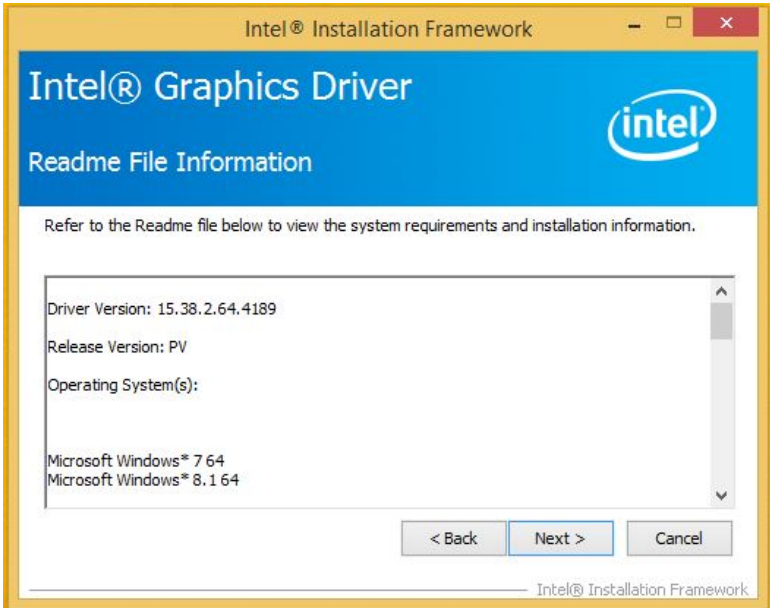

5. On Setup Progress screen, click *Next* to continue.

6. Setup complete. Click *Finish* to restart the computer and for changes to take effect.

## Realtek HD Audio Driver Installation

1. Click *Realtek High Definition Audio Driver*.



2. On the Welcome to the InstallShield Wizard screen, click *Next* to proceed with and complete the installation process.

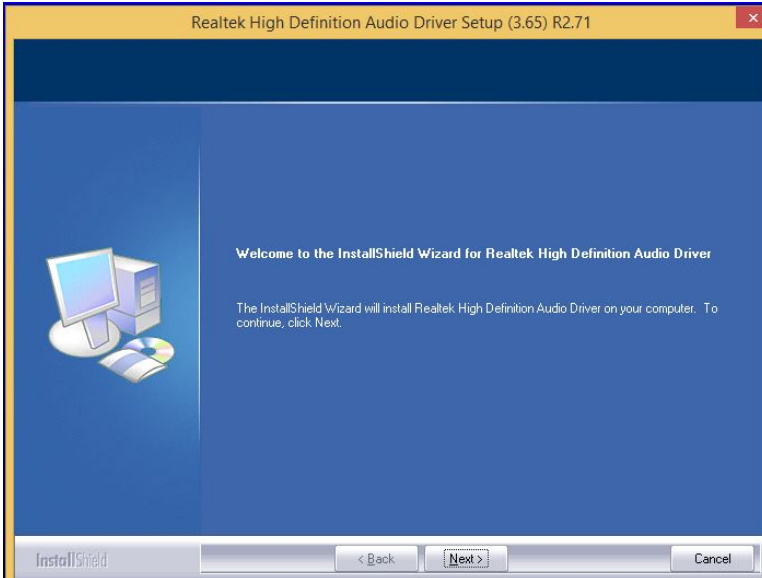

3. Restart the computer when prompted.

## LAN Drivers Installation

1. Insert the CD that comes with the board. Click **LAN Card** and then **Intel LAN Controller Drivers**.



2. Click **Intel(R) I21x Gigabit Network Drivers**



3. In the Welcome screen, click **Next**.



4. In the License Agreement screen, click **I accept the terms in license agreement** and **Next** to accept the software license agreement and proceed with the installation process.



5. Click the checkbox for **Drivers** in the Setup Options screen to select it and click **Next** to continue.

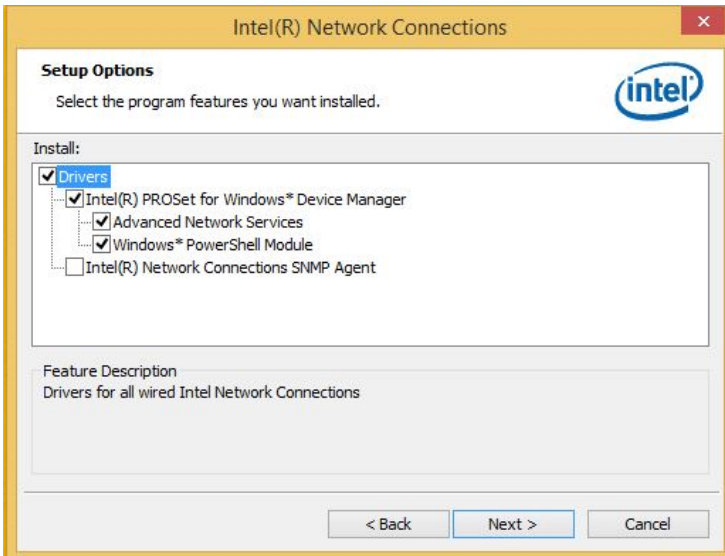

6. When the Ready to Install the Program screen appears, click **Install** to continue.

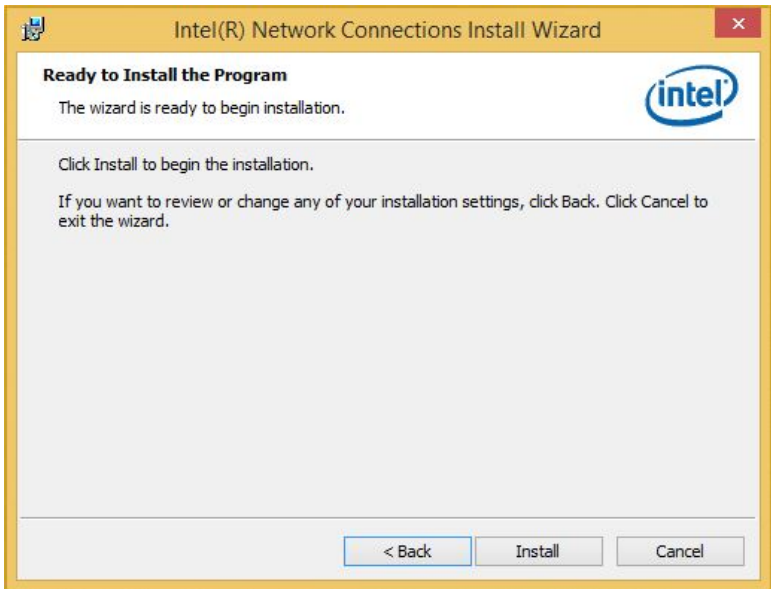

7. When InstallShield Wizard is complete, click **Finish**.

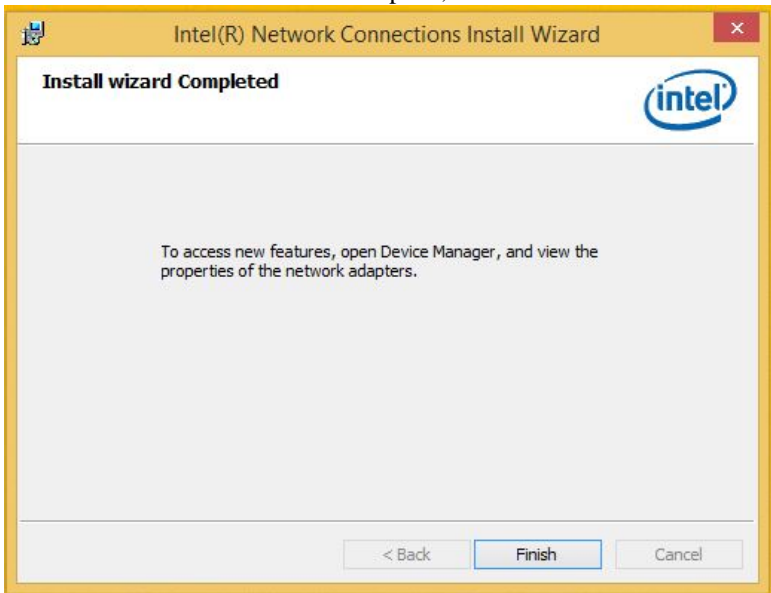

## TXE Drivers Installation

1. Click *Intel(R) TXE Driver*



2. When the Welcome screen appears, click *Next* to continue.

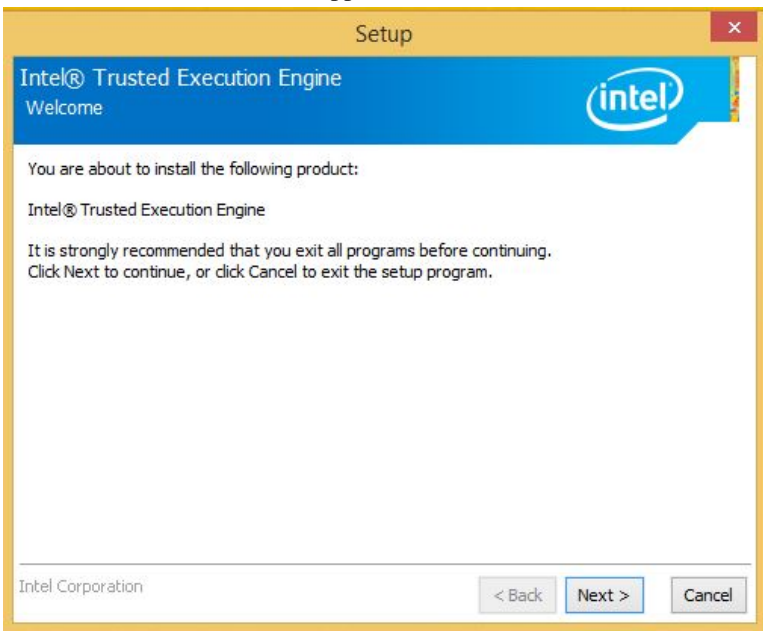

3. Click **Next** to to agree with the license agreement and continue the installation.
4. On the Confirmation screen, click **Next** to continue the installation of the Intel(R) TXE Driver.
5. Setup complete. Click **Finish** to restart the computer and for changes to take effect.

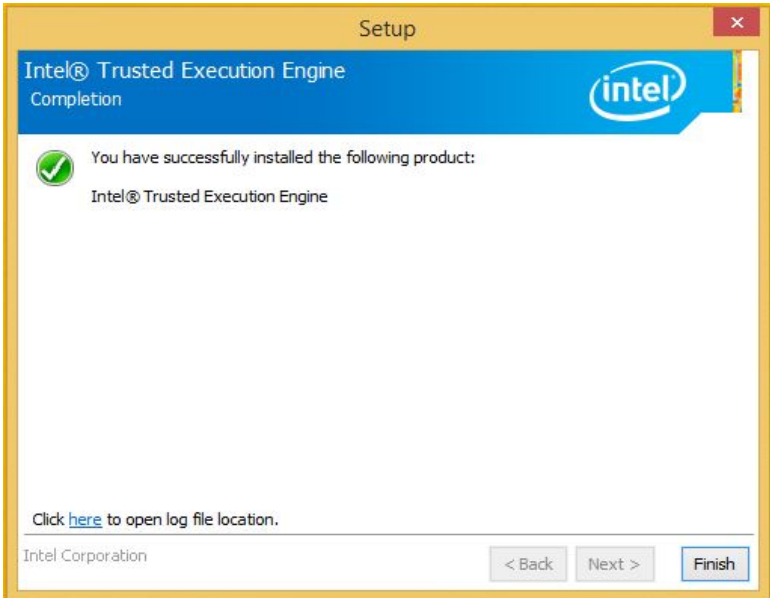

## Appendix

### A. I/O Port Address Map

Each peripheral device in the system is assigned a set of I/O port addresses that also becomes the identity of the device. The following table lists the I/O port addresses used.

Address	Device Description
000h - 06Fh	PCI Express Root Complex
040h - 043h	System timer
070h - 077h	System CMOS/real time clock
2E8h - 2EFh	Communications Port (COM4)
2F8h - 2FFh	Communications Port (COM2)
378h - 37Fh	Printer Port (LPT1)
3B0h - 3BBh	Intel(R) HD Graphics
3E8h - 3EFh	Communications Port (COM3)
3F8h - 3FFh	Communications Port (COM1)
040h - 05Fh	Intel(R) Celeron(R)/Pentium(R) SM Bus Controller
060h - 07Fh	Standard SATA AHCI Controller



## B. Interrupt Request Lines (IRQ)

Peripheral devices use interrupt request lines to notify CPU for the service required. The following table shows the IRQ used by the devices on board.

Level	Function
IRQ0	System timer
IRQ1	Standard PS/2 Keyboard
IRQ3	Communications Port (COM2)
IRQ4	Communications Port (COM1)
IRQ6	Communications Port (COM3)
IRQ10	Communications Port (COM4)
IRQ11	PS/2 Compatible Mouse
IRQ12	Intel(R) Celeron(R)/Pentium(R) SM Bus Controller
IRQ19	Standard SATA AHCI Controller

## C. Watchdog Timer Configuration

The WDT is used to generate a variety of output signals after a user programmable count. The WDT is suitable for use in the prevention of system lock-up, such as when software becomes trapped in a deadlock. Under these sorts of circumstances, the timer will count to zero and the selected outputs will be driven. Under normal circumstance, the user will restart the WDT at regular intervals before the timer counts to zero.

### SAMPLE CODE:

```
//-----
#include <dos.h>
#include <conio.h>
#include <stdio.h>
#include <stdlib.h>
#include "F81866.H"
//-----
int main (int argc, char *argv[]);
void EnableWDT(int);
void DisableWDT(void);
//-----
int main (int argc, char *argv[])
{
    unsigned char bBuf;
    unsigned char bTime;
    char **endptr;

    char SIO;

    printf("Fintek 81866 watch dog program\n");

    SIO = Init_F81866();
    if (SIO == 0)
    {
        printf("Can not detect Fintek 81866, program abort.\n");
        return(1);
    }/if (SIO == 0)

    if (argc != 2)
    {
        printf(" Parameter incorrect!!\n");
        return (1);
    }

    bTime = strtol (argv[1], endptr, 10);
    printf("System will reset after %d seconds\n", bTime);

    if (bTime)
    {
        EnableWDT(bTime); }
    else
    {
        DisableWDT(); }

    return 0;
}
//-----
void EnableWDT(int interval)
{
    unsigned char bBuf;
```

```

bBuf = Get_F81866_Reg(0x2B);
bBuf &= (~0x20);
Set_F81866_Reg(0x2B, bBuf); //Enable WDTO

Set_F81866_LD(0x07); //switch to logic device 7
Set_F81866_Reg(0x30, 0x01); //enable timer

bBuf = Get_F81866_Reg(0xF5);
bBuf &= (~0x0F);
bBuf |= 0x52;
Set_F81866_Reg(0xF5, bBuf); //count mode is second

Set_F81866_Reg(0xF6, interval); //set timer

bBuf = Get_F81866_Reg(0xFA);
bBuf |= 0x01;
Set_F81866_Reg(0xFA, bBuf); //enable WDTO output

bBuf = Get_F81866_Reg(0xF5);
bBuf |= 0x20;
Set_F81866_Reg(0xF5, bBuf); //start counting
}
//-----
void DisableWDT(void)
{
    unsigned char bBuf;

    Set_F81866_LD(0x07); //switch to logic device 7

    bBuf = Get_F81866_Reg(0xFA);
    bBuf &= ~0x01;
    Set_F81866_Reg(0xFA, bBuf); //disable WDTO output

    bBuf = Get_F81866_Reg(0xF5);
    bBuf &= ~0x20;
    bBuf |= 0x40;
    Set_F81866_Reg(0xF5, bBuf); //disable WDT
}
//-----

```

```

//-----
#include "F81866.H"
#include <dos.h>
//-----
unsigned int F81866_BASE;
void Unlock_F81866 (void);
void Lock_F81866 (void);
//-----
unsigned int Init_F81866(void)
{
    unsigned int result;
    unsigned char ucDid;

    F81866_BASE = 0x4E;
    result = F81866_BASE;

    ucDid = Get_F81866_Reg(0x20);
    if (ucDid == 0x10) //Fintek 81866
    {
        goto Init_Finish;
    }

    F81866_BASE = 0x2E;
    result = F81866_BASE;

    ucDid = Get_F81866_Reg(0x20);
    if (ucDid == 0x10) //Fintek 81866
    {
        goto Init_Finish;
    }

    F81866_BASE = 0x00;
    result = F81866_BASE;
}

Init_Finish:
    return (result);
}
//-----
void Unlock_F81866 (void)
{
    outportb(F81866_INDEX_PORT, F81866_UNLOCK);
    outportb(F81866_INDEX_PORT, F81866_UNLOCK);
}
//-----
void Lock_F81866 (void)
{
    outportb(F81866_INDEX_PORT, F81866_LOCK);
}
//-----
void Set_F81866_LD( unsigned char LD)
{
    Unlock_F81866();
    outportb(F81866_INDEX_PORT, F81866_REG_LD);
    outportb(F81866_DATA_PORT, LD);
    Lock_F81866();
}
//-----
void Set_F81866_Reg( unsigned char REG, unsigned char DATA)
{
    Unlock_F81866();
    outportb(F81866_INDEX_PORT, REG);
    outportb(F81866_DATA_PORT, DATA);
    Lock_F81866();
}
//-----
unsigned char Get_F81866_Reg(unsigned char REG)
{
    unsigned char Result;
    Unlock_F81866();
    outportb(F81866_INDEX_PORT, REG);
    Result = inportb(F81866_DATA_PORT);
    Lock_F81866();
    return Result;
}

```

```
}
//-----

//-----
#ifndef __F81866_H
#define __F81866_H          1
//-----
#define F81866_INDEX_PORT    (F81866_BASE)
#define F81866_DATA_PORT    (F81866_BASE+1)
//-----
#define F81866_REG_LD        0x07
//-----
#define F81866_UNLOCK        0x87
#define F81866_LOCK          0xAA
//-----
unsigned int Init_F81866(void);
void Set_F81866_LD(unsigned char);
void Set_F81866_Reg(unsigned char, unsigned char);
unsigned char Get_F81866_Reg(unsigned char);
//-----
#endif //__F81866_H
```

## D. Digital I/O Sample Code

```
//-----
//
// THIS CODE AND INFORMATION IS PROVIDED "AS IS" WITHOUT WARRANTY OF ANY
// KIND, EITHER EXPRESSED OR IMPLIED, INCLUDING BUT NOT LIMITED TO THE
// IMPLIED WARRANTIES OF MERCHANTABILITY AND/OR FITNESS FOR A PARTICULAR
// PURPOSE.
//
//-----
//rev date name description
//-----
//s01 20091028 Sunny set gpio multi-function pin
//-----
#include <dos.h>
#include <conio.h>
#include <stdio.h>
#include <stdlib.h>
#include "F81865.H"

#define BIT0 0x01
#define BIT1 0x02
#define BIT2 0x04
#define BIT3 0x08
#define BIT4 0x10
#define BIT5 0x20
#define BIT6 0x40
#define BIT7 0x80

//-----
int main (void);

void Dio5Initial(void);
void Dio5SetOutput(unsigned char);
unsigned char Dio5GetInput(void);
void Dio5SetDirection(unsigned char);
unsigned char Dio5GetDirection(void);
//-----
int main (void)
{
    char SIO;
    unsigned char DIO;

    printf("Fintek 81865/81866 digital I/O test program\n");

    SIO = Init_F81865();
    if (SIO == 0)
    {
        printf("Can not detect Fintek 81865/81866, program abort.\n");
        return(1);
    }/if (SIO == 0)

    Dio5Initial();
/*
    //for GPIO50..57
    Dio5SetDirection(0xF0); //GP50..53 = input, GP54..57=output
    printf("Current DIO direction = 0x%X\n", Dio5GetDirection());

    printf("Current DIO status = 0x%X\n", Dio5GetInput());

    printf("Set DIO output to high\n");
*/
}
```

```

Dio5SetOutput(0x0F);

printf("Set DIO output to low\n");
Dio5SetOutput(0x00);
*/

//for GPIO50..57
Dio5SetDirection(0xF0); //GP50..53 = input, GP54..57=output

Dio5SetOutput(0x00); //clear
// DIO = Dio5GetInput() & 0x0F;

Dio5SetOutput(0x00); //clear
DIO = Dio5GetInput() & 0x0F;
if (DIO != 0x0A)
{
    printf("The Fintek 81865 digital IO abnormal, abort.\n");
    return(1);
} //if (DIO != 0x0A)

Dio5SetOutput(0xA0); //clr# is high
Dio5SetOutput(0xF0); //clk and clr# is high
Dio5SetOutput(0xA0); //clr# is high

DIO = Dio5GetInput() & 0x0F;
if (DIO != 0x05)
{
    printf("The Fintek 81865 digital IO abnormal, abort.\n");
    return(1);
}
printf("!!! Pass !!!\n");
return 0;
}
//-----
void Dio5Initial(void)
{
    unsigned char ucBuf;

//iBase-Sunny20091028[s01] start >>
//switch GPIO multi-function pin for gpio 50~57

//gpio53~57 UR5_FULL_EN(bit1), clear UR6_FULL_EN(bit3)
//set UR5_FULL_EN,should set UR_GP_PROG_EN = 1 (reg26,bit0) first

    ucBuf = Get_F81865_Reg(0x26);
    ucBuf |= BIT0;
    Set_F81865_Reg(0x26, ucBuf);
    //set UR5_FULL_EN(bit1), clear UR6_FULL_EN(bit3)
    ucBuf = Get_F81865_Reg(0x2A);
    ucBuf &= ~BIT3;//clear bit 3,
    ucBuf |= BIT1;//set bit 1,
    Set_F81865_Reg(0x2a, ucBuf);

//GPIO51 ~ GPIO52
//clear UR6_ALT_EN(bit5), IR_ALT_EN(bit4),set FDC_GP_EN(bit3)

//GPIO50
//set FDC_GP_EN(bit3), clear RTS6_ALT_EN(RTS6_2_ALT_EN)(bit6)

    ucBuf = Get_F81865_Reg(0x2A);
    ucBuf &= ~(BIT4+BIT5+BIT6); //clear UR6_ALT_EN(bit5), IR_ALT_EN(bit4),
    RTS6_ALT_EN(RTS6_2_ALT_EN)(bit6)
    Set_F81865_Reg(0x2a, ucBuf);

```

## APPENDIX

```
//set FDC_GP_EN(bit3), should clear UR_GP_PROG_EN (reg26.bit0) first
ucBuf = Get_F81865_Reg(0x26);
ucBuf &= ~BIT0;
Set_F81865_Reg(0x26, ucBuf);//clear UR_GP_PROG_EN = 0 (reg26.bit0)

ucBuf = Get_F81865_Reg(0x2A);
ucBuf |= BIT3; //set FDC_GP_EN(bit3),
Set_F81865_Reg(0x2a, ucBuf);

//<<i>Base-Sunny20091028[s01] end
Set_F81865_LD(0x06); //switch to logic device 6

//enable the GP5 group
ucBuf = Get_F81865_Reg(0x30);
ucBuf |= 0x01;
Set_F81865_Reg(0x30, ucBuf);

Set_F81865_Reg(0xA0, 0x00); //define as input mode
Set_F81865_Reg(0xA3, 0xFF); //push pull mode
}
//-----
void Dio5SetOutput(unsigned char NewData)
{
    Set_F81865_LD(0x06); //switch to logic device 6
    Set_F81865_Reg(0xA1, NewData);
}
//-----
unsigned char Dio5GetInput(void)
{
    unsigned char result;

    Set_F81865_LD(0x06); //switch to logic device 6
    result = Get_F81865_Reg(0xA2);
    return (result);
}
//-----
void Dio5SetDirection(unsigned char NewData)
{
    //NewData : 1 for input, 0 for output
    Set_F81865_LD(0x06); //switch to logic device 6
    Set_F81865_Reg(0xA0, NewData);
}
//-----
unsigned char Dio5GetDirection(void)
{
    unsigned char result;

    Set_F81865_LD(0x06); //switch to logic device 6
    result = Get_F81865_Reg(0xA0);
    return (result);
}
//-----
```