

# **KH960-CM238/QM175/HM175**

## **COM Express Basic Module**

### **User's Manual**

## Copyright

This publication contains information that is protected by copyright. No part of it may be reproduced in any form or by any means or used to make any transformation/adaptation without the prior written permission from the copyright holders.

This publication is provided for informational purposes only. The manufacturer makes no representations or warranties with respect to the contents or use of this manual and specifically disclaims any express or implied warranties of merchantability or fitness for any particular purpose. The user will assume the entire risk of the use or the results of the use of this document. Further, the manufacturer reserves the right to revise this publication and make changes to its contents at any time, without obligation to notify any person or entity of such revisions or changes.

Changes after the publication's first release will be based on the product's revision. The website will always provide the most updated information.

© 2017. All Rights Reserved.

## Trademarks

Product names or trademarks appearing in this manual are for identification purpose only and are the properties of the respective owners.

## COM Express Specification Reference

PICMG® COM Express Module™ Base Specification.

<http://www.picmg.org/>

## FCC and DOC Statement on Class B

This equipment has been tested and found to comply with the limits for a Class B digital device, pursuant to Part 15 of the FCC rules. These limits are designed to provide reasonable protection against harmful interference when the equipment is operated in a residential installation. This equipment generates, uses and can radiate radio frequency energy and, if not installed and used in accordance with the instruction manual, may cause harmful interference to radio communications. However, there is no guarantee that interference will not occur in a particular installation. If this equipment does cause harmful interference to radio or television reception, which can be determined by turning the equipment off and on, the user is encouraged to try to correct the interference by one or more of the following measures:

- Reorient or relocate the receiving antenna.
- Increase the separation between the equipment and the receiver.
- Connect the equipment into an outlet on a circuit different from that to which the receiver is connected.
- Consult the dealer or an experienced radio TV technician for help.

## Notice:

1. The changes or modifications not expressly approved by the party responsible for compliance could void the user's authority to operate the equipment.
2. Shielded interface cables must be used in order to comply with the emission limits.

## Table of Contents

Copyright.....	2	Mechanical Diagram.....	11
Trademarks.....	2	System Memory.....	12
COM Express Specification Reference.....	2	Connectors.....	13
FCC and DOC Statement on Class B.....	2	CPU Fan Connector.....	13
About this Manual.....	4	COM Express Connectors.....	14
Warranty.....	4	COM Express Connectors Signals and Descriptions.....	16
Static Electricity Precautions.....	4	Standby Power LED.....	30
Safety Measures.....	4	Cooling Option.....	30
About the Package.....	5	<b>Chapter 4 - BIOS Setup.....</b>	<b>33</b>
Optional Items.....	5	Overview.....	33
Before Using the System Board.....	5	Insyde BIOS Setup Utility.....	34
Chapter 1 - Introduction.....	6	Main.....	34
Specifications.....	6	Advanced.....	34
Features.....	7	Security.....	43
Chapter 2 - Concept.....	8	Boot.....	44
COM Express Module Standards.....	8	Exit.....	46
Specification Comparison Table.....	9	<b>Chapter 5 - Supported Software.....</b>	<b>48</b>
Chapter 3 - Hardware Installation.....	10	<b>Chapter 6 - RAID.....</b>	<b>57</b>
Board Layout.....	10	<b>Chapter 7 - Intel AMT Settings.....</b>	<b>61</b>
Block Diagram.....	10	<b>Appendix A - Troubleshooting.....</b>	<b>75</b>
		<b>Appendix B - Insyde BIOS Standard Status POST Code</b>	<b>77</b>

## About this Manual

An electronic file of this manual is included in the DVD. To view the user's manual in the DVD, insert the DVD into a DVD-ROM drive. The autorun screen (Main Board Utility DVD) will appear. Click "User's Manual" on the main menu.

## Warranty

1. Warranty does not cover damages or failures that arised from misuse of the product, inability to use the product, unauthorized replacement or alteration of components and product specifications.
2. The warranty is void if the product has been subjected to physical abuse, improper installation, modification, accidents or unauthorized repair of the product.
3. Unless otherwise instructed in this user's manual, the user may not, under any circumstances, attempt to perform service, adjustments or repairs on the product, whether in or out of warranty. It must be returned to the purchase point, factory or authorized service agency for all such work.
4. We will not be liable for any indirect, special, incidental or consequential damages to the product that has been modified or altered.

## Static Electricity Precautions

It is quite easy to inadvertently damage your PC, system board, components or devices even before installing them in your system unit. Static electrical discharge can damage computer components without causing any signs of physical damage. You must take extra care in handling them to ensure against electrostatic build-up.

1. To prevent electrostatic build-up, leave the system board in its anti-static bag until you are ready to install it.
2. Wear an antistatic wrist strap.
3. Do all preparation work on a static-free surface.
4. Hold the device only by its edges. Be careful not to touch any of the components, contacts or connections.
5. Avoid touching the pins or contacts on all modules and connectors. Hold modules or connectors by their ends.



### Important:

Electrostatic discharge (ESD) can damage your processor, disk drive and other components. Perform the upgrade instruction procedures described at an ESD workstation only. If such a station is not available, you can provide some ESD protection by wearing an antistatic wrist strap and attaching it to a metal part of the system chassis. If a wrist strap is unavailable, establish and maintain contact with the system chassis throughout any procedures requiring ESD protection.

## Safety Measures

To avoid damage to the system:

- Use the correct AC input voltage range.

To reduce the risk of electric shock:

- Unplug the power cord before removing the system chassis cover for installation or servicing. After installation or servicing, cover the system chassis before plugging the power cord.

## About the Package

The package contains the following items. If any of these items are missing or damaged, please contact your dealer or sales representative for assistance.

- One KH960 board
- One DVD
- One Cooler (Height: 36.58mm)

## Optional Items

- COM332-B carrier board kit
- Heat spreader (Height: 11mm)

The board and accessories in the package may not come similar to the information listed above. This may differ in accordance with the sales region or models in which it was sold. For more information about the standard package in your region, please contact your dealer or sales representative.

## Before Using the System Board

Before using the system board, prepare basic system components.

If you are installing the system board in a new system, you will need at least the following internal components.

- Memory module
- Storage devices such as hard disk drive, CD-ROM, etc.

You will also need external system peripherals you intend to use which will normally include at least a keyboard, a mouse and a video display monitor.

## Chapter 1 - Introduction

### Specifications

<b>System</b>	Processor	7th Generation Intel® Core™ Processors, BGA 1440 Intel® Xeon® E3-1505M v6 Processor, Quad Core, 8M Cache, 3.0GHz (4.0GHz), 45W* Intel® Xeon® E3-1505L v6 Processor, Quad Core, 8M Cache, 2.2GHz (3.0GHz), 25W* Intel® Core™ i7-7820EQ Processor, Quad Core, 8M Cache, 3.0GHz (3.7GHz), 45W Intel® Core™ i5-7440EQ Processor, Quad Core, 6M Cache, 2.9GHz (3.6GHz), 45W Intel® Core™ i5-7442EQ Processor, Quad Core, 6M Cache, 2.1GHz (2.9GHz), 25W Intel® Core™ i3-7100E Processor, Dual Core, 3M Cache, 2.9GHz, 35W Intel® Core™ i3-7102E Processor, Dual Core, 3M Cache, 2.1GHz, 25W
	Chipset	Intel® CM238/Intel® QM175/Intel® HM175 Chipset
	Memory	Two 260-pin SODIMM up to 32GB Dual Channel DDR4 2400MHz (The maximum memory speed supported differs by SKU.)
	BIOS	Insyde SPI 128Mbit
	<b>Graphics</b>	Controller
	Feature	OpenGL up to 5.0, DirectX 11, OpenCL 2.1 HW Decode: HEVC/H.265, H.264, M/JPEG, MPEG2, VC1/WMV9, VP8 (8-bit), VP9 (10-bit) HW Encode: HEVC/H.265, M/JPEG, MPEG2, VP8
	Display	1 x VGA/DDI3 (DDI3 available upon request) 1 x LVDS/eDP (eDP available upon request) 2 x DDI (HDMI/DVI/DP++) VGA: resolution up to 2560x1600 @ 60Hz LVDS: dual channel 24-bit, resolution up to 1920x1200 @ 60Hz HDMI: resolution up to 4096x2160 @ 30Hz, 24bpp DVI: resolution up to 1920x1200 @ 60Hz DP++/eDP: resolution up to 4096x2304 @ 60Hz, 24bpp
	Triple Displays	VGA+LVDS+DDI or VGA+ DDI1+DDI2 eDP + 2 x DDI (or 3 x DDI available upon request)
<b>Expansion</b>	Interface	1 x PCIe x16 (or 2 x PCIe x8 upon request) (Gen 3) 8 x PCIe x1 (or 2 x PCIe x4 or 4 x PCIe x2 upon request) (Gen 3) 1 x LPC 1 x I <sup>2</sup> C 1 x SMBus 2 x UART (TX/RX)

<b>Audio</b>	Interface	HD Audio
<b>Ethernet</b>	Controller	1 x Intel® I219LM PCIe with iAMT (10/100/1000Mbps)†
<b>I/O</b>	USB	4 x USB 3.0 8 x USB 2.0
	SATA	4 x SATA 3.0 (up to 6Gb/s); capable of RAID configuration of 0, 1, 5, 10
	DIO	1 x 8-bit DIO (default 4 inputs and 4 outputs)
<b>WatchDog Timer</b>	Output & Interval	System Reset, Programmable via Software from 1 to 255 Seconds
<b>Security</b>	TPM	Available Upon Request
<b>Power</b>	Type	12V, 5VSB, VCC_RTC (ATX mode) 12V, VCC_RTC (AT mode)
<b>OS Support</b>		Windows: Windows 10 IoT Enterprise 64-bit Linux: Yocto Project v2.2
<b>Environment</b>	Temperature	Operating : 0 to 60°C : -40 to 85°C (with heat spreader) Storage: -40 to 85°C
	Humidity	Operating: 5 to 90% RH Storage: 5 to 90% RH
	MTBF	TBD
<b>Mechanical</b>	Dimensions	COM Express® Basic 95mm (3.74") x 125mm (4.9")
	Compliance	PICMG COM Express® R2.1, Type 6

\* Intel® Xeon® E3-1505M/1505L v6 can only be paired with the Intel® CM238 Chipset.

† Intel Active Management Technology (Intel® AMT) is not available on Core™ i3 processors or HM175 chipset.

## Features

### • Watchdog Timer

The Watchdog Timer function allows your application to regularly “clear” the system at the set time interval. If the system hangs or fails to function, it will reset at the set time interval so that your system will continue to operate.

### • DDR4

DDR4 delivers increased system bandwidth and improves performance. The advantages of DDR4 provide an extended battery life and improve the performance at a lower power than DDR3/DDR2.

### • Graphics

The integrated Intel® HD Graphics 630 engine delivers an excellent blend of graphics performance and features to meet business needs. It delivers enhanced media conversion rates and higher frame rates on 4K Ultra HD videos. These enhancements deliver the performance and compatibility to meet the demand for business and home entertainment applications. The system supports VGA, LVDS (or eDP) and DDI (HDMI/DVI/DP++) display outputs.

### • Serial ATA

Serial ATA is a storage interface that is compliant with SATA 1.0a specification. With speed of up to 6Gb/s (SATA 3.0), it improves hard drive performance faster than the standard parallel ATA whose data transfer rate is 100MB/s. However, the bandwidth of the SATA 3.0 will be limited by carrier board design.

### • Gigabit LAN

The Intel® I219LM Gigabit LAN PHY controller features up to 1Gbps data transmission with support for Intel® Active Management Technology. It provides remote maintenance and manageability for networked computing assets in an enterprise environment.

### • USB

The system board supports the new USB 3.0. It is capable of running at a maximum transmission speed of up to 5 Gbit/s (625 MB/s) and is faster than USB 2.0 (480 Mbit/s, or 60 MB/s) and USB 1.1 (12Mb/s). USB 3.0 reduces the time required for data transmission, reduces power consumption, and is backward compatible with USB 2.0. It is a marked improvement in device transfer speeds between your computer and a wide range of simultaneously accessible external Plug and Play peripherals.

### • Intel® Rapid Storage Technology

With a newer release of the Intel Rapid Storage Technology software, the system offers better performance and responsiveness. New features such as Smart Response Technology and Dynamic Storage Accelerator maximize the utilization of the SSD cache acceleration in your system.

### • Intel Turbo Boost 2.0

With the new Intel Turbo Boost Technology 2.0, the system shows better power efficiency when the processor's frequency is dynamically increased to provide better performance state using this technology.

### • PCI Express Revision 3.0

The 3 chipsets offered by the model all support PCIe Gen 3 data transfer rates of 8 GT/s, higher than PCIe Gen 2 speeds of 5 GT/s and providing faster access to expansion cards and networking.

## Chapter 2 - Concept

### COM Express Module Standards

The figure below shows the dimensions of the different types of COM Express modules.

KH960 is a COM Express Basic module. Its dimension is 95mm x 125mm.

- ⊙ Common for all Form Factors
- Extended only
- Basic only
- ⌚ Compact only
- ⌚ Compact and Basic only
- ⌚ Mini only

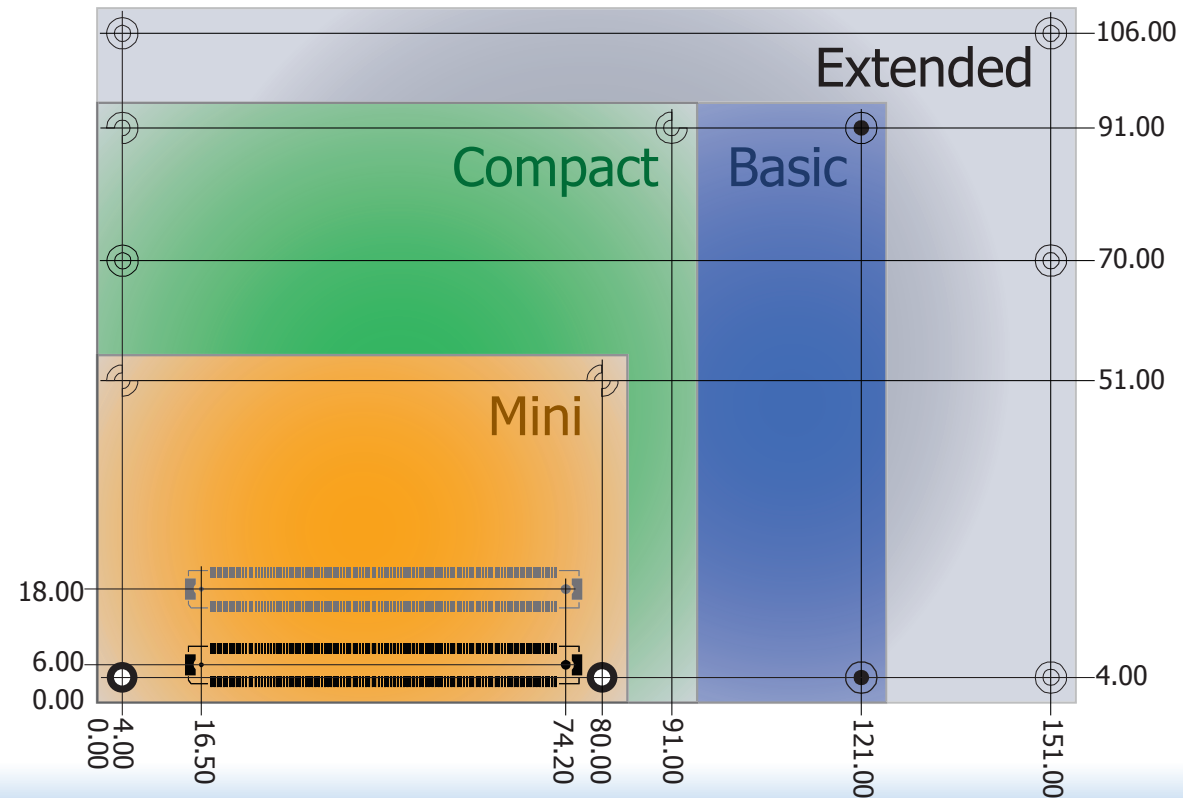



## Specification Comparison Table

The table below shows the COM Express standard specifications and the corresponding specifications supported on the KH960 module.

Module Pin-out - Required and Optional Features A-B Connector.

Connector	Feature	COM Express Module Base Specification Type 6 (No IDE or PCI, add DDI+ USB3) Min / Max	DFI KH960 Type 6
A-B	<b>System I/O</b>		
A-B	PCI Express Lanes 0 - 5	1 / 6	6
A-B	LVDS Channel A	0 / 1	1
A-B	LVDS Channel B	0 / 1	1
A-B	eDP on LVDS CH A pins	0 / 1	1
A-B	VGA Port	0 / 1	1
A-B	TV-Out	NA	NA
A-B	DDI 0	NA	NA
A-B <sup>5</sup>	Serial Ports 1 - 2	0 / 2	2
A-B	CAN interface on SER1	0 / 1	0
A-B	SATA / SAS Ports	1 / 4	4
A-B	AC'97 / HDA Digital Interface	0 / 1	1
A-B	USB 2.0 Ports	4 / 8	8
A-B	USB Client	0 / 1	0
A-B	USB 3.0 Ports	NA	NA
A-B	LAN Port 0	1 / 1	1
A-B	Express Card Support	1 / 2	2
A-B	LPC Bus	1 / 1	1
A-B	SPI	1 / 2	1
A-B	<b>System Management</b>		
A-B <sup>6</sup>	SDIO (muxed on GPIO)	0 / 1	NA
A-B <sup>6</sup>	General Purpose I/O	8 / 8	8
A-B	SMBus	1 / 1	1
A-B	I2C	1 / 1	1
A-B	Watchdog Timer	0 / 1	1
A-B	Speaker Out	1 / 1	1
A-B	External BIOS ROM Support	0 / 2	1
A-B	Reset Functions	1 / 1	1

- <sup>5</sup> Indicates 12V-tolerant features on former VCC\_12V signals.
- <sup>6</sup> Cells in the connected columns spanning rows provide a rough approximation of features sharing connector pins.

Connector	Feature	COM Express Module Base Specification Type 6 (No IDE or PCI, add DDI+ USB3) Min / Max	DFI KH960 Type 6
A-B	<b>Power Management</b>		
A-B	Thermal Protection	0 / 1	1
A-B	Battery Low Alarm	0 / 1	1
A-B	Suspend/Wake Signals	0 / 3	2
A-B	Power Button Support	1 / 1	1
A-B	Power Good	1 / 1	1
A-B	VCC_5V_SBY Contacts	4 / 4	4
A-B <sup>5</sup>	Sleep Input	0 / 1	1
A-B <sup>5</sup>	Lid Input	0 / 1	1
A-B <sup>5</sup>	Fan Control Signals	0 / 2	1
A-B	Trusted Platform Modules	0 / 1	1 (optional)
A-B	<b>Power</b>		
A-B	VCC_12V Contacts	12 / 12	12

Module Pin-out - Required and Optional Features C-D Connector.

Connector	Feature	COM Express Module Base Specification Type 6 (No IDE or PCI, add DDI+ USB3) Min / Max	DFI KH960 Type 6
C-D	<b>System I/O</b>		
C-D	PCI Express Lanes 16 - 31	0 / 16	16
C-D	PCI Express Graphics (PEG)	0 / 1	1
C-D <sup>6</sup>	Muxed SDVO Channels 1 - 2	NA	NA
C-D	PCI Express Lanes 6 - 15	0 / 2	2
C-D	PCI Bus - 32 Bit	NA	NA
C-D	PATA Port	NA	NA
C-D	LAN Ports 1 - 2	NA	NA
C-D	DDIs 1 - 3	0 / 3	3 (DDI3 option)
C-D <sup>6</sup>	USB 3.0 Ports	0 / 4	4
C-D	<b>Power</b>		
C-D	VCC_12V Contacts	12 / 12	12

# Chapter 3 - Hardware Installation

## Board Layout

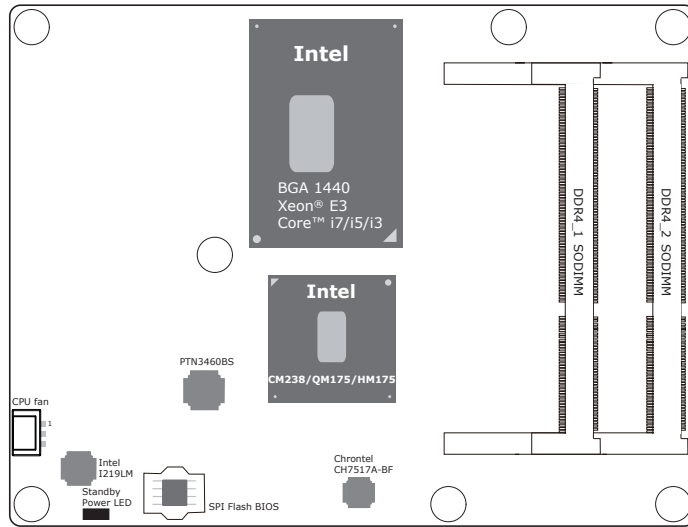

Top View

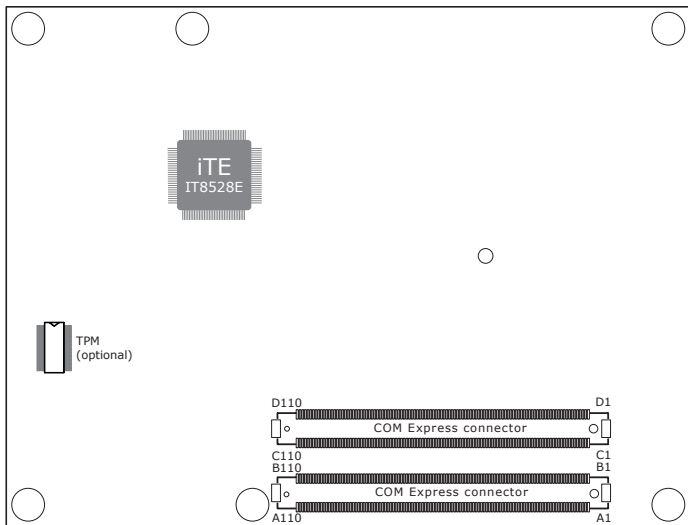

Bottom View

## Block Diagram

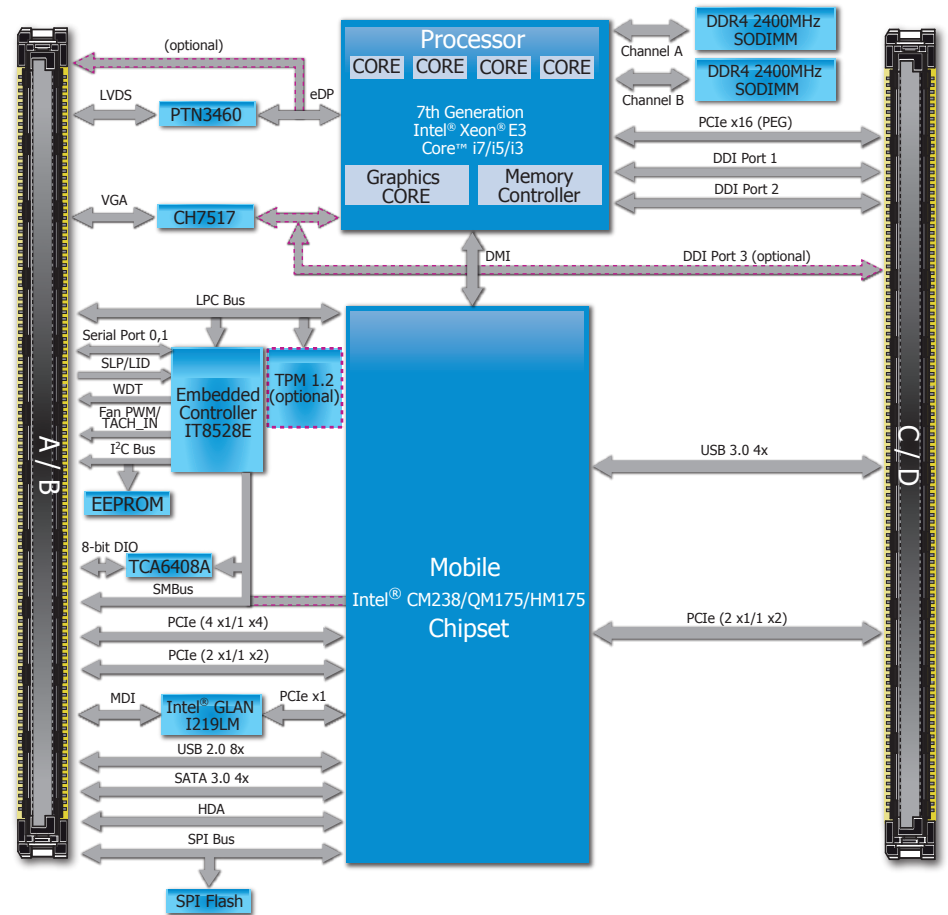

# Mechanical Diagram

Heat Sink and Fan

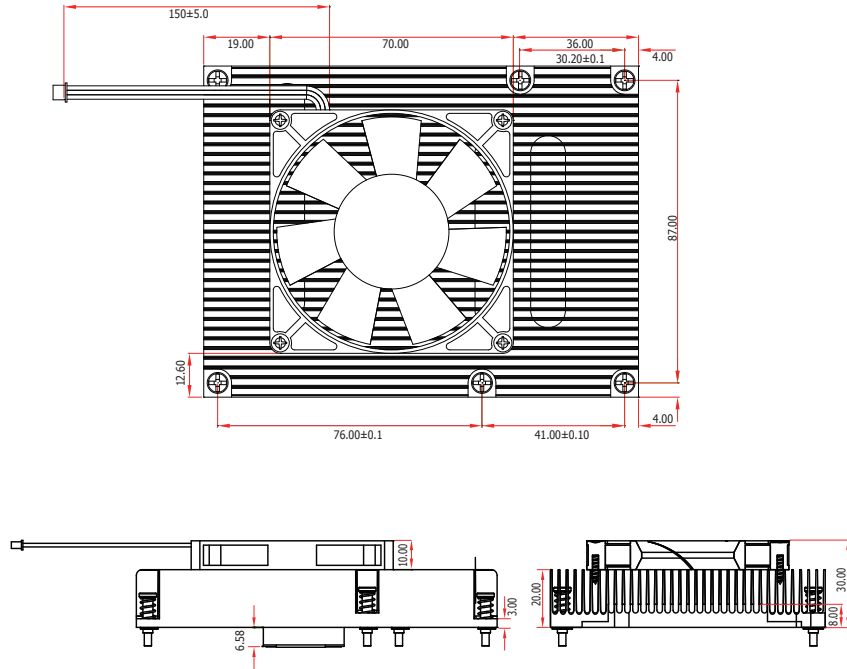

KH960

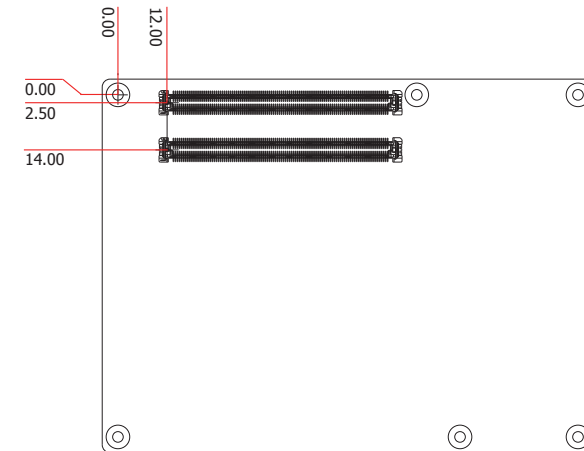
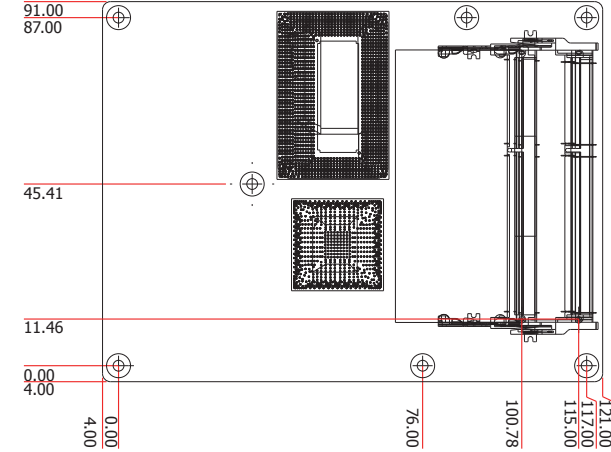

**Important:**

Electrostatic discharge (ESD) can damage your board, processor, disk drives, add-in boards, and other components. Perform installation procedures at an ESD workstation only. If such a station is not available, you can provide some ESD protection by wearing an antistatic wrist strap and attaching it to a metal part of the system chassis. If a wrist strap is unavailable, establish and maintain contact with the system chassis throughout any procedures requiring ESD protection.

## System Memory

The system board is equipped with two 260-pin SODIMM sockets that support non-ECC DDR4 memory modules.

**Important:**

When the Standby Power LED is red, it indicates that there is power on the board. Power off the PC then unplug the power cord prior to installing any devices. Failure to do so will cause severe damage to the board and components.

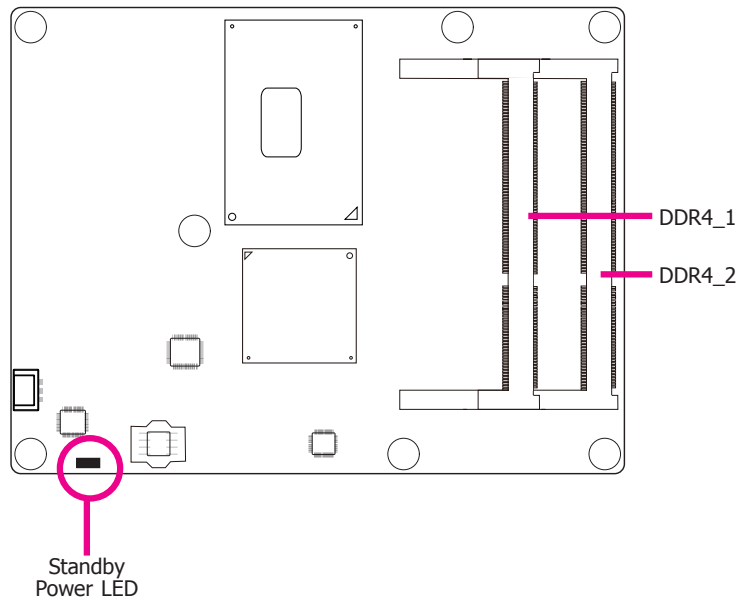

## Installing the DIMM Module

**Note:**

The system board used in the following illustrations may not resemble the actual one. These illustrations are for reference only.

1. Check to see if the module is a non-ECC DDR4 SODIMM module.
2. Make sure the PC and all other peripheral devices connected to it has been powered down.
3. Disconnect all power cords and cables.
4. Locate the SODIMM socket on the system board.
5. Note the key on the socket. The key ensures that the module can be plugged into the socket in only one direction.

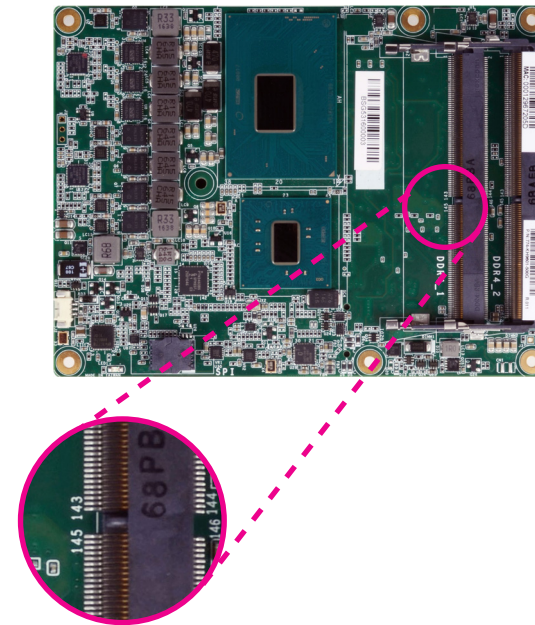

- Grasp the module by its edges and align the memory module key with the memory socket key. Grasp the module by its edges and align the memory's notch with the socket's notch; then insert the memory into the socket at an angle and push it down until you feel a click.

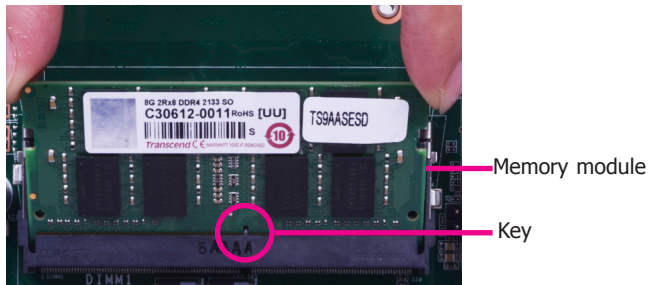

## Connectors

### CPU Fan Connector

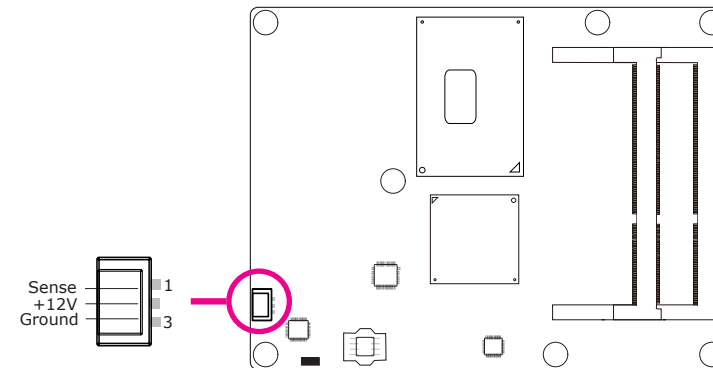

Connect the CPU fan's cable connector to the CPU fan connector on the board. The cooling fan will provide adequate airflow throughout the chassis to prevent overheating the CPU and board components.

### BIOS Setting

The "Super IO Configuration" submenu in the Advanced menu of the BIOS will display the current speed of the cooling fan. Refer to chapter 4 for more information.

## COM Express Connectors

The COM Express connectors are used to interface the KH960 COM Express board to a carrier board. Connect the COM Express connectors (located on the solder side of the board) to the COM Express connectors on the carrier board.

Refer to the "Installing KH960 onto a Carrier Board" section for more information.

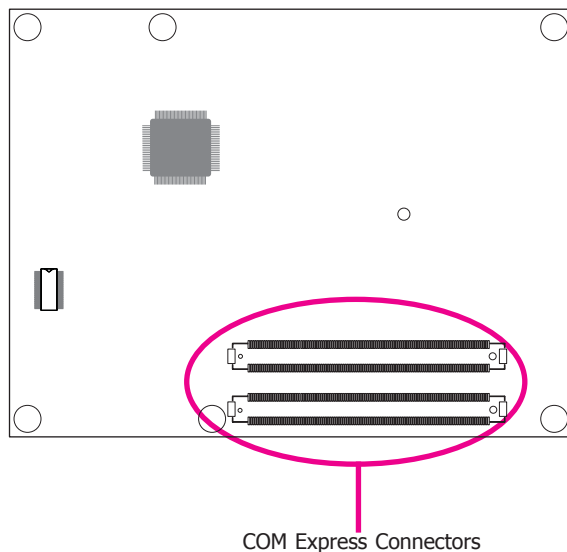

Refer to the following pages for the pin functions of these connectors.

Pin	Row A	Row B	Row C	Row D
1	GND(FIXED)	GND(FIXED)	GND(FIXED)	GND(FIXED)
2	GBE0_MDI3-	GBE0_ACT#	GND	GND
3	GBE0_MDI3+	LPC_FRAME#	USB_SSRX0-	USB_SSTX0-
4	GBE0_LINK100#	LPC_AD0	USB_SSRX0+	USB_SSTX0+
5	GBE0_LINK1000#	LPC_AD1	GND	GND
6	GBE0_MDI2-	LPC_AD2	USB_SSRX1-	USB_SSTX1-
7	GBE0_MDI2+	LPC_AD3	USB_SSRX1+	USB_SSTX1+
8	GBE0_LINK#	LPC_DRQ0#	GND	GND
9	GBE0_MDI1-	LPC_DRQ1#	USB_SSRX2-	USB_SSTX2-
10	GBE0_MDI1+	LPC_CLK	USB_SSRX2+	USB_SSTX2+
11	GND(FIXED)	GND(FIXED)	GND(FIXED)	GND(FIXED)
12	GBE0_MDI0-	PWRBTN#	USB_SSRX3-	USB_SSTX3-
13	GBE0_MDI0+	SMB_CK	USB_SSRX3+	USB_SSTX3+
14	GBE0_CTREF	SMB_DAT	GND	GND
15	SUS_S3#	SMB_ALERT#	DDI1_PAIR6+	DDI1_CTRLCLK_AUX+
16	SATA0_TX+	SATA1_TX+	DDI1_PAIR6-	DDI1_CTRLCLK_AUX-
17	SATA0_TX-	SATA1_TX-	RSVD <sup>19</sup>	RSVD <sup>19</sup>
18	SUS_S4#	SUS_STAT#	RSVD <sup>19</sup>	RSVD <sup>19</sup>
19	SATA0_RX+	SATA1_RX+	PCIE_RX6+	PCIE_TX6+
20	SATA0_RX-	SATA1_RX-	PCIE_RX6-	PCIE_TX6-
21	GND(FIXED)	GND(FIXED)	GND(FIXED)	GND(FIXED)
22	SATA2_TX+	SATA3_TX+	PCIE_RX7+	PCIE_TX7+
23	SATA2_TX-	SATA3_TX-	PCIE_RX7-	PCIE_TX7-
24	SUS_S5#	PWR_OK	DDI1_HPD	RSVD <sup>19</sup>
25	SATA2_RX+	SATA3_RX+	DDI1_PAIR4+	RSVD <sup>19</sup>
26	SATA2_RX-	SATA3_RX-	DDI1_PAIR4-	DDI1_PAIR0+
27	BATLOW#	WDT	RSVD <sup>19</sup>	DDI1_PAIR0-
28	(S)ATA_ACT#	AC/HDA_SDIN2	RSVD <sup>19</sup>	RSVD <sup>19</sup>
29	AC/HDA_SYNC	AC/HDA_SDIN1	DDI1_PAIR5+	DDI1_PAIR1+
30	AC/HDA_RST#	AC/HDA_SDIN0	DDI1_PAIR5-	DDI1_PAIR1-
31	GND(FIXED)	GND(FIXED)	GND(FIXED)	GND(FIXED)
32	AC/HDA_BITCLK	SPKR	DDI2_CTRLCLK_AUX+	DDI1_PAIR2+
33	AC/HDA_SDOOUT	I2C_CK	DDI2_CTRLCLK_AUX-	DDI1_PAIR2-
34	BIOS_DIS0#	I2C_DAT	DDI2_DDC_AUX_SEL	DDI1_DDC_AUX_SEL
35	THRMTRIP#	THRM#	RSVD <sup>19</sup>	RSVD <sup>19</sup>
36	USB6-	USB7-	DDI3_CTRLCLK_AUX+	DDI1_PAIR3+
37	USB6+	USB7+	DDI3_CTRLCLK_AUX-	DDI1_PAIR3-
38	USB_6_7_OC#	USB_4_5_OC#	DDI3_DDC_AUX_SEL	RSVD <sup>19</sup>
39	USB4-	USB5-	DDI3_PAIR0+	DDI2_PAIR0+
40	USB4+	USB5+	DDI3_PAIR0-	DDI2_PAIR0-
41	GND(FIXED)	GND(FIXED)	GND(FIXED)	GND(FIXED)

## COM Express Connectors-Continued

Pin	Row A	Row B	Row C	Row D
42	USB2-	USB3-	DDI3 PAIR1+	DDI2 PAIR1+
43	USB2+	USB3+	DDI3 PAIR1-	DDI2 PAIR1-
44	USB 2 3 OC#	USB 0 1 OC#	DDI3 HPD	DDI2 HPD
45	USB0-	USB1-	RSVD <sup>19</sup>	RSVD <sup>19</sup>
46	USB0+	USB1+	DDI3 PAIR2+	DDI2 PAIR2+
47	VCC_RTC	EXCD1_PERST#	DDI3 PAIR2-	DDI2 PAIR2-
48	EXCD0_PERST#	EXCD1_CPPE#	RSVD <sup>19</sup>	RSVD <sup>19</sup>
49	EXCD0_CPPE#	SYS RESET#	DDI3 PAIR3+	DDI2 PAIR3+
50	LPC_SERIRQ	CB_RESET#	DDI3 PAIR3-	DDI2 PAIR3-
51	GND(FIXED)	GND(FIXED)	GND(FIXED)	GND(FIXED)
52	PCIE_TX5+	PCIE_RX5+	PEG_RX0+	PEG_TX0+
53	PCIE_TX5-	PCIE_RX5-	PEG_RX0-	PEG_TX0-
54	GPI0	GPO1	TYPE0#	PEG_LANE RV#
55	PCIE_TX4+	PCIE_RX4+	PEG_RX1+	PEG_TX1+
56	PCIE_TX4-	PCIE_RX4-	PEG_RX1-	PEG_TX1-
57	GND	GPO2	TYPE1#	TYPE2#
58	PCIE_TX3+	PCIE_RX3+	PEG_RX2+	PEG_TX2+
59	PCIE_TX3-	PCIE_RX3-	PEG_RX2-	PEG_TX2-
60	GND(FIXED)	GND(FIXED)	GND(FIXED)	GND(FIXED)
61	PCIE_TX2+	PCIE_RX2+	PEG_RX3+	PEG_TX3+
62	PCIE_TX2-	PCIE_RX2-	PEG_RX3-	PEG_TX3-
63	GPI1	GPO3	RSVD <sup>19</sup>	RSVD <sup>19</sup>
64	PCIE_TX1+	PCIE_RX1+	RSVD <sup>19</sup>	RSVD <sup>19</sup>
65	PCIE_TX1-	PCIE_RX1-	PEG_RX4+	PEG_TX4+
66	GND	WAKE0#	PEG_RX4-	PEG_TX4-
67	GPI2	WAKE1#	RSVD <sup>19</sup>	GND
68	PCIE_TX0+	PCIE_RX0+	PEG_RX5+	PEG_TX5+
69	PCIE_TX0-	PCIE_RX0-	PEG_RX5-	PEG_TX5-
70	GND(FIXED)	GND(FIXED)	GND(FIXED)	GND(FIXED)
71	LVDS A0+	LVDS B0+	PEG_RX6+	PEG_TX6+
72	LVDS A0-	LVDS B0-	PEG_RX6-	PEG_TX6-
73	LVDS A1+	LVDS B1+	GND	GND
74	LVDS A1-	LVDS B1-	PEG_RX7+	PEG_TX7+
75	LVDS A2+	LVDS B2+	PEG_RX7-	PEG_TX7-
76	LVDS A2-	LVDS B2-	GND	GND
77	LVDS VDD_EN	LVDS B3+	RSVD <sup>19</sup>	RSVD <sup>19</sup>
78	LVDS A3+	LVDS B3-	PEG_RX8+	PEG_TX8+
79	LVDS A3-	LVDS BKLT_EN	PEG_RX8-	PEG_TX8-
80	GND(FIXED)	GND(FIXED)	GND(FIXED)	GND(FIXED)
81	LVDS A CK+	LVDS B CK+	PEG_RX9+	PEG_TX9+
82	LVDS A CK-	LVDS B CK-	PEG_RX9-	PEG_TX9-
83	LVDS I2C CK	LVDS BKLT_CTRL	RSVD <sup>19</sup>	RSVD <sup>19</sup>
84	LVDS I2C DAT	VCC 5V_SBY	GND	GND
85	GPI3	VCC 5V_SBY	PEG_RX10+	PEG_TX10+
86	RSVD <sup>19</sup>	VCC 5V_SBY	PEG_RX10-	PEG_TX10-
87	eDP_HPDP	VCC 5V_SBY	GND	GND
88	PCIE_CLK_REF+	BIOS_DIS1#	PEG_RX11+	PEG_TX11+
89	PCIE_CLK_REF-	VGA_RED	PEG_RX11-	PEG_TX11-
90	GND(FIXED)	GND(FIXED)	GND(FIXED)	GND(FIXED)

Pin	Row A	Row B	Row C	Row D
91	SPI_POWER	VGA GRN	PEG_RX12+	PEG_TX12+
92	SPI_MISO	VGA BLU	PEG_RX12-	PEG_TX12-
93	GPO0	VGA_HSYNC	GND	GND
94	SPI_CLK	VGA_VSYNC	PEG_RX13+	PEG_TX13+
95	SPI_MOSI	VGA_I2C_CK	PEG_RX13-	PEG_TX13-
96	TPM_PP	VGA_I2C_DAT	GND	GND
97	TYPE10#	SPI_CS#	RSVD <sup>19</sup>	RSVD <sup>19</sup>
98	SER0_TX	RSVD <sup>19</sup>	PEG_RX14+	PEG_TX14+
99	SER0_RX	RSVD <sup>19</sup>	PEG_RX14-	PEG_TX14-
100	GND(FIXED)	GND(FIXED)	GND(FIXED)	GND(FIXED)
101	SER1_TX	FAN_PWMOUT	PEG_RX15+	PEG_TX15+
102	SER1_RX	FAN_TACHIN	PEG_RX15-	PEG_TX15-
103	LID#	SLEEP#	GND	GND
104	VCC_12V	VCC_12V	VCC_12V	VCC_12V
105	VCC_12V	VCC_12V	VCC_12V	VCC_12V
106	VCC_12V	VCC_12V	VCC_12V	VCC_12V
107	VCC_12V	VCC_12V	VCC_12V	VCC_12V
108	VCC_12V	VCC_12V	VCC_12V	VCC_12V
109	VCC_12V	VCC_12V	VCC_12V	VCC_12V
110	GND(FIXED)	GND(FIXED)	GND(FIXED)	GND(FIXED)

## COM Express Connectors Signals and Descriptions

Pin Types I Input to the Module O Output from the Module I/O Bi-directional input / output signal OD Open drain output RSVD pins are reserved for future use and should be no connect. Do not tie the RSVD pins together.
------------------------------------------------------------------------------------------------------------------------------------------------------------------------------------------------------------------------------------------

## AC97/HDA Signals and Descriptions

Signal	Pin#	Pin Type	Pwr Rail /Tolerance	KH960 PU/PD	Module Base Specification R2.1 Description	COM Express Carrier Design Guide R2.0 Description
AC/HDA_RST#	A30	O CMOS	3.3V Suspend/3.3V	series 33Ω resistor	Reset output to CODEC, active low.	CODEC Reset.
AC/HDA_SYNC	A29	O CMOS	3.3V/3.3V	series 33Ω resistor	Sample-synchronization signal to the CODEC(s).	Serial Sample Rate Synchronization.
AC/HDA_BITCLK	A32	I/O CMOS	3.3V/3.3V	series 33Ω resistor	Serial data clock generated by the external CODEC(s).	24 MHz Serial Bit Clock for HDA CODEC.
AC/HDA_SDOUT	A33	O CMOS	3.3V/3.3V	series 33Ω resistor	Serial TDM data output to the CODEC.	Audio Serial Data Output Stream.
AC/HDA_SDIN0	B30	I/O CMOS	3.3V Suspend/3.3V		Serial TDM data inputs from up to 3 CODECs.	Audio Serial Data Input Stream from CODEC[0:2].
AC/HDA_SDIN1	B29	I/O CMOS	3.3V Suspend/3.3V			
AC/HDA_SDIN2	B28	I/O CMOS	3.3V Suspend/3.3V	NC		

## Gigabit Ethernet Signals and Descriptions

Signal	Pin#	Pin Type	Pwr Rail /Tolerance	KH960 PU/PD	Module Base Specification R2.1 Description	COM Express Carrier Design Guide R2.0 Description
GBE0_MDI0+	A13	I/O Analog	3.3V max Suspend		Gigabit Ethernet Controller 0: Media Dependent Interface Differential Pairs 0,1,2,3. The MDI can operate in 1000, 100 and 10 Mbit / sec modes. Some pairs are unused in some modes, per the following: 1000BASE-T 100BASE-TX 10BASE-T MDI[0]+/- B1_DA+/- TX+/- TX+/- MDI[1]+/- B1_DB+/- RX+/- RX+/- MDI[2]+/- B1_DC+/- MDI[3]+/- B1_DD+/-	Media Dependent Interface (MDI) differential pair 0.
GBE0_MDI0-	A12	I/O Analog	3.3V max Suspend			Media Dependent Interface (MDI) differential pair 1.
GBE0_MDI1+	A10	I/O Analog	3.3V max Suspend			Media Dependent Interface (MDI) differential pair 2. Only used for 1000Mbit/sec Gigabit Ethernet mode.
GBE0_MDI1-	A9	I/O Analog	3.3V max Suspend			Media Dependent Interface (MDI) differential pair 3. Only used for 1000Mbit/sec Gigabit Ethernet mode.
GBE0_MDI2+	A7	I/O Analog	3.3V max Suspend			
GBE0_MDI2-	A6	I/O Analog	3.3V max Suspend			
GBE0_MDI3+	A3	I/O Analog	3.3V max Suspend			
GBE0_MDI3-	A2	I/O Analog	3.3V max Suspend			
GBE0_ACT#	B2	OD CMOS	3.3V Suspend/3.3V		Gigabit Ethernet Controller 0 activity indicator, active low.	Ethernet controller 0 activity indicator, active low.
GBE0_LINK#	A8	OD CMOS	3.3V Suspend/3.3V		Gigabit Ethernet Controller 0 link indicator, active low.	Ethernet controller 0 link indicator, active low.
GBE0_LINK100#	A4	OD CMOS	3.3V Suspend/3.3V		Gigabit Ethernet Controller 0 100 Mbit / sec link indicator, active low.	Ethernet controller 0 100Mbit/sec link indicator, active low.
GBE0_LINK1000#	A5	OD CMOS	3.3V Suspend/3.3V		Gigabit Ethernet Controller 0 1000 Mbit / sec link indicator, active low.	Ethernet controller 0 1000Mbit/sec link indicator, active low.
GBE0_CTREF	A14	REF	GND min 3.3V max	NC	Reference voltage for Carrier Board Ethernet channel 0 magnetics center tap. The reference voltage is determined by the requirements of the Module PHY and may be as low as 0V and as high as 3.3V. The reference voltage output shall be current limited on the Module. I <sub>n</sub>	Reference voltage for Carrier Board Ethernet channel 0 magnetics center tap.



SATA Signals and Descriptions						
Signal	Pin#	Pin Type	Pwr Rail /Tolerance	KH960 PU/PD	Module Base Specification R2.1 Description	COM Express Carrier Design Guide R2.0 Description
SATA0_TX+	A16	O SATA	AC coupled on Module	AC Coupling capacitor	Serial ATA or SAS Channel 0 transmit differential pair.	Serial ATA channel 0 Transmit output differential pair.
SATA0_TX-	A17	O SATA	AC coupled on Module	AC Coupling capacitor		
SATA0_RX+	A19	I SATA	AC coupled on Module	AC Coupling capacitor	Serial ATA or SAS Channel 0 receive differential pair.	Serial ATA channel 0 Receive input differential pair.
SATA0_RX-	A20	I SATA	AC coupled on Module	AC Coupling capacitor		
SATA1_TX+	B16	O SATA	AC coupled on Module	AC Coupling capacitor	Serial ATA or SAS Channel 1 transmit differential pair.	Serial ATA channel 1 Transmit output differential pair.
SATA1_TX-	B17	O SATA	AC coupled on Module	AC Coupling capacitor		
SATA1_RX+	B19	I SATA	AC coupled on Module	AC Coupling capacitor	Serial ATA or SAS Channel 1 receive differential pair.	Serial ATA channel 1 Receive input differential pair.
SATA1_RX-	B20	I SATA	AC coupled on Module	AC Coupling capacitor		
SATA2_TX+	A22	O SATA	AC coupled on Module	AC Coupling capacitor	Serial ATA or SAS Channel 2 transmit differential pair.	Serial ATA channel 2 Transmit output differential pair.
SATA2_TX-	A23	O SATA	AC coupled on Module	AC Coupling capacitor		
SATA2_RX+	A25	I SATA	AC coupled on Module	AC Coupling capacitor	Serial ATA or SAS Channel 2 receive differential pair.	Serial ATA channel 2 Receive input differential pair.
SATA2_RX-	A26	I SATA	AC coupled on Module	AC Coupling capacitor		
SATA3_TX+	B22	O SATA	AC coupled on Module	AC Coupling capacitor	Serial ATA or SAS Channel 3 transmit differential pair.	Serial ATA channel 3 Transmit output differential pair.
SATA3_TX-	B23	O SATA	AC coupled on Module	AC Coupling capacitor		
SATA3_RX+	B25	I SATA	AC coupled on Module	AC Coupling capacitor	Serial ATA or SAS Channel 3 receive differential pair.	Serial ATA channel 3 Receive input differential pair.
SATA3_RX-	B26	I SATA	AC coupled on Module	AC Coupling capacitor		
(S)ATA_ACT#	A28	I/O CMOS	3.3V / 3.3V	PU 10KΩ to 3.3V	ATA (parallel and serial) or SAS activity indicator, active low.	Serial ATA activity LED. Open collector output pin driven during SATA command activity.

PCI Express Lanes Signals and Descriptions						
Signal	Pin#	Pin Type	Pwr Rail /Tolerance	KH960 PU/PD	Module Base Specification R2.1 Description	COM Express Carrier Design Guide R2.0 Description
PCIE_TX0+	A68	O PCIE	AC coupled on Module	AC Coupling capacitor	PCI Express Differential Transmit Pairs 0	PCIe channel 0. Transmit Output differential pair.
PCIE_TX0-	A69			AC Coupling capacitor		
PCIE_RX0+	B68	I PCIE	AC coupled off Module		PCI Express Differential Receive Pairs 0	PCIe channel 0. Receive Input differential pair.
PCIE_RX0-	B69					
PCIE_TX1+	A64	O PCIE	AC coupled on Module	AC Coupling capacitor	PCI Express Differential Transmit Pairs 1	PCIe channel 1. Transmit Output differential pair.
PCIE_TX1-	A65			AC Coupling capacitor		
PCIE_RX1+	B64	I PCIE	AC coupled off Module		PCI Express Differential Receive Pairs 1	PCIe channel 1. Receive Input differential pair.
PCIE_RX1-	B65					
PCIE_TX2+	A61	O PCIE	AC coupled on Module	AC Coupling capacitor	PCI Express Differential Transmit Pairs 2	PCIe channel 2. Transmit Output differential pair.
PCIE_TX2-	A62			AC Coupling capacitor		
PCIE_RX2+	B61	I PCIE	AC coupled off Module		PCI Express Differential Receive Pairs 2	PCIe channel 2. Receive Input differential pair.
PCIE_RX2-	B62					
PCIE_TX3+	A58	O PCIE	AC coupled on Module	AC Coupling capacitor	PCI Express Differential Transmit Pairs 3	PCIe channel 3. Transmit Output differential pair.
PCIE_TX3-	A59			AC Coupling capacitor		

PCI Express Lanes Signals and Descriptions						
PCIE_RX3+	B58	I PCIE	AC coupled off Module		PCI Express Differential Receive Pairs 3	PCIe channel 3. Receive Input differential pair.
PCIE_RX3-	B59					
PCIE_TX4+	A55	O PCIE	AC coupled on Module	AC Coupling capacitor	PCI Express Differential Transmit Pairs 4	PCIe channel 4. Transmit Output differential pair.
PCIE_TX4-	A56			AC Coupling capacitor		
PCIE_RX4+	B55	I PCIE	AC coupled off Module		PCI Express Differential Receive Pairs 4	PCIe channel 4. Receive Input differential pair.
PCIE_RX4-	B56					
PCIE_TX5+	A52	O PCIE	AC coupled on Module	AC Coupling capacitor	PCI Express Differential Transmit Pairs 5	PCIe channel 5. Transmit Output differential pair.
PCIE_TX5-	A53			AC Coupling capacitor		
PCIE_RX5+	B52	I PCIE	AC coupled off Module		PCI Express Differential Receive Pairs 5	PCIe channel 5. Receive Input differential pair.
PCIE_RX5-	B53					
PCIE_TX6+	D19	O PCIE	AC coupled on Module	AC Coupling capacitor	PCI Express Differential Transmit Pairs 6	PCIe channel 6. Transmit Output differential pair.
PCIE_TX6-	D20			AC Coupling capacitor		
PCIE_RX6+	C19	I PCIE	AC coupled off Module		PCI Express Differential Receive Pairs 6	PCIe channel 6. Receive Input differential pair.
PCIE_RX6-	C20					
PCIE_TX7+	D22	O PCIE	AC coupled on Module	AC Coupling capacitor	PCI Express Differential Transmit Pairs 7	PCIe channel 7. Transmit Output differential pair.
PCIE_TX7-	D23			AC Coupling capacitor		
PCIE_RX7+	C22	I PCIE	AC coupled off Module		PCI Express Differential Receive Pairs 7	PCIe channel 7. Receive Input differential pair.
PCIE_RX7-	C23					
PCIE_CLK_REF+	A88	O PCIE	PCIE		Reference clock output for all PCI Express and PCI Express Graphics lanes.	PCIe Reference Clock for all COM Express PCIe lanes, and for PEG lanes.
PCIE_CLK_REF-	A89					

PEG Signals and Descriptions						
Signal	Pin#	Pin Type	Pwr Rail /Tolerance	KH960 PU/PD	Module Base Specification R2.1 Description	COM Express Carrier Design Guide R2.0 Description
PEG_TX0+	D52	O PCIE	AC coupled on Module	AC Coupling capacitor	PCI Express Graphics transmit differential pairs 0	PEG channel 0, Transmit Output differential pair.
PEG_TX0-	D53			AC Coupling capacitor		
PEG_RX0+	C52	I PCIE	AC coupled off Module		PCI Express Graphics receive differential pairs 0	PEG channel 0, Receive Input differential pair.
PEG_RX0-	C53					
PEG_TX1+	D55	O PCIE	AC coupled on Module	AC Coupling capacitor	PCI Express Graphics transmit differential pairs 1	PEG channel 1, Transmit Output differential pair.
PEG_TX1-	D56			AC Coupling capacitor		
PEG_RX1+	C55	I PCIE	AC coupled off Module		PCI Express Graphics receive differential pairs 1	PEG channel 1, Receive Input differential pair.
PEG_RX1-	C56					
PEG_TX2+	D58	O PCIE	AC coupled on Module	AC Coupling capacitor	PCI Express Graphics transmit differential pairs 2	PEG channel 2, Transmit Output differential pair.
PEG_TX2-	D59			AC Coupling capacitor		
PEG_RX2+	C58	I PCIE	AC coupled off Module		PCI Express Graphics receive differential pairs 2	PEG channel 2, Receive Input differential pair.
PEG_RX2-	C59					

PEG Signals and Descriptions						
PEG_TX3+	D61	O PCIE	AC coupled on Module	AC Coupling capacitor	PCI Express Graphics transmit differential pairs 3	PEG channel 3, Transmit Output differential pair.
PEG_TX3-	D62			AC Coupling capacitor		
PEG_RX3+	C61	I PCIE	AC coupled off Module		PCI Express Graphics receive differential pairs 3	PEG channel 3, Receive Input differential pair.
PEG_RX3-	C62					
PEG_TX4+	D65	O PCIE	AC coupled on Module	AC Coupling capacitor	PCI Express Graphics transmit differential pairs 4	PEG channel 4, Transmit Output differential pair.
PEG_TX4-	D66			AC Coupling capacitor		
PEG_RX4+	C65	I PCIE	AC coupled off Module		PCI Express Graphics receive differential pairs 4	PEG channel 4, Receive Input differential pair.
PEG_RX4-	C66					
PEG_TX5+	D68	O PCIE	AC coupled on Module	AC Coupling capacitor	PCI Express Graphics transmit differential pairs 5	PEG channel 5, Transmit Output differential pair.
PEG_TX5-	D69			AC Coupling capacitor		
PEG_RX5+	C68	I PCIE	AC coupled off Module		PCI Express Graphics receive differential pairs 5	PEG channel 5, Receive Input differential pair.
PEG_RX5-	C69					
PEG_TX6+	D71	O PCIE	AC coupled on Module	AC Coupling capacitor	PCI Express Graphics transmit differential pairs 6	PEG channel 6, Transmit Output differential pair.
PEG_TX6-	D72			AC Coupling capacitor		
PEG_RX6+	C71	I PCIE	AC coupled off Module		PCI Express Graphics receive differential pairs 6	PEG channel 6, Receive Input differential pair.
PEG_RX6-	C72					
PEG_TX7+	D74	O PCIE	AC coupled on Module	AC Coupling capacitor	PCI Express Graphics transmit differential pairs 7	PEG channel 7, Transmit Output differential pair.
PEG_TX7-	D75			AC Coupling capacitor		
PEG_RX7+	C74	I PCIE	AC coupled off Module		PCI Express Graphics receive differential pairs 7	PEG channel 7, Receive Input differential pair.
PEG_RX7-	C75					
PEG_TX8+	D78	O PCIE	AC coupled on Module	AC Coupling capacitor	PCI Express Graphics transmit differential pairs 8	PEG channel 8, Transmit Output differential pair.
PEG_TX8-	D79			AC Coupling capacitor		
PEG_RX8+	C78	I PCIE	AC coupled off Module		PCI Express Graphics receive differential pairs 8	PEG channel 8, Receive Input differential pair.
PEG_RX8-	C79					
PEG_TX9+	D81	O PCIE	AC coupled on Module	AC Coupling capacitor	PCI Express Graphics transmit differential pairs 9	PEG channel 9, Transmit Output differential pair.
PEG_TX9-	D82			AC Coupling capacitor		
PEG_RX9+	C81	I PCIE	AC coupled off Module		PCI Express Graphics receive differential pairs 9	PEG channel 9, Receive Input differential pair.
PEG_RX9-	C82					
PEG_TX10+	D85	O PCIE	AC coupled on Module	AC Coupling capacitor	PCI Express Graphics transmit differential pairs 10	PEG channel 10, Transmit Output differential pair.
PEG_TX10-	D86			AC Coupling capacitor		
PEG_RX10+	C85	I PCIE	AC coupled off Module		PCI Express Graphics receive differential pairs 10	PEG channel 10, Receive Input differential pair.
PEG_RX10-	C86					
PEG_TX11+	D88	O PCIE	AC coupled on Module	AC Coupling capacitor	PCI Express Graphics transmit differential pairs 11	PEG channel 11, Transmit Output differential pair.
PEG_TX11-	D89			AC Coupling capacitor		

PEG Signals and Descriptions						
PEG_RX11+	C88	I PCIE	AC coupled off Module		PCI Express Graphics receive differential pairs 11	PEG channel 11, Receive Input differential pair.
PEG_RX11-	C89					
PEG_TX12+	D91	O PCIE	AC coupled on Module	AC Coupling capacitor	PCI Express Graphics transmit differential pairs 12	PEG channel 12, Transmit Output differential pair.
PEG_TX12-	D92			AC Coupling capacitor		
PEG_RX12+	C91	I PCIE	AC coupled off Module		PCI Express Graphics receive differential pairs 12	PEG channel 12, Receive Input differential pair.
PEG_RX12-	C92					
PEG_TX13+	D94	O PCIE	AC coupled on Module	AC Coupling capacitor	PCI Express Graphics transmit differential pairs 13	PEG channel 13 Transmit Output differential pair.
PEG_TX13-	D95			AC Coupling capacitor		
PEG_RX13+	C94	I PCIE	AC coupled off Module		PCI Express Graphics receive differential pairs 13	PEG channel 13, Receive Input differential pair.
PEG_RX13-	C95					
PEG_TX14+	D98	O PCIE	AC coupled on Module	AC Coupling capacitor	PCI Express Graphics transmit differential pairs 14	PEG channel 14, Transmit Output differential pair.
PEG_TX14-	D99			AC Coupling capacitor		
PEG_RX14+	C98	I PCIE	AC coupled off Module		PCI Express Graphics receive differential pairs 14	PEG channel 14, Receive Input differential pair.
PEG_RX14-	C99					
PEG_TX15+	D101	O PCIE	AC coupled on Module	AC Coupling capacitor	PCI Express Graphics transmit differential pairs 15	PEG channel 15, Transmit Output differential pair.
PEG_TX15-	D102			AC Coupling capacitor		
PEG_RX15+	C101	I PCIE	AC coupled off Module		PCI Express Graphics receive differential pairs 15	PEG channel 15, Receive Input differential pair.
PEG_RX15-	C102					
PEG_LANE_RV#	D54	I CMOS	3.3V / 3.3V	PU 10KΩ to 3V3	PCI Express Graphics lane reversal input strap. Pull low on the Carrier board to reverse lane order.	PCI Express Graphics lane reversal input strap. Pull low on the carrier board to reverse lane order.

ExpressCard Signals and Descriptions						
Signal	Pin#	Pin Type	Pwr Rail /Tolerance	KH960 PU/PD	Module Base Specification R2.1 Description	COM Express Carrier Design Guide R2.0 Description
EXCD0_CPPE#	A49	I CMOS	3.3V /3.3V	PU 10k to 3.3V	PCI ExpressCard: PCI Express capable card request, active low, one per card	PCI ExpressCard0: PCI Express capable card request, active low, one per card
EXCD0_PERST#	A48	O CMOS	3.3V /3.3V		PCI ExpressCard: reset, active low, one per card	PCI ExpressCard0: reset, active low, one per card
EXCD1_CPPE#	B48	I CMOS	3.3V /3.3V	PU 10k to 3.3V	PCI ExpressCard: PCI Express capable card request, active low, one per card	PCI ExpressCard1: PCI Express capable card request, active low, one per card
EXCD1_PERST#	B47	O CMOS	3.3V /3.3V		PCI ExpressCard: reset, active low, one per card	PCI ExpressCard1: reset, active low, one per card

USB Signals and Descriptions						
Signal	Pin#	Pin Type	Pwr Rail /Tolerance	KH960 PU/PD	Module Base Specification R2.1 Description	COM Express Carrier Design Guide R2.0 Description
USB0+	A46	I/O USB	3.3V Suspend/3.3V		USB differential pairs, channel 0	USB Port 0, data + or D+
USB0-	A45					USB Port 0, data - or D-
USB1+	B46	I/O USB	3.3V Suspend/3.3V		USB differential pairs, channel 1	USB Port 1, data + or D+
USB1-	B45					USB Port 1, data - or D-
USB2+	A43	I/O USB	3.3V Suspend/3.3V		USB differential pairs, channel 2	USB Port 2, data + or D+
USB2-	A42					USB Port 2, data - or D-

USB3+	B43	I/O USB	3.3V Suspend/3.3V		USB differential pairs, channel 3	USB Port 3, data + or D+
USB3-	B42					USB Port 3, data - or D-
USB4+	A40	I/O USB	3.3V Suspend/3.3V		USB differential pairs, channel 4	USB Port 4, data + or D+
USB4-	A39					USB Port 4, data - or D-
USB5+	B40	I/O USB	3.3V Suspend/3.3V		USB differential pairs, channel 5	USB Port 5, data + or D+
USB5-	B39					USB Port 5, data - or D-
USB6+	A37	I/O USB	3.3V Suspend/3.3V		USB differential pairs, channel 6	USB Port 6, data + or D+
USB6-	A36					USB Port 6, data - or D-
USB7+	B37	I/O USB	3.3V Suspend/3.3V		USB differential pairs, channel 7. USB7 may be configured as a USB client or as a host, or both, at the Module designer's discretion. (KH960 default set as a host)	USB Port 7, data + or D+
USB7-	B36					USB Port 7, data - or D-
USB_0_1_OC#	B44	I CMOS	3.3V Suspend/3.3V	PU 10K $\Omega$ to 3.3V Suspend	USB over-current sense, USB channels 0 and 1. A pull-up for this line shall be present on the Module. An open drain driver from a USB current monitor on the Carrier Board may drive this line low. Do not pull this line high on the Carrier Board.	USB over-current sense, USB ports 0 and 1.
USB_2_3_OC#	A44	I CMOS	3.3V Suspend/3.3V	PU 10K $\Omega$ to 3.3V Suspend	USB over-current sense, USB channels 2 and 3. A pull-up for this line shall be present on the Module. An open drain driver from a USB current monitor on the Carrier Board may drive this line low. Do not pull this line high on the Carrier Board.	USB over-current sense, USB ports 2 and 3.
USB_4_5_OC#	B38	I CMOS	3.3V Suspend/3.3V	PU 10K $\Omega$ to 3.3V Suspend	USB over-current sense, USB channels 4 and 5. A pull-up for this line shall be present on the Module. An open drain driver from a USB current monitor on the Carrier Board may drive this line low. Do not pull this line high on the Carrier Board.	USB over-current sense, USB ports 4 and 5.
USB_6_7_OC#	A38	I CMOS	3.3V Suspend/3.3V	PU 10K $\Omega$ to 3.3V Suspend	USB over-current sense, USB channels 6 and 7. A pull-up for this line shall be present on the Module. An open drain driver from a USB current monitor on the Carrier Board may drive this line low. Do not pull this line high on the Carrier Board.	USB over-current sense, USB ports 6 and 7.
USB_SSTX0+	D4	O PCIE	AC coupled on Module	AC Coupling capacitor	Additional transmit signal differential pairs for the SuperSpeed USB data path.	USB Port 0, SuperSpeed TX +
USB_SSTX0-	D3			AC Coupling capacitor		USB Port 0, SuperSpeed TX -
USB_SSRX0+	C4	I PCIE	AC coupled off Module		Additional receive signal differential pairs for the SuperSpeed USB data path.	USB Port 0, SuperSpeed RX +
USB_SSRX0-	C3			USB Port 0, SuperSpeed RX -		
USB_SSTX1+	D7	O PCIE	AC coupled on Module	AC Coupling capacitor	Additional transmit signal differential pairs for the SuperSpeed USB data path.	USB Port 1, SuperSpeed TX +
USB_SSTX1-	D6			AC Coupling capacitor		USB Port 1, SuperSpeed TX -
USB_SSRX1+	C7	I PCIE	AC coupled off Module		Additional receive signal differential pairs for the SuperSpeed USB data path.	USB Port 1, SuperSpeed RX +
USB_SSRX1-	C6			USB Port 1, SuperSpeed RX -		
USB_SSTX2+	D10	O PCIE	AC coupled on Module	AC Coupling capacitor	Additional transmit signal differential pairs for the SuperSpeed USB data path.	USB Port 2, SuperSpeed TX +
USB_SSTX2-	D9			AC Coupling capacitor		USB Port 2, SuperSpeed TX -
USB_SSRX2+	C10	I PCIE	AC coupled off Module		Additional receive signal differential pairs for the SuperSpeed USB data path.	USB Port 2, SuperSpeed RX +
USB_SSRX2-	C9			USB Port 2, SuperSpeed RX -		
USB_SSTX3+	D13	O PCIE	AC coupled on Module	AC Coupling capacitor	Additional transmit signal differential pairs for the SuperSpeed USB data path.	USB Port 3, SuperSpeed TX +
USB_SSTX3-	D12			AC Coupling capacitor		USB Port 3, SuperSpeed TX -
USB_SSRX3+	C13	I PCIE	AC coupled off Module		Additional receive signal differential pairs for the SuperSpeed USB data path.	USB Port 3, SuperSpeed RX +
USB_SSRX3-	C12			USB Port 3, SuperSpeed RX -		

LVDS Signals and Descriptions						
Signal	Pin#	Pin Type	Pwr Rail /Tolerance	KH960 PU/PD	Module Base Specification R2.1 Description	COM Express Carrier Design Guide R2.0 Description
LVDS_A0+/eDP_TX2+	A71	O LVDS	LVDS EDP: AC coupled off Module		LVDS Channel A differential pairs The LVDS flat panel differential pairs (LVDS_A[0:3]+/-, LVDS_B[0:3]+/-. LVDS_A_CK+/-, LVDS_B_CK+/-) shall have 100Ω terminations across the pairs at the destination. These terminations may be on the Carrier Board if the Carrier Board implements a LVDS deserializer on-board.	LVDS channel A differential signal pair 0 eDP lane 2, TX± differential signal pair
LVDS_A0-/eDP_TX2-	A72					LVDS channel A differential signal pair 1 eDP lane 1, TX± differential signal pair
LVDS_A1+/eDP_TX1+	A73	O LVDS	LVDS EDP: AC coupled off Module		LVDS Channel A differential pairs The LVDS flat panel differential pairs (LVDS_A[0:3]+/-, LVDS_B[0:3]+/-. LVDS_A_CK+/-, LVDS_B_CK+/-) shall have 100Ω terminations across the pairs at the destination. These terminations may be on the Carrier Board if the Carrier Board implements a LVDS deserializer on-board.	LVDS channel A differential signal pair 2 eDP lane 0, TX ± differential signal pair
LVDS_A1-/eDP_TX1-	A74					LVDS channel A differential signal pair 3
LVDS_A2+/eDP_TX0+	A75	O LVDS	LVDS EDP: AC coupled off Module		eDP: eDP differential pairs	LVDS channel A differential clock pair eDP lane 3, TX± differential pair
LVDS_A2-/eDP_TX0-	A76					
LVDS_A3+	A78	O LVDS	LVDS EDP: AC coupled off Module		LVDS Channel A differential clock	LVDS channel B differential signal pair 0
LVDS_A3-	A79					LVDS channel B differential signal pair 1
LVDS_A_CK+/eDP_TX3+	A81	O LVDS	LVDS		LVDS Channel B differential pairs The LVDS flat panel differential pairs (LVDS_A[0:3]+/-, LVDS_B[0:3]+/-. LVDS_A_CK+/-, LVDS_B_CK+/-) shall have 100Ω terminations across the pairs at the destination. These terminations may be on the Carrier Board if the Carrier Board implements a LVDS deserializer on-board.	LVDS channel B differential signal pair 2
LVDS_A_CK-/eDP_TX3-	A82					LVDS channel B differential signal pair 3
LVDS_B0+	B71	O LVDS	LVDS		LVDS Channel B differential clock	LVDS flat panel power enable. eDP power enable
LVDS_B0-	B72					LVDS flat panel backlight enable high active signal eDP backlight enable
LVDS_B1+	B73	O LVDS	LVDS		LVDS panel / eDP backlight brightness control	LVDS flat panel backlight brightness control eDP backlight brightness control
LVDS_B1-	B74					DDC I2C clock signal used for flat panel detection and control. eDP auxiliary lane +
LVDS_B2+	B75	O LVDS	LVDS		LVDS panel / eDP backlight brightness control	DDC I2C data signal used for flat panel detection and control. eDP auxiliary lane -
LVDS_B2-	B76					eDP_HPD: Detection of Hot Plug / Unplug and notification of the link layer
LVDS_B3+	B77	O LVDS	LVDS		LVDS panel / eDP backlight brightness control	eDP_HPD: Detection of Hot Plug / Unplug and notification of the link layer
LVDS_B3-	B78					
LVDS_B_CK+	B81	O LVDS	LVDS		LVDS panel / eDP backlight brightness control	
LVDS_B_CK-	B82					
LVDS_VDD_EN/eDP_VDD_EN	A77	O CMOS	3.3V / 3.3V		LVDS panel / eDP power enable	LVDS flat panel power enable. eDP power enable
LVDS_BKLT_EN/eDP_BKLT_EN	B79	O CMOS	3.3V / 3.3V		LVDS panel / eDP backlight enable	LVDS flat panel backlight enable high active signal eDP backlight enable
LVDS_BKLT_CTRL/eDP_BKLT_CTRL	B83	O CMOS	3.3V / 3.3V	PD 100KΩ to GND	LVDS panel / eDP backlight brightness control	LVDS flat panel backlight brightness control eDP backlight brightness control
LVDS_I2C_CK/eDP_AUX+	A83	I/O OD CMOS	3.3V / 3.3V	PU 2.2KΩ to 3.3V	I2C clock output for LVDS display use / eDP AUX+	DDC I2C clock signal used for flat panel detection and control. eDP auxiliary lane +
LVDS_I2C_DAT/eDP_AUX-	A84	I/O OD CMOS	3.3V / 3.3V	PU 2.2KΩ to 3.3V	I2C data line for LVDS display use / eDP AUX-	DDC I2C data signal used for flat panel detection and control. eDP auxiliary lane -
RSVD/eDP_HPD	A87	I CMOS	3.3V / 3.3V	RSV PD 100KΩ to GND	eDP_HPD: Detection of Hot Plug / Unplug and notification of the link layer	eDP_HPD: Detection of Hot Plug / Unplug and notification of the link layer

LPC Signals and Descriptions						
Signal	Pin#	Pin Type	Pwr Rail /Tolerance	KH960 PU/PD	Module Base Specification R2.1 Description	COM Express Carrier Design Guide R2.0 Description
LPC_AD0	B4	I/O CMOS	3.3V / 3.3V		LPC multiplexed address, command and data bus.	LPC multiplexed command, address and data.
LPC_AD1	B5					
LPC_AD2	B6					
LPC_AD3	B7					
LPC_FRAME#	B3	O CMOS	3.3V / 3.3V		LPC frame indicates the start of an LPC cycle	LPC frame indicates start of a new cycle or termination of a broken cycle.
LPC_DRQ0#	B8	I CMOS	3.3V / 3.3V	PU 10K to 3.3V, not support.	LPC serial DMA request	LPC encoded DMA/Bus master request.
LPC_DRQ1#	B9			PU 10K to 3.3V, not support.		
LPC_SERIRQ	A50	I/O CMOS	3.3V / 3.3V	PU 10K to 3.3V	LPC serial interrupt	LPC serialized IRQ.
LPC_CLK	B10	O CMOS	3.3V / 3.3V	series 22Ω resistor	LPC clock output - 33MHz nominal	LPC clock output 33MHz.

SPI Signals and Descriptions						
Signal	Pin#	Pin Type	Pwr Rail /Tolerance	KH960 PU/PD	Module Base Specification R2.1 Description	COM Express Carrier Design Guide R2.0 Description
SPI_CS#	B97	O CMOS	3.3V Suspend/3.3V		Chip select for Carrier Board SPI - may be sourced from chipset SPI0 or SPI1	Chip select for Carrier Board SPI – may be sourced from chipset SPI0 or SPI1
SPI_MISO	A92	I CMOS	3.3V Suspend/3.3V		Data in to Module from Carrier SPI	Data in to Module from Carrier SPI
SPI_MOSI	A95	O CMOS	3.3V Suspend/3.3V		Data out from Module to Carrier SPI	Data out from Module to Carrier SPI
SPI_CLK	A94	O CMOS	3.3V Suspend/3.3V		Clock from Module to Carrier SPI	Clock from Module to Carrier SPI
SPI_POWER	A91	O	3.3V Suspend/3.3V		Power supply for Carrier Board SPI – sourced from Module – nominally 3.3V. The Module shall provide a minimum of 100mA on SPI_POWER. Carriers shall use less than 100mA of SPI_POWER. SPI_POWER shall only be used to power SPI devices on the Carrier Board.	Power supply for Carrier Board SPI – sourced from Module – nominally 3.3V. The Module shall provide a minimum of 100mA on SPI_POWER. Carriers shall use less than 100mA of SPI_POWER. SPI_POWER shall only be used to power SPI devices on the Carrier.
BIOS_DIS0#	A34	I CMOS	NA	PU 10KΩ to 3V3 Suspend.	Selection straps to determine the BIOS boot device. The Carrier should only float these or pull them low, please refer to COM Express Module Base Specification Revision 2.1 for strapping options of BIOS disable signals.	Selection strap to determine the BIOS boot device. The Carrier should only float these or pull them low, please refer to for strapping options of BIOS disable signals.
BIOS_DIS1#	B88			PU 10KΩ to 3V3 Suspend.		

VGA Signals and Descriptions						
Signal	Pin#	Pin Type	Pwr Rail /Tolerance	KH960 PU/PD	Module Base Specification R2.1 Description	COM Express Carrier Design Guide R2.0 Description
VGA_RED	B89	O Analog	Analog	PD 150Ω to GND	Red for monitor. Analog DAC output, designed to drive a 37.5Ω equivalent load.	Red component of analog DAC monitor output, designed to drive a 37.5Ω equivalent load.
VGA_GRN	B91	O Analog	Analog	PD 150Ω to GND	Green for monitor. Analog DAC output, designed to drive a 37.5Ω equivalent load.	Green component of analog DAC monitor output, designed to drive a 37.5Ω equivalent load.
VGA_BLU	B92	O Analog	Analog	PD 150Ω to GND	Blue for monitor. Analog DAC output, designed to drive a 37.5Ω equivalent load.	Blue component of analog DAC monitor output, designed to drive a 37.5Ω equivalent load.
VGA_HSYNC	B93	O CMOS	3.3V / 3.3V		Horizontal sync output to VGA monitor	Horizontal sync output to VGA monitor.
VGA_VSYNC	B94	O CMOS	3.3V / 3.3V		Vertical sync output to VGA monitor	Vertical sync output to VGA monitor.
VGA_I2C_CLK	B95	I/O OD CMOS	3.3V / 3.3V	PU 2.2KΩ to 3.3V	DDC clock line (I2C port dedicated to identify VGA monitor capabilities)	DDC clock line (I2C port dedicated to identify VGA monitor capabilities).
VGA_I2C_DAT	B96	I/O OD CMOS	3.3V / 3.3V	PU 2.2KΩ to 3.3V	DDC data line.	DDC data line.

## DDI Signals and Descriptions

Signal	Pin#	Pin Type	Pwr Rail /Tolerance	KH960 PU/PD	Module Base Specification R2.1 Description	COM Express Carrier Design Guide R2.0 Description
DDI1_PAIR0+	D26	O PCIE	AC coupled off Module		DDI for Display Port: DP1_LANE 0 differential pairs	DP1_LANE0+ for DP / TMDS1_DATA2+ for HDMI or DVI
DDI1_PAIR0-	D27				DDI for SDVO: SDVO1_RED± differential pair (Serial Digital Video red output)	DP1_LANE0- for DP / TMDS1_DATA2- for HDMI or DVI
DDI1_PAIR1+	D29	O PCIE	AC coupled off Module		DDI for Display Port: DP1_LANE 1 differential pairs	DP1_LANE1+ for DP / TMDS1_DATA1+ for HDMI or DVI
DDI1_PAIR1-	D30				DDI for SDVO: SDVO1_GRN± differential pair (Serial Digital Video green output)	DP1_LANE1- for DP / TMDS1_DATA1- for HDMI or DVI
DDI1_PAIR2+	D32	O PCIE	AC coupled off Module		DDI for Display Port: DP1_LANE 2 differential pairs	DP1_LANE2+ for DP / TMDS1_DATA0+ for HDMI or DVI
DDI1_PAIR2-	D33				DDI for SDVO: SDVO1_BLU± differential pair (Serial Digital Video blue output)	DP1_LANE2- for DP / TMDS1_DATA0- for HDMI or DVI
DDI1_PAIR3+	D36	O PCIE	AC coupled off Module		DDI for Display Port: DP1_LANE 3 differential pairs	DP1_LANE3+ for DP / TMDS1_CLK+
DDI1_PAIR3-	D37				DDI for SDVO: SDVO1_CK± differential pair (Serial Digital Video clock output)	DP1_LANE3- for DP / TMDS1_CLK-
DDI1_PAIR4+	C25	I PCIE	AC coupled off Module	NC	DDI for SDVO: SDVO1_INT± differential pair (Serial Digital Video B interrupt input differential pair)	NA
DDI1_PAIR4-	C26			NC	NA	
DDI1_PAIR5+	C29	I PCIE	AC coupled off Module	NC	DDI for SDVO: SDVO1_TVCLKIN± differential pair (Serial Digital Video TVOUT synchronization clock input differential pair.)	NA
DDI1_PAIR5-	C30			NC	NA	
DDI1_PAIR6+	C15	I PCIE	AC coupled off Module	NC	DDI for SDVO: SDVO1_FLDSTALL± differential pair (Serial Digital Video Field Stall input differential pair.)	NA
DDI1_PAIR6-	C16			NC	NA	
DDI1_CTRLCLK_AUX+	D15	I/O PCIE	AC coupled on Module	PD 100K to GND <b>(S/W IC between Rpu/PCH)</b>	DDI for Display Port: DP1_AUX+ Differential pairs (DP AUX+ function if DDI1_DDC_AUX_SEL is no connect) Half-duplex bi-directional AUX channel for services such as link configuration or maintenance and EDID access	DP1_AUX+ for DP
		I/O OD CMOS	3.3V / 3.3V	PU 2.2K to 3.3V, PD 100K to GND <b>(S/W IC between Rpu/Rpd resistor)</b>	DDI for SDVO: SDVO1_CTRLCLK (SDVO I2C clock line - to set up SDVO peripherals.) DDI for HDMI/DVI: HDMI1_CTRLCLK (HDMI/DVI I2C CTRLCLK if DDI1_DDC_AUX_SEL is pulled high)	HDMI1_CTRLCLK for HDMI or DVI
DDI1_CTRLCLK_AUX-	D16	I/O PCIE	AC coupled on Module	PU 100K to 3.3V <b>(S/W IC between Rpu/PCH)</b>	DDI for Display Port: DP1_AUX- Differential pairs (DP AUX- function if DDI1_DDC_AUX_SEL is no connect) Half-duplex bi-directional AUX channel for services such as link configuration or maintenance and EDID access	DP1_AUX- for DP
		I/O OD CMOS	3.3V / 3.3V	PU 2.2K to 3.3V/PU 100K to 3.3V <b>(S/W IC between 2.2K/100K resistor)</b>	DDI for SDVO: SDVO1_CTRLDATA (SDVO I2C data line - to set up SDVO peripherals.) DDI for HDMI/DVI: HDMI1_CTRLDATA (HDMI/DVI I2C CTRLDATA if DDI1_DDC_AUX_SEL is pulled high)	HDMI1_CTRLDATA for HDMI or DVI
DDI1_HPD	C24	I CMOS	3.3V / 3.3V	PD 1M to GND	DDI for Display Port: DP1_HPD (DP Hot-Plug Detect) DDI for HDMI/DVI: HDMI1_HPD (HDMI Hot-Plug Detect)	DP1_HPD for DP / HDMI1_HPD for HDMI or DVI
DDI1_DDC_AUX_SEL	D34	I CMOS	3.3V / 3.3V	PD 1M to GND	Selects the function of DDI1_CTRLCLK_AUX+ and DDI1_CTRLDATA_AUX-. This pin shall have a 1M pull-down to logic ground on the Module. If this input is floating the AUX pair is used for the DP AUX+/- signals. If pulled-high the AUX pair contains the CTRLCLK and CTRLDATA signals.	Selects the function of DP1_AUX±(Low) or HDMI1 DDC CLK/DATA(High) The DDC_AUX_SEL pin should be routed to pin 13 of the DisplayPort connector, to enable Dual-Mode. When HDMI/DVI is directly done on the Carrier Board, this pin shall be pulled to 3.3V with a 100k Ohm resistor to configure the AUX pairs as DDC channels.



DDI2_PAIR0+	D39	O PCIE	AC coupled off Module		DDI for Display Port: DP2_LANE 0 differential pairs DDI for HDMI/DVI: TMDS2_DATA lanes 2 differential pairs	DP2_LANE0+ for DP / TMDS2_DATA2+ for HDMI or DVI
DDI2_PAIR0-	D40					DP2_LANE0- for DP / TMDS2_DATA2- for HDMI or DVI
DDI2_PAIR1+	D42	O PCIE	AC coupled off Module		DDI for Display Port: DP2_LANE 1 differential pairs DDI for HDMI/DVI: TMDS2_DATA lanes 1 differential pairs	DP2_LANE1+ for DP / TMDS2_DATA1+ for HDMI or DVI
DDI2_PAIR1-	D43					DP2_LANE1- for DP / TMDS2_DATA1- for HDMI or DVI
DDI2_PAIR2+	D46	O PCIE	AC coupled off Module		DDI for Display Port: DP2_LANE 2 differential pairs DDI for HDMI/DVI: TMDS2_DATA lanes 0 differential pairs	DP2_LANE2+ for DP / TMDS2_DATA0+ for HDMI or DVI
DDI2_PAIR2-	D47					DP2_LANE2- for DP / TMDS2_DATA0- for HDMI or DVI
DDI2_PAIR3+	D49	O PCIE	AC coupled off Module		DDI for Display Port: DP2_LANE 3 differential pairs DDI for HDMI/DVI: TMDS2_CLK differential pairs	DP2_LANE3+ for DP / TMDS2_CLK+
DDI2_PAIR3-	D50					DP2_LANE3- for DP / TMDS2_CLK-
DDI2_CTRLCLK_AUX+	C32	I/O PCIE	AC coupled on Module	PD 100K to GND <b>(S/W IC between Rpu/PCH)</b>	DDI for Display Port: DP2_AUX+ Differential pairs (DP AUX+ function if DDI2_DDC_AUX_SEL is no connect) Half-duplex bi-directional AUX channel for services such as link configuration or maintenance and EDID access	DP2_AUX+ for DP
		I/O OD CMOS	3.3V / 3.3V	PU 2.2K to 3.3V, PD 100K to GND <b>(S/W IC between Rpu/Rpd resistor)</b>	DDI for HDMI/DVI: HDMI2_CTRLCLK (HDMI/DVI I2C CTRLCLK if DDI2_DDC_AUX_SEL is pulled high)	HDMI2_CTRLCLK for HDMI or DVI
DDI2_CTRLCLK_AUX-	C33	I/O PCIE	AC coupled on Module	PU 100K to 3.3V <b>(S/W IC between Rpu/PCH)</b>	DDI for Display Port: DP2_AUX- Differential pairs (DP AUX- function if DDI2_DDC_AUX_SEL is no connect) Half-duplex bi-directional AUX channel for services such as link configuration or maintenance and EDID access	DP2_AUX- for DP
		I/O OD CMOS	3.3V / 3.3V	PU 2.2K to 3.3V/PU 100K to 3.3V <b>(S/W IC between 2.2K/100K resistor)</b>	DDI for HDMI/DVI: HDMI2_CTRLDATA (HDMI/DVI I2C CTRLDATA if DDI2_DDC_AUX_SEL is pulled high)	HDMI2_CTRLDATA for HDMI or DVI
DDI2_HPD	D44	I CMOS	3.3V / 3.3V	PD 1M to GND	DDI for Display Port: DP2_HPD (DP Hot-Plug Detect) DDI for HDMI/DVI: HDMI2_HPD (HDMI Hot-Plug Detect)	DP2_HPD for DP / HDMI1_HPD for HDMI or DVI
DDI2_DDC_AUX_SEL	C34	I CMOS	3.3V / 3.3V	PD 1M to GND	Selects the function of DDI2_CTRLCLK_AUX+ and DDI2_CTRLDATA_AUX-. This pin shall have a 1M pull-down to logic ground on the Module. If this input is floating the AUX pair is used for the DP AUX+/- signals. If pulled-high the AUX pair contains the CTRLCLK and CTRLDATA signals.	Selects the function of DP2 AUX±(Low) or HDMI2 DDC CLK/DATA(High) The DDC_AUX_SEL pin should be routed to pin 13 of the DisplayPort connector, to enable Dual-Mode. When HDMI/DVI is directly done on the Carrier Board, this pin shall be pulled to 3.3V with a 100k Ohm resistor to configure the AUX pairs as DDC channels.
DDI3_PAIR0+	C39	O PCIE	AC coupled off Module		DDI for Display Port: DP3_LANE 0 differential pairs DDI for HDMI/DVI: TMDS3_DATA lanes 2 differential pairs	DP3_LANE0+ for DP / TMDS3_DATA2+ for HDMI or DVI
DDI3_PAIR0-	C40					DP3_LANE0- for DP / TMDS3_DATA2- for HDMI or DVI
DDI3_PAIR1+	C42	O PCIE	AC coupled off Module		DDI for Display Port: DP3_LANE 1 differential pairs DDI for HDMI/DVI: TMDS3_DATA lanes 1 differential pairs	DP3_LANE1+ for DP / TMDS3_DATA1+ for HDMI or DVI
DDI3_PAIR1-	C43					DP3_LANE1- for DP / TMDS3_DATA1- for HDMI or DVI
DDI3_PAIR2+	C46	O PCIE	AC coupled off Module		DDI for Display Port: DP3_LANE 2 differential pairs DDI for HDMI/DVI: TMDS3_DATA lanes 0 differential pairs	DP3_LANE2+ for DP / TMDS3_DATA0+ for HDMI or DVI
DDI3_PAIR2-	C47					DP3_LANE2- for DP / TMDS3_DATA0- for HDMI or DVI
DDI3_PAIR3+	C49	O PCIE	AC coupled off Module		DDI for Display Port: DP3_LANE 3 differential pairs DDI for HDMI/DVI: TMDS3_CLK differential pairs	DP3_LANE3+ for DP / TMDS3_CLK+
DDI3_PAIR3-	C50					DP3_LANE3- for DP / TMDS3_CLK-
DDI3_CTRLCLK_AUX+	C36	I/O PCIE	AC coupled on Module	PD 100K to GND <b>(S/W IC between Rpu/PCH)</b>	DDI for Display Port: DP3_AUX+ Differential pairs (DP AUX+ function if DDI3_DDC_AUX_SEL is no connect) Half-duplex bi-directional AUX channel for services such as link configuration or maintenance and EDID access	DP3_AUX+ for DP
		I/O OD CMOS	3.3V / 3.3V	PU 2.2K to 3.3V, PD 100K to GND <b>(S/W IC between Rpu/Rpd resistor)</b>	DDI for HDMI/DVI: HDMI3_CTRLCLK (HDMI/DVI I2C CTRLCLK if DDI3_DDC_AUX_SEL is pulled high)	HDMI3_CTRLCLK for HDMI or DVI

DDB_CTRLCLK_AUX-	C37	I/O PCIE	AC coupled on Module	PU 100K to 3.3V <b>(S/W IC between Rpu/PCH)</b>	DDI for Display Port: DP3_AUX- Differential pairs (DP AUX- function if DDB_DDC_AUX_SEL is no connect)	DP3_AUX- for DP
		I/O OD CMOS	3.3V / 3.3V	PU 2.2K to 3.3V/PU 100K to 3.3V <b>(S/W IC between 2.2K/100K resistor)</b>	DDI for HDMI/DVI: HDMI3_CTRLDATA (HDMI/DVI I2C CTRLDATA if DDB_DDC_AUX_SEL is pulled high)	HDMI3_CTRLDATA for HDMI or DVI
DDB_HPD	C44	I CMOS	3.3V / 3.3V	PD 1M $\Omega$ to GND	DDI for Display Port: DP3_HPD (DP Hot-Plug Detect) DDI for HDMI/DVI: HDMI3_HPD (HDMI Hot-Plug Detect)	DP3_HPD for DP / HDMI1_HPD for HDMI or DVI
DDB_DDC_AUX_SEL	C38	I CMOS	3.3V / 3.3V	PD 1M $\Omega$ to GND	Selects the function of DDB_CTRLCLK_AUX+ and DDB_CTRLDATA_AUX-. This pin shall have a 1M pull-down to logic ground on the Module. If this input is floating the AUX pair is used for the DP AUX+/- signals. If pulled-high the AUX pair contains the CTRLCLK and CTRLDATA signals.	Selects the function of DP3_AUX $\pm$ (Low) or HDMI3 DDC CLK/DATA(High) The DDC_AUX_SEL pin should be routed to pin 13 of the DisplayPort connector, to enable Dual-Mode. When HDMI/DVI is directly done on the Carrier Board, this pin shall be pulled to 3.3V with a 100k Ohm resistor to configure the AUX pairs as DDC channels.

### Serial Interface Signals and Descriptions

Signal	Pin#	Pin Type	Pwr Rail /Tolerance	KH960 PU/PD	Module Base Specification R2.1 Description	COM Express Carrier Design Guide R2.0 Description
SER0_TX	A98	O CMOS	5V/12V		General purpose serial port 0 transmitter	Transmit Line for Serial Port 0 ; PD 4.7K $\Omega$
SER0_RX	A99	I CMOS	5V/12V	PU 10K $\Omega$ to 3.3V	General purpose serial port 0 receiver	Receive Line for Serial Port 0
SER1_TX	A101	O CMOS	5V/12V		General purpose serial port 1 transmitter	Transmit Line for Serial Port 1 ; PD 4.7K $\Omega$
SER1_RX	A102	I CMOS	5V/12V	PU 10K $\Omega$ to 3.3V	General purpose serial port 1 receiver	Receive Line for Serial Port 1

### I2C Signals and Descriptions

Signal	Pin#	Pin Type	Pwr Rail /Tolerance	KH960 PU/PD	Module Base Specification R2.1 Description	COM Express Carrier Design Guide R2.0 Description
I2C_CK	B33	I/O OD CMOS	3.3V Suspend/3.3V	PU 2.2K to 3.3V Suspend	General purpose I2C port clock output	General Purpose I2C Clock output
I2C_DAT	B34	I/O OD CMOS	3.3V Suspend/3.3V	PU 2.2K to 3.3V Suspend	General purpose I2C port data I/O line	General Purpose I2C data I/O line.

### Miscellaneous Signals and Descriptions

Signal	Pin#	Pin Type	Pwr Rail /Tolerance	KH960 PU/PD	Module Base Specification R2.1 Description	COM Express Carrier Design Guide R2.0 Description
SPKR	B32	O CMOS	3.3V / 3.3V		Output for audio enunciator - the "speaker" in PC-AT systems. This port provides the PC beep signal and is mostly intended for debugging purposes.	Output used to control an external FET or a logic gate to drive an external PC speaker.
WDT	B27	O CMOS	3.3V / 3.3V		Output indicating that a watchdog time-out event has occurred.	Output indicating that a watchdog time-out event has occurred.
FAN_PWMOUT	B101	O CMOS	3.3V / 12V	RSV PD 100K $\Omega$ to GND	Fan speed control. Uses the Pulse Width Modulation (PWM) technique to control the fan's RPM.	Fan speed control. Uses the Pulse Width Modulation (PWM) technique to control the fan's RPM.
FAN_TACHIN	B102	I OD CMOS	3.3V / 12V	PU 47K $\Omega$ to 3.3V	Fan tachometer input for a fan with a two pulse output.	Fan tachometer input for a fan with a two pulse output.
TPM_PP	A96	I CMOS	3.3V / 3.3V	PD 100K $\Omega$ to GND.	Trusted Platform Module (TPM) Physical Presence pin. Active high. TPM chip has an internal pull down. This signal is used to indicate Physical Presence to the TPM.	Trusted Platform Module (TPM) Physical Presence pin. Active high. TPM chip has an internal pull down. This signal is used to indicate Physical Presence to the TPM.

**Power and System Management Signals and Descriptions**

Signal	Pin#	Pin Type	Pwr Rail /Tolerance	KH960 PU/PD	Module Base Specification R2.1 Description	COM Express Carrier Design Guide R2.0 Description
PWRBTN#	B12	I CMOS	3.3V Suspend/3.3V	PU 10K $\Omega$ to 3.3V Suspend	A falling edge creates a power button event. Power button events can be used to bring a system out of S5 soft off and other suspend states, as well as powering the system down.	Power button low active signal used to wake up the system from S5 state (soft off). This signal is triggered on the falling edge.
SYS_RESET#	B49	I CMOS	3.3V Suspend/3.3V	PU 10K $\Omega$ to 3.3V Suspend	Reset button input. Active low request for Module to reset and reboot. May be falling edge sensitive. For situations when SYS_RESET# is not able to reestablish control of the system, PWR_OK or a power cycle may be used.	Reset button input. Active low request for Module to reset and reboot. May be falling edge sensitive. For situations when SYS_RESET# is not able to reestablish control of the system, PWR_OK or a power cycle may be used.
CB_RESET#	B50	O CMOS	3.3V Suspend/3.3V	PD 100K $\Omega$ to GND	Reset output from Module to Carrier Board. Active low. Issued by Module chipset and may result from a low SYS_RESET# input, a low PWR_OK input, a VCC_12V power input that falls below the minimum specification, a watchdog timeout, or may be initiated by the Module software.	Reset output signal from Module to Carrier Board. This signal may be driven low by the Module to reset external components located on the Carrier Board.
PWR_OK	B24	I CMOS	3.3V / 3.3V	PU 10K $\Omega$ to 3.3V	Power OK from main power supply. A high value indicates that the power is good. This signal can be used to hold off Module startup to allow Carrier based FPGAs or other configurable devices time to be programmed.	Power OK status signal generated by the ATX power supply to notify the Module that the DC operating voltages are within the ranges required for proper operation.
SUS_STAT#	B18	O CMOS	3.3V Suspend/3.3V		Indicates imminent suspend operation; used to notify LPC devices.	Suspend status signal to indicate that the system will be entering a low power state soon. It can be used by other peripherals on the Carrier Board as an indication that they should go into power-down mode.
SUS_S3#	A15	O CMOS	3.3V Suspend/3.3V	PD 100K $\Omega$ to GND	Indicates system is in Suspend to RAM state. Active low output. An inverted copy of SUS_S3# on the Carrier Board may be used to enable the non-standby power on a typical ATX supply.	S3 Sleep control signal indicating that the system resides in S3 state (Suspend to RAM).
SUS_S4#	A18	O CMOS	3.3V Suspend/3.3V	PD 100K $\Omega$ to GND	Indicates system is in Suspend to Disk state. Active low output.	S4 Sleep control signal indicating that the system resides in S4 state (Suspend to Disk).
SUS_S5#	A24	O CMOS	3.3V Suspend/3.3V	PD 100K $\Omega$ to GND	Indicates system is in Soft Off state.	S5 Sleep Control signal indicating that the system resides in S5 State (Soft Off).
WAKE0#	B66	I CMOS	3.3V Suspend/3.3V	PU 10K $\Omega$ to 3.3V Suspend	PCI Express wake up signal.	PCI Express wake-up event signal.
WAKE1#	B67	I CMOS	3.3V Suspend/3.3V	Integrate PU @PCH	General purpose wake up signal. May be used to implement wake-up on PS2 keyboard or mouse activity.	General purpose wake-up signal.
BATLOW#	A27	I CMOS	3.3V Suspend/ 3.3V	PU 10K $\Omega$ to 3.3V Suspend	Indicates that external battery is low. This port provides a battery-low signal to the Module for orderly transitioning to power saving or power cut-off ACPI modes.	Battery low input. This signal may be driven low by external circuitry to signal that the system battery is low. It also can be used to signal some other external power management event.
LID#	A103	I OD CMOS	3.3V Suspend/12V	PU 47K $\Omega$ to 3.3V Suspend	LID switch. Low active signal used by the ACPI operating system for a LID switch.	LID switch. Low active signal used by the ACPI operating system for a LID switch.
SLEEP#	B103	I OD CMOS	3.3V Suspend/12V	PU 47K $\Omega$ to 3.3V Suspend	Sleep button. Low active signal used by the ACPI operating system to bring the system to sleep state or to wake it up again.	Sleep button. Low active signal used by the ACPI operating system to bring the system to sleep state or to wake it up again.

**Thermal Protection Signals and Descriptions**

Signal	Pin#	Pin Type	Pwr Rail /Tolerance	KH960 PU/PD	Module Base Specification R2.1 Description	COM Express Carrier Design Guide R2.0 Description
THRM#	B35	I CMOS	3.3V / 3.3V	PU 10K $\Omega$ to 3.3V	Input from off-Module temp sensor indicating an over-temp situation.	Thermal Alarm active low signal generated by the external hardware to indicate an over temperature situation. This signal can be used to initiate thermal throttling.
THRMTRIP#	A35	O CMOS	3.3V / 3.3V	PU 10K $\Omega$ to 3.3V	Active low output indicating that the CPU has entered thermal shutdown.	Thermal Trip indicates an overheating condition of the processor. If 'THRMTRIP#' goes active the system immediately transitions to the S5 State (Soft Off).

SMBUS Signals and Descriptions						
Signal	Pin#	Pin Type	Pwr Rail /Tolerance	KH960 PU/PD	Module Base Specification R2.1 Description	COM Express Carrier Design Guide R2.0 Description
SMB_CK	B13	I/O OD CMOS	3.3V Suspend/3.3V	PU 2.2K $\Omega$ to 3.3V Suspend	System Management Bus bidirectional clock line.	System Management Bus bidirectional clock line
SMB_DAT	B14	I/O OD CMOS	3.3V Suspend/3.3V	PU 2.2K $\Omega$ to 3.3V Suspend	System Management Bus bidirectional data line.	System Management bidirectional data line.
SMB_ALERT#	B15	I CMOS	3.3V Suspend/3.3V	PU 2.2K $\Omega$ to 3.3V Suspend	System Management Bus Alert – active low input can be used to generate an SMI# (System Management Interrupt) or to wake the system.	System Management Bus Alert

GPIO Signals and Descriptions						
Signal	Pin#	Pin Type	Pwr Rail /Tolerance	KH960 PU/PD	Module Base Specification R2.1 Description	COM Express Carrier Design Guide R2.0 Description
GPO0	A93	O CMOS	3.3V / 3.3V		General purpose output pins. Upon a hardware reset, these outputs should be low.	General Purpose Outputs for system specific usage.
GPO1	B54					
GPO2	B57					
GPO3	B63					
GPI0	A54	I CMOS	3.3V / 3.3V	PU 47K $\Omega$ to 3.3V	General purpose input pins. Pulled high internally on the Module.	General Purpose Input for system specific usage. The signals are pulled up by the Module.
GPI1	A63			PU 47K $\Omega$ to 3.3V		
GPI2	A67			PU 47K $\Omega$ to 3.3V		
GPI3	A85			PU 47K $\Omega$ to 3.3V		

Power and GND Signals and Descriptions						
Signal	Pin#	Pin Type	Pwr Rail /Tolerance	KH960 PU/PD	Module Base Specification R2.1 Description	COM Express Carrier Design Guide R2.0 Description
VCC_12V	A104~A109 B104~B109 C104~C109 D104~D109	Power			Primary power input: +12V nominal. All available VCC_12V pins on the connector(s) shall be used.	
VCC_5V_SBY	B84~B87	Power			Standby power input: +5.0V nominal. If VCC5_SBY is used, all available VCC_5V_SBY pins on the connector(s) shall be used. Only used for standby and suspend functions. May be left unconnected if these functions are not used in the system design.	
VCC_RTC	A47	Power			Real-time clock circuit-power input. Nominally +3.0V.	
GND	A1, A11, A21, A31, A41, A51, A57, A60, A66, A70, A80, A90, A100, A110, B1, B11, B21, B31, B41, B51, B60, B70, B80, B90, B100, B110, C1, C2, C5, C8, C11, C14, C21, C31, C41, C51, C60, C70, C73, C76, C80, C84, C87, C90, C93, C96, C100, C103, C110, D1, D2, D5, D8, D11, D14, D21, D31, D41, D51, D60, D67, D70, D73, D76, D80, D84, D87, D90, D93, D96, D100, D103, D110	Power			Ground - DC power and signal and AC signal return path. All available GND connector pins shall be used and tied to Carrier Board GND plane.	

**Module type Signals and Descriptions**

Signal	Pin#	Pin Type	Pwr Rail /Tolerance	KH960 PU/PD	Module Base Specification R2.1 Description	COM Express Carrier Design Guide R2.0 Description
TYPE0#	C54	PDS		N.C.	TYPE2# TYPE1# TYPE0# X X X pin out Type 1 NC NC NC pin out Type 2 NC NC GND pin out Type 3 (no IDE) NC GND NC pin out Type 4 (no PCI) NC GND GND pin out Type 5 (no IDE, no PCI) GND NC NC pin out Type 6 (no IDE, no PCI)	The Type pins indicate the COM Express pin-out type of the Module. To indicate the Module's pin-out type, the pins are either not connected or strapped to ground on the Module. The Carrier Board has to implement additional logic, which prevents the system to switch power on, if a Module with an incompatible pin-out type is detected.
TYPE1#	C57	PDS	N.C.			
TYPE2#	D57	PDS	PD 0Ω to GND			
TYPE10#	A97	PDS		N.C.	Dual use pin. Indicates to the Carrier Board that a Type 10 Module is installed. Indicates to the Carrier that a Rev 1.0/2.0 Module is installed TYPE10# NC Pin-out R2.0 PD Pin-out Type 10 pull down to ground with 47K resistor 12V Pin-out R1.0 This pin is reclaimed from the VCC_12V pool. In R1.0 Modules this pin will connect to other VCC_12V pins. In R2.0 this pin is defined as a no connect for types 1-6. A Carrier can detect a R1.0 Module by the presence of 12V on this pin. R2.0 Module types 1-6 will no connect this pin. Type 10 Modules shall pul this pin to ground through a 47K resistor.	Indicates to the Carrier Board that a Type 10 Module is installed. Indicates to the Carrier Board, that a Rev 1.0/2.0 Module is installed. TYPE10# NC Pin-out R2.0 PD Pin-out Type 10 pull down to ground with 47k 12V Pin-out R1.0

## Standby Power LED

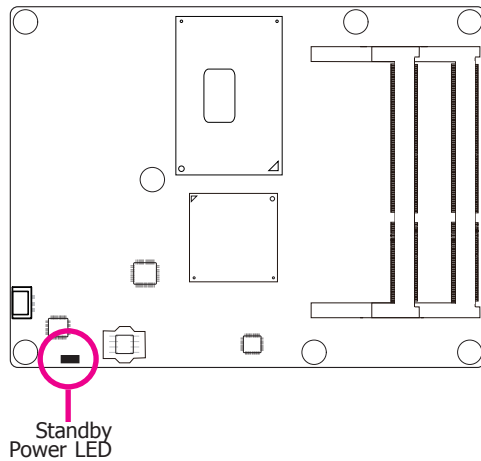

This LED will be lit when the system is in the standby mode.

## Cooling Option

### Heat Spreader with Heat Sink and Fan



**Note:**

The system board used in the following illustrations may not resemble the actual board. These illustrations are for reference only.



Top View of the Heat Sink

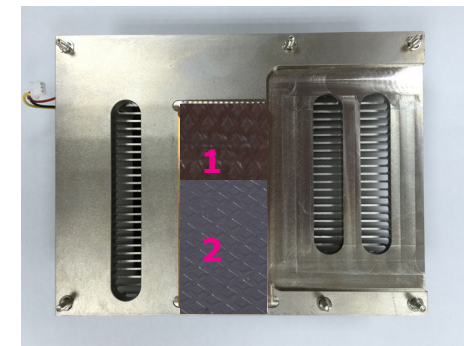

Bottom View of the Heat Sink

- "1" and "2" denote the locations of the thermal pads designed to contact the corresponding components on KH960.



**Important:**

Remove the plastic covering from the thermal pads prior to mounting the heat sink onto KH960.

## Installing KH960 onto a Carrier Board



### Important:

The carrier board used in this section is for reference purpose only and may not resemble your carrier board. These illustrations are mainly to guide you on how to install KH960 onto the carrier board of your choice.

1. Grasp KH960 by its edges and position it on top of the carrier board with its mounting holes aligned with the standoffs on the carrier board. This helps align the COM Express connectors of the two boards to each other.

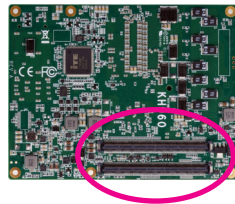

COM Express connectors on KH960

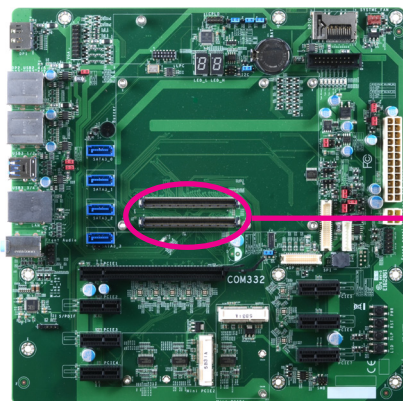

COM Express connectors on the carrier board

2. Apply firm even pressure to the side with the connectors first and push down the entire board. You will hear a "click", which indicates the module is correctly seated in the COM Express connectors of the carrier board.

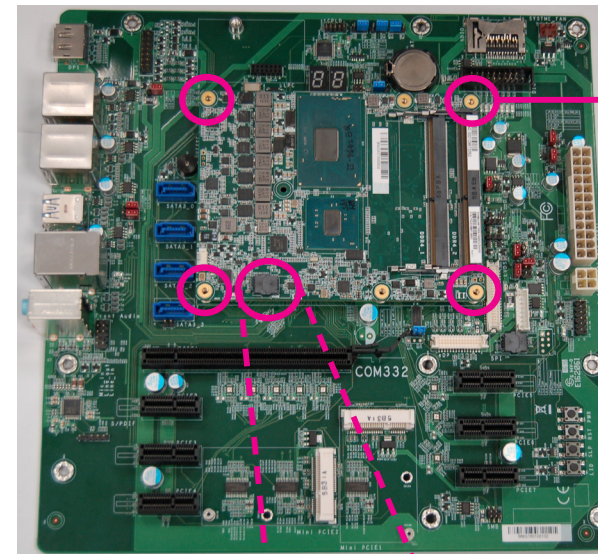

Pressing points

BIOS ROM socket



### Note:

The above illustration shows the pressing points of the module onto the carrier board. Be careful when pressing the module to avoid damaging the socket.

3. Install a heat sink onto the KH960 with the carrier board. First align the mounting holes of the heatsink with the mounting holes of the module.

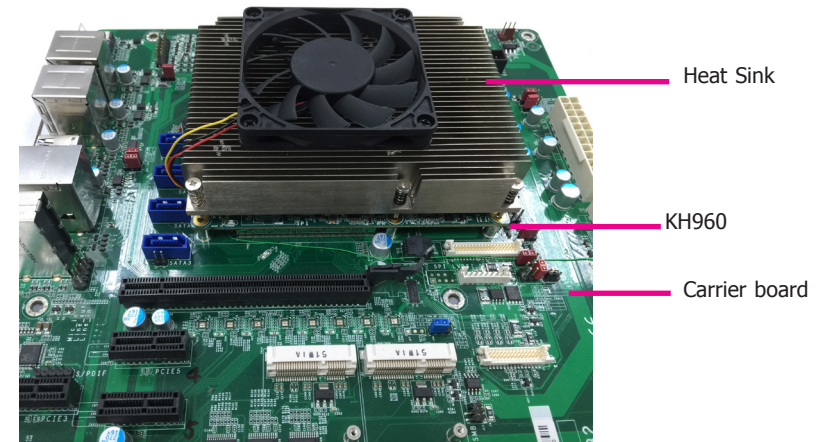
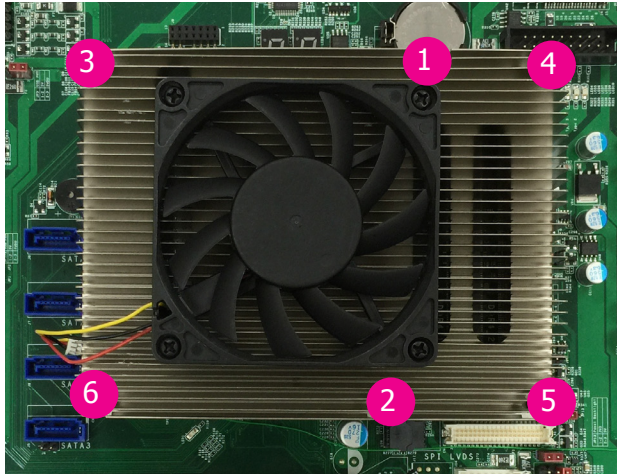

Side View of the Heatsink, Module, and Carrier Board



**Note:**

Install the heatsink according to the sequence of the screws shown in the above image to avoid damaging the CPU.

4. Connect the heatsink and fan's cable to the fan connector on KH960.

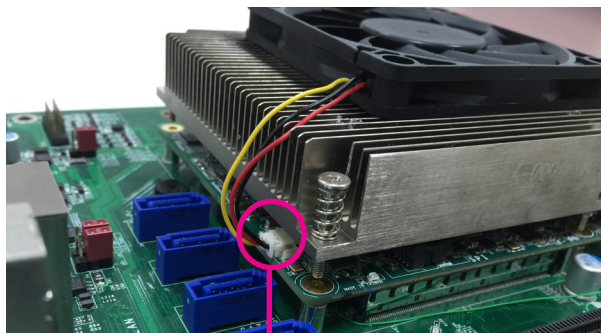

Fan connector



## Chapter 4 - BIOS Setup

### Overview

The BIOS is a program that takes care of the basic level of communication between the CPU and peripherals. It contains codes for various advanced features found in this system board. The BIOS allows you to configure the system and save the configuration in a battery-backed CMOS so that the data retains even when the power is off. In general, the information stored in the CMOS RAM of the EEPROM will stay unchanged unless a configuration change has been made such as a hard drive replaced or a device added. It is possible that the CMOS battery will fail causing CMOS data loss. If this happens, you need to install a new CMOS battery and reconfigure the BIOS settings.

**Note:**

The BIOS is constantly updated to improve the performance of the system board; therefore the BIOS screens in this chapter may not appear the same as the actual one. These screens are for reference purpose only.

### Default Configuration

Most of the configuration settings are either predefined according to the Load Optimal Defaults settings which are stored in the BIOS or are automatically detected and configured without requiring any actions. There are a few settings that you may need to change depending on your system configuration.

### Entering the BIOS Setup Utility

The BIOS Setup Utility can only be operated from the keyboard and all commands are keyboard commands. The commands are available at the right side of each setup screen.

The BIOS Setup Utility does not require an operating system to run. After you power up the system, the BIOS message appears on the screen and the memory count begins. After the memory test, the message "Press DEL to run setup" will appear on the screen. If the message disappears before you respond, restart the system or press the "Reset" button. You may also restart the system by pressing the <Ctrl> <Alt> and <Del> keys simultaneously.

### Legends

KEYS	Function
F1	Help
<Esc>	Exit
Up and Down Arrows	Select Item
Right and Left Arrows	Select Item
<F5>/<F6>	Change Values
<Enter>	Select ► Submenu
<F9>	Setup Defaults
<F10>	Save and Exit

### Scroll Bar

When a scroll bar appears to the right of the setup screen, it indicates that there are more available fields not shown on the screen. Use the up and down arrow keys to scroll through all the available fields.

### Submenu

When "►" appears on the left of a particular field, it indicates that a submenu which contains additional options are available for that field. To display the submenu, move the highlight to that field and press <Enter>.

## Insyde BIOS Setup Utility

### Main

The Main menu is the first screen that you will see when you enter the BIOS setup utility.

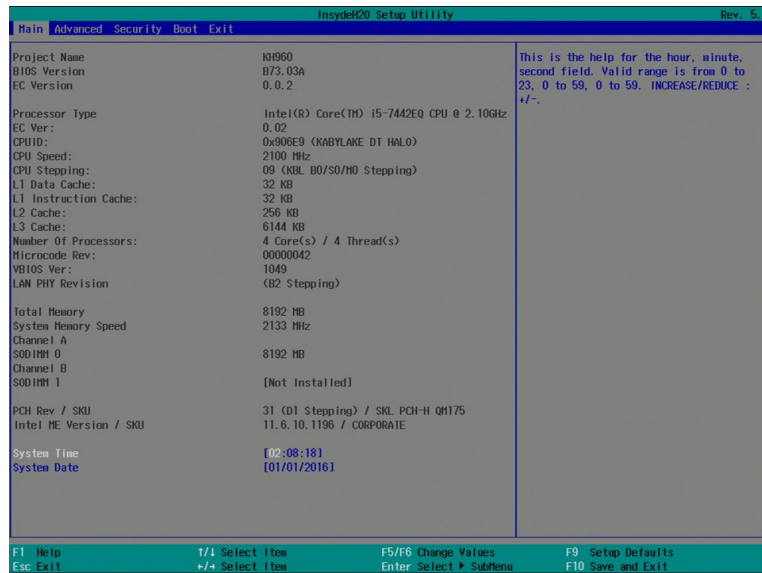

#### System Date

The date format is <month>, <date>, <year>. Day displays a day, from Sunday to Saturday. Month displays the month, from January to December. Date displays the date, from 1 to 31. Year displays the year, from 1980 to 2099.

#### System Time

The time format is <hour>, <minute>, <second>. The time is based on the 24-hour military-time clock. For example, 1 p.m. is 13:00:00. Hour displays hours from 00 to 23. Minute displays minutes from 00 to 59. Second displays seconds from 00 to 59.

## Advanced

The Advanced menu allows you to configure your system for basic operation. Some entries are defaults required by the system board, while others, if enabled, will improve the performance of your system or let you set some features according to your preference.



#### Important:

Setting incorrect field values may cause the system to malfunction.

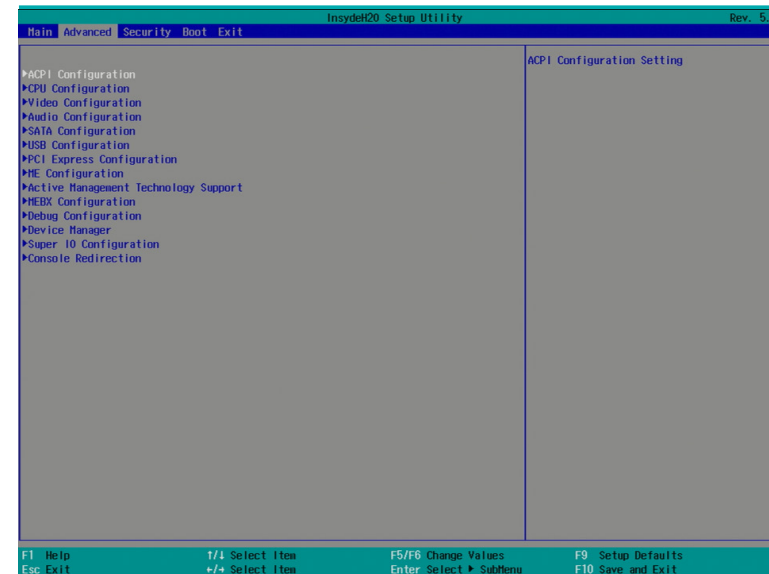

## ACPI Settings

This section configures the system's ACPI settings.

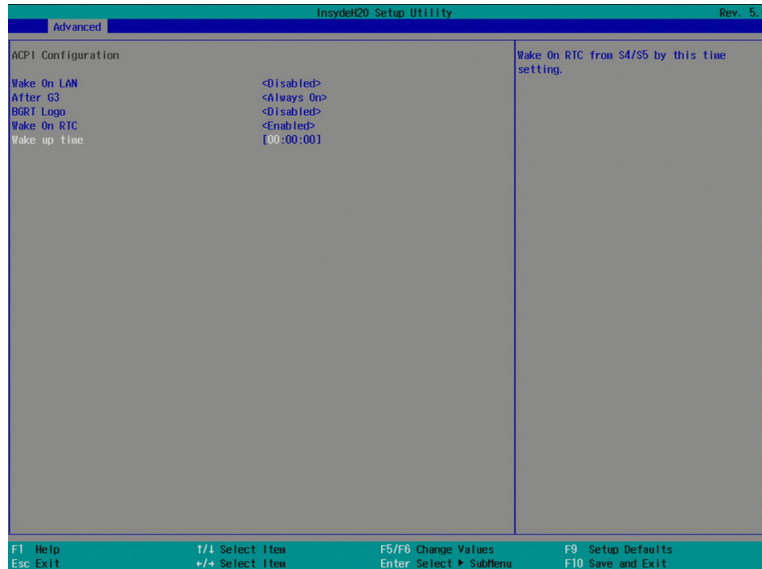

### Wake on PME

Enable or disable Wake on PME (Power Management Event) to wake the system through ACPI events.

### State After G3

This field is to specify what state the system should be in when power is re-applied after a power failure (G3, the mechanical-off, state).

**Always On** The system is powered on.

**Always Off** The system is powered off.

### BRGT Logo

Enable or disable the display of an operating system logo or image during boot using the BRGT (Boot Graphics Resource Table) mechanism.

### Wake on RTC

Automatically power the system on at a particular time every day from the Real-time clock battery. Specify the wake up time of the day below: <hour>, <minute>, <second>.

## CPU Configuration

This section configures the CPU.

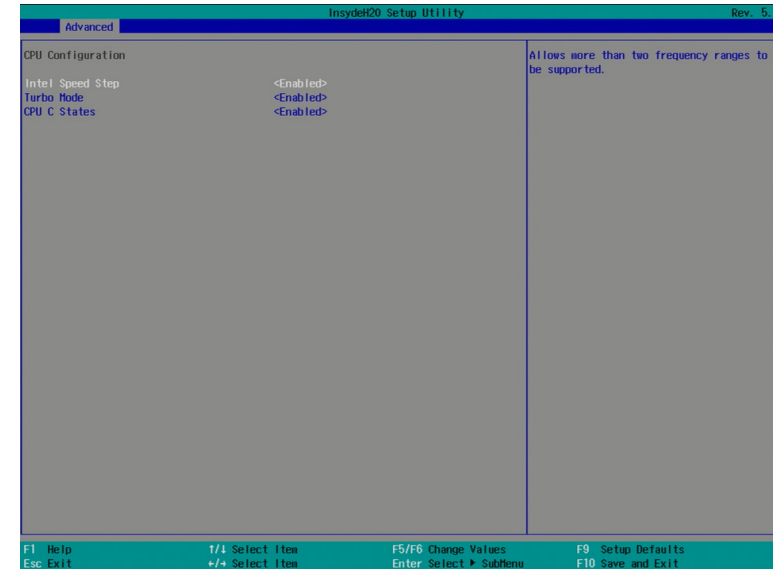

### Intel® SpeedStep™

Enable or disable the Enhanced Intel SpeedStep® Technology, which helps optimize the balance between system's power consumption and performance. After it is enabled in the BIOS, you can enable the EIST feature using the operating system's power management.

### Turbo Mode

Enable or disable processor turbo mode, which allows the processor core to automatically run faster than the base frequency when by taking advantage of thermal and power headroom. Note this option is not available on Core i3 processors.

### CPU C States

Enable or disable CPU Power Management. It allows the CPU to go to C states when it's not 100% utilized.



#### Note:

With some Linux kernel OS such as Debian, CentOS, Ubuntu, this option needs to be set to "disabled" before installation.

## Video Configuration

This section configures video settings.

### Primary Display

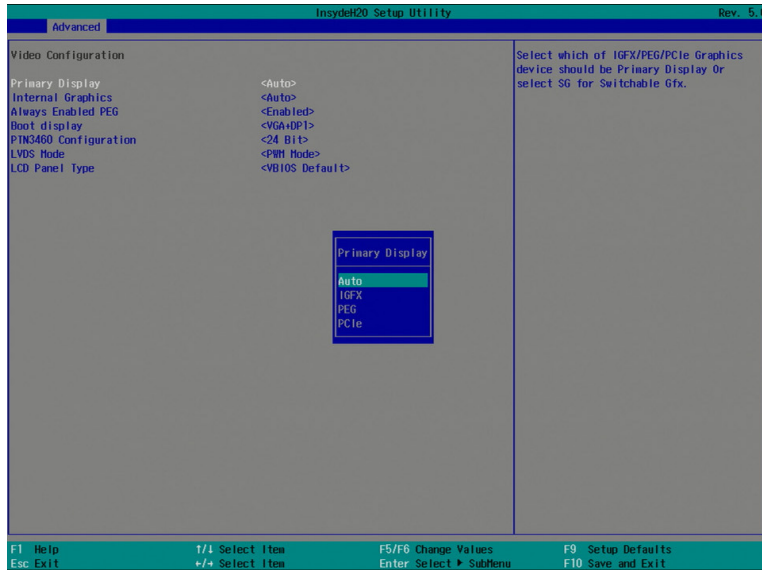

### Primary Display

Select either integrated graphics function (IGFX) or PCIe graphics device (PEG) to be the primary display. Note that this option is only available if the boot type is set to "Dual" or "UEFI".

### Internal Graphics Device

Enable or disable the integrated graphics function (IGFX).

### Boot display

Set the display device combination during boot. Note this option is only available when the boot type is set to "Dual" or "Legacy".

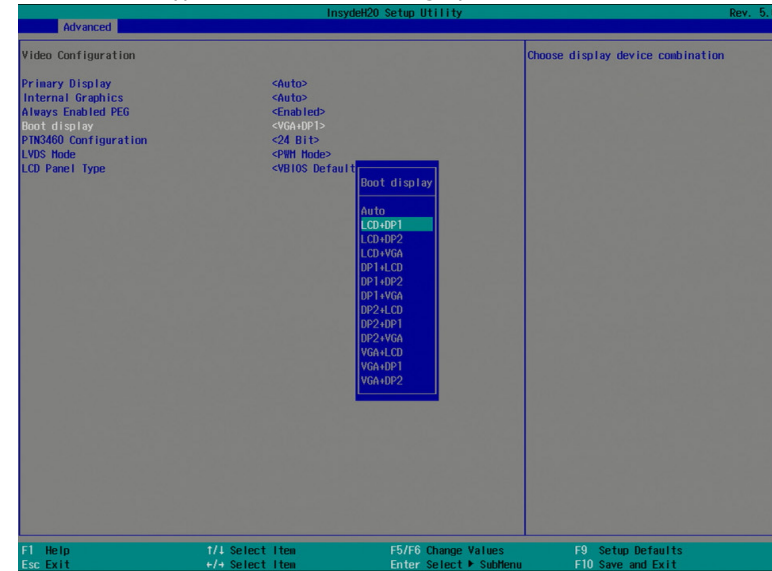

### PTN3460 Configuration

Select the display panel color depth: 18 bit, 24 bit, 36 bit, and 48 bit.



## LCD Panel Type

Select the resolution for your LCD panel.

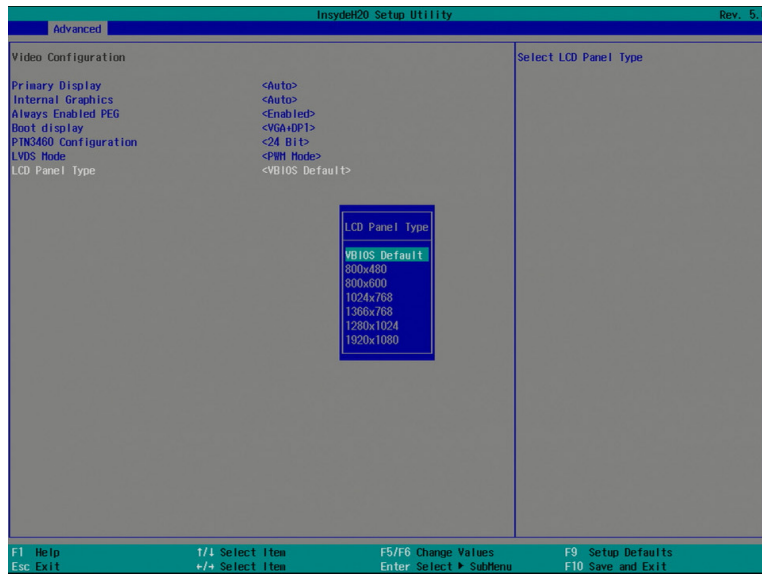

## Backlight Type

Select the backlight brightness control using the Pulse Width Modulation (PWM) or the DC mode.

## Audio Configuration

This section configures audio settings.

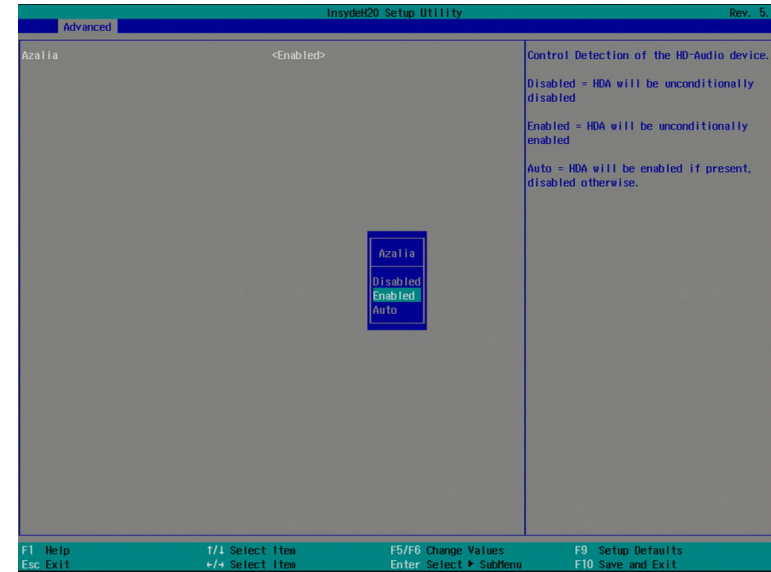

## Azalia

Control the detection of the High-Definition Audio device.

### Disabled

High Definition Audio will be unconditionally disabled.

### Enabled

High Definition Audio will be unconditionally enabled.

### Auto

High Definition Audio will be enabled if present and disabled otherwise.

## SATA Configuration

This section configures SATA controllers and their mode of operation.

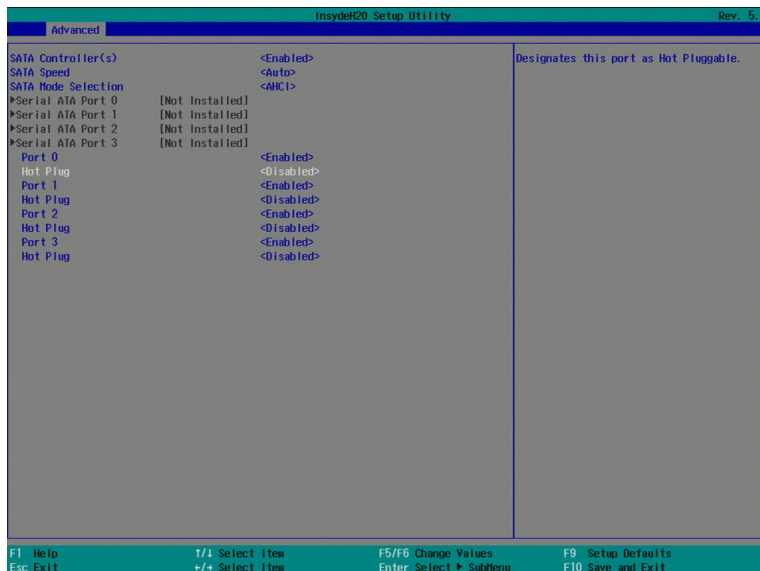

### SATA Controller(s)

Enable or disable Serial ATA devices.

### SATA Speed

Select Serial ATA device speed from Gen1 (1.5 Gbit/s), Gen2 (3 Gbit/s), Gen 3 (6 Gbit/s) or auto.

### SATA Mode Selection

The mode selection determines how the SATA controller(s) operates.

#### AHCI Mode

This option allows the Serial ATA devices to use AHCI (Advanced Host Controller Interface).

#### RAID Mode

This option allows you to create RAID using Intel® Rapid Storage Technology on the Serial ATA devices.

### Serial ATA Port 0, 1, 2, and 3 Hot Plug

Enable or disable each Serial ATA port and its hot plug function.

## USB Configuration

This section configures the parameters of the USB device.

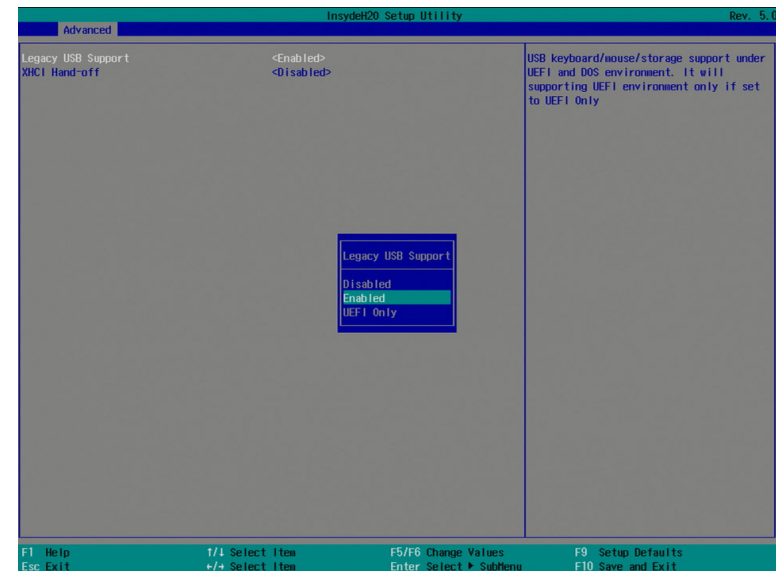

### Legacy USB Support

#### Disabled

Disable USB keyboard/mouse/storage support.

#### Enabled

Enable USB keyboard/mouse/storage support under UEFI and DOS environment.

#### UEFI Only

Enable USB keyboard/mouse/storage support only under UEFI environment.

### xHCI Hand-off

Set this option to disabled if the operating system supports xHCI hand-off (e.g. more recent versions of Windows) and enabled if the operating system does not support xHCI hand-off (e.g. older versions of Windows).

## PCI Express Configuration

This section configures the settings of the PCIe root ports.

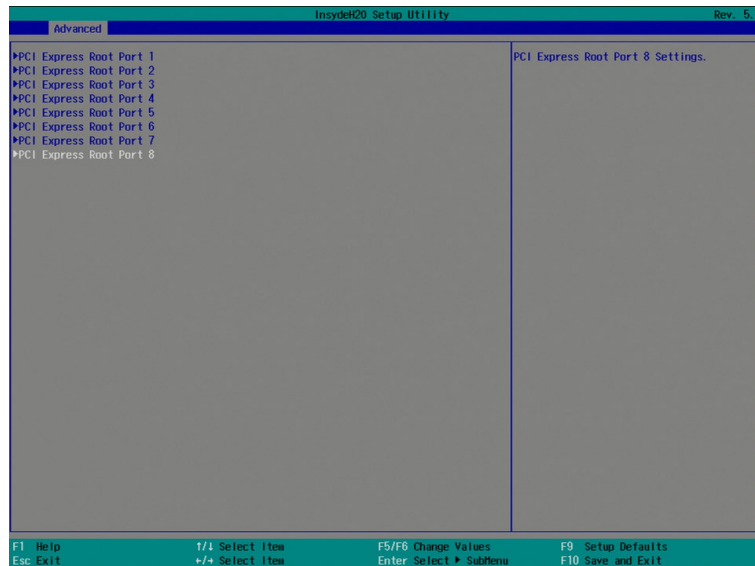

## PCI Express Root Port 1 to PCI Express Root Port 8

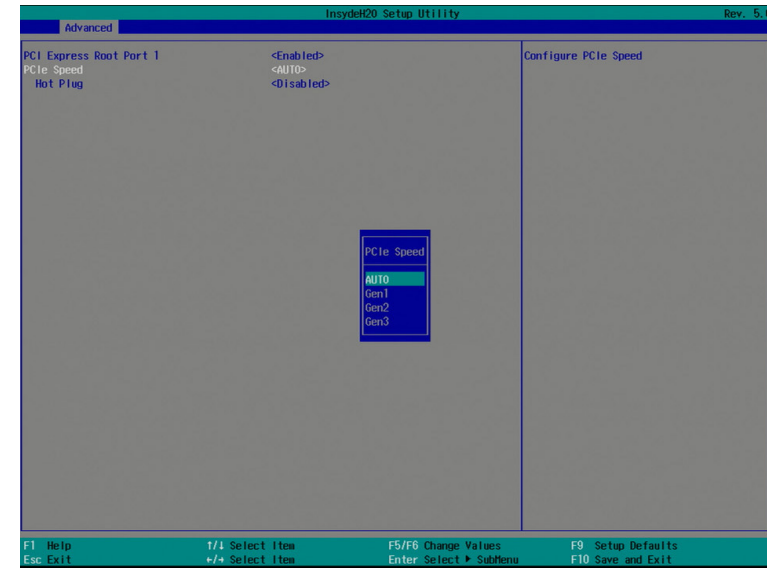

### PCI Express Root Port

Enable or disable each PCI Express Root Port.

### PCIe Speed

Select the speed of the PCI Express Root Port: Auto, Gen1 (2.5 GT/s), Gen2 (5 GT/s) or Gen3 (8 GT/s).

### Hot Plug

Enable or disable the hot plug function of each PCIe root port.

## ME Configuration

This section configures the settings of flashing the Intel® Management Engine (ME).

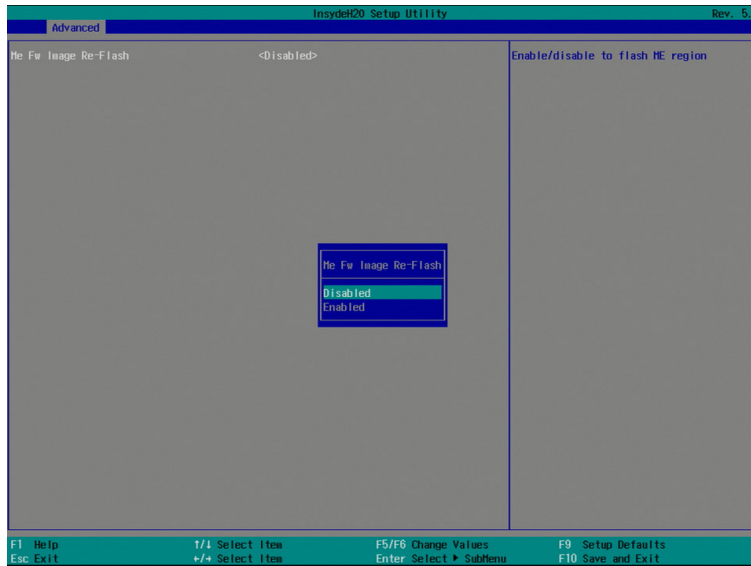

### Me Fw Image Re-Flash

Enable or disable flashing of the Intel® Management Engine (ME) region of the BIOS.

## Active Management Technology Support

The section allows users to enable or disable the Intel® Active Management Technology (Intel® AMT) BIOS extension. Note that this function is not available on Core™ i3 processors or HM175 chipset. Refer to Chapter 7 for more information.



### Intel AMT Support

Enable or disable the Intel® Active Management Technology (AMT) support of the BIOS.

### Un-Configure ME

Enable to clear all settings of the Intel® Active Management Technology (AMT) without requiring a password on the next boot.



## Debug Configuration

This section configures the debug function.

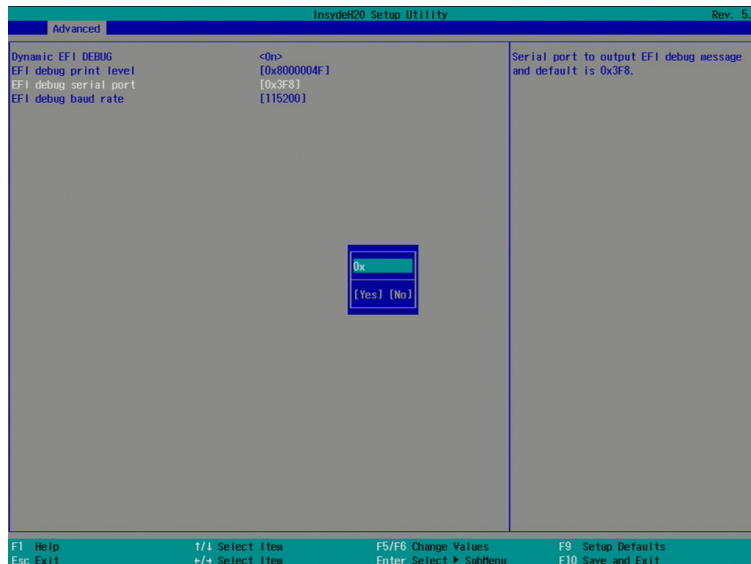

### Dynamic EFI Debug

Enable or disable output of the log messages for debugging through a serial port. If you select to enable this function, please set a serial port for this purpose with the following parameters:

#### EFI debug print level

Enter or choose the desired print level for displaying different type of log messages. The options are as follows:

- 0x00000001: Display messages of system initialization
- 0x00000002: Display warning messages
- 0x00000004: Display messages of Load events
- 0x00000008: Display messages of EFI File system
- 0x00000040: Display informational debug messages
- 0x80000000: Display Error messages
- 0x8000004F: Display all types of messages shown above

#### EFI Debug serial port

Enter or choose the serial port number for message output. The options are COM1 (0x3F8) and COM2 (0x2F8).

#### EFI Debug baud rate

Enter or choose the baud rate for serial communication. The default is 115200.

## Device Manager

The system board allows RAID configuration on Serial ATA drives using Intel® Rapid Storage Technology. It supports RAID 0, RAID 1, RAID 5 and RAID 10. Select this menu to enter the Device Manager program for RAID configuration. Refer to Chapter 6 for more information.

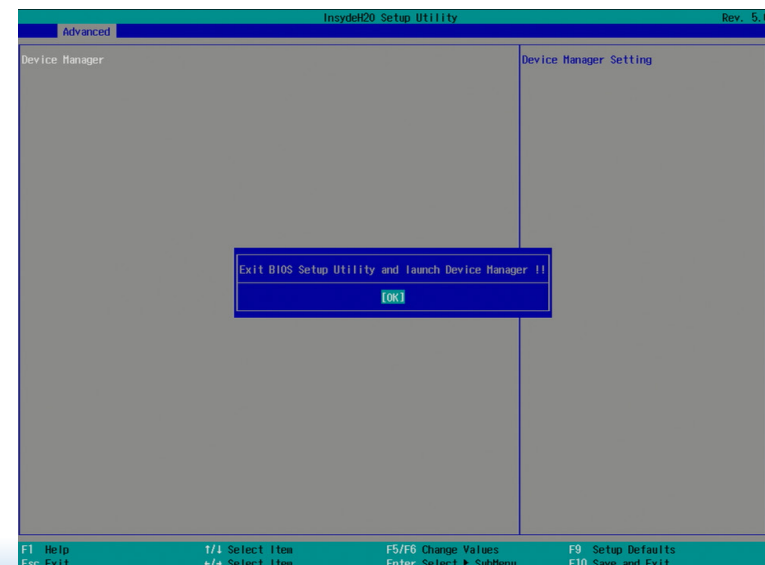
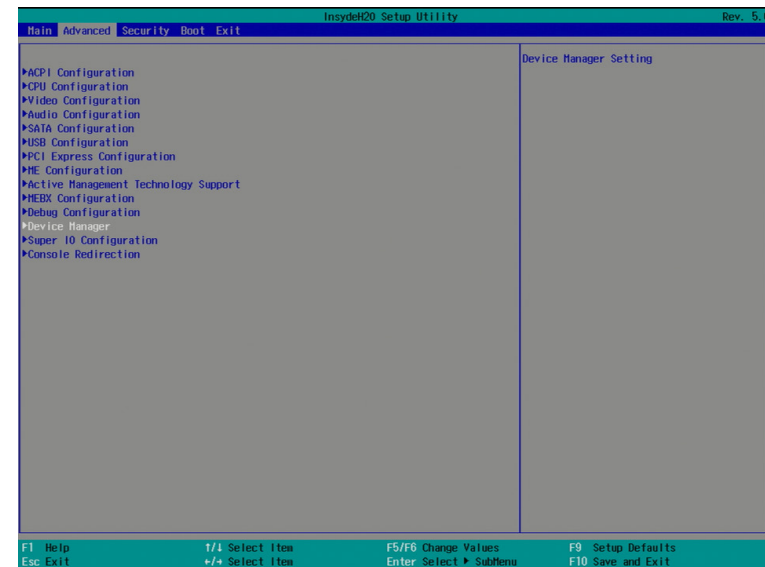

## Super IO Configuration

This section configures COM port settings and displays PC health information.

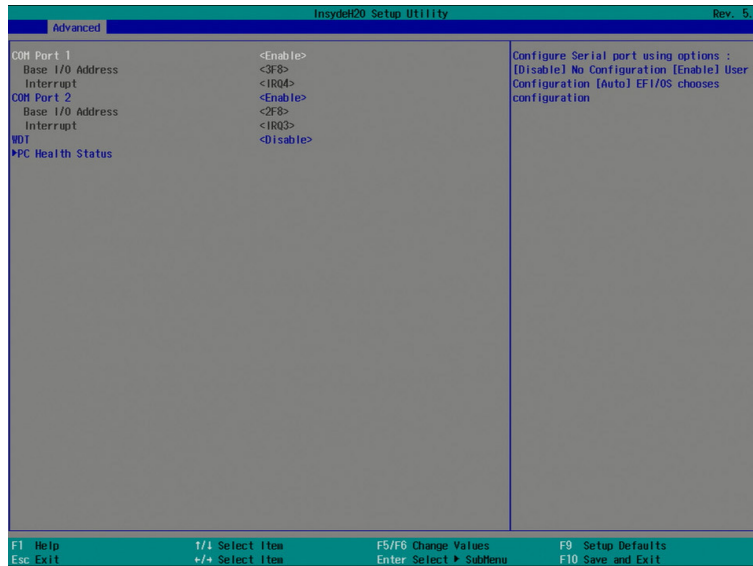

### COM Port 1 to COM Port 2

Enable or disable each serial port.

## WDT

Enable or disable the watchdog function. A counter will appear if you select to enable WDT. Input any value between 1 to 255 seconds.

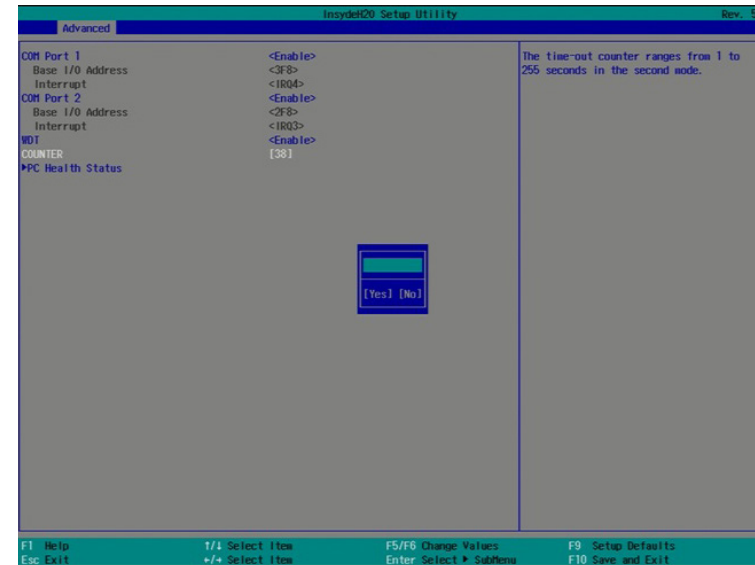

## PC Health Status

The screen displays the PC health status such as the CPU temperature and fan speeds.

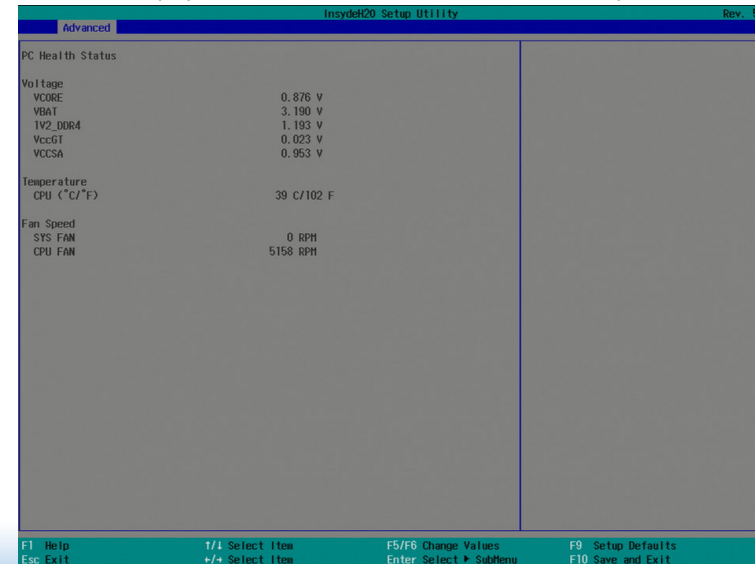

## Console Redirection

Console redirection lets you monitor and control a system from a remote station by re-directing the host screen output through a serial port.

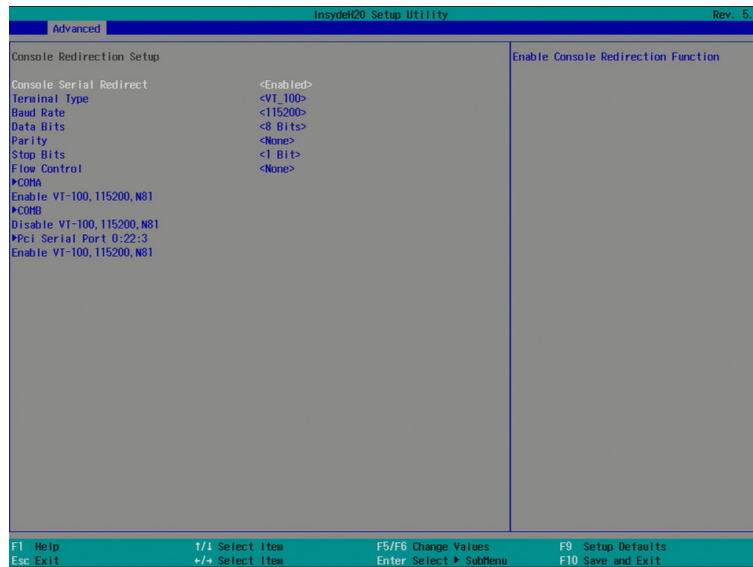

### Console Serial Redirect

Enable or disable the console redirection function. (The default is disabled.) If you select to enable it, please configure the following parameters for serial communication between the system and a remote station:

Terminal type: VT\_100, VT\_100+, VT\_UTF8 or PC\_ANSI.

Baud rate: 115200, 57600, 38400, 19200, 9600, 4800, 2400 or 1200.

Data bits: 8 Bits or 7 Bits.

Parity: None, Even or Odd.

Stop bits: 1 Bit or 2 Bits.

Flow control: None, RTS/CTS or XON/XOFF

This is the global setting for all of the designated serial ports for the console redirection function.

### COMA/COMB/PCI Serial Port

Enable or disable the serial redirection function for each of the detected serial ports on the system. And configure the serial communication parameters to be used between the system and a remote station. Alternatively, choose to use the pre-configured global settings from the previous menu.

## Security

This section configures security-related settings.

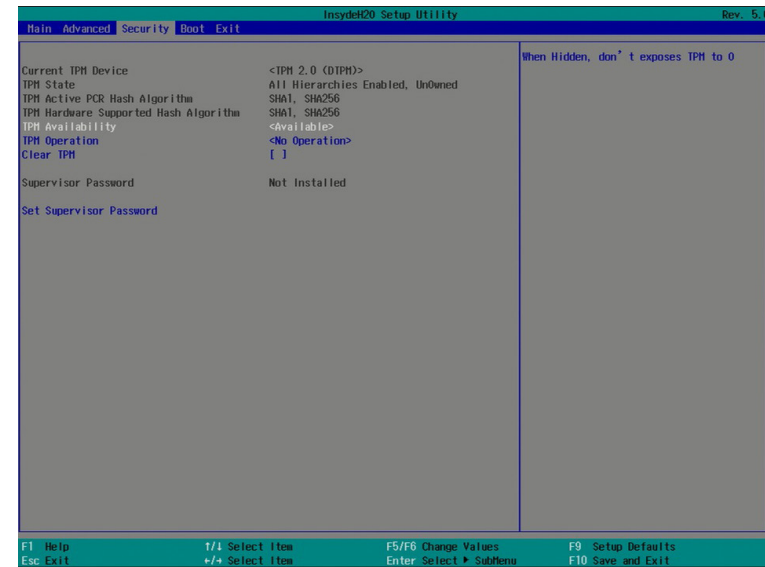

### TPM Availability

Show or hide the TPM availability and its configurations.

### TPM Operation

Enable or disable the TPM function. It displays the following options:

- No Operation: No changes to the current state.
- Disable: Disable and deactivate TPM.
- Enable: Enable and activate TPM.

### Clear TPM

Remove all TPM ownership contents.

### Set Supervisor Password

Enter to set supervisor password for entering the BIOS setup utility or upon power-on self-test (POST) depending on the configuration of the following Power-on Password option.

### Power on Password

If you select to set the supervisor password, this option will be shown. Enable or disable the system to require password at boot.

## Boot

This section configures boot options.



### Numlock

Turn on or off the number lock key at boot.

### Boot Type

Select the boot mode. The options are Dual Boot Type, Legacy Boot Type, and UEFI Boot Type.

### Network Stack

This option is shown only when the boot type is set to "Dual" or "UEFI". Enable or disable UEFI network stack. It supports the operation of these functions or software: Windows 8 BitLocker Network Unlock, UEFI IPv4/IPv6 PXE and legacy PXE Option ROM.

### PXE Boot Capability

Enable or disable Preboot eXecution Environment (PXE) through LAN.

### USB Boot

Enable or disable boot from USB devices.



#### Note:

If the boot type is set to UEFI, the method for RAID volume creation will be different. Please refer to Chapter 6 for more information.

## Boot Device Priority

This section configures legacy or EFI boot order or both depending on the "Boot Type" selected.



### EFI Boot Menu

Use + and - keys to arrange the priority of the boot devices in the list.

### Normal Boot Menu

#### Normal

For this option, determine the boot order for the devices within each category. Use + and - keys to arrange the priority of the boot devices in the list. The first device in the list has the highest boot priority.

#### Advance

For this option, determine the boot order for all boot devices. Use + and - keys to arrange the priority of the detected boot devices in the list. The first device in the list has the highest boot priority.

### Boot Type Order

Use + and - keys to arrange the sequence of storage devices that the system's hardware checks for the operating system's boot files. The first device in the order list has the highest boot priority. For example, to boot from a floppy drive instead of a hard drive, place the floppy drive ahead of the hard drive in priority.

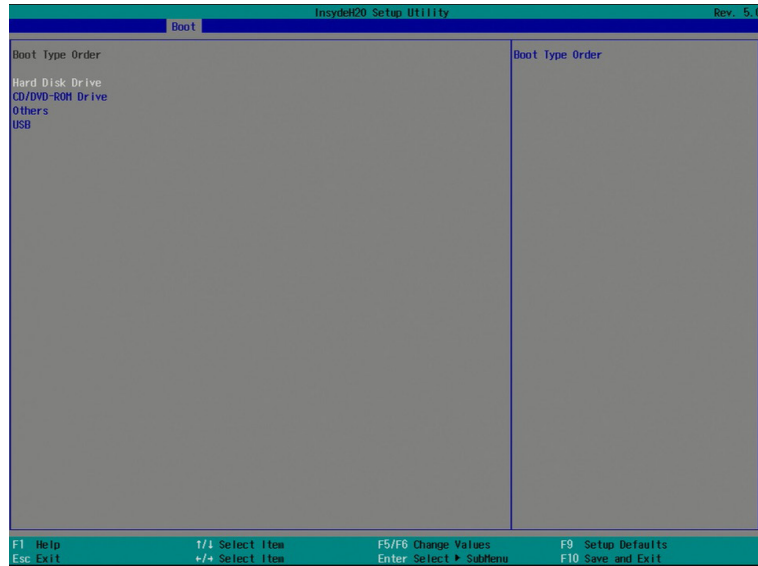

### Hard Disk Drive

All installed hard disk drives will be displayed in this field. Use + and - keys to arrange the sequence of hard disk drives that the system's hardware checks for the operating system's boot files.

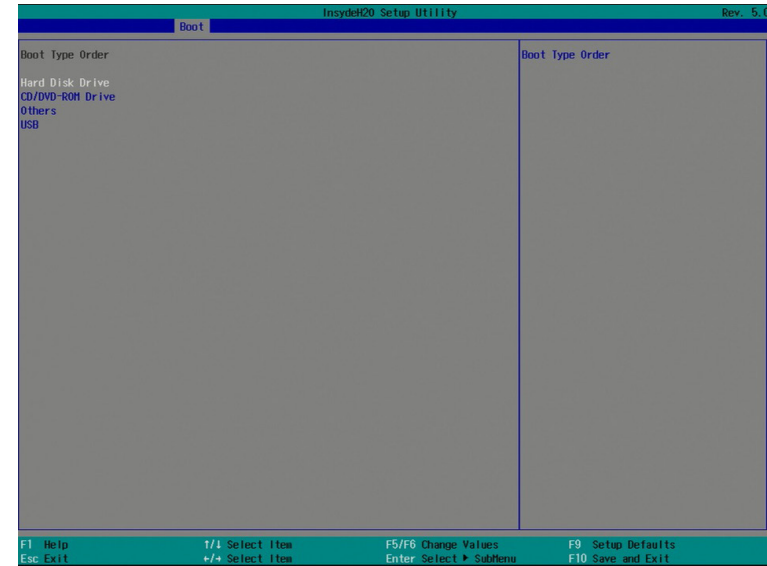

## Exit

This section configures options for exiting the BIOS setup utility.

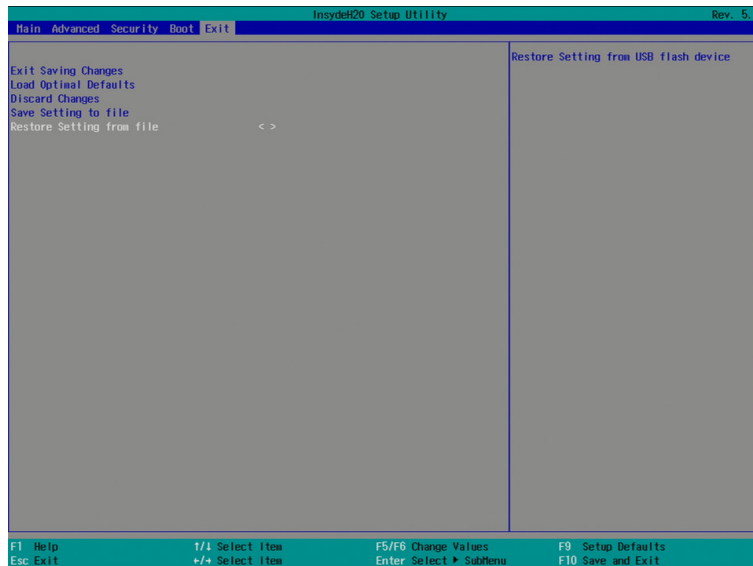

### Exit Saving Changes

Select this field and then press <Enter> to save your changes and exit the setup program.

### Load Optimal Defaults

Select this field and then press <Enter> to load optimal defaults.

### Discard Changes

Select this field and then press <Enter> to exit the system setup without saving your changes.

### Save Setting to file

Select this option to save BIOS configuration settings to a USB drive. The operation will fail if there aren't any USB devices detected on the system. The saved configuration will have the DSF file extension and can be used for restoration.

### Restore Setting from file

Select this option to restore BIOS configuration settings from a USB drive. Note that this option will not be available if there aren't any USB devices detected on the system.

## Updating the BIOS

To update the BIOS, you will need the new BIOS file and a flash utility. Please contact technical support or your sales representative for the files and specific instructions about how to update BIOS with the flash utility.

When you download the given BIOS file, you may find a BIOS flash utility attached with the BIOS file. This is the utility for performing BIOS updating procedure. For your convenience, we will also provide you with an auto-execution file in the BIOS file downloaded. This auto-execution file will bring you directly to the flash utility menu soon after system boots up and finishes running the boot files on your boot disk.

```

Read file successfully. (path= "platform.ini")

Information
Please do not remove the AC power

Insyde H20FFT (Flash Firmware Tool) Version (SEG) 100.00.08.10
Copyright(c) 2012 - 2016, Insyde Software Corp. All Rights Reserved.

Initializing
Current BIOS Model name: KH960
New BIOS Model name: KH960

Current BIOS version: 65.05A
New BIOS version: 65.05A

Updating Block at FFFFF000h
0%      25%      50%      75%      100%
|-----|-----|-----|-----|
C:\KH960>_

```

## Notice: BIOS SPI ROM

1. The Intel® Management Engine has already been integrated into this system board. Due to the safety concerns, the BIOS (SPI ROM) chip cannot be removed from this system board and used on another system board of the same model.
2. The BIOS (SPI ROM) on this system board must be the original equipment from the factory and cannot be used to replace one which has been utilized on other system boards.
3. If you do not follow the methods above, the Intel® Management Engine will not be updated and will cease to be effective.

### Note:



- a. You can take advantage of flash tools to update the default configuration of the BIOS (SPI ROM) to the latest version anytime.
- b. When the BIOS IC needs to be replaced, you have to populate it properly onto the system board after the EEPROM programmer has been burned and follow the technical person's instructions to confirm that the MAC address should be burned or not.

## Chapter 5 - Supported Software

The DVD that came with the system board contains drivers, utilities and software applications required to enhance the performance of the system board.

Insert the DVD into a DVD-ROM drive. The autorun screen (Mainboard Utility DVD) will appear. If the "Autorun" does not automatically start, please go directly to the root directory of the DVD and double-click "Setup".

### Auto Run Page (For Windows 10)

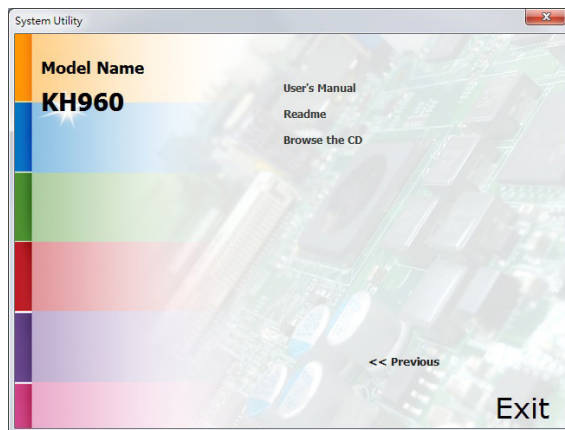
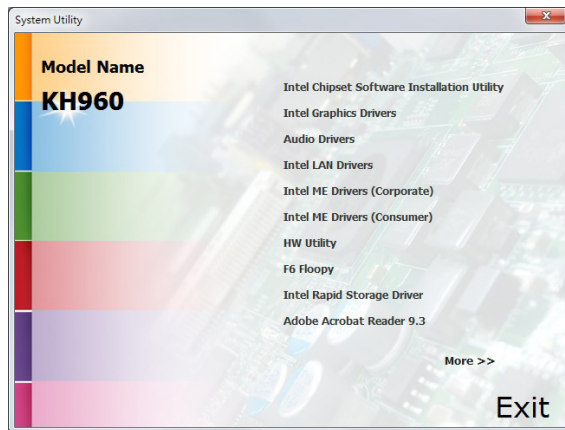

### Intel Chipset Software Installation Utility

The Intel Chipset Software Installation Utility is used for updating Windows® INF files so that the Intel chipset can be recognized and configured properly in the system.

To install the utility, click "Intel Chipset Software Installation Utility" on the main menu.

1. Setup is ready to install the utility. Click "Next".

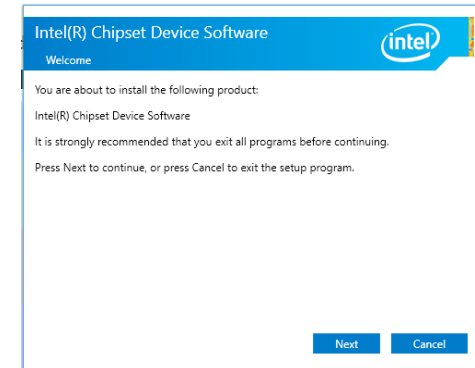

2. Read the license agreement, then click "Yes".

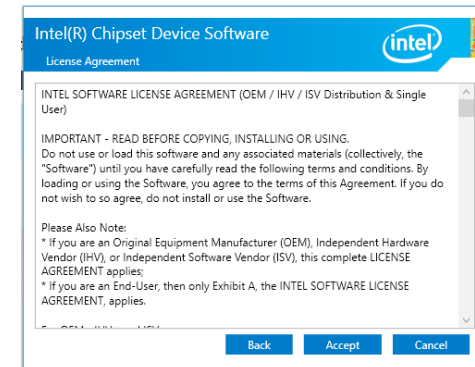



- Go through the readme document for system requirements and installation tips, then click "Next". Please wait while the installation is in progress.

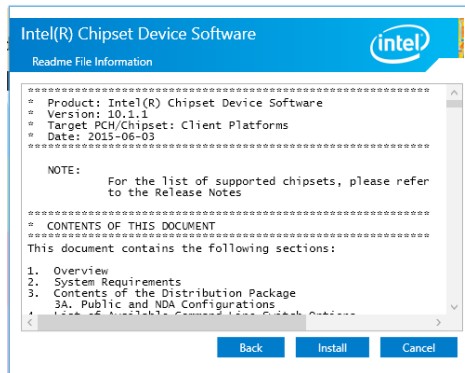

- Please wait while the installation is in progress.

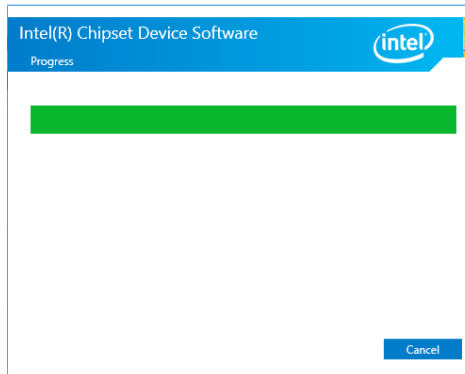

- Click "Restart Now" to allow the new software installation to take effect.

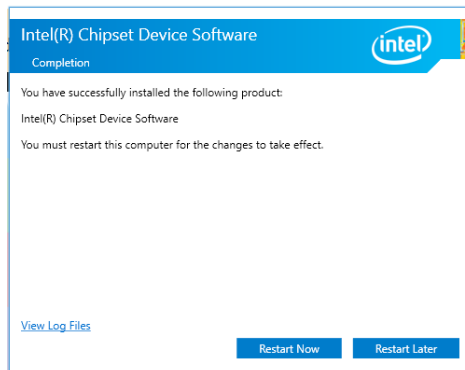

## Audio Drivers (for COM332-B Carrier Board)

To install the driver, click "Audio Drivers" on the main menu.

- Setup is now ready to install the audio driver. Click "Next".
- Follow the rest of the steps on the screen; click "Next" each time you finish a step.

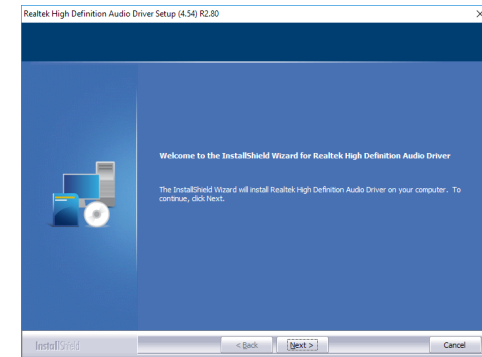

- Click "Yes, I want to restart my computer now", then click "Finish".

Restart the system to allow the new software installation to take effect.

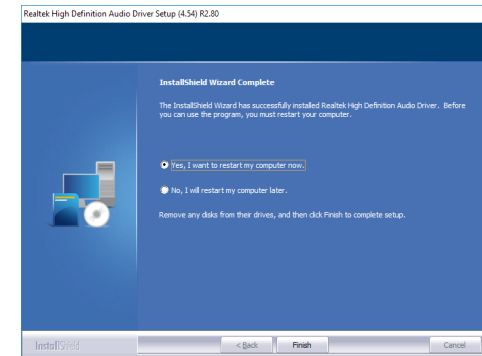

## Intel Graphics Drivers

To install the driver, click "Intel Graphics Drivers" on the main menu.

1. Setup is now ready to install the graphics driver. Click "Next".

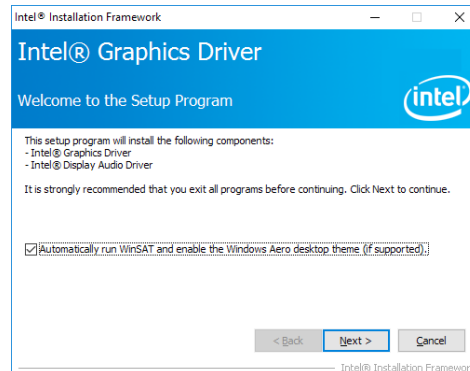

By default, the "Automatically run WinSAT and enable the Windows Aero desktop theme" is enabled. With this is enabled and after the system is rebooted, the screen will turn blank for 1 to 2 minutes (while WinSAT is running) before the Windows 7/ Windows 8.1/ Windows 10 desktop appears. The "blank screen" period is the time Windows is testing the graphics performance.

We recommend that you skip this process by disabling this function and then click "Next".

2. Read the license agreement, then click "Yes".

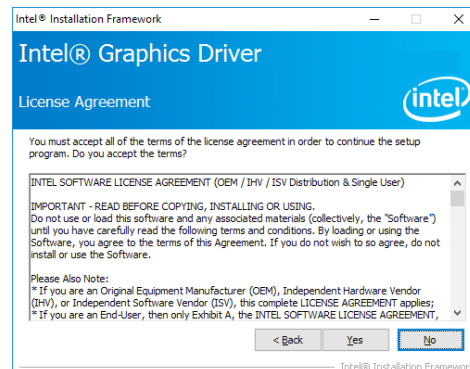

3. Go through the readme document for system requirements and installation tips, then click "Next".

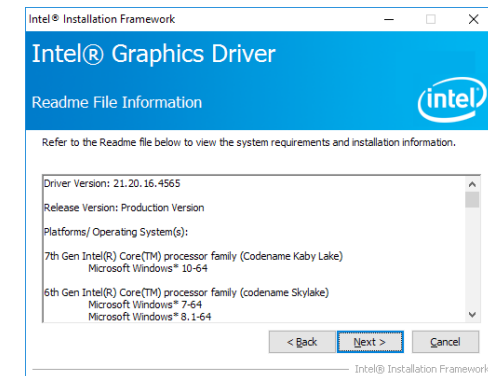

4. Setup is now installing the driver. Click "Next" to continue.

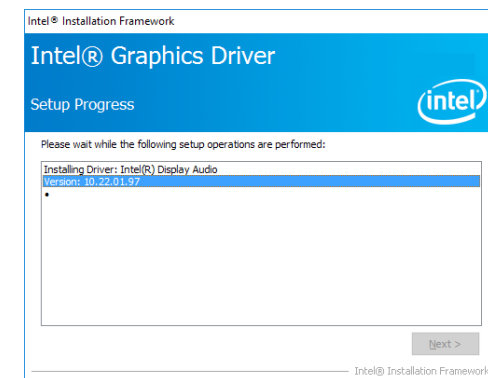

5. Click "Yes, I want to restart this computer now", then click "Finish".

Restarting the system will allow the new software installation to take effect.

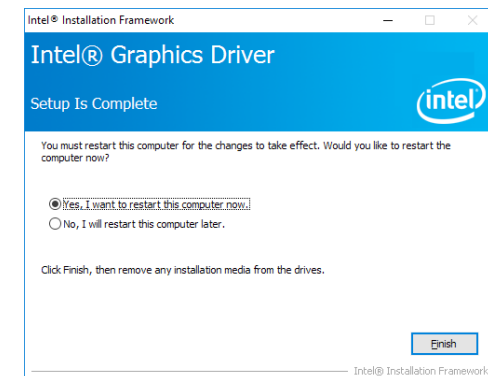

## Intel LAN Drivers

To install the driver, click "Intel LAN Drivers" on the main menu.

1. Setup is preparing to install the driver. Click "Next" to continue.

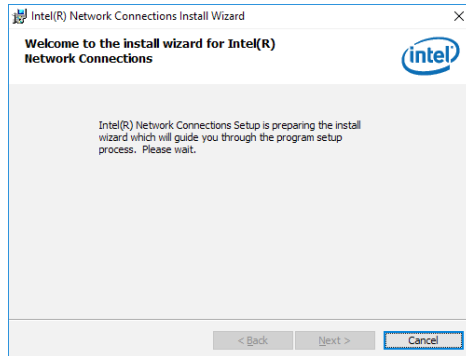

2. Click "I accept the terms in the license agreement" if you accept the agreement, then click "Next".

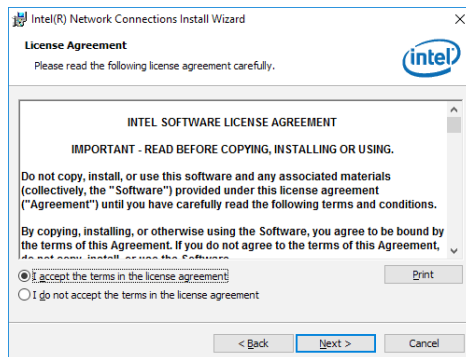

3. Select the program features you want installed, then click "Next".

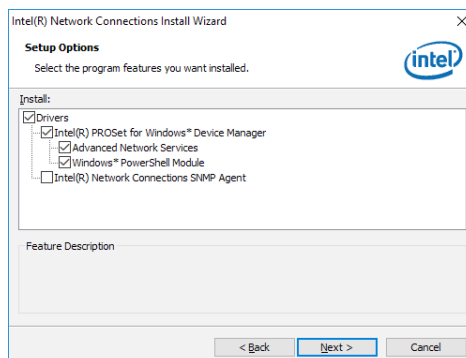

4. Click "Install" to begin the installation.

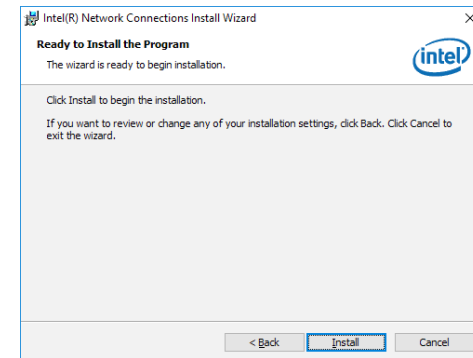

5. After the installation is complete, click "Finish".

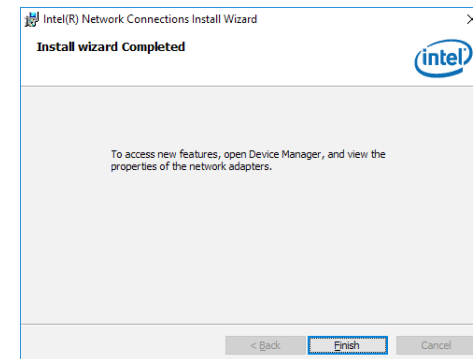

## Intel Management Engine Drivers

To install the driver, click "Intel Management Engine Drivers" on the main menu.

1. Setup is ready to install the driver. Click "Next" to continue.

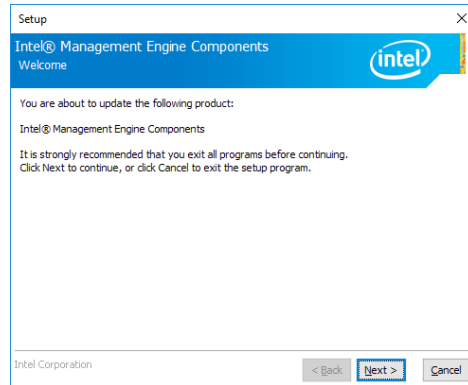

2. Read the license agreement and click "I accept the terms in the license agreement" if you accept the agreement, then click "Next".

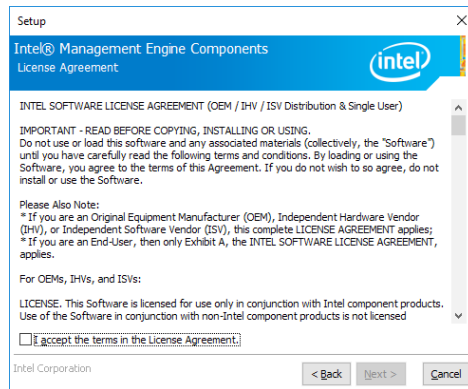

3. Setup is currently installing the driver. After the installation is complete, click "Next".

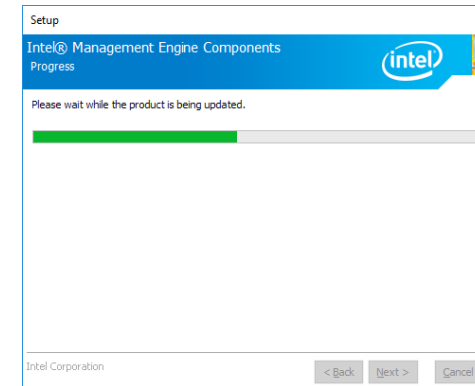

4. After the installation is complete, click "Finish" to exit the setup program.

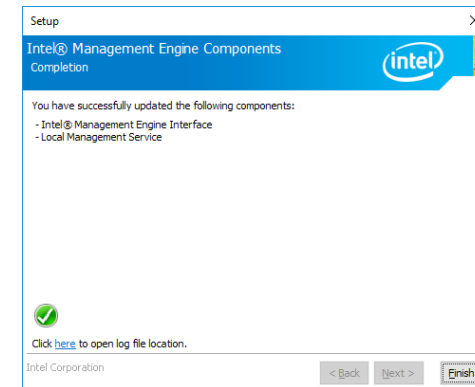

## Intel Rapid Storage Technology

The Intel Rapid Storage Technology is a utility that allows you to monitor the current status of the SATA drives. It enables enhanced performance and power management for the storage subsystem.

To install the driver, click "Intel Rapid Storage Technology" on the main menu. Please refer to **Chapter 6** for more information.

## Adobe Acrobat Reader 9.3

To install the reader, click "Adobe Acrobat Reader 9.3" on the main menu.

1. Please wait while the Setup program is being processed.

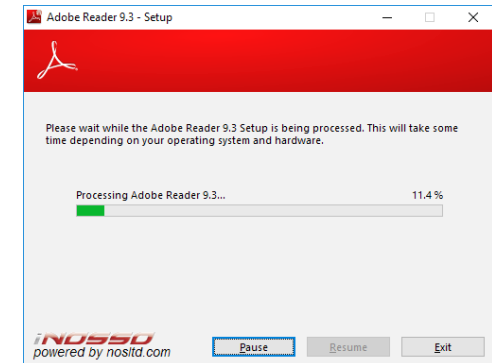

2. Click "Install" to begin installation.

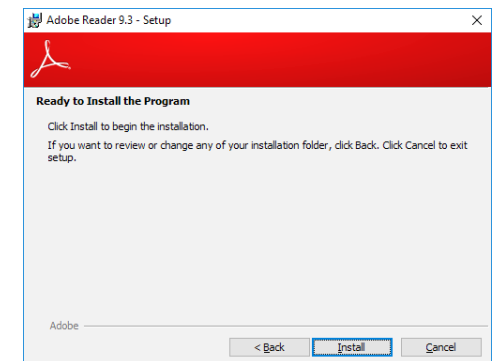

3. Click "Finish" to exit the installation.

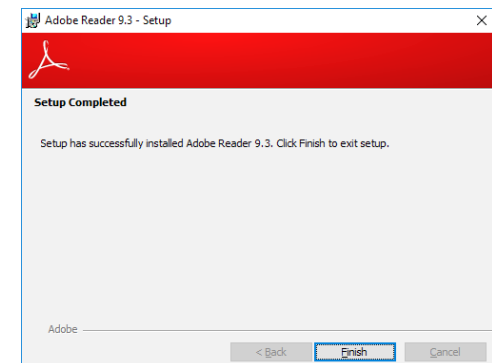

## HW Utility

HW Utility provides information about the board and configuration of the Watchdog and DIO. To access the utility, click "HW Utility" on the main menu.



### Note:

If you are using Windows 7 or later versions, you need to access the operating system as an administrator to be able to install the utility.

1. Setup is ready to install the driver.

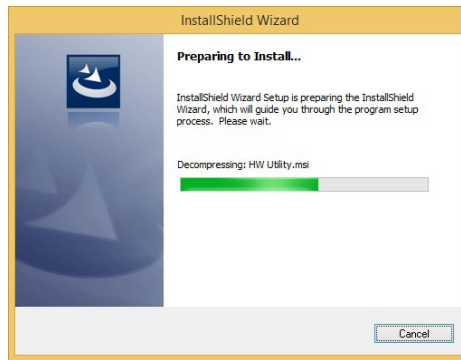

2. Click "Next" to continue.

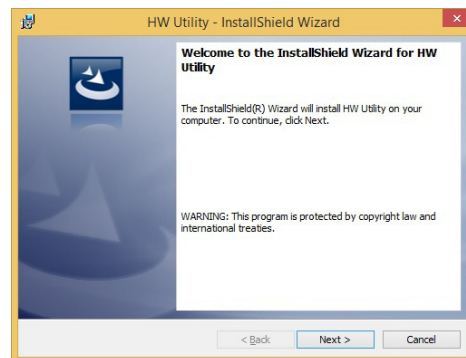

3. Read the license agreement, then click "I accept the terms in the license agreement". Click "Next".

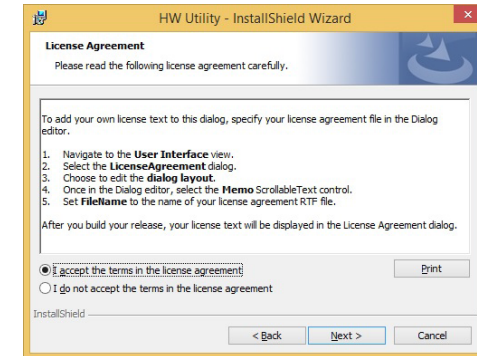

4. The wizard is ready to begin installation. Click "Install".

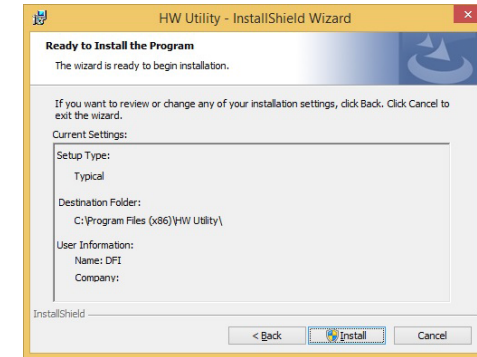

5. Please wait while the program features are being installed.

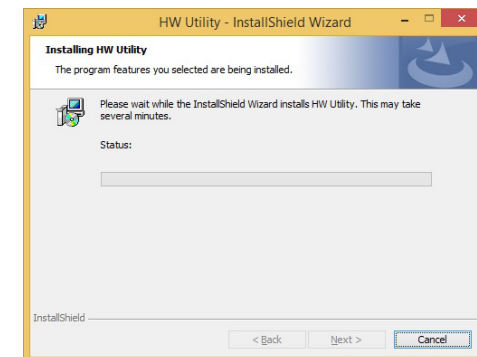

6. After the installation is complete, click "Finish".



The HW Utility icon will appear on the desktop. Double-click the icon to open the utility.



Information



HW Health

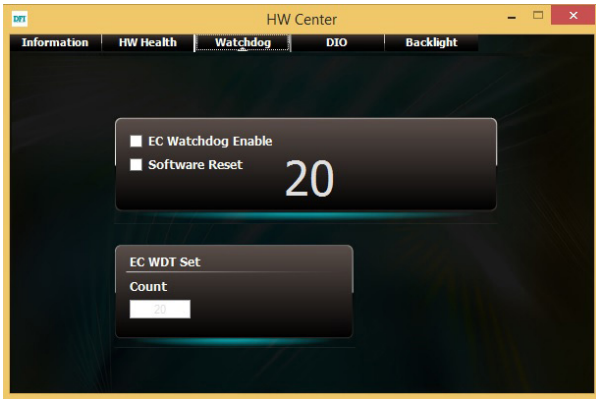

Watchdog

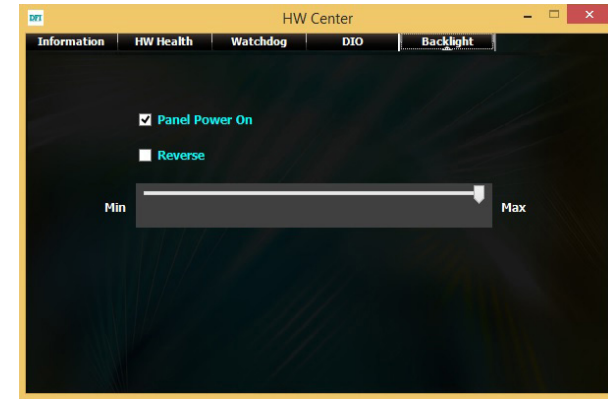

Backlight



DIO



## Chapter 6 - RAID

The system board allows RAID configuration with levels of RAID 0, RAID 1, RAID 5 and RAID 10.

### RAID Levels

#### RAID 0 (Striped Disk Array without Fault Tolerance)

RAID 0 uses two new identical hard disk drives to read and write data in parallel, interleaved stacks. Data is divided into stripes and each stripe is written alternately between two disk drives. This improves the I/O performance of the drives at different channel; however it is not fault tolerant. A failed disk will result in data loss in the disk array.

#### RAID 1 (Mirrored Disk Array with Fault Tolerance)

RAID 1 copies and maintains an identical image of the data from one drive to the other drive. If a drive fails to function, the disk array management software directs all applications to the other drive since it contains a complete copy of the drive's data. This enhances data protection and increases fault tolerance to the entire system. Use two new drives or an existing drive and a new drive but the size of the new drive must be the same or larger than the existing drive.

#### RAID 5 (Striped Disk Array with Distributed Parity)

RAID 5 stripes data and parity information across hard drives. It is fault tolerant and provides better hard drive performance and higher disk utilization than RAID 1.

#### RAID 10 (Mirrored and Striped Disk Array)

RAID 10 is a combination of data striping and data mirroring providing the benefits of both RAID 0 and RAID 1.

RAID Level	Min. Drives	Protection	Description
RAID 0	2	None	Data striping without redundancy
RAID 1	2	Single Drive Failure	Disk mirroring
RAID 5	3	Single Drive Failure	Block-level data striping with distributed parity
RAID 10	4	1 Disk Per Mirrored Stripe (not same mirror)	Combination of RAID 0 (data striping) and RAID 1 (mirroring)

### Settings

To enable the RAID function, the following settings are required.

1. Connect the Serial ATA drives.
2. Enable RAID in the BIOS.
3. Create a RAID volume.
4. Install the Intel Rapid Storage Technology Utility.

#### Step 1: Connect the Serial ATA Drives

Refer to carrier board manual for details on connecting the Serial ATA drives.



#### Important:

1. Make sure you have installed the Serial ATA drives and connected the data cables otherwise you won't be able to enter the RAID BIOS utility.
2. Treat the cables with extreme caution especially while creating RAID. A damaged cable will ruin the entire installation process and operating system. The system will not boot and you will lost all data in the hard drives. Please give special attention to this warning because there is no way of recovering back the data.

#### Step 2: Enable RAID in the BIOS

1. Power on the system then press <Del> to enter the main menu of the BIOS.
2. Go to "Advanced" menu, and select the "SATA Configuration" menu.
3. Change the "SATA Mode Selection" to "RAID" mode.
4. Save the changes in the "Exit" menu.
5. Reboot the system.

### Step 3: Create a RAID Volume

1. When the Intel® RST option ROM status screen displays during POST, press <Ctrl> and <I> simultaneously to enter the option ROM user interface.
2. Select 1: Create RAID Volume and press <Enter>.
3. Use the up or down arrow keys to select the RAID level and press <Enter>.
4. Use the up or down arrow keys to select the strip size and press <Enter>.
5. Press <Enter> to select the physical disks.
6. Use the up or down arrow keys to scroll through the list of hard drives and press <Space> to select the drive.
7. Press <Enter>.
8. Select the volume size and press <Enter>. You must select less than one hundred percent of the available volume space to leave space for the second volume.
9. Press <Enter> to create the volume.
10. At the prompt, press <Y> to confirm volume creation.
11. Select 4: Exit and press <Enter>.
12. Press <Y> to confirm exit.



**Note:**

These steps are cited from the Intel® Support site, "Set Up a System with Intel® Matrix RAID Technology" (Article ID: 000005789).

### Step 3-1: Create a RAID Volume if the boot type is UEFI

If the boot type is set to UEFI, RAID volume creation will be different. Please use the following steps to create RAID volumes. To set the boot type, enter the BIOS utility and go to "Boot" > "Boot type".

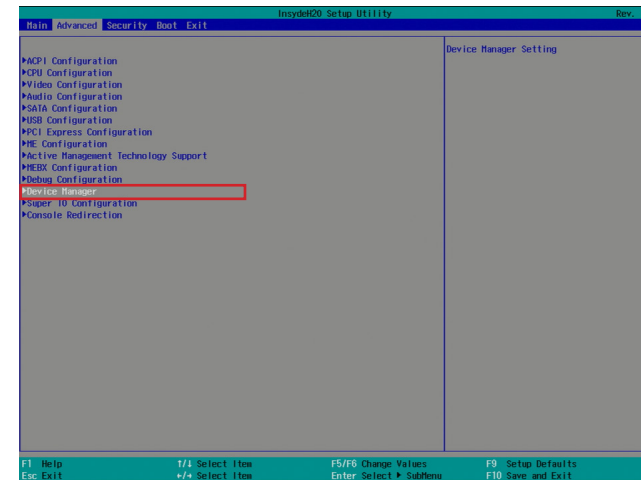
1. In the BIOS, go to the "Advanced" > "Device Manager".



2. Select Device Manager. The system will prompt you that it is going to exit the BIOS utility. Select "OK" to continue.
3. The "Intel® Rapid Storage Technology" menu appears. Enter this menu.



- The screen displays all available drives. Select "Create RAID volume" to create a RAID volume".
- Use the up or down arrow keys to select the RAID level and press <Enter>.
- Use the up or down arrow keys to scroll through the list of hard drives and press <Enter> and select "x" to select the drive for the RAID group.
- Use the up or down arrow keys to select the strip size and press <Enter>.
- Enter the capacity for the volume and press <Enter>.
- Select "Create Volume" to start creating the volume.



## Step 4: Install the Intel Rapid Storage Technology Utility

The Intel Rapid Storage Technology Utility can be installed from within Windows. It allows RAID volume management (create, delete, migrate) from within the operating system. It will also display useful SATA device and RAID volume information. The user interface, tray icon service and monitor service allow you to monitor the current status of the RAID volume and/or SATA drives. Furthermore, It enables enhanced performance and power management for the storage subsystem.

- Insert the provided DVD into an optical drive.
- Click "Intel Rapid Storage Driver" on the main menu.
- Setup is ready to install the utility. Click "Next" to continue.

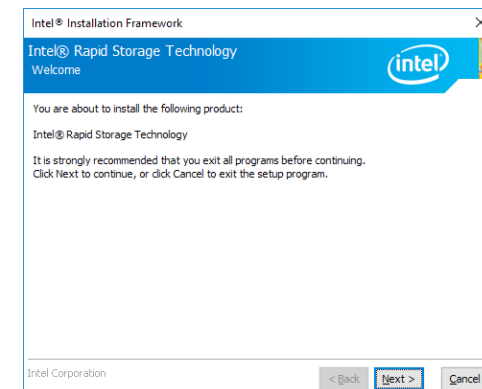

- Read the license agreement and click "I accept the terms in the License Agreement" if you accept the agreement. Then, click "Next".

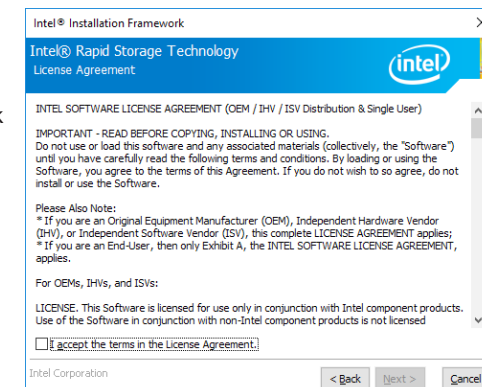

5. Go through the readme document to view system requirements and installation information, then click "Next".

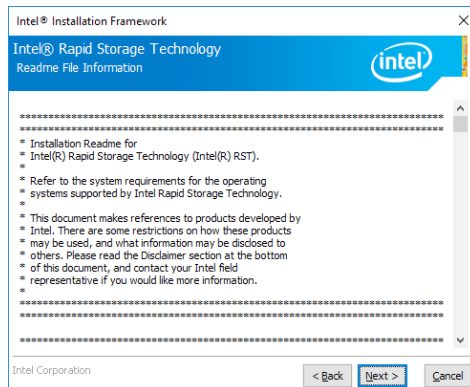

6. Click "Next" to install to the default folder or click "change" to choose another destination folder.

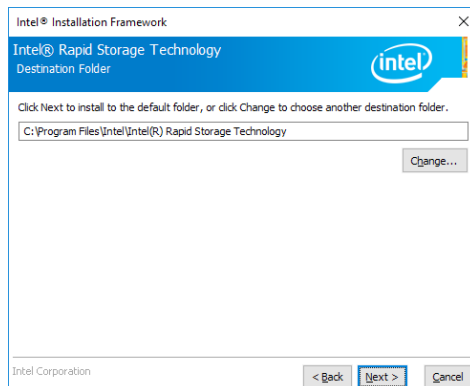

7. Confirm the installation and click "Next".

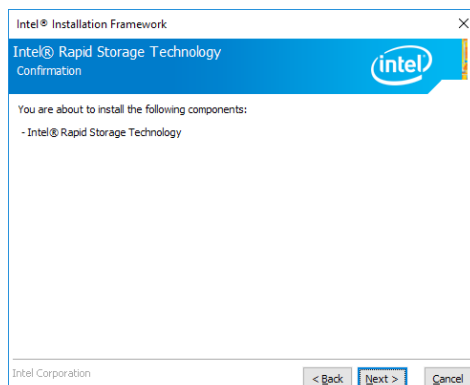

8. Click "Yes, I want to restart this computer now" to complete the installation and click "Finish".

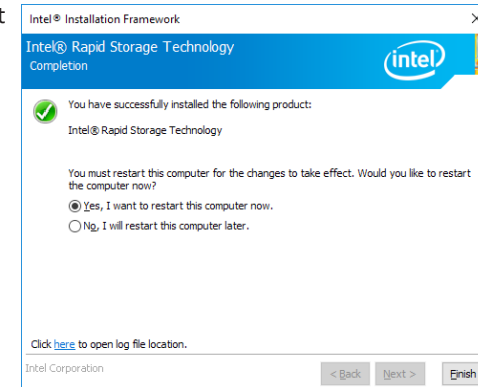

## Enable Intel Smart Response Technology

Intel® Rapid Storage Technology (Intel® RST) comes with a caching feature, Intel® Smart Response Technology, to improve system performance with an SSD used as cache memory.

To use this features, the following requirements have to be met:

- \*Intel RST software 10.5 version release or later
- \*Single hard disk drive or multiple drives in one RAID volume
- \*Solid state drive (SSD) with a minimum capacity of 18.6 GB
- \*Operating system: Windows 7 (32-bit and 64-bit editions) or later versions

Before using this function, setup your system with the following methods:

1. Configure SATA mode in BIOS setup. Please refer to the previous section on Intel Rapid Storage Technology for detailed instructions.
2. Install the operating system and all required device drivers.
3. Install the Intel RST software version 10.5 or later.
4. Enable Intel Smart Response Technology, which is denoted as accelerate in the Intel RST software.



### Note:

The above information is cited from the Intel® Support site, "Intel® Smart Response Technology User Guide" (Article ID: 000005501).

## Chapter 7 - Intel AMT Settings

### Overview

Intel Active Management Technology (Intel® AMT) combines hardware and software solution to provide maximum system defense and protection to networked systems.

The hardware and software information are stored in non-volatile memory. With its built-in manageability and latest security applications, Intel® AMT provides the following functions.

- **Discover**

Allows remote access and management of networked systems even while PCs are powered off; significantly reducing desk-side visits.

- **Repair**

Remotely repair systems after OS failures. Alerting and event logging help detect problems quickly to reduce downtime.

- **Protect**

Intel AMT's System Defense capability remotely updates all systems with the latest security software. It protects the network from threats at the source by proactively blocking incoming threats, reactively containing infected clients before they impact the network, and proactively alerting when critical software agents are removed.

### Enable Intel® AMT in the BIOS

1. Power-on the system then press <Del> to enter the main menu of the BIOS setup utility.
2. In the "Advanced" menu, select "Active Management Technology Support".

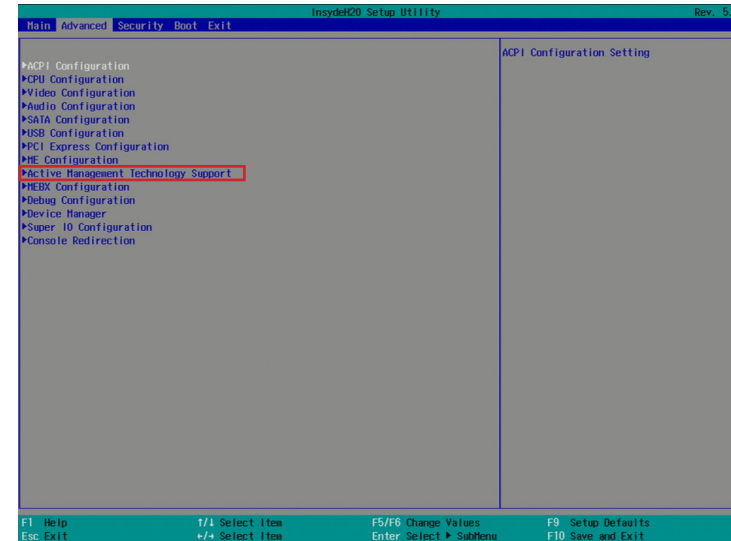

3. In the "Active Management Technology Support" menu, select "Enabled" for "Intel AMT Support".

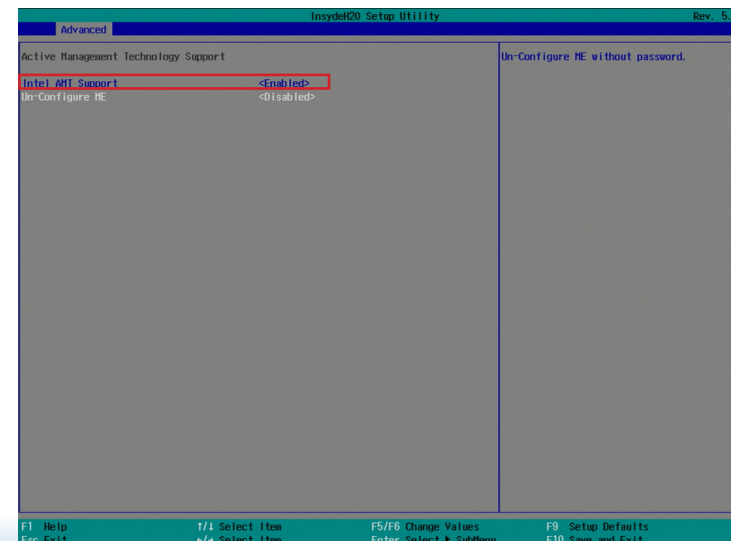

4. In the "Exit" menu, select "Exit Saving Changes", and then select "OK".

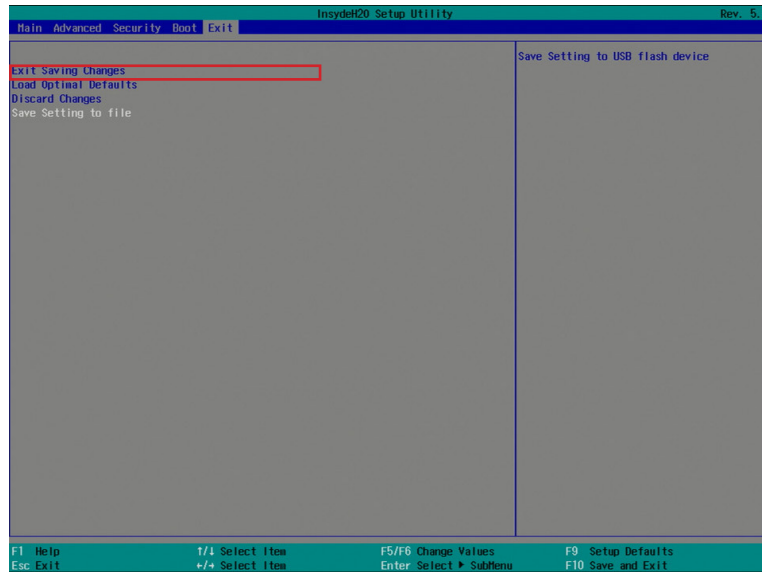

## Set up Intel® AMT using the Intel® Management Engine BIOS Extension (MEBX)

1. After the system reboots, press <Del> to enter the BIOS menu again.
2. In the "Advanced" menu, select "MEBX Configuration" to enter the Manageability Engine BIOS Extension (MEBx) Setup.

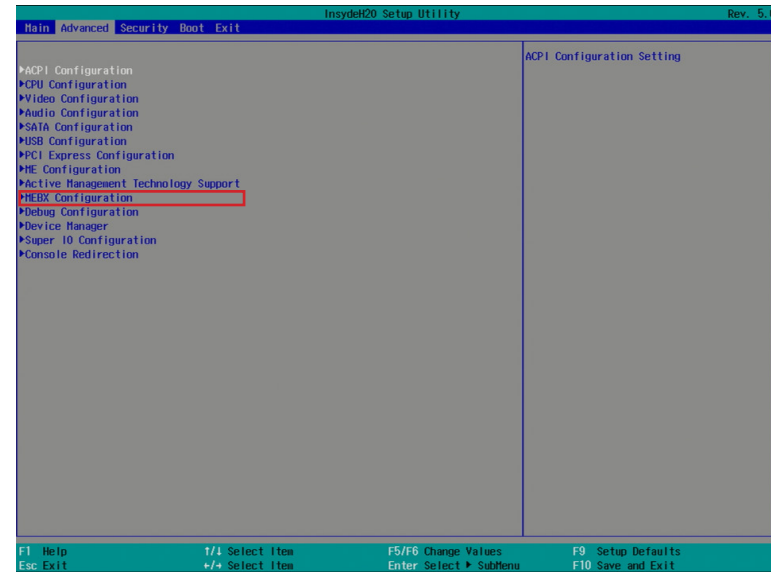

3. Select "MEBx Login". You will be prompted for a password. The default password is "admin". Enter the default password in the space provided under Intel(R) ME Password and then press "Enter".

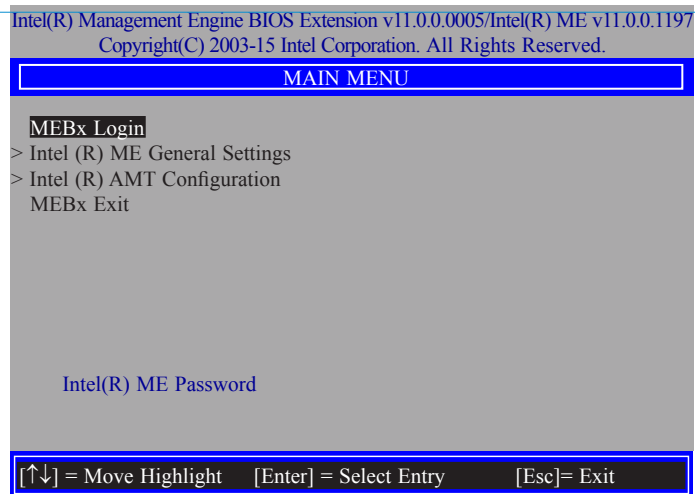

4. Enter a new password in the space provided under Intel(R) ME New Password then press Enter. The password must include:

- 8-32 characters
- Strong 7-bit ASCII characters excluding : , and " characters
- At least one digit character (0, 1, ...9)
- At least one 7-bit ASCII non alpha-numeric character, above 0x20, (e.g. !, \$, ;)
- Both lower case and upper case characters

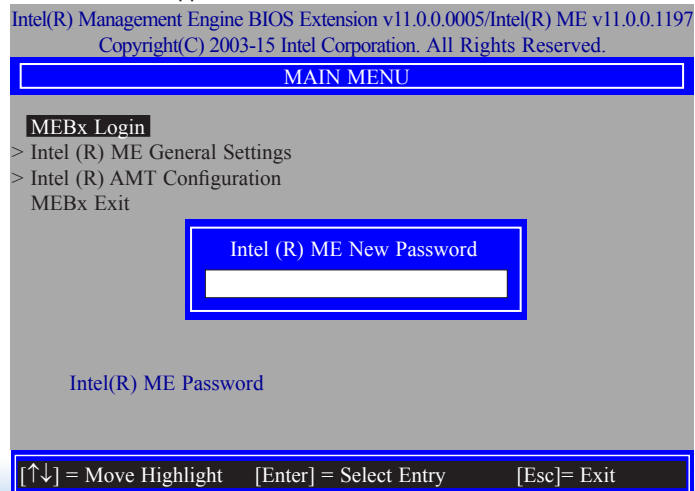

5. You will be asked to verify the password. Enter the same new password in the space provided under "Verify Password", then press "Enter".

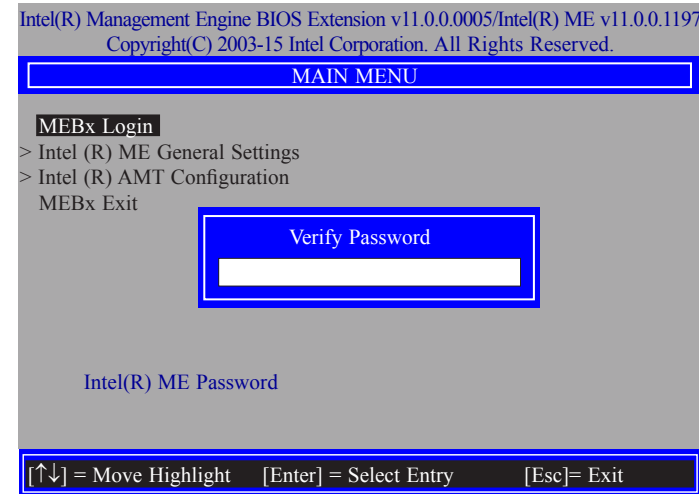

6. Select "Intel(R) ME General Settings", then press "Enter".

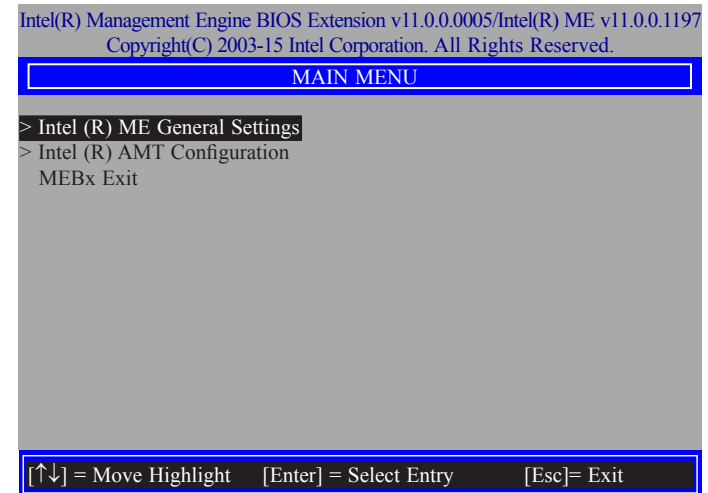

7. Select "Change Intel(R) ME Password" and then press "Enter".

You will be prompted for a password. The default password is "admin". Enter the default password in the space provided under "Intel(R) ME New Password" and then press "Enter".

- 8-32 characters
- Strong 7-bit ASCII characters excluding : , and " characters
- At least one digit character (0, 1, ...9)
- At least one 7-bit ASCII non alpha-numeric character, above 0x20, (e.g. !, \$, ;)
- Both lower case and upper case characters

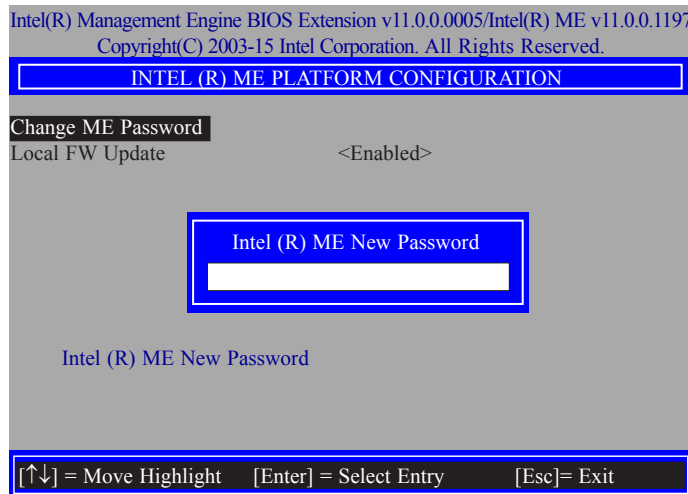

8. Select "Local FW Update", then press "Enter". Select "Enabled" or "Disabled" or "Password Protected" and then press "Enter".

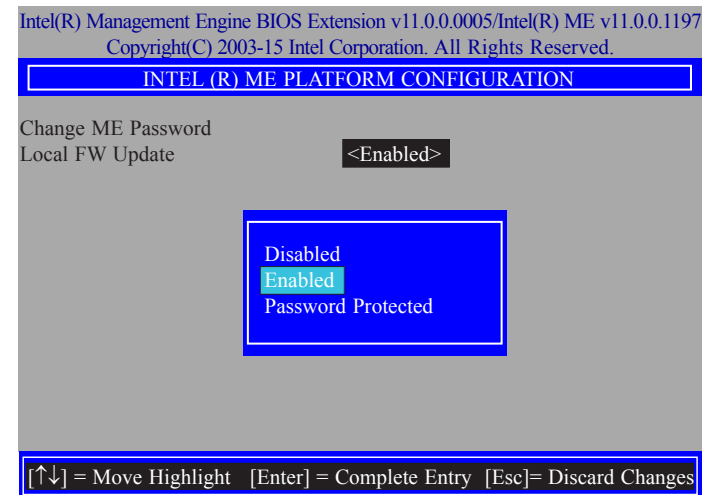

9. Select Previous Menu until you return to the "Main Menu". Select "Intel(R) AMT Configuration", then press "Enter".

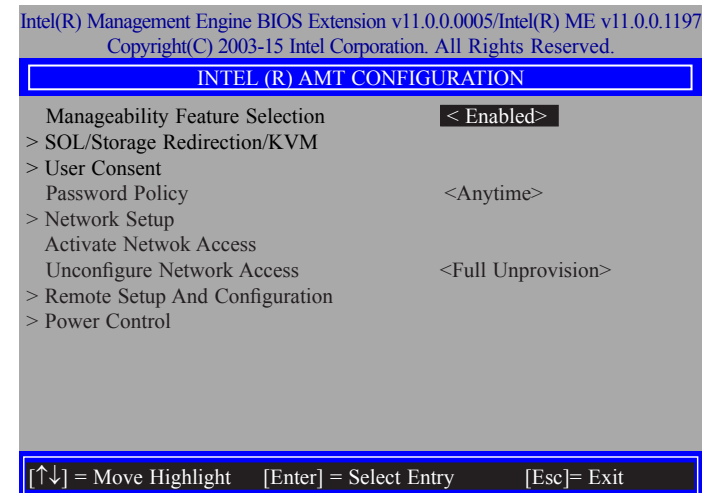



10. In the "Intel(R) AMT Configuration" menu, select "Manageability Feature Selection", then press "Enter". Select "Enabled" or "Disabled", then press "Enter".

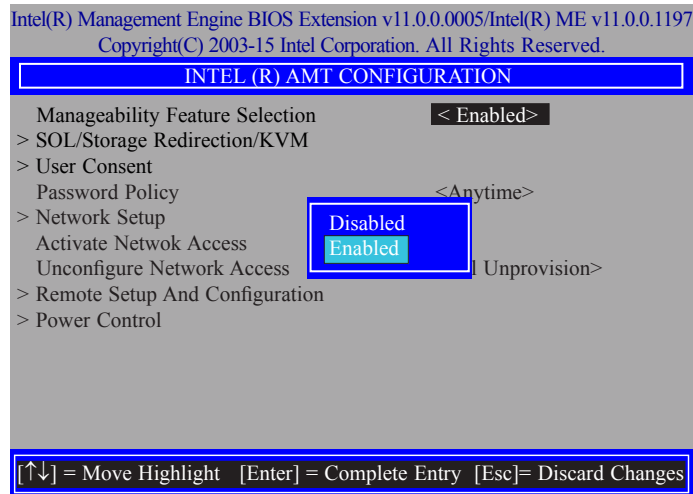

12. In the "SOL/Storage Redirection/KVM" menu, select "Username and Password", then press "Enter". Select "Enabled" or "Disabled", then press "Enter".

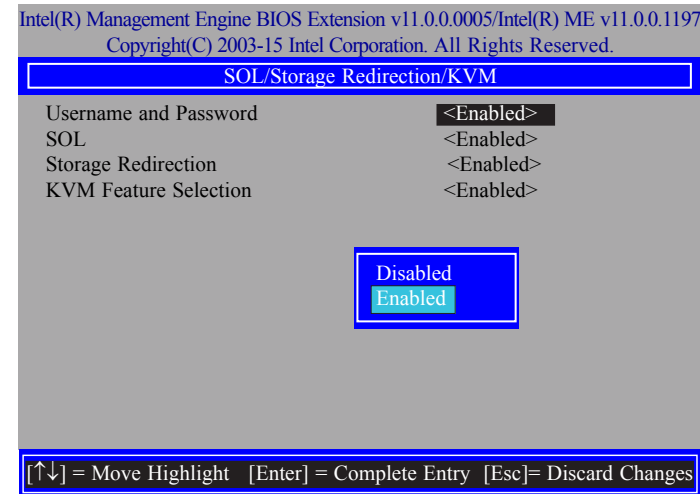

11. In the "Intel(R) AMT Configuration" menu, select "SOL/Storage Redirection/KVM", then press "Enter".

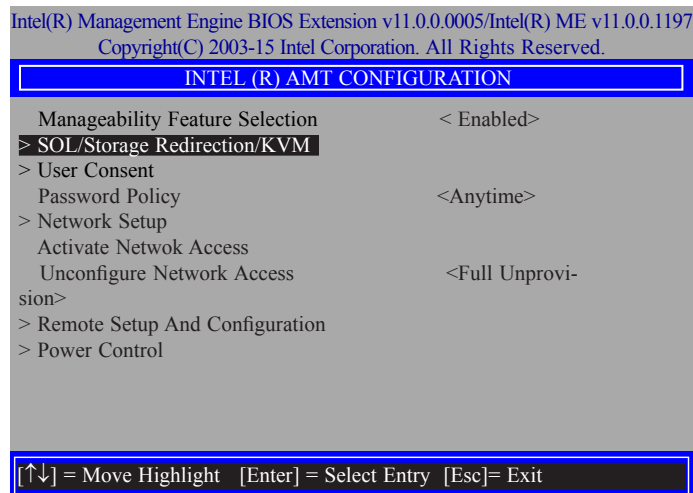

13. In the "SOL/Storage Redirection/KVM" menu, select "SOL", then press "Enter". Select "Enabled" or "Disabled", then press "Enter".

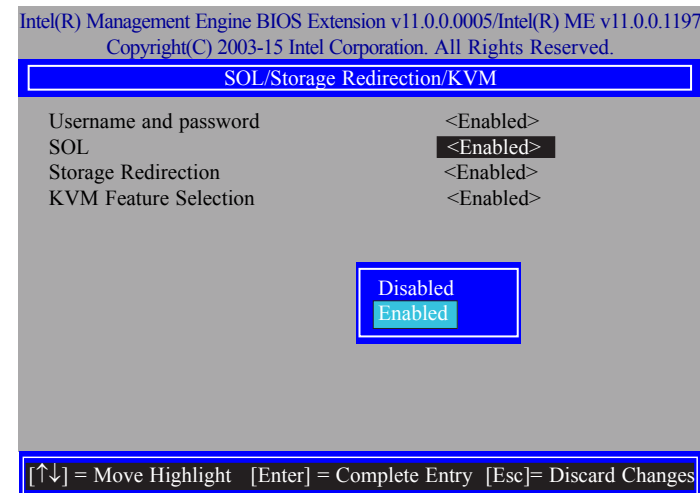

14. In the "SOL/Storage Redirection/KVM" menu, select "Storage Redirection", then press "Enter". Select "Enabled" or "Disabled", then press "Enter".

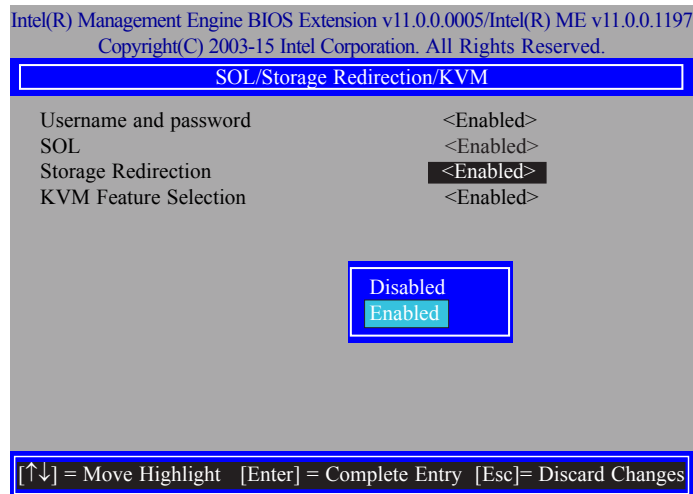

16. Select Previous Menu until you return to the "Intel(R) AMT Configuration" menu. Select "User Consent", then press "Enter".

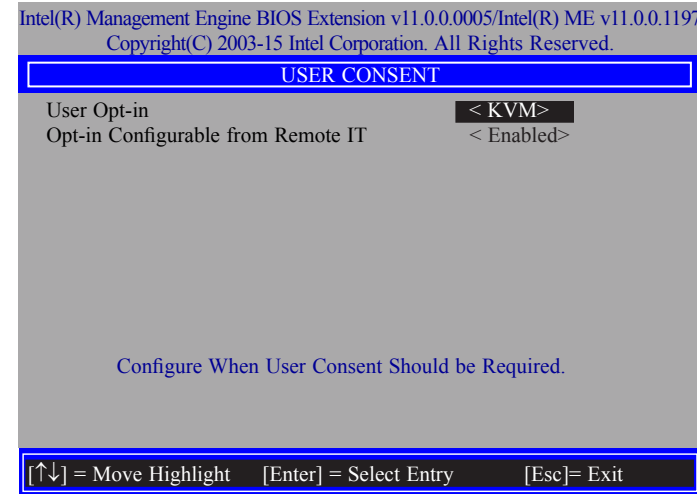

15. In the "SOL/IDER/KVM" menu, select "KVM Feature Selection" and then press "Enter". Select "Enabled" or "Disabled", then press "Enter".

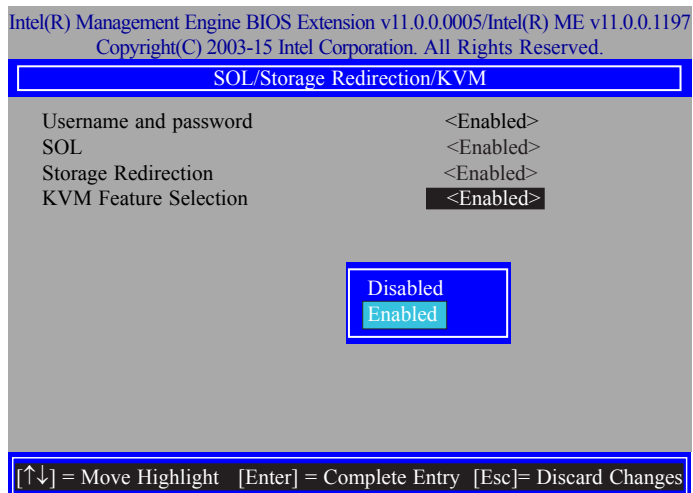

17. In the "User Consent" menu, select "User Opt-in", then press "Enter". Select "None" or "KVM" or "ALL", then press "Enter".

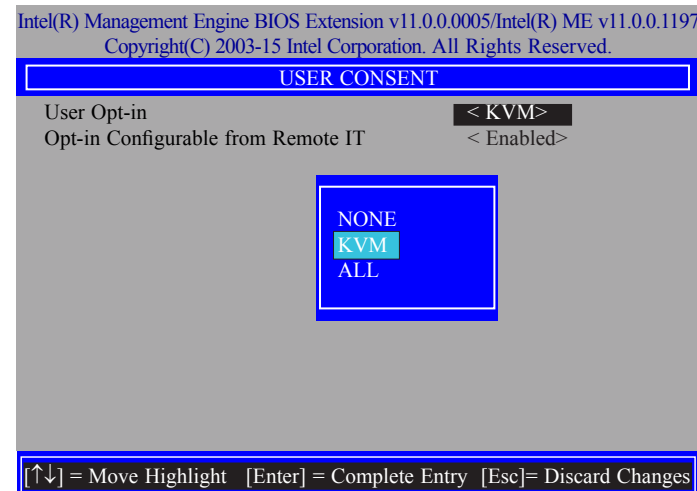

18. In the "User Consent" menu, select "Opt-in Configurable from Remote IT", then press "Enter". Select "Enabled" or "Disable Remote Control of KVM Opt-in Policy", then press "Enter".

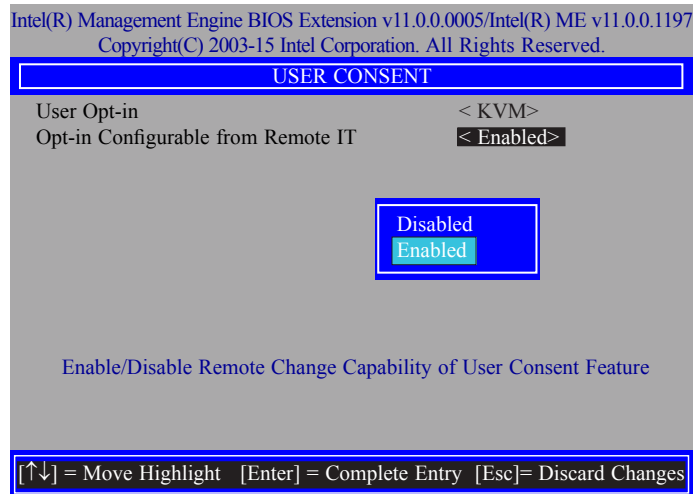

19. Select Previous Menu until you return to the "Intel(R) AMT Configuration" menu. Select "Password Policy", then press "Enter".

You may choose to use a password only during setup and configuration or to use a password anytime the system is being accessed.

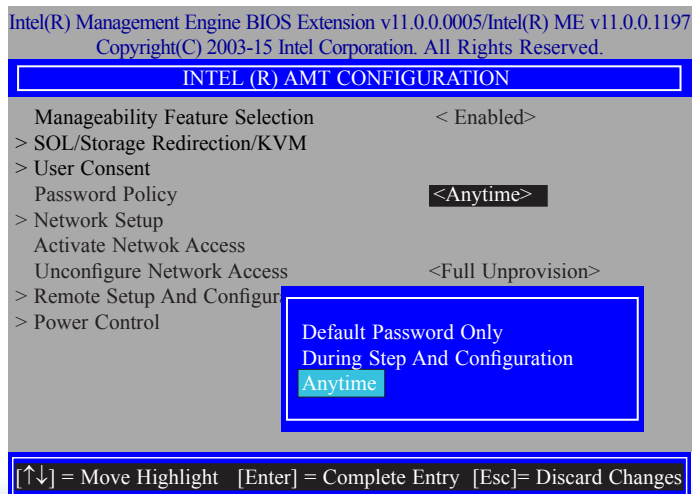

20. In the "Intel(R) AMT Configuration" menu, select "Network Setup", then press "Enter".

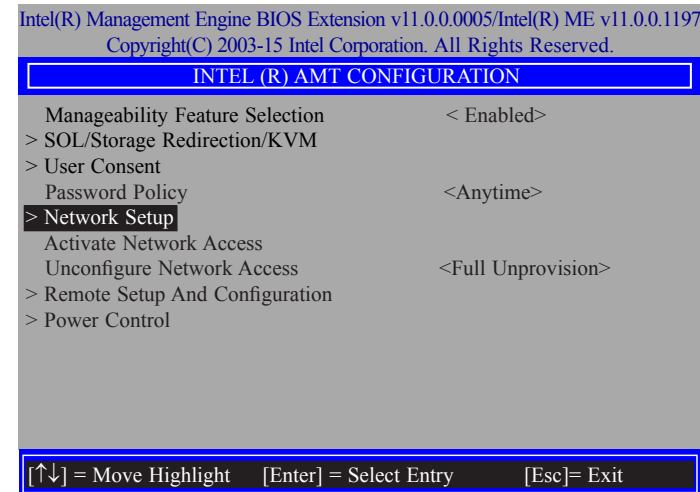

21. In the "Intel(R) ME Network Setup" menu, select "Intel(R) ME Network Name Settings", then press "Enter".

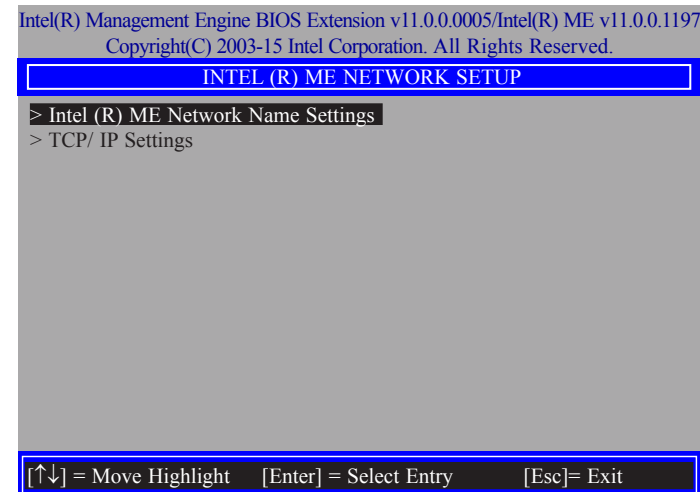

22. In the "Intel(R) ME Network Name Settings" menu, select "Host Name", then press "Enter". Enter the computer's host name and then press "Enter".

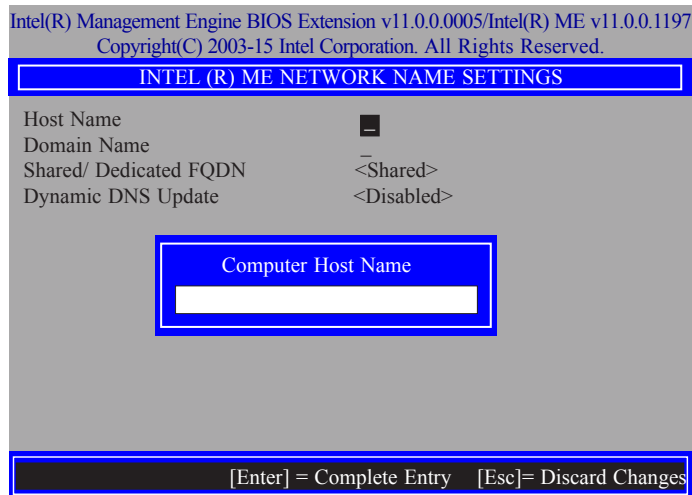

24. Select "Shared/Dedicated FQDN", then press "Enter". Select "Shared" or "Dedicated", then press "Enter".

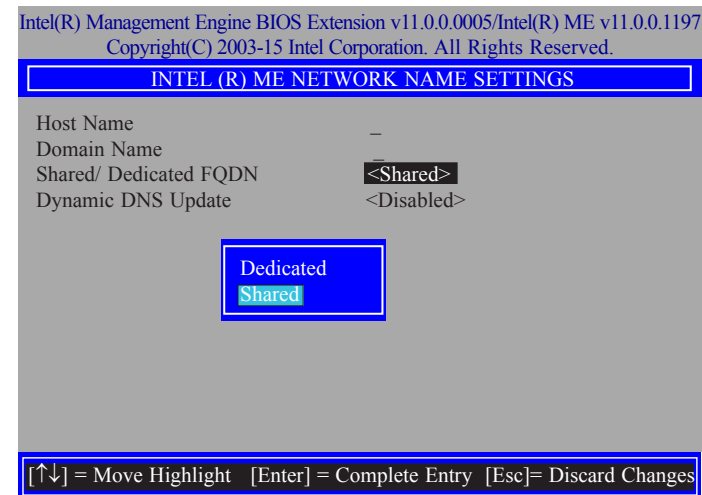

23. Select "Domain Name" and then press "Enter". Enter the computer's domain name, then press "Enter".

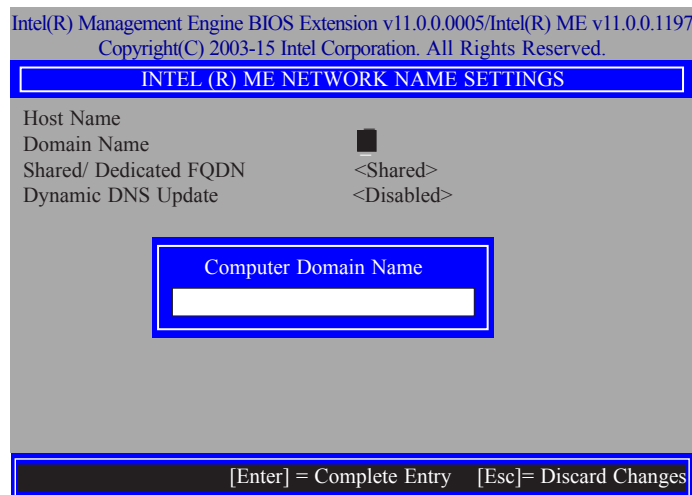

25. Select "Dynamic DNS Update", then press "Enter". Select "Enabled" or "Disabled", then press "Enter".

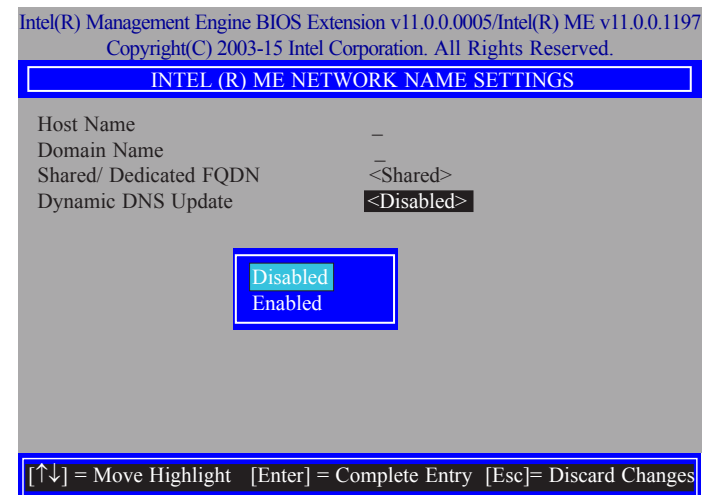

26. Select Previous Menu until you return to the "Intel(R) ME Network Setup" menu. Select "TCP/IP Settings", then press "Enter".

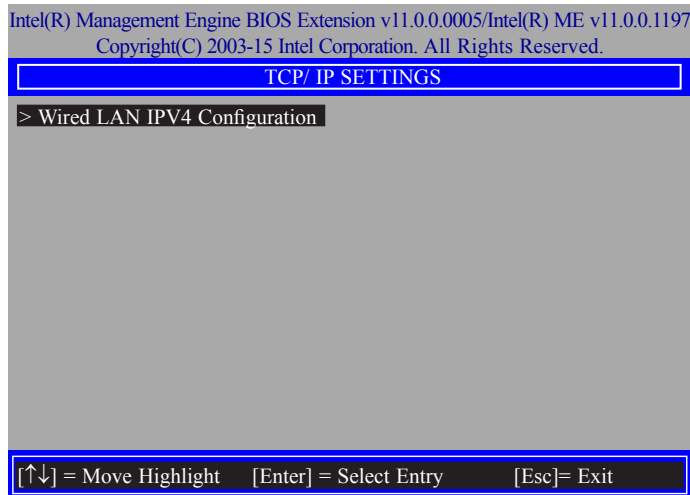

If DHCP mode is disabled, the following items will appear.

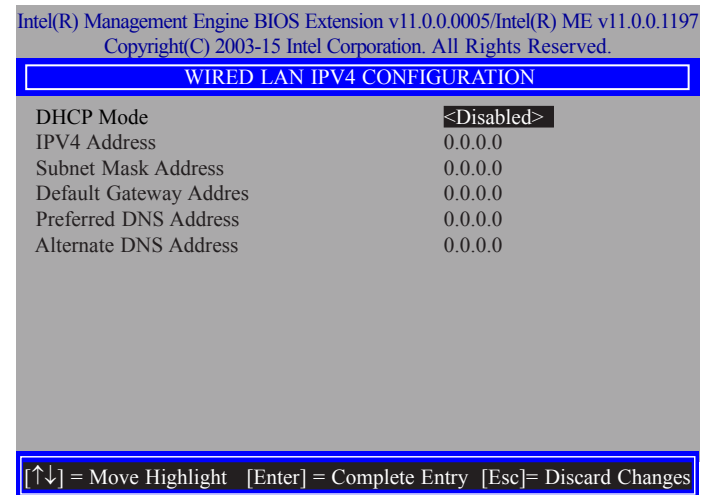

27. In the "TCP/IP Settings" menu, select "Wired LAN IPV4 Configuration", then press "Enter".

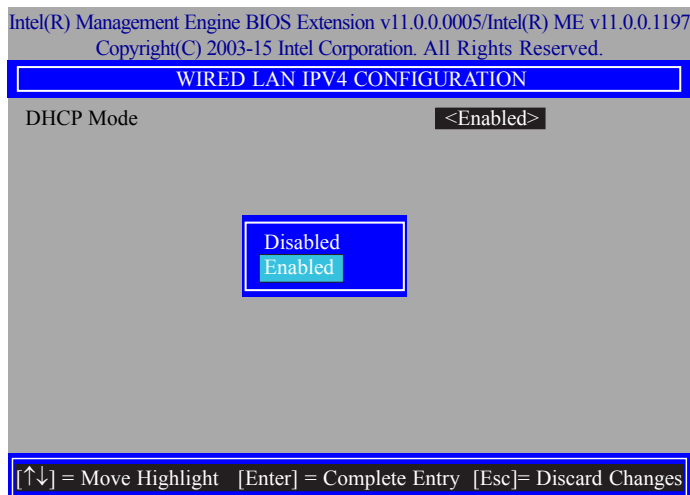

28. In the "Intel(R) AMT Configuration" menu, select "Activate Network Access"; then select "Yes/No" and press "Enter".

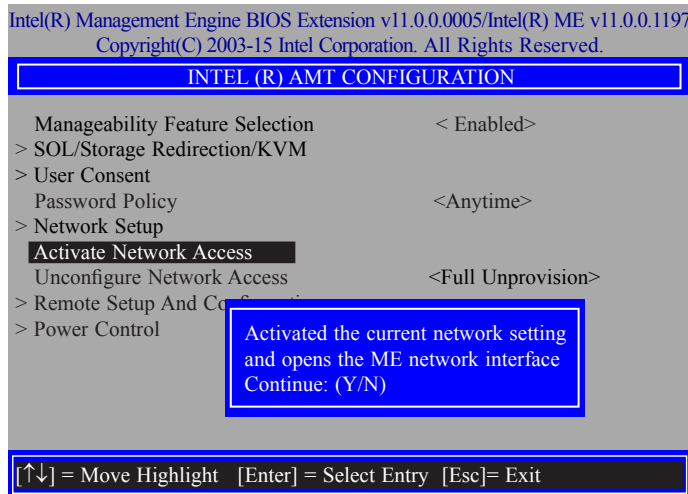

29. In the "Intel(R) AMT Configuration" menu, select "Unconfigure Network Access", then press "Enter".

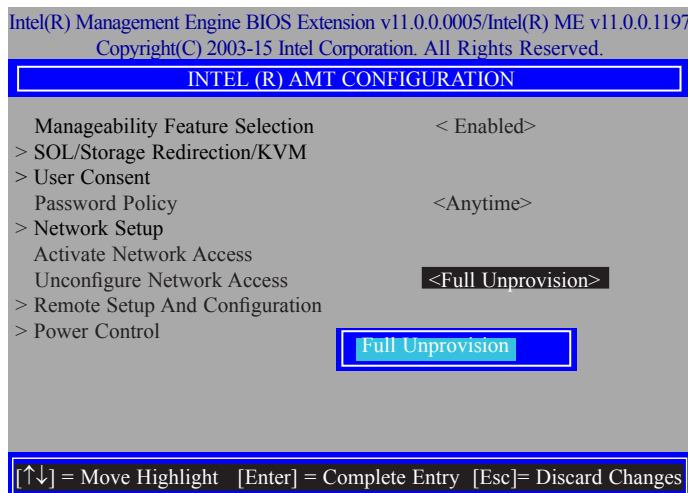

30. In the "Intel(R) AMT Configuration" menu, select "Remote Setup And Configuration", then press "Enter".

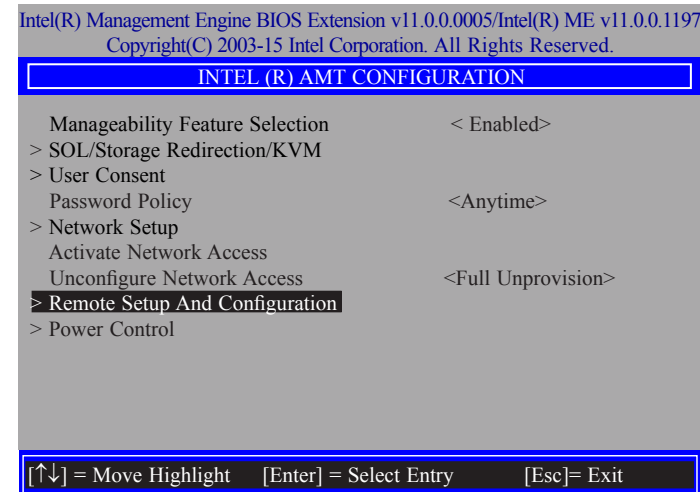

31. In the "Intel(R) Remote Setup And Configuration" menu, select "Current Provisioning Mode", then press "Enter".

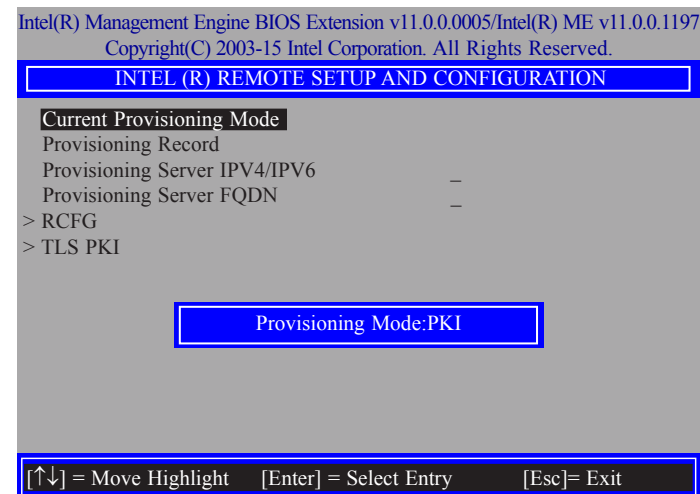

32. In the "Intel(R) Remote Setup And Configuration" menu, select "Provisioning Record", then press "Enter".

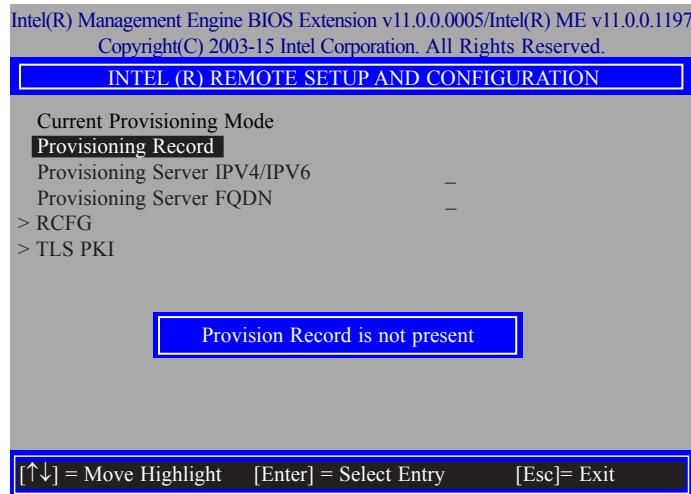

33. In the "Intel(R) Remote Setup And Configuration" menu, select "Provisioning server IPV4/IPV6", enter the Provisioning server address, then press "Enter".

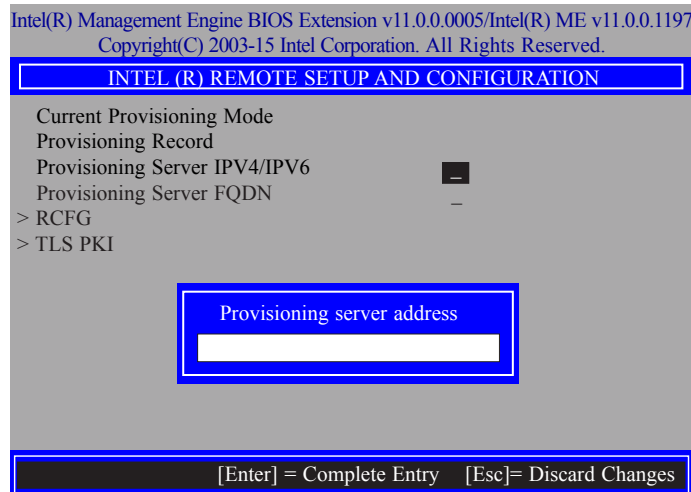

34. In the "Intel(R) Remote Setup And Configuration" menu, select "Provisioning server FQDN", enter the FQDN of Provisioning, then press "Enter".

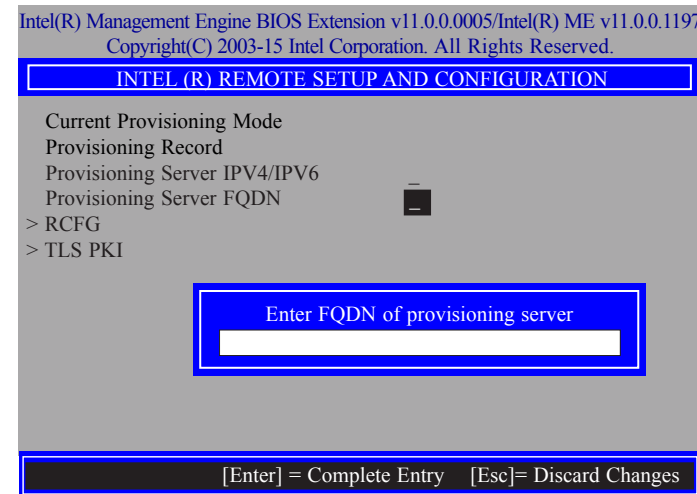

35. In the "Intel(R) Remote Setup And Configuration" menu, select "RCFG" and press "Enter", then select "Start Configuration Y/N" and press "enter".



36. In the "Intel(R) Remote Setup And Configuration" menu, select "TLS PKI", then press "Enter".

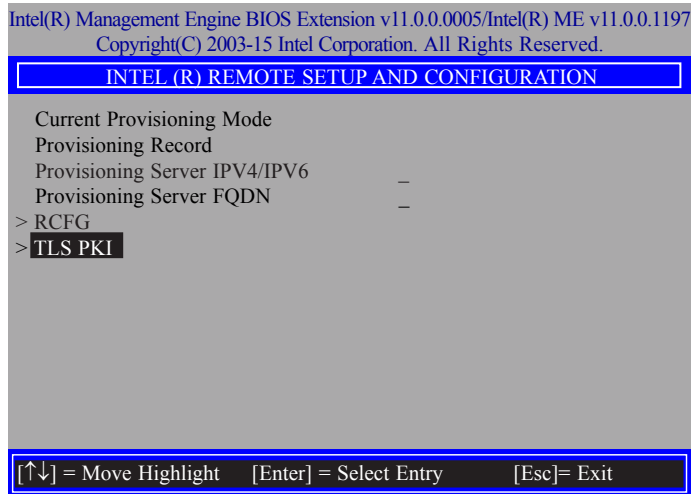

37. Select "PKI DNS Suffix", enter the "PKI DNS Suffix", then press "Enter".

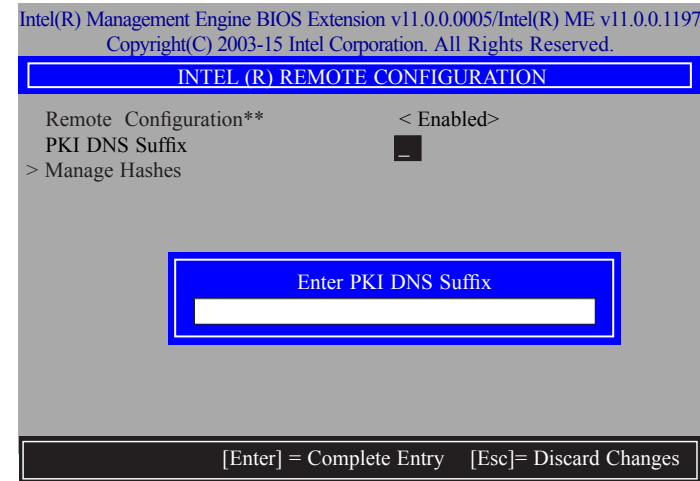

37. In the "Intel(R) Remote Configuration" menu, select "Remote Configuration\*\*" and press "Enter", then select "Enabled" or "Disabled" and press "Enter".

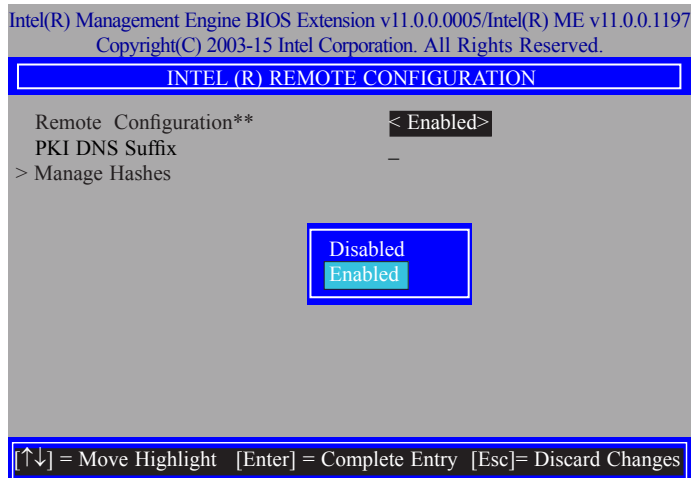

38. Select "Manage Hashes" and press "Enter", then select one of the hash names.

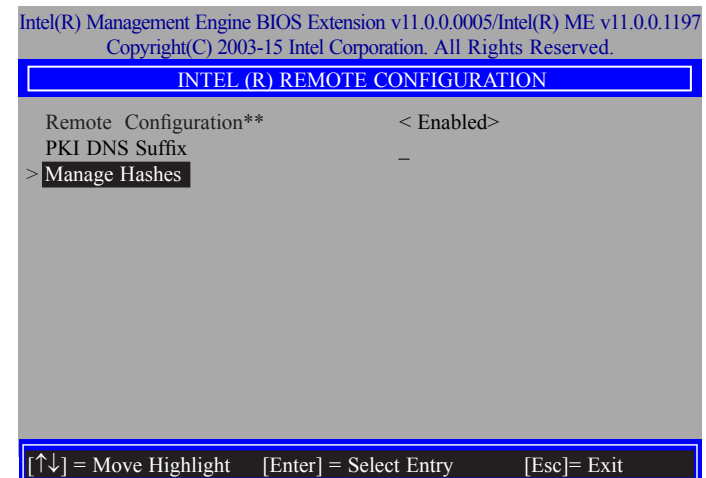



39. In the Intel(R) Remote Configuration menu, select "Manage Hashes", then press "Enter".

Intel(R) Management Engine BIOS Extension v11.0.0.0005/Intel(R) ME v11.0.0.1197  
Copyright(C) 2003-15 Intel Corporation. All Rights Reserved.

**INTEL (R) REMOTE CONFIGURATION**

Hash Name	Active	Default	Algorithm
VeriSign Class 3	Active: [*]	Default: [*]	SHA256
VeriSign Class 3	Active: [*]	Default: [*]	SHA256
Go Daddy Class 2	Active: [*]	Default: [*]	SHA256
Comodo AAA CA	Active: [*]	Default: [*]	SHA256
Starfield Class 2	Active: [*]	Default: [*]	SHA256
VeriSign Class 3	Active: [*]	Default: [*]	SHA256
VeriSign Class 3	Active: [*]	Default: [*]	SHA256
VeriSign Class 3	Active: [*]	Default: [*]	SHA256
GTE CyberTrust G1	Active: [*]	Default: [*]	SHA256
Baltimore Cyber Tr	Active: [*]	Default: [*]	SHA256
Cyber Trust Global	Active: [*]	Default: [*]	SHA256
Verizon Global Ro	Active: [*]	Default: [*]	SHA256
Entrust. net CA (2	Active: [*]	Default: [*]	SHA256
Entrust Root CA	Active: [*]	Default: [*]	SHA256
VeriSign Universa	Active: [*]	Default: [*]	SHA256
Go Daddy Root CA	Active: [*]	Default: [*]	SHA256
Entrust Root CA -	Active: [*]	Default: [*]	SHA256
Startfield Root CA	Active: [*]	Default: [*]	SHA256

[Ins]= Add New Hash    [Delete]= Delete Hash    [\*]= Activate Hash  
[↑↓]= Move Highlight    [Enter]= View Hash    [Esc]= Exit

40. In the "Intel(R) AMT Configuration" menu, select "Power Control", then press "Enter".

Intel(R) Management Engine BIOS Extension v11.0.0.0005/Intel(R) ME v11.0.0.1197  
Copyright(C) 2003-15 Intel Corporation. All Rights Reserved.

**INTEL (R) AMT CONFIGURATION**

- Manageability Feature Selection < Enabled>
- > SOL/ IDER/ KVM
- > User Consent
- Password Policy <Anytime>
- > Network Setup
- Activate Network Access
- Unconfigure Network Access <Full Unprovision>
- > Remote Setup And Configuration
- > **Power Control**

[↑↓] = Move Highlight    [Enter] = Select Entry    [Esc]= Exit

41. In the "Intel(R) AMT Power Control" menu, select "Intel(R) AMT ON in Host Sleep States", then press "Enter". Select an option then press "Enter".

Intel(R) Management Engine BIOS Extension v11.0.0.0005/Intel(R) ME v11.0.0.1197  
Copyright(C) 2003-15 Intel Corporation. All Rights Reserved.

**INTEL (R) AMT POWER CONTROL**

These configurations are effective only after AMT provisioning has started

Intel (R) AMT ON in Host Sleep States    <Mobile: ON in S0, ME Wake in S3, S4-5 (AC only)>

Idle Timeout    65535

Mobile: ON in S0  
Mobile: ON in S0, ME Wake in S3, S4-5 (AC only)

[↑↓] = Move Highlight    [Enter] = Complete Entry    [Esc]= Discard Changes

42. In the "Intel(R) AMT Power Control" menu, select "Idle Timeout", then press "Enter". Enter the timeout value (1-65535).

Intel(R) Management Engine BIOS Extension v11.0.0.0005/Intel(R) ME v11.0.0.1197  
Copyright(C) 2003-15 Intel Corporation. All Rights Reserved.

**INTEL (R) AMT POWER CONTROL**

This configurations are effective only after AMT provisioning has started

Intel (R) ME ON in Host Sleep States    <Mobile: ON in S0, ME Wake in S3, S4-5 (AC only)>

Idle Timeout    **65535**

Timeout Value (1-65535)  
65535

<ENTER> = Complete Entry    [ESC]= Discard Changes

43. Select Previous Menu until you return to the "Main Menu". Select "Exit", then press "Enter". Type "Y", then press "Enter".

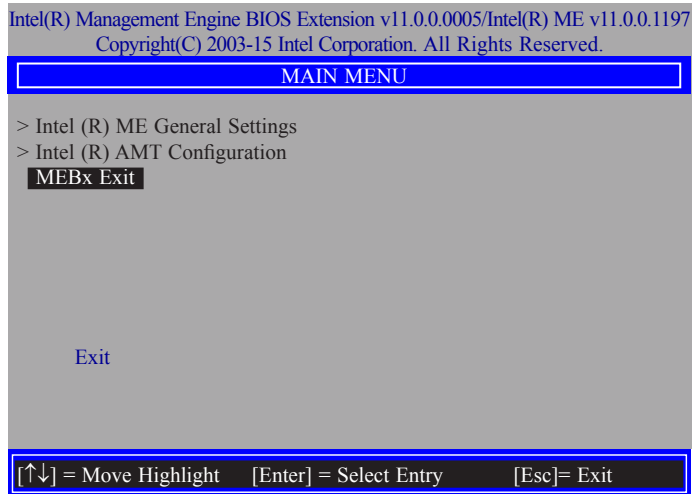

## Appendix A - Troubleshooting

### Troubleshooting Checklist

This chapter of the manual is designed to help you with problems that you may encounter with your personal computer. To efficiently troubleshoot your system, treat each problem individually. This is to ensure an accurate diagnosis of the problem in case a problem has multiple causes.

Some of the most common things to check when you encounter problems while using your system are listed below.

1. The power switch of each peripheral device is turned on.
2. All cables and power cords are tightly connected.
3. The electrical outlet to which your peripheral devices are connected is working. Test the outlet by plugging in a lamp or other electrical device.
4. The monitor is turned on.
5. The display's brightness and contrast controls are adjusted properly.
6. All add-in boards in the expansion slots are seated securely.
7. Any add-in board you have installed is designed for your system and is set up correctly.

### Monitor/Display

#### If the display screen remains dark after the system is turned on:

1. Make sure that the monitor's power switch is on.
2. Check that one end of the monitor's power cord is properly attached to the monitor and the other end is plugged into a working AC outlet. If necessary, try another outlet.
3. Check that the video input cable is properly attached to the monitor and the system's display adapter.
4. Adjust the brightness of the display by turning the monitor's brightness control knob.

#### The picture seems to be constantly moving.

1. The monitor has lost its vertical sync. Adjust the monitor's vertical sync.
2. Move away any objects, such as another monitor or fan, that may be creating a magnetic field around the display.
3. Make sure your video card's output frequencies are supported by this monitor.

#### The screen seems to be constantly wavering.

1. If the monitor is close to another monitor, the adjacent monitor may need to be turned off. Fluorescent lights adjacent to the monitor may also cause screen wavering.

### Power Supply

#### When the computer is turned on, nothing happens.

1. Check that one end of the AC power cord is plugged into a live outlet and the other end properly plugged into the back of the system.
2. Make sure that the voltage selection switch on the back panel is set for the correct type of voltage you are using.
3. The power cord may have a "short" or "open". Inspect the cord and install a new one if necessary.

## Hard Drive

### Hard disk failure.

1. Make sure the correct drive type for the hard disk drive has been entered in the BIOS.
2. If the system is configured with two hard drives, make sure the bootable (first) hard drive is configured as Master and the second hard drive is configured as Slave. The master hard drive must have an active/bootable partition.

### Excessively long formatting period.

If your hard drive takes an excessively long period of time to format, it is likely a cable connection problem. However, if your hard drive has a large capacity, it will take a longer time to format.

## Serial Port

### The serial device (modem, printer) doesn't output anything or is outputting garbled characters.

1. Make sure that the serial device's power is turned on and that the device is on-line.
2. Verify that the device is plugged into the correct serial port on the rear of the computer.
3. Verify that the attached serial device works by attaching it to a serial port that is working and configured correctly. If the serial device does not work, either the cable or the serial device has a problem. If the serial device works, the problem may be due to the onboard I/O or the address setting.
4. Make sure the COM settings and I/O address are configured correctly.

## Keyboard

### Nothing happens when a key on the keyboard was pressed.

1. Make sure the keyboard is properly connected.
2. Make sure there are no objects resting on the keyboard and that no keys are pressed during the booting process.

## System Board

1. Make sure the add-in card is seated securely in the expansion slot. If the add-in card is loose, power off the system, re-install the card and power up the system.
2. Check the jumper settings to ensure that the jumpers are properly set.
3. Verify that all memory modules are seated securely into the memory sockets.
4. Make sure the memory modules are in the correct locations.
5. If the board fails to function, place the board on a flat surface and seat all socketed components. Gently press each component into the socket.
6. If you made changes to the BIOS settings, re-enter setup and load the BIOS defaults.

## Appendix B - Insyde BIOS Standard Status POST Code

### SEC Phase 8-Bit POST Code Values

Functionality Name	POST Code Value	Description
SEC_SYSTEM_POWER_ON	01	CPU power on and switch to Protected mode
SEC_AFTER_MICROCODE_PATCH	03	Setup Cache as RAM
SEC_ACCESS_CSR	04	PCIE MMIO Base Address initial
SEC_GENERIC_MSRRINIT	05	CPU Generic MSR initialization
SEC_CPU_SPEEDCFG	06	Setup CPU speed
SEC_SETUP_CAR_OK	07	Cache as RAM test
SEC_FORCE_MAX_RATIO	08	Tune CPU frequency ratio to maximum level
SEC_GO_TO_SECSTARTUP	09	Setup BIOS ROM cache
SEC_GO_TO_PEICORE	0A	Enter Boot Firmware Volume

### PEI Phase 8-Bit POST Code Values

Functionality Name	POST Code Value	Description
PEI_SIO_INIT	70	Super I/O initialization
PEI_CPU_REG_INIT	71	CPU Early Initialization
PEI_CPU_AP_INIT	72	Multi-processor Early initialization
PEI_CPU_HT_RESET	73	HyperTransport initialization
PEI_PCIE_MMIO_INIT	74	PCIE MMIO BAR Initialization
PEI_NB_REG_INIT	75	North Bridge Early Initialization
PEI_SB_REG_INIT	76	South Bridge Early Initialization
PEI_PCIE_TRAINING	77	PCIE Training
PEI_TPM_INIT	78	TPM Initialization
PEI_MEMORY_INSTALL	80	Simple Memory test
PEI_TXTPEI	81	TXT function early initialization
PEI_MEMORY_CALLBACK	83	Set cache for physical memory

### DXE Phase 8-Bit POST Code Values

Functionality Name	Post Code Values	Description
DXE_SB_SPI_INIT	41	South bridge SPI initialization
DXE_VARIABLE_RECLAIM	61	Variable store garbage collection and reclaim operation
DXE_FLASH_PART_NONSUPPORT	62	Flash part not supported.

### BDS Phase 8-Bit POST Code Values

Functionality Name	POST Code Value	Description
BDS_ENTER_BDS	10	Enter BDS entry
BDS_INSTALL_HOTKEY	11	Install Hotkey service
BDS_ASF_INIT	12	ASF Initialization
BDS_PCI_ENUMERATION_START	13	PCI enumeration
BDS_BEFORE_PCIIO_INSTALL	14	PCI resource assign complete
BDS_PCI_ENUMERATION_END	15	PCI enumeration complete
BDS_CONNECT_CONSOLE_IN	16	Keyboard Controller, Keyboard and Mouse initializatio
BDS_CONNECT_CONSOLE_OUT	17	Video device initialization
BDS_CONNECT_STD_ERR	18	Error report device initialization
BDS_CONNECT_USB_HC	19	USB host controller initialization
BDS_CONNECT_USB_BUS	1A	USB BUS driver initialization
BDS_CONNECT_USB_DEVICE	1B	USB device driver initialization
BDS_NO_CONSOLE_ACTION	1C	Console device initialization fail
BDS_ENUMERATE_ALL_BOOT_OPTIO	27	Get boot device information
BDS_ENTER_SETUP	29	Enter Setup Menu
BDS_ENTER_BOOT_MANAGER	2A	Enter Boot manager
BDS_READY_TO_BOOT_EVENT	2E	Last Chipset initialization before boot to OS
BDS_GO_LEGACY_BOOT	2F	Start to boot Legacy OS
BDS_GO_UEFI_BOOT	30	Start to boot UEFI OS
BDS_LEGACY16_PREPARE_TO_BOOT	31	Prepare to Boot to Legacy OS
BDS_EXIT_BOOT_SERVICES	32	Send END of POST Message to ME via HECI

### PostBDS Phase 8-Bit POST Code Values

Functionality Name	POST Code Value	Description
POST_BDS_NO_BOOT_DEVICE	F9	No Boot Device
POST_BDS_JUMP_BOOT_SECTOR	FE	Try to Boot with INT 19

### ACPI 8-Bit POST Code Values

Functionality Name	POST Code Value	Description
ASL_ENTER_S1	51	Prepare to enter S1
ASL_ENTER_S3	53	Prepare to enter S3
ASL_ENTER_S4	54	Prepare to enter S4
ASL_ENTER_S5	55	Prepare to enter S5
ASL_WAKEUP_S1	E1	System wakeup from S1
ASL_WAKEUP_S3	E3	System wakeup from S3
ASL_WAKEUP_S4	E4	System wakeup from S4
ASL_WAKEUP_S5	E5	System wakeup from S5

### SMM 8-Bit POST Code Values

Functionality Name	POST Code Value	Description
SMM_ACPI_ENABLE_END	A7	ACPI enable function complete
SMM_S1_SLEEP_CALLBACK	A1	Enter S1
SMM_S3_SLEEP_CALLBACK	A3	Enter S3
SMM_S4_SLEEP_CALLBACK	A4	Enter S4
SMM_S5_SLEEP_CALLBACK	A5	Enter S5