



ADP253

Embedded 4" SBC

User's Manual

Copyright

This publication contains information that is protected by copyright. No part of it may be reproduced in any form or by any means or used to make any transformation/adaptation without the prior written permission from the copyright holders.

This publication is provided for informational purposes only. The manufacturer makes no representations or warranties with respect to the contents or use of this manual and specifically disclaims any express or implied warranties of merchantability or fitness for any particular purpose. The user will assume the entire risk of the use or the results of the use of this document. Further, the manufacturer reserves the right to revise this publication and make changes to its contents at any time, without obligation to notify any person or entity of such revisions or changes.

Changes after the publication's first release will be based on the product's revision. The website will always provide the most updated information.

© 2023. All Rights Reserved.

Trademarks

Product names or trademarks appearing in this manual are for identification purpose only and are the properties of the respective owners.

FCC and DOC Statement on Class A

This equipment has been tested and found to comply with the limits for a Class A digital device, pursuant to Part 15 of the FCC rules. These limits are designed to provide reasonable protection against harmful interference when the equipment is operated in a residential installation. This equipment generates, uses and can radiate radio frequency energy and, if not installed and used in accordance with the instruction manual, may cause harmful interference to radio communications. However, there is no guarantee that interference will not occur in a particular installation. If this equipment does cause harmful interference to radio or television reception, which can be determined by turning the equipment off and on, the user is encouraged to try to correct the interference by one or more of the following measures:

- Reorient or relocate the receiving antenna.
- Increase the separation between the equipment and the receiver.
- Connect the equipment into an outlet on a circuit different from that to which the receiver is connected.
- Consult the dealer or an experienced radio TV technician for help.

Notice:

1. The changes or modifications not expressly approved by the party responsible for compliance could void the user's authority to operate the equipment.
2. Shielded interface cables must be used in order to comply with the emission limits.

Table of Contents

Chapter 1 - Introduction.....	6
Specifications	6
Dimensions	8
Block Diagram	8
Chapter 2 - Hardware Installations.....	9
Overview.....	9
Top View.....	9
Jumper Settings.....	10
COM Serial / DIO Switch (JP8 & JP9)	10
Pin Assignment	11
RTC Battery (J1)	11
SATA Power (CN8)	11
SATA (J12)	12
Front Panel (JP10)	12
COM1 (CN49) & COM2 (CN50)	13
COM3/DIO (Optional) (CN51)	13
COM4 (CN52) & COM5 (J22) & COM6 (J23)	14
Expansion Slots.....	15
Installing the M.2 Module	15
Installing the SO-DIMM Module	16
Installing the Heatsink or Fan	17
Chapter 3 - BIOS Settings.....	19
Overview	19
Main.....	20
Advanced	20
CPU Configuration.....	21
Power & Performance	21
PCH-FW Configuration	22
Trusted Computing.....	22
IT8786 Super IO Configuration.....	23
IT8786 Super IO Configuration ▶ Serial Port 1, 2 Configuration	23
IT8786 Super IO Configuration ▶ Serial Port 3, 4 Configuration	24
IT8786 Super IO Configuration ▶ Serial Port 5, 6 Configuration	24
IT8786 Hardware Monitor.....	25
IT8786 Hardware Monitor ▶ Smart FAN Function	25
Serial Port Console Redirection	26
Serial Port Console Redirection ▶ Console Redirection Settings	26
ACPI Settings.....	27
USB Configuration	28
Network Stack Configuration.....	28
DFI WDT Configuration.....	29
USB Power Control	29
Tls Auth Configuration	30
Chipset	31
System Agent (SA) Configuration	31
PCH-IO Configuration	32
PCH-IO Configuration ▶ PCI Express Configuration	32
PCH-IO Configuration ▶ SATA Configuration	33
PCH-IO Configuration ▶ HD Audio Configuration	33

Security	34
Secure Boot.....	34
Boot	35
Save & Exit	35
Updating the BIOS.....	36
Notice: BIOS SPI ROM.....	36

About this Manual

This manual can be retrieved from the website.

The manual is subject to change and update without notice, and may be based on editions that do not resemble your actual products. Please visit our website or contact our sales representatives for the latest editions.

Warranty

1. Warranty does not cover damages or failures that arises from misuse of the product, inability to use the product, unauthorized replacement or alteration of components and product specifications.
2. The warranty is void if the product has been subjected to physical abuse, improper installation, modification, accidents or unauthorized repair of the product.
3. Unless otherwise instructed in this user's manual, the user may not, under any circumstances, attempt to perform service, adjustments or repairs on the product, whether in or out of warranty. It must be returned to the purchase point, factory or authorized service agency for all such work.
4. We will not be liable for any indirect, special, incidental or consequential damages to the product that has been modified or altered.

About this Package

The package contains the following items. If any of these items are missing or damaged, please contact your dealer or sales representative for assistance.

- 1 ADP253 board
- 1 Heat sink (Height: 37mm)
- 1 Serial ATA data with power cable

Note: The items are subject to change in the developing stage. The product and accessories in the package may not come similar to the information listed above. This may differ in accordance with the sales region or models in which it was sold. For more information about the standard package in your region, please contact your dealer or sales representative.

Static Electricity Precautions

It is quite easy to inadvertently damage your PC, system board, components or devices even before installing them in your system unit. Static electrical discharge can damage computer components without causing any signs of physical damage. You must take extra care in handling them to ensure against electrostatic build-up.

1. To prevent electrostatic build-up, leave the system board in its anti-static bag until you are ready to install it.
2. Wear an antistatic wrist strap.
3. Do all preparation work on a static-free surface.
4. Hold the device only by its edges. Be careful not to touch any of the components, contacts or connections.
5. Avoid touching the pins or contacts on all modules and connectors. Hold modules or connectors by their ends.



Important:

Electrostatic discharge (ESD) can damage your processor, disk drive and other components. Perform the upgrade instruction procedures described at an ESD workstation only. If such a station is not available, you can provide some ESD protection by wearing an antistatic wrist strap and attaching it to a metal part of the system chassis. If a wrist strap is unavailable, establish and maintain contact with the system chassis throughout any procedures requiring ESD protection.

Safety Precautions

- Use the correct DC / AC input voltage range.
- Unplug the power cord before removing the system chassis cover for installation or servicing. After installation or servicing, cover the system chassis before plugging in the power cord.
- There is danger of explosion if battery incorrectly replaced.
- Replace only with the same or equivalent specifications of batteries recommend by the manufacturer.
- Dispose of used batteries according to local ordinance.
- Keep this system away from humid environments.
- Make sure the system is placed or mounted correctly and stably to prevent the chance of dropping or falling may cause damage.
- The openings on the system shall not be blocked and shall be kept in distance from

other objects to make sure of proper air ventilation to protect the system from over-heating.

- Dress the cables, especially the power cord, so they will not be stepped on, in contact with high temperature surfaces, or cause any tripping hazards.
- Do not place anything on top of the power cord. Use a power cord that has been approved for use with the system and is compliant with the voltage and current ranges required by the system's electrical specifications.
- If the system is to be unused or stored for a long time, disconnect it from the power source to avoid damage by transient overvoltage.
- If one of the following occurs, consult a service personnel:
 - The power cord or plug is damaged.
 - Liquid has penetrated the system.
 - The system has been exposed to moisture.
 - The system is not working properly.
 - The system is physically damaged.
- The unit uses a three-wire ground cable which is equipped with a third pin to ground the unit and prevent electric shock. Do not defeat the purpose of this pin. If your outlet does not support this kind of plug, contact your electrician to replace the outlet.
- Disconnect the system from the electricity outlet before cleaning. Use a damp cloth for cleaning the surface. Do not use liquid or spray detergents for cleaning.
- Before connecting, make sure that the power supply voltage is correct. The device is connected to a power outlet which should be grounded connection.



The system may burn fingers while running.

Wait for 30 minutes to handle electronic parts after power off.

Chapter 1 - Introduction

► Specifications

SYSTEM	Processor	12th Gen Intel® Core™ Processors, BGA 1744 (Alder Lake-P, 15W) Intel® Core™ i7-1265UE Processor, 10C12T, 12M Cache, 1.7GHz (4.7GHz) Intel® Core™ i5-1245UE Processor, 10C12T, 12M Cache, 1.5GHz (4.4GHz) Intel® Core™ i3-1215UE Processor, 6C8T, 10M Cache, 1.2GHz (4.4GHz) Intel® Celeron® 7305E Processor, 5C5T, 8M Cache, 1.0GHz
	Memory	8GB On-board memory & one SO-DIMM DDR4 up to 32GB Dual Channel DDR4 3200MHz
	BIOS	AMI SPI 256Mbit (Supports UEFI boot only)
GRAPHICS	Controller	Intel® Iris® Xe Graphics Intel® UHD Graphics
	Feature	DirectX 12, Open GL 4.6, Vulkan 1.2 HW Decode: AV1, AVC/H.264, MJPEG, HEVC/H.265, VP9, SCC HW Encode: MJPEG, AVC/H.264, HEVC/H.265, VP9, SCC
	Display	1 x HDMI HDMI: Resolution up to 4096x2160 @60Hz 1 x VGA/DP (Opt.) VGA: Resolution up to 1920x1200 @60Hz DP: Resolution up to 4096x2304 @60Hz 2 x Type-C DP Alt. Mode
	Multiple Displays	HDMI + VGA/DP (Optional) + Type-C DP Alt. Mode + Type-C DP Alt. Mode
EXPANSION	Interface	1 x M.2 M Key 2280 (PCIex4/SATA) 1 x M.2 B Key 3042/3052 (USB3.0/USB2.0/PCIex1) 1 x M.2 E Key 2230 (CNVi/PCIex1/USB2.0) 1 x SIM slot for 4G/5G
AUDIO	Audio Codec	Realtek ALC888S
ETHERNET	Controller	1 x Intel® I225LM/IT (10/100/1000/2500Mbps) 2 x Intel® I225LM/IT (10/100/1000Mbps) (Only Core i7/i5 supports iAMT)
REAR I/O	Ethernet	1 x 2.5GHz (RJ-45) + 2 x GbE (RJ-45)
	Serial	COM 3: 1 x RS-232 (also supports an optional 8-bit DIO)
	USB	4 x USB 3.2 Default: 2 x Type C + 2 x Type A connector Option: 4 x Type A connector
	Audio	1 x Audio Combo Phone Jack (Line-out/Mic-in)
	Display	1 x HDMI 2 x Type-C DP Alt. Mode

FRONT I/O	Serial	COM 1 / COM 2: 2 x RS-232/422/485 COM 4: 1 x RS-232
	Display	1 x VGA/DP (Optional)
	Button	1 x Power Button 1 x Reset Button
INTERNAL I/O	Serial	COM 5 / COM 6: 2 x RS-232 (2.0mm pitch, box header)
	USB	2 x USB 2.0 (2.0mm pitch, box header)
	Audio	1 x Front Audio (Line-out/Mic-in, 2.0mm pitch, box header)
	SATA	1 x SATA 3.0 (up to 6Gb/s) 1 x SATA Power (5V/12V)
	Others	1 x Front Panel 1 x System Fan Connector (Optional)
WATCHDOG TIMER	Output & Interval	System Reset, Programmable via Software from 1 to 255 Seconds
SECURITY	TPM	Discrete TPM 2.0
	Type	9~36 VDC input
POWER	Connector	One power jack with lock. (Default) Co-lay 2x2 pin power connector straight type and right angle type
	Consumption	TBD
	RTC Battery	CR2032 Coin Cell, link mother board with cable
OS SUPPORT	Microsoft	Windows 10 IoT Enterprise 64-bit Windows 11
	Linux	Linux
MECHANISM	Dimensions	4" SBC Form Factor , 165mm (6.49") x 115mm (4.53")
	Height	PCB: 1.6mm Top Side: 16.34mm, Bottom Side: 3mm
ENVIRONMENT	Temperature	Operating: -5 to 65°C / -30 to 80°C Storage: -40 to 85°C
	Humidity	Operating: 5 to 90% RH Storage: 5 to 90% RH
	MTBF	TBD

► Dimensions

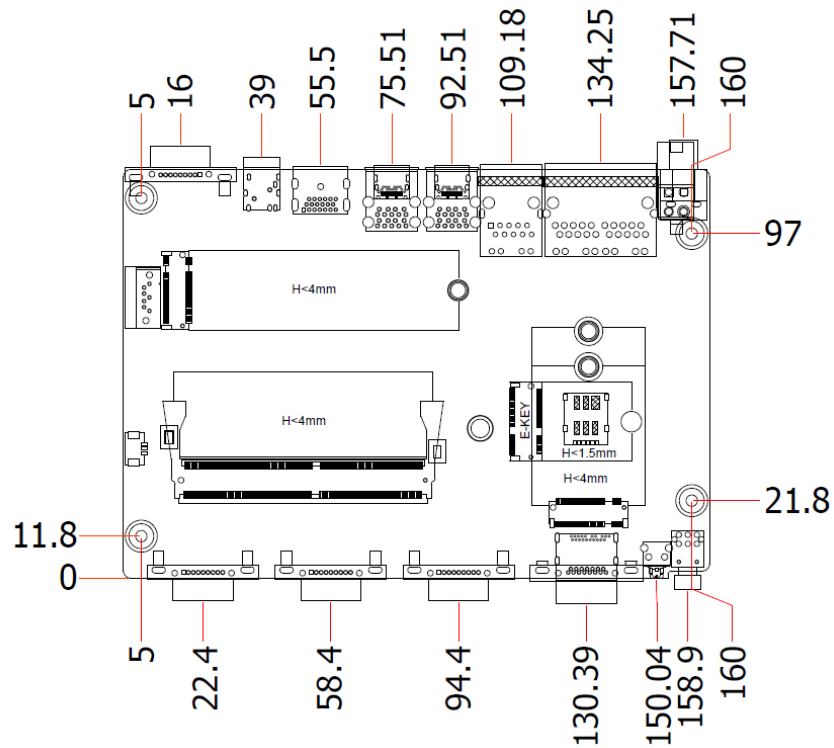

► Block Diagram

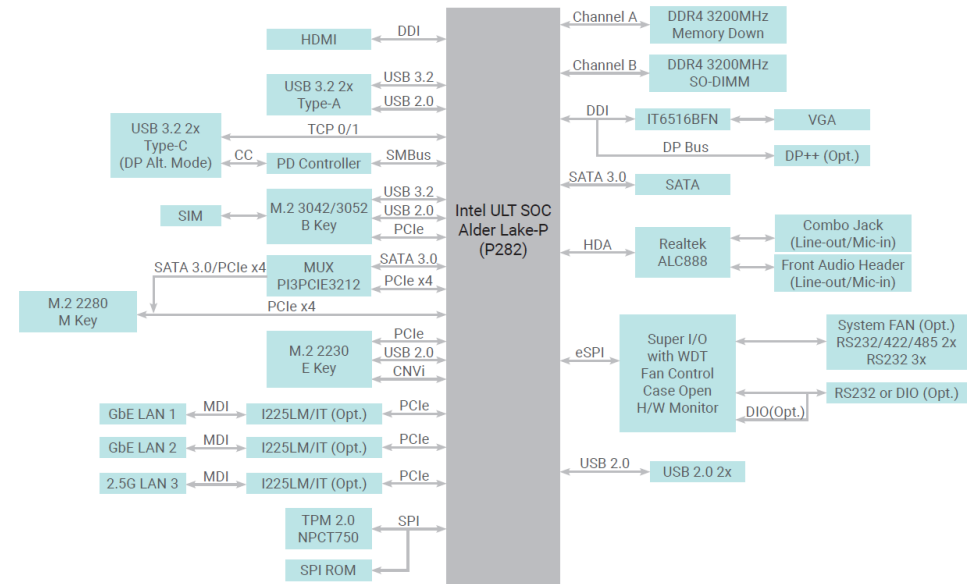

Chapter 2 - Hardware Installations

► Overview

Top View

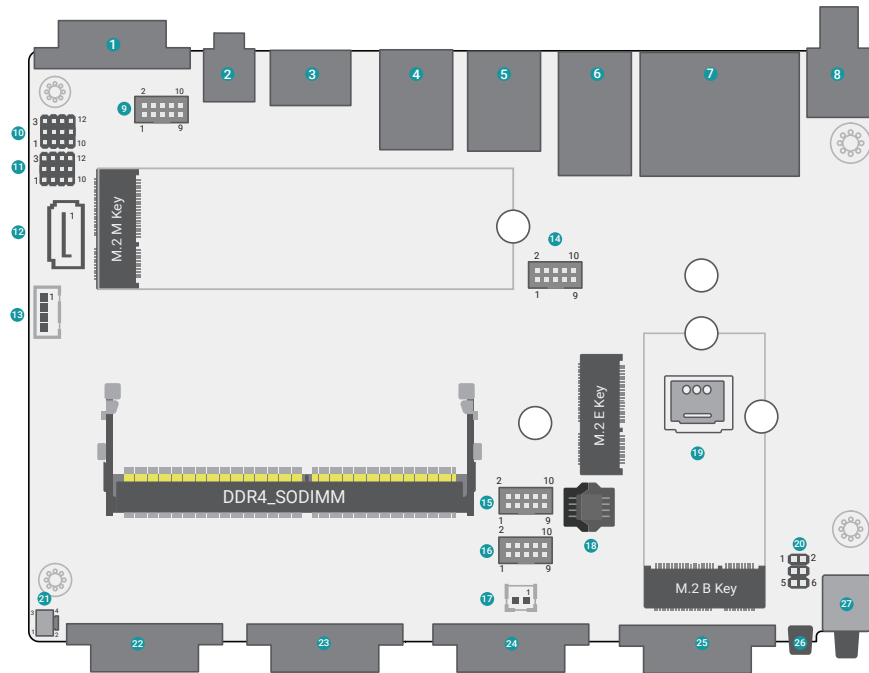

- | | | | |
|----|----------------------------------|----|--------------|
| 1 | COM3 (RS232) / DIO (Optional) | 21 | Clear CMOS |
| 2 | Audio | 22 | COM2 |
| 3 | HDMI | 23 | COM1 |
| 4 | ▲USB3.2 Type A
▼USB3.2 Type C | 24 | COM4 |
| 5 | ▲USB3.2 Type A
▼USB3.2 Type C | 25 | VGA |
| 6 | 2.5G LAN3 | 26 | Reset Button |
| 7 | LAN2 / LAN1 | 27 | Power Button |
| 8 | DC-IN | | |
| 9 | Front Audio | | |
| 10 | COM Serial / DIO Switch (JP8) | | |
| 11 | COM Serial / DIO Switch (JP9) | | |
| 12 | SATA | | |
| 13 | SATA Power | | |
| 14 | USB2.0 | | |
| 15 | COM6 | | |
| 16 | COM5 | | |
| 17 | RTC Battery | | |
| 18 | SPI | | |
| 19 | SIM Slot | | |
| 20 | Front Panel | | |

► Jumper Settings

COM Serial / DIO Switch (JP8 & JP9)

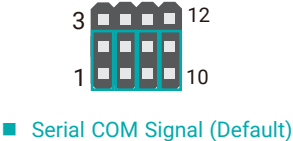
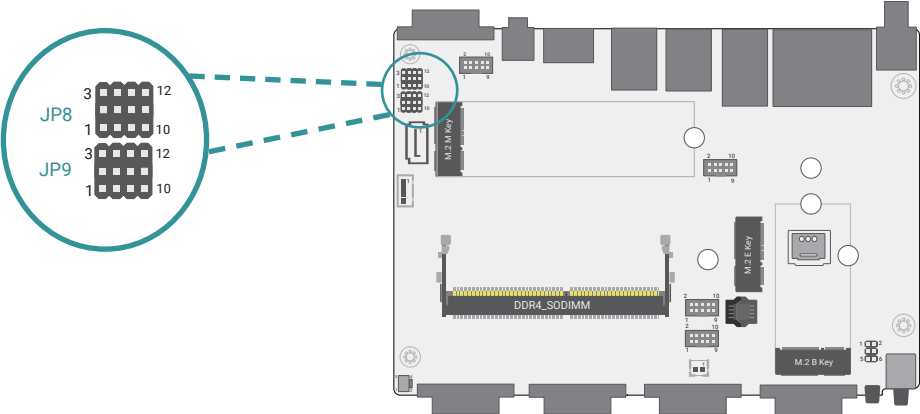

► **Pin Assignment**

RTC Battery (J1)

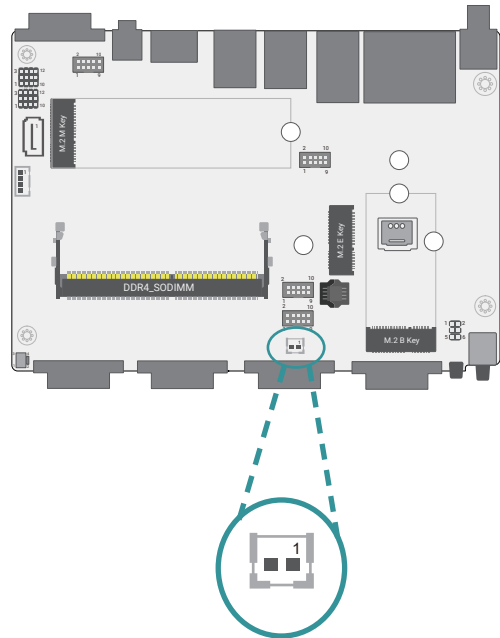

Pin	Assignment
1	V_BAT
2	GND

SATA Power (CN8)

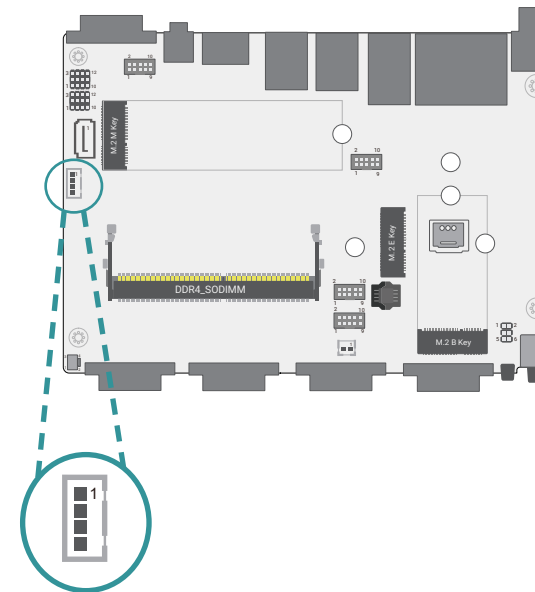

Pin	Assignment
1	12V
2	GND
3	GND
4	5V

SATA (J12)

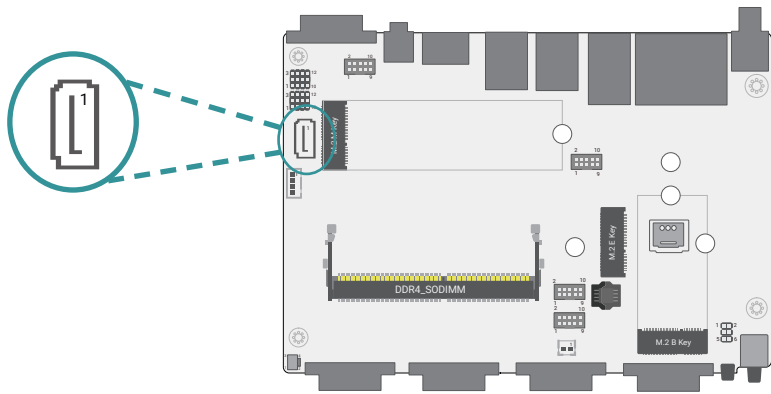

Pin	Assignment
1	GND
2	TX+
3	TX-
4	GND
5	RX-
6	RX+
7	GND

Front Panel (JP10)

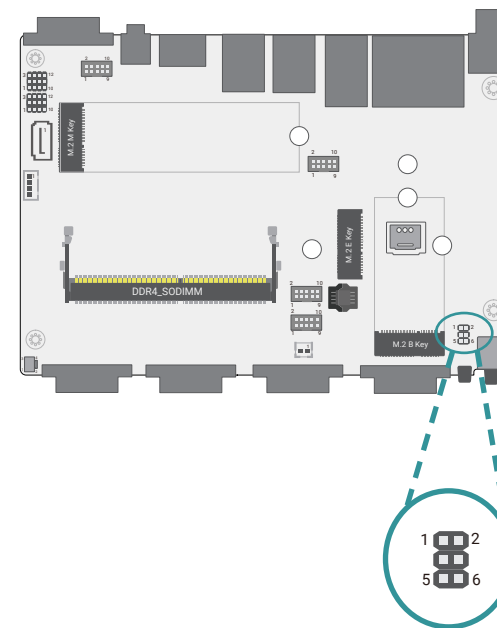

Pin	Assignment	Pin	Assignment
1	PWR_BTN0	2	V_SUS_LED
3	GND	4	SUS_LED#
5	SYS_RST0	6	HD_LED#

COM1 (CN49) & COM2 (CN50)

COM4 (CN52) & COM5 (J22) & COM6 (J23)

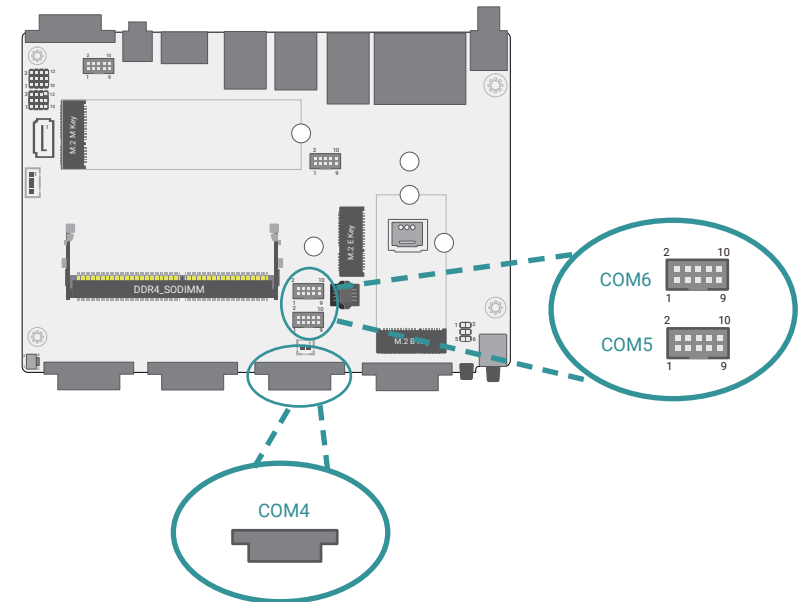
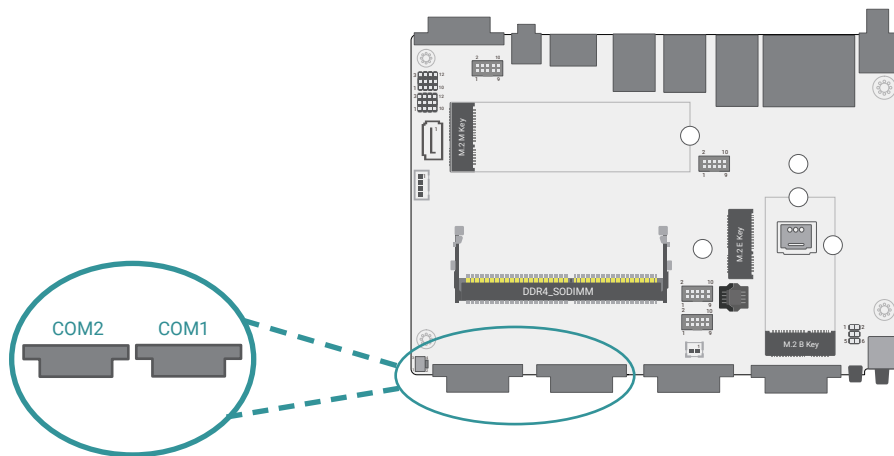

Pin	RS232	RS422	RS485
1	DCD-	TXD-	Data-
2	RD	TXD+	Data+
3	TD	RXD+	N.C.
4	DTR-	RXD-	N.C.
5	GND	GND	GND
6	DSR-	N.C.	N.C.
7	RTS-	N.C.	N.C.
8	CTS-	N.C.	N.C.
9	RI-	N.C.	N.C.

Pin	Assignment	Pin	Assignment
1	MDCD-	2	MSIN-
3	MSO-	4	MDTR-
5	GND	6	MDSR-
7	MRTS-	8	MCTS-
9	MRI-	10	NC

COM3/DIO (Optional) (CN51)

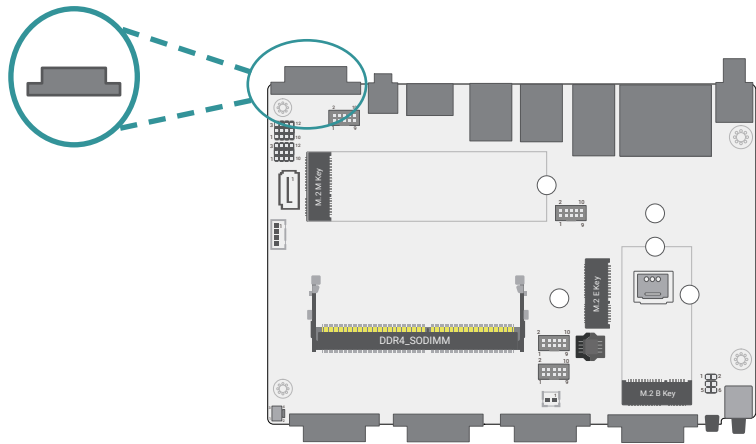

■ COM3 Pin Assignment

Pin	Assignment	Pin	Assignment
1	MDCD-	2	MSIN-
3	MSO-	4	MDTR-
5	GND	6	MDSR-
7	MRTS-	8	MCTS-
9	MRI-	10	NC

■ DIO Pin Assignment (Optional)

Pin	Assignment	Pin	Assignment
1	DIOA0	2	DIOA1
3	DIOA2	4	DIOA3
5	GND	6	DIOA6
7	DIOA7	8	DIOA4
9	DIOA5		

► Expansion Slots

Installing the M.2 Module

Before installing the M.2 module into the M.2 socket, please make sure that the following safety cautions are well-attended.

1. Make sure the PC and all other peripheral devices connected to it has been powered down.
2. Disconnect all power cords and cables.
3. Locate the M.2 socket on the system board
4. Make sure the notch on card is aligned to the key on the socket.
5. Make sure the standoff screw is removed from the standoff.

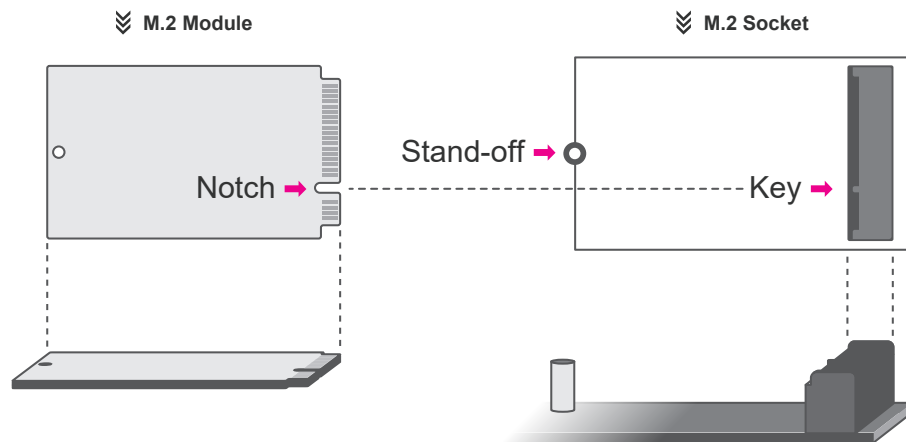

Please follow the steps below to install the card into the socket.

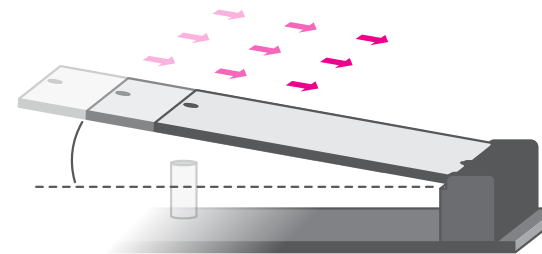

Step 1:
Insert the card into the socket at an angle while making sure the notch and key are perfectly aligned.

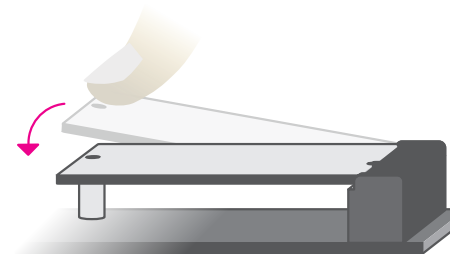

Step 2:
Press the end of the card far from the socket down until the stand-off closes up.

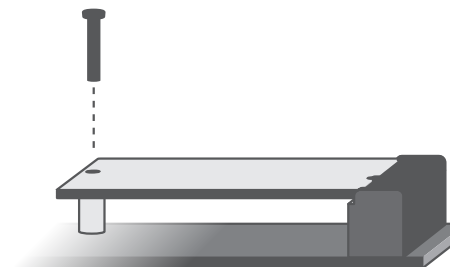

Step 3:
Screw tight the card onto the stand-off with a screw driver and a stand-off screw until the gap between the card and the stand-off closes up. The card should be lying parallel to the board when it's correctly mounted.

Installing the SO-DIMM Module

Before installing the memory module, please make sure that the following safety cautions are well-attended.

1. Make sure the PC and all other peripheral devices connected to it has been powered down.
2. Disconnect all power cords and cables.
3. Locate the SO-DIMM socket on the system board
4. Make sure the notch on memory card is aligned to the key on the socket.

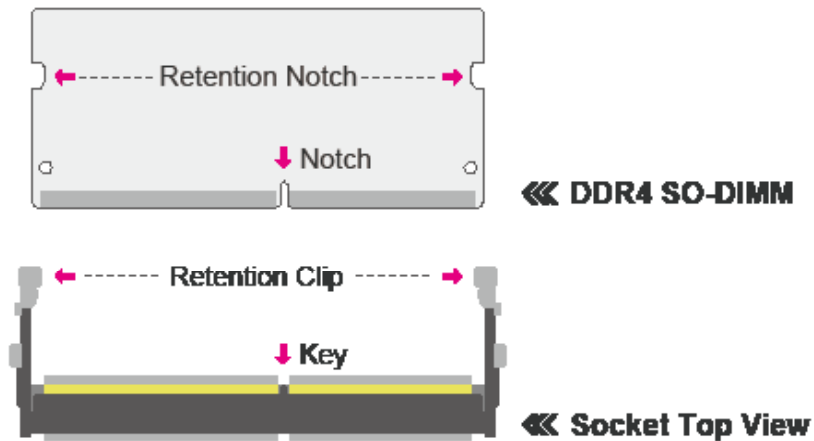

Please follow the steps below to install the memory card into the socket.

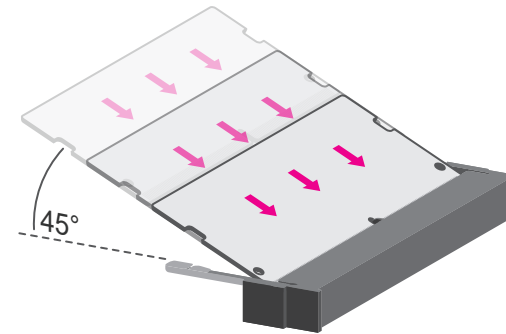

Step 1:
Insert the memory card into the slot while making sure 1) the notch and the key are aligned, and 2) the non-connector end rises approximately 45 degrees horizontally. Press the card firmly into the socket while applying and maintaining even pressure on both ends.

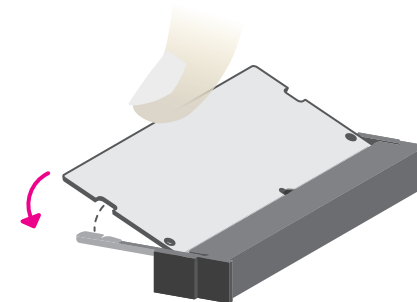

Step 2:
Press the end of the card far from the socket down while making sure the retention notch and the clip align as indicated by the dotted line in the illustration. If the retention notch and the clip do not align, please remove the card and re-insert it. Press the card all the way down.

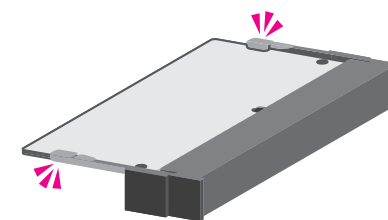

Step 3:
The clips snap automatically and abruptly to the retention notches of the card sounding a distinctive click, and lock the card in place. Inspect that the clip sits in the notch. If not, please pull the clips outward, release and remove the card, and mount it again.

► Installing the Heatsink

The system board may come with a heatsink, including four stand-offs and four stand-off screws to secure the board and heatsink onto the chassis. The assembly is expected to be installed in the manners as illustrated below.

Step 1:

To avoid damage from the excessive force, please first put the heatsink on the surface and turn the thermal pad side upwards. Remove any plastic film on the interface metal and apply thermal paste/adhesive if it is required. Place the motherboard on top of the heatsink. CPU should be facing the interface metal side of the heat sink.

Make sure the mounting holes are aligned. Screw tight the mounting hole in the middle of the motherboard. Please see the illustration circled in red.

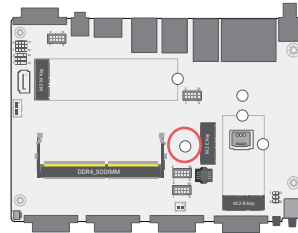

Step 2:

Screw the stand-offs onto the chassis. This step can be omitted if there exist pre-installed stand-offs on the chassis.



Step 3:

Place the module combo onto the stand-offs. Make sure the stand-off screw holes on the combo and those on the stand-offs align.

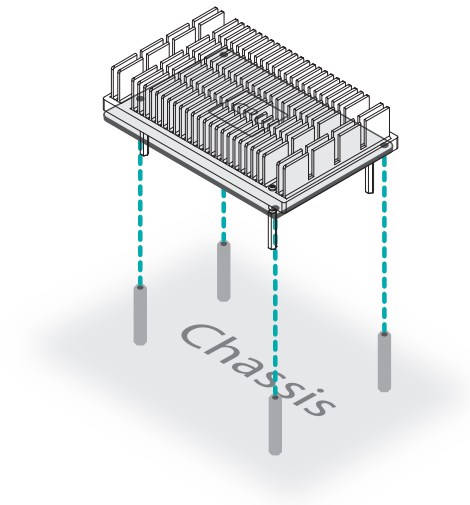

Step 4:

Place the stand-off screws provided in the package into the screw holes of the combo. Use a screwdriver to fasten the screws onto the chassis tight.

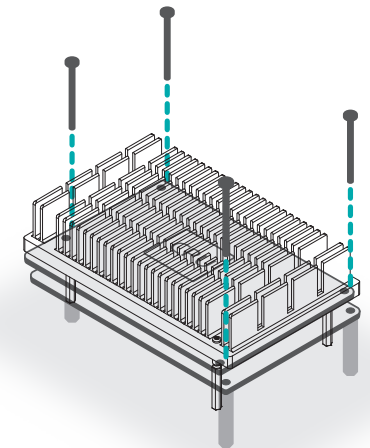

Note:
Do not use excessive force or place direct pressure on the board. It affects the board's performance and may damage the motherboard.



Note:
It is typical that the chassis is customized, in which case the installation shall vary according to the design of the chassis instead of the instructions provided here.

Chapter 3 - BIOS Settings

► Overview

The BIOS is a program that takes care of the basic level of communication between the CPU and peripherals. It contains codes for various advanced features found in this system board. The BIOS allows you to configure the system and save the configuration in a battery-backed CMOS so that the data retains even when the power is off. In general, the information stored in the CMOS RAM of the EEPROM will stay unchanged unless a configuration change has been made such as a hard drive replaced or a device added. It is possible that the CMOS battery will fail causing CMOS data loss. If this happens, you need to install a new CMOS battery and reconfigure the BIOS settings.



Note:

The BIOS is constantly updated to improve the performance of the system board; therefore the BIOS screens in this chapter may not appear the same as the actual one. These screens are for reference purpose only.

Default Configuration

Most of the configuration settings are either predefined according to the Load Optimal Defaults settings which are stored in the BIOS or are automatically detected and configured without requiring any actions. There are a few settings that you may need to change depending on your system configuration.

Entering the BIOS Setup Utility

The BIOS Setup Utility can only be operated from the keyboard and all commands are keyboard commands. The commands are available at the right side of each setup screen. The BIOS Setup Utility does not require an operating system to run. After you power up the system, the BIOS message appears on the screen and the memory count begins. After the memory test, the message "Press DEL to run setup" will appear on the screen. If the message disappears before you respond, restart the system or press the "Reset" button. You may also restart the system by pressing the <Ctrl> <Alt> and keys simultaneously.

Legends

Keys	Function
Right / Left arrow	Move the highlight left or right to select a menu
Up / Down arrow	Move the highlight up or down between submenus or fields
<Enter>	Enter the highlighted submenu
+ (plus key)/F6	Scroll forward through the values or options of the highlighted field
- (minus key)/F5	Scroll backward through the values or options of the highlighted field
<F1>	Display general help
<F2>	Display previous values
<F7>	Popup Boot Device List
<F9>	Optimized defaults
<F10>	Save and Exit
<Esc>	Return to previous menu

Scroll Bar

When a scroll bar appears to the right of the setup screen, it indicates that there are more available fields not shown on the screen. Use the up and down arrow keys to scroll through all the available fields.

Submenu

When "►" appears on the left of a particular field, it indicates that a submenu which contains additional options are available for that field. To display the submenu, move the highlight to that field and press <Enter>.

► Main

The Main menu is the first screen that you will see when you enter the BIOS Setup Utility.

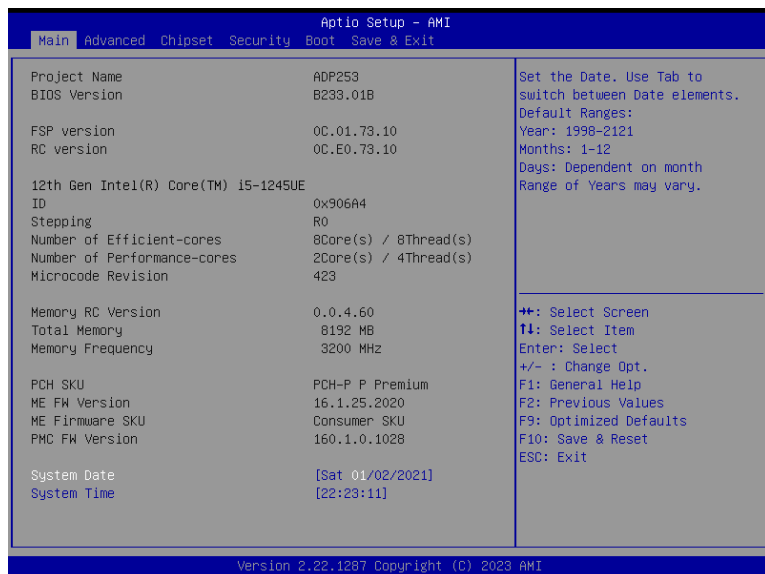

System Date

The date format is <month>, <date>, <year>. Press "Tab" to switch to the next field and press "-" or "+" to modify the value.

System Time

The time format is <hour>, <minute>, <second>. The time is based on the 24-hour military-time clock. For example, 1 p.m. is 13:00:00. Hour displays hours from 00 to 23. Minute displays minutes from 00 to 59. Second displays seconds from 00 to 59.

► Advanced

The Advanced menu allows you to configure your system for basic operation. Some entries are defaults required by the system board, while others, if enabled, will improve the performance of your system or let you set some features according to your preference.



Important:
Setting incorrect field values may cause the system to malfunction.

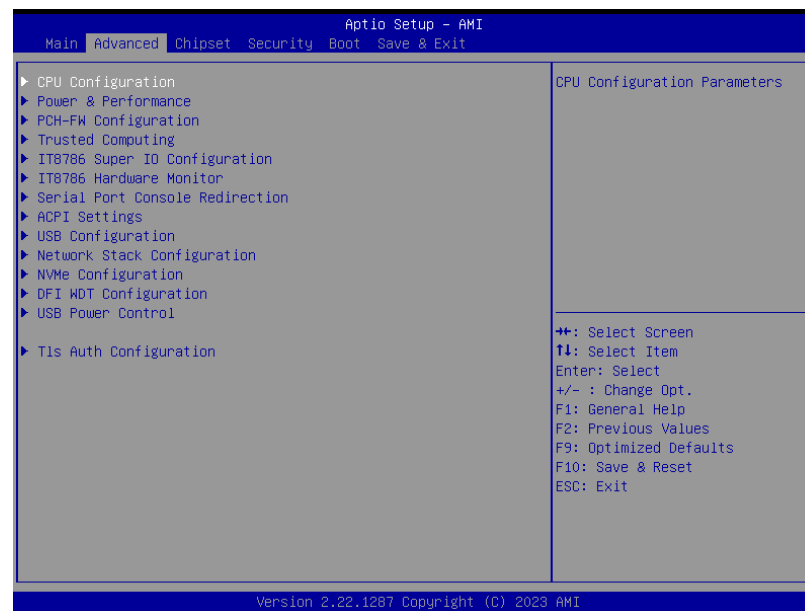

▶ Advanced

CPU Configuration

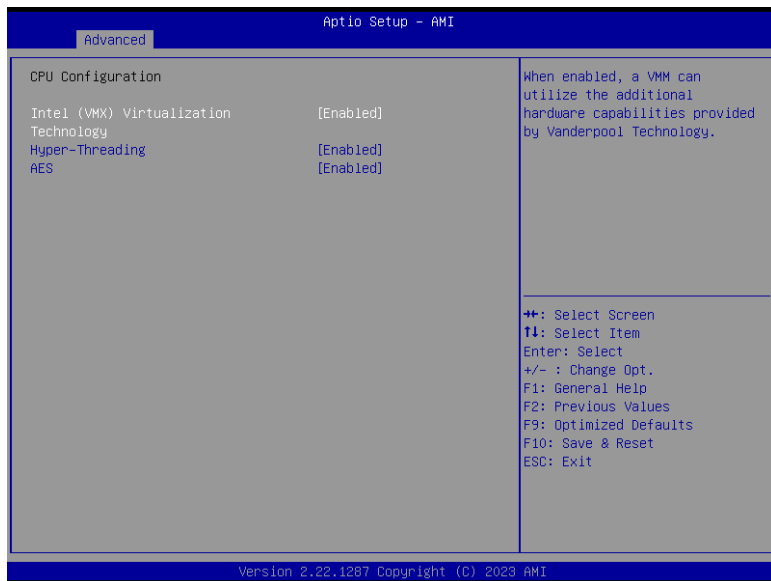

Intel (VMX) Virtualization Technology

When this field is set to Enabled, the VMM can utilize the additional hardware capabilities provided by Vanderpool Technology.

Active Processor Cores

Select number of cores to enable in each processor package: all or 1.

Hyper-threading

Enables this field for Windows XP and Linux which are optimized for Hyper-Threading technology. Select disabled for other OSes not optimized for Hyper-Threading technology. When disabled, only one thread per enabled core is enabled.

AES

Enable or disable AES function.



Note:

Some of the fields may not be available when the features are not supported by the equipped CPU.

▶ Advanced

Power & Performance



▶ Advanced

PCH-FW Configuration

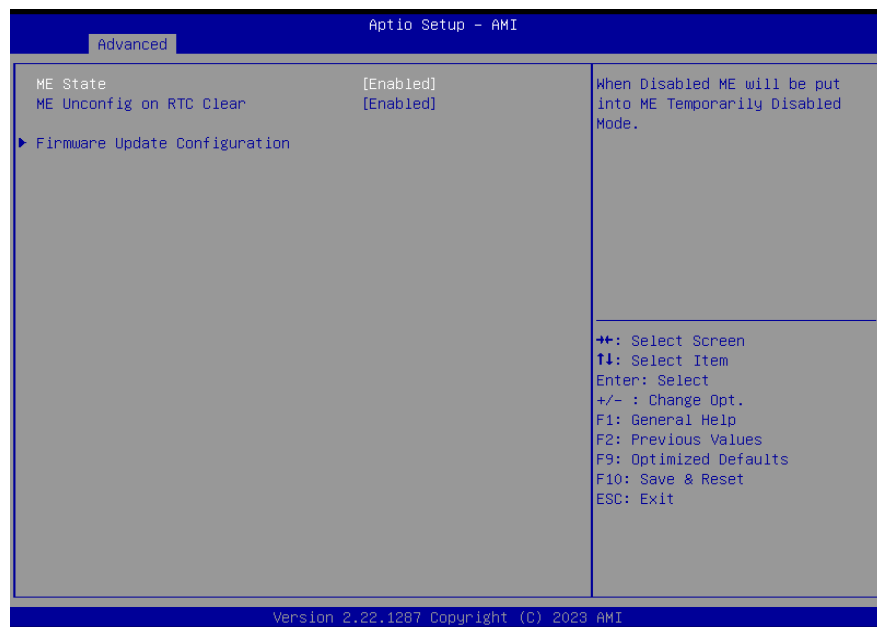

ME State

When this field is set to Disabled, ME will be put into ME Temporarily Disabled Mode.

ME Unconfig on RTC Clear

When disabled, ME will not be unconfigured on RTC Clear.

Firmware Update Configuration

Configure Management Engine Technology Parameter



Note:
The sub-menus are detailed in following sections.

▶ Advanced

Trusted Computing



Security Device Support

This field is used to enable or disable BIOS support for the security device such as an TPM 2.0 to achieve hardware-level security via cryptographic keys.

Pending operation

To clear the existing TPM encryption, select "TPM Clear" and restart the system. This field is not available when "Security Device Support" is disabled.

▶ Advanced

IT8786 Super IO Configuration

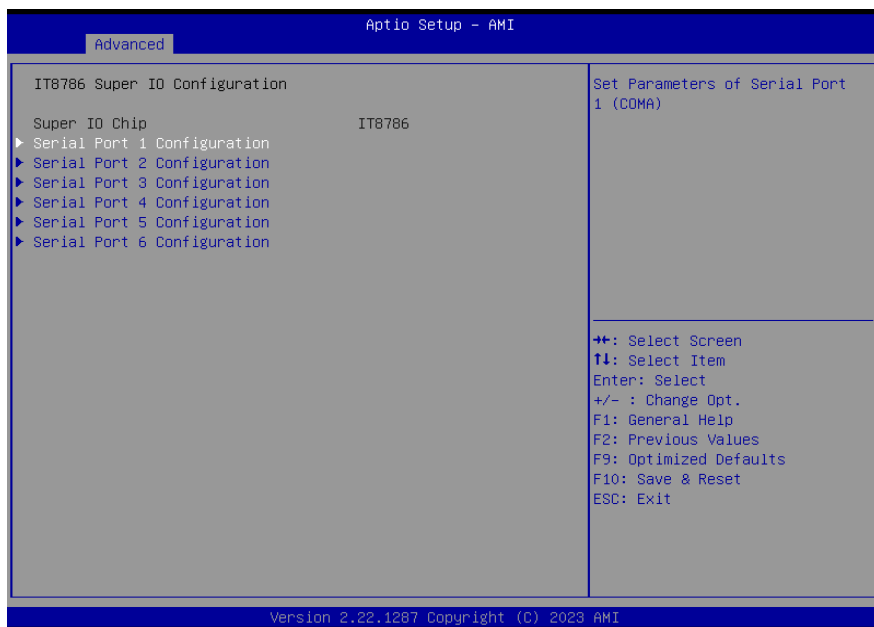

WatchDog Timer Unit

Select WatchDog Timer Unit – Second or Minute.

SuperIO WatchDog Timer

Set SuperIO WatchDog Timer Timeout value. The range is from 0 (disabled) to 255.



Note: The sub-menus are detailed in following sections.

▶ Advanced

IT8786 Super IO Configuration ▶ Serial Port 1, 2 Configuration



Serial Port

Enable or disable serial port.

▶ Advanced

IT8786 Super IO Configuration ▶ Serial Port 3, 4 Configuration

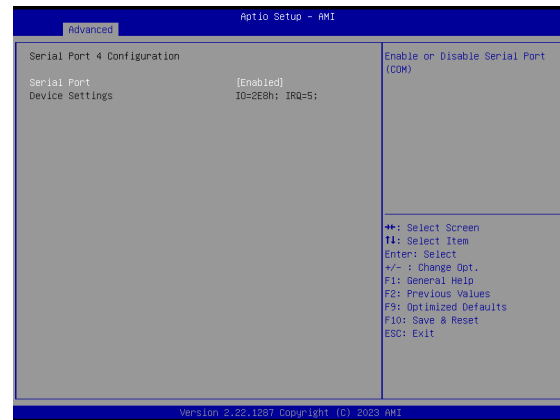
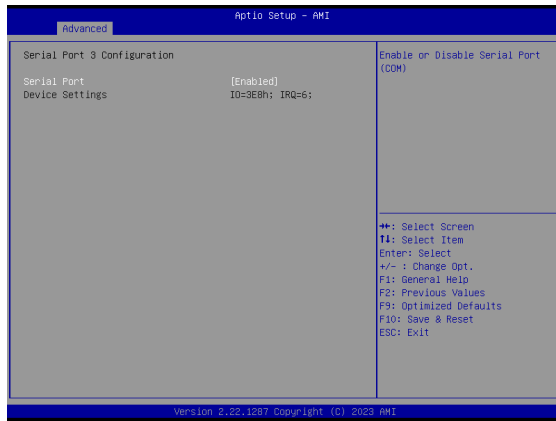

Serial Port

Enable or disable serial port.

▶ Advanced

IT8786 Super IO Configuration ▶ Serial Port 5, 6 Configuration



Serial Port

Enable or disable serial port.

▶ Advanced

IT8786 Hardware Monitor

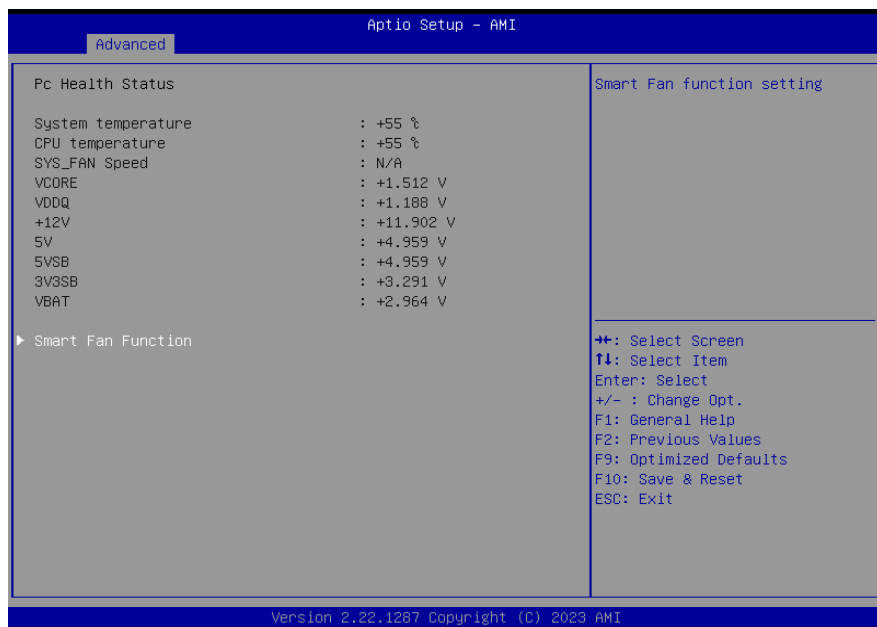

This section displays the system's health information, i.e. voltage readings, CPU and system temperatures, and fan speed readings

▶ Advanced

IT8786 Hardware Monitor ▶ Smart FAN Function



Smart Fan is a fan speed moderation strategy dependent on the current system temperature. When the system temperature goes higher than the Boundary setting, the fan speed will be turned up to the setting of the Fan Speed Count that bears the same index as the Boundary field.

SYS FAN Mode

Smart Fan Mode Select.

Fan off temperature limit

Fan will off when temperature lower than this limit.

Fan start temperature limit

Fan will work when temperature higher than this limit.

Fan full speed temperature limit

Fan will full speed when temperature higher than this limit.

Fan start PWM

Fan will start with this PWM value.

▶ **Advanced**

Serial Port Console Redirection

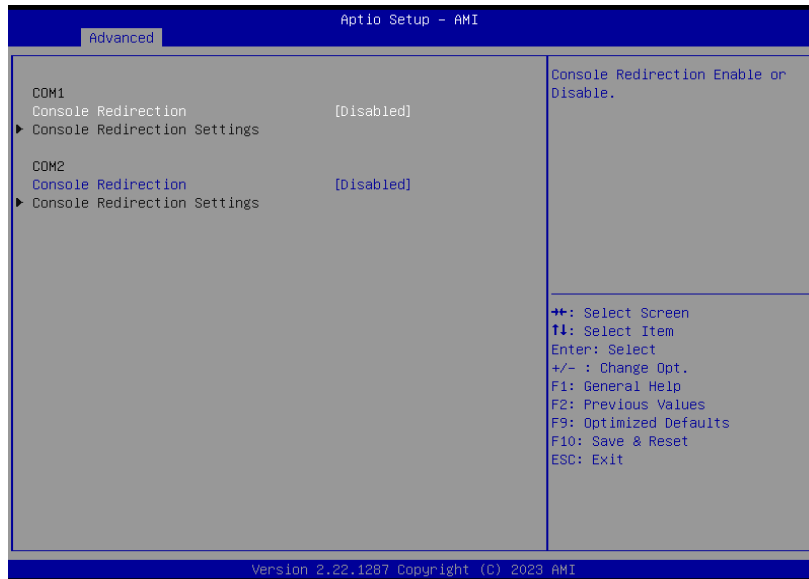

Console Redirection

By enabling Console Redirection of a COM port, the sub-menu of console redirection settings will become available for configuration as detailed in the following.

▶ **Advanced**

Serial Port Console Redirection ▶ Console Redirection Settings



Configure the serial settings of the current COM port.

Terminal Type

Select terminal type: VT100, VT100+, VT-UTF8 or ANSI.

Bits per second

Select serial port transmission speed: 9600, 19200, 38400, 57600 or 115200.

Data Bits

Select data bits: 7 bits or 8 bits.

Parity

Select parity bits: None, Even, Odd, Mark or Space.

Stop Bits

Select stop bits: 1 bit or 2 bits.

Flow Control

Select flow control type: None or Hardware RTS/CTS. Flow Control is for RS485 mode and is only supported by Serial Port 1 (COM1).

VT-UTF8 Combo Key Support

Enable or disable VT-UTF8 Combination Key Support for ANSI/VT100 terminals.

Recorder Mode

With this mode enabled only text will be sent. This is to capture Terminal data.

Resolution 100x31

Enables or disables extended terminal resolution.

Putty Keypad

Select FunctionKey and KeyPad on Putty.

- VT100
- LINUX
- XTERMR6
- SCO
- ESCN
- VT400

▶ Advanced

ACPI Settings



Wake system from S5 via RTC

When Enabled, the system will automatically power up at a designated time every day. Once it's switched to [Enabled], please set up the time of day – hour, minute, and second – for the system to wake up.

State After G3

Select between S0 State, and S5 State. This field is used to specify what state the system is set to return to when power is re-applied after a power failure (G3 state).

- **S0 State** The system automatically powers on after power failure.
- **S5 State** The system enter soft-off state after power failure. Power-on signal input is required to power up the system.
- **Last State** The system returns to the last state right before power failure.

► Advanced

USB Configuration

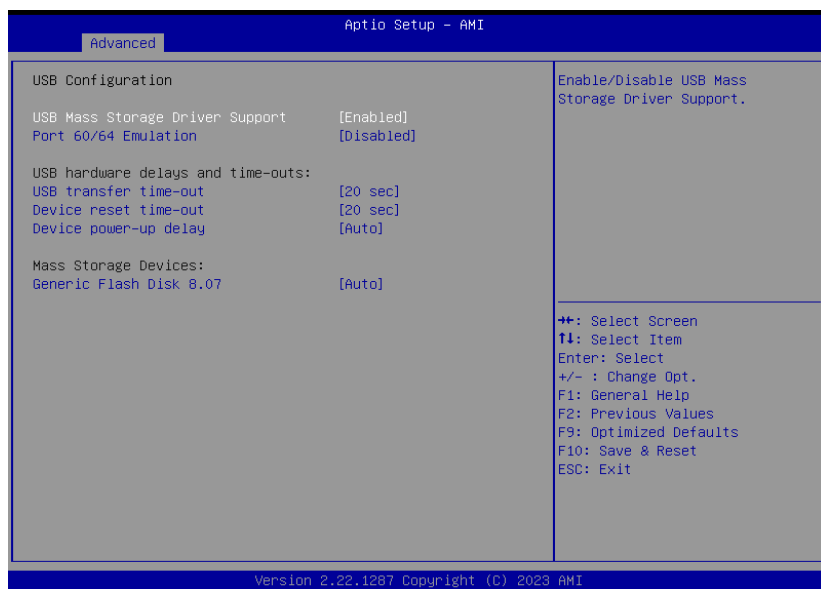

USB Mass Storage Driver Support

Enable or disable USB Mass Storage Driver Support.

Port 60/64 Emulation

Enables I/O port 60h/64h emulation support. This should be enabled for the complete USB keyboard legacy support for non-USB aware Oses.

USB transfer time-out

The time-out value for Control, Bulk, and Interrupt transfers: 1,5,10,20 secs.

Device reset time-out

USB mass storage device Start Unit command time-out: 10,20,30, 40 secs.

Device power-up delay

Maximum time the device will take before it properly reports itself to the Host Controller.

'Auto' uses default value: for a Root port it is 100 ms, for a Hub port the delay is taken from Hub descriptor.

► Advanced

Network Stack Configuration

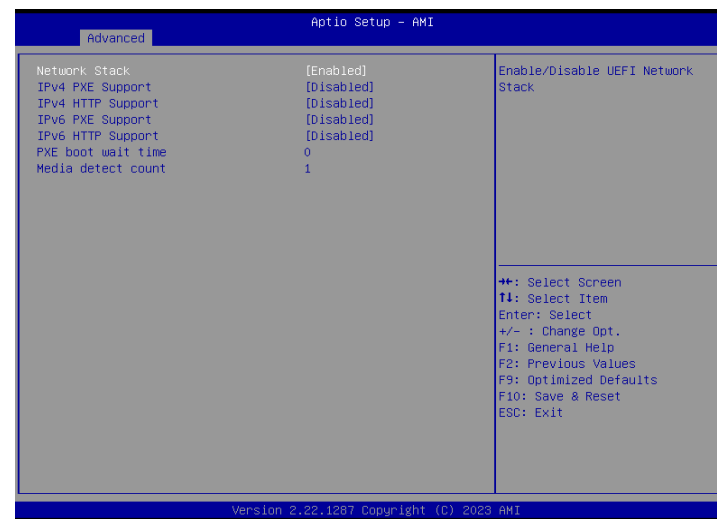

Network Stack

Enable or disable UEFI network stack. The following fields will appear when this field is enabled.

IPv4 PXE/HTTP Support

Enable or disable IPv4 PXE/HTTP boot support. If disabled, IPv4 PXE/HTTP boot support will not be available.

IPv6 PXE/HTTP Support

Enable or disable IPv6 PXE/HTTP boot support. If disabled, IPv6 PXE/HTTP boot support will not be available.

PXE boot wait time

Set the wait time in seconds to press ESC key to abort the PXE boot. Use either +/- or numeric keys to set the value.

Media detect count

Set the number of times the presence of media will be checked. Use either +/- or numeric keys to set the value.

▶ Advanced

DFI WDT Configuration

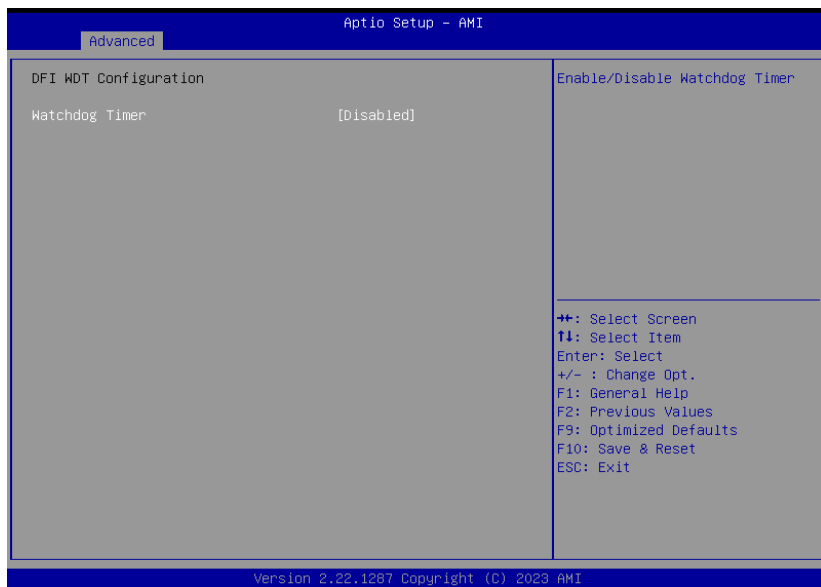

Watchdog Timer

Enable or disable Watchdog Timer.

▶ Advanced

USB Power Control

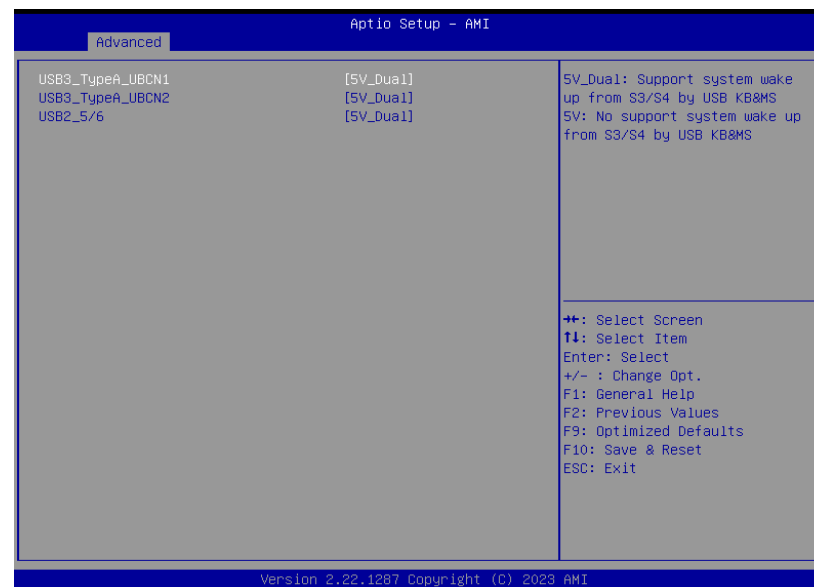

USB Power Switch

5_Dual: Support system wake up from S3/S4 by USB KB&MS

5V: No support system wake up from S3/S4 by USB KB&MS

▶ **Advanced**

Tls Auth Configuration

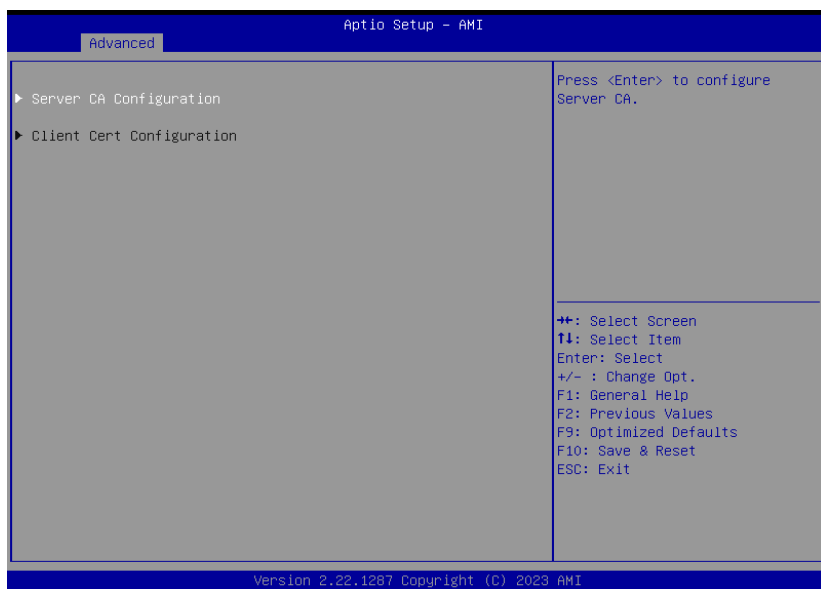

▶ **Server CA Configuration**

• **Enroll Cert**

Press <Enter> to enroll cert.

• **Delete Cert**

Press <Enter> to delete cert.

▶ **Client Cert Configuration**

Press <Enter> to configure Client Cert Configuration.

► Chipset

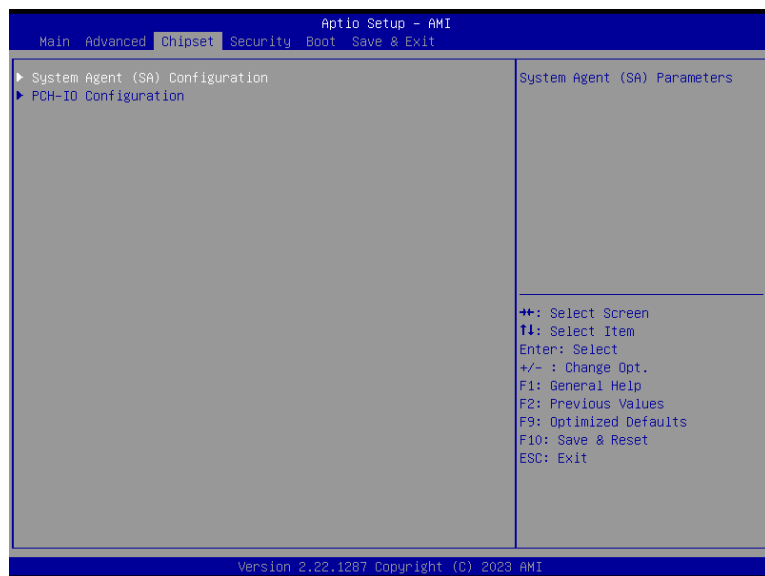

Please select a submenu and press Enter. The submenus are detailed in the following pages.

► Chipset

System Agent (SA) Configuration

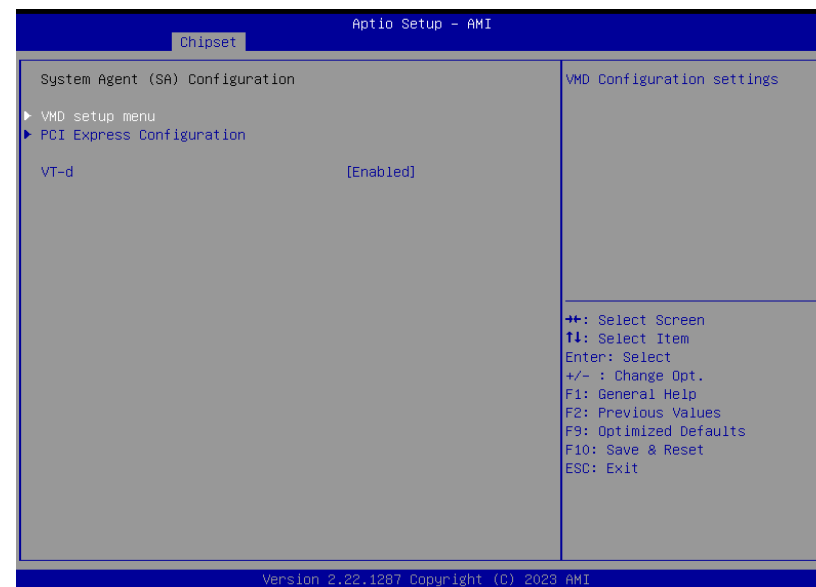

► **VMD setup menu**

VMD Configuration settings.

► **PCI Express Configuration**

PCI Express Configuration settings.

VT-d

Disable or enable VT-d.

► Chipset

PCH-IO Configuration

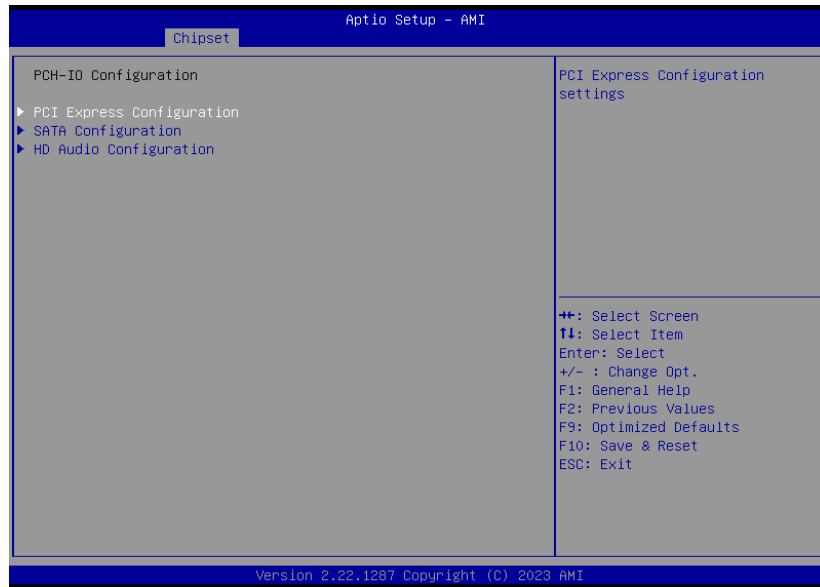

PCI Express Configuration

PCI Express Configuration Settings

SATA Configuration

SATA Device Options Settings

HD Audio Configuration

HD Audio Subsystem Configuration Settings

► Chipset

PCH-IO Configuration ► PCI Express Configuration

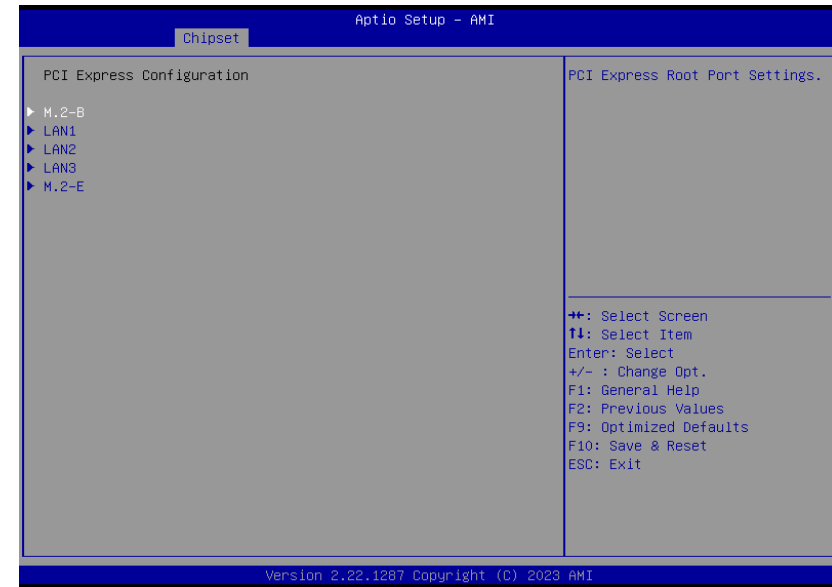

Select one of the PCI Express channels and press enter to configure the following settings.

LAN 1, LAN2, LAN3, M.2-E, M.2-B

Control the PCI Express Root Port.

► Chipset

PCH-IO Configuration ► SATA Configuration

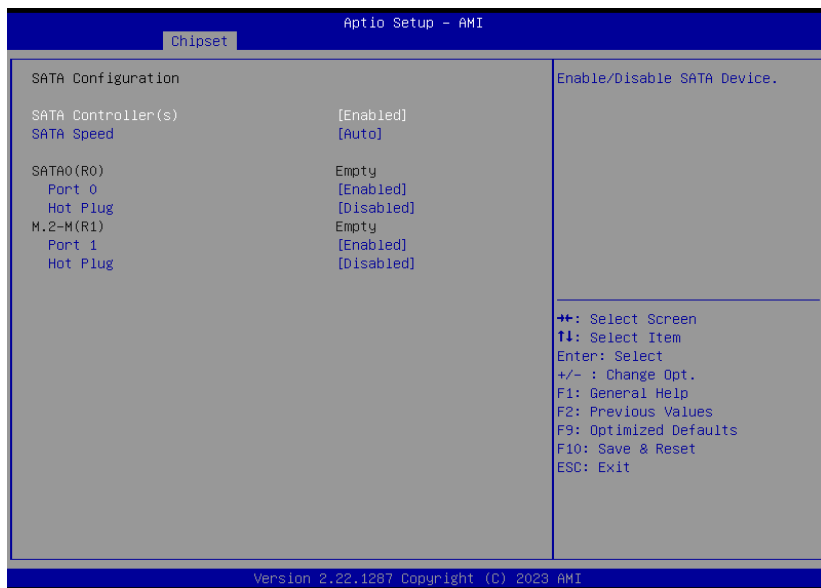

SATA Controller(s)

This field is used to enable or disable the Serial ATA controller.

SATA Speed

This field is used to select SATA speed generation limit: Auto, Gen1, Gen2 or Gen3.

Ports and Hot Plug

Enable or disable the Serial ATA port and its hot plug function.

► Chipset

PCH-IO Configuration ► HD Audio Configuration

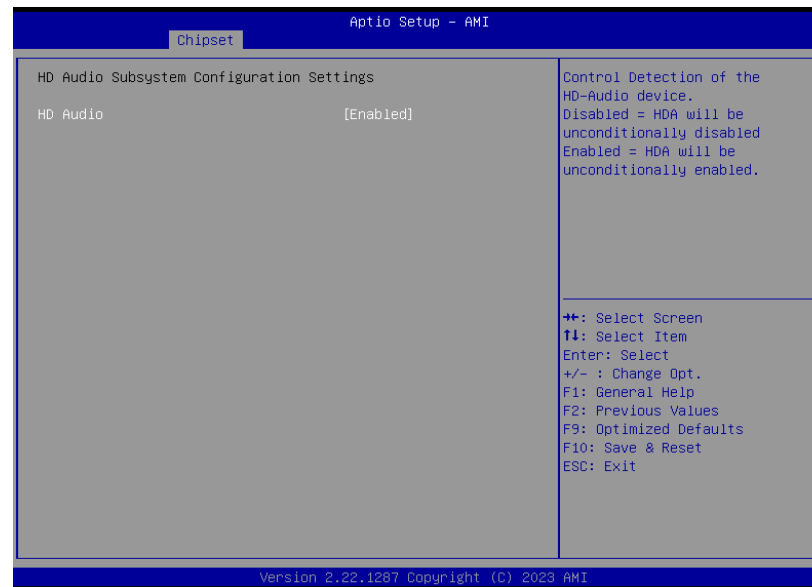

HD Audio

Control the detection of the HD Audio device.

- **Disabled** HDA will be unconditionally disabled.
- **Enabled** HDA will be unconditionally enabled.

► Security

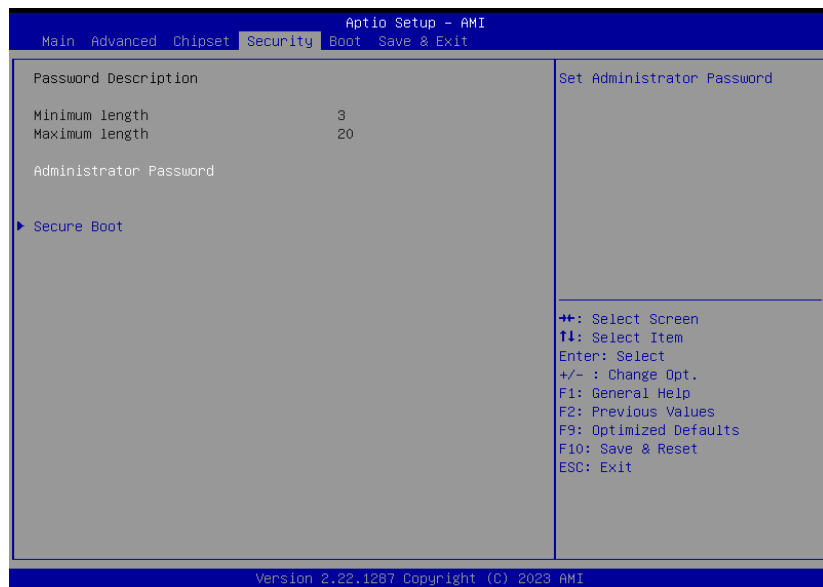
**Administrator Password**

Set the administrator password. To clear the password, input nothing and press enter when a new password is asked. Administrator Password will be required when entering the BIOS.

► Security

Secure Boot

**Secure Boot**

The Secure Boot store a database of certificates in the firmware and only allows the OSEs with authorized signatures to boot on the system. To activate Secure Boot, please make sure that "Secure Boot" is "[Enabled]", Platform Key (PK) is enrolled, "System Mode" is "User", and CSM is disabled. After enabling/disabling Secure Boot, please save the configuration and restart the system. When configured and activated correctly, the Secure Boot status will be "Active".

Secure Boot Mode

Select the secure boot mode – Standard or Custom. When set to Custom, the following fields will be configurable for the user to manually modify the key database.

Restore Factory Keys

Force system to User Mode. Load OEM-defined factory defaults of keys and databases onto the Secure Boot. Press Enter and a prompt will show up for you to confirm.

Reset To Setup Mode

Clear the database from the NVRAM, including all the keys and signatures installed in the Key Management menu. Press Enter and a prompt will show up for you to confirm.

Key Management

Enables expert users to modify Secure Boot Policy variables without full authentication.

► Boot

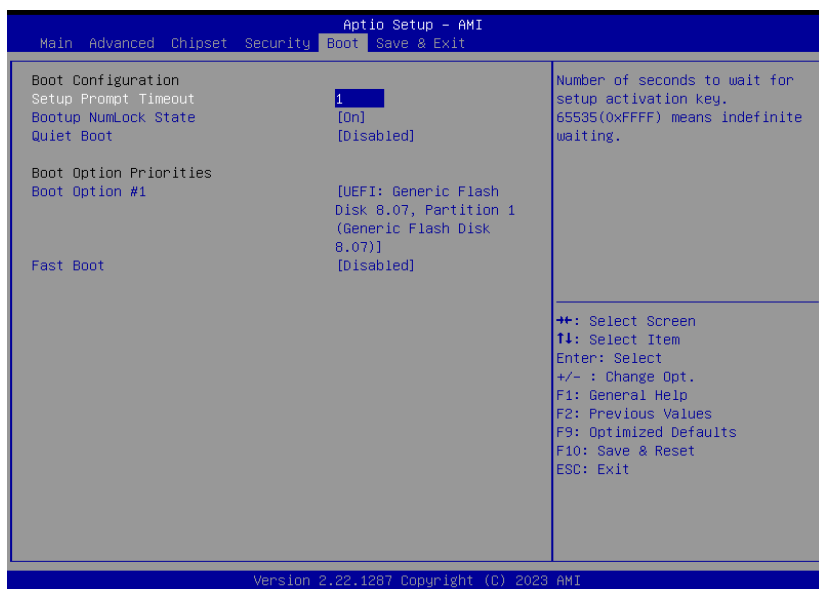

Setup Prompt Timeout

Set the number of seconds to wait for the setup activation key. 65535 (0xFFFF) denotes indefinite waiting.

Bootup NumLock State

Select the keyboard NumLock state: On or Off.

Quiet Boot

This section is used to enable or disable quiet boot option.

Boot Option Priorities

Rearrange the system boot order of available boot devices.

Fast Boot

Enable or disable fast boot.



Note:

If "Boot option filter" of "CSM Configuration" is set to "UEFI and Legacy" or "UEFI only", and "Quiet Boot" is set to enabled, "BGRT Logo" will show up for configuration. Refer to the Advanced > CSM Configuration submenu for more information.

► Save & Exit

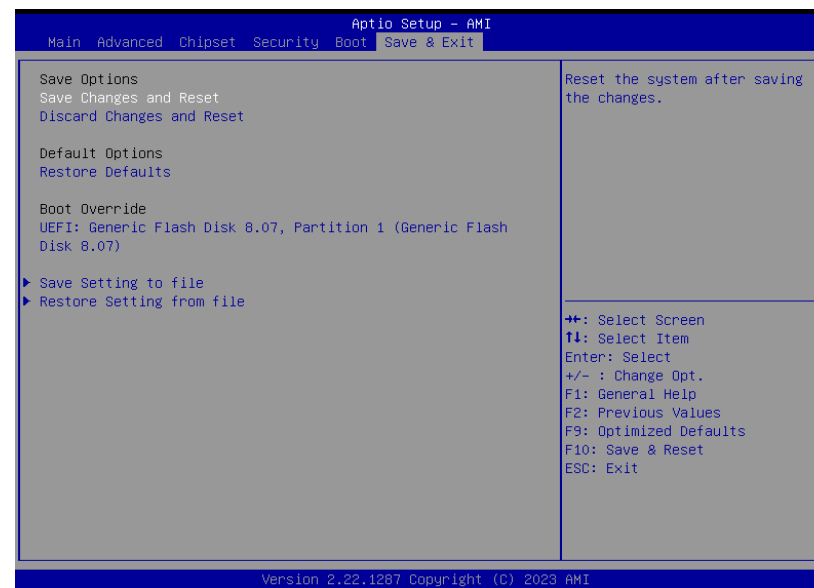

Save Changes and Reset

To save the changes, select this field and then press <Enter>. A dialog box will appear. Select Yes to reset the system after saving all changes made.

Discard Changes and Reset

To discard the changes, select this field and then press <Enter>. A dialog box will appear. Select Yes to reset the system setup without saving any changes.

Restore Defaults

To restore and load the optimized default values, select this field and then press <Enter>. A dialog box will appear. Select Yes to restore the default values of all the setup options.

Boot Override

Move the cursor to an available boot device and press Enter, and then the system will immediately boot from the selected boot device. The Boot Override function will only be effective for the current boot. The "Boot Option Priorities" configured in the Boot menu will not be changed.

- **Save Setting to file** Select this option to save BIOS configuration settings to a USB flash device.
- **Restore Setting from file** This field will appear only when a USB flash device is detected. Select this field to restore setting from the USB flash device.

► Updating the BIOS

To update the BIOS, you will need the new BIOS file and a flash utility. Please contact technical support or your sales representative for the files and specific instructions about how to update BIOS with the flash utility.

► Notice: BIOS SPI ROM

1. The Intel® Management Engine has already been integrated into this system board. Due to the safety concerns, the BIOS (SPI ROM) chip cannot be removed from this system board and used on another system board of the same model.
2. The BIOS (SPI ROM) on this system board must be the original equipment from the factory and cannot be used to replace one which has been utilized on other system boards.
3. If you do not follow the methods above, the Intel® Management Engine will not be updated and will cease to be effective.



Note:

- a. You can take advantage of flash tools to update the default configuration of the BIOS (SPI ROM) to the latest version anytime.
- b. When the BIOS IC needs to be replaced, you have to populate it properly onto the system board after the EEPROM programmer has been burned and follow the technical person's instructions to confirm that the MAC address should be burned or not.
- c. After updating unique MAC Address from manufacturing, NVM will be protected immediately after power cycle. Users cannot update NVM or MAC address.