



User Manual

IDS-3319 Series 19" Industrial Front IP65 Monitor 平板顯示器

申請商：研華股份有限公司
地址：臺北市內湖區瑞光路 26 巷 20 弄 1 號
電話：02- 2792 7818

ADVANTECH

Enabling an Intelligent Planet

Copyright

The documentation and the software included with this product are copyrighted 2020 by Advantech Co., Ltd. All rights are reserved. Advantech Co., Ltd. reserves the right to improve the products described in this manual at any time without notice. No part of this manual may be reproduced, copied, translated, or transmitted in any form, or by any means, without the prior written permission of Advantech Co., Ltd. The information provided in this manual is intended to be accurate and reliable. However, Advantech Co., Ltd. assumes no responsibility for its use, nor for any infringements of the rights of third parties that may result from its use.

Acknowledgements

Intel and Pentium are trademarks of Intel Corporation.

Microsoft Windows and MS-DOS are registered trademarks of Microsoft Corp.

All other product names or trademarks are properties of their respective owners.

Product Warranty (2 years)

Advantech warrants the original purchaser that all of its products will be free from defects in materials and workmanship for two years from the date of purchase.

This warranty does not apply to any products that have been repaired or altered by persons other than repair personnel authorized by Advantech, or products that have been subject to misuse, abuse, accident, or improper installation. Under the terms of this warranty, Advantech assumes no liability for the consequence of such events.

Because of Advantech's high quality-control standards and rigorous testing, most customers never need to use our repair service. If an Advantech product is defective, it will be repaired or replaced free of charge during the warranty period. For out-of-warranty repairs, customers will be billed according to the cost of the replacement materials, service time, and freight. Please consult your dealer for more details.

If you suspect that your product is defective, follow the steps outlined below.

1. Collect all the information about the problem encountered. (For example, CPU speed, Advantech products used, other hardware and software used, etc.) Note anything abnormal and list any onscreen messages displayed when the problem occurs.
2. Call your dealer and describe the problem. Please have your manual, product, and all relevant information readily available.
3. If your product is diagnosed as defective, obtain a return merchandise authorization (RMA) number from your dealer. This allows us to process your return more quickly.
4. Carefully pack the defective product, a completed Repair and Replacement Order Card, and a proof of purchase date (such as a photocopy of your sales receipt) in a shippable container. Products returned without a proof of purchase date are not eligible for warranty service.
5. Write the RMA number clearly on the outside of the package and ship it prepaid to your dealer.

Declaration of Conformity

CE

This product has passed the CE test for environmental specifications. Test conditions for passing included the equipment being operated within an industrial enclosure. In order to protect the product from damage due to electrostatic discharge (ESD) or electromagnetic interference (EMI) leakage, we strongly recommend the use of CE-compliant industrial enclosure products.

FCC Class A

This equipment has been tested and found to comply with the limits for a Class A digital device, pursuant to part 15 of the FCC Rules. These limits are designed to provide reasonable protection against harmful interference when the equipment is operated in a commercial environment. This equipment generates, uses, and can radiate radio frequency energy and, if not installed and used in accordance with the instruction manual, may cause harmful interference to radio communications. Operation of this equipment in a residential area is likely to cause harmful interference. In such cases, users are required to correct the interference at their own expense.

Technical Support and Assistance

1. Visit the Advantech website at <http://support.advantech.com> to obtain the latest product information.
2. Contact your distributor, sales representative, or Advantech's customer service center for technical support or additional assistance. Please have the following information ready before calling:
 - Product name and serial number
 - Description of your peripheral attachments
 - Description of your software (operating system, version, application software, etc.)
 - Comprehensive description of the problem
 - The exact wording of any error messages

Warnings, Cautions, and Notes

Warning! Warnings indicate conditions that if not observed can result in personal injury!



Caution! Cautions are included to prevent hardware damage or data losses.



New batteries are at risk of exploding if incorrectly installed. Do not attempt to recharge, force open, or heat the battery. Replace the battery only with the same or equivalent type recommended by the manufacturer. Discard used batteries according to the manufacturer's instructions.

Note! Notes provide additional optional information.



Document Feedback

To assist us in improving this manual, we welcome all comments and constructive criticism. Please send all feedback in writing to support@advantech.com

Safety Instructions

1. Read these safety instructions carefully.
2. Retain this user manual for future reference.
3. Disconnect this equipment from all AC outlets before cleaning. Use a damp cloth to clean the equipment. Do not use liquid or spray detergents.
4. For pluggable equipment, the power outlet socket should be located near the equipment and easily accessible.
5. Protect the equipment from humidity.
6. Place this equipment on a reliable surface during installation. Dropping or letting the equipment fall may cause damage.
7. The openings of the enclosure are for air convection. Prevent the equipment from overheating. Do not cover the openings.
8. Ensure that the voltage is correct before connecting the equipment to a power outlet.
9. Position the power cord away from high-traffic areas. Do not place anything over the power cord.
10. All cautions and warnings on the equipment should be noted.
11. If idle for a long duration, disconnect the equipment from the power source to avoid damage from transient overvoltage.
12. Never pour liquid into an opening. This may cause fire or electrical shock.
13. Never open the equipment. For safety reasons, the equipment should only be opened by qualified service personnel.
14. If one of the following occurs, have the equipment checked by service personnel:
 - The power cord or plug is damaged.
 - Liquid has penetrated into the equipment.
 - The equipment has been exposed to moisture.
 - The equipment is malfunctioning or does not function according to the user manual.
 - The equipment has been dropped or damaged.
 - The equipment shows obvious signs of breakage.
15. Do not store this equipment in an environment where the temperature fluctuates below $-20\text{ }^{\circ}\text{C}$ ($-4\text{ }^{\circ}\text{F}$) or above $60\text{ }^{\circ}\text{C}$ ($140\text{ }^{\circ}\text{F}$) because this could damage the equipment. The equipment should be stored in a controlled environment.
16. The sound pressure level at the operator's position does not exceed 70 dB (A) in accordance with IEC 704-1:1982.

DISCLAIMER: These instructions are provided according to IEC 704-1. Advantech disclaims all responsibility for the accuracy of any statements contained herein.

Caution! *Information regarding the adapter output rating (12 V_{DC}, 5 A/18 W min) is provided in the user manual to assist with adapter selection if a power adapter is not shipped with the unit.*



安全指示

1. 請仔細閱讀此安全操作說明。
2. 請妥善保存此用戶手冊供日後參考。
3. 用濕抹布清洗設備前，請確認拔除電源線。請勿使用液體或去污噴霧劑清洗設備。
4. 對於使用電源線的設備，設備周圍必須有容易接觸到的電源插座。
5. 請勿在潮濕環境中使用設備。
6. 請在安裝前確保設備放置在可靠的平面上，意外摔落可能會導致設備損壞。
7. 設備機殼的開孔適用於空氣對流，從而防止設備過熱。請勿覆蓋開孔。
8. 當您連接設備到電源插座前，請確認電源插座的電壓符合要求。
9. 請將電源線布置在人們不易絆倒的位置，請勿在電源線上覆蓋任何雜物。
10. 請注意設備上所有的警告標示。
11. 如果長時間不使用設備，請拔除與電源插座的連結，避免設備被超標的電壓波動損壞。
12. 請勿讓任何液體流入通風口，以免引起火災或短路。
13. 請勿自行打開設備。為了確保您的安全，請透過經認證的工程師來打開設備。
14. 如欲下列情況，請由專業人員維修：
 - 電源線或插頭損壞；
 - 設備內部有液體流入；
 - 設備曾暴露在過度潮濕環境中使用；
 - 設備無法正常工作，或您無法透過用戶手冊來正常工作；
 - 設備摔落或損壞；
 - 設備有明顯外觀損壞。
15. 請勿將設備放置在超出建議溫度範圍的環境，即不要低於 0° C (32° F) 或高於 40° C (104° F)，否則可能會造成設備損壞。
16. 注意：若電池更換不正確，將有爆炸危險。因此，只可以使用製造商推薦的同一種或者同等型號的電池進行替換。請按照製造商的指示處理舊電池。
17. 根據 IEC 704-1:1982 規定，操作員所在位置音量不可高於 70 分貝。
18. 限制區域：請勿將設備安裝於限制區域使用。
19. 免責聲明：該安全指示符合 IEC 704-1 要求。研華公司對其內容之準確性不承擔任何法律責任。
20. 使用過度恐傷害視力。
21. 未滿兩歲幼兒不看螢幕，兩歲以上每天看螢幕不要超過 1 小時。
22. 使用 30 分鐘請休息 10 分鐘。

警告使用者

這是甲類資訊產品，在居住的環境中使用時，可能會造成射頻干擾，在這種情況下，使用者會被要求採取某些適當的對策。

Contents

Chapter 1	Overview.....	1
1.1	Introduction	2
1.2	Features	2
1.3	Applications.....	2
1.4	Product Photos.....	2
1.5	Naming Rule	3
Chapter 2	System Setup.....	5
2.1	Specifications	6
2.2	Mechanical Outlook.....	7
2.3	I/O Interface	8
2.4	Rear Mount Assembly.....	8
2.5	Packing List.....	9
2.6	Ordering Information	9
Chapter 3	Touchscreen	11
3.1	OSD Functions.....	12
3.2	OSD Menu Details	13
3.2.1	Luminance	13
3.2.2	Image Setup.....	15
3.2.3	Color Temperature.....	17
3.2.4	OSD Setup.....	18
3.2.5	Extra.....	20
3.3	Touch Drivers.....	22
Appendix A	Troubleshooting	23
A.1	Introduction	24
A.2	Troubleshooting	24
A.3	BSMI RoHS.....	25

Chapter 1

Overview

- Introduction
- Features
- Applications
- Product Photos
- Naming Rule

1.1 Introduction

Advantech's IDS-3319 series is a brand new waterproof and dustproof industrial IP65 rated monitor, designed for different applications such as public signage, medical, point-of-sale and more.

1.2 Features

- 19" SXGA LED backlight panel which provides 20~30% power saving.
- -20°C ~ +60°C wide operating temperature range support.
- Front IP65 for waterproof and dustproof.
- Design with 5-wire resistive, P-cap touchscreen solution or tempered smudge resistant protected glass.
- Versatile mounting methods for rear mount and VESA mount (75 x 75 mm, 100 x 100 mm).

1.3 Applications

Application scenarios

- KIOSK / POI machine.
- Transportation machine.
- Ticketing machine.
- Financial ATM.
- Entertainment / gaming / slot machine.
- Human-Machine Interface equipment controller monitor.
- Public communication machine.
- Public advertisement machine.

1.4 Product Photos

Front View



1.5 Naming Rule

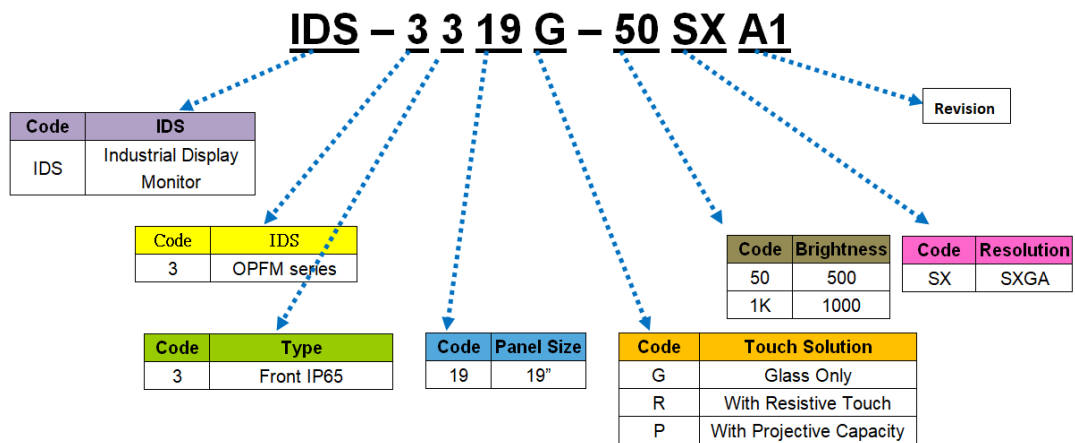

系列型號：

IDS-3319G-35SXA1

IDS-3319P-35SXA1

IDS-3319R-35SXA1

Chapter 2

System Setup

- Specifications
- Dimensions
- Rear Mount Assembly
- Cable Clamp
- Packing List

2.1 Specifications

Note! The IDS-3319 offers the following features.



Unless otherwise indicated, all the specifications listed below are subject to change without prior notification.

Display	Model	IDS-3319
	Size	19" LED panel
	Resolution	1280 x 1024 (SXGA)
	Viewing Angle	85°/80° (H), 80°/80° (V)
	Brightness	350 (cd/m ²)
	Color Support	16.7M
	Contrast Ratio	1000:1
	Response Time	10 [msec]
	Backlight Life (hrs)	70,000 hrs
Touchscreen	Touchscreen Type	5-Wire Resistive Touchscreen / Projected Capacitive Touchscreen
	Surface Hardness	3H / 6H
	Durability	10 million touches / -
	Transparency	80% / 86 ± 3%
Environment	Operating Temperature	-20 ~ 60° C (-4 ~ 140° F)
	Storage Temperature	-30 ~ 70° C (-22 ~ 158° F)
	Humidity	5 ~ 95% @ 40° C, non-condensing
	Vibration	5-500 Hz, 0.026G ² /Hz, 2.16Grms, X, Y, Z 1 hour per axis
System	I/O	VGA x 1, DVI x 1, HDMI x 1, 12V DC Jack x 1, USB x 1, RS232 x 1 (RS232 and USB are reserved for the connection to enable touch usage only)
	OSD	Keys: Power on/off, Menu/Enter, Left/Up, Right/Down, Exit/Auto, Source Menu Functions: Brightness, Contrast, Screen Setting, Color Temp, OSD Language, Reset, Auto Adjust
	Power	60 W power adapter, with AC 100 ~ 240 V input and DC +12 V @ 5 A output
	EMC Compliance	CE/FCC/CCC/BSMI

2.2 Mechanical Outlook

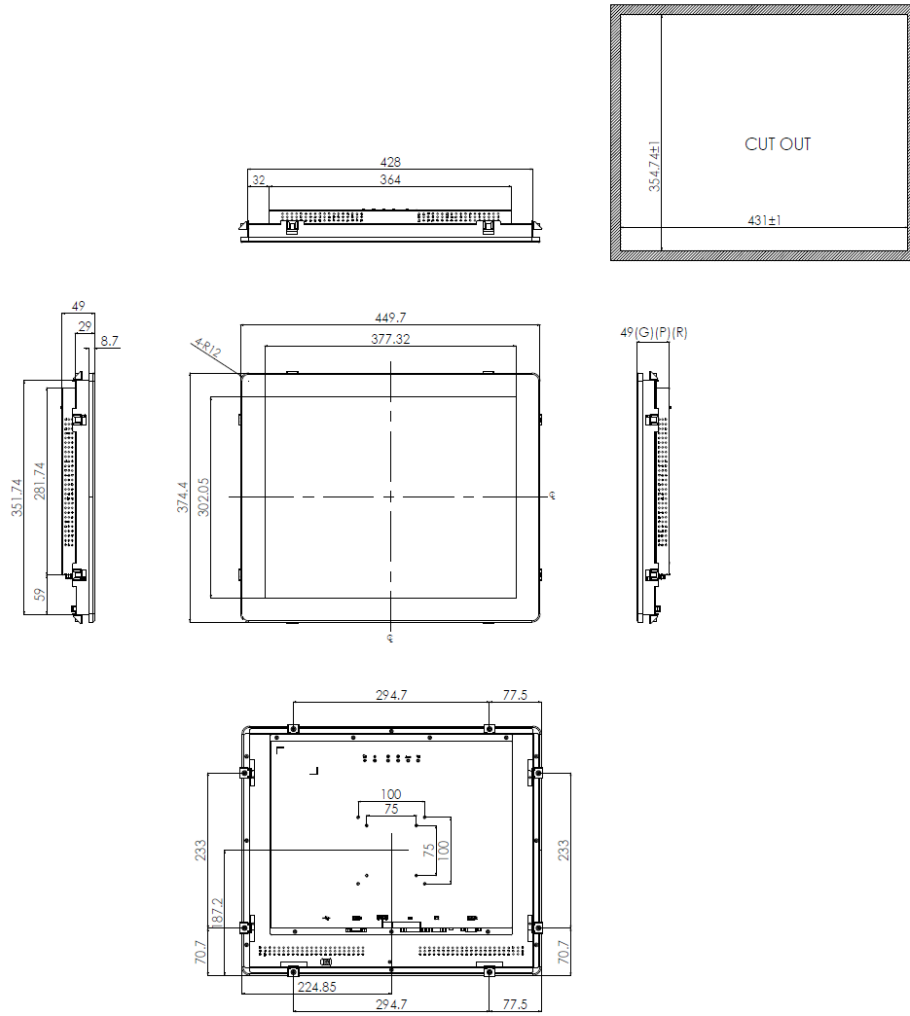

2.3 I/O Interface

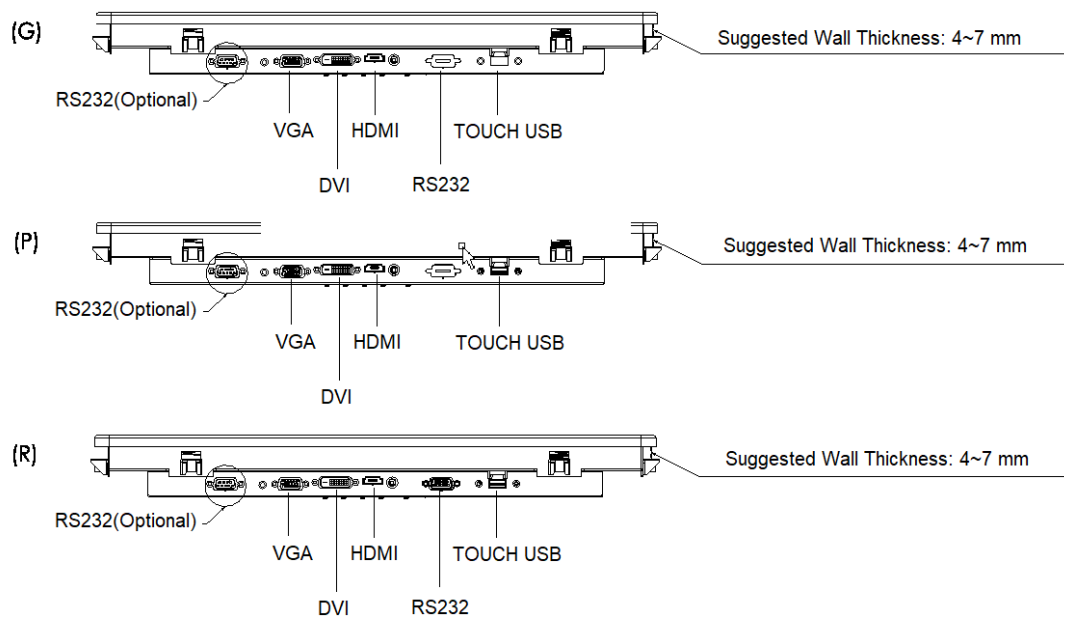

2.4 Rear Mount Assembly

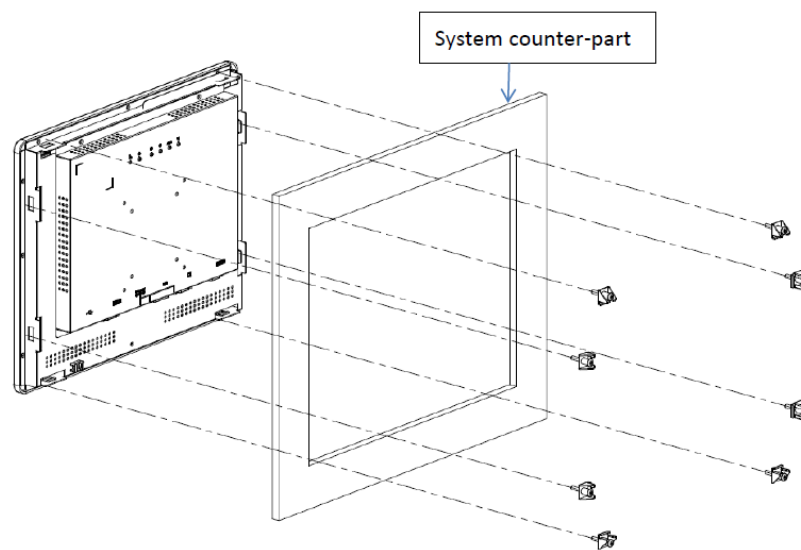

Note! Suggested screws - M4x10L



2.5 Packing List

- 1 x VGA cable 15P(M) 1.8 meter
- 1 x USB-A(M)/USB-A(M) 1.8 meter (for SKU with touch screen)
- 8 x Panel-mount clamps
- 8 x Panel-mount clamber screws: M4_25L
- 1 x Cable clamp
- 1 x Cable clamp screw
- 1 x Cable tie
- 1 x 60 W DC12V Power Adapter (optional order)
- 1 x Power Cord (optional order)
- 1 x DVI cable 2.0 meter (optional order)
- 1 x RS232 9P/9P 1.8M M/F cable (optional order)

Note! The accessory cables listed above may differ according to SKU.



2.6 Ordering Information

Model Name	Description
IDS-3319G-35SXA1	19" SXGA 350 cd/m2 Front IP65 Monitor with Protected Glass
IDS-3319R-35SXA1	19" SXGA 350 cd/m2 Front IP65 Monitor with Res. Touch
IDS-3319P-35SXA1	19" SXGA 350 cd/m2 Front IP65 Monitor with P-Cap Touch

Chapter 3

Touchscreen

- OSD Functions
- Touch Drivers

3.1 OSD Functions

IDS-3319 is equipped with 1280 x 1024 display resolution and the following OSD features:

Buttons	Description
Power	Turn the monitor power ON or OFF
Menu	Activate the OSD menu Select
Auto/Exit	Automatically adjust the clock, phase H-position and V-position
Value Up/Down	Move the selector to the previous option Reduce the value of the selected option

LED Function

DPMS ON	Green
DPMS STANDBY	Orange
DPMS OFF	Red

Hot Key	Function
Value Down	ECO mode

3.2 OSD Menu Details

3.2.1 Luminance

Contrast

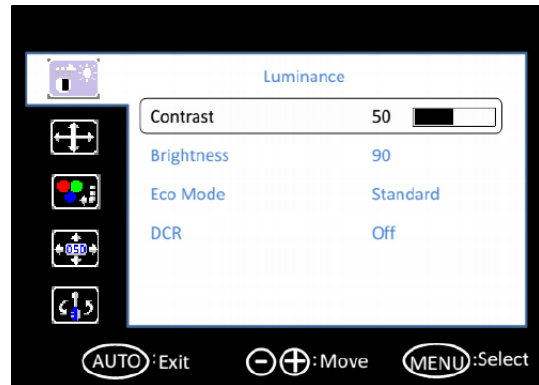
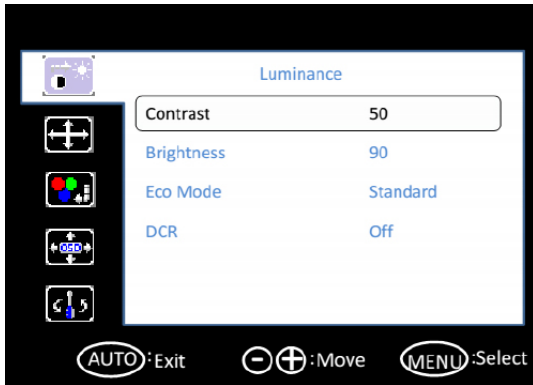

Brightness

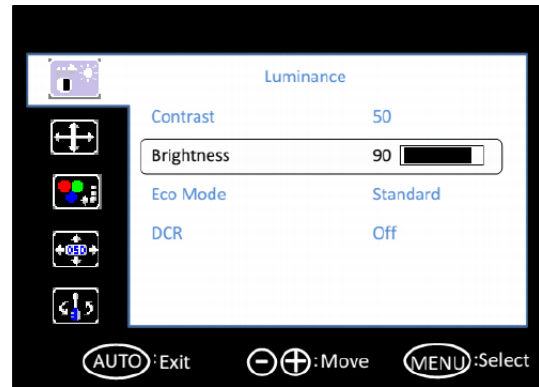
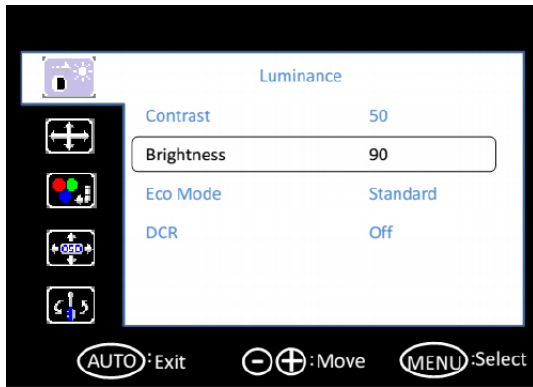

Eco Mode

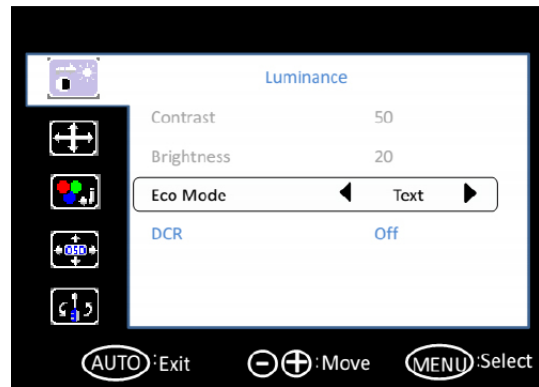
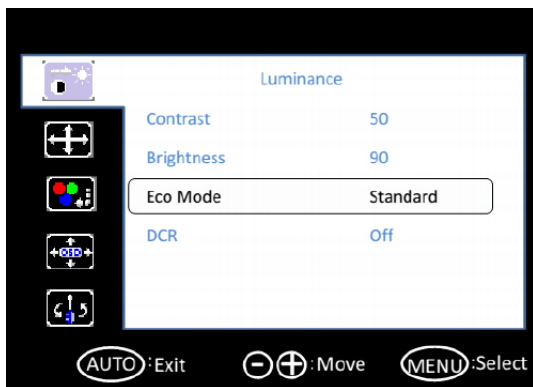

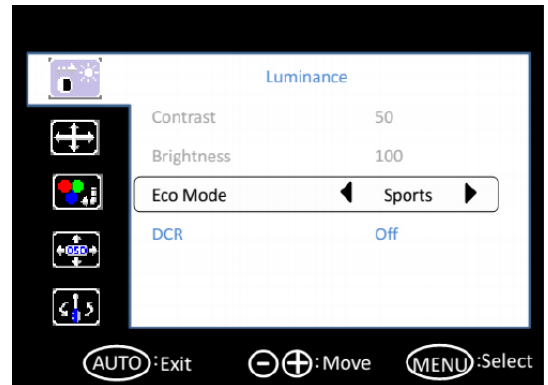
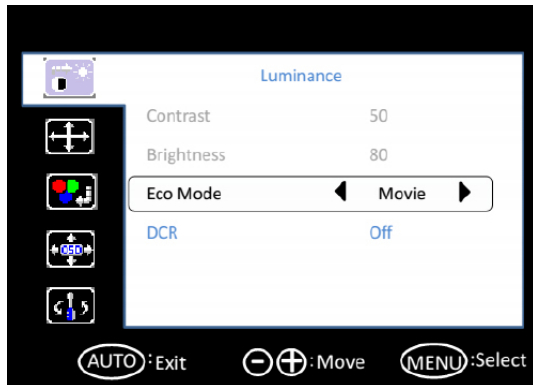
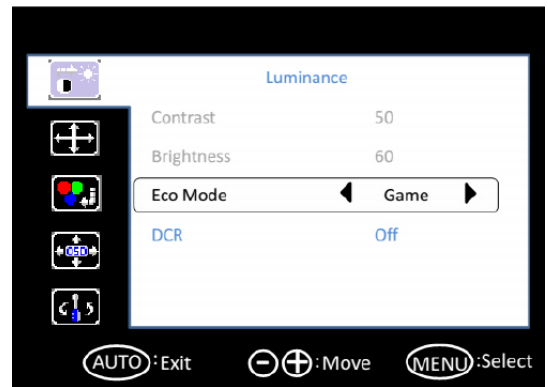
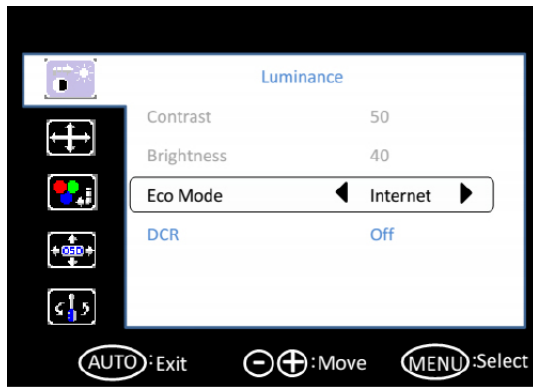

DCR

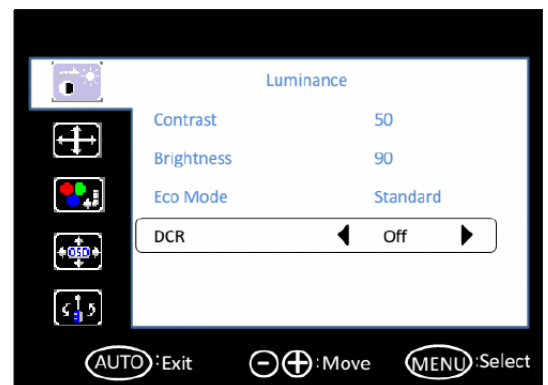
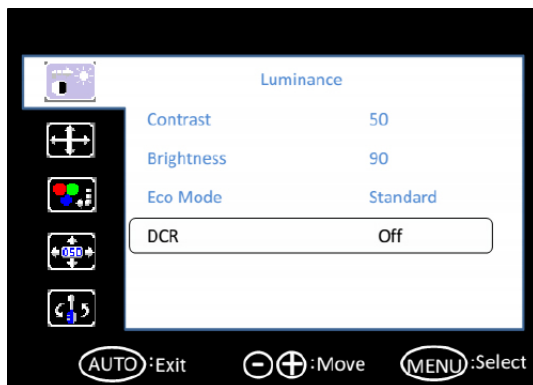

3.2.2 Image Setup

Clock

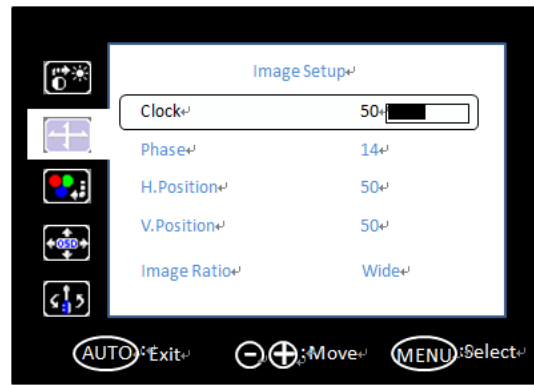
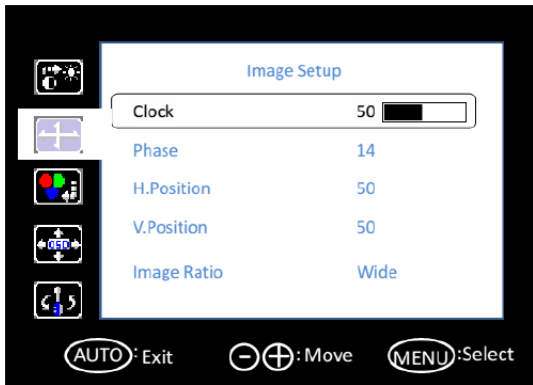

Phase

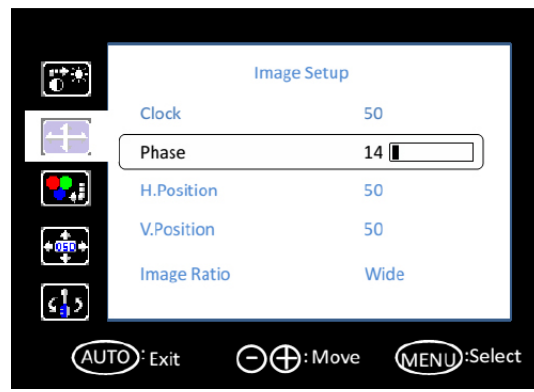
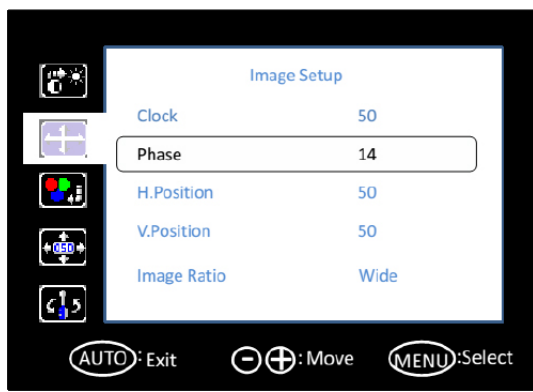

H. Position

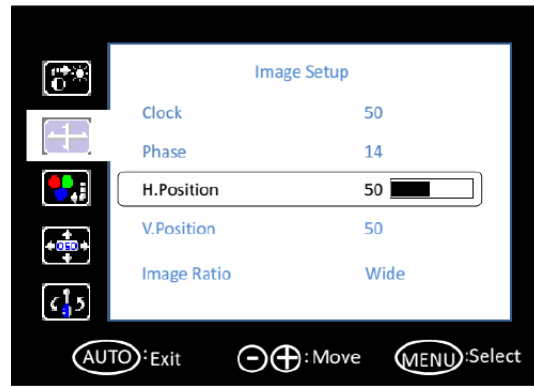
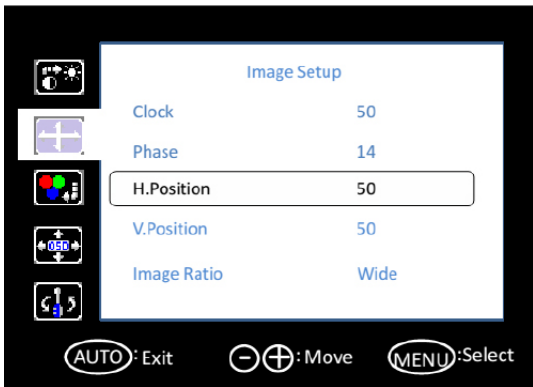

V. Position

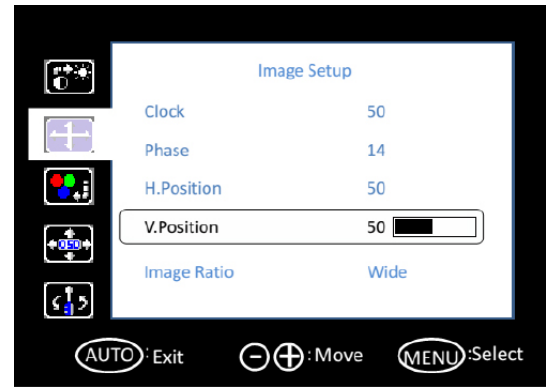
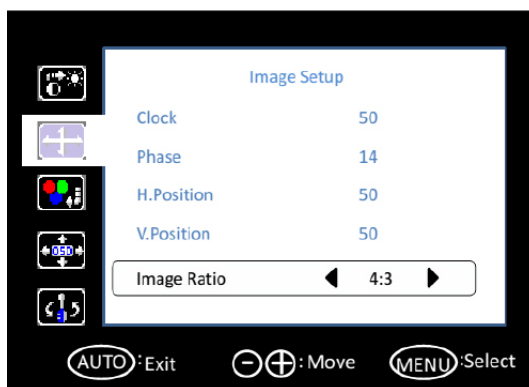
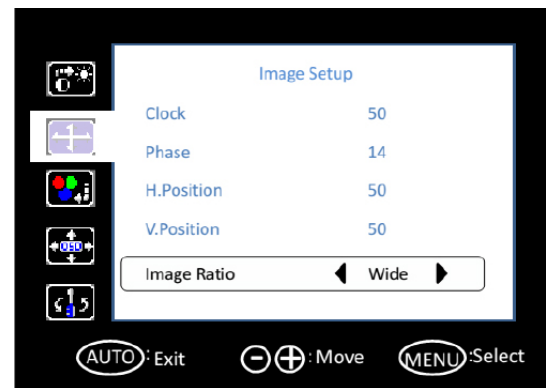
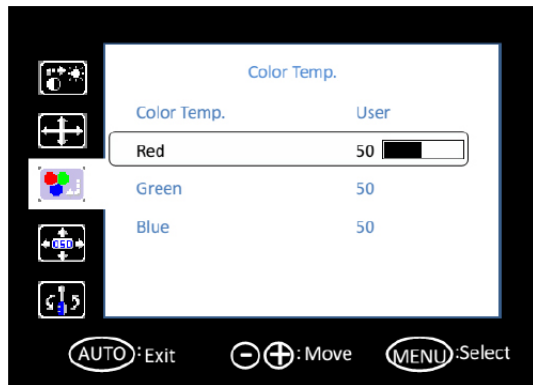
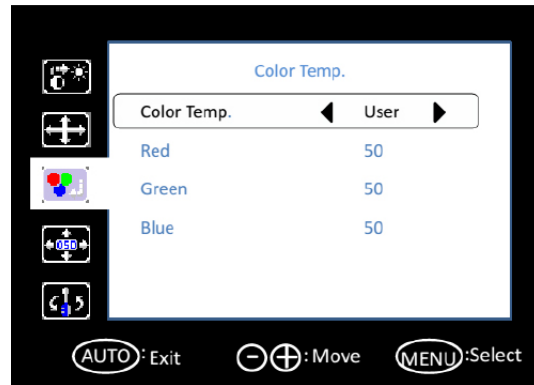
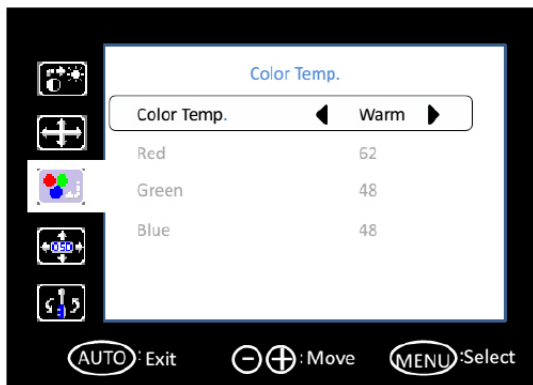
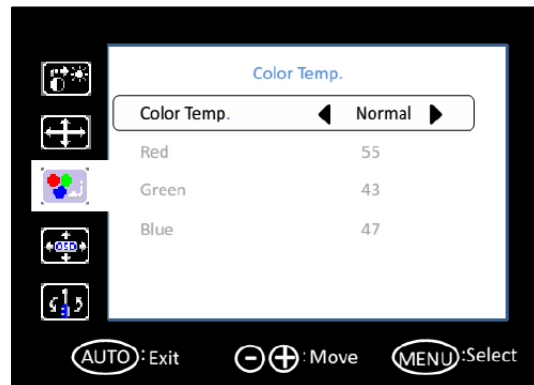
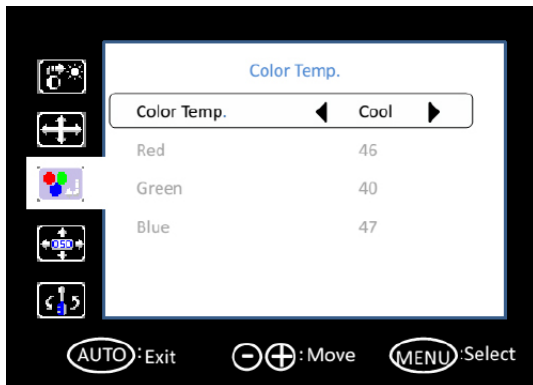

Image Ratio



3.2.3 Color Temperature

Color Temperature



3.2.4 OSD Setup

H. Position

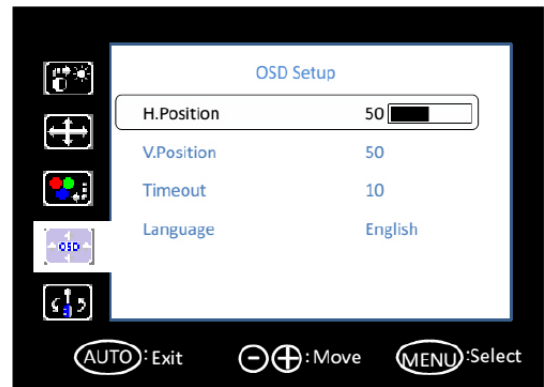
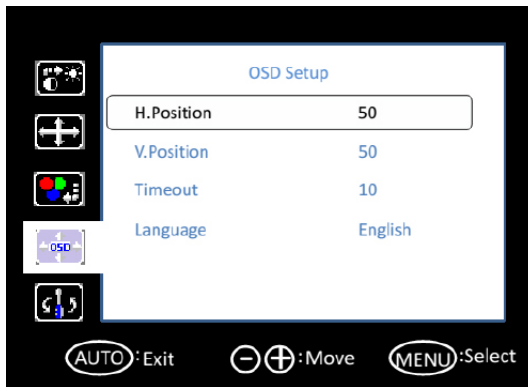

V. Position

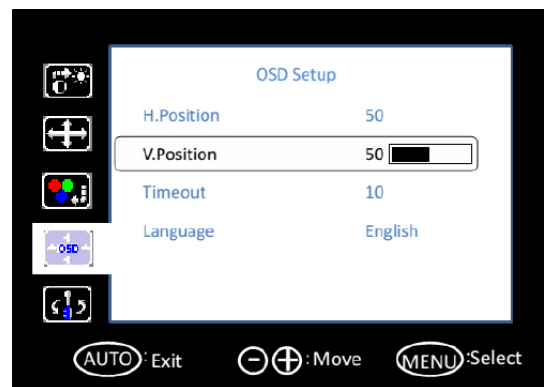
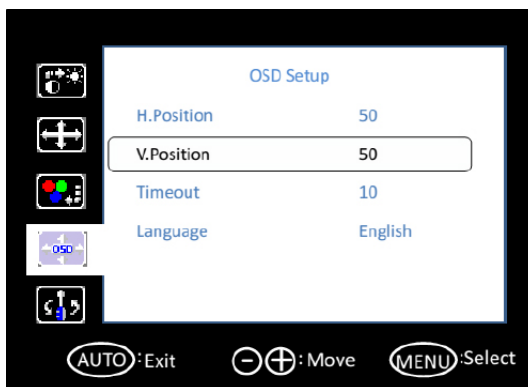

Timeout

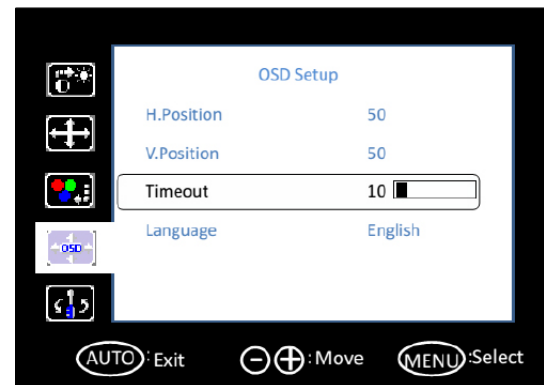
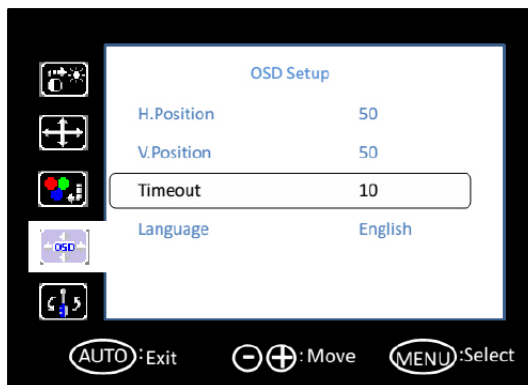

Language



3.2.5 Extra

Input Select

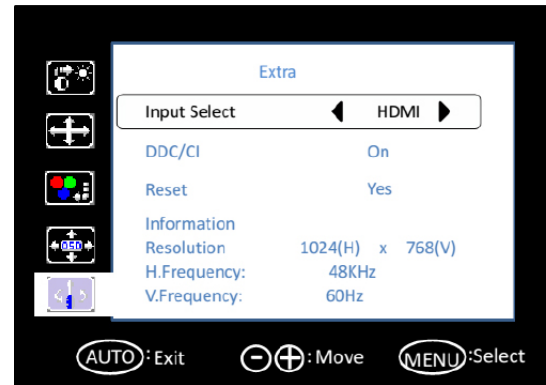
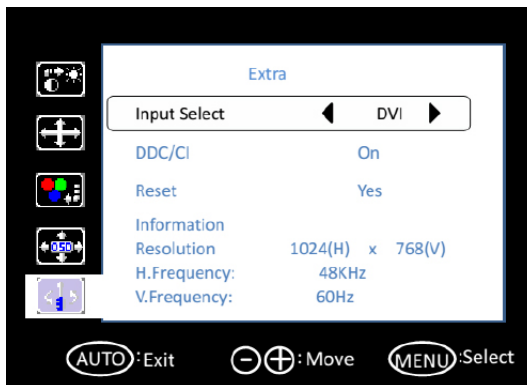
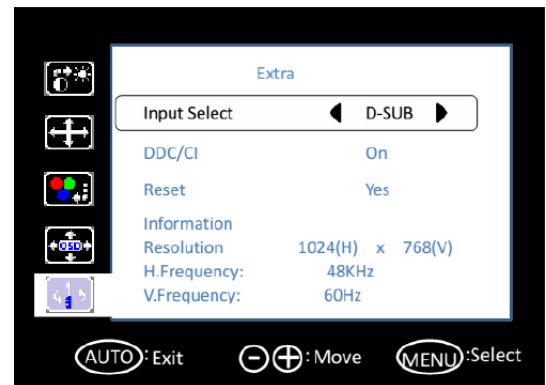
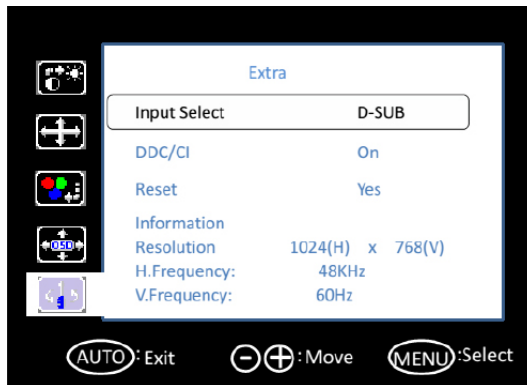

DDC/CI

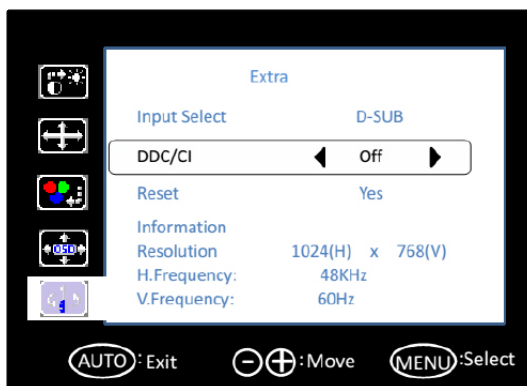
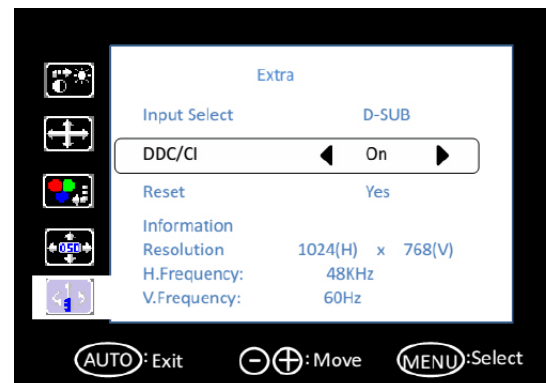
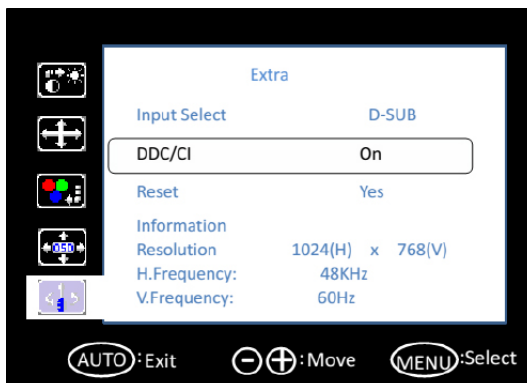

Reset

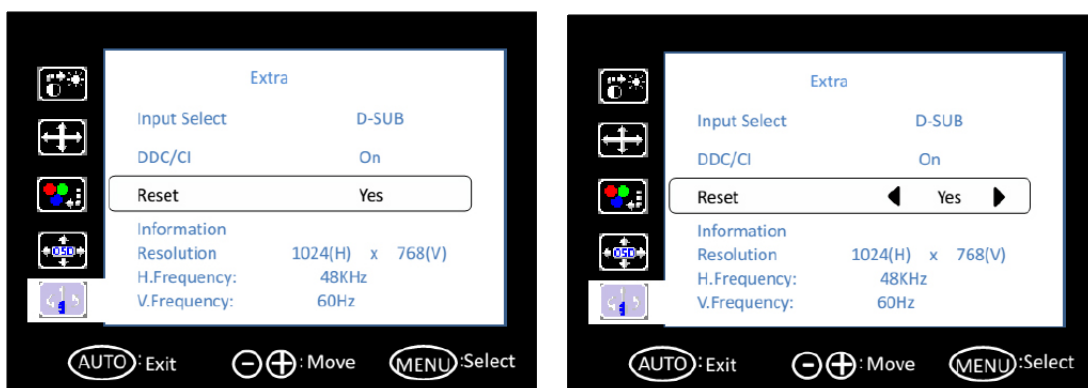

Layer 1	Layer 2	Layer 3	Comment	Default Value
	Contrast	0 100	Adjusts contrast	50
	Brightness	0 100	Adjusts brightness (backlight)	90
Luminance	ECO Mode	Standard		
		Sport		
		Movie		
		Game		Standard
		Internet		
	DCR	On Off	Sets dynamic contrast ratio	Off
Image setup	Clock	0 100	Adjusts clock latency of output capture window	Depends on the input resolution
	Phase	0 100	Adjusts clock phase of output capture window	Depends on the input resolution
	H. Position	0 100	Adjusts horizontal position of output capture window	50
	V. Position	0 100	Adjusts vertical position of output capture window	50
	Image Ratio	Wide 4:3	Adjusts aspect ratio to full screen Adjusts aspect ratio to 4:3 screen	Wide
Color Temperature	Color Temp.	Warm -->	Adjusts color temperature to warm	
		Normal -->	Adjusts color temperature to normal	User
		Cool -->	Adjusts color temperature to cool	
		User -->	Adjusts color temperature to user defined	

	H. Position	0 100	Adjusts OSD horizontal position	50
	V. Position	0 100	Adjusts OSD vertical position	50
	Timeout	5 100	Sets OSD timeout counter	10
OSD Setup	Language	English	Sets OSD display language	English
		Spanish		
		French		
		Portuguese		
		Russian		
		简体中文		
		繁體中文		
		Korean		
Extra	Input Select	D-Sub	Sets input source	Depends on the input source
		HDMI		
		DVI		
	DDC/CI	On	Sets DDC/CI function on/off	On
		Off		
Reset	Yes	Sets user setting reset	On	
	No			
Information	Resolution	Display current source information	Depends on the input source	
	H. Frequency			
	V. Frequency			

3.3 Touch Drivers

The touchscreen driver is available online at the Advantech website. Use the following link to access the driver: <http://support.advantech.com/support/default.aspx>

Appendix **A**

Troubleshooting

A.1 Introduction

If the monitor is malfunctioning or does not operate according to the user manual, refer to the following instructions before calling the Advantech service center.

If you are unable to correct the faults using the instructions provided below, please contact your distributor or the Advantech service center.

A.2 Troubleshooting

The image is displayed incorrectly/the full screen image does not appear

- Ensure that the screen resolution on the motherboard is correct.

The screen image is not centered

- Adjust the horizontal and vertical position of the OSD or select the “Auto” option for automatic adjustment.

Out of range

- If an “Out of Range” message appears onscreen, this indicates that the display output signal is not compatible with the LCD display (for example, the output resolution exceeds the LCD display resolution).
- Adjust the BIOS settings to match the correct resolution.

No signal

- The display is powered on but is not receiving or displaying output signals from the computer. Check all power switches, power cables, and VGA signal cables and ensure that both ends of all cables are properly connected.

Going to sleep

- If the system goes to sleep, either the display has been set to power-saving mode or is experiencing a sudden signal disconnection problem. Check the BIOS system settings and/or Windows configuration. Then check both ends of the power cable connected to the computer.

A.3 BSMI RoHS

設備名稱: Equipment name	型號 (型式): IDS-3319G-35SXA1, IDS-3319P-35SXA1, IDS-3319R-35SXA1 Type designation (Type)					
單元 Unit	限用物質及其化學符號 Restricted substances and its chemical symbols					
	鉛 Lead (Pb)	汞 Mercury (Hg)	鎘 Cadmium (Cd)	六價鉻 Hexavalent chromium (Cr+6)	多溴聯苯 Polybrominated biphenyls (PBB)	多溴二苯醚 Polybrominated diphenyl ethers (PBDE)
電路板	—	○	○	○	○	○
內外殼 (外殼、內部框架等)	○	○	○	○	○	○
其它固定組件 (螺絲, 夾具、卡榫)	—	○	○	○	○	○
線材	○	○	○	○	○	○
面板	—	○	○	○	○	○
觸碰模組	—	○	○	○	○	○
<p>備考 1. “超出 0.1 wt %” 及 “超出 0.01 wt %” 係指限用物質之百分比含量超出百分比含量基準值。 Note 1: “Exceeding 0.1 wt %” and “exceeding 0.01 wt %” indicate that the percentage content of the restricted substance exceeds the reference percentage value of presence condition.</p> <p>備考 2. “○” 係指該項限用物質之百分比含量未超出百分比含量基準值。 Note 2: “○” indicates that the percentage content of the restricted substance does not exceed the percentage of reference value of presence.</p> <p>備考 3. “—” 係指該項限用物質為排除項目。 Note 3: The “—” indicates that the restricted substance corresponds to the exemption.</p>						

ADVANTECH

Enabling an Intelligent Planet

www.advantech.com

Please verify specifications before quoting. This guide is intended for reference purposes only.

All product specifications are subject to change without notice.

No part of this publication may be reproduced in any form or by any means, such as electronically, by photocopying, recording, or otherwise, without prior written permission from the publisher.

All brand and product names are trademarks or registered trademarks of their respective companies.

© Advantech Co., Ltd. 2021