

**QBiX-RPLA1355H-A1/  
QBiX-RPLA1335H-A1/  
QBiX-RPLA1315EH-A1**

---

QBiX Industrial Embedded System  
Quick Start Guide

## Copyright Notice

---

This document is copyrighted, 2024. All rights are reserved. The original manufacturer reserves the right to make improvements to the products described in this manual at any time without notice.

No part of this manual may be reproduced, copied, translated, or transmitted in any form or by any means without the prior written permission of the original manufacturer. Information provided in this manual is intended to be accurate and reliable. However, the original manufacturer assumes no responsibility for its use, or for any infringements upon the rights of third parties that may result from its use.

The material in this document is for product information only and is subject to change without notice. While reasonable efforts have been made in the preparation of this document to assure its accuracy, GIGAIPC assumes no liabilities resulting from errors or omissions in this document, or from the use of the information contained herein.

GIGAIPC reserves the right to make changes in the product design without notice to its users.

## Acknowledgement

---

All other products' name or trademarks are properties of their respective owners.

- Microsoft Windows is a registered trademark of Microsoft Corp.
- Intel, Pentium, Celeron, and Xeon are registered trademarks of Intel Corporation
- Core, Atom are trademarks of Intel Corporation
- ITE is a trademark of Integrated Technology Express, Inc.
- IBM, PC/AT, PS/2, and VGA are trademarks of International Business Machines Corporation.

All other product names or trademarks are properties of their respective owners.

# Packing List

---

Before setting up your product, please make sure the following items have been shipped:

Item	Quantity
System kit	1
19.5V/ 135W adapter	1
Power cord (May vary based on local distribution)	1
Wall Mount Bracket	2
HDD screw, M3 x 8L	4
Thermal pad for DRAM2	1

If any of these items are missing or damaged, please contact your distributor or sales representative immediately.

## About this Document

---

This User's Manual contains all the essential information, such as detailed descriptions and explanations on the product's hardware and software features (if any), its specifications, dimensions, jumper/connector settings/definitions, and driver installation instructions (if any), to facilitate users in setting up their product.

Users may refer to the [GIGAIPC.com](http://GIGAIPC.com) for the latest version of this document.

## Safety Precautions

---

Please read the following safety instructions carefully. It is advised that you keep this manual for future references

1. All cautions and warnings on the device should be noted.
2. Make sure the power source matches the power rating of the device.
3. Position the power cord so that people cannot step on it. Do not place anything over the power cord.
4. Always completely disconnect the power before working on the system's hardware.
5. No connections should be made when the system is powered as a sudden rush of power may damage sensitive electronic components.
6. If the device is not to be used for a long time, disconnect it from the power supply to avoid damage by transient over-voltage.
7. Always disconnect this device from any AC supply before cleaning.
8. While cleaning, use a damp cloth instead of liquid or spray detergents.
9. Make sure the device is installed near a power outlet and is easily accessible.
10. Keep this device away from humidity.
11. Place the device on a solid surface during installation to prevent falls
12. Do not cover the openings on the device to ensure optimal heat dissipation.

13. Watch out for high temperatures when the system is running.
14. Do not touch the heat sink or heat spreader when the system is running
15. Never pour any liquid into the openings. This could cause fire or electric shock.
16. As most electronic components are sensitive to static electrical charge, be sure to ground yourself to prevent static charge when installing the internal components. Use a grounding wrist strap and contain all electronic components in any static-shielded containers.
17. If any of the following situations arises, please the contact our service personnel:
  - i. Damaged power cord or plug
  - ii. Liquid intrusion to the device
  - iii. Exposure to moisture
  - iv. Device is not working as expected or in a manner as described in this manual
  - v. The device is dropped or damaged
  - vi. Any obvious signs of damage displayed on the device
18. This product requires connection to protective earth by means of powercord(s) connected to socket-outlet(s) with protective earthing connection .

**19. DO NOT LEAVE THIS DEVICE IN AN UNCONTROLLED ENVIRONMENT WITH TEMPERATURES BEYOND THE DEVICE'S PERMITTED STORAGE TEMPERATURES (SEE CHAPTER 1) TO PREVENT DAMAGE.**

## FCC Statement

---

### **Warning!**



This device complies with Part 15 FCC Rules. Operation is subject to the following two conditions: (1) this device may not cause harmful interference, and (2) this device must accept any interference received including interference that may cause undesired operation.

### **Caution:**

*There is a danger of explosion if the battery is incorrectly replaced. Replace only with the same or equivalent type recommended by the manufacturer. Dispose of used batteries according to the manufacturer's instructions and your local government's recycling or disposal directives.*

### **Attention:**

*Il y a un risque d'explosion si la batterie est remplacée de façon incorrecte. Ne la remplacer qu'avec le même modèle ou équivalent recommandé par le constructeur. Recycler les batteries usées en accord avec les instructions du fabricant et les directives gouvernementales de recyclage.*

## High Temperature Warning

---

(1) This equipment is intended to be used in Restrict Access Location. The access can only be gained by Skilled person or by Instructed person who have been instructed about the metal chassis of the equipment is so hot that Skilled person have to pay special attention or take special protection. Only authorized by well trained professional person can access the restrict access location.

(2) External metal parts are hot!! Before touching it, special attention or protection is necessary





## Table Contents

<b>QBiX Industrial Embedded System</b>	<b>1</b>
<b>Quick Start Guide</b>	<b>1</b>
Copyright Notice .....	2
Acknowledgement .....	3
Packing List.....	4
About this Document .....	5
Safety Precautions .....	6
FCC Statement.....	8
High Temperature Warning .....	8
<b>Chapter 1 - Product Specifications</b>	<b>12</b>
1.1 Specifications .....	14
<b>Chapter 2 – QBiX Industrial Embedded System Kit</b>	<b>16</b>
2.1 Dimension .....	17
2.2 Getting Familiar with Your Unit.....	18
2.3 A) M.2 SSD Installation: How to safely install the M.2 2280 SSD .....	20
2.4 B) Wireless Module : How to safely install the Module (Wireless Module inclusion may vary based on local distribution) .....	21
2.5 C) Memory Installation: DDR5 SO-DIMM .....	22
2.6 D) 2.5” HDD/SSD installation: How to install 2.5” HDD/ SSD .....	23
2.7 Antenna Installation (Antenna inclusion may vary based on local distribution) .....	24

2.8	Wall mount bracket Installation.....	25
2.9	RAL .....	26
2.10	Support .....	27
2.11	Safety and Regulatory Information.....	28

## Chapter 3 – Hardware Information 29

3.1	Jumpers and Connectors .....	30
3.2.1	ATX_IN (ATX IN Connector) .....	33
3.2.2	SATA (SATA 6Gb/s connector) .....	34
3.2.3	SATA_PWR (SATA power connector) .....	35
3.2.4	M2E (M.2 Slot, 2230 E-key).....	36
3.2.5	M2M (M.2 Slot, 2280 M-Key) .....	37
3.2.6	BATTERY (Battery connector) .....	38
3.2.7	FUSB (USB 2.0 header) .....	39
3.2.8	F_PANEL (Front panel Connector).....	40
3.2.9	SODIMM1, SODIMM2 (DDR5 SO-DIMM Slot).....	41
3.2.10	ME_DIS (ME Disable jumper).....	42
3.2.11	CPU FAN (CPU FAN connector) .....	43
3.2.12	COM1 (Serial port connector, RS-232/422/485).....	44
3.2.13	USB3CM (USB Type C Port) .....	45
3.2.14	HP_MIC (Combo audio jack (Headphone & Headset))..	46
3.2.15	USB32_2 (USB 3.2 Gen 2x1 Port).....	47
3.2.16	PWR_BT (Power button with LED).....	48
3.2.17	DC_IN (Screw type DC Jack connector) .....	49
3.2.18	LAN1 (2.5GbE LAN port connector).....	50
3.2.19	LAN2 (1GbE LAN port connector).....	51

3.2.20	USB32_1 (USB 3.2 Gen 2x1 connector) .....	52
3.2.21	HDMI2_21 (HDMI connector) .....	53

## **Chapter 4 – BIOS 54**

4.1	Introduction .....	55
4.2	The Main Menu.....	56
4.3	Advanced .....	57
4.3.1	TPM Configuration.....	58
4.3.2	CPU Configuration .....	60
4.3.3	SATA Configuration .....	61
4.3.4	Super IO Configuration .....	62
4.3.5	Hardware Monitor .....	63
4.3.6	S5 RTC Wake Settings .....	64
4.3.7	Network Stack Configuration.....	65
4.3.8	NVMe Configuration .....	66
4.3.9	Offboard SATA Controller Configuration .....	67
4.3.10	Tls Auth Configuration .....	68
4.3.11	Intel(R) Ethernet Controller I226-V - 10:FF:E0:34:83:E0 (MAC address may varied based on different mother- board).....	69
4.3.12	Realtek PCIe GBE Family Controller(MAC:10:FF:E0: 34:83:E1) (MAC address may varied based on different motherboard).....	70
4.4	Chipset .....	71
4.5	Security .....	72
4.6	Boot.....	75
4.7	Save & Exit .....	76

# Chapter 1

---

## Chapter 1 - Product Specifications

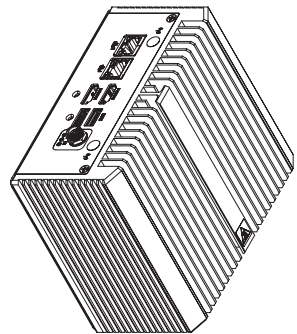
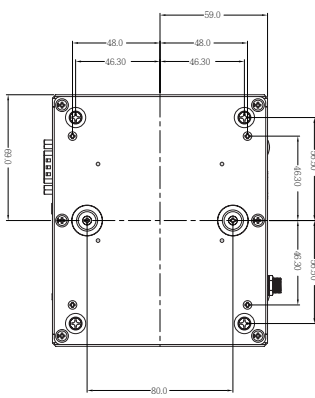
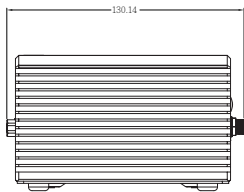
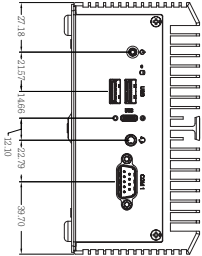
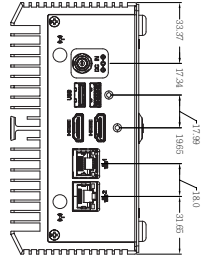
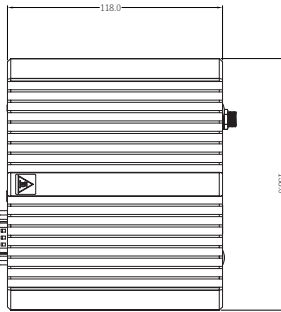
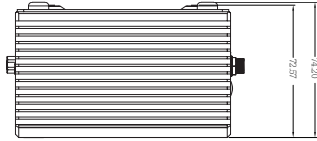

## 1.1 Specifications

	QBiX- RPLA1355H-A1 (QB-1355A)	QBiX- RPLA1335H-A1 (QB-1335A)	QBiX- RPLA1315EH-A1 (QB-1315A)
Dimension	System Size : 138W x 118D x 74.2H (mm)		
CPU	Intel® Core™ i7-1355U Processor Intel® 7, 10 cores, 2P+8E, 12 threads, up to 5.0 GHz	Intel® Core™ i5-1335U Processor Intel® 7, 10 cores, 2P+8E, 12 threads, up to 4.6 GHz	Intel® Core™ i3-1315UE Processor Intel® 7, 6 cores, 2P+4E, 8 threads, up to 4.5 GHz
Chipset	SoC		
Memory	2 x DDR5 SO-DIMM sockets, Max. Capacity 64 GB Support Dual Channel DDR5 5200 MHz memory modules		
Ethernet	1 x 2.5 GbE LAN Port (Intel® I226V) 1 x GbE LAN Port (Realtek® RTL8111H)		
Graphics support	Integrated Graphics Processor - Intel® Iris® Xe Graphics eligible: 2 x HDMI 2.0 ports, supporting a maximum resolution of 4096x2160 @60Hz 1 x DP 1.4 through USB Type C (DP Alt. mode), supporting a maximum resolution of 7680x4320 @30Hz, requires designated graphic driver  (3 independent display outputs)		Integrated Graphics Processor - Intel® UHD Graphics for 13th Gen. Intel® Processors: 2 x HDMI 2.0 ports, supporting a maximum resolution of 4096x2160 @60Hz 1 x DP 1.4 through USB Type C (DP Alt. mode), supporting a maximum resolution of 7680x4320 @30Hz, requires designated graphic driver  (3 independent display outputs)
Audio	Realtek® ALC269		
Storage	1 x 2.5" HDD/SSD (SATA 6Gb/s)		

	QBiX- RPLA1355H-A1 (QB-1355A)	QBiX- RPLA1335H-A1 (QB-1335A)	QBiX- RPLA1315EH-A1 (QB-1315A)
Expansion Slots	1 x 2280 M.2 M-Key (PCIe Gen 4x4, SATA 6Gb/s) 1 x 2230 M.2 E-Key (PCIe x1, USB 2.0)		
Front I/O	2 x USB 3.2 Gen 2x1 1 x USB 3.2 type C with DP 1.4b (DP Alt. mode) 1 x Power button with LED 1 x HDD LED 1 x COM Port (RS-232/422/485) 1 x Combo Audio Jack (Headphone & Headset)		
Rear I/O	2 x HDMI 2 x RJ45 LAN Ports 2 x External Antenna Holes (Optional) 2 x USB 3.2 Gen 2x1 1 x Screw type DC Jack		
TPM	Onboard TPM 2.0 security chip INFINEON SLB9672VU2.0		
Power	+12V~24VDC (Adapter 19.5V/135W)		
Operation temperature	Operating temperature: 0°C to 50°C Operating humidity: 0-90% (non-condensing) Non-operating temperature:-40°C to 85°C Non-operating humidity: 0%-95% (non-condensing) Use wide temperature range memory and storage		
Vibration During Operation	Operation: IEC 60068-2-64, 3 Grms, random, 5 ~ 500 Hz, 1 hr / Per Axis, With SSD Non-operation: IEC 60068-2-6, 2 G, Sine, 10 ~ 500 Hz, 1 Oct/min, 1 hr / Per Axis		
Shock During Operation	Operation: IEC 60068-2-27, 50 G, half sine, 11 ms duration, With SSD		
Packaging Content	Carton size: 416 x 409 x 296 (mm) Packing Capacity: 6pcs  Including: PSU ADP 19.5V 135W 100-240VAC x 1 (P/N: 25EP4-201352-C1S) Power Cord : Optional (by region) Wall Mount Bracket x 2 (P/N: 25HB2-CGAA20-CHR) Screw I Head for 25HDD M3x8L x 4 (P/N: 25KSG-130081-K1R) Thermal PAD for DRAM2 x 1 (P/N: 25ST3-200086-T5R)		
Order Information	System: 6BQB1355AMR-SI	System: 6BQB1335AMR-SI	System: 6BQB1315AMR-SI

## Chapter 2

---

### Chapter 2 – QBiX Industrial Embedded System Kit



## 2.1 Dimension

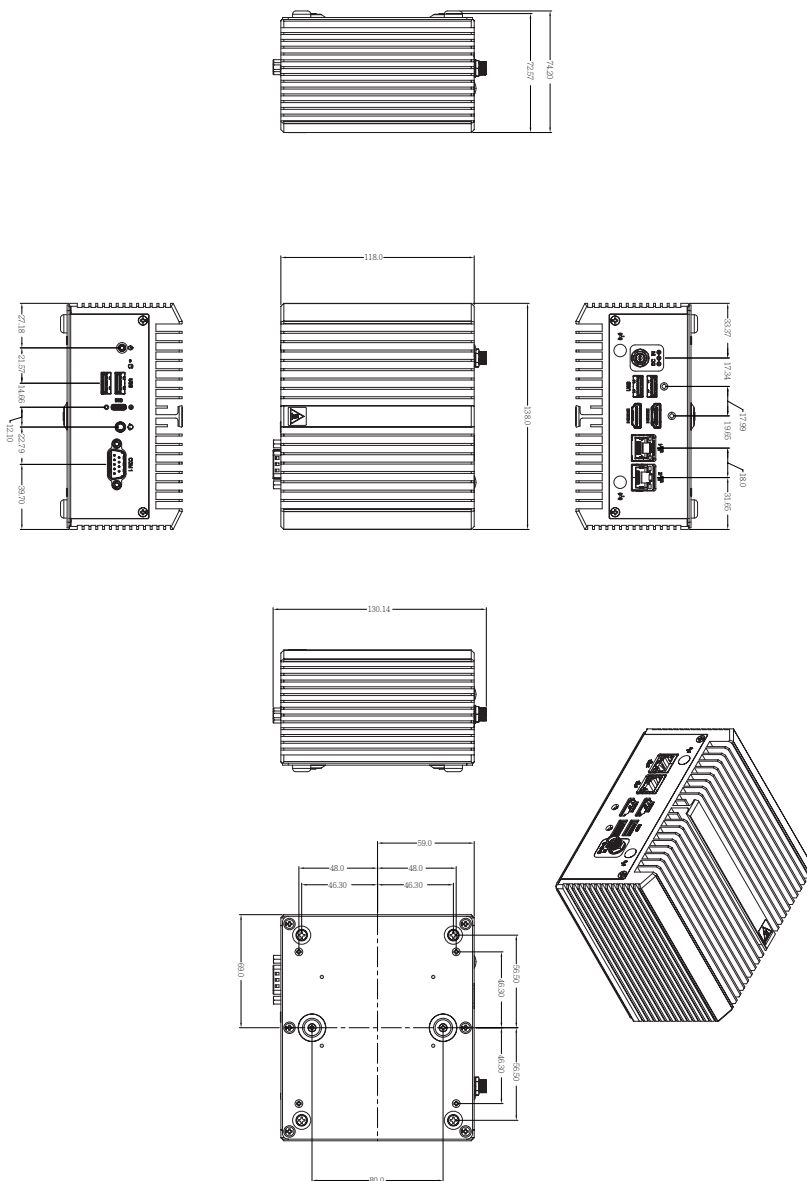

## 2.2 Getting Familiar with Your Unit

### [Front Side]

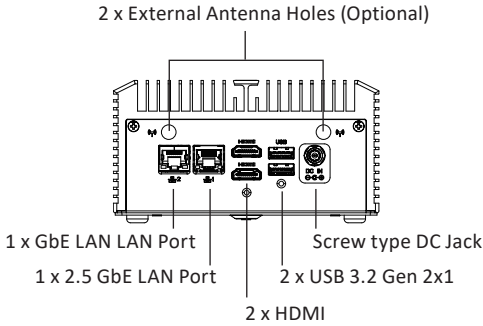

### [Left Side]

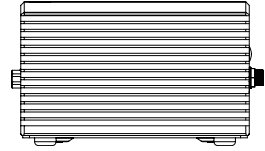

### [Rear Side]

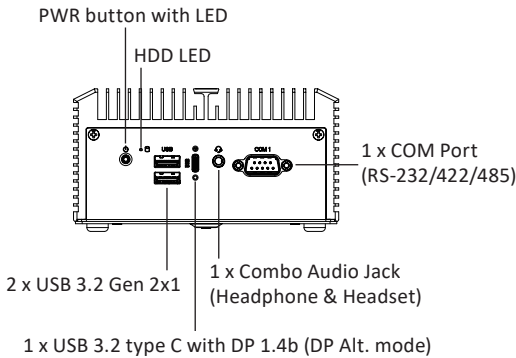

### [Right Side]

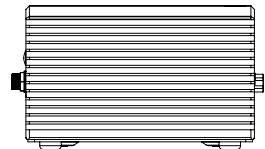

### [Bottom Side]

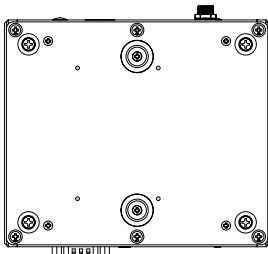

## [Install]

- \* Before opening the case, make sure to unplug the power cord.
- \* Before Connecting the power, make sure to fasten the case securely.

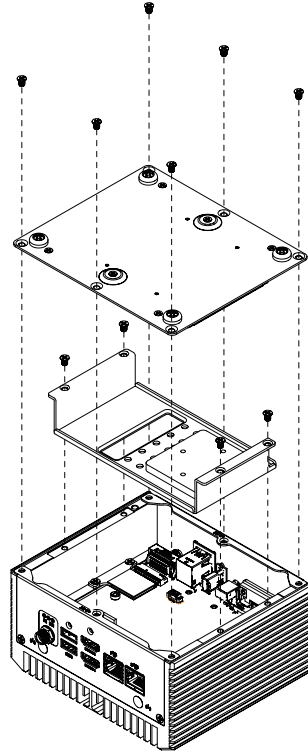

## [Bottom PCB Side]

Information	
A	1 x M.2 slot, 2280 M-key
B	1 x M.2 slot, 2230 E-key

Information	
C	2 x DDR5 SO-DIMM sockets
D	support 2.5" Hard drive/SSD

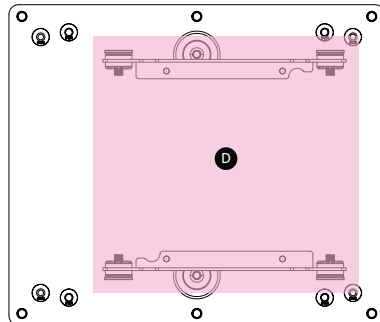
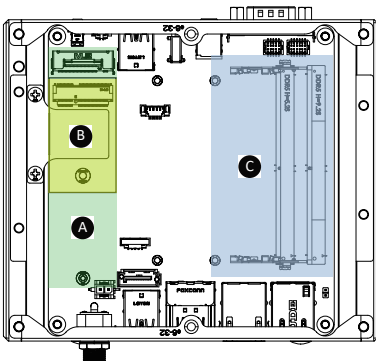

## 2.3 A) M.2 SSD Installation: How to safely install the M.2 2280 SSD

1

Remove the screw from the screw hole. (Location : MSO2)

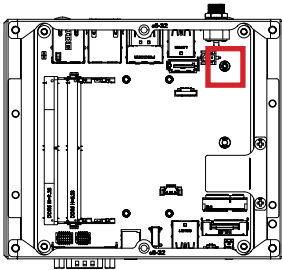

2

Carefully insert the M.2 SSD into the slot, and secure with the screw.

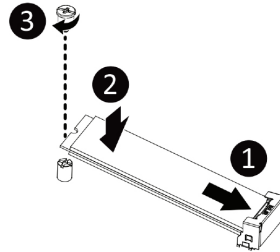

## 2.4 B) Wireless Module : How to safely install the Module (Wireless Module inclusion may vary based on local distribution)

1

Remove release paper on the thermal pad.

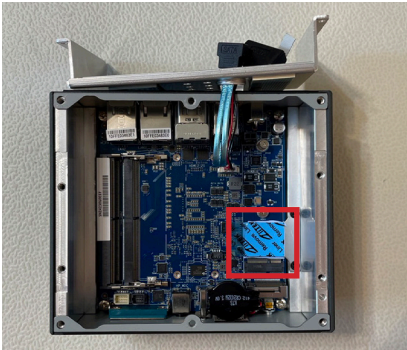

2

Remove 1 screw from the screw hole. (Location : MSO1)

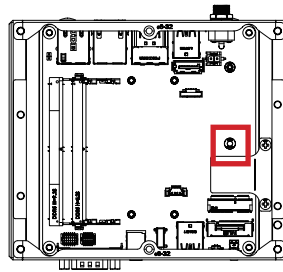

3

Carefully insert the wireless module into the M.2 slot.

4

Lock the screw in the middle.

5

Install the antenna on the left side of the connection wireless module down.

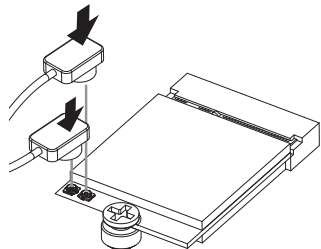
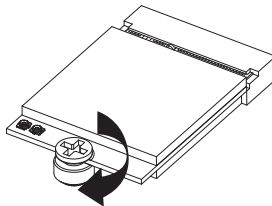
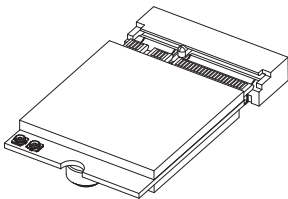

## 2.5 C) Memory Installation: DDR5 SO-DIMM

**1**

Carefully insert SO-DIMM memory modules.

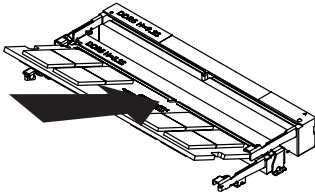
**2**

Push down until the modules click into place.

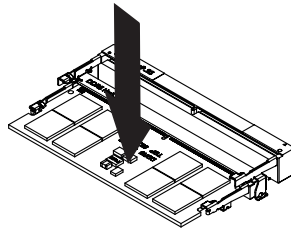
**3**

Carefully insert SO-DIMM memory modules.

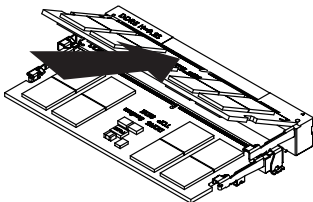
**4**

Push down until the modules click into place.

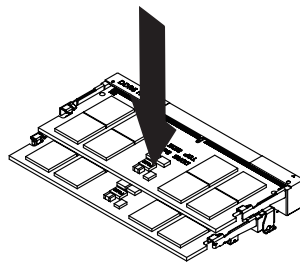

## 2.6 D) 2.5" HDD/SSD installation: How to install 2.5" HDD/SSD

---

- 1 Remove 2 release papers on the thermal pad which located on the bottom cover.
- 2 First : assemble the SATA cable and 2.5" HDD/SSD.  
Second : install 2.5" HDD/SSD (Gold finger of 2.5" HDD/SSD must face down),  
and secure with 4 screws.
- 3 Lock the bottom cover.

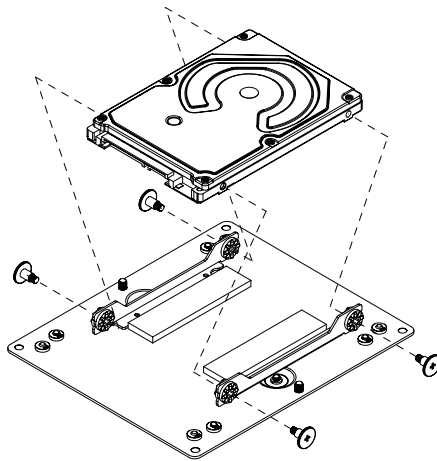

## 2.7 Antenna Installation (Antenna inclusion may vary based on local distribution)

**1**

Carefully insert the antennas into the connectors.

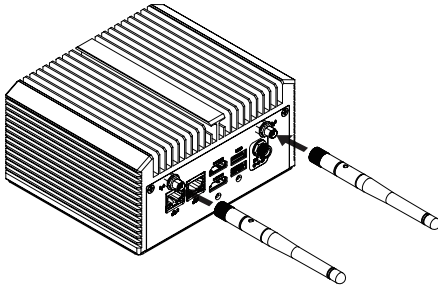
**2**

Turn the antennas clockwise until they are completely secure on the connectors.

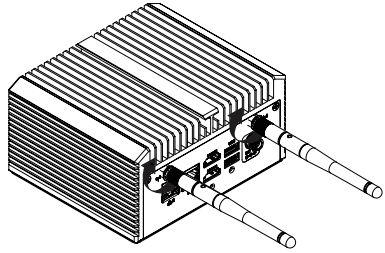
**3**

Flip up the antenna heads so that they are perpendicular to the machine.

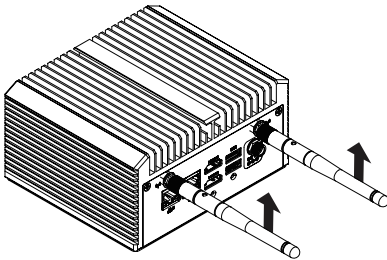



## 2.8 Wall mount bracket Installation

1

After Remove 4 screws with rubber foot, remove the rubber foot from screw, and keep these 4 screws for assemble afterwards.



2

Use 4 screws which removed earlier to assemble wall mount bracket.



3

Install the system, suggest using 4 x M4x10L type screws to fix on the wall. (not included in the shipment) suggest screw type : M4x10L pan head with Spring washer + flat washer (3 in 1), P/N : 25983G-1C017-500



4

Please make sure the direction of installation.



## 2.9 RAL

---

This equipment is intended to be used in Restrict Access Location. The access can only be gained by Skilled person.  
Only authorized by well trained professional person can access the restrict access location.

## 2.10 Support

---

- For a list of tested memory, M.2, 2.5'' SSD, wireless adapters and OS supported, go to: <http://www.gigaipc.com>
- To download the latest drivers and BIOS updates, go to: <http://www.gigaipc.com>
- For product support, go to: <http://www.gigaipc.com>

## 2.11 Safety and Regulatory Information

---

Risk of explosion if the battery is replaced with an incorrect type. Batteries should be recycled where possible.

Disposal of used Batteries must be in accordance with local environmental regulations.

Failure to use the included Power Adapter may violate regulatory compliance and may expose the user to safety hazards.

**HDMI**™  
HIGH DEFINITION MULTIMEDIA INTERFACE



At the end of its serviceable life, this product should not be treated as household or general waste. It should be handed over to the applicable collection point for the recycling of electrical and electronic equipment, or returned to the supplier for disposal.

# Chapter 3

---

## Chapter 3 – Hardware Information

# 3.1 Jumpers and Connectors

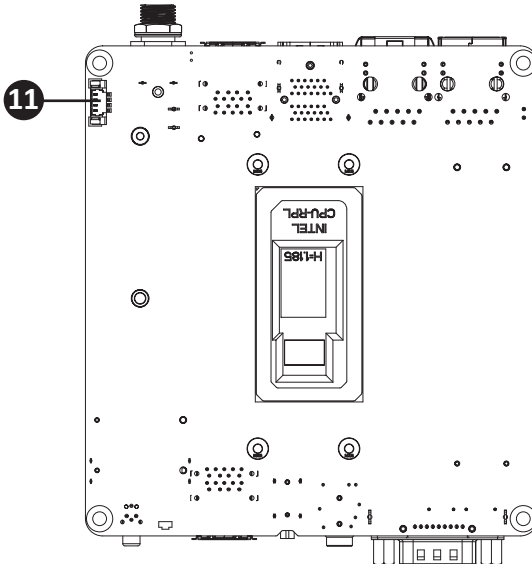
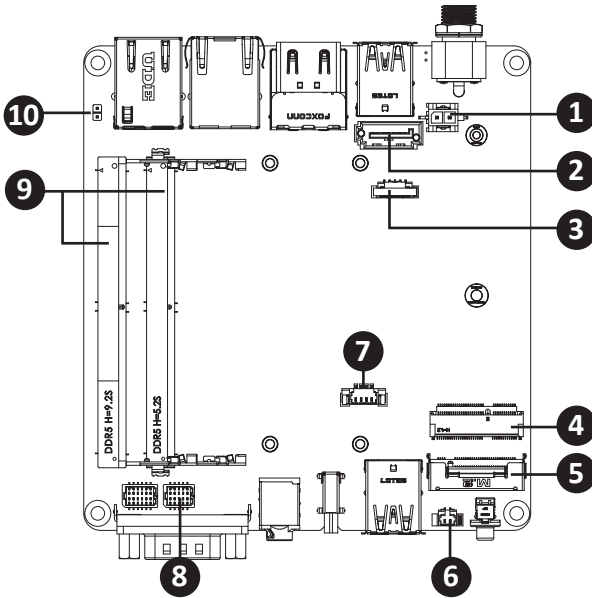

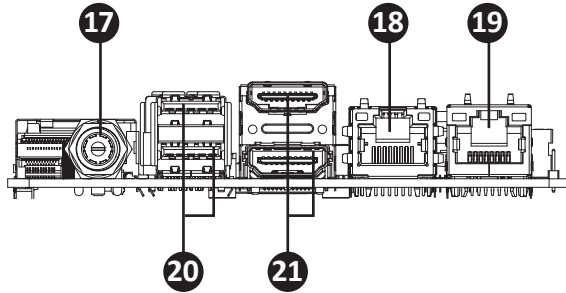
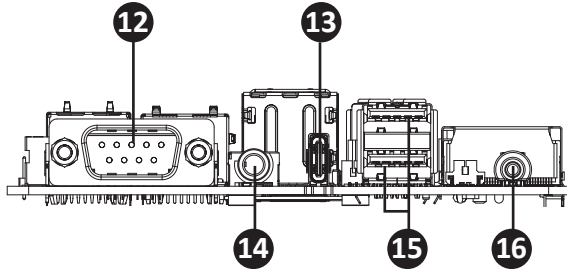

No	Code	Description
1	ATX_IN	ATX IN Connector
2	SATA	SATA 6Gb/s connector
3	SATA_PWR	SATA power connector
4	M2E	M.2 Slot, 2230 E-key
5	M2M	M.2 Slot, 2280 M-Key
6	BATTERY	Battery Connector
7	FUSB	USB 2.0 header
8	F_PANEL	Front panel header

No	Code	Description
9	SODIMM1 SODIMM2	DDR5 SO-DIMM Slot
10	ME_DIS	ME Disable jumper
11	CPU_FAN	CPU FAN Connector
12	COM1	Serial port connector (RS-232/422/485)
13	USB3CM	USB Type C Port
14	HP_MIC	Combo audio jack (Headphone & Headset)
15	USB32_2	USB 3.2 Gen 2x1 Port x 2
16	PWR_BT	Power button with LED
17	DC_IN	Screw type DC Jack
18	LAN1	2.5GbE LAN Port
19	LAN2	1GbE LAN Port
20	USB32_1	USB 3.2 Gen 2x1 Port x 2
21	HDMI2_21	HDMI Port x 2



## 3.2.1 ATX\_IN (ATX IN Connector)

1

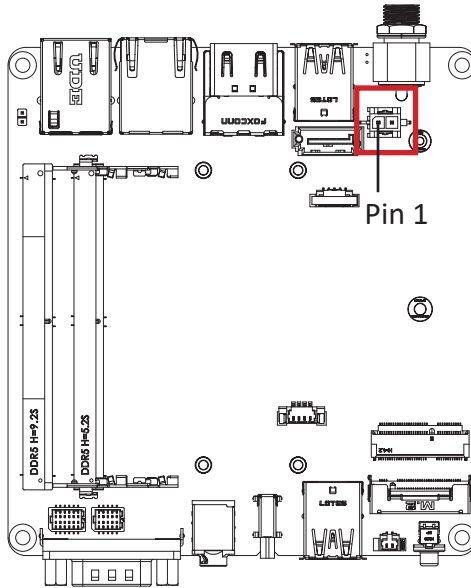

ATX IN Connector	
	
Pin No.	Definition
1	GND
2	DC IN

Connector PN	Vendor
99-01740-B004-A	TCONN
Connector type	
1x2pin header, pitch 3.0mm	

## 3.2.2 SATA (SATA 6Gb/s connector)

2

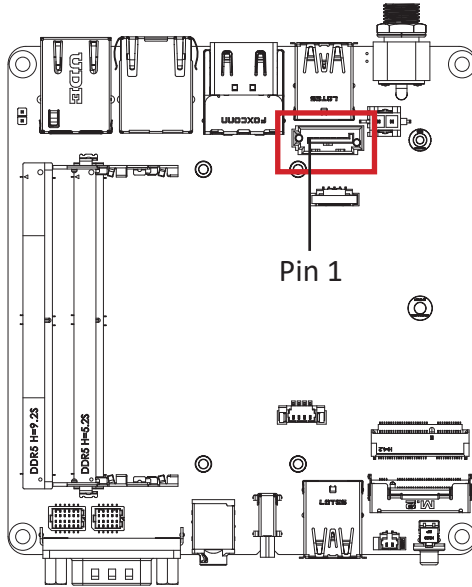

SATA 6Gb/s connector

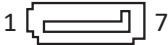

Connector PN

WATF-07DBLBA1UW

Vendor

WINWIN

Pin No.	Definition
1	GND
2	TXp
3	TXn
4	GND
5	RXn
6	RXp
7	GND

## 3.2.3 SATA\_PWR (SATA power connector)

**3**

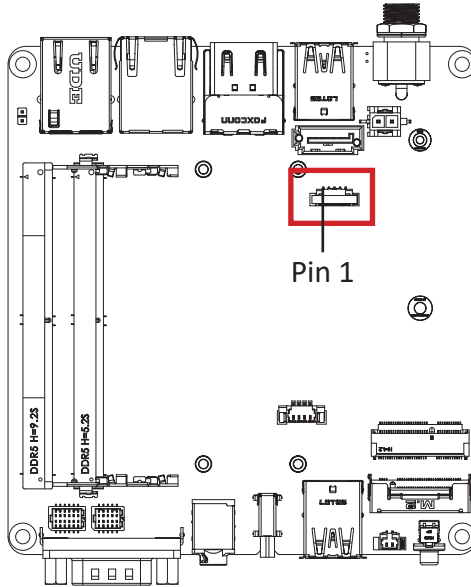

**SATA power connector**

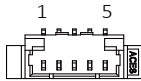

**Connector PN**

85205-0570N

**Vendor**

ACES

**Connector type**

1x5pin header, pitch 1.25mm

Pin No.	Definition
1	5V
2	5V
3	NC
4	GND
5	GND

### 3.2.4 M2E (M.2 Slot, 2230 E-key)

4

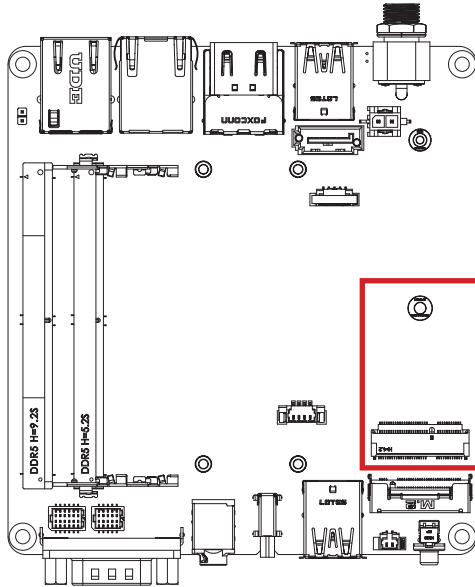

**M.2 E Key Connector**

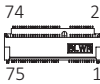

Pin No.	Definition	Pin No.	Definition
1	GND	2	3.3V
3	USB_D+	4	3.3V
5	USB_D-	6	NC
7	GND	8	NC
9	NC	10	NC
11	NC	12	NC
13	NC	14	NC
15	NC	16	NC
17	NC	18	GND
19	NC	20	NC
21	NC	22	NC
23	NC		

Pin No.	Definition	Pin No.	Definition
33	GND	32	NC
35	WLAN_TXp	34	NC

37	WLAN_TXn	36	NC
39	GND	38	CL_Reset
41	WLAN_RXp	40	CL_DATA
43	WLAN_RXn	42	CL_Clock
45	GND	44	NC
47	Clock_Dp	46	NC
49	Clock_Dn	48	NC
51	GND	50	SUSCLK
53	Clock_Request	52	PLT_Reset
55	PCIE_Wake up	54	BT_Disable
57	GND	56	WIFI_Disable
59	NC	58	NC
61	NC	60	NC
63	GND	62	NC
65	NC	64	NC
67	NC	66	NC
69	GND	68	NC
71	NC	70	NC
73	NC	72	3.3V
75	GND	74	3.3V

Connector PN	Vendor
80152-4221	BELLWETHER

## 3.2.5 M2M (M.2 Slot, 2280 M-Key)

5

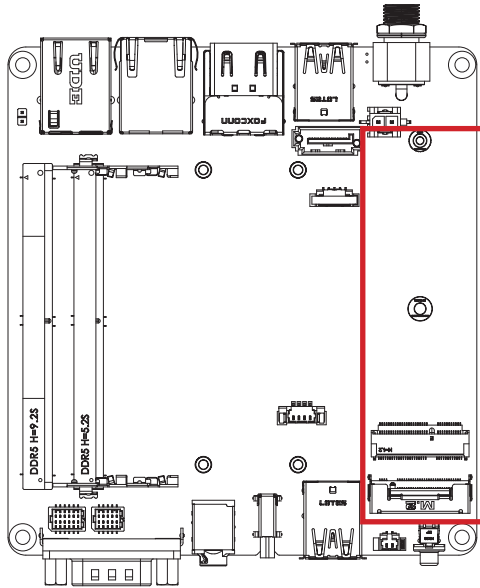

**M.2 M Key Connector**

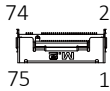

Pin No.	Definition	Pin No.	Definition
1	GND	2	3.3V
3	GND	4	3.3V
5	PCIE_RXn3	6	NC
7	PCIE_RXp3	8	NC
9	GND	10	M2_LED
11	PCIE_TXn3	12	3.3V
13	PCIE_TXp3	14	3.3V
15	GND	16	3.3V
17	PCIE_RXn2	18	3.3V
19	PCIE_RXp2	20	NC
21	GND	22	NC
23	PCIE_TXn2	24	NC
25	PCIE_TXp2	26	NC
27	GND	28	NC
29	PCIE_RXn1	30	NC
31	PCIE_RXp1	32	NC
33	GND	34	NC

Pin No.	Definition	Pin No.	Definition
35	PCIE_TXn1	36	NC
37	PCIE_TXp1	38	DEVSLP
39	GND	40	NC
41	SATA_RXp	42	NC
43	SATA_RXn	44	NC
45	GND	46	NC
47	SATA_TXn	48	NC
49	SATA_TXp	50	PLT_Reset
51	GND	52	CK_Request
53	Clock_n	54	PCIE_Wake up
55	Clock_p	56	NC
57	GND	58	NC

Pin No.	Definition	Pin No.	Definition
67	NC	68	SUSCLK
69	M2_SSD_Detect	70	3.3V
71	GND	72	3.3V
73	GND	74	3.3V
75	GND		

Connector PN	Vendor
2E0BC41-C85CM-LH	FOXCONN

### 3.2.6 BATTERY (Battery connector)

6

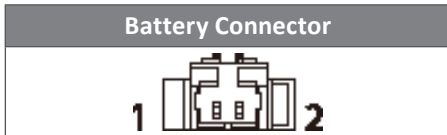
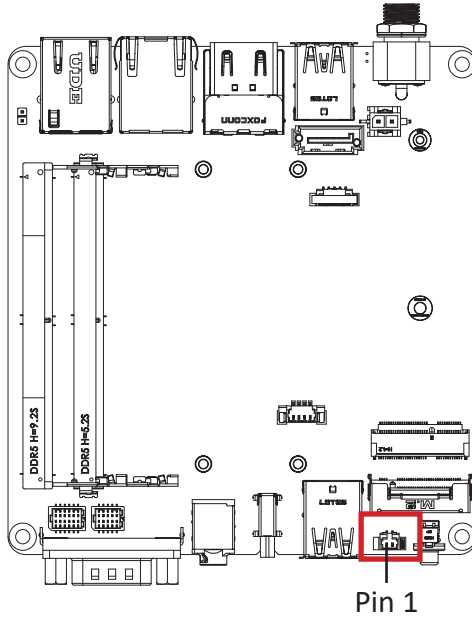

Pin No.	Definition
1	3V
2	GND

Connector type
1x2pin header, pitch 1.25mm

## 3.2.7 FUSB (USB 2.0 header)

7

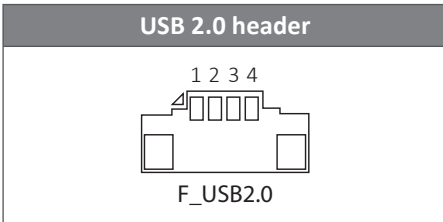
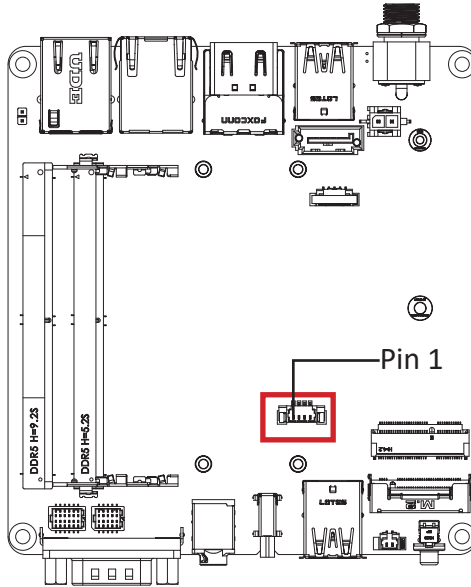

Pin No.	Definition
1	VCC
2	D- (USBN)
3	D+ (USBP)
4	GND

Connector PN	Vendor
A1250WV-S-04PNLBT1T00L	JOINT-TECH
50273-0047N-001	ACES

Connector type
1x4pin header, pitch 1.25mm

### 3.2.8 F\_PANEL (Front panel Connector)

8

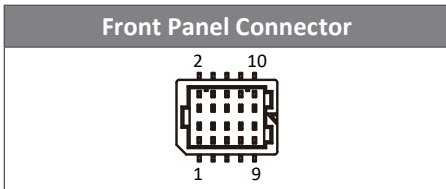
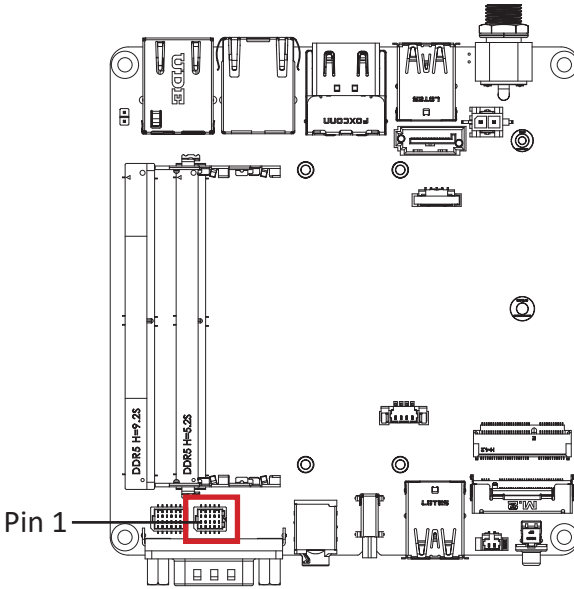

Pin No.	Definition
1	Power Button+
2	Power Button-
3	PWR LED+
4	PWR LED-
5	NC
6	HDD LED-
7	NC
8	NC
9	HDD LED+
10	NC

Connector PN	Vendor
50238-01041-001	ACES

Connector type
2x5pin header, pitch 1.0mm



### 3.2.9 SODIMM1, SODIMM2 (DDR5 SO-DIMM Slot)

9

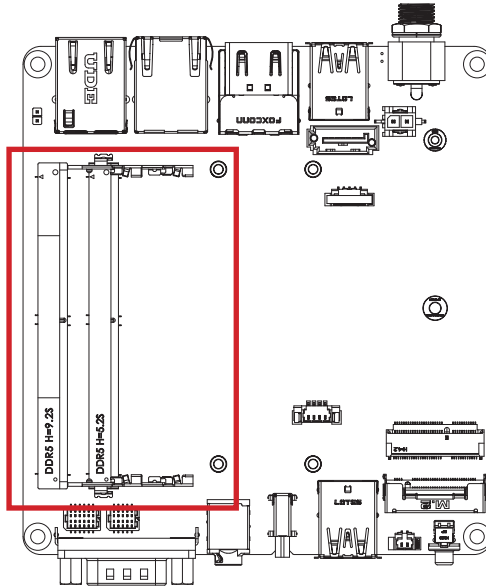

### 3.2.10 ME\_DIS (ME Disable jumper)

10

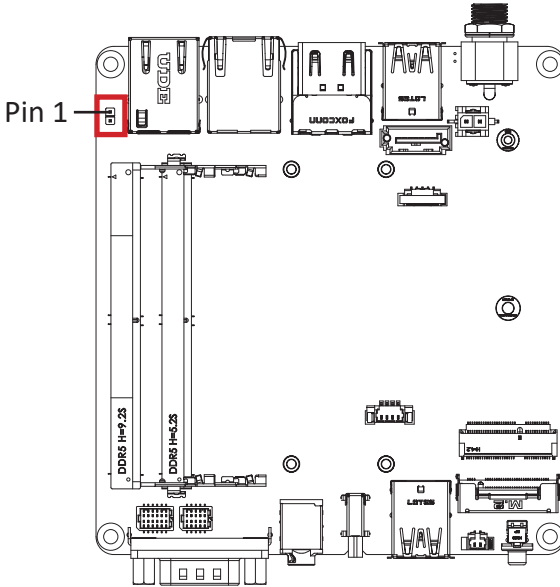

**ME Disable jumper**

**Connector type**  
1x2pin header, pitch 2.0mm

ME Disable Jumper	
	Enable
	Disable

## 3.2.11 CPU FAN (CPU FAN connector)

11

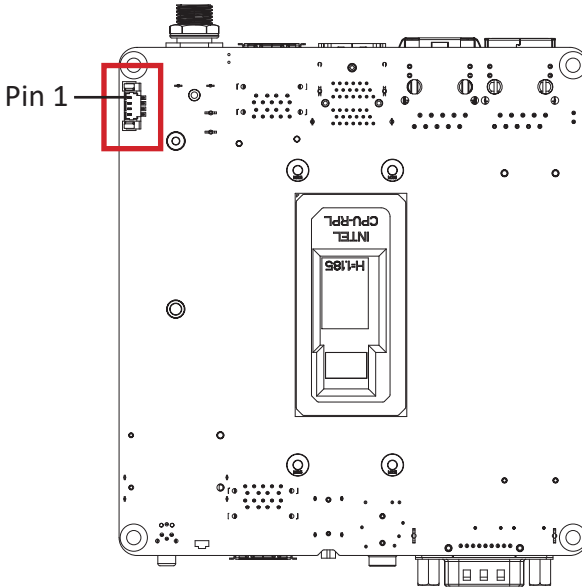

CPU FAN connector

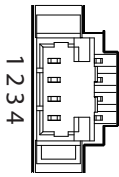

Connector PN

85205-0470N

A1250WV-S-04PC

Vendor

ACES

JOINT-TECH

Connector type

1x4pin header, pitch 1.25mm

Pin No.	Definition
1	GND
2	12V
3	Detect
4	Speed Control

### 3.2.12 COM1 (Serial port connector, RS-232/422/485)

12

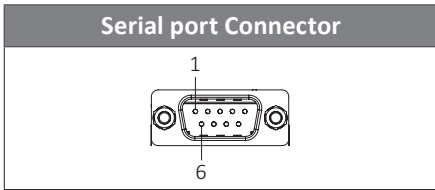
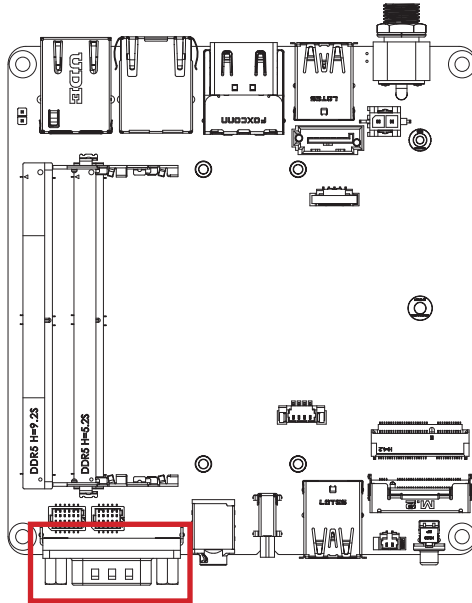

Connector PN	Vendor
SM41D1P1122N33N1	FENYING

Pin No.	RS-232	RS-422 Full Duplex	RS-485 Half Duplex
1	DCD	TXD-	D-
2	RXD	TXD+	D+
3	TXD	RXD+	-
4	DTR	RXD-	-
5	GND		
6	DSR	-	-
7	RTS	-	-
8	CTS	-	-
9	RI	-	-

## 3.2.13 USB3CM (USB Type C Port)

13

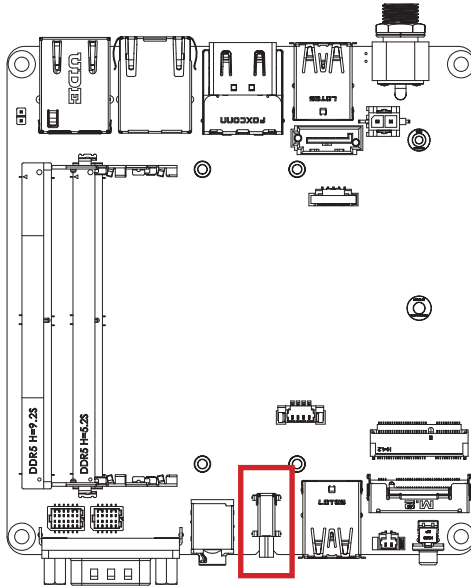

USB TYPE C Port



Pin No.	Definition	Pin No.	Definition
A1	GND	B12	GND
A2	TX0_P	B11	RX0_P
A3	TX0_N	B10	RX0_N
A4	USB_VBUS	B9	USB_VBUS
A5	CC1	B8	SBU2
A6	USBP5_P	B7	USBP5_N
A7	USBP5_N	B6	USBP5_P
A8	SBU1	B5	CC2
A9	USB_VBUS	B4	USB_VBUS
A10	RX1_N	B3	TX1_N
A11	RX1_P	B2	TX1_P
A12	GND	B1	GND

Connector PN	Vendor
WU3CR-24A5L1CU5T41	WINWIN

### 3.2.14 HP\_MIC (Combo audio jack (Headphone & Headset))

14

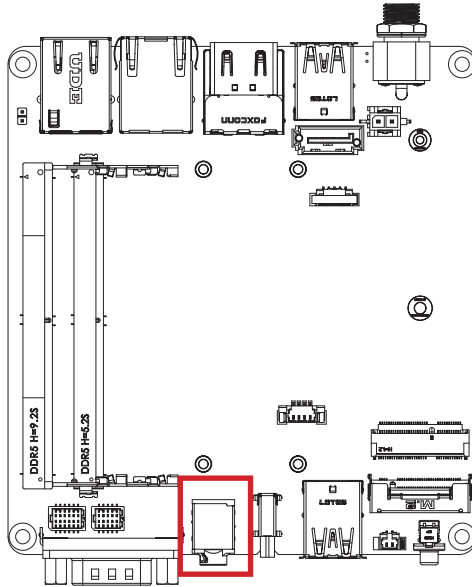

Connector PN	Vendor
2SJ3082-086111F	SINGATRON

Pin No.	Definition	Pin No.	Definition
1	HPOUT_L	4	MIC_IN_C
2	HPOUT_R	5	HP_JD
3	AGND	6	AGND

## 3.2.15 USB32\_2 (USB 3.2 Gen 2x1 Port)

15

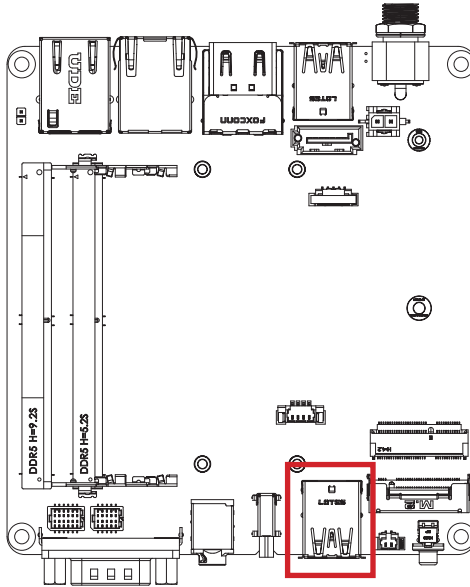

USB 3.2 Gen 2x1 connector



Connector PN

18-A5950-6A33-A

Vendor

TCONN

Pin No.	Definition	Pin No.	Definition
1	5V	10	5V
2	USB_D-	11	USB_D-
3	USB_D+	12	USB_D+
4	GND	13	GND
5	USB3_RX-	14	USB3_RX-
6	USB3_RX+	15	USB3_RX+
7	GND	16	GND
8	USB3_TX-	17	USB3_TX-
9	USB3_TX+	18	USB3_TX+

### 3.2.16 PWR\_BT (Power button with LED)

16

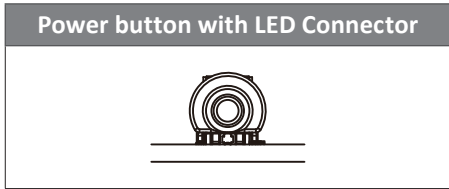
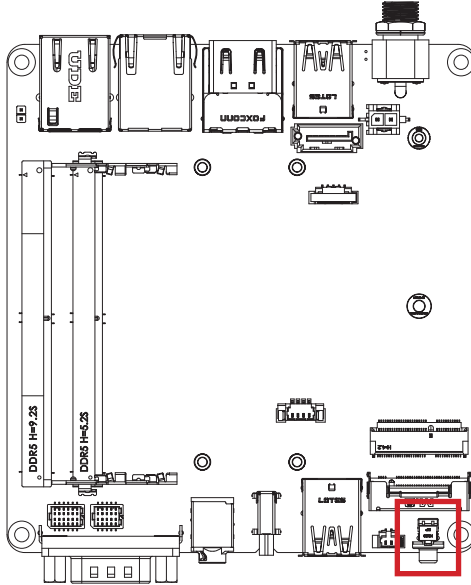

Connector PN	Vendor
ML3-AG2HW-Q-R	DIPTRONICS



### 3.2.17 DC\_IN (Screw type DC Jack connector)

17

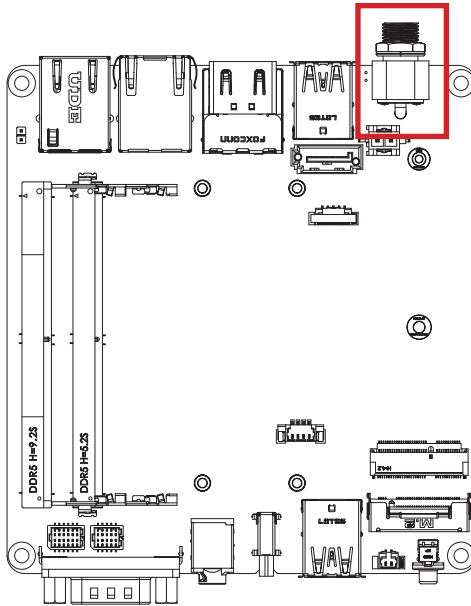

Screw Type DC Jack Connector

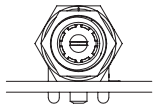

Connector PN	Vendor
655-360-000	SHEN-MING

### 3.2.18 LAN1 (2.5GbE LAN port connector)

18

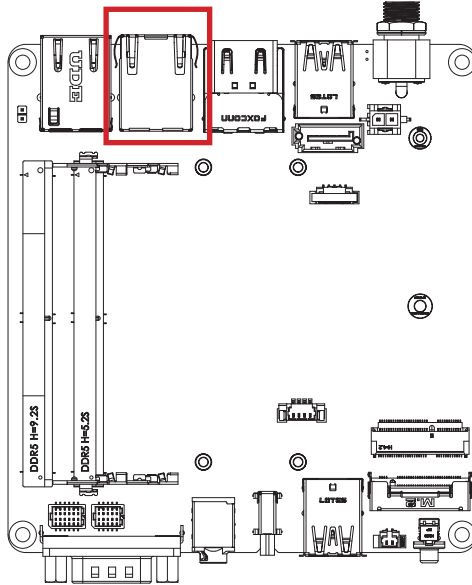

**2.5 GbE LAN Connector**

Link / Activity LED      Connection/ Speed LED

State	Description
Orange On	2.5Gbps data rate
Green On	1GMbps data rate
Off	100/10Mbps data rate

Pin No.	Definition
1	TX+_D1
2	TX-_D1
3	RX+_D2
4	BI+_D3
5	BI-_D3
6	RX-_D2
7	BI+_D4
8	BI-_D4

Connector PN	Vendor
S22-GB-0006	UDE
JFM4811D-F8AF-4F	FOXCONN

## 3.2.19 LAN2 (1GbE LAN port connector)

19

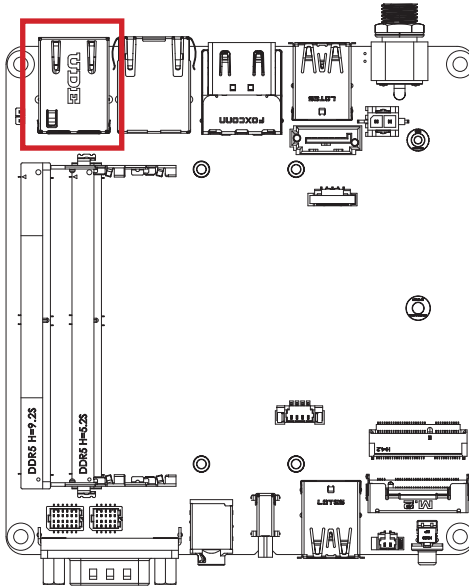

### LAN Connector

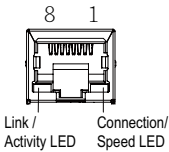

State	Description
Orange On	1Gbps data rate
Green On	100Mbps data rate
Off	10Mbps data rate

Pin No.	Definition
1	TX+_D1
2	TX-_D1
3	RX+_D2
4	BI+_D3
5	BI-_D3
6	RX-_D2
7	BI+_D4
8	BI-_D4

Connector PN	Vendor
RT7-GB-0003	UDE

## 3.2.20 USB32\_1 (USB 3.2 Gen 2x1 connector)

20

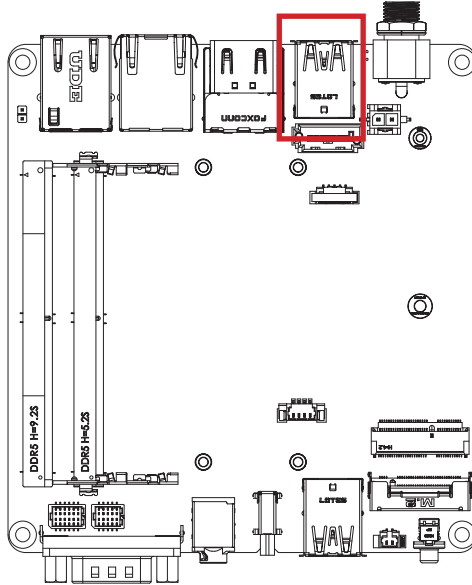

USB 3.2 Gen 2x1 connector

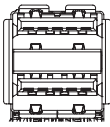

Connector PN	Vendor
18-A5950-6A33-A	TCNN

Pin No.	Definition	Pin No.	Definition
1	5V	10	5V
2	USB_D-	11	USB_D-
3	USB_D+	12	USB_D+
4	GND	13	GND
5	USB3_RX-	14	USB3_RX-
6	USB3_RX+	15	USB3_RX+
7	GND	16	GND
8	USB3_TX-	17	USB3_TX-
9	USB3_TX+	18	USB3_TX+

## 3.2.21 HDMI2\_21 (HDMI connector)

21

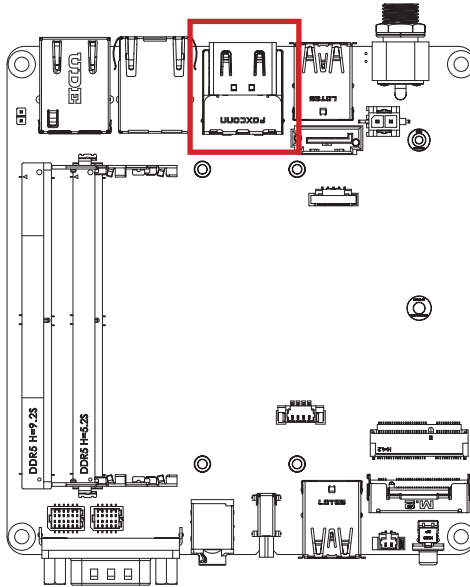

HDMI Connector

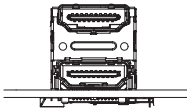

Connector PN

QJ11191-DFB1-4F

Vendor

FOXCONN

Pin No.	Definition	Pin No.	Definition
1	HDMI_D2+	11	GND
2	GND	12	HDMI_CLK-
3	HDMI_D2-	13	NC
4	HDMI_D1+	14	NC
5	GND	15	HDMI_SCL
6	HDMI_D1-	16	HDMI_SDA
7	HDMI_D0+	17	GND
8	GND	18	5V
9	HDMI_D0-	19	HDMI_HPD
10	HDMI_CLK+		

# Chapter 4

---

## Chapter 4 – BIOS

## 4.1 Introduction

BIOS (Basic input/output system) provides hardware detailed information and boot-up options, which include firmware to control, set-up and test all hardware settings. Therefore, BIOS is the communication bridge between OS/application software and hardware.

### 4.1.1 How to Entering into BIOS menu

Once the system is power on, press the <DEL> key as soon as possible to access into BIOS Setup program.

### 4.1.2 Function Keys to setup in BIOS Setup program

Function keys	Description
→←	Select Screen
↑↓	Select Item
Enter	Execute command or enter the submenu
+	Increase the numeric value or make changes
—	Decrease the numeric value or make changes
F1	General Help
F2	Previous Values
F3	Load Optimized Defaults Settings
F4	Save changes & Exit the BIOS Setup program
ESC	Exit the BIOS Setup program

## 4.2 The Main Menu

The main menu shows the basic system information. Use arrow keys to move among the items.

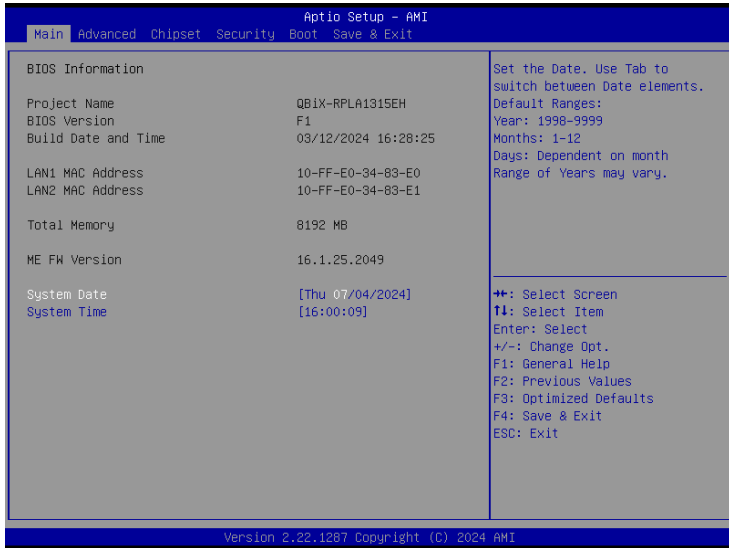

Items	Description
<b>Project Name</b>	<b>Shows Project name information</b>
<b>BIOS Version</b>	<b>Shows the BIOS version of the system</b>
<b>Build Date and Time</b>	<b>Shows the Build Date and Time when the BIOS was created.</b>
<b>LAN1 MAC Address</b>	<b>Shows LAN1 MAC Address information</b>
<b>LAN2 MAC Address</b>	<b>Shows LAN2 MAC Address information</b>
<b>Total Memory</b>	<b>Shows the total memory size of the installed memory</b>
<b>ME FW version</b>	<b>Shows ME firmware version</b>
<b>System Date</b>	<b>Set the Date for the system (Format : Week - Month - Day - Year)</b>
<b>System Time</b>	<b>Set the time for the system (Format : Hour - Minute - Second)</b>



## 4.3 Advanced

The Advanced menu is to configure the functions of hardware settings through submenu. Use arrow keys to move among the items, and press <Enter> to access into the related submenu.

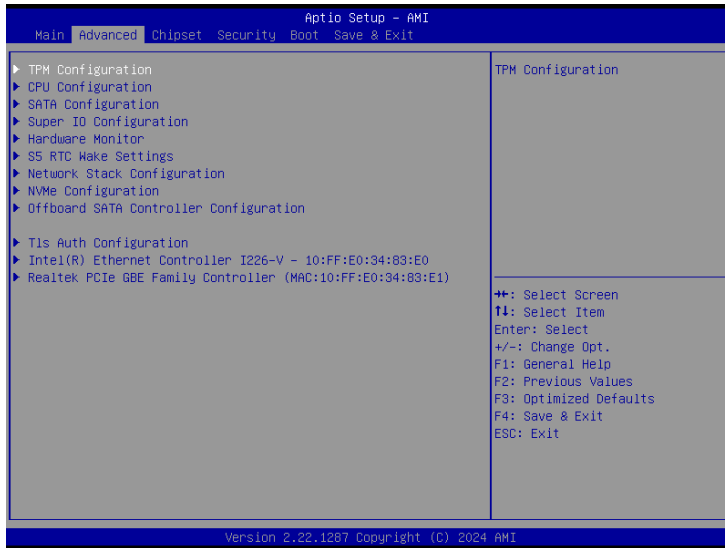

## 4.3.1 TPM Configuration

Use TPM Configuration submenu to choose TPM interface.

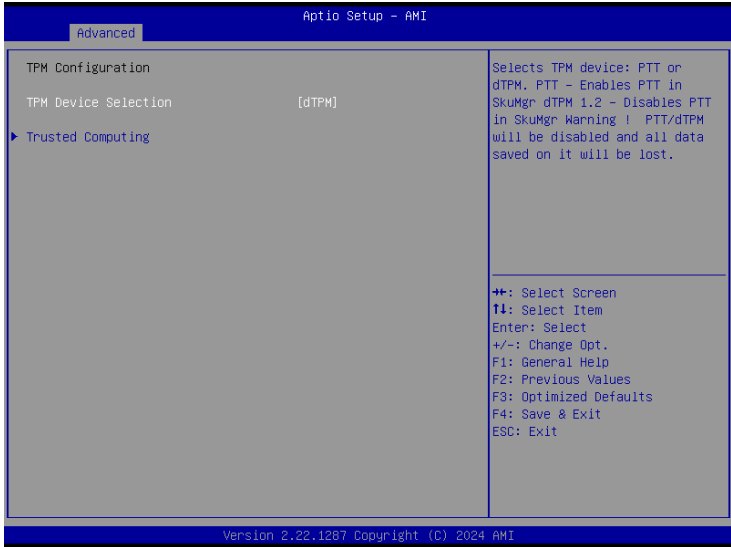

Item	Description
TPM Device Selection	PTT : Internal TPM dTPM : External TPM (When using External TPM module or having TPM chip on MB) (Default setting)

Trusted Computing : Shows TPM information, and TPM module configuration setting.



Item	Description
<b>Security Device support</b>	<b>Enabled : Enables TPM feature (Default setting)</b> <b>Disabled : Disables TPM feature</b>
<b>Pending operation</b>	<b>None : (Default setting)</b> <b>Disabled : Disables TPM feature</b>

## 4.3.2 CPU Configuration

This submenu shows detailed CPU informations.

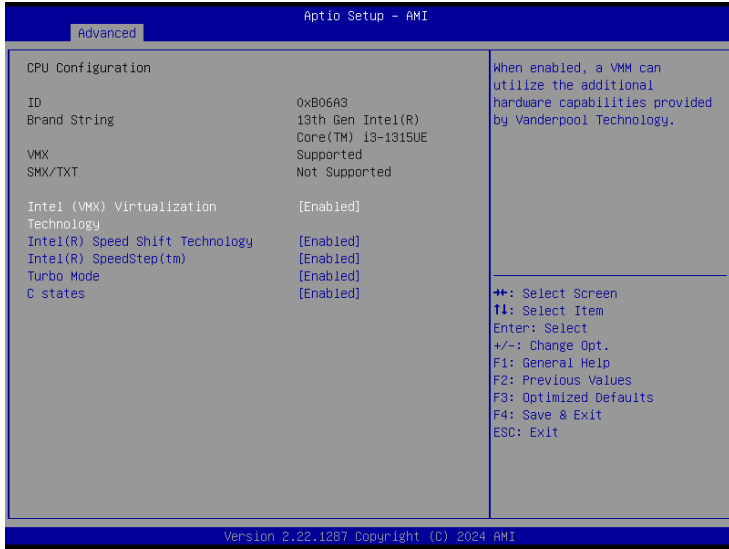

Item	Description
<b>Intel (VMX) Virtualization Technology</b>	Virtualization enhanced by Intel® Virtualization Technology will allow a platform to run multiple operating systems and applications in independent partitions. With virtualization, one computer system can function as multiple virtual systems. <b>Enabled : Enables Intel Virtualization Technology (Default setting)</b> <b>Disabled : Disables Intel Virtualization Technology</b>
<b>Intel(R) Speed Shift Technology</b>	To speed up CPU frequency transition time from basic frequency to maximum frequency. <b>Enabled : Enables Intel(R) Speed Shift Technology (Default setting)</b> <b>Disabled : Disables Intel(R) Speed Shift Technology</b>
<b>Intel(R) SpeedStep(tm)</b>	According to Intel CPU loading, Intel SpeedStep Technology will automatically adjust the CPU voltage and core frequency to decrease heat and power consumption for power saving. <b>Enabled : Enables Intel SpeedStep Technology (Default setting)</b> <b>Disabled : Disables Intel SpeedStep Technology</b>
<b>Turbo Mode</b>	<b>Enabled : Enables Turbo Mode (Default setting)</b> <b>Disabled : Disables Turbo Mode</b>
<b>C states</b>	Command CPU to enter into low power consumption mode when CPU is under idle mode. <b>Enabled : Enables C states (Default setting)</b> <b>Disabled : Disables C states</b>

### 4.3.3 SATA Configuration

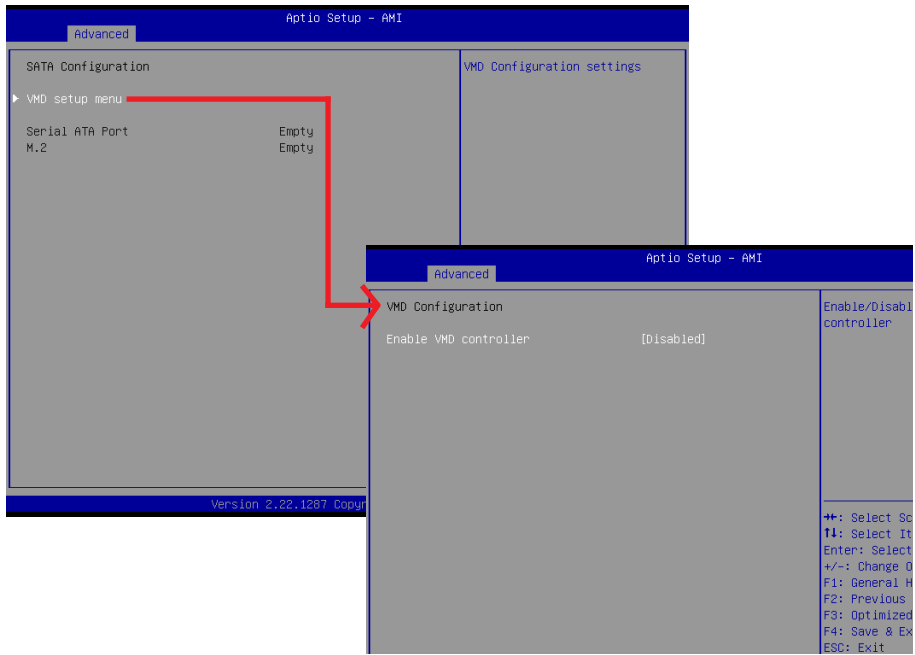

Item	Description
<b>VMD setup menu / Enable VMD controller</b>	Intel VMD feature helps you to control and manage NVMe PCIe SSD. <b>Enabled : Enables Intel VMD feature</b> <b>Disabled : Disables Intel VMD feature (Default setting)</b>
<b>Serial ATA Port</b>	shows 2.5" SATA HDD/SSD information
<b>M.2</b>	shows M.2 SATA interface SSD information

### 4.3.4 Super IO Configuration

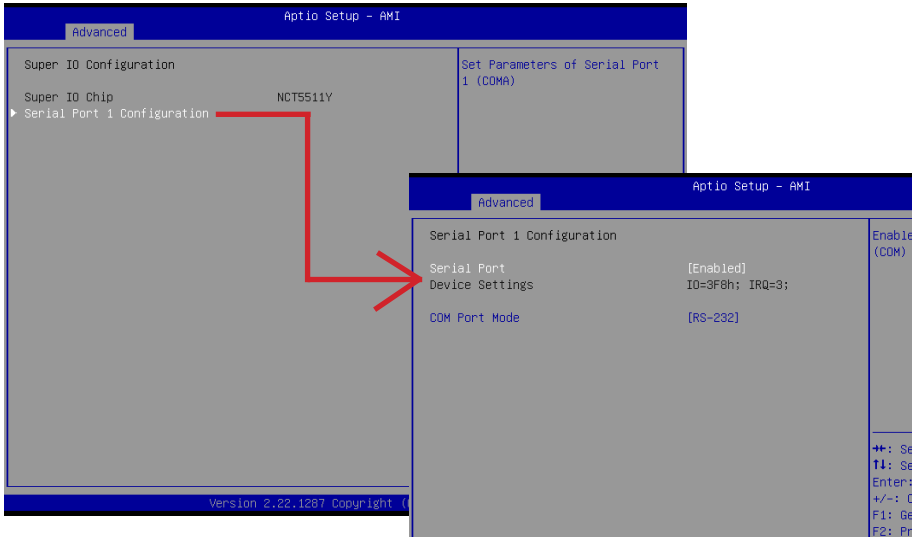

Item	Description
<b>Super IO Chip</b>	Shows Super I/O chip model
<b>Serial Port 1 Configuration</b>	<p>Press [Enter] to configure advanced items :</p> <p>Serial Port :  <b>Enabled : Enables Serial Port function (Default setting)</b>  <b>Disabled : Disables Serial Port function</b></p> <p>Device settings :                      Display the specified Serial Port base I/O address and IRQ</p> <p>COM Port Mode :                      Choose RS-232, RS-422, or RS-485 feature</p>

## 4.3.5 Hardware Monitor

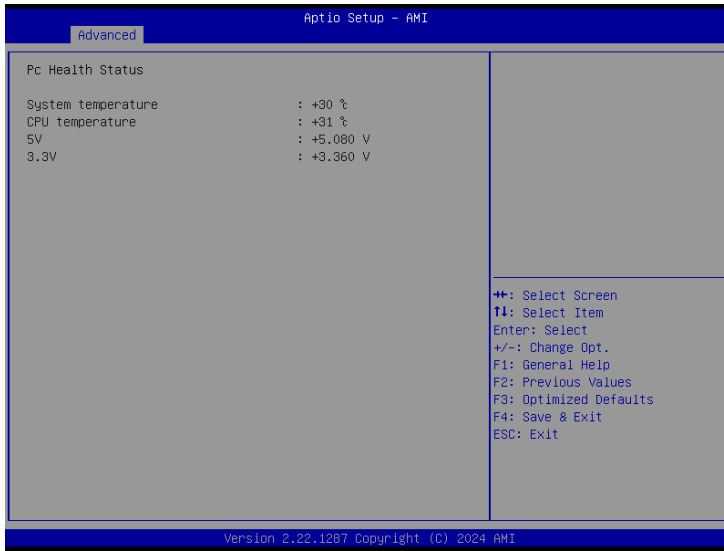

Item	Description
<b>System Temperature</b>	Shows current system temperature
<b>CPU Temperature</b>	Shows current CPU temperature

### 4.3.6 S5 RTC Wake Settings



Item	Description
Wake system from S5	Enable or Disable System to wake on a specific time. <b>Disabled : Disables system to wake on a specific time (Default setting)</b> <b>Fixed Time : Enables system to wake on a specific time (Format : hr : min : sec)</b>



### 4.3.7 Network Stack Configuration

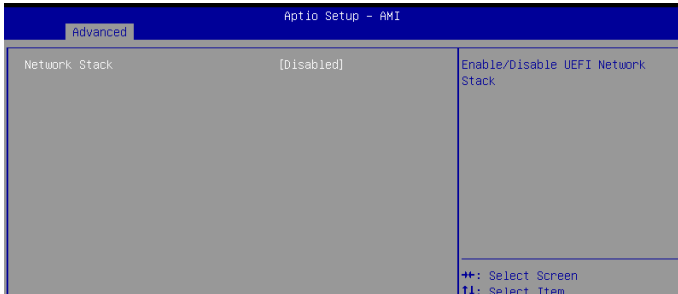

When Network stack is enabled :

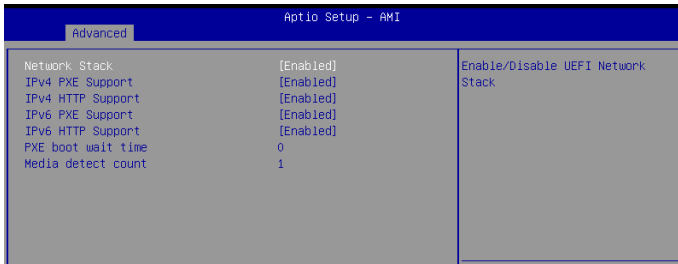

Item	Description
<b>Network Stack</b>	When system is power on, install LAN driver under UEFI mode <b>Disabled : Disables UEFI Network Stack (Default setting)</b> <b>Enabled : Enables UEFI Network Stack</b>
<b>IPv4 PXE Support</b>	When Network stack is enabled : <b>Disabled : Disables IPv4 PXE Support</b> <b>Enabled : Enables IPv4 PXE Support</b>
<b>IPv4 HTTP Support</b>	When Network stack is enabled : <b>Disabled : Disables IPv4 HTTP Support</b> <b>Enabled : Enables IPv4 HTTP Support</b>
<b>IPv6 PXE Support</b>	When Network stack is enabled : <b>Disabled : Disables IPv6 PXE Support</b> <b>Enabled : Enables IPv6 PXE Support</b>
<b>IPv6 HTTP Support</b>	When Network stack is enabled : <b>Disabled : Disables IPv6 HTTP Support</b> <b>Enabled : Enables IPv6 HTTP Support</b>
<b>PXE boot wait time</b>	Wait time in seconds, or use ESC key to abort the PXE boot.
<b>Media detect count</b>	Number of times the presence of media will be checked.

### 4.3.8 NVMe Configuration

NVMe Configuration shows information when your M.2 NVMe PCIe SSD is installed.

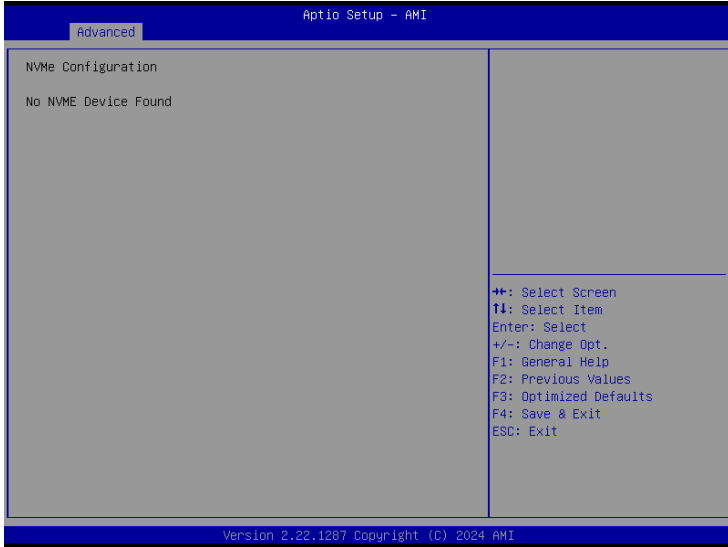

## 4.3.9 Offboard SATA Controller Configuration

---



### 4.3.10 Tls Auth Configuration

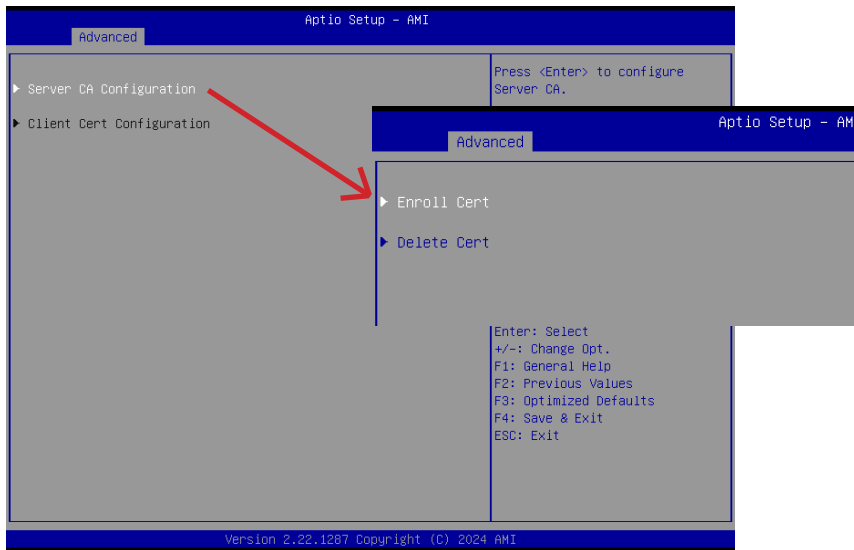

Item	Description
<b>Enroll Cert</b>	<p>Press [Enter] to configure advanced items :</p> <p><b>Server CA Configuration :</b></p> <p>Enroll Cert :</p> <ol style="list-style-type: none"> <li>1. Enroll Cert Using File</li> <li>2. Cert GUID : Input digit character in 11111111-2222-3333-4444-1234567890ab format.</li> <li>3. Commit Changes and Exit</li> <li>4. Discard Changes and Exit</li> </ol>

### 4.3.11 Intel(R) Ethernet Controller I226-V - 10:FF:E0:34:83:E0 (MAC address may varied based on different motherboard)

Shows Intel Ethernet controller information



NOTE : MAC address may varied based on different motherboard

## 4.3.12 Realtek PCIe GBE Family Controller (MAC:10:FF:E0:34:83:E1) (MAC address may varied based on different motherboard)

Shows Realtek Ethernet controller information

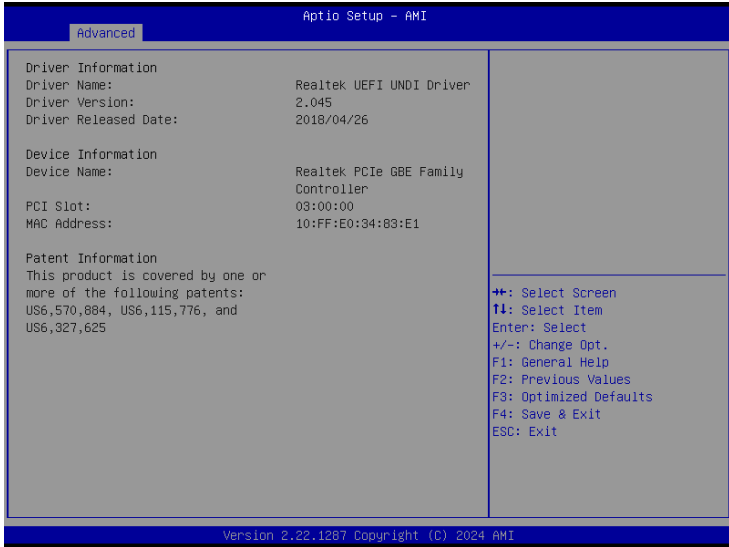

NOTE : MAC address may varied based on different motherboard

## 4.4 Chipset

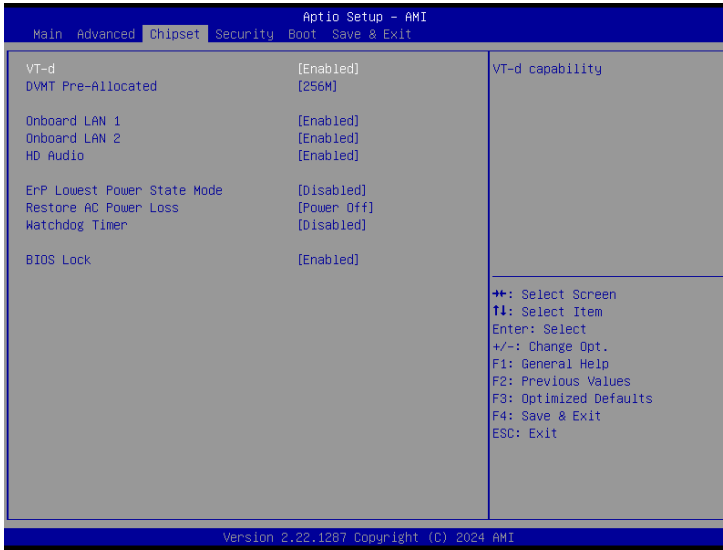

Item	Description
VT-d	<b>Enabled : Enables VT-d function (Default setting)</b> <b>Disabled : Disables VT-d function</b>
DVMT Pre-Allocated	Use DVMT Pre-Allocated to set the amount of system memory which is installed to the integrated graphics processor <b>Option items : 32M , 64M, 128M, 256M (Default setting)</b>
Onboard LAN1 Onboard LAN2	Enable/Disable onboard LAN controller <b>Enabled : Enables onboard LAN controller (Default setting)</b> <b>Disabled : Disables onboard LAN controller</b>
HD Audio	Enable/Disable onboard audio controller <b>Enabled : Enables onboard audio controller (Default setting)</b> <b>Disabled : Disables onboard audio controller</b>
ErP Lowest Power State Mode	Enable/Disable power saving function <b>Enabled : Enables ERP Lowest Power State Mode</b> <b>Disabled : Disabled ERP Lowest Power State Mode (Default setting)</b>
Restore AC Power Loss	To set which option the system should returns if a sudden power loss occurred <b>Power on : System power on when the power is back</b> <b>Power off : Do not power on when the power is back (Default setting)</b> <b>Last state : Restore the system to the state before power loss occurs</b>
Watchdog Timer	Enable/Disable Watchdog Timer function <b>Enabled : Enables Watchdog Timer function</b> <b>Disabled : Disabled Watchdog Timer function (Default setting)</b>
BIOS Lock	Enable/Disable BIOS Lock function <b>Enabled : Enables BIOS Lock function (Default setting)</b> <b>Disabled : Disabled BIOS Lock function</b>

## 4.5 Security



Item	Description
<b>Administrator Password</b>	To set up Administrator's password <b>Minimum length : 3</b> <b>Maximum length : 20</b>
<b>User Password</b>	To set up User's password <b>Minimum length : 3</b> <b>Maximum length : 20</b>
<b>Secure Boot</b>	Press <Enter> to configure the advanced items





Item	Description
<b>Secure Boot</b>	Secure Boot requires all the applications that are running during the booting process to be pre-signed with valid digital certificates <b>Enabled : Enables Secure Boot function</b> <b>Disabled : Disables Secure Boot function (Default setting)</b>
<b>Secure Boot Mode</b>	<b>Standard : Standard mode</b> <b>Custom : Custom mode (Default setting)</b>
<b>Restore Factory Keys</b>	To restore factory settings <b>Yes : Agree to restore factory settings</b> <b>No : Cancel to restore factory settings</b>
<b>Reset To Setup Mode</b>	<b>Yes : Agree to setup mode</b> <b>No : Cancel to setup mode</b>
<b>Key Management</b>	Enables expert users to modify Secure boot policy variables without full authentication Press <Enter> to configure the advanced items

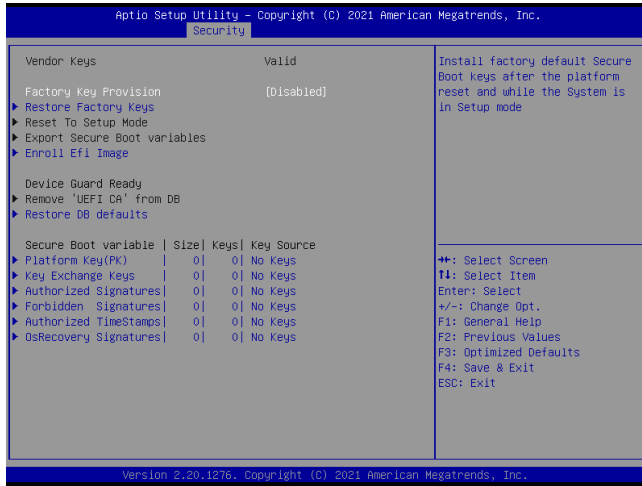

Item	Description
<b>Factory Key Provision</b>	Install factory default Secure Boot keys after the platform reset and while the system is in Setup mode <b>Enabled : Enables Factory Key Provision</b> <b>Disabled : Disables Factory Key Provision (Default setting)</b>
<b>Restore Factory Keys</b>	To restore factory settings
<b>Reset To Setup Mode</b>	Delete all Secure boot key databases from NVRAM
<b>Export Secure Boot variables</b>	Copy NVRAM content of Secure Boot variables to files in a root folder on a file system device
<b>Enroll Efi Image</b>	Allow the image to run in Secure Boot mode
<b>Remove 'UEFI CA' from DB</b>	To remove 'UEFI CA' from database
<b>Restore DB defaults</b>	Restore DB variables to factory defaults <b>Yes : Agree to restore DB defaults</b> <b>No : Cancel to restore DB defaults</b>

Item	Description
<b>Platform Key (PK)</b>	These items allows you to enroll factory defaults or load Certificates from a file.
<b>Key Exchange Keys</b>	
<b>Authorized Signatures</b>	
<b>Forbidden Signatures</b>	
<b>Authorized TimeStamps</b>	
<b>OsRecovery Signatures</b>	

## 4.6 Boot

This Boot menu allows you to set/change system boot options

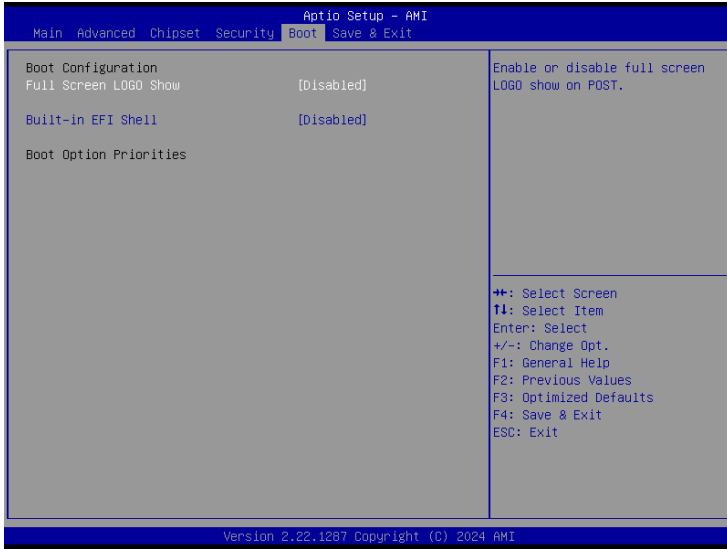

Item	Description
<b>Full Screen LOGO Show</b>	Enable/Disable full screen LOGO show on POST screen <b>Enabled : Enables Full screen LOGO Show on POST screen</b> <b>Disabled : Disables Full screen LOGO Show on POST screen (Default setting)</b>
<b>Built-in EFI Shell</b>	<b>Enabled : Enables Built-in EFI Shell</b> <b>Disabled : Disables Built-in EFI Shell (Default setting)</b>
<b>Boot Option Priorities</b>	Shows the information of the storage that be installed in the system <b>Choose/set the boot priority</b>

## 4.7 Save & Exit

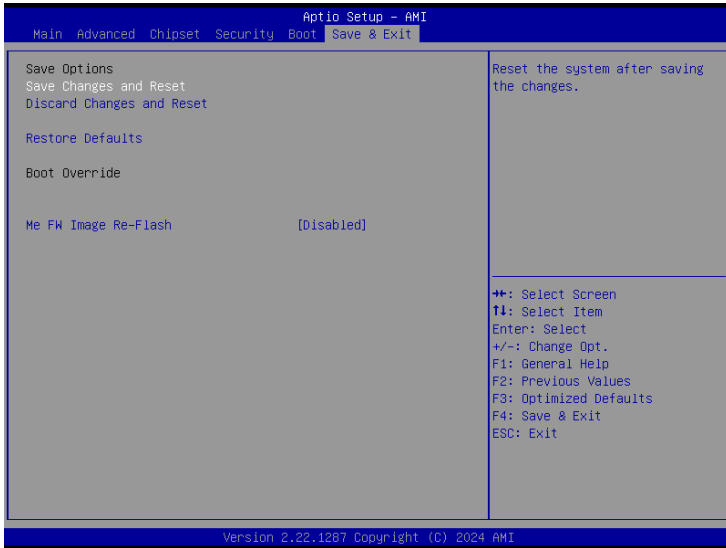

Item	Description
<b>Save Changes and Reset</b>	After configuring all the options that you wish to change, choose this option to save all the changes and reboot the system <b>Yes : Agree to save and reset</b> <b>No : Cancel to save and reset</b>
<b>Discard Changes and Reset</b>	Choose this option to reboot the system without saving any changes <b>Yes : Agree to discard changes and reset</b> <b>No : Cancel to discard changes and reset</b>
<b>Restore Defaults</b>	Restore/Load default values for all the setup options <b>Yes : Agree to load optimized defaults</b> <b>No : Cancel to load optimized defaults</b>
<b>Me FW Image Re-Flash</b>	Enable/Disable Me FW image re-flash function <b>Enabled : Enables Me FW image re-flash function</b> <b>Disabled : Disables Me FW image re-flash function (Default setting)</b>