

ASB200-838

Fanless System with 3.5" Disk-Size SBC

User's Manual

Version 1.0
(May 2024)



Copyright

© 2024 IBASE Technology, Inc. All rights reserved.

No part of this publication may be reproduced, copied, stored in a retrieval system, translated into any language or transmitted in any form or by any means, electronic, mechanical, photocopying, or otherwise, without the prior written consent of IBASE Technology, Inc. (hereinafter referred to as "IBASE").

Disclaimer

IBASE reserves the right to make changes and improvements to the products described in this document without prior notice. Every effort has been made to ensure the information in the document is correct; however, IBASE does not guarantee this document is error-free.

IBASE assumes no liability for incidental or consequential damages arising from misapplication or inability to use the product or the information contained herein, nor for any infringements of rights of third parties, which may result from its use.

Trademarks

All the trademarks, registrations and brands mentioned herein are used for identification purposes only and may be trademarks and/or registered trademarks of their respective owners.

Compliance

CE

This product has passed CE tests for environmental specifications and limits. This product is in accordance with the directives of the Union European (EU). If users modify and/or install other devices in this equipment, the CE conformity declaration may no longer apply.

FCC

This product has been tested and found to comply with the limits for a Class B device, pursuant to Part 15 of the FCC Rules. These limits are designed to provide reasonable protection against harmful interference in a residential installation. This equipment generates, uses and can radiate radio frequency energy and, if not installed and used in accordance with manufacturer's instructions, may cause harmful interference to radio communications.

WEEE



This product must not be disposed of as normal household waste, in accordance with the EU directive of for waste electrical and electronic equipment (WEEE - 2012/19/EU). Instead, it should be disposed of by returning it to a municipal recycling collection point. Check local regulations for disposal of electronic products.

Green IBASE



This product is compliant with the current RoHS restrictions and prohibits use of the following substances in concentrations exceeding 0.1% by weight (1000 ppm) except for cadmium, limited to 0.01% by weight (100 ppm).

- Lead (Pb)
- Mercury (Hg)
- Cadmium (Cd)
- Hexavalent chromium (Cr6+)
- Polybrominated biphenyls (PBB)
- Polybrominated diphenyl ether (PBDE)

Important Safety Information

Carefully read the precautions before using the device.

Environmental conditions:

- Lay the device horizontally on a stable and solid surface in case the device may fall, causing serious damage.
- Leave plenty of space around the device and do not block the openings for ventilation. NEVER DROP OR INSERT ANY OBJECTS OF ANY KIND INTO THE VENTILATION OPENINGS.
- Slots and openings on the chassis are for ventilation. Do not block or cover these openings. Make sure you leave plenty of space around the device for ventilation. NEVER INSERT OBJECTS OF ANY KIND INTO THE VENTILATION OPENINGS.
- Use this product in environments with ambient temperatures $-20^{\circ}\text{C} \sim 60^{\circ}\text{C}$ for SSD, and $0^{\circ}\text{C} \sim 45^{\circ}\text{C}$ for HDD.
- DO NOT LEAVE THIS DEVICE IN AN ENVIRONMENT WHERE THE STORAGE TEMPERATURE MAY GO BELOW -20°C OR ABOVE 80°C . This could damage the device. The device must be used in a controlled environment.

Care for your iBASE products:

- Before cleaning the device, ensure it is powered off and disconnected from all cables, including the power cable, to prevent any risk of electric shock.
- Use a damp cloth with neutral cleaning agents or diluted alcohol to gently clean the device chassis. Avoid applying cleaning agents directly to the device. After cleaning, wipe the chassis with a dry cloth to remove any moisture.
- Use a computer vacuum cleaner to carefully remove dust from the air vents and slots of the device.



WARNING

Attention during use:

- Avoid placing heavy objects on top of the device to prevent damage.
- Only operate the device using the type of power indicated on the marking label.
- Do not walk on or place heavy objects on the power cord to prevent damage or tripping hazards.
- If using an extension cord, ensure that the total ampere rating of all products plugged into it does not exceed the cord's limits to prevent overloading and potential hazards.

Avoid Disassembly

Do not disassemble, repair, or modify the device in any way. Doing so could create hazards, cause damage to the device, and may result in bodily injury or property damage. Additionally, such actions will void any warranty.



CAUTION

"Warning: There is a risk of explosion if the internal lithium-ion battery is replaced with an incorrect type. Only replace it with the same or an equivalent type recommended by the manufacturer. Dispose of used batteries according to the manufacturer's instructions.

Warranty Policy

- **IBASE standard products:**

We offer a 24-month (2-year) warranty from the date of shipment. If the date of shipment is unknown, the product serial numbers can help approximate the shipping date.

- **3rd-party parts:**

For components not manufactured by IBASE, such as CPUs, memory, HDDs, power adapters, panels, and touchscreens, we provide a 12-month (1-year) warranty from the delivery date.

- * However, please note that products that fail due to misuse, accidents, improper installation, or unauthorized repairs will be considered out of warranty. In such cases, customers will be billed for repair and shipping charges.,

Technical Support & Services

1. Visit the IBASE website at www.ibase.com.tw to find the latest information about the product.
2. If you need any further assistance from your distributor or sales representative, prepare the following information of your product and elaborate upon the problem.
 - Product model name
 - Product serial number
 - Detailed description of the problem
 - The error messages in text or in screenshots if there is any
 - The arrangement of the peripherals
 - Software in use (such as OS and application software, including the version numbers)
3. If repair service is required, visit the IBASE's eRMA page to apply for RMA authorization. You will then print out the RMA form containing the assigned RMA number and include it with the items to be returned.

Table of Contents

Chapter 1	General Information	1
1.1	Introduction	2
1.2	Features.....	2
1.3	Packing List	3
1.4	Optional Accessories	3
1.5	Specifications.....	4
1.6	Product View.....	6
1.7	Dimensions	9
Chapter 2	Hardware Configuration	10
2.1	Installations.....	11
2.1.1	HDD Installation.....	11
2.1.2	M.2 Card Installation.....	12
2.1.3	Memory Installation	13
2.1.4	WiFi / 3G / 4G Antenna Installation.....	14
2.1.5	Side Bracket Installation	14
2.1.6	Pinout for COM Ports, DC Power & Digital I/O Connectors.....	15
2.2	Setting the Jumpers	17
2.3	Jumper & Connector Locations on the Motherboard	18
2.4	Jumpers Quick Reference.....	19
2.4.1	eDP Panel Power Selection (JP1)	19
2.4.2	LVDS Panel Brightness Selection (JP2)	20
2.4.3	LVDS Panel Power Selection (JP3).....	20
2.4.4	AT / ATX Selection (JP4).....	21
2.4.5	M.2 B-key / Sierra Module Selection (JP5)	21
2.4.6	Sierra Module Interface Selection (JP6).....	22
2.4.7	Clear CMOS Data (SW1).....	22
2.4.8	Clear ME Register (SW1)	23
2.5	Connectors Quick Reference	24
2.5.1	SATA Connectors (CN1)	25
2.5.2	eDP Connector (CN2).....	25
2.5.3	DP Connectors (CN3).....	27
2.5.4	LAN Connectors (CN4, CN5).....	28
2.5.5	USB 3.2 Connector (CN6)	28
2.5.6	Type-C Connector (CN7).....	29
2.5.7	USB 3.2 Stack Connector (CN8).....	29
2.5.8	COM1 RS-232/422/485 Serial Port (CN9)	30
2.5.9	Nano SIM Card Slot (J1).....	31
2.5.10	DDR5 SO-DIMM Connector (J2).....	31

2.5.11	M.2 B-Key 3052 Connector (J3)	32
2.5.12	DC Power Input Connector (J4).....	32
2.5.13	USB 2.0 Connector (J5).....	33
2.5.14	SPI Flash Tool Connector (J6).....	33
2.5.15	Audio Connector (J7).....	34
2.5.16	SATA HDD Power Connector (J8)	34
2.5.17	Speaker Out Connector (J9).....	35
2.5.18	LVDS Connectors (J10, J15)	36
2.5.19	SMBUS Connector (J11)	37
2.5.20	M.2 E-Key 2230 Connector (J13).....	37
2.5.21	COM2, COM3, COM4 RS-232 Ports (J18, J16, J14)	38
2.5.22	RTC Battery Connector (J20)	38
2.5.23	LVDS Backlight Connector (J21)	39
2.5.24	80 Port Debug Tool Connector (J22)	39
2.5.25	Digital I/O Connector (J23)	40
2.5.26	Front Panel Setting Connector (J24).....	40
Chapter 3 Driver Installation		41
3.1	Introduction	42
3.2	Intel® Chipset Software Installation Utility	42
3.3	VGA Driver Installation.....	44
3.4	HD Audio Driver Installation	46
3.5	LAN Driver Installation	49
3.6	Intel® Management Engine Drivers Installation.....	51
3.7	Intel(R) Serial IO Drivers Installation	52
Chapter 4 BIOS Setup.....		53
4.1	Introduction	54
4.2	BIOS Setup.....	54
4.3	Main Settings	55
4.4	Advanced Settings	56
4.5	Chipset Settings.....	68
4.6	Security Settings	70
4.7	Boot Settings.....	71
4.8	Save & Exit Settings.....	72
Appendix		74
A.	I/O Port Address Map.....	75
B.	Interrupt Request Lines (IRQ)	77
C.	Watchdog Timer Configuration.....	78
D.	Onboard Connector Reference Types.....	82

Chapter 1

General Information

The information provided in this chapter includes:

- Features
- Packing List
- Optional Accessories
- Specifications
- Product View
- Dimensions

1.1 Introduction

The ASB200-838 is a compact and fanless embedded system powered by the IBASE IB838 3.5" Single Board Computer, featuring an onboard Intel® N-series Processor. Its robust design, coupled with a wide-range power input of 9V to 36V DC, ensures reliability in various environments. This system supports up to 16GB of DDR5 SO-DIMM memory and features 2x M.2 sockets (B-Key/E-Key) for expanded storage options and CNVi wireless connectivity. With 3x USB 3.2 ports, 1x USB Type-C port, and 2x Intel® 2.5 Gigabit LAN ports, it offers versatile connectivity options. Additionally, it is equipped with 2x DisplayPort interfaces, external digital I/O, and fTPM.



1.2 Features

- Fanless system with IBASE IB838 3.5" Single Board Computer
- Onboard Intel® N-series Processor
- Supports 2x M.2 sockets (B-Key/E-Key)
- 9V ~ 36V DC Wide-Range power input
- 1x DDR5 SO-DIMM, Max.16 GB
- 3x USB 3.2 + 1x USB Type-C, 2x Intel® 2.5 Gigabit LAN
- 2x DisplayPort, External Digital I/O, support fTPM
- Wall mount kit included



1.3 Packing List

Your product package should include the items listed below. If any of the items below is missing, contact the distributor or the dealer from whom you purchased the product.

- ASB200-838 x 1
- 3-pin Terminal Block (for power) x 1
- 10-pin Terminal Block (for GPIO connector) x 1
- Side Brackets x 1
- Screws for Side Brackets x 4
- Power Adaptor and Power Cord x 1

1.4 Optional Accessories

- WiFi / Bluetooth Module Kit

1.5 Specifications

Product Name	ASB200-838-i3M
Description	Fanless chassis with IB838F board and Intel® Atom i3-N305 on board, 4x COM, 1x DDR5 memory slot, 1x 2.5" SSD slot, desktop stand & mounting bracket, w/o memory/ SSD/ 90W power adaptor and VESA mount bracket
System	
Operating System	<ul style="list-style-type: none"> • Windows 10 • Linux Ubuntu / Fedora
Memory	1x DDR5-4800 SO-DIMM, Max.16GB
Front Panel External I/O	<ul style="list-style-type: none"> • 1x Power button • 1x Digital I/O (4-in/4-out) • 1x HDD LED • 1x 3-pin DC-in terminal block for 12V(-10%) ~ 24V(+10%)
Rear Panel External I/O	<ul style="list-style-type: none"> • 3x USB 3.x • 1x USB Type-C • 1x DisplayPort • 1x DB9 for COM#1 • 1x DB9 for COM#2 • 2x 2.5G LAN
Expansion Slots	2x M.2 sockets (B-Key/ E-Key)
Storage	1x 2.5" HDD or SSD
Construction	Aluminum & steel
Chassis Color	Black
Mounting Type	<ul style="list-style-type: none"> • Desktop or wall mount (wall mount kit included) • Optional VESA mount kit
Dimensions	180mm (W) x 150mm (D) x 72mm (H) 7.08" (W) x 5.9" (D) x 2.83" (H)
Certificate	CE / LVD / FCC Class B

Environment	
Temperature	<ul style="list-style-type: none"> • Operating: 0 ~ 45 °C (32 ~ 113 °F) • Storage: -20~ 80 °C (-4 ~ 176 °F)
Relative Humidity	5 ~ 90% at 45 °C (non-condensing)
Vibration Protection	<ul style="list-style-type: none"> • Operating: 0.25 Grms / 5 ~ 500 Hz • Non-operating: 1 Grms / 5 ~ 500Hz
Shock Protection	<ul style="list-style-type: none"> • Operating: 20 g / 11 ms • Non-operating: 40 g / 11 ms

All specifications are subject to change without prior notice.

1.6 Product View

Front View

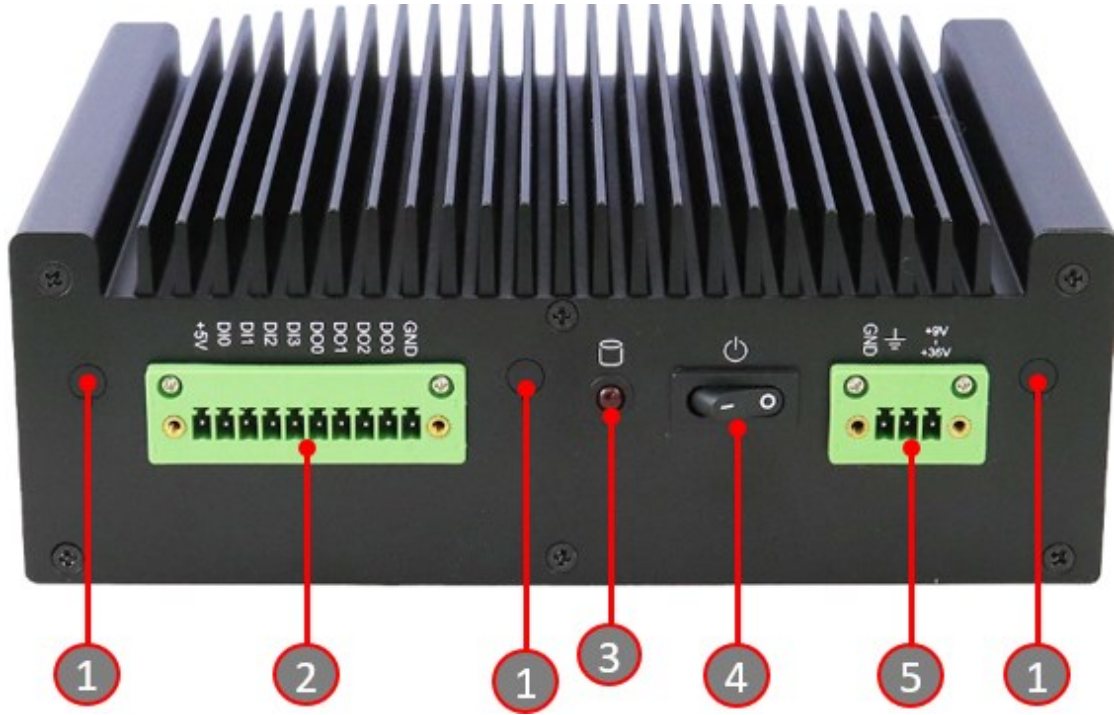

No.	Name	No.	Name
1	Antenna Holes	4	Power Switch
2	Digital I/O (4-In / 4-Out)	5	DC in +12V~ +36V
3	HDD LED		

Rear View

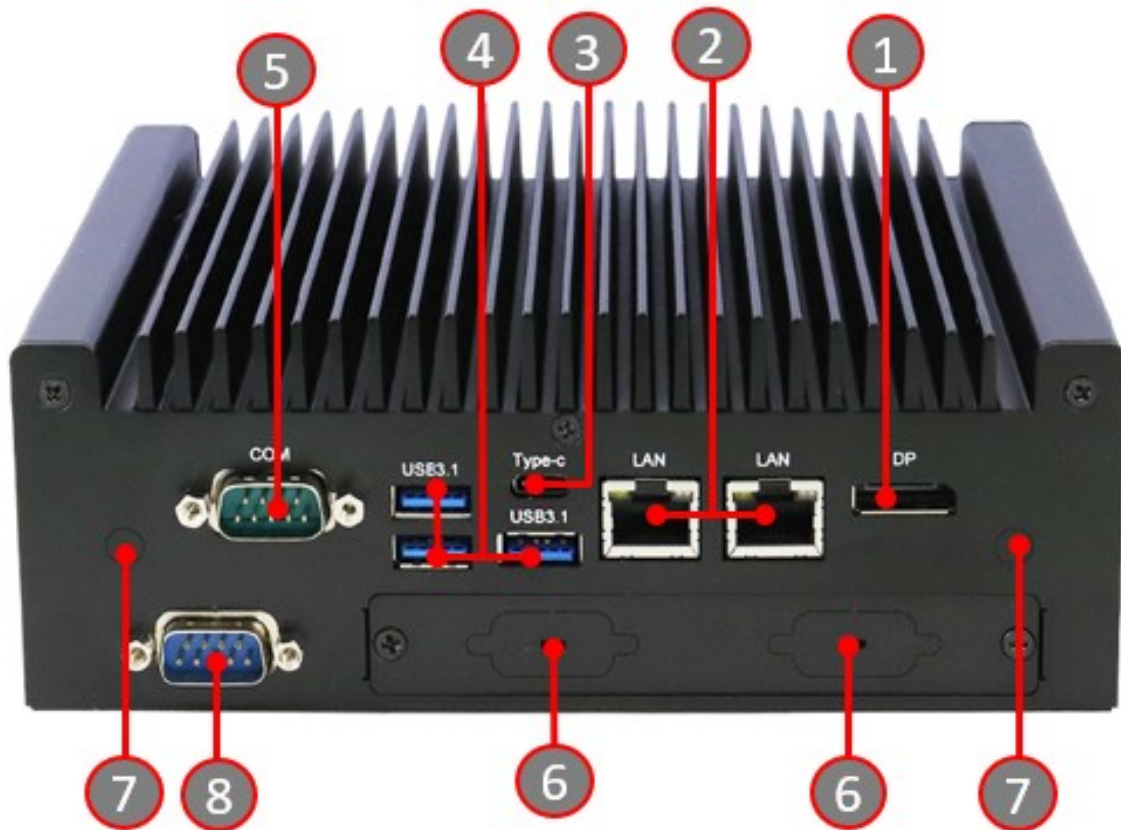

No.	Name	No.	Name
1	Display Port	5	COM1 RS-232/422/485
2	LAN Port	6	COM Port Holes
3	USB Type-C	7	Antenna Holes
4	USB 3.x Ports	8	COM Port

Oblique View



1.7 Dimensions

Unit: mm

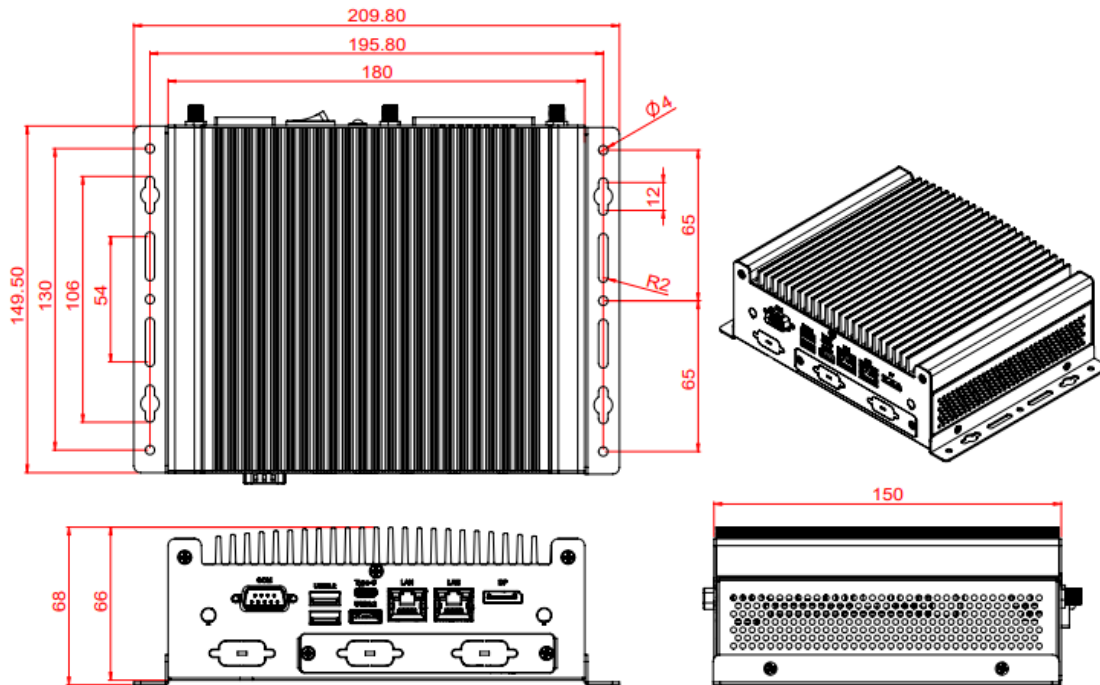

Chapter 2

Hardware Configuration

The information provided in this chapter includes:

- Installations
- Descriptions and locations of connectors

2.1 Installations

2.1.1 HDD Installation

If you need to install or replace an SSD or a HDD, first unscrew the single screw (as indicated below) to remove and lift the hard drive cover. Then, proceed to remove the other screws securing the SSD/HDD drive.

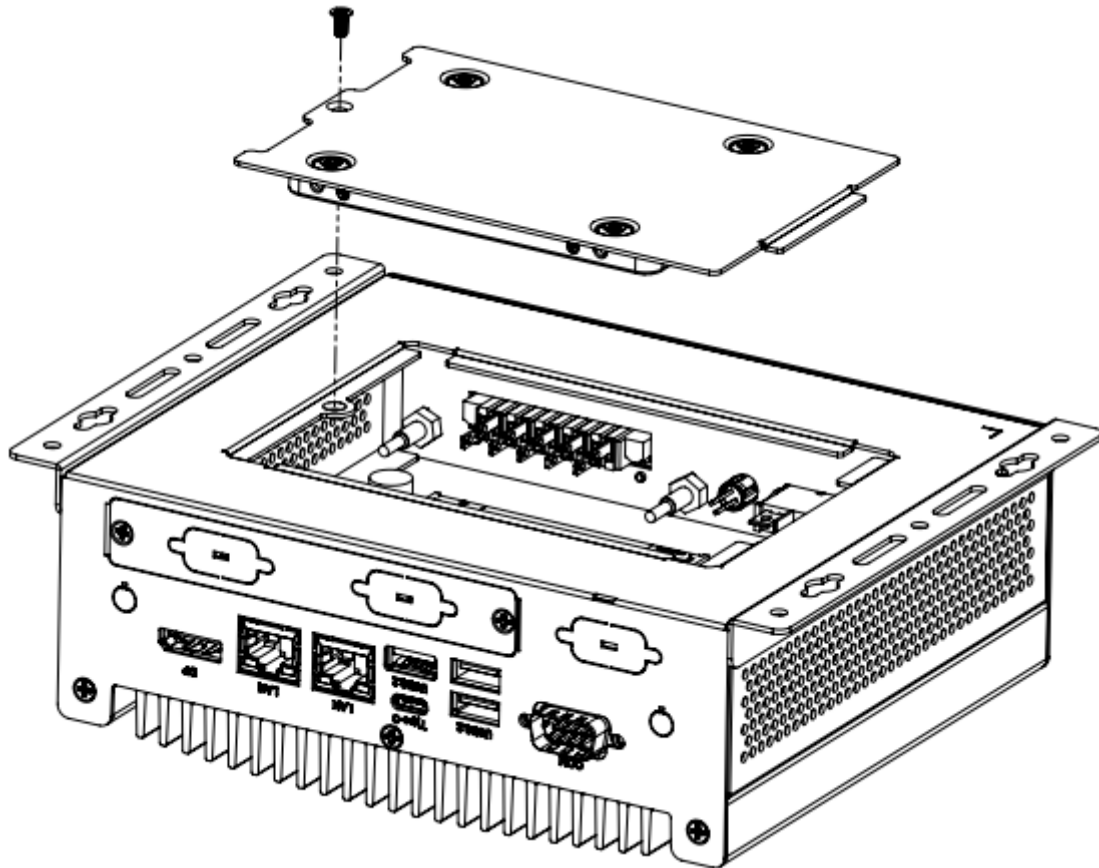

2.1.2 M.2 Card Installation

1. Remove the bottom chassis cover by loosening the 9 screws and the COM port standoff as indicated below.

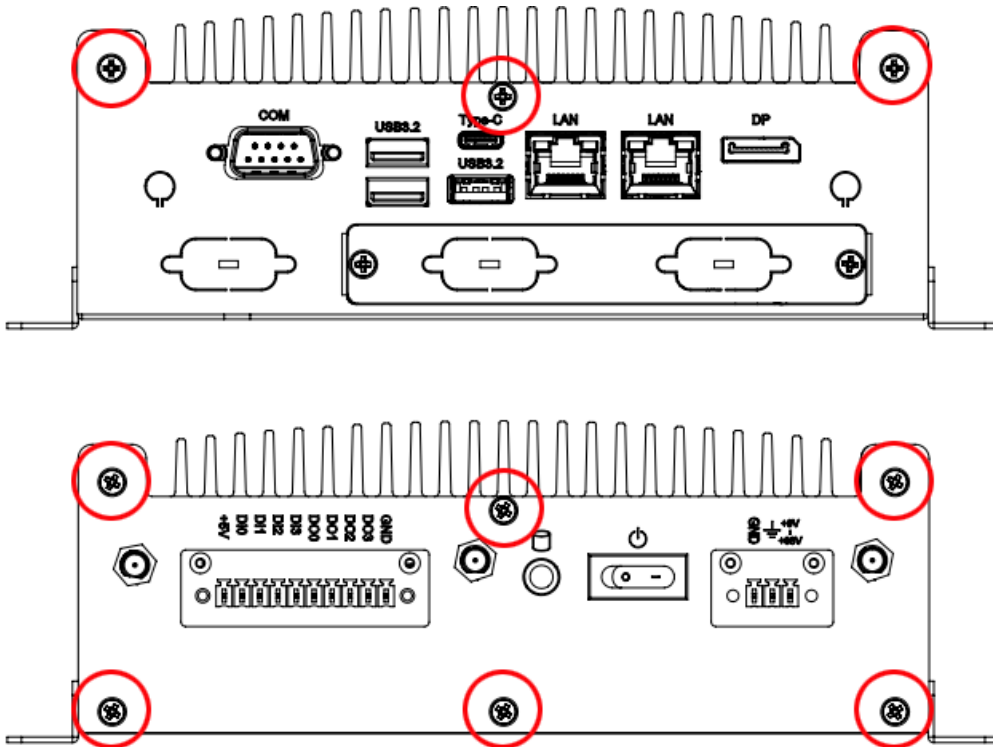

2. Locate the M.2 card slots to install the M.2 cards.

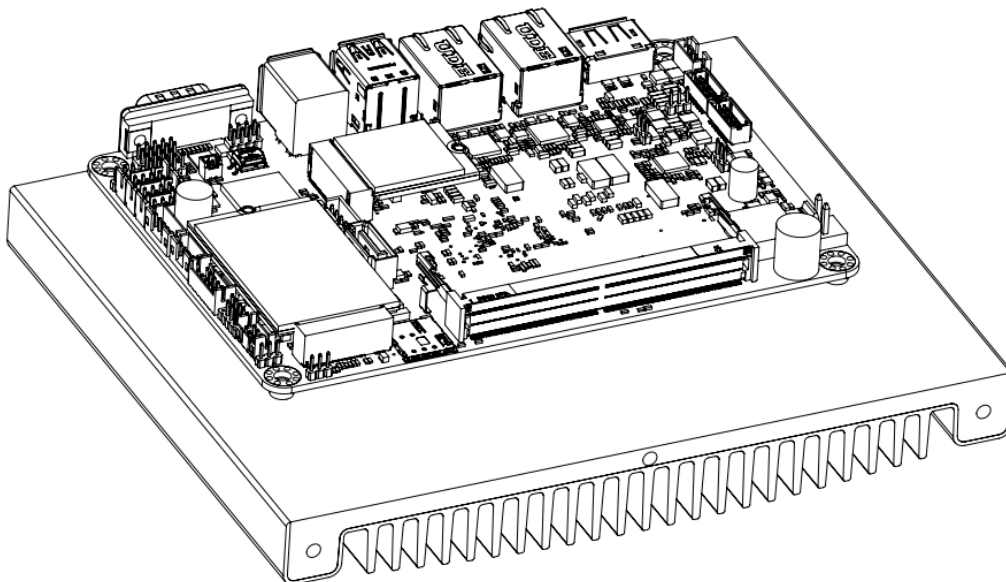

3. Align the key of the m.2 card to the m.2 interface, and insert the card slantwise.

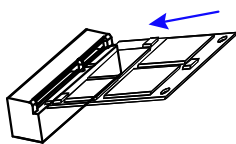

4. Push the m.2 card down, fix it onto the standoff with a screw.

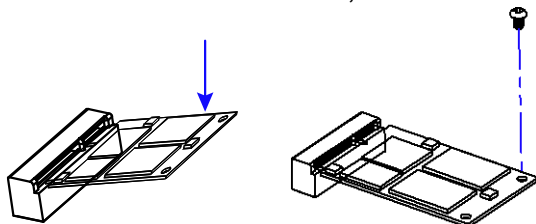

2.1.3 Memory Installation

If you need to install or replace a memory module, perform the following steps:

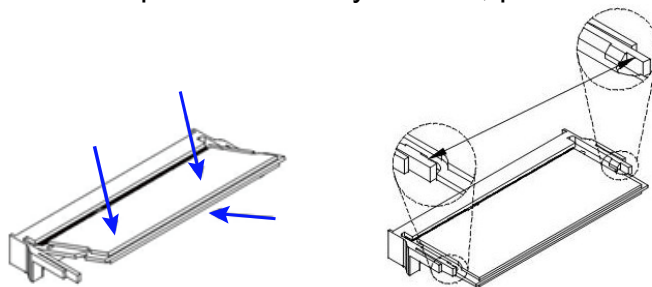

1. Locate the memory slot on the board.
2. Align the key of the memory module with that on the memory slot and insert the module slantwise.
3. Gently push the module down in an upright position until the clips of the slot close to hold the module in place when the module touches the bottom of the slot.

To remove the module, press the clips outwards with both hands, and the module will pop-up.

2.1.4 WiFi / 3G / 4G Antenna Installation

Thread the WiFi / 3G / 4G antenna cable through an antenna hole. Then fasten the antenna as shown below.

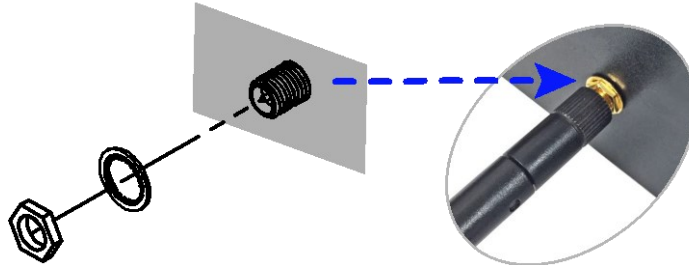

Info: The diameter of the nut is around 6.35 mm (0.25"-36UNC).

2.1.5 Side Bracket Installation

Use the screws provided in the accessory kit to attach the side bracket to the case.

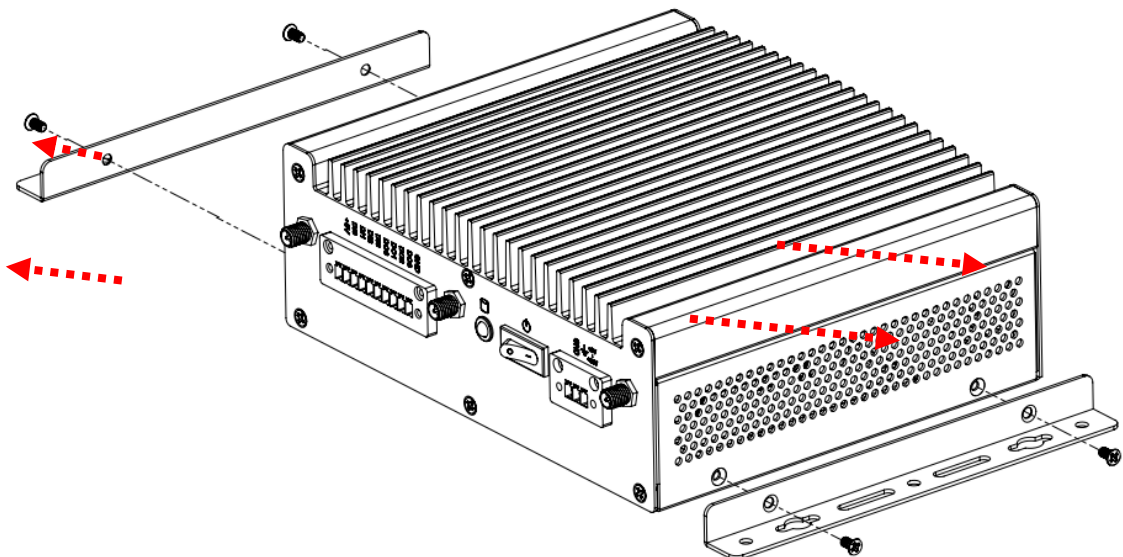

2.1.6 Pinout for COM Ports, DC Power & Digital I/O Connectors

- COM1 RS232/422/485 Port

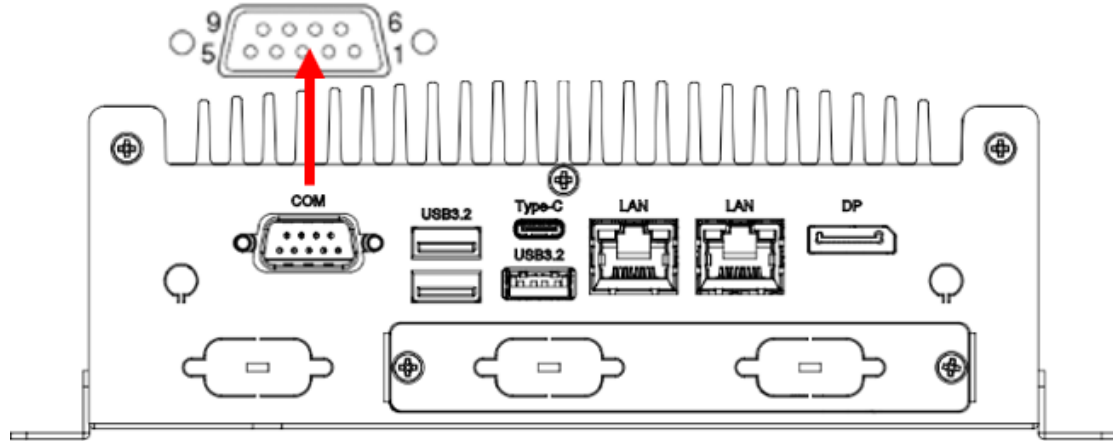

Pin	Assignment	Pin	Assignment
1	DCD, Data carrier detect	6	DSR, Data set ready
2	RXD, Receive data	7	RTS, Request to send
3	TXD, Transmit data	8	CTS, Clear to send
4	DTR, Data terminal ready	9	RI, Ring indicator
5	Ground		

Pin	Assignment		
	RS-232	RS-422	RS-485
1	DCD	TX-	DATA-
2	RX	TX+	DATA+
3	TX	RX+	NC
4	DTR	RX-	NC
5	Ground	Ground	Ground
6	DSR	NC	NC
7	RTS	NC	NC
8	CTS	NC	NC
9	RI	NC	NC

- DC Power Input Connector (terminal block)

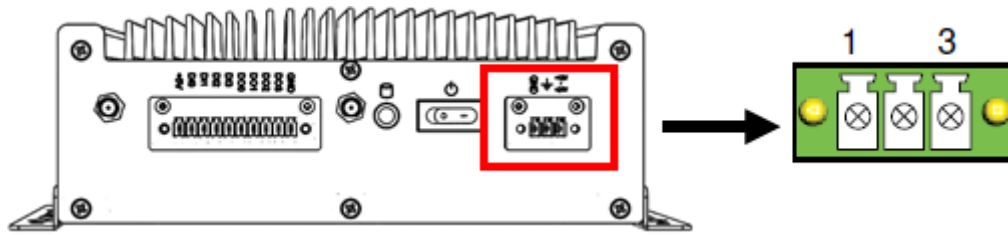

Pin	Assignment	Pin	Assignment
1	Ground	3	+12V ~ +24V
2	Chassis Ground		

- Digital I/O Connector (terminal block)

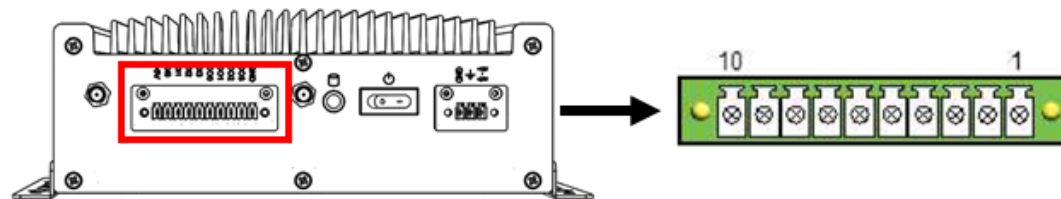

Pin	Assignment	Pin	Assignment
1	Ground	6	DI3
2	DO3	7	DI2
3	DO2	8	DI1
4	DO1	9	DI0
5	DO0	10	+5V

2.2 Setting the Jumpers

Set up and configure your product by using jumpers for various settings and features according to your needs and applications. Contact your supplier if you have doubts about the best configuration for your use.

2.2.1 How to Set Jumpers

Jumpers are short-length conductors consisting of several metal pins with a non-conductive base mounted on the circuit board. Jumper caps are used to have the functions and features enabled or disabled. If a jumper has 3 pins, you can connect either PIN1 to PIN2 or PIN2 to PIN3 by creating a short circuit.

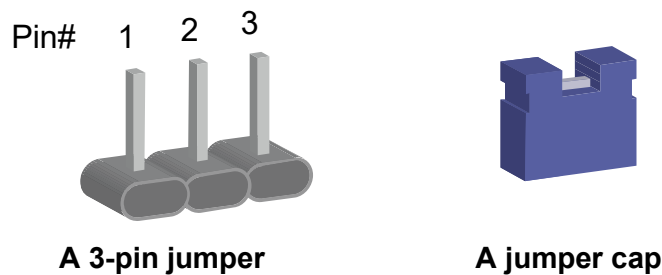

Refer to the illustration below to set jumpers.

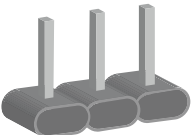
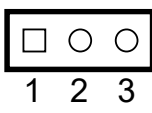
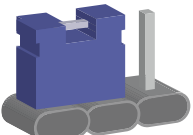
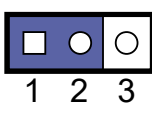
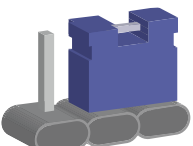
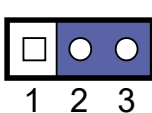
Pin closed	Oblique view	illustration
Open		 1 2 3
1-2		 1 2 3
2-3		 1 2 3

When two pins of a jumper are encased in a jumper cap, this jumper is **closed**, i.e. turned **On**. When a jumper cap is removed from two jumper pins, this jumper is **open**, i.e. turned **Off**.

2.3 Jumper & Connector Locations on the Motherboard

Motherboard: IB838

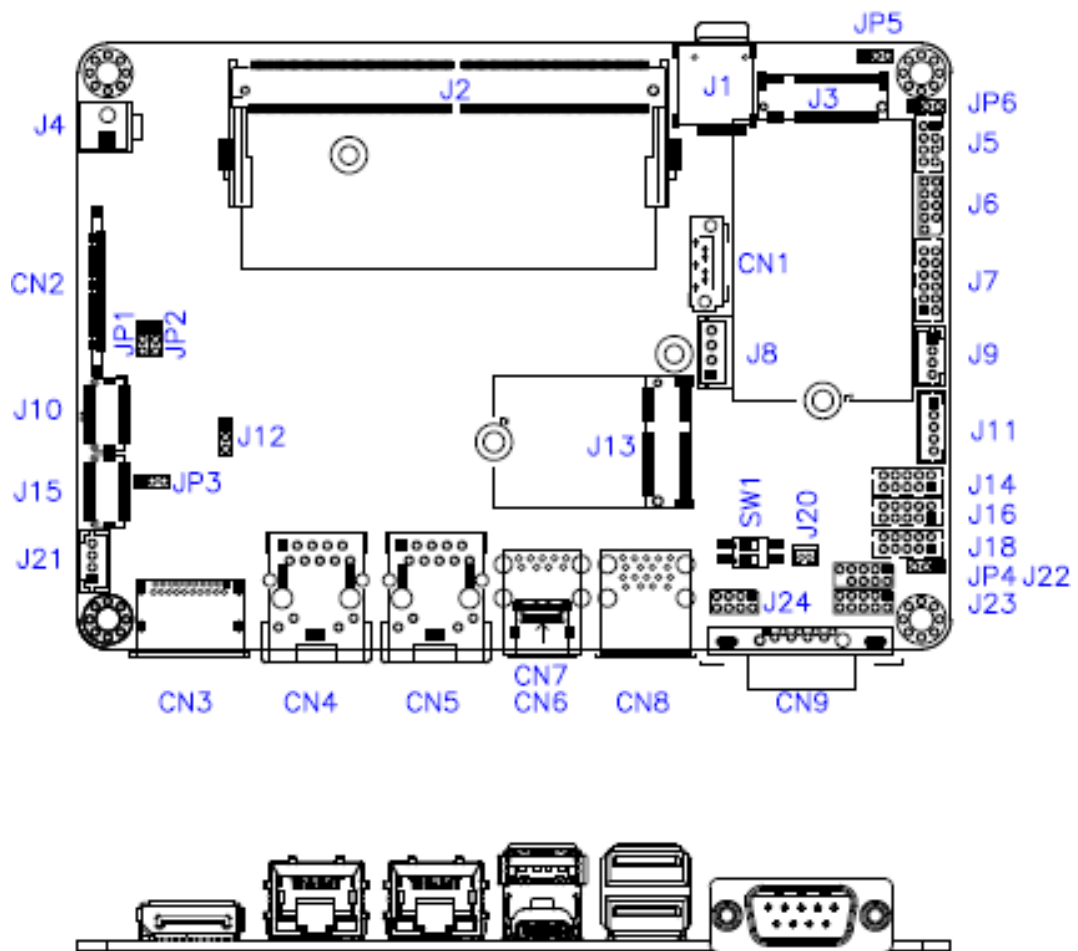

2.4 Jumpers Quick Reference

Function	Jumper
eDP Panel Power Selection	JP1
LVDS Panel Brightness Selection	JP2
LVDS Panel Power Selection	JP3
AT / ATX Selection	JP4
M.2 B-key / Sierra Module Selection	JP5
Sierra Module Interface Selection	JP6
Clear CMOS Data	SW1
Clear ME Register	SW1

2.4.1 eDP Panel Power Selection (JP1)

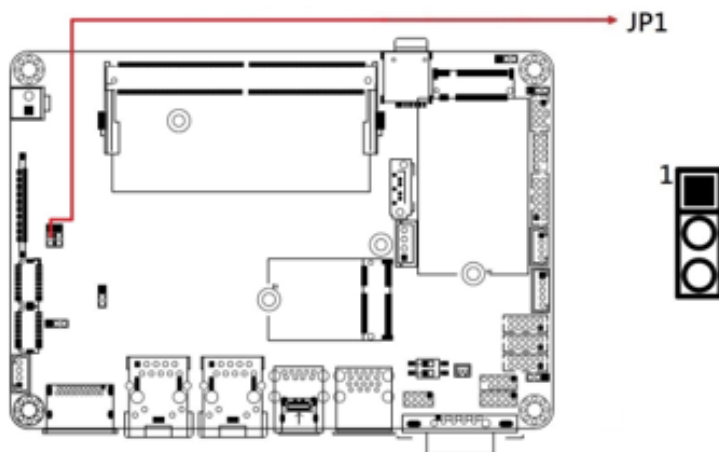



Function	Pin closed	Setting
3.3V (default)	1-2	1
5V	2-3	1

Note: This is for setting Pin1~Pin5 voltage of CN2.

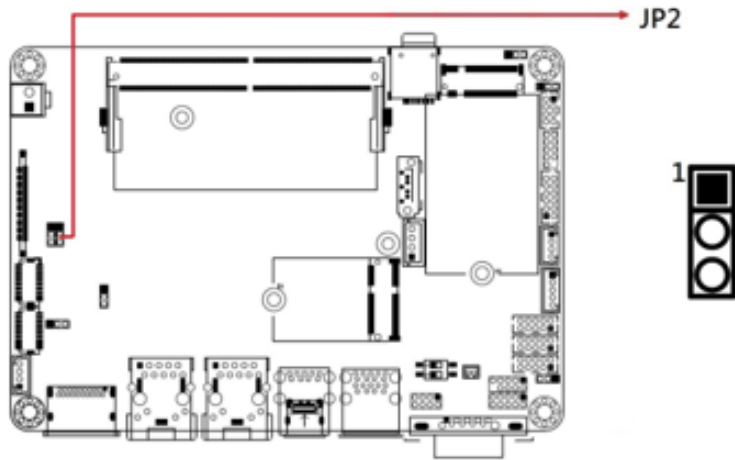
2.4.2 LVDS Panel Brightness Selection (JP2)





Function	Pin closed	Setting
3.3V (default)	1-2	1 
5V	2-3	1 

Note: This is for setting Pin3 voltage of J21.

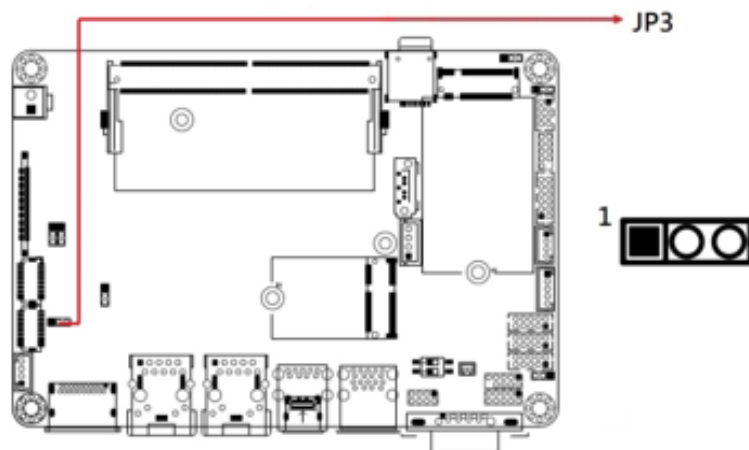
2.4.3 LVDS Panel Power Selection (JP3)



Function	Pin closed	Setting
3.3V (default)	1-2	1 
5V	2-3	1 

Note: This is for setting Pin19~Pin20 voltage of J10, J15.

2.4.4 AT / ATX Selection (JP4)

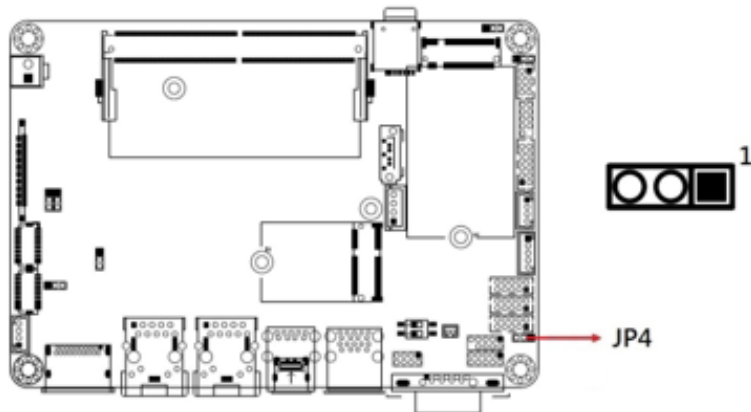

Function	Pin closed	Setting
ATX	1-2	1
AT	2-3	1

Note: AT: Auto power on; ATX: Manual power on

2.4.5 M.2 B-key / Sierra Module Selection (JP5)

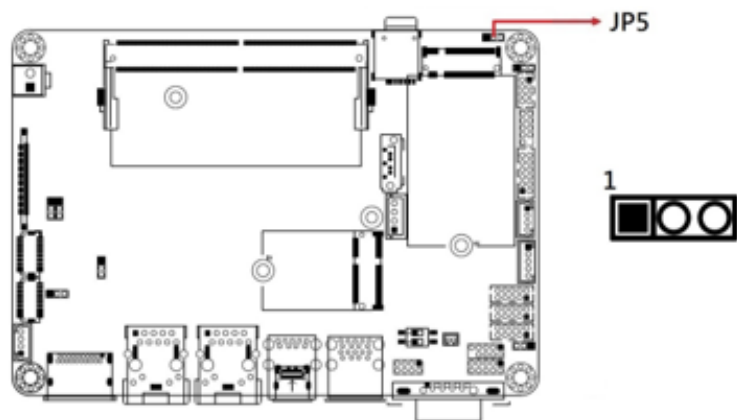

Function	Pin closed	Setting
M.2 B-key (default)	1-2	1
Sierra Module	2-3	1

Note: The setting is via J3.

2.4.6 Sierra Module Interface Selection (JP6)

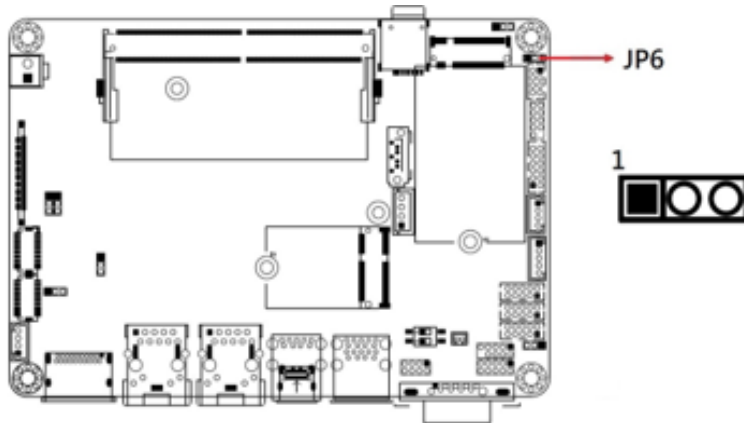

Function	Pin closed	Setting
USB	1-2	1
PCIE (default)	2-3	1

Note: The setting is via J3.

2.4.7 Clear CMOS Data (SW1)

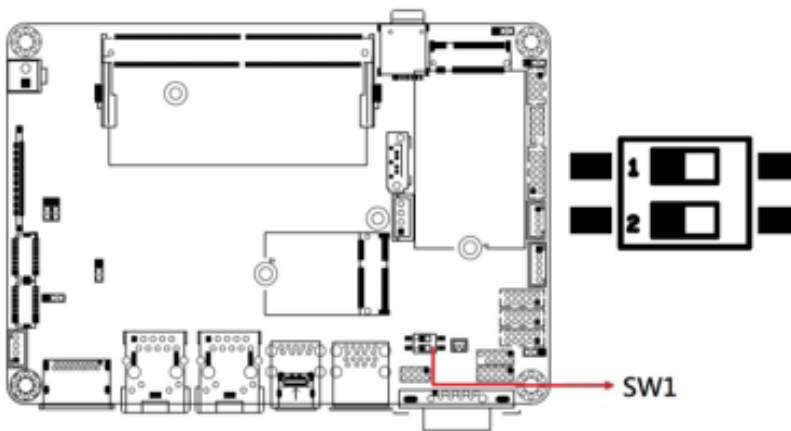

Function	Setting
Normal (default)	P1-OFF
Clear CMOS	P1-ON

2.4.8 Clear ME Register (SW1)

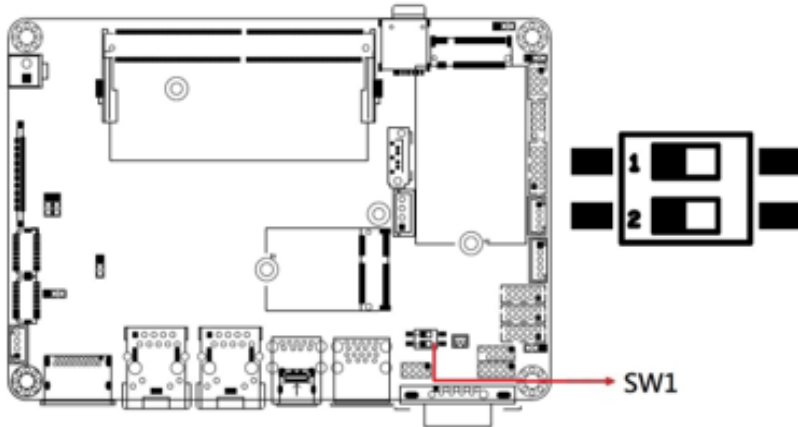

Function	Setting
Normal (default)	P2-OFF
Clear ME Register	P2-ON

2.5 Connectors Quick Reference

Function	Connector
SATA Connectors	CN1
eDP Connector	CN2
DP Connectors	CN3
LAN Connectors	CN4, CN5
USB 3.2 Connector	CN6
Type-C Connector	CN7
USB 3.2 Stack Connector	CN8
COM1 RS-232/422/485 Serial Port	CN9
Nano SIM Card Slot	J1
DDR5 SO-DIMM Connector	J2
M.2 B-Key 3052 Connector	J3
DC Power Input Connector	J4
USB 2.0 Connector	J5
SPI Flash Tool Connector	J6
Audio Connector	J7
SATA HDD Power Connector	J8
Speaker Out Connector	J9
LVDS Connectors	J10, J15
SMBUS Connector	J11
Power JTAG Connector	J12
M.2 E-Key 2230 Connector	J13
COM2, COM3, COM4 RS-232 Ports	J18, J16, J14
RTC Battery Connector	J20
LVDS Backlight Connector	J21
80 Port Debug Tool Connector	J22
Digital I/O Connector	J23
Front Panel Connector	J24

2.5.1 SATA Connectors (CN1)

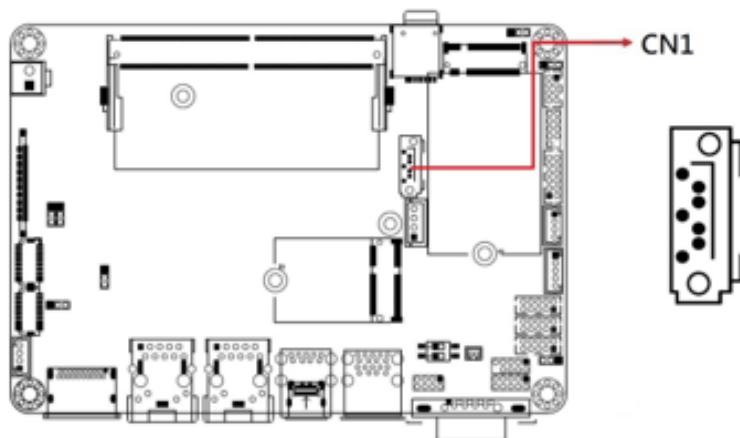

Pin	Assignment	Pin	Assignment
1	Ground	5	RX-
2	TX+	6	RX+
3	TX-	7	Ground
4	Ground		

2.5.2 eDP Connector (CN2)

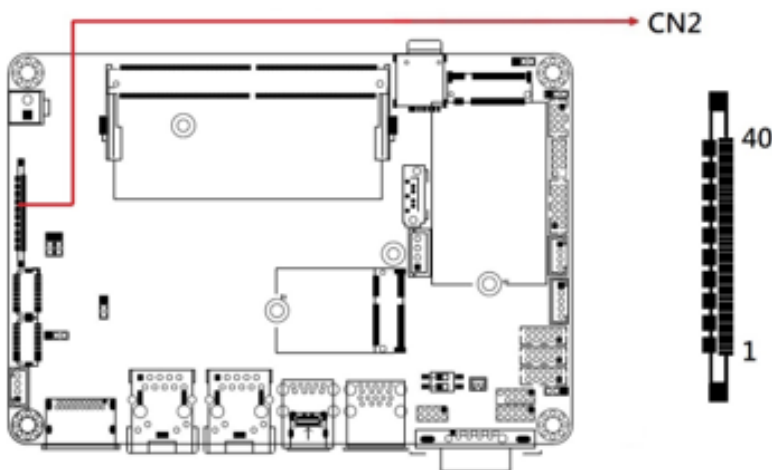

Remarks: KEL_SSL00-40S

Note: Use JP1 to set Pin1~ Pin5 voltage; Total current: 1A

Pin27, Pin36 Total current: 1A

Pin28, Pin35 Total current: 1A

Pin31 Total current: 0.5A

Pin	Assignment	Pin	Assignment
1	eDP Vcc	21	TXN0
2	eDP Vcc	22	TXP1
3	eDP Vcc	23	Ground
4	eDP Vcc	24	AUXP
5	eDP Vcc	25	AUXN
6	Ground	26	NC
7	Ground	27	+3.3V
8	Ground	28	EDP BKLT (+12V)
9	Ground	29	NC
10	Hot Plug detect	30	Ground
11	Ground	31	+5V
12	TXN3	32	NC
13	TXP3	33	Back Light Control
14	Ground	34	Back Light Enable
15	TXN2	35	EDP BKLT (+12V)
16	TXP2	36	+3.3V
17	Ground	37	Ground
18	TXN1	38	NC
19	TXP1	39	NC
20	Ground	40	NC

2.5.3 DP Connectors (CN3)

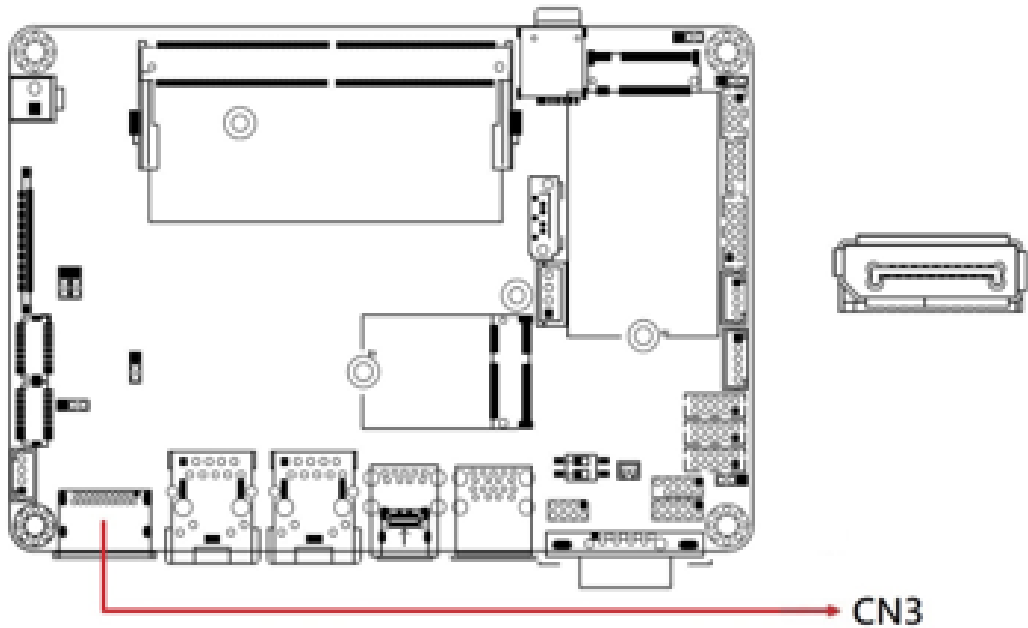

Pin	Assignment	Pin	Assignment
1	LAN0_P	11	GND
2	GND	12	LAN3_N
3	LAN0_N	13	CONFIG
4	LAN1_P	14	GND
5	GND	15	AUXP
6	LAN1_N	16	GND
7	LAN2_P	17	AUXN
8	GND	18	Hot Plug
9	LAN2_N	19	GND
10	LAN3_P	20	+3.3V/0.5A

2.5.4 LAN Connectors (CN4, CN5)

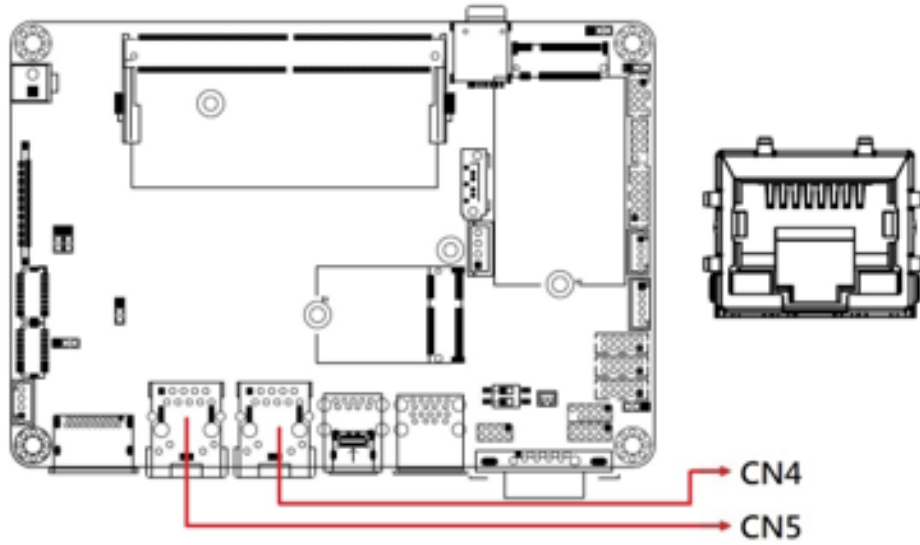

2.5.5 USB 3.2 Connector (CN6)

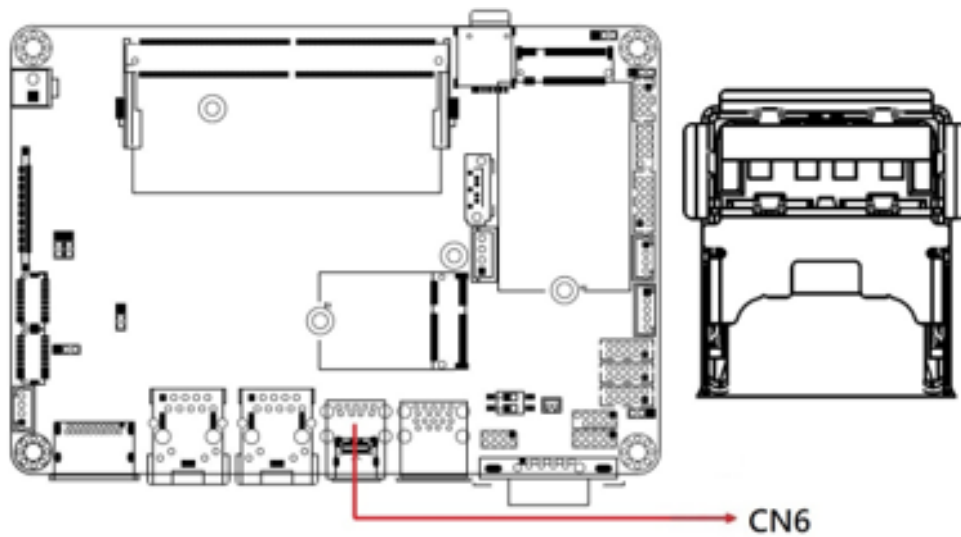

2.5.6 Type-C Connector (CN7)

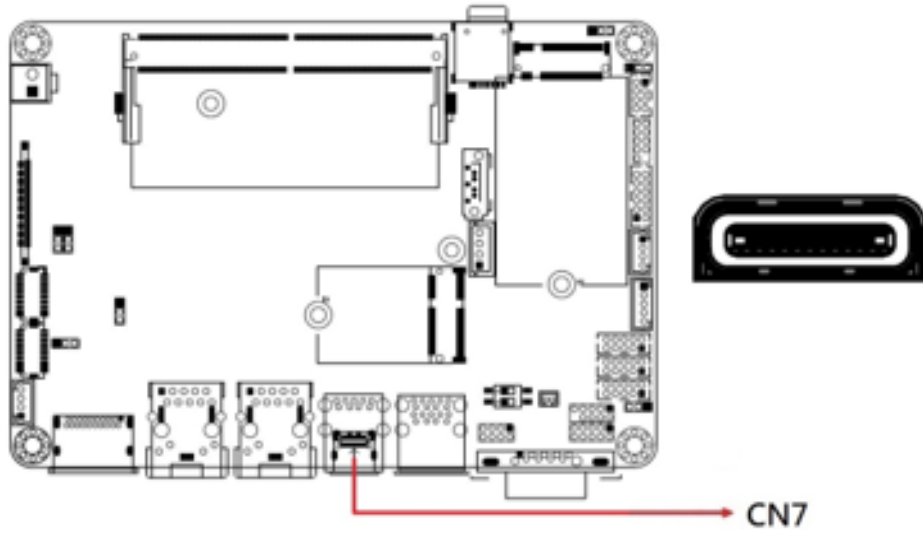

Note: DP, USB 3.2, DC Output: +5V/3A

2.5.7 USB 3.2 Stack Connector (CN8)

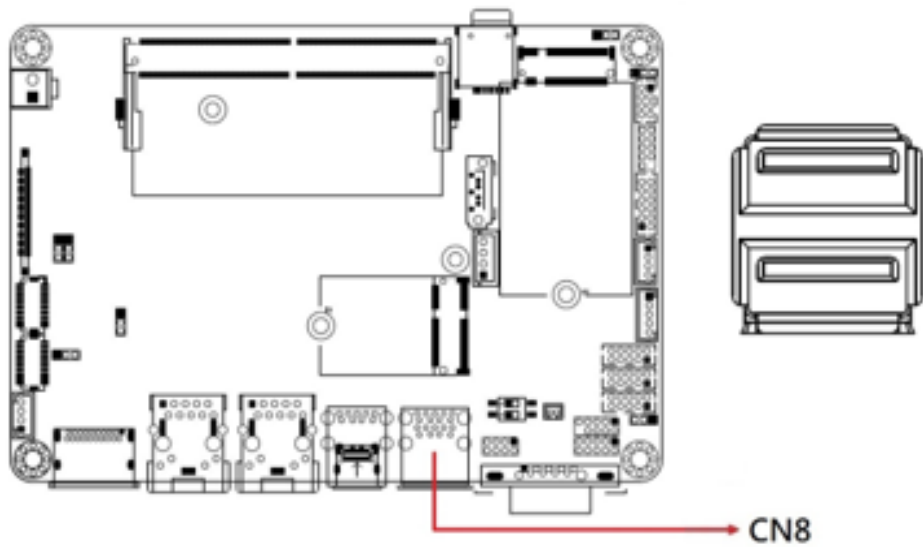

2.5.8 COM1 RS-232/422/485 Serial Port (CN9)

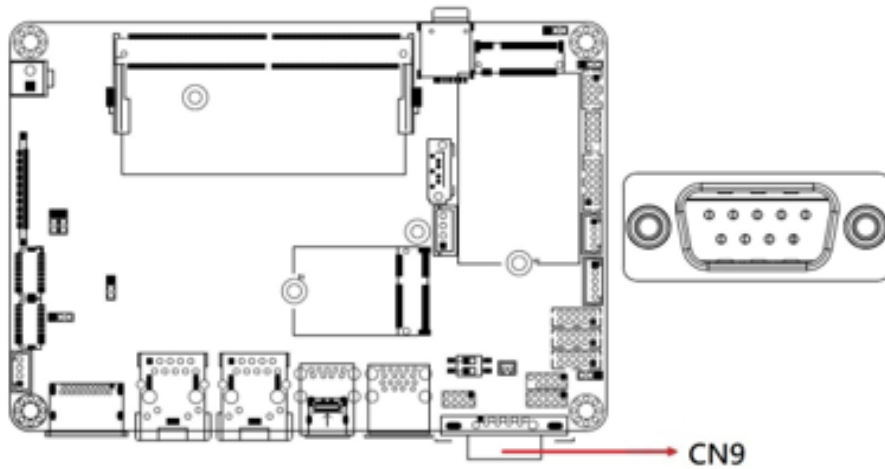

**COM1 port is jumper-less and configurable in BIOS.*

Pin	Assignment	Pin	Assignment
1	DSR, Data set ready	6	DCD, Data carrier detect
2	Ground	7	DTR, Data terminal ready
3	Ground	8	CTS, Clear to send
4	TX, Transmit	9	RTS, Request to send
5	RX, Receive	10	RI, Ring Indicator

Pin	Assignment		
	RS-232 (default)	RS-422	RS-485
1	DSR	NC	NC
2	Ground	Ground	Ground
3	Ground	Ground	Ground
4	TX	RX+	NC
5	RX	TX+	Data+
6	DCD	TX-	Data-
7	DTR	RX-	NC
8	CTS	NC	NC
9	RTS	NC	NC
10	RI	NC	NC

2.5.9 Nano SIM Card Slot (J1)

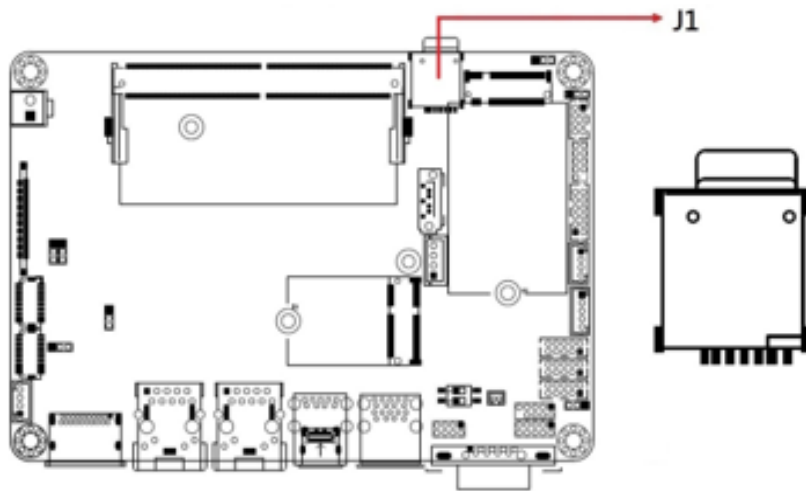

2.5.10 DDR5 SO-DIMM Connector (J2)

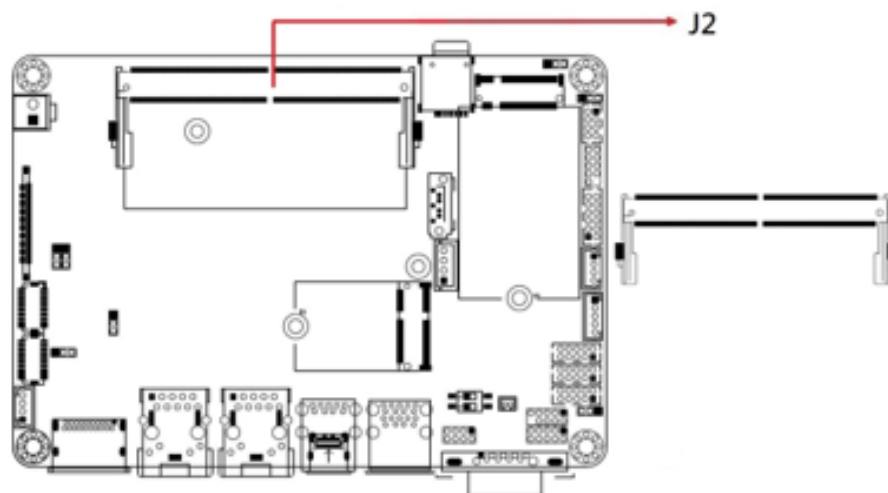

2.5.11 M.2 B-Key 3052 Connector (J3)

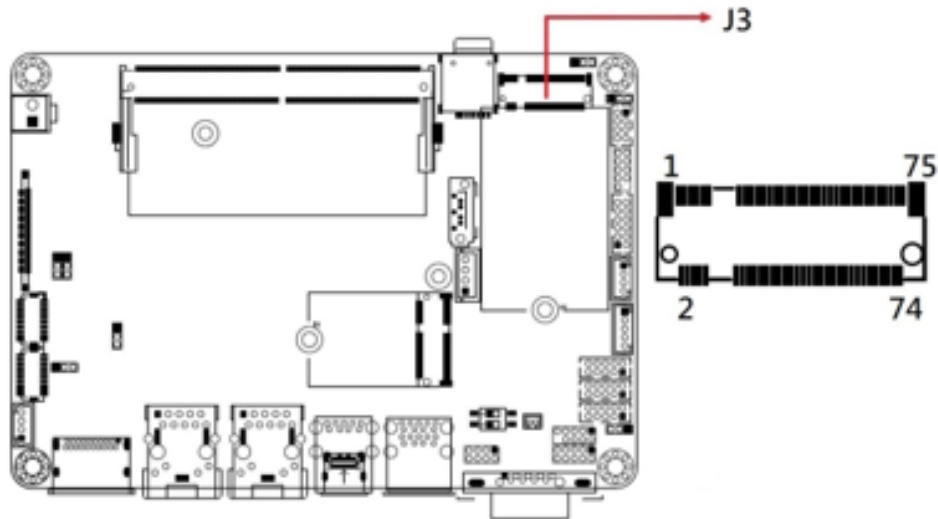

**With sierra LTE card, USB/PCIE I/F is configurable by JP5, JP6.*

2.5.12 DC Power Input Connector (J4)

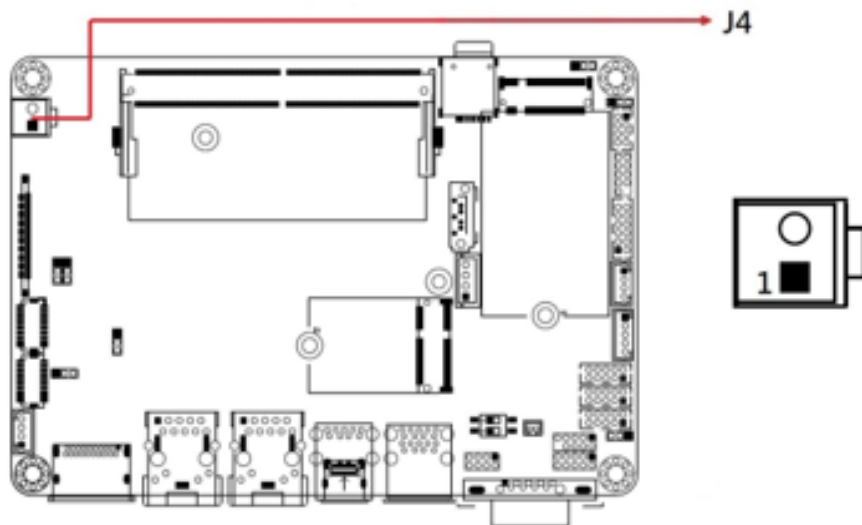

Pin	Assignment
1	+9V ~ +36V
2	Ground

2.5.13 USB 2.0 Connector (J5)

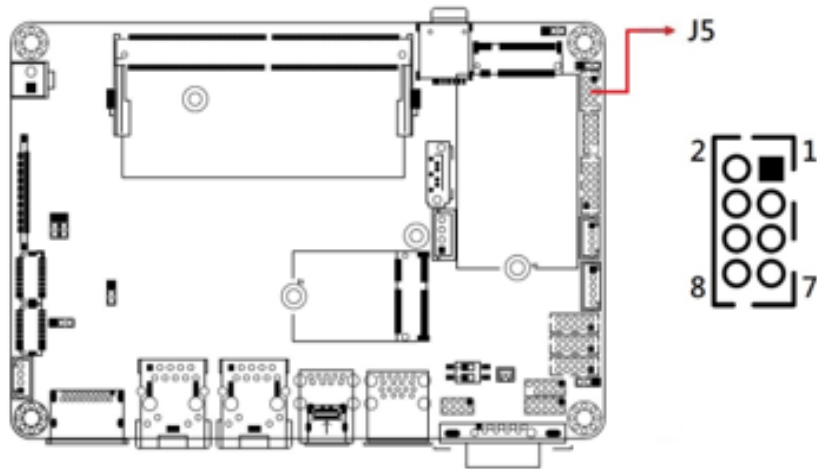

Remarks: HK_DF11-8S-PA66H

Pin	Assignment	Pin	Assignment
1	+5V/0.5A	2	Ground
3	Data-	4	Data+
5	Data+	6	Data-
7	Ground	8	+5V/0.5A

2.5.14 SPI Flash Tool Connector (J6)

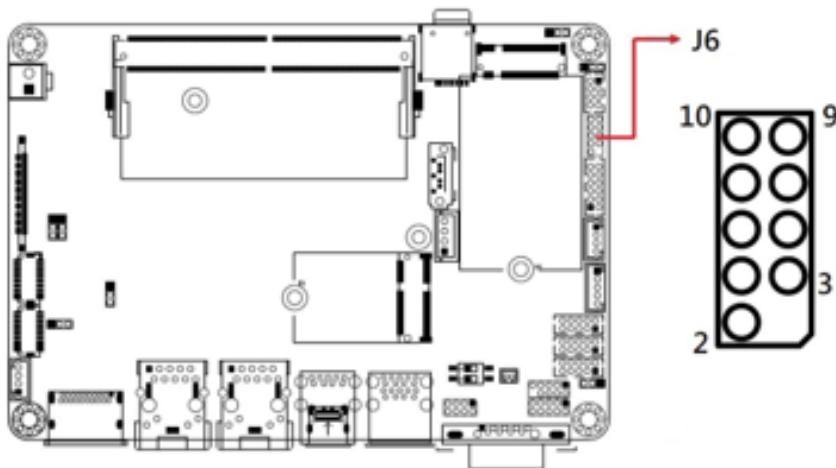

Remarks: Factory use only.

2.5.15 Audio Connector (J7)

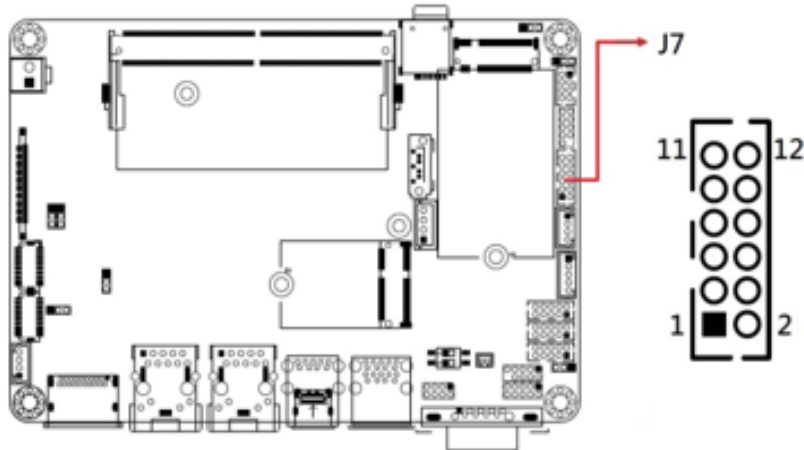

Remarks: HK_DF11-12S-PA66H

Pin	Assignment	Pin	Assignment
1	Lineout_L	2	Lineout_R
3	JD_FRONT	4	Ground
5	LINEIN_L	6	Linein_R
7	JD_LINEIN	8	Ground
9	MIC_L	10	MIC-R
11	JD_MIC1	12	Ground

2.5.16 SATA HDD Power Connector (J8)

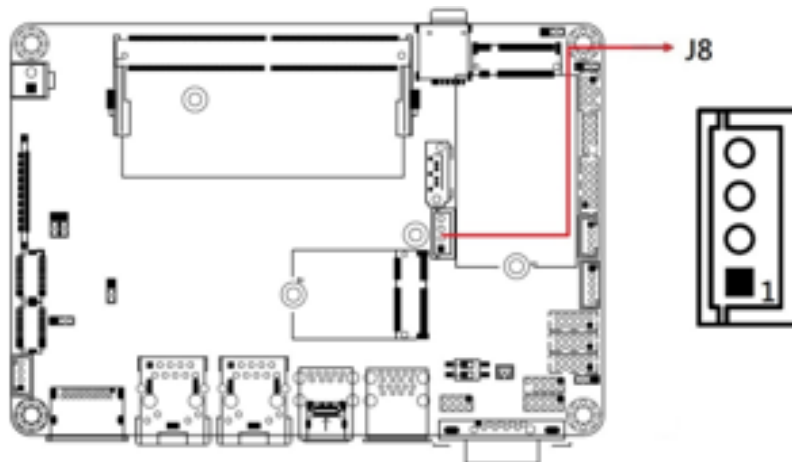

Remarks: E-CALL 0110-071-040

Pin	Assignment	Pin	Assignment
1	+5V/1A	3	Ground
2	Ground	4	+12V/1A

2.5.17 Speaker Out Connector (J9)

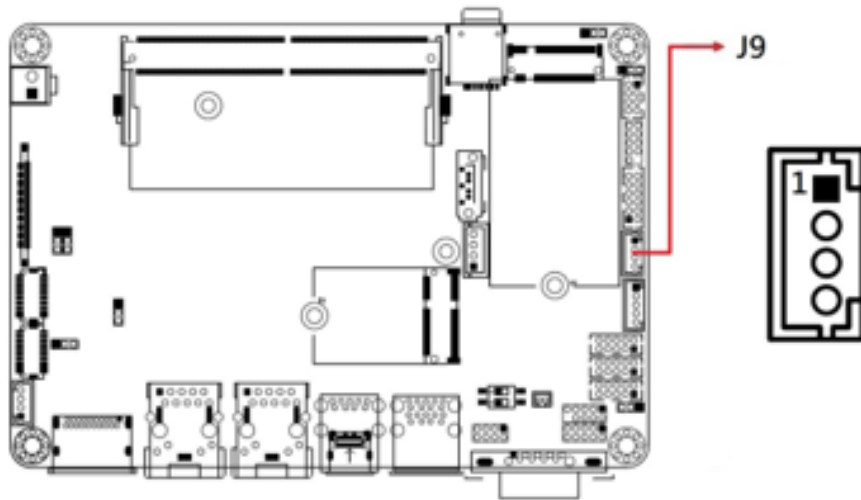

Remarks: E-CALL_0110-161-040

Pin	Assignment	Pin	Assignment
1	SPK_L+	3	SPK_R-
2	SPK_L-	4	SPK_R+

Remarks: 2.1 W/Ch Into 4 Ω at 5 V
 1.4 W/Ch Into 8 Ω at 5 V

2.5.18 LVDS Connectors (J10, J15)

** J10: Channel-A, J15: Channel-B

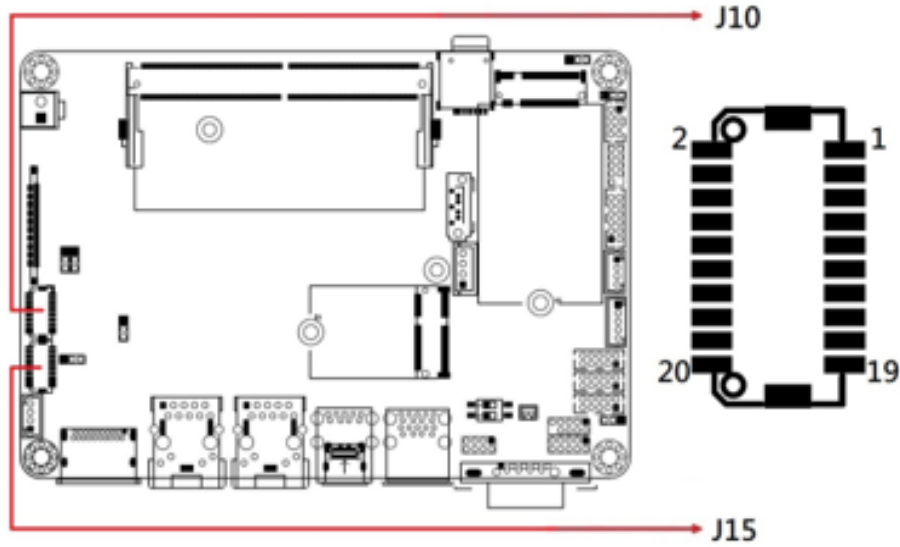

Remarks: HIROSE_DF20G-20DP-1V(56)

Note: Use JP3 to set Pin19~Pin20 voltage. Total current: 1A

Pin	Assignment	Pin	Assignment
1	TX0P	2	TX0N
3	Ground	4	Ground
5	TX1P	6	TX1N
7	Ground	8	Ground
9	TX2P	10	TX2N
11	Ground	12	Ground
13	CLKP	14	CLKN
15	Ground	16	Ground
17	TX3P	18	TX3N
19	Power	20	Power

2.5.19 SMBUS Connector (J11)

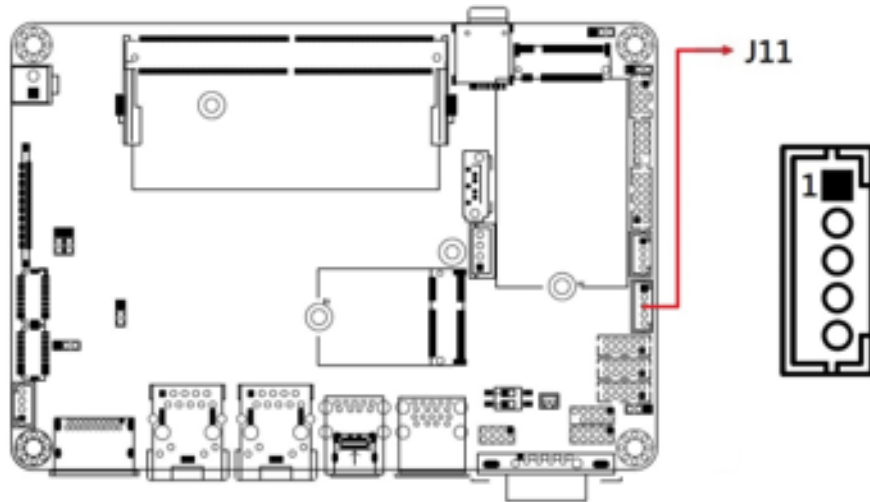

Pin	Assignment	Pin	Assignment
1	PLT_RST#	4	SMB_DATA
2	GPIO	5	SMB_CLK-
3	Ground		

2.5.20 M.2 E-Key 2230 Connector (J13)

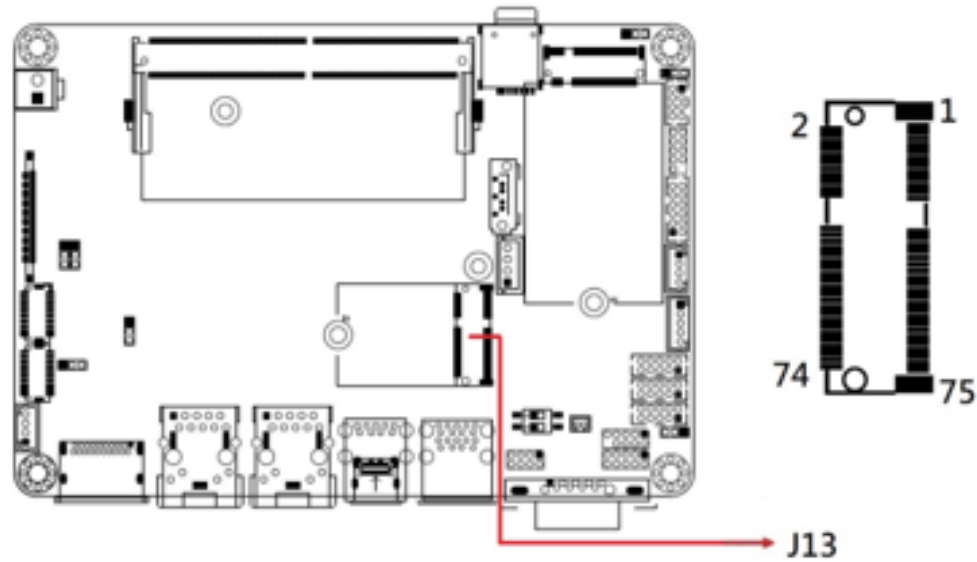

**Supports CNVI Card*

2.5.21 COM2, COM3, COM4 RS-232 Ports (J18, J16, J14)

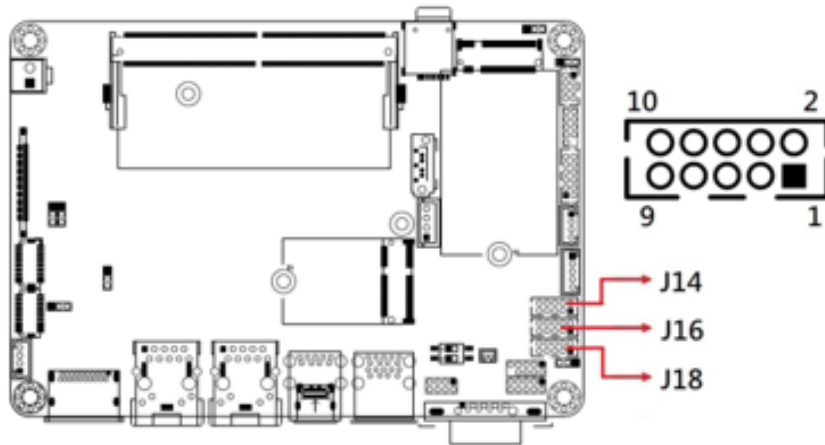

Remarks: HK_DF11-10S-PA66H

Pin	Assignment	Pin	Assignment
1	DCD, Data carrier detect	2	RXD, Receive data
3	TXD, Transmit data	4	DTR, Data terminal ready
5	Ground	6	DSR, Data set ready
7	RTS, Request to send	8	CTS, Clear to send
9	RI, Ring indicator	10	Not Used

2.5.22 RTC Battery Connector (J20)

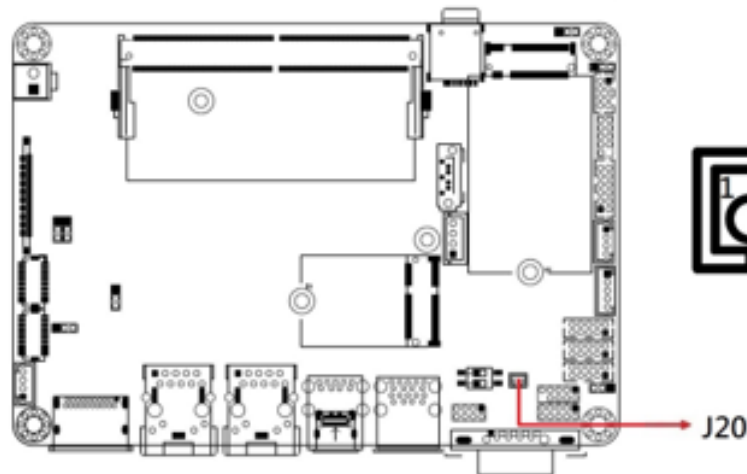

Note: Coin battery with cable.

Pin	Assignment
1	+3V
2	Ground

2.5.23 LVDS Backlight Connector (J21)

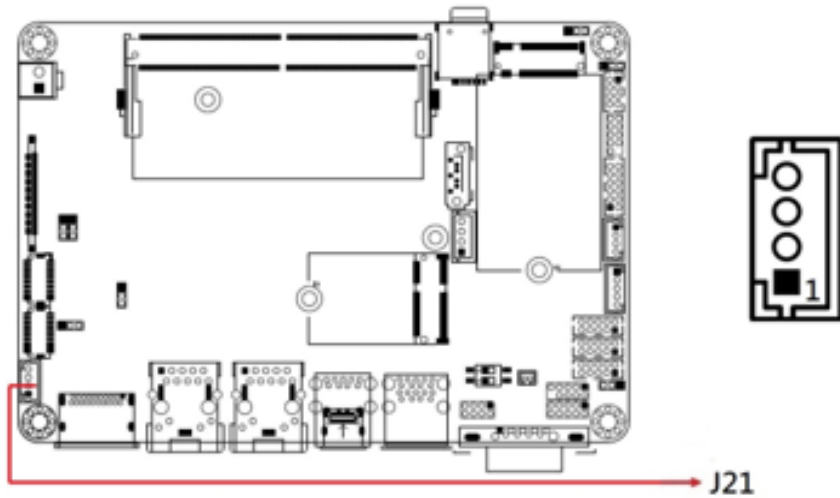

Remarks: E-CALL_0110-161-040

Note: Use JP2 to set Pin3 voltage.

Pin	Assignment	Pin	Assignment
1	+12V/1.5A	3	Brightness Control
2	Backlight Enable	4	Ground

2.5.24 80 Port Debug Tool Connector (J22)

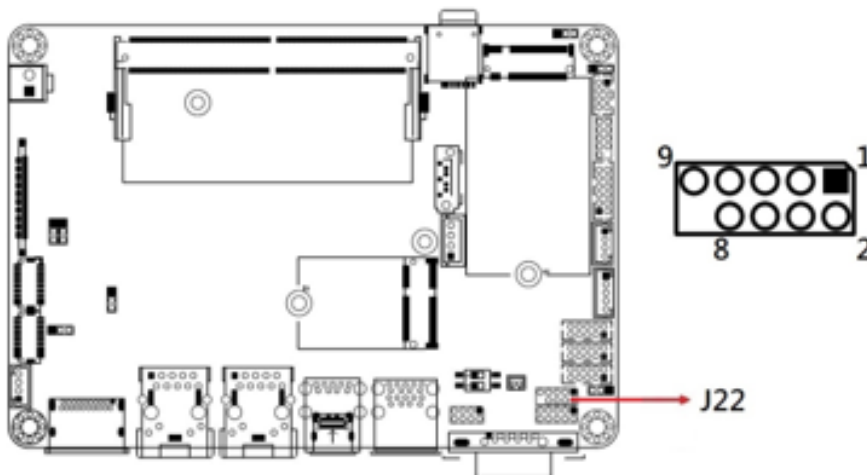

Remarks: Factory use only.

2.5.25 Digital I/O Connector (J23)

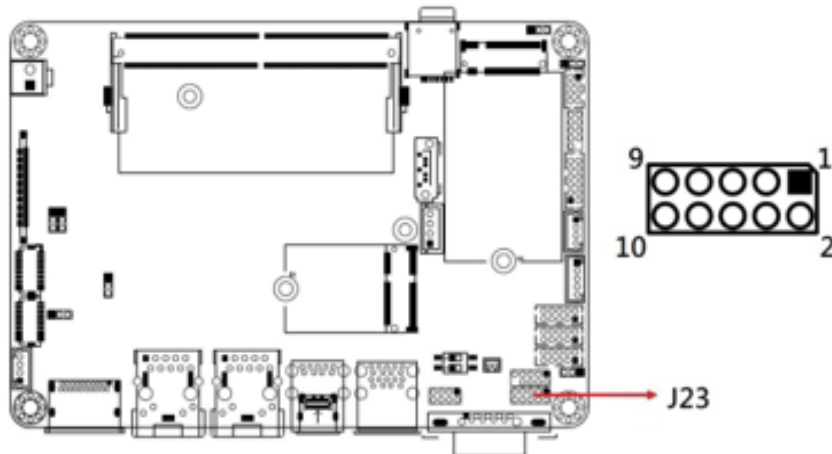

Remarks: E-CALL_0196-01-200-100

Pin	Assignment	Pin	Assignment
1	Ground	2	+5V/0.5A
3	OUT3	4	OUT1
5	OUT2	6	OUT0
7	IN3	8	IN1
9	IN2	10	IN0

2.5.26 Front Panel Setting Connector (J24)

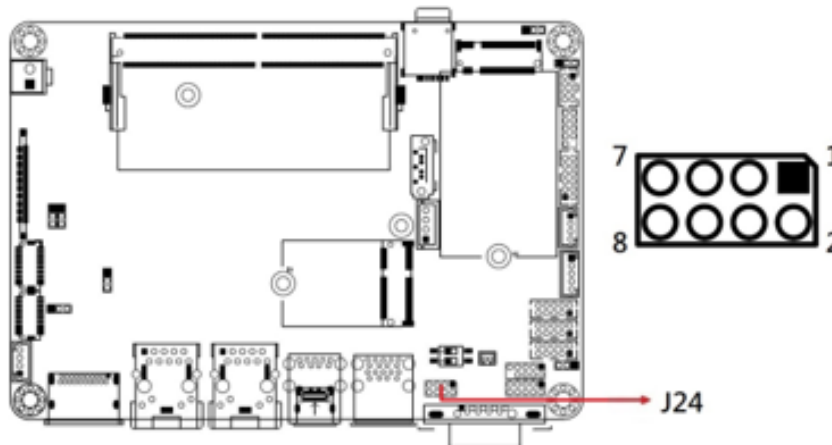

Remarks: E-CALL_0126-01-203-080

Pin	Assignment	Pin	Assignment
1	PWR_BTN-	2	PWR_BTN+
3	HDD_LED+, 3.3V	4	HDD Active
5	Ground	6	Reset
7	Power_LED+, 5V	8	Ground

Chapter 3

Driver Installation

This chapter introduces installation of the following drivers:

- Intel® Chipset Software Installation Utility
- Intel® Graphics Drivers
- Realtek HD Audio Driver
- Intel® LAN Drivers
- Intel® ME Drivers
- Intel® Serial IO Drivers

3.1 Introduction

This section describes the installation procedures for software and drivers. The software and drivers are included with the motherboard. If you find anything missing, please contact the distributor where you made the purchase. The contents of this section include the following:

Note: After installing your Windows operating system, you must install the Intel® Chipset Software Installation Utility first before proceeding with the drivers installation.

3.2 Intel® Chipset Software Installation Utility

The Intel® Chipset drivers should be installed first before the software drivers to install INF files for Plug & Play function for Intel chipset components. Follow the instructions below to complete the installation.

1. Run the drivers disk. Click Intel on the left pane and then Intel(R) AlderLake-N Chipset Drivers on the right pane.



- Click Intel(R) Chipset Software Installation Utility.



- When the Welcome screen to the Intel® Chipset Device Software appears, click Next to continue.

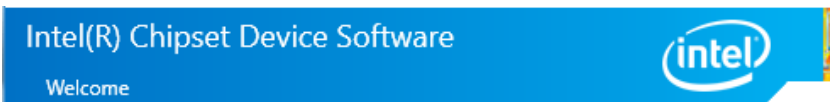

- Accept the software license agreement and proceed with the installation process.

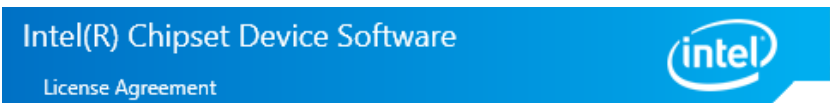

- On the Readme File Information screen, click Install.

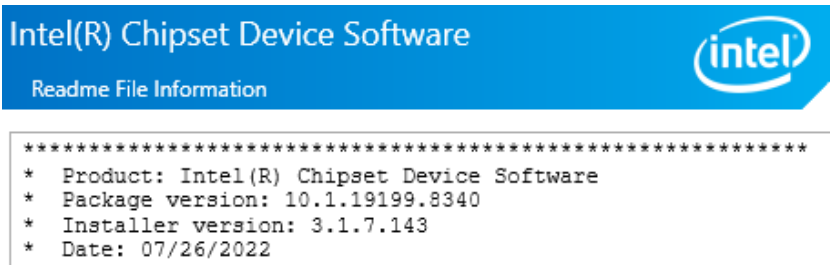

- After completing the installation, click Finish to complete the setup process.

3.3 VGA Driver Installation

1. Run the drivers disk. Click Intel on the left pane and then Intel(R) AlderLake-N Chipset Drivers on the right pane.
2. Click Intel(R) HD Graphics Driver.

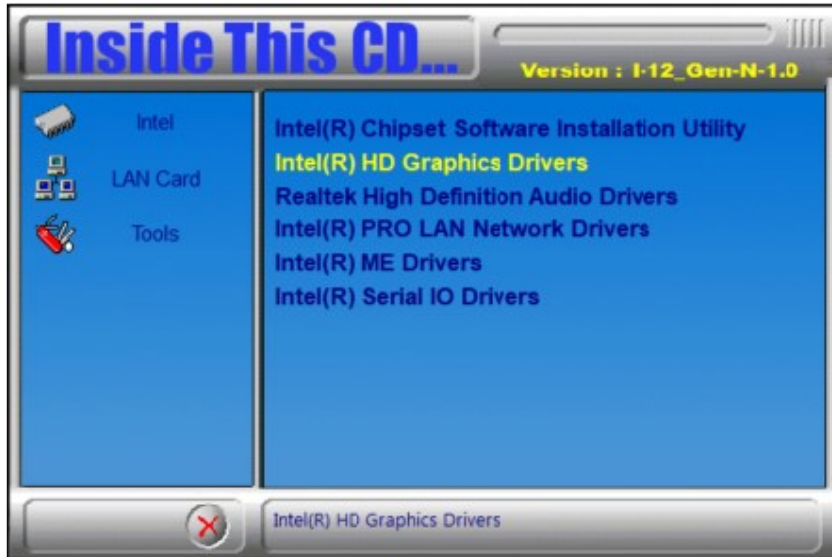

3. Click Begin installation.

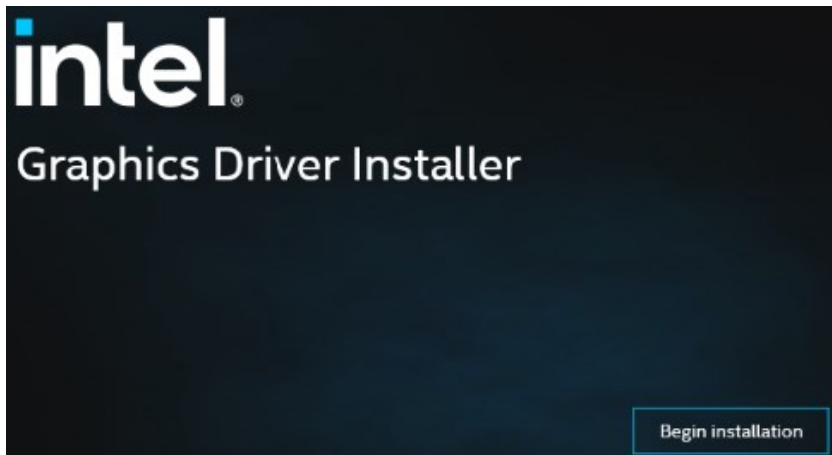

4. Click I agree to accept the license agreement.

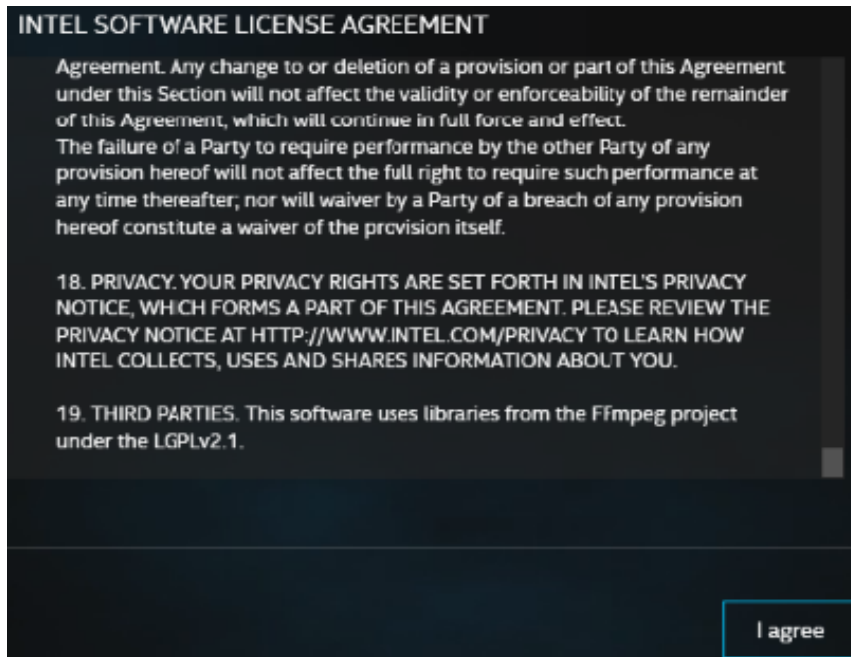

5. On the next screen, click Start and then click Finish when installation has been completed.



3.4 HD Audio Driver Installation

1. To complete the audio driver installation, go to the system's Device Manager to Update driver of the High Definition Audio Controller.

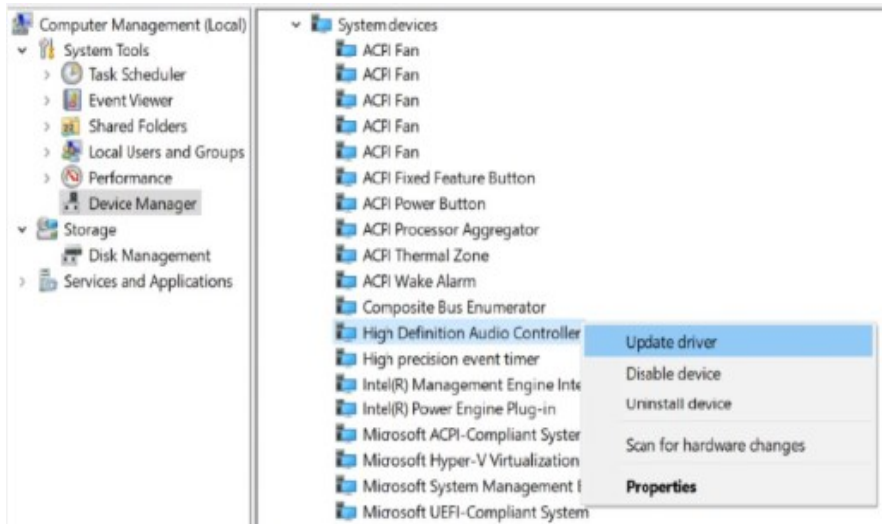

2. Locate and install the driver manually.

 Update Drivers - High Definition Audio Controller

How do you want to search for drivers?

→ Search automatically for drivers

Windows will search your computer for the best available driver and install it on your device.

→ Browse my computer for drivers

Locate and install a driver manually.



3. Go to the subfolder shown below and click Next.

 Update Drivers - High Definition Audio Controller

Browse for drivers on your computer

Search for drivers in this location:

D:\Intel\AlderLake-N\Sound



Include subfolders

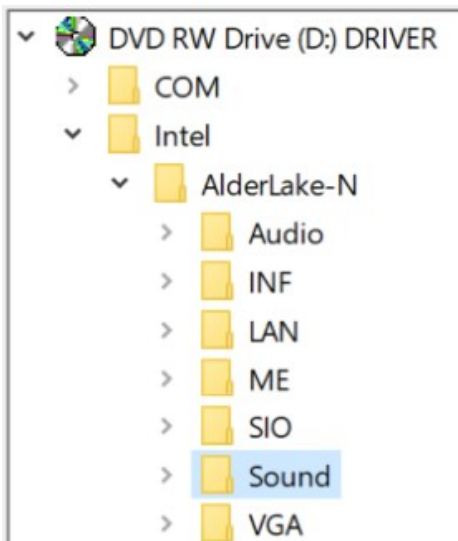

4. Windows has finished installing the drivers. Click Close.

 Update Drivers - Intel® Smart Sound Technology BUS

Windows has successfully updated your drivers

Windows has finished installing the drivers for this device:

 Intel® Smart Sound Technology BUS

5. Run the drivers disk. Click Intel on the left pane and then Intel(R) AlderLake-N Chipset Drivers on the right pane.
6. Click Realtek High Definition Audio Driver.



7. On the Welcome screen of the InstallShield Wizard, click Next.

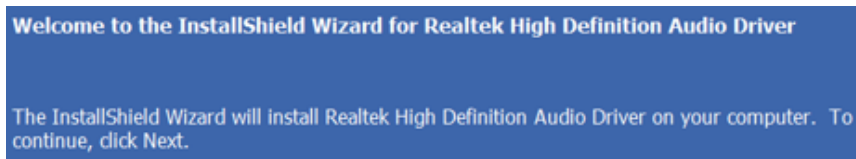

8. On the next screen, click Next.

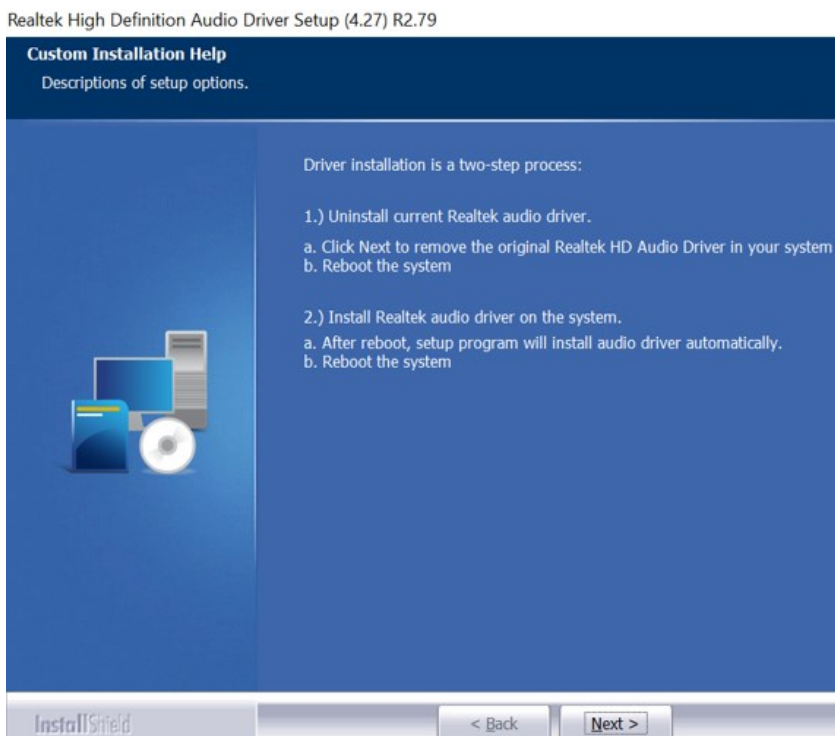

9. On the next screen, click Finish.

3.5 LAN Driver Installation

1. Run the drivers disk. Click Intel on the left pane and then Intel(R) AlderLake-N Chipset Drivers on the right pane.
2. Click Intel(R) PRO LAN Network Drivers..



3. On the Network Connections screen, click Install Drivers and Software.

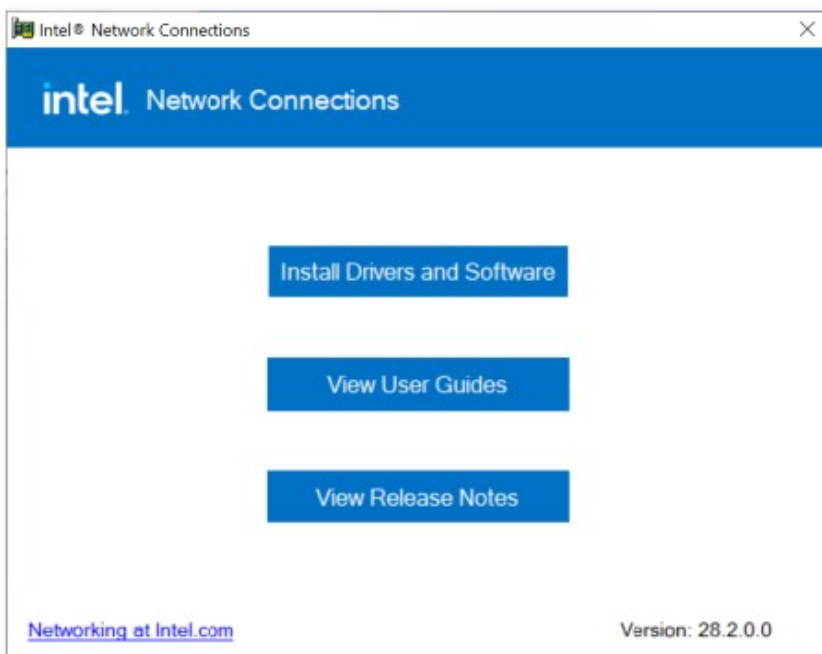

4. When the Welcome screen appears, click Next.

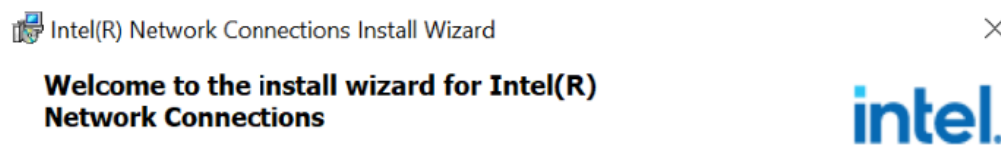

iBASE

5. On the next screen, accept the license agreement and click Next.
6. On the Setup Options screen, click Next to continue.

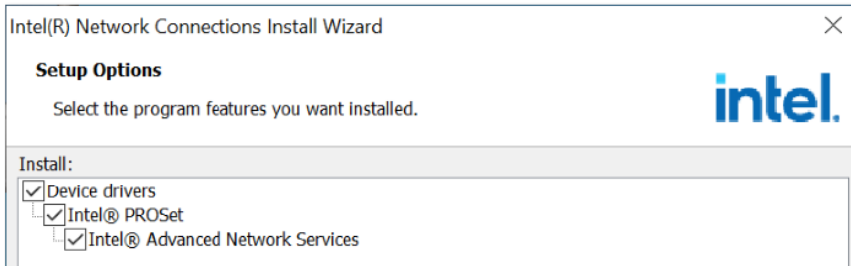

7. On the Ready to Install the Program screen, click Install.

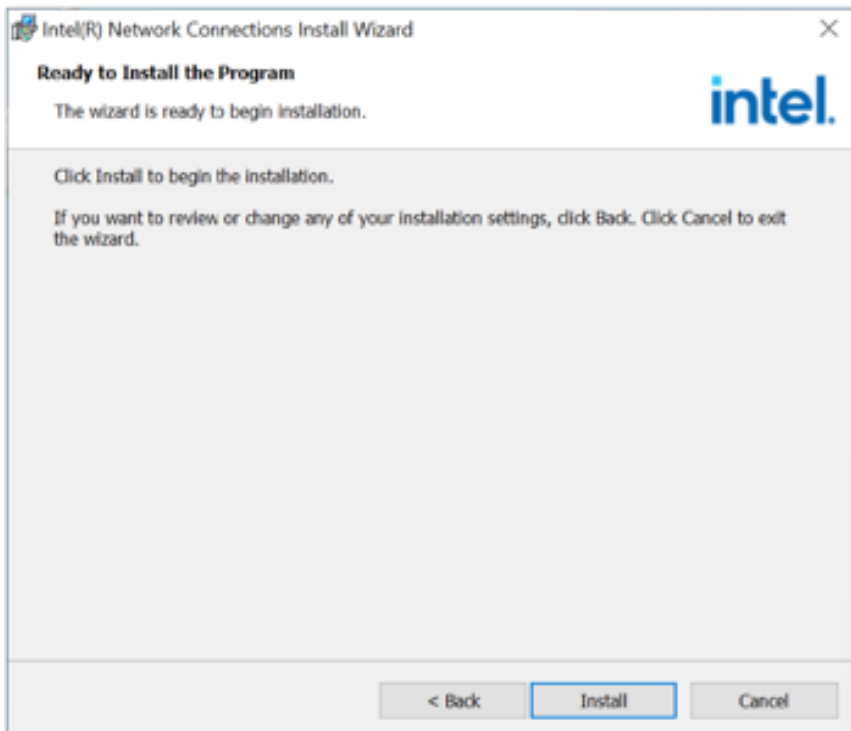

8. When the Install wizard has completed the installation, click Finish.

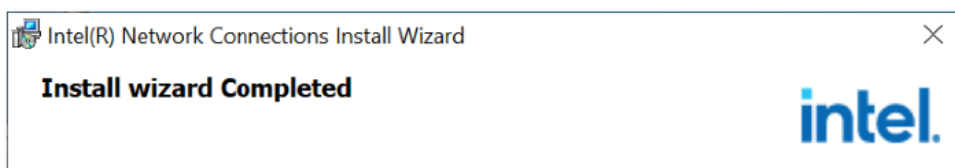

3.6 Intel® Management Engine Drivers Installation

1. Run the drivers disk. Click Intel on the left pane and then Intel(R) AlderLake-N Chipset Drivers on the right pane.
2. Click Intel(R) ME 15.x Drivers.



3. When the *Welcome* screen appears, click **Next**.

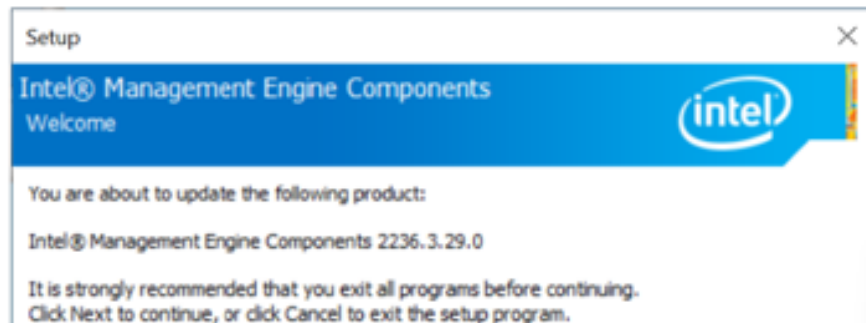

4. Accept the license agreement and click **Next**.

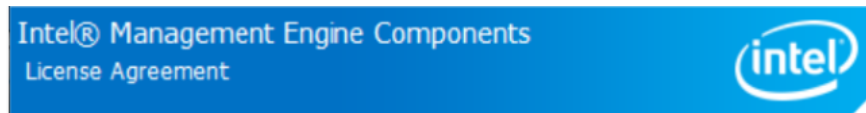

5. After Intel Management Engine Components have been successfully installed, click **Finish**.

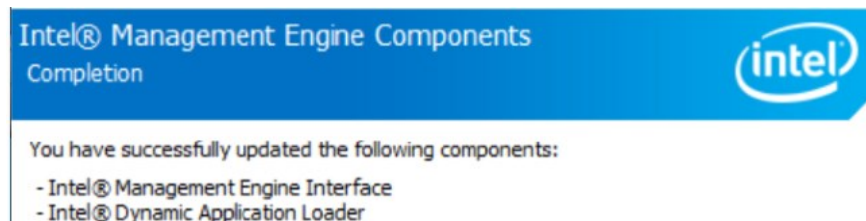

3.7 Intel(R) Serial IO Drivers Installation

1. Run the drivers disk. Click Intel on the left pane and then Intel(R) AlderLake-N Chipset **Drivers** on the right pane.
2. Click Intel(R) Serial IO Drivers Installation.



3. In the Welcome screen, click Next.

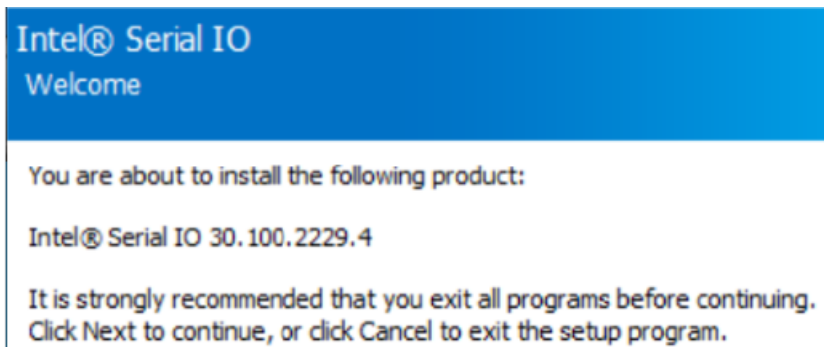

4. In the next screen, accept the license agreement and click Next.
5. In the Readme File Information screen, click Next.
6. In the Confirmation screen, click Next.

You are about to install the following components:

- Intel® Serial IO GPIO Driver
- Intel® Serial IO UART Driver

7. When installation has been completed, click Finish.



You have successfully installed the following product:

Intel® Serial IO 30.100.2229.4

Chapter 4

BIOS Setup

This chapter describes the different settings available in the AMI BIOS that comes with the board. The topics covered in this chapter are as follows:

- Main Settings
- Advanced Settings
- Chipset Settings
- Security Settings
- Boot Settings
- Save & Exit

4.1 Introduction

The BIOS (Basic Input/Output System) installed in the ROM of your computer system supports Intel® processors. The BIOS provides critical low-level support for standard devices such as disk drives, serial ports and parallel ports. It also provides password protection as well as special support for detailed fine-tuning of the chipset controlling the entire system.

4.2 BIOS Setup

The BIOS provides a Setup utility program for specifying the system configurations and settings. The BIOS ROM of the system stores the Setup utility. When you turn on the computer, the BIOS is immediately activated. Press the key immediately allows you to enter the Setup utility. If you are a little bit late pressing the key, POST (Power On Self Test) will continue with its test routines, thus preventing you from invoking the Setup.

If you still need to enter Setup, restart the system by pressing the "Reset" button or simultaneously pressing the <Ctrl>, <Alt> and <Delete> keys. You can also restart by turning the system Off and back On again.

The following message will appear on the screen:

```
Press <DEL> to Enter Setup
```

In general, press the arrow keys to highlight items, <Enter> to select, the <PgUp> and <PgDn> keys to change entries, <F1> for help, and <Esc> to quit.

When you enter the BIOS Setup utility, the *Main Menu* screen will appear on the screen. The Main Menu allows you to select from various setup functions and exit choices.

Warning: It is strongly recommended that you avoid making any changes to the chipset defaults.

These defaults have been carefully chosen by both AMI and your system manufacturer to provide the absolute maximum performance and reliability. Changing the defaults could make the system unstable and crash in some cases.

4.3 Main Settings

Aptio Setup - AMI	
Main Advanced Chipset Security Boot Save & Exit	
BIOS Version	IB838-AS002-230721
Total Memory	8192 MB
Memory Frequency	4800 MHz
System Date	[Mon 12/14/2122]
System Time	[13:58:24]

BIOS Setting	Description
System Date	Sets the date. Use the <Tab> key to switch between the date elements.
System Time	Set the time. Use the <Tab> key to switch between the time elements.

4.4 Advanced Settings

This section allows you to configure system features according to your preference.

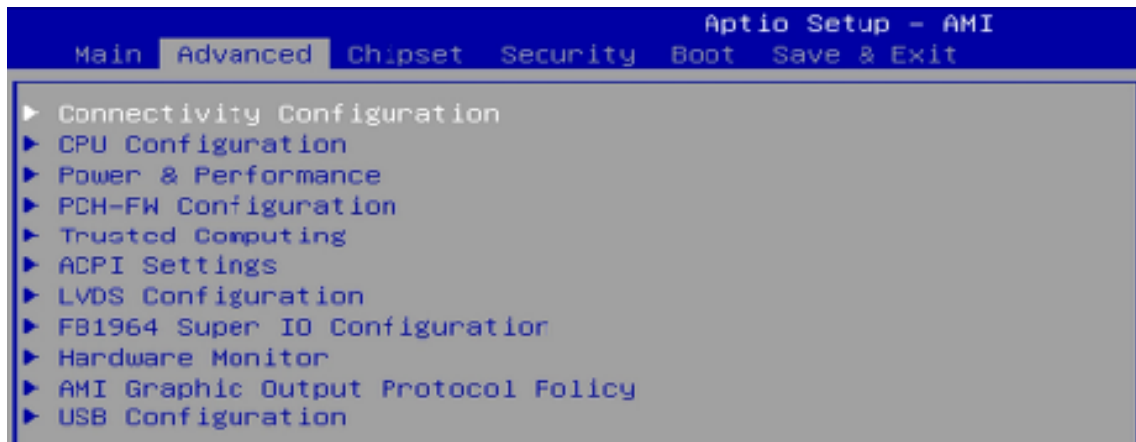

4.4.1 Connectivity Configuration

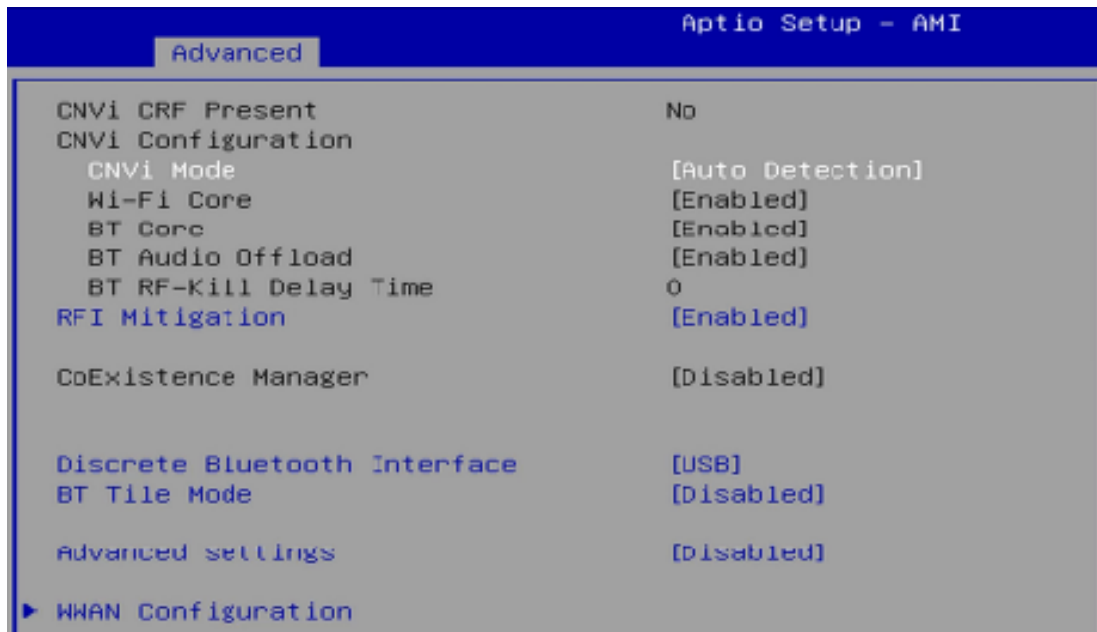

BIOS Setting	Description
CNVi Mode	This option configures Connectivity. Auto Detection – means that if Discrete solution is discovered it will be enabled by default. Otherwise Integrated solution (CNVi) will be enabled; Disable Integrated – disables Integrated Solution.
RFI Mitigation	This is an option intended to enable/disable DDR-RFIM feature for Connectivity. This feature may result in temporary slowdown of the DDR speed.
Discrete Bluetooth Interface	Serial IO UART0 needs to be enabled to select BT interface.
BT Tile Mode	Options: Enabled/Disabled
Advanced Settings	Configure ACPI objects for wireless devices Default: Disabled
WWAN Configuration	Configure WWAN related options. WWAN Device: enable or disable M.2 WWAN device

WWAN Device	[Disabled]	Select the M.2 WWAN Device options to enable 4G - 7860/7560 (Intel), 5G - M80 (MediaTek) Modems
-------------	------------	---

4.4.2 CPU Configuration

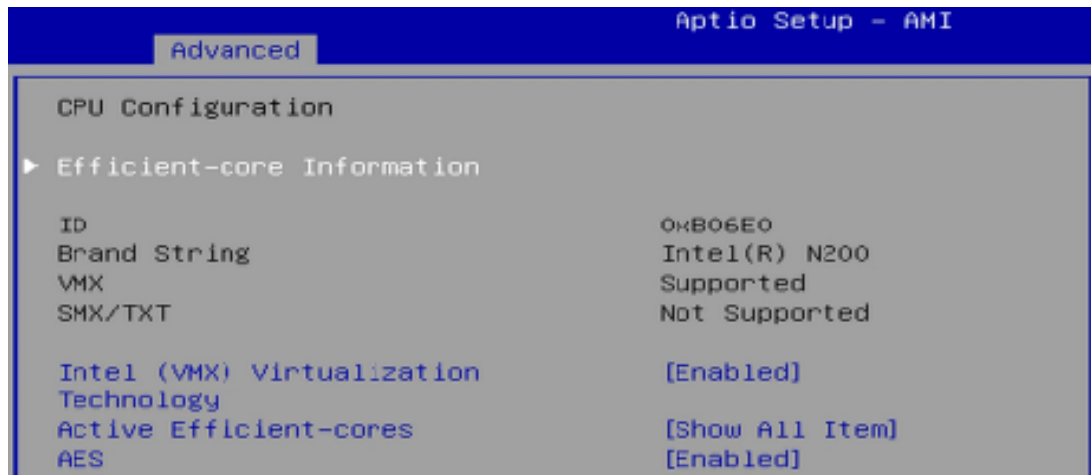

BIOS Setting	Description
Efficient-core Information	Displays the E-core Information.
Intel (VMX) Virtualization Technology	When enabled, a VMM can utilize the additional hardware capabilities provided by Vanderpool Technology.
Active Efficient-cores	Number of E-cores to enable in each processor package. Note: Number of cores and E-cores are looked at together. When both are (o,o), Pcode will enable all cores.
AES	Enable/Disable AES (Advanced Encryption Standard)

Efficient-core Information	
L1 Data Cache	32 KB × 4
L1 Instruction Cache	64 KB × 4
L2 Cache	2048 KB
L3 Cache	6 MB

4.4.3 Power & Performance

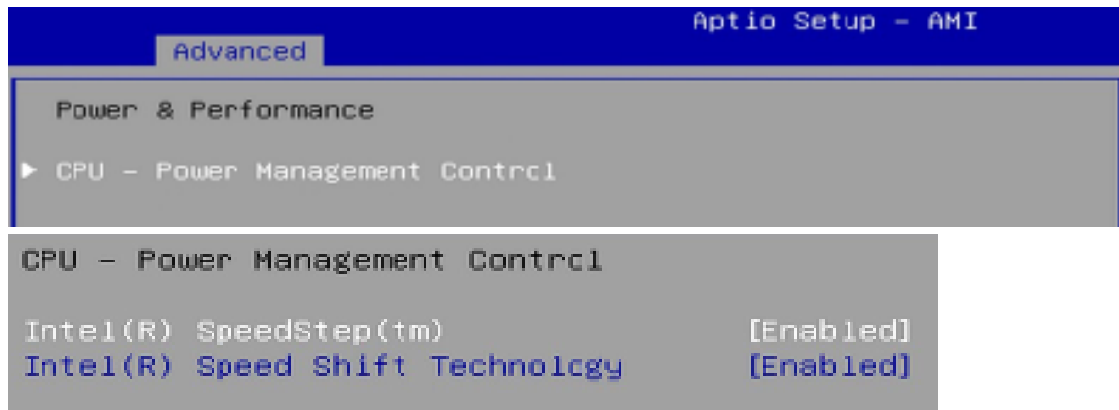

BIOS Setting	Description
CPU – Power Management Control	CPU – Power Management Control Options
Intel Speedstep	Allows more than two frequency ranges to be supported
Intel Speed Shift Technology	Enable/Disable Intel Speed Shift Technology support. Enabling will expose the CPPC v2 interface to allow for hardware controlled P-states.

4.4.4 PCH-FW Configuration

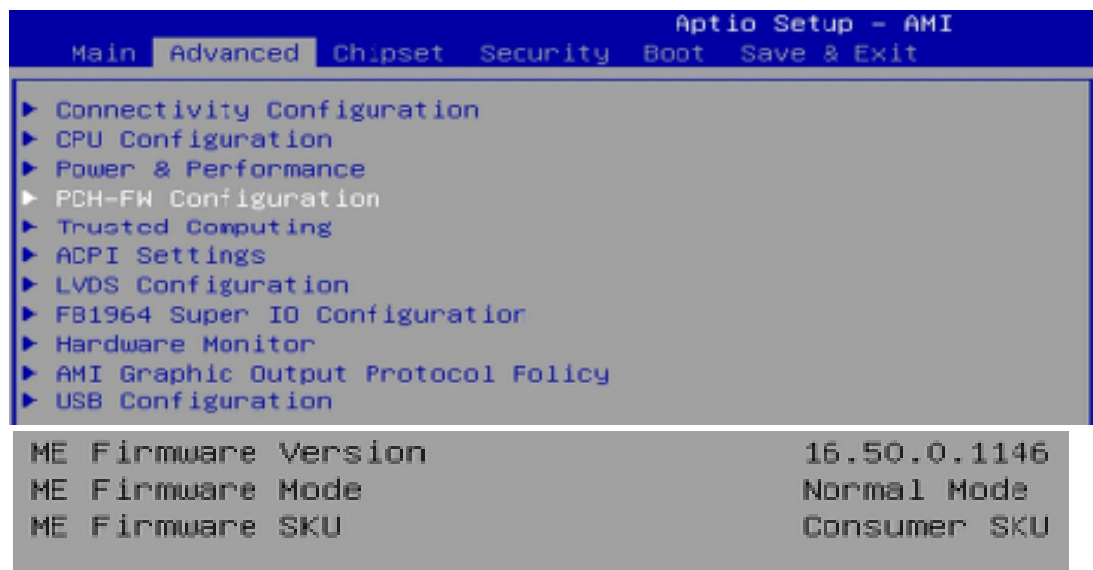

4.4.5 Trusted Computing

Advanced		Aptio Setup - AMI	
TPM 2.0 Device Found			
Firmware Version:		600.18	
Vendor:		INTC	
Security Device Support		[Enable]	
Active PCR banks		SHA256	
Available PCR banks		SHA256,SHA384,SM3	
SHA256 PCR Bank		[Enabled]	
SHA384 PCR Bank		[Disabled]	
SM3_256 PCR Bank		[Disabled]	
Pending operation		[None]	
Platform Hierarchy		[Enabled]	
Storage Hierarchy		[Enabled]	
Endorsement Hierarchy		[Enabled]	
Physical Presence Spec Version		[1.3]	
TPM 2.0 InterfaceType		[CRB]	
Device Select		[Auto]	

BIOS Setting	Description
Security Device Support	Enables / Disables BIOS support for security device. OS will not show security device. TCG EFI protocol and INT1A interface will not be available.
SHA256 PCR Bank	Options: Enabled / Disabled
SHA384 PCR Bank	Options: Enabled / Disabled
SM3_256 PCR Bank	Options: Enabled / Disabled
Pending operation	Schedule an operation for the security device. Note: Your computer will reboot during restart in order to change state of security device.
Platform Hierarchy	Enables / Disables platform hierarchy.
Storage Hierarchy	Enables / Disables storage hierarchy.
Endorsement Hierarchy	Enables / Disables endorsement hierarchy.
Physical Presence Spec Version	Select to tell O.S. to support PPI Spec Version 1.2 or 1.3. Note some HCK tests might not support 1.3.
Device Select	TPM 1.2 will restrict support to TPM 1.2 devices. TPM 2.0 will restrict support to TPM 2.0 devices. Auto will support both with the default set to TPM 2.0 devices if not found, TPM 1.2 devices will be enumerated.

4.4.6 ACPI Settings



BIOS Setting		Description
Enable Hibernation		Enables / Disables the system ability to hibernate (OS/S4 Sleep State). This option may be not effective with some OS.
ACPI State	Sleep	Select the highest ACPI sleep state the system will enter when the SUSPEND button is pressed.

4.4.7 LVDS Configuration

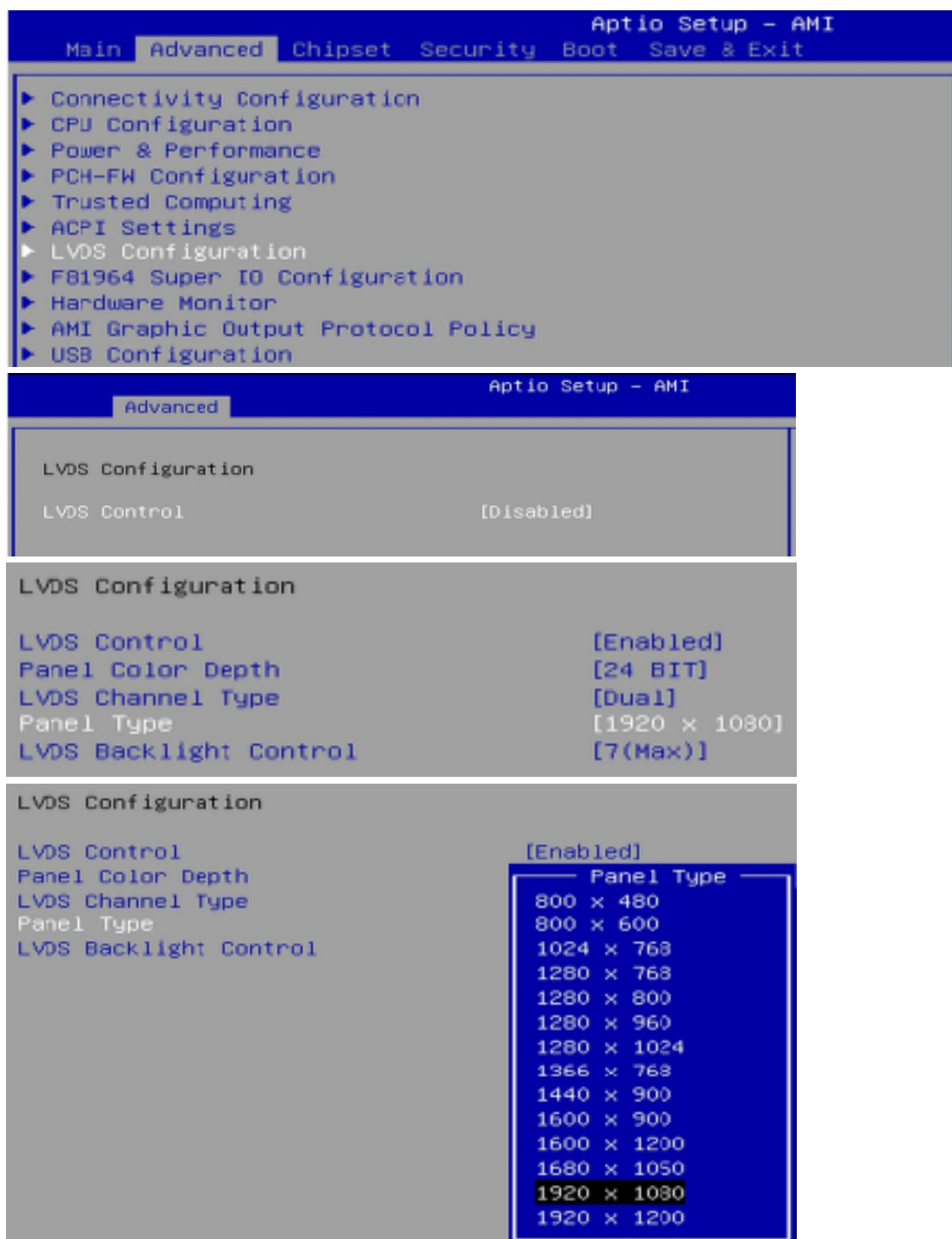

4.4.8 F81964 Super IO Configuration

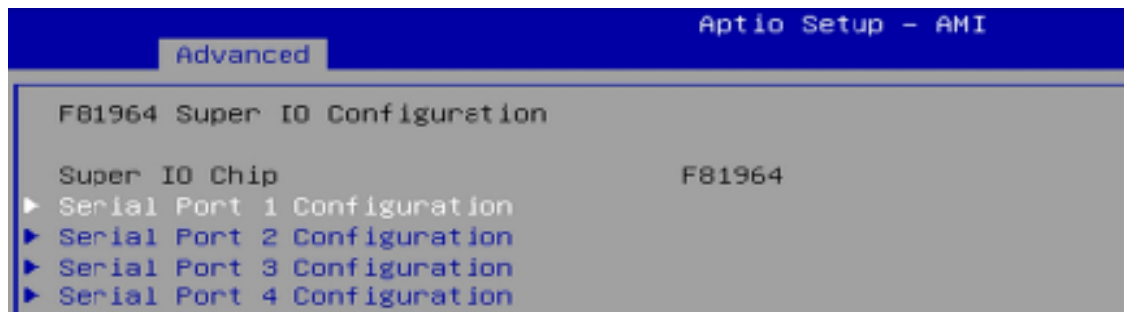

BIOS Setting	Description
Serial Port 1 Config.	Sets parameters of Serial Port 1 (COMA).
Serial Port	Enable / Disable the serial port.
Change Settings	Select an optimal setting for the Super IO device. Options are: IO=3F8h; IRQ=4; IO=3F8h; IRQ=3,4,5,6,7,9,10,11,12; IO=2F8h; IRQ=3,4,5,6,7,9,10,11,12; IO=3E8h; IRQ=3,4,5,6,7,9,10,11,12; IO=2E8h; IRQ=3,4,5,6,7,9,10,11,12;
Serial Port Mode Select	Options are: RS232, RS485, RS422
Serial Port 2 Config.	Sets parameters of Serial Port 2 (COMB).
Serial Port	Enable / Disable the serial port.
Change Settings	Select an optimal setting for the Super IO device. Options are: IO=2F8h; IRQ=3; IO=3F8h; IRQ=3,4,5,6,7,9,10,11,12; IO=2F8h; IRQ=3,4,5,6,7,9,10,11,12; IO=3E8h; IRQ=3,4,5,6,7,9,10,11,12; IO=2E8h; IRQ=3,4,5,6,7,9,10,11,12;
Serial Port 3 Config.	Sets parameters of Serial Port 3 (COM).
Serial Port	Enable / Disable the serial port.
Change Settings	Select an optimal setting for the Super IO device. Options are: IO=3E8h; IRQ=7; IO=3F8h; IRQ=3,4,5,6,7,9,10,11,12; IO=2F8h; IRQ=3,4,5,6,7,9,10,11,12; IO=3E8h; IRQ=3,4,5,6,7,9,10,11,12; IO=2E8h; IRQ=3,4,5,6,7,9,10,11,12;
Serial Port 4 Config.	Sets parameters of Serial Port 4 (COMD).
Serial Port	Enable / Disable the serial port.
Change Settings	Select an optimal setting for the Super IO device. Options are: IO=2E8h; IRQ=7; IO=3F8h; IRQ=3,4,5,6,7,9,10,11,12; IO=2F8h; IRQ=3,4,5,6,7,9,10,11,12; IO=3E8h; IRQ=3,4,5,6,7,9,10,11,12; IO=2E8h; IRQ=3,4,5,6,7,9,10,11,12;
Standby Power on S5 (Eup)	Enable – provide the standby power for devices. Disable – shutdown the standby power.

4.4.9 Hardware Monitor

Advanced		Aptio Setup - AMI	
Pc Health Status			
CPU temperature	:	+53 C	
System temperature	:	+34 C	
VIN1	:	+1.208 V	
VIN2	:	+5.087 V	
VIN3	:	+12.056 V	
VIN4	:	+1.104 V	
VCC3V	:	+3.296 V	

BIOS Setting	Description
Temperatures / Voltages	These fields are the parameters of the hardware monitoring function feature of the motherboard. The values are read-only values as monitored by the system and show the PC health status.

4.4.10 AMI Graphic Output Protocol Policy

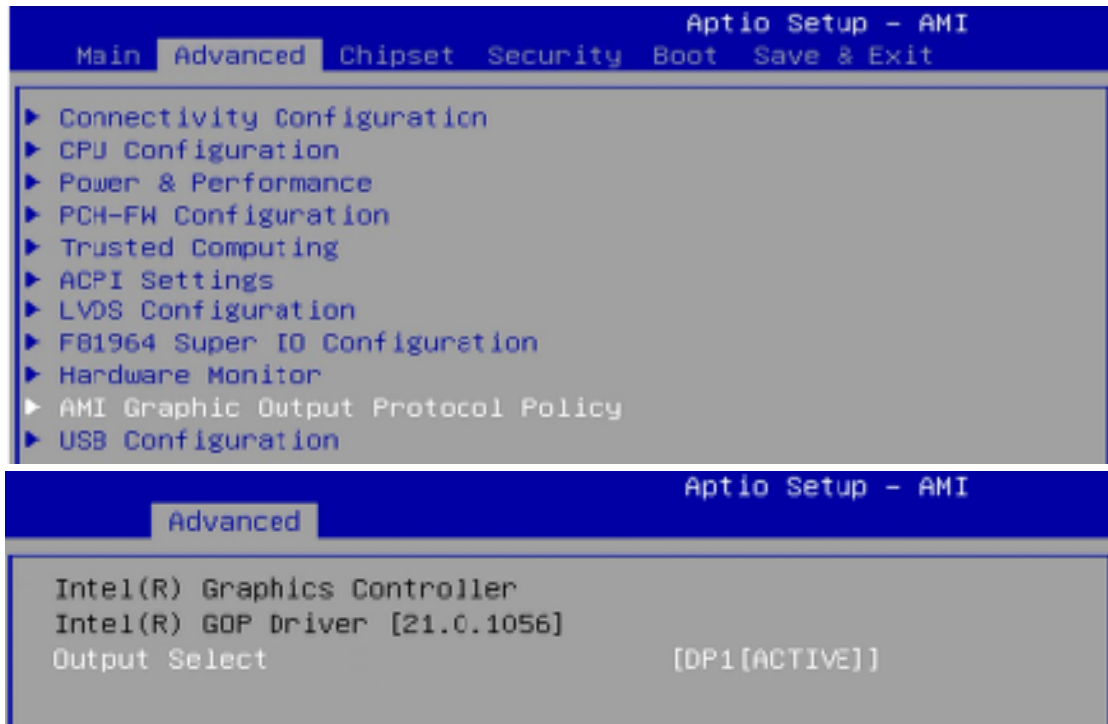

4.4.11 USB Configuration

The screenshot shows the BIOS Advanced menu with the following settings:

```

Aptio Setup - AMI
-----
Advanced
-----
USB Configuration
USB Module Version                28
USB Controllers:
  2 XHCIs
USB Devices:
  1 Keyboard, 1 Mouse

Legacy USB Support                 [Enabled]
XHCI Hand-off                     [Enabled]
USB Mass Storage Driver Support   [Enabled]

USB hardware delays and time-outs:
USB transfer time-out             [20 sec]
Device reset time-out            [20 sec]
Device power-up delay            [Auto]

```

BIOS Setting	Description
Legacy USB Support	<ul style="list-style-type: none"> • Enabled enables Legacy USB support. • Auto disables legacy support if there is no USB device connected. • Disabled keeps USB devices available only for EFI applications.
XHCI Hand-off	This is a workaround for Oses without XHCI hand-off support. The XHCI ownership change should be claimed by XHCI driver.
USB Mass Storage Driver Support	Enables / Disables the support for USB mass storage driver.
USB Transfer time-out	The time-out value (1 / 5 10 / 20 secs) for Control, Bulk, and Interrupt transfers.
Device reset time-out	USB mass storage device Start Unit command time-out
Device power-up delay	Max.time the device will take before it properly reports itself to the Host Controller. ' Auto ' uses default value: for a Root port it is 100ms, for a Hub port the delay is taken from Hub descriptor.

4.5 Chipset Settings

4.5.1 System Agent (SA) Configuration

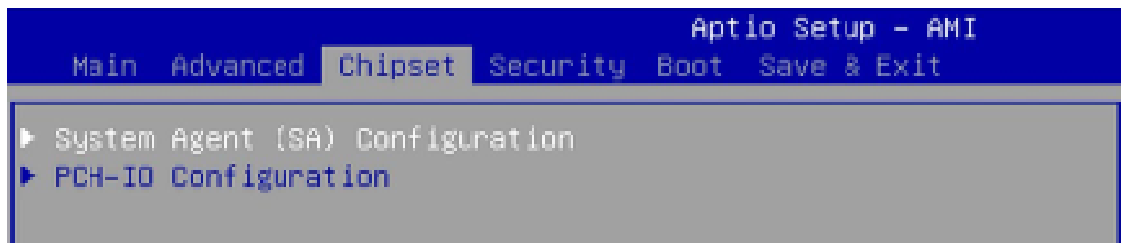

4.5.1.1. Graphics Configuration:

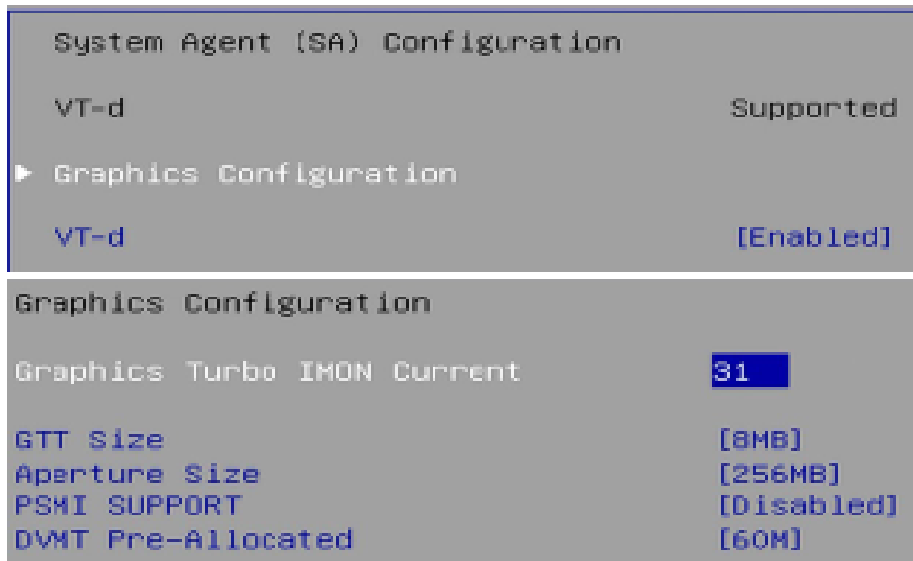

4.5.2 PCH-IO Configuration

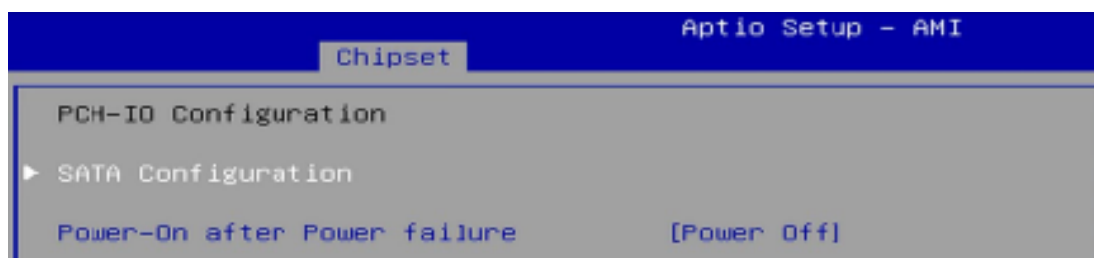

4.5.2.1 SATA Configuration:



BIOS Setting	Description
SATA and RST Configuration	SATA device options and settings
SATA Controller(s)	Enables / Disables the Serial ATA.
SATA Mode Selection	Selects IDE or AHCI Mode.
Serial ATA Port 0~2	Enables / Disables Serial Port 0 ~ 2.
SATA Ports Hot Plug	Enables / Disables SATA Ports HotPlug.
Power-On After Power failure	Specify what state to go to when power is re-applied after a power failure (G3 state)

4.6 Security Settings

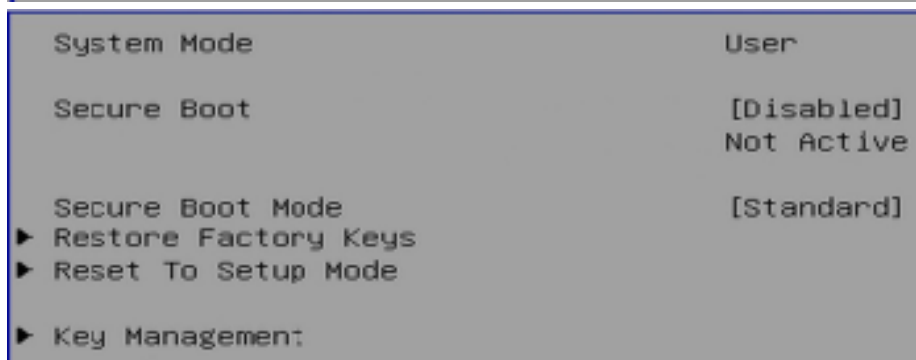
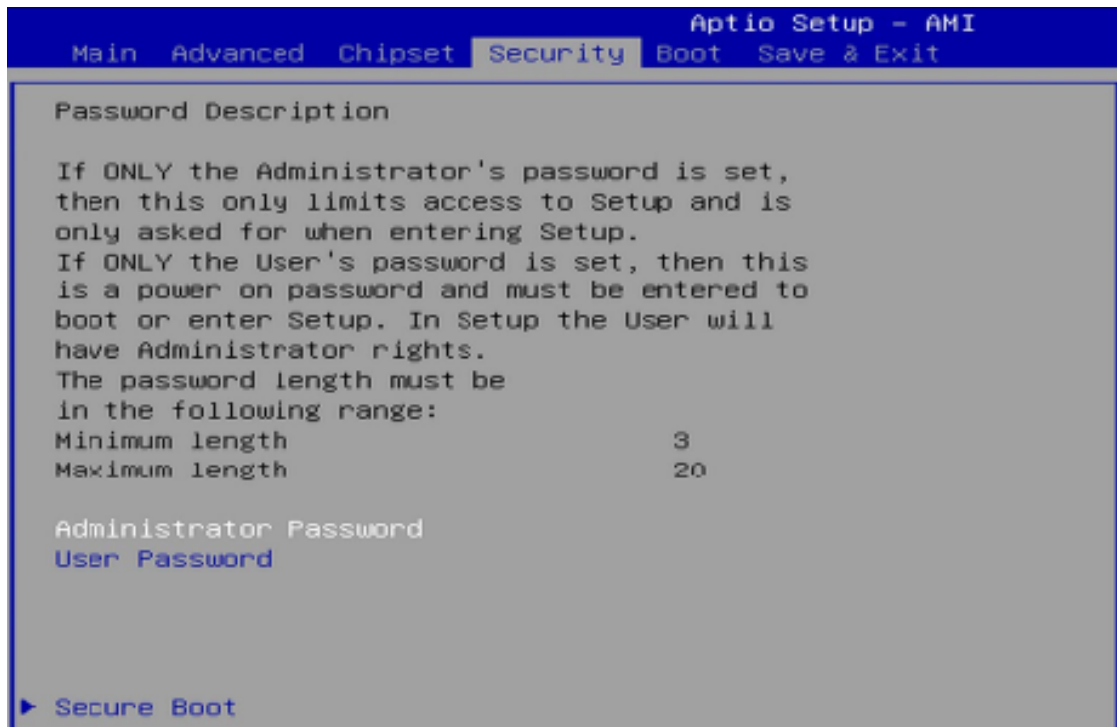

BIOS Setting	Description
Setup Administrator Password	Sets an administrator password for the setup utility.
User Password	Sets a user password.
Secure Boot	Secure Boot feature is Active if Secure Boot is enabled. Platform Key(PK) is enrolled and the system is in user mode. The mode change requires platform reset.
Secure Boot Mode	Secure Boot mode options: Standard or Custom. In Custom mode, Secure Boot Policy variables can be configured by a physically present user without full authentication

4.7 Boot Settings

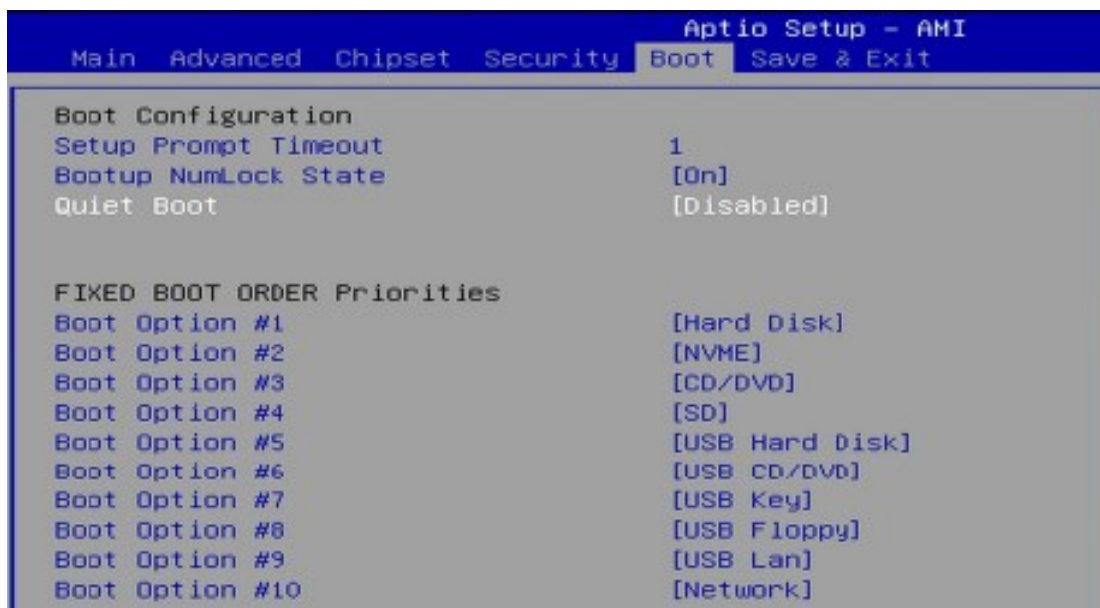

BIOS Setting	Description
Setup Prompt Timeout	Number of seconds to wait for setup activation key. 65535 (0xFFFF) means indefinite waiting.
Bootup NumLock State	Selects the keyboard NumLock state.
Quiet Boot	Enables / Disables Quiet Boot option.
FIXED BOOT ORDER Priorities	Sets the system boot order.

4.8 Save & Exit Settings



BIOS Setting	Description
Save Changes and Exit	Exits system setup after saving the changes.
Discard Changes and Exit	Exits system setup without saving any changes.
Save Changes and Reset	Resets the system after saving the changes.
Discard Changes and Reset	Resets system setup without saving any changes.
Save Changes	Saves changes done so far to any of the setup options.
Discard Changes	Discards changes done so far to any of the setup options.
Restore Defaults	Restores / Loads defaults values for all the setup options.
Save as User Defaults	Saves the changes done so far as User Defaults.
Restore User Defaults	Restores the user defaults to all the setup options.
Launch EFI Shell from filesystem device	Attempts to launch EFI shell application (Shell.efi) from one of the available filesystem devices.

This page is intentionally left blank.

Appendix

This section provides the mapping addresses of peripheral devices and the sample code of watchdog timer configuration.

- I/O Port Address Map
- Interrupt Request Lines (IRQ)
- Digital I/O Sample Code
- Watchdog Timer Configuration

A. I/O Port Address Map

Each peripheral device in the system is assigned a set of I/O port addresses which also becomes the identity of the device. The following table lists the I/O port addresses used.

Address	Device Description
0x00000A00-0x00000A0F	Motherboard resources
0x00000A10-0x00000A1F	Motherboard resources
0x00000A10-0x00000A1F	Motherboard resources
0x0000002E-0x0000002F	Motherboard resources
0x0000004E-0x0000004F	Motherboard resources
0x00000061-0x00000061	Motherboard resources
0x00000063-0x00000063	Motherboard resources
0x00000065-0x00000065	Motherboard resources
0x00000067-0x00000067	Motherboard resources
0x00000070-0x00000070	Motherboard resources
0x00000080-0x00000080	Motherboard resources
0x00000092-0x00000092	Motherboard resources
0x000000B2-0x000000B3	Motherboard resources
0x00000680-0x0000069F	Motherboard resources
0x0000164E-0x0000164F	Motherboard resources
0x00001854-0x00001857	Motherboard resources
0x000003F8-0x000003FF	Communications Port (COM1)
0x000002F8-0x000002FF	Communications Port (COM2)
0x000003E8-0x000003EF	Communications Port (COM3)
0x000002E8-0x000002EF	Communications Port (COM4)
0x0000EFA0-0x0000EFBF	SMBus - 54A3
0x00000020-0x00000021	Programmable interrupt controller
0x00000024-0x00000025	Programmable interrupt controller
0x00000028-0x00000029	Programmable interrupt controller
0x0000002C-0x0000002D	Programmable interrupt controller
0x00000030-0x00000031	Programmable interrupt controller
0x00000034-0x00000035	Programmable interrupt controller
0x00000038-0x00000039	Programmable interrupt controller
0x0000003C-0x0000003D	Programmable interrupt controller
0x000000A0-0x000000A1	Programmable interrupt controller
0x000000A4-0x000000A5	Programmable interrupt controller
0x000000A8-0x000000A9	Programmable interrupt controller
0x000000AC-0x000000AD	Programmable interrupt controller
0x000000B0-0x000000B1	Programmable interrupt controller

Address	Device Description
0x000000B4-0x000000B5	Programmable interrupt controller
0x000000B8-0x000000B9	Programmable interrupt controller
0x000000BC-0x000000BD	Programmable interrupt controller
0x000004D0-0x000004D1	Programmable interrupt controller
0x00003000-0x0000303F	Intel(R) UHD Graphics
0x00000000-0x00000CF7	PCI Express Root Complex
0x00000D00-0x0000FFFF	PCI Express Root Complex
0x00003090-0x00003097	Standard SATA AHCI Controller
0x00003080-0x00003083	Standard SATA AHCI Controller
0x00003060-0x0000307F	Standard SATA AHCI Controller
0x00000040-0x00000043	System timer
0x00000050-0x00000053	System timer
0x00002000-0x000020FE	Motherboard resources
0x00000060-0x00000060	Standard PS/2 Keyboard
0x00000064-0x00000064	Standard PS/2 Keyboard

B. Interrupt Request Lines (IRQ)

Peripheral devices use interrupt request lines to notify CPU for the service required. The following table shows the IRQ used by the devices on board.

Level	Function
IRQ 4294967291	Intel(R) USB 3.20 eXtensible Host Controller - 1.20 (Microsoft)
IRQ 4294967294	PCI Express Root Port #7 - 54BE
IRQ 4294967278	Intel(R) Management Engine Interface #1
IRQ 4294967285~89	Intel(R) Ethernet Controller I226-V #6
IRQ 4294967280~84	Intel(R) Ethernet Controller I226-V #7
IRQ 4	Communications Port (COM1)
IRQ 3	Communications Port (COM2)
IRQ 5	Communications Port (COM3)
IRQ 6	Communications Port (COM4)
IRQ 19	High Definition Audio Controller
IRQ 4294967279	Intel(R) UHD Graphics
IRQ 16	Intel(R) Serial IO UART Host Controller - 54A8
IRQ 55~204	Microsoft ACPI-Compliant System
IRQ 256~511	Microsoft ACPI-Compliant System
IRQ 4294967292	Standard SATA AHCI Controller
IRQ 4294967290	Intel(R) USB 3.10 eXtensible Host Controller - 1.20 (Microsoft)
IRQ 0	System timer
IRQ 14	Intel(R) Serial IO GPIO Host Controller - INTC1057
IRQ 1	Standard PS/2 Keyboard
IRQ 12	Microsoft PS/2 Mouse
IRQ 4294967293	PCI Express Root Port #9 - 54B0
IRQ 4294967291	Intel(R) USB 3.20 eXtensible Host Controller - 1.20 (Microsoft)
IRQ 4294967294	PCI Express Root Port #7 - 54BE
IRQ 4294967278	Intel(R) Management Engine Interface #1

C. Watchdog Timer Configuration

The Watchdog Timer (WDT) is used to generate a variety of output signals after a user programmable count. The WDT is suitable for use in the prevention of system lock-up, such as when software becomes trapped in a deadlock. Under these sorts of circumstances, the timer will count to zero and the selected outputs will be driven.

Under normal circumstance, you will need to restart the WDT at regular intervals before the timer counts to zero.

Sample Code:

```
//-----
//
// THIS CODE AND INFORMATION IS PROVIDED "AS IS" WITHOUT WARRANTY OF ANY
// KIND, EITHER EXPRESSED OR IMPLIED, INCLUDING BUT NOT LIMITED TO THE
// IMPLIED WARRANTIES OF MERCHANTABILITY AND/OR FITNESS FOR A PARTICULAR
// PURPOSE.
//
//-----
#include <dos.h>
#include <conio.h>
#include <stdio.h>
#include <stdlib.h>
#include "F81964.H"
//-----
int main (int argc, char *argv[]);
void EnableWDT(int);
void DisableWDT(void);
//-----
int main (int argc, char *argv[])
{
    unsigned char bBuf;
    unsigned char bTime;
    char **endptr;

    char SIO;

    printf("Fintek 81964 watch dog program\n");
    SIO = Init_F81964();
    if (SIO == 0)
    {
        printf("Can not detect Fintek 81964, program abort.\n");
        return(1);
    }
    //if (SIO == 0)

    if (argc != 2)
    {
        printf(" Parameter incorrect!!\n");
        return (1);
    }

    bTime = strtol (argv[1], endptr, 10);
    printf("System will reset after %d seconds\n", bTime);

    if (bTime)
```

```

    { EnableWDT(bTime); }
    else
    { DisableWDT(); }
    return 0;
}
//-----
void EnableWDT(int interval)
{
    unsigned char bBuf;

    bBuf = Get_F81964_Reg(0x2B);
    bBuf &= (~0x20);
    Set_F81964_Reg(0x2B, bBuf); //Enable WDTO

    Set_F81964_LD(0x07); //switch to logic device 7
    Set_F81964_Reg(0x30, 0x01); //enable timer

    bBuf = Get_F81964_Reg(0xF5);
    bBuf &= (~0x0F);
    bBuf |= 0x52;
    Set_F81964_Reg(0xF5, bBuf); //count mode is second

    Set_F81964_Reg(0xF6, interval); //set timer

    bBuf = Get_F81964_Reg(0xFA);
    bBuf |= 0x01;
    Set_F81964_Reg(0xFA, bBuf); //enable WDTO output

    bBuf = Get_F81964_Reg(0xF5);
    bBuf |= 0x20;
    Set_F81964_Reg(0xF5, bBuf); //start counting
}
//-----
void DisableWDT(void)
{
    unsigned char bBuf;

    Set_F81964_LD(0x07); //switch to logic device 7

    bBuf = Get_F81964_Reg(0xFA);
    bBuf &= ~0x01;
    Set_F81964_Reg(0xFA, bBuf); //disable WDTO output

    bBuf = Get_F81964_Reg(0xF5);
    bBuf &= ~0x20;
    bBuf |= 0x40;
    Set_F81964_Reg(0xF5, bBuf); //disable WDT
}
//-----

//-----
//
// THIS CODE AND INFORMATION IS PROVIDED "AS IS" WITHOUT WARRANTY OF ANY
// KIND, EITHER EXPRESSED OR IMPLIED, INCLUDING BUT NOT LIMITED TO THE
// IMPLIED WARRANTIES OF MERCHANTABILITY AND/OR FITNESS FOR A PARTICULAR
// PURPOSE.

```

```
//
//-----
#include "F81964.H"
#include <dos.h>
//-----
unsigned int F81964_BASE;
void Unlock_F81964 (void);
void Lock_F81964 (void);
//-----
unsigned int Init_F81964(void)
{
    unsigned int result;
    unsigned char ucDid;

    F81964_BASE = 0x4E;
    result = F81964_BASE;

    ucDid = Get_F81964_Reg(0x20);
    if (ucDid == 0x07) //Fintek 81964
    { goto Init_Finish; }

    F81964_BASE = 0x2E;
    result = F81964_BASE;

    ucDid = Get_F81964_Reg(0x20);
    if (ucDid == 0x07) //Fintek 81964
    { goto Init_Finish; }

    F81964_BASE = 0x00;
    result = F81964_BASE;

Init_Finish:
    return (result);
}
//-----
void Unlock_F81964 (void)
{
    outportb(F81964_INDEX_PORT, F81964_UNLOCK);
    outportb(F81964_INDEX_PORT, F81964_UNLOCK);
}
//-----
void Lock_F81964 (void)
{
    outportb(F81964_INDEX_PORT, F81964_LOCK);
}
//-----
void Set_F81964_LD( unsigned char LD)
{
    Unlock_F81964();
    outportb(F81964_INDEX_PORT, F81964_REG_LD);
    outportb(F81964_DATA_PORT, LD);
    Lock_F81964();
}
//-----
void Set_F81964_Reg( unsigned char REG, unsigned char DATA)
{
    Unlock_F81964();
```



```

        outportb(F81964_INDEX_PORT, REG);
        outportb(F81964_DATA_PORT, DATA);
        Lock_F81964();
    }
//-----
unsigned char Get_F81964_Reg(unsigned char REG)
{
    unsigned char Result;
    Unlock_F81964();
    outportb(F81964_INDEX_PORT, REG);
    Result = inportb(F81964_DATA_PORT);
    Lock_F81964();
    return Result;
}
//-----

//-----
//
// THIS CODE AND INFORMATION IS PROVIDED "AS IS" WITHOUT WARRANTY OF ANY
// KIND, EITHER EXPRESSED OR IMPLIED, INCLUDING BUT NOT LIMITED TO THE
// IMPLIED WARRANTIES OF MERCHANTABILITY AND/OR FITNESS FOR A PARTICULAR
// PURPOSE.
//
//-----
#ifndef F81964_H
#define F81964_H    1
//-----
#define F81964_INDEX_PORT    (F81964_BASE)
#define F81964_DATA_PORT (F81964_BASE+1)
//-----
#define F81964_REG_LD    0x07
//-----
#define F81964_UNLOCK    0x87
#define F81964_LOCK    0xAA
//-----
unsigned int Init_F81964(void);
void Set_F81964_LD( unsigned char);
void Set_F81964_Reg( unsigned char,
unsigned char); unsigned char
Get_F81964_Reg( unsigned char);
//-----
#endif // F81964_H

```

D. Onboard Connector Reference Types

Function	Connector	Onboard Type	Compatible Mating Type
Audio	J7	Hao Guo Xing Ye DF11-12S-PA66H	Hirose DF11-12DS-2C
SATA HDD Power	J8	E-CALL 0110-071-040	JST XHP-4
Front Panel Setting	J24	E-CALL 2.0 mm-pitch pin header (Female)	Dupont 2.0 mm-pitch (Female)
USB 2.0	J5	Hao Guo Xing Ye DF11-8S-PA66H	Hirose DF11-8DS-2C
COM2 Serial Port	J19	Hao Guo Xing Ye DF11-10S-PA66H	Hirose DF11-10DS-2C
DC Power Input	J4	Hao Guo Xing Ye WAFER396-2S-WV	JST VHR-2N
Digital I/O	J23	Dupont 2.00 mm-pitch pin header (Male)	Dupont 2.00 mm-pitch (Female)
LCD Backlight	J21	E-CALL 0110-161-040	JST PHR-4
LVDS	J10, J15	Hirose DF20G-20DP-1V	Hirose DF20A-20DS-1C
eDP	CN2	KEL SSL00-40S	KEL SSL20-40S